

**NATIONAL INSTRUMENT 43-101 TECHNICAL REPORT  
ON THE DIMBI AND ETOILE PROJECTS IN CENTRAL AFRICAL REPUBLIC (CAR),  
TSHIKAPA RIVER AND LONGATSHIMO RIVER PROJECTS  
IN DEMOCRATIC REPUBLIC OF CONGO (DRC),  
CASSANGUIDI PROJECT IN ANGOLA,  
AND  
BAKERVILLE, HARTS RIVER AND BLOEMHOF PROJECTS IN SOUTH AFRICA  
OF PANGEA DIAMONDFIELDS PLC**

**PREPARED FOR  
PANGEA DIAMONDFIELDS PLC  
BY  
VENMYN RAND (PTY) LTD**

**COMPILED BY:-**

**C.A. TELFER**

B.Sc. Hons (Geol.), (DMS) Dip Bus Man  
Pr. Sci. Nat., MGSSA, MAusIMM  
**DIRECTOR**

**S. MILLWARD**

B.Sc. Hons (Geol.)  
Cand. Sci. Nat., MGSSA, ASAIMM  
**MINERAL PROJECT ANALYST**

**A.G.BLOOMER**

B.Sc. Hons (Geol.)  
Pr. Sci. Nat., MGSSA, MSAGA, MSEG  
**ASSOCIATE**

**QUALIFIED PERSONS:-**

**C.A. TELFER**

B.Sc. Hons (Geol.), (DMS) Dip Bus Man  
Pr. Sci. Nat., MGSSA, MAusIMM  
**DIRECTOR**

**A.G.BLOOMER**

B.Sc. Hons (Geol.)  
Pr. Sci. Nat., MGSSA, MSAGA, MSEG  
**ASSOCIATE**

**Effective Date : 30<sup>th</sup> April 2008**

**NATIONAL INSTRUMENT 43-101 TECHNICAL REPORT  
ON THE DIMBI AND ETOILE PROJECTS IN CENTRAL AFRICAL REPUBLIC (CAR),  
TSHIKAPA RIVER AND LONGATSHIMO RIVER PROJECTS  
IN DEMOCRATIC REPUBLIC OF CONGO (DRC),  
CASSANGUIDI PROJECT IN ANGOLA,  
AND  
BAKERVILLE, HARTS RIVER AND BLOEMHOF PROJECTS IN SOUTH AFRICA  
OF PANGEA DIAMONDFIELDS PLC**

**TABLE OF CONTENTS**

1	SUMMARY .....	1
1.1	Dimbi Project .....	7
1.2	Etoile Project .....	8
1.3	Longatshimo River Project .....	8
1.4	Tshikapa River Project .....	9
1.5	Cassanguidi Project.....	10
1.6	Bakerville Project.....	11
1.7	Harts River Project .....	11
1.8	Bloemhof Project .....	12
2	INTRODUCTION.....	13
2.1	Terms of Reference and Nature of Transaction .....	13
2.2	Qualified Persons Declaration .....	13
2.3	Sources of Information .....	13
2.4	Site Visit and Field Involvement .....	13
3	RELIANCE ON OTHER EXPERTS .....	14
4	CENTRAL AFRICAN REPUBLIC PROJECTS .....	15
5	DIMBI PROJECT .....	15
5.1	Property Description and Location .....	15
5.1.1	Legal Aspects and Tenure .....	15
5.1.2	Royalties, Fees and Taxes .....	19
5.1.3	Impact of the Project on the Environment .....	20
5.2	Accessibility, Climate, Local Resources, Infrastructure and Physiography .....	20
5.2.1	Locality, Population and Access .....	20
5.2.2	Infrastructure and Local Resources.....	20
5.2.3	Climate and Vegetation .....	21
5.2.4	Physiography .....	21
5.3	History .....	23
5.3.1	Historical Exploration, Sampling and Production Records .....	23
5.3.2	Historical Diamond Resources .....	25
5.4	Geological Setting .....	25
5.4.1	Regional Geological Setting .....	25
5.4.2	Local and Property Geology .....	27
5.5	Deposit Type .....	27
5.6	Mineralization .....	29
5.7	Exploration.....	29
5.8	Phase I – River System Prospecting Pitting.....	30
5.8.1	Sampling Method and Approach .....	30
5.8.2	Sample Preparation, Analyses and Security .....	30
5.8.3	Data Verification.....	32
5.8.4	Results.....	32
5.9	Phase I – River System Mega Pitting.....	33
5.9.1	Sampling Method and Approach .....	33
5.9.2	Sample Preparation, Analyses and Security .....	33
5.9.3	Data Verification.....	34
5.9.4	Results.....	34
5.10	Phase I – Dimbi Formation Prospecting Pitting.....	34
5.10.1	Sampling Method and Approach .....	34
5.10.2	Sample Preparation, Analyses and Security .....	34
5.10.3	Data Verification.....	36

5.10.4	Results .....	36
5.11	Phase I – Dimbi Formation Mega Pitting .....	37
5.11.1	Sampling Method and Approach .....	37
5.11.2	Sample Preparation, Analyses and Security .....	37
5.11.3	Data Verification.....	37
5.11.4	Results.....	37
5.12	Phase I – River System Drilling.....	37
5.12.1	Sampling Method and Approach .....	37
5.12.2	Sample Preparation, Analyses and Security .....	38
5.12.3	Data Verification.....	38
5.12.4	Results.....	38
5.13	Phase II – River System Drilling.....	40
5.13.1	Sampling Method and Approach .....	40
5.13.2	Sample Preparation, Analyses and Security .....	43
5.13.3	Data Verification.....	43
5.13.4	Results.....	43
5.14	Phase II – Bulk Sampling .....	43
5.14.1	Sampling Method and Approach .....	43
5.14.2	Sample Preparation, Analyses and Security .....	44
5.14.3	Data Verification.....	44
5.14.4	Results.....	44
5.15	Adjacent Properties .....	46
5.16	Mineral Processing and Metallurgical Testing.....	47
5.16.1	Pan Plant .....	47
5.16.2	Final Recovery Plant.....	47
5.16.3	Security .....	50
5.17	Diamond Resource and Diamond Reserve Estimates.....	50
5.17.1	Previous Resource Statements .....	50
5.17.2	Volume.....	50
5.17.3	Density.....	51
5.17.4	Grade.....	51
5.17.5	Diamond Value .....	51
5.17.6	Current Resource Statement.....	51
5.18	Other Relevant Data and Information.....	52
5.19	Interpretation and Conclusions.....	53
5.20	Recommendations.....	55
6	ETOILE PROJECT .....	57
6.1	Property Description and Location .....	57
6.1.1	Legal Aspects and Tenure.....	57
6.1.2	Royalties, Fees and Taxes .....	58
6.1.3	Impact of the Project on the Environment .....	58
6.2	Accessibility, Climate, Local Resources, Infrastructure and Physiography .....	58
6.2.1	Locality, Population and Access.....	58
6.2.2	Infrastructure and Local Resources.....	58
6.2.3	Climate and Vegetation .....	59
6.2.4	Physiography .....	59
6.3	History .....	59
6.3.1	Historical Exploration, Sampling and Production Records.....	59
6.3.2	Historical Diamond Resources .....	61
6.4	Geological Setting .....	61
6.4.1	Regional Geological Setting .....	61
6.4.2	Local and Property Geology .....	61
6.5	Deposit Type .....	62
6.6	Mineralization .....	62
7	ETOILE PROJECT – NZAKO PROJECT AREA .....	62
7.1	Exploration.....	62
7.2	Reconnaissance Exercise .....	62
7.3	Pitting.....	62
7.4	Auger Drilling.....	62
7.5	Bulk Sampling.....	62
7.6	Adjacent Properties .....	64
7.7	Mineral Processing and Metallurgical Testing.....	64

7.8	Diamond Resource and Diamond Reserve Estimates .....	64
7.9	Other Relevant Data and Information .....	64
7.10	Interpretation and Conclusions .....	64
7.11	Recommendations .....	64
8	ETOILE PROJECT – KOTTO-BANGANA PROJECT AREA .....	64
8.1	Exploration .....	64
8.2	Reconnaissance Exercise .....	64
8.3	Pitting .....	66
8.4	Auger Drilling .....	66
8.5	Bulk Sampling .....	66
8.6	Adjacent Properties .....	66
8.7	Mineral Processing and Metallurgical Testing .....	66
8.8	Diamond Resource and Diamond Reserve Estimates .....	66
8.9	Other Relevant Data and Information .....	66
8.10	Interpretation and Conclusions .....	66
8.11	Recommendations .....	66
9	DEMOCRATIC REPUBLIC OF CONGO PROJECTS .....	67
10	LONGATSHIMO RIVER PROJECT .....	67
10.1	Property Description and Location .....	67
10.1.1	Legal Aspects and Tenure .....	70
10.1.2	Royalties, Fees and Taxes .....	72
10.1.3	Impact of the Project on the Environment .....	72
10.2	Accessibility, Climate, Local Resources, Infrastructure and Physiography .....	72
10.2.1	Locality, Population and Access .....	72
10.2.2	Infrastructure and Local Resources .....	74
10.2.3	Climate and Vegetation .....	74
10.2.4	Physiography .....	74
10.3	History .....	74
10.3.1	Historical Exploration, Sampling and Production Records .....	76
10.3.2	Historical Diamond Resources .....	76
10.4	Geological Setting .....	77
10.4.1	Regional Geological Setting .....	77
10.4.2	Local and Property Geology .....	77
10.5	Deposit Type .....	77
10.6	Mineralization .....	77
11	LONGATSHIMO RIVER PROJECT – KAPOPO PROJECT AREA .....	79
11.1	Exploration .....	79
11.2	Reconnaissance Mapping .....	79
11.3	Prospecting Pitting .....	81
11.3.1	Sampling Method and Approach .....	81
11.3.2	Sample Preparation, Analyses and Security .....	81
11.3.3	Data Verification .....	81
11.3.4	Results .....	81
11.4	Jimbo Pitting .....	84
11.4.1	Sampling Method and Approach .....	84
11.4.2	Sample Preparation, Analyses and Security .....	84
11.4.3	Data Verification .....	84
11.4.4	Results .....	84
11.5	Mega Pitting .....	84
11.5.1	Sampling Method and Approach .....	84
11.5.2	Sample Preparation, Analyses and Security .....	86
11.5.3	Data Verification .....	86
11.5.4	Results .....	86
11.6	Auger Drilling .....	87
11.6.1	Sampling Method and Approach .....	87
11.6.2	Sample Preparation, Analyses and Security .....	88
11.6.3	Data Verification .....	88
11.6.4	Results .....	88
11.7	Bulk Sampling .....	88
11.8	Adjacent Properties .....	88
11.9	Mineral Processing and Metallurgical Testing .....	88

11.10	Diamond Resource and Diamond Reserve Estimates	88
11.10.1	Previous Resource Statements	88
11.10.2	Volume	90
11.10.3	Density	90
11.10.4	Grade	90
11.10.5	Diamond Value	90
11.10.6	Current Resource Statement	91
11.11	Other Relevant Data and Information	91
11.12	Interpretation and Conclusions	92
11.13	Recommendations	94
12	LONGATSHIMO RIVER PROJECT – KAMONIA PROJECT AREA	94
12.1	Exploration	94
12.2	Reconnaissance Mapping	94
12.3	Prospecting Pitting	94
12.3.1	Sampling Method and Approach	94
12.3.2	Sample Preparation, Analyses and Security	94
12.3.3	Data Verification	94
12.3.4	Results	94
12.4	Jimbo Pitting	98
12.4.1	Sampling Method and Approach	98
12.4.2	Sample Preparation, Analyses and Security	98
12.4.3	Data Verification	98
12.4.4	Results	98
12.5	Mega Pitting	98
12.5.1	Sampling Method and Approach	98
12.5.2	Sample Preparation, Analyses and Security	98
12.5.3	Data Verification	98
12.5.4	Results	98
12.6	Auger Drilling	100
12.6.1	Sampling Method and Approach	100
12.6.2	Sample Preparation, Analyses and Security	100
12.6.3	Data Verification	100
12.6.4	Results	100
12.7	Bulk Sampling	101
12.8	Adjacent Properties	101
12.9	Mineral Processing and Metallurgical Testing	101
12.10	Diamond Resource and Diamond Reserve Estimates	101
12.10.1	Previous Resource Statements	101
12.10.2	Volume	101
12.10.3	Density	101
12.10.4	Grade	101
12.10.5	Diamond Value	101
12.10.6	Current Resource Statement	102
12.11	Other Relevant Data and Information	102
12.12	Interpretation and Conclusions	104
12.13	Recommendations	104
13	LONGATSHIMO RIVER PROJECT – KAJAMA PROJECT AREA	104
13.1	Exploration	104
13.2	Reconnaissance Mapping	104
13.3	Prospecting Pitting	104
13.4	Jimbo Pitting	104
13.4.1	Sampling Method and Approach	106
13.4.2	Sample Preparation, Analyses and Security	106
13.4.3	Data Verification	106
13.4.4	Results	106
13.5	Mega Pitting	106
13.6	Auger Drilling	106
13.7	Bulk Sampling	106
13.8	Adjacent Properties	106
13.9	Mineral Processing and Metallurgical Testing	106
13.10	Diamond Resource and Diamond Reserve Estimates	106
13.11	Other Relevant Data and Information	107

13.12	Interpretation and Conclusions.....	107
13.13	Recommendations.....	107
14	LONGATSHIMO RIVER PROJECT – SOMILO PROJECT AREA.....	107
14.1	Exploration.....	107
14.2	Reconnaissance Mapping.....	107
14.3	Prospecting Pitting.....	107
14.4	Jimbo Pitting.....	107
14.5	Mega Pitting.....	107
14.6	Auger Drilling.....	107
14.7	Bulk Sampling.....	107
14.8	Adjacent Properties.....	107
14.9	Mineral Processing and Metallurgical Testing.....	107
14.10	Diamond Resource and Diamond Reserve Estimates.....	107
14.11	Other Relevant Data and Information.....	108
14.12	Interpretation and Conclusions.....	108
14.13	Recommendations.....	108
15	LONGATSHIMO RIVER PROJECT – BASHALA PROJECT AREA.....	108
15.1	Exploration.....	108
15.2	Reconnaissance Mapping.....	108
15.3	Prospecting Pitting.....	108
15.4	Jimbo Pitting.....	108
15.5	Mega Pitting.....	108
15.6	Auger Drilling.....	108
15.7	Bulk Sampling.....	108
15.8	Adjacent Properties.....	108
15.9	Mineral Processing and Metallurgical Testing.....	108
15.10	Diamond Resource and Diamond Reserve Estimates.....	108
15.11	Other Relevant Data and Information.....	108
15.12	Interpretation and Conclusions.....	109
15.13	Recommendations.....	109
16	TSHIKAPA RIVER PROJECT.....	110
16.1	Property Description and Location.....	110
16.1.1	Legal Aspects and Tenure.....	111
16.1.2	Royalties, Fees and Taxes.....	111
16.1.3	Impact of the Project on the Environment.....	111
16.2	Accessibility, Climate, Local Resources, Infrastructure and Physiography.....	113
16.2.1	Locality, Population and Access.....	113
16.2.2	Infrastructure and Local Resources.....	113
16.2.3	Climate and Vegetation.....	113
16.2.4	Physiography.....	113
16.3	History.....	113
16.3.1	Historical Exploration, Sampling and Production Records.....	114
16.3.2	Historical Diamond Resources.....	114
16.4	Geological Setting.....	114
16.4.1	Regional Geological Setting.....	114
16.4.2	Local and Property Geology.....	114
16.5	Deposit Type.....	114
16.6	Mineralization.....	114
17	TSHIKAPA RIVER PROJECT – MVULA MILENGE PROJECT AREA.....	115
17.1	Exploration.....	115
17.2	Reconnaissance Mapping.....	115
17.3	Prospecting Pitting.....	115
17.3.1	Sampling Method and Approach.....	115
17.3.2	Sample Preparation, Analyses and Security.....	115
17.3.3	Data Verification.....	117
17.3.4	Results.....	117
17.4	Mega Pitting.....	117
17.4.1	Sampling Method and Approach.....	119
17.4.2	Sample Preparation, Analyses and Security.....	119
17.4.3	Data Verification.....	119
17.4.4	Results.....	119

17.5	Auger Drilling.....	120
17.5.1	Sampling Method and Approach .....	120
17.5.2	Sample Preparation, Analyses and Security .....	120
17.5.3	Data Verification.....	120
17.5.4	Results.....	120
17.6	Bulk Sampling.....	120
17.7	Adjacent Properties .....	120
17.8	Mineral Processing and Metallurgical Testing.....	120
17.9	Diamond Resource and Diamond Reserve Estimates.....	121
17.9.1	Previous Resource Statements .....	121
17.9.2	Volume.....	121
17.9.3	Density .....	121
17.9.4	Grade.....	121
17.9.5	Diamond Value .....	121
17.9.6	Current Resource Statement.....	122
17.10	Other Relevant Data and Information.....	122
17.11	Interpretation and Conclusions.....	122
17.12	Recommendations.....	122
18	TSHIKAPA RIVER PROJECT – NANZAMBI PROJECT AREA.....	124
18.1	Exploration.....	124
18.2	Reconnaissance Mapping .....	124
18.3	Prospecting Pitting.....	124
18.3.1	Sampling Method and Approach .....	124
18.3.2	Sample Preparation, Analyses and Security .....	124
18.3.3	Data Verification.....	124
18.3.4	Results.....	124
18.4	Jimbo Pitting .....	126
18.5	Mega Pitting.....	126
18.5.1	Sampling Method and Approach .....	126
18.5.2	Sample Preparation, Analyses and Security .....	126
18.5.3	Data Verification.....	126
18.5.4	Results.....	126
18.6	Auger Drilling.....	126
18.7	Bulk Sampling.....	126
18.8	Adjacent Properties .....	126
18.9	Mineral Processing and Metallurgical Testing.....	126
18.10	Diamond Resource and Diamond Reserve Estimates.....	127
18.10.1	Previous Resource Statements .....	127
18.10.2	Volume.....	127
18.10.3	Density .....	127
18.10.4	Grade.....	127
18.10.5	Diamond Value .....	127
18.10.6	Current Resource Statement.....	127
18.11	Other Relevant Data and Information.....	128
18.12	Interpretation and Conclusions.....	128
18.13	Recommendations.....	128
19	TSHIKAPA RIVER PROJECT – TUMINES PROJECT AREA .....	128
19.1	Exploration.....	128
19.2	Reconnaissance Mapping .....	128
19.3	Prospecting Pitting.....	128
19.4	Jimbo Pitting .....	128
19.5	Mega Pitting.....	128
19.6	Auger Drilling.....	128
19.7	Bulk Sampling.....	128
19.8	Adjacent Properties .....	130
19.9	Mineral Processing and Metallurgical Testing.....	130
19.10	Diamond Resource and Diamond Reserve Estimates.....	130
19.11	Other Relevant Data and Information.....	130
19.12	Interpretation and Conclusions.....	130
19.13	Recommendations.....	130
20	TSHIKAPA RIVER PROJECT – KABULA PROJECT AREA .....	130

20.1	Exploration.....	130
20.2	Reconnaissance Mapping.....	130
20.3	Prospecting Pitting.....	130
	20.3.1 Sampling Method and Approach .....	130
	20.3.2 Sample Preparation, Analyses and Security .....	130
	20.3.3 Data Verification.....	130
	20.3.4 Results.....	132
20.4	Jimbo Pitting .....	132
20.5	Mega Pitting.....	132
20.6	Auger Drilling.....	132
20.7	Bulk Sampling.....	132
20.8	Adjacent Properties .....	132
20.9	Mineral Processing and Metallurgical Testing.....	132
20.10	Diamond Resource and Diamond Reserve Estimates.....	132
20.11	Other Relevant Data and Information.....	132
20.12	Interpretation and Conclusions.....	132
20.13	Recommendations.....	132
21	ANGOLAN PROJECT.....	133
22	CASSANGUIDI PROJECT .....	133
	22.1 Property Description and Location .....	133
	22.1.1 Legal Aspects and Tenure.....	133
	22.1.2 Royalties, Fees and Taxes .....	137
	22.1.3 Impact of the Project on the Environment .....	139
	22.2 Accessibility, Climate, Local Resources, Infrastructure and Physiography .....	139
	22.2.1 Locality, Population and Access.....	139
	22.2.2 Infrastructure and Local Resources.....	139
	22.2.3 Climate and Vegetation .....	141
	22.2.4 Physiography .....	141
	22.3 History .....	141
	22.3.1 Historical Exploration, Sampling and Production Records .....	141
	22.3.2 Historical Diamond Resources .....	142
	22.4 Geological Setting .....	148
	22.4.1 Regional Geological Setting .....	148
	22.4.2 Local and Property Geology .....	151
	22.5 Deposit Type .....	151
	22.6 Mineralization .....	151
	22.6.1 Colinas.....	151
	22.6.2 Terraces.....	151
	22.6.3 Lezirias.....	151
	22.6.4 Present River Bed.....	151
23	CASSANGUIDI PROJECT – CASSANGUIDI SOUTH PROJECT AREA.....	153
	23.1 Exploration.....	153
	23.2 Pitting.....	153
	23.2.1 Sampling Method and Approach .....	153
	23.2.2 Sample Preparation, Analyses and Security .....	153
	23.2.3 Data Verification.....	153
	23.2.4 Results.....	153
	23.3 Bulk Sampling.....	154
	23.3.1 Sampling Method and Approach .....	154
	23.3.2 Sample Preparation, Analyses and Security .....	159
	23.3.3 Data Verification.....	159
	23.3.4 Results.....	159
	23.4 Pilot Mining .....	159
	23.4.1 Sampling Method and Approach .....	159
	23.4.2 Sample Preparation, Analyses and Security .....	160
	23.4.3 Data Verification.....	160
	23.4.4 Results.....	160
	23.5 Adjacent Properties .....	162
	23.6 Mineral Processing and Metallurgical Testing.....	163
	23.6.1 Main Pan Plant.....	163
	23.6.2 Auxiliary Pan Plant.....	165



	23.6.3	Final Recovery Plant.....	165
	23.6.4	Security .....	168
23.7		Diamond Resource and Diamond Reserve Estimates.....	168
	23.7.1	Previous Resource Statements .....	168
	23.7.2	Volume.....	168
	23.7.3	Density .....	169
	23.7.4	Grade.....	169
	23.7.5	Diamond Value .....	169
	23.7.6	Current Resource Statement .....	171
23.8		Other Relevant Data and Information.....	172
23.9		Interpretation and Conclusions.....	172
23.10		Recommendations.....	173
24		CASSANGUIDI PROJECT – CABUAQUECE PROJECT AREA .....	173
	24.1	Exploration.....	173
	24.2	Data Modelling.....	175
	24.2.1	Method and Approach .....	175
	24.2.2	Data Verification.....	175
	24.2.3	Results .....	175
	24.3	Adjacent Properties .....	175
	24.4	Mineral Processing and Metallurgical Testing.....	175
	24.5	Diamond Resource and Diamond Reserves Estimate.....	178
	24.5.1	Previous Resource Statements .....	178
	24.5.2	Volume.....	178
	24.5.3	Density .....	178
	24.5.4	Grade.....	178
	24.5.5	Diamond Value .....	178
	24.5.6	Current Resource Statement .....	178
	24.6	Other Relevant Data and Information.....	180
	24.7	Interpretation and Conclusions.....	180
	24.8	Recommendations.....	180
25		CASSANGUIDI PROJECT – CATCHOQUE PROJECT AREA .....	180
	25.1	Exploration.....	180
	25.2	Data Modelling.....	180
	25.2.1	Method and Approach .....	180
	25.2.2	Data Verification.....	181
	25.2.3	Results .....	181
	25.3	Auger Drilling.....	181
	25.3.1	Sampling Method and Approach .....	181
	25.3.2	Sample Preparation, Analyses and Security .....	181
	25.3.3	Data Verification.....	182
	25.3.4	Results .....	182
	25.4	Adjacent Properties .....	182
	25.5	Mineral Processing and Metallurgical Testing.....	182
	25.6	Diamond Resource and Diamond Reserves Estimate.....	182
	25.6.1	Previous Resource Statements .....	182
	25.6.2	Volume.....	182
	25.6.3	Density .....	182
	25.6.4	Grade.....	182
	25.6.5	Diamond Value .....	185
	25.6.6	Current Resource Statement .....	185
	25.7	Other Relevant Data and Information.....	185
	25.8	Interpretation and Conclusions.....	185
	25.9	Recommendations.....	187
26		CASSANGUIDI PROJECT – CALE PROJECT AREA .....	187
	26.1	Exploration.....	187
	26.2	Data Modelling.....	187
	26.2.1	Method and Approach .....	187
	26.2.2	Data Verification.....	188
	26.2.3	Results .....	188
	26.3	Adjacent Properties .....	188
	26.4	Mineral Processing and Metallurgical Testing.....	188

26.5	Diamond Resource and Diamond Reserves Estimate .....	188
26.5.1	Previous Resource Statements .....	188
26.5.2	Volume .....	188
26.5.3	Density .....	191
26.5.4	Grade .....	191
26.5.5	Diamond Value .....	191
26.5.6	Current Resource Statement .....	191
26.6	Other Relevant Data and Information .....	191
26.7	Interpretation and Conclusions .....	191
26.8	Recommendations .....	193
27	SOUTH AFRICAN PROJECTS .....	194
28	BAKERVILLE PROJECT .....	194
28.1	Property Description and Location .....	194
28.1.1	Legal Aspects and Tenure .....	198
28.1.2	Royalties, Fees and Taxes .....	200
28.1.3	Impact of the Project on the Environment .....	200
28.2	Accessibility, Climate, Local Resources, Infrastructure and Physiography .....	200
28.2.1	Locality, Population and Access .....	200
28.2.2	Infrastructure and Local Resources .....	200
28.2.3	Climate and Vegetation .....	200
28.2.4	Physiography .....	201
28.3	History .....	201
28.3.1	Historical Exploration, Sampling and Production Records .....	201
28.3.2	Historical Diamond Resources .....	203
28.4	Geological Setting .....	203
28.4.1	Regional Geological Setting .....	203
28.4.2	Local and Property Geology .....	203
28.5	Deposit Type .....	205
28.6	Mineralization .....	205
29	BAKERVILLE PROJECT – PATSEMA PROJECT AREA .....	208
29.1	Exploration .....	208
29.2	Reconnaissance Exploration .....	208
29.3	RC Drilling .....	208
29.3.1	Sampling Method and Approach .....	208
29.3.2	Sample Preparation, Analyses and Security .....	210
29.3.3	Data Verification .....	210
29.3.4	Results .....	210
29.4	LDD Holes .....	211
29.4.1	Sampling Method and Approach .....	211
29.4.2	Sample Preparation, Analyses and Security .....	211
29.4.3	Data Verification .....	214
29.4.4	Results .....	214
29.5	Surface Samples .....	214
29.5.1	Sampling Method and Approach .....	214
29.5.2	Sample Preparation, Analyses and Security .....	214
29.5.3	Data Verification .....	215
29.5.4	Results .....	215
29.6	Adjacent Properties .....	215
29.7	Mineral Processing and Metallurgical Testing .....	215
29.7.1	Processing Plant .....	215
29.7.2	Final Recovery .....	215
29.7.3	Security .....	218
29.8	Diamond Resource and Diamond Reserves Estimate .....	218
29.8.1	Previous Resource Statements .....	218
29.8.2	Volume .....	218
29.8.3	Density .....	218
29.8.4	Grade .....	218
29.8.5	Diamond Value .....	218
29.8.6	Current Resource Statement .....	219
29.9	Other Relevant Data and Information .....	219
29.10	Interpretation and Conclusions .....	219

29.11	Recommendations.....	221
30	BAKERVILLE PROJECT – GELUKSDAL PROJECT AREA.....	221
30.1	Exploration.....	221
30.2	Reconnaissance.....	221
30.3	RC Drilling.....	221
30.3.1	Sampling Method and Approach.....	221
30.3.2	Sample Preparation, Analyses and Security.....	221
30.3.3	Data Verification.....	221
30.3.4	Results.....	225
30.4	LDD Holes.....	225
30.4.1	Sampling Method and Approach.....	225
30.4.2	Sample Preparation, Analyses and Security.....	225
30.4.3	Data Verification.....	225
30.4.4	Results.....	227
30.5	Adjacent Properties.....	227
30.6	Mineral Processing and Metallurgical Testing.....	227
30.7	Diamond Resource and Diamond Reserves Estimate.....	227
30.8	Other Relevant Data and Information.....	227
30.9	Interpretation and Conclusions.....	227
30.10	Recommendations.....	227
31	HARTS RIVER PROJECT.....	228
31.1	Property Description and Location.....	228
31.1.1	Legal Aspects and Tenure.....	231
31.1.2	Royalties, Fees and Taxes.....	233
31.1.3	Impact of the Project on the Environment.....	233
31.2	Accessibility, Climate, Local Resources, Infrastructure and Physiography.....	233
31.2.1	Locality, Population and Access.....	233
31.2.2	Infrastructure and Local Resources.....	233
31.2.3	Climate and Vegetation.....	234
31.2.4	Physiography.....	234
31.3	History.....	234
31.3.1	Historical Exploration, Sampling and Production Records.....	234
31.3.2	Historical Diamond Resource Estimate.....	234
31.4	Geological Setting.....	234
31.4.1	Regional Geological Setting.....	234
31.4.2	Local and Property Geology.....	234
31.5	Deposit Type.....	236
31.6	Mineralization.....	236
32	HARTS RIVER PROJECT – BRUSSELS PROJECT AREA.....	236
32.1	Exploration.....	236
32.2	Percussion Drilling.....	236
32.2.1	Sampling Method and Approach.....	236
32.2.2	Sample Preparation, Analyses and Security.....	239
32.2.3	Data Verification.....	239
32.2.4	Results.....	239
32.3	Viska Bulk Sampling.....	243
32.3.1	Sampling Method and Approach.....	243
32.3.2	Sample Preparation, Analyses and Security.....	243
32.3.3	Data Verification.....	243
32.3.4	Results.....	243
32.4	PDF Bulk Sampling.....	247
32.4.1	Sampling Method and Approach.....	247
32.4.2	Sample Preparation, Analyses and Security.....	248
32.4.3	Data Verification.....	248
32.4.4	Results.....	248
32.5	Badenhorst Bulk Sampling.....	249
32.5.1	Sampling Method and Approach.....	249
32.5.2	Sample Preparation, Analyses and Security.....	249
32.5.3	Data Verification.....	249
32.5.4	Results.....	249
32.6	Adjacent Properties.....	249

32.7	Mineral Processing and Metallurgical Testing.....	249
32.7.1	Viska Processing Plant.....	250
32.7.2	Badenhorst Processing Plant.....	250
32.8	Diamond Resource and Diamond Reserves Estimate.....	254
32.8.1	Previous Mineral Resource Statement.....	254
32.8.2	Volume.....	254
32.8.3	Density.....	254
32.8.4	Grade.....	254
32.8.5	Diamond Value.....	255
32.8.6	Current Resource Statement.....	255
32.9	Other Relevant Data and Information.....	257
32.10	Interpretation and Conclusions.....	257
32.11	Recommendations.....	257
33	HARTS RIVER PROJECT – PAMPIERSTAD PROJECT AREA.....	257
33.1	Exploration.....	257
33.2	Percussion Drilling.....	257
33.2.1	Sampling Method and Approach.....	257
33.2.2	Sample Preparation, Analyses and Security.....	258
33.2.3	Data Verification.....	258
33.2.4	Results.....	258
33.3	Exploration Pitting.....	258
33.4	Bulk Sampling.....	258
33.5	Adjacent Properties.....	258
33.6	Mineral Processing and Metallurgical Testing.....	261
33.7	Diamond Resource and Diamond Reserves Estimate.....	261
33.8	Other Relevant Data and Information.....	261
33.9	Interpretation and Conclusions.....	261
33.10	Recommendations.....	261
34	BLOEMHOF PROJECT.....	263
34.1	Property Description and Location.....	263
34.1.1	Legal Aspects and Tenure.....	263
34.1.2	Royalties, Fees and Taxes.....	271
34.1.3	Impact of the Project on the Environment.....	271
34.2	Accessibility, Climate, Local Resources, Infrastructure and Physiography.....	271
34.2.1	Locality, Population and Access.....	271
34.2.2	Infrastructure and Local Resources.....	271
34.2.3	Climate and Vegetation.....	271
34.2.4	Physiography.....	271
34.3	History.....	271
34.3.1	Historical Exploration, Sampling and Production Records.....	271
34.3.2	Historical Diamond Resources.....	272
34.4	Geological Setting.....	272
34.4.1	Regional Geological Setting.....	272
34.4.2	Local and Property Geology.....	272
34.5	Deposit Type.....	272
34.6	Mineralization.....	272
35	BLOEMHOF PROJECT – ZOUTPAN PROJECT AREA.....	274
35.1	Exploration.....	274
35.2	Percussion Drilling.....	274
35.2.1	Sampling Method and Approach.....	274
35.2.2	Sample Preparation, Analyses and Security.....	274
35.2.3	Data Verification.....	274
35.2.4	Results.....	274
35.3	Adjacent Properties.....	275
35.4	Mineral Processing and Metallurgical Testing.....	275
35.5	Diamond Resource and Diamond Reserves Estimate.....	275
35.6	Other Relevant Data and Information.....	275
35.7	Interpretation and Conclusions.....	275
35.8	Recommendations.....	275
36	BLOEMHOF – PALMIETFONTEIN PROJECT AREA.....	275
36.1	Exploration.....	275

36.2	Adjacent Properties .....	275
36.3	Mineral Processing and Metallurgical Testing.....	275
36.4	Diamond Resource and Diamond Reserves Estimate.....	275
36.5	Other Relevant Data and Information.....	275
36.6	Interpretation and Conclusions.....	275
36.7	Recommendations.....	275
37	BLOEMHOF PROJECT – BERGSPRUIT PROJECT AREA.....	277
37.1	Exploration.....	277
37.2	Adjacent Properties .....	277
37.3	Mineral Processing and Metallurgical Testing.....	277
37.4	Diamond Resource and Diamond Reserves Estimate.....	277
37.5	Other Relevant Data and Information.....	277
37.6	Interpretation and Conclusions.....	277
37.7	Recommendations.....	277
38	BLOEMHOF PROJECT – WOLMARANSSTAD PROJECT AREA.....	277
38.1	Exploration.....	277
38.2	Adjacent Properties .....	277
38.3	Mineral Processing and Metallurgical Testing.....	277
38.4	Diamond Resource and Diamond Reserves Estimate.....	277
38.5	Other Relevant Data and Information.....	277
38.6	Interpretation and Conclusions.....	277
38.7	Recommendations.....	277
39	REFERENCES.....	278
40	DATE AND SIGNATURE PAGE.....	279
41	CERTIFICATES OF QUALIFIED PERSONS .....	280

### LIST OF FIGURES

Figure 1	: Location of PDF's Diamond Assets.....	2
Figure 2	: Corporate Structure of PDF.....	3
Figure 3	: Locality Plan of CAR Projects .....	16
Figure 4	: Infrastructure Plan for the CAR Projects .....	17
Figure 5	: Ownership of the Dimbi and Etoile Projects.....	18
Figure 6	: Infrastructure and Equipment at Dimbi Project Camp.....	22
Figure 7	: Local Geology and Historical Pitting Sites within the Dimbi Project.....	24
Figure 8	: Regional Geology of the South Central CAR.....	26
Figure 9	: Schematic Cross Section of the Diamondiferous Deposits in the Dimbi Project.....	28
Figure 10	: Location of River System and Bulk Sampling Pits for Dimbi Project .....	31
Figure 11	: Location of Dimbi Formation Pits for the Dimbi Project .....	35
Figure 12	: Location of Auger Drilling for Dimbi Project .....	39
Figure 13	: Contour Plan of River System Gravel and Overburden Thicknesses for the Mbia River .....	41
Figure 14	: Contour Plan of River System Gravel and Overburden Thicknesses for the Ngouboro & Akongo Rivers.....	42
Figure 15	: Dimbi Project Number of Carats by Sieve Size.....	46
Figure 16	: Dimbi Project Cumulative Size Frequency Distribution.....	46
Figure 17	: Schematic Flowsheet for Dimbi Project Pan Plant.....	48
Figure 18	: Schematic Flowsheet for Dimbi Project Final Recovery Plant.....	49
Figure 19	: Location of Diamond Resources for the Dimbi Project .....	54
Figure 20	: Historical Statistics on Percentage of Gem Diamonds for Nzako Project Area.....	60
Figure 21	: Historical Statistics on Diamond Size for Nzako Project Area .....	61

Figure 22 : Extent of Workings and Historical Information for Nzako Project Area.....	63
Figure 23 : Location of Rivers and Historical Workings in the Kotto-Bangana Project Area.....	65
Figure 24 : Infrastructure and Locality Plan of DRC Projects.....	68
Figure 25 : License Boundaries in Relation to Local Infrastructure and Drainage.....	69
Figure 26 : Ownership of the Longatshimo River Project.....	71
Figure 27 : Infrastructure and Equipment at Longatshimo River Project Camp and Surrounds.....	73
Figure 28 : Geology and Historical Production of the Tshikapa Diamondfield.....	75
Figure 29 : Schematic Cross Section of the Diamondiferous Deposits in the Tshikapa Diamondfield.....	78
Figure 30 : Extent of Gravels and Sample Positions for the Kapopo Project Area.....	80
Figure 31 : Contour Plot of Gravel and Overburden Thicknesses for the Kapopo Project Area.....	83
Figure 32 : Photographs of Exploration and Sampling Techniques.....	85
Figure 33 : Schematic Flowsheet for Longatshimo River Project Plant.....	89
Figure 34 : Location of Diamond Resources for the Kapopo Project Area.....	93
Figure 35 : Extent of Gravels and Sample Positions for the Kamonia Project Area.....	97
Figure 36 : Contour Plot of Gravel and Overburden Thicknesses for the Kamonia Project Area.....	99
Figure 37 : Location of Diamond Resources for the Kamonia Project Area.....	103
Figure 38 : Extent of Gravels and Sample Positions for the Kajama Project Area.....	105
Figure 39 : Ownership of the Tshikapa River Project.....	112
Figure 40 : Extent of Gravels and Sample Position for the Mvula Milenge Project Area.....	116
Figure 41 : Contour Plot of Gravel and Overburden Thicknesses for the Mvula Milenge Project Area.....	118
Figure 42 : Location of Diamond Resources for the Mvula Milenge Project Area.....	123
Figure 43 : Extent of Gravels and Sample Position for the Nanzambi Project Area.....	125
Figure 44 : Location of Diamond Resources for the Nanzambi Project Area.....	129
Figure 45 : Location of Pits on the Kabula Project Area.....	131
Figure 46 : Infrastructure and Locality Plan of PDF's Angola Project.....	134
Figure 47 : Infrastructure of Northeastern Angola.....	135
Figure 48 : Cassanguidi Project Infrastructure and Satellite Image.....	136
Figure 49 : Ownership of the Cassanguidi Project.....	138
Figure 50 : Cassanguidi Project Infrastructure and Equipment.....	140
Figure 51 : Location of Historical Exploration and Mining for the Cabuaquece Project Area.....	143
Figure 52 : Location of Historical Exploration and Mining for the Catchoque Project Area.....	144
Figure 53 : Location of Historical Exploration, Historical Mining and Recent Exploration for the Cale Project Area.....	145
Figure 54 : Location of Historical Mining, Recent Exploration and Recent Mining for the Cassanguidi South Project Area.....	146
Figure 55 : Geology of Lunda Norte Province.....	149
Figure 56 : Cassanguidi Project Schematic Cross Section of Local Geology.....	152
Figure 57 : Contour Plot of Gravel and Overburden Thicknesses for the CA02 Block, Cassanguidi South Project Area.....	155
Figure 58 : Contour Plot of Gravel and Overburden Thicknesses for the CA08 Block, Cassanguidi South Project Area.....	156
Figure 59 : Contour Plot of Gravel and Overburden Thicknesses for the CA09 Block, Cassanguidi South Project Area.....	157

Figure 60 : Contour Plot of Gravel and Overburden Thicknesses for the CA10 Block, Cassanguidi South Project Area .....	158
Figure 61 : Pilot Mining Production Results .....	160
Figure 62 : Average Stone Sizes for the Pilot Mining Operation.....	161
Figure 63 : Cumulative SFD for Cassanguidi Project.....	162
Figure 64 : Schematic Flowsheet for Cassanguidi South Project Area Main Pan Plant.....	164
Figure 65 : Processing Results for the Pilot Mining Operation.....	165
Figure 66 : Schematic Flowsheet for the Cassanguidi South Project Area Auxilliary Pan Plant.....	166
Figure 67 : Schematic Flowsheet for Cassanguidi South Project Area Final Recovery Plant .....	167
Figure 68 : Location of Cassanguidi South Project Area Diamond Resources Blocks .....	170
Figure 69 : Diamond Sales Results for the Cassanguidi Project .....	171
Figure 70 : Contour Plot of Gravel and Overburden Thickness for the Cabuaquece Project Area.....	176
Figure 71 : Contour Plot of Grade Variations for the Cabuaquece Project Area.....	177
Figure 72 : Location of Diamond Resources for the Cabuaquece Project Area .....	179
Figure 73 : Contour Plot of Gravel and Overburden Thicknesses for the Catchoque Project Area.....	183
Figure 74 : Contour Plot of Grade Variations for the Catchoque Project Area.....	184
Figure 75 : Location of Diamond Resources for the Cachoque Project Area .....	186
Figure 76 : Contour Plot of Gravel and Overburden Thicknesses for the Cale Project Area.....	189
Figure 77 : Contour Plot of Grade Variations for the Cale Project Area.....	190
Figure 78 : Location of Diamond Resources for the Cale Project Area .....	192
Figure 79 : Location of South African Projects in Relation to Local Diamond Deposits.....	195
Figure 80 : Infrastructure and Locality Plan of South African Projects.....	196
Figure 81 : Locality Plan for Bakerville Project.....	197
Figure 82 : Ownership of Bakerville Project .....	199
Figure 83 : The Patsema Prospect in relation to Alluvial Diamond Diggings .....	202
Figure 84 : The Development of a Pothole.....	204
Figure 85 : Patsema Gravel Runs and Potholes .....	206
Figure 86 : Stratigraphic Column and Location of Exploration within the Patsema Project Area .....	207
Figure 87 : Patsema Prospect Gravity Survey 2005 .....	209
Figure 88 : Contour Plots of the Gravel Thickness for Run 1 and Associated Potholes.....	212
Figure 89 : Contour Plots of Gravel Thickness for Run 2 and Associated Potholes.....	213
Figure 90 : Schematic Flowsheet for the Bakerville Project Plant.....	216
Figure 91 : Schematic Flowsheet for the Bakerville Final Recovery .....	217
Figure 92 : Location of Diamond Resources for the Patsema Project Area.....	220
Figure 93 : Stratigraphic Column and Location of Exploration on the Geluksdal Project Area.....	224
Figure 94 : Contour Plot of Gravel Thickness Modelling for Geluksdal Project Area.....	226
Figure 95 : Locality Plan for Harts River Project .....	229
Figure 96 : Ownership of Harts River Project.....	232
Figure 97 : Geology of the Brussels Area .....	235
Figure 98 : Geological Model for the Harts River Project.....	237
Figure 99 : Deep Channel Gravels and Shallow Calcrete Gravels of the Brussels Project Area .....	238
Figure 100 : Location of Percussion Drilling on Zamenkomst 819, Brussels Project Area .....	240

Figure 101 : Location of Percussion Drilling on Gamabot 733 and Uitenhage 826, Brussels Project Area .	241
Figure 102 : Contour Plots of Gravel and Overburden Thicknesses for the Shallow Calcrete Gravels on Zamenkomst 819, Gamabot 733 and Uitenhage 826.....	242
Figure 103 : Contour Plots of Gravel and Overburden Thicknesses for the Deep Channel Gravels on Zamenkomst 819 .....	244
Figure 104 : Location of Bulk Sample on the Brussels Project Area.....	245
Figure 105 : Brussels Project Area Size Distribution Chart.....	247
Figure 106 : Brussels Project Area Cumulative SFD .....	247
Figure 107 : Schematic Flowsheet for the Viska Pan Plant at the Brussels Project Area .....	251
Figure 108 : Schematic Flowsheet for the Badenhorst Pan Plant at the Brussels Project Area.....	252
Figure 109 : Valuation of Parcels .....	255
Figure 110 : Location of Diamond Resources for the Brussels Project Area.....	256
Figure 111 : Location of Exploration at the Pampierstad Project Area indicating the Deep Channel Gravels .....	259
Figure 112 : Location Exploration at the Pampierstad Project Area indicating the Rooikoppie Gravels .....	260
Figure 113 : Contour Plots of Gravel and Overburden Thicknesses for the Pampierstad Project Area .....	262
Figure 114 : Locality Plan for Bergspruit and Wolmaransstad Project Areas .....	264
Figure 115 : Locality Plan for Zoutpan and Palmietfontein Project Areas.....	265
Figure 116 : Ownership of the Bloemhof Project.....	266
Figure 117 : Location of Exploration and Stratigraphic Column for Zoutpan Project Area .....	273
Figure 118 : Contour Plots of Gravel and Overburden Thicknesses for the Zoutpan Project Area .....	276

### LIST OF TABLES

Table 1 : Summary of PDF's Projects .....	4
Table 2 : PDF's Inferred Diamond Resources.....	5
Table 3 : PDF's Indicated Diamond Resources.....	5
Table 4 : PDF's Recommended Exploration Work Programme and Costing for all Projects.....	6
Table 5 : Summary of Site Visits .....	13
Table 6 : List of Other Experts.....	14
Table 7 : Dimbi Project Area and Boundary Coordinates.....	15
Table 8 : Dimbi Project Legal Tenure.....	19
Table 9 : History of Diamond Discoveries in the CAR and the Dimbi Project .....	23
Table 10 : BRGM Exploration Results.....	23
Table 11 : Historical Diamond Prices .....	25
Table 12 : Summary of River System Prospecting Pitting For Dimbi Project.....	33
Table 13 : Summary of River System Mega Pitting Results for Dimbi Project.....	34
Table 14 : Summary Dimbi Formation Prospecting Pitting Results for Dimbi Project.....	36
Table 15 : Summary Dimbi Formation Mega Pitting Results for Dimbi Project.....	37
Table 16 : Summary Statistics for Modelling .....	40
Table 17 : Summary of Bulk Sampling Results for Dimbi Project .....	45
Table 18 : Technical Issues Associated with BS1 and BS2.....	45
Table 19 : Volume Estimation for Dimbi Project.....	51
Table 20 : Grade Calculation for Dimbi Project.....	51



Table 21 : Results of Diamond Sale for the Dimbi Project .....	51
Table 22 : Diamond Resource Statement for the Dimbi Project (1 <sup>st</sup> March 2008) .....	52
Table 23 : Preliminary Assessment at First Stage of Commercial Mining for Dimbi Project.....	52
Table 24 : Exploration Work Programme and Costing for all CAR Projects .....	56
Table 25 : Revenue Generation for all CAR Projects.....	56
Table 26 : Etoile Project Area and Boundary Coordinates.....	57
Table 27 : Etoile Project Legal Tenure .....	57
Table 28 : History of Diamond Discoveries in the CAR and the Etoile Project .....	59
Table 29 : Historical Production Data to 1963 for Nzako and Kotto-Bangana Project Areas .....	60
Table 30 : Longatshimo River Project Areas and Boundary Coordinates.....	67
Table 31 : Longatshimo River Project Legal Tenure .....	70
Table 32 : Historical Production within PDF's Longatshimo Project.....	76
Table 33 : Summary Prospecting Pitting Results for Kapopo Project Area .....	82
Table 34 : Summary Statistics for Kapopo Modelling.....	82
Table 35 : Summary Jimbo Pitting Results for Kapopo Project Area .....	84
Table 36 : Summary Mega Pitting Results for Kapopo Project Area .....	87
Table 37 : Summary of Auger Drilling Results for Kapopo Project Area.....	88
Table 38 : Previous Resource Statement for Longatshimo River Project (1st May 2006).....	90
Table 39 : Volume Estimation for Kapopo Project Area .....	90
Table 40 : Grade Calculation for Kapopo Project Area .....	90
Table 41 : Average Diamond Price for Tshikapa River Project.....	90
Table 42 : Diamond Resource Statement for the Longatshimo Project (1 <sup>st</sup> March 2008).....	91
Table 43 : Preliminary Assessment at First Stage of Commercial Mining for Longatshimo River Project.....	91
Table 44 : Exploration Work Programme and Costing for all the DRC Projects .....	95
Table 45 : Revenue Generation for all the DRC Projects.....	95
Table 46 : Summary Prospecting Pitting Results for Kamonia Project Area.....	96
Table 47 : Summary Statistics for Kamonia Modelling.....	96
Table 48 : Summary Jimbo Pitting Results for Kamonia Project Area .....	98
Table 49 : Summary Mega Pitting Results for Kamonia Project Area.....	100
Table 50 : Summary of Auger Drilling Results for Kamonia Project Area .....	100
Table 51 : Volume Estimation for Kamonia Project Area .....	101
Table 52 : Grade Calculation for Kamonia Project Area .....	101
Table 53 : Indicative Diamond Valuations for Kamonia.....	102
Table 54 : Sales Records from Artisanal Miners .....	102
Table 55 : Summary Jimbo Pitting Results for Kajama Project Area .....	106
Table 56 : Initial Gravel Volume Calculations for the Kajama Project Area .....	106
Table 57 : Tshikapa River Project Areas and Boundary Coordinates.....	110
Table 58 : Tshikapa River Project Legal Tenure .....	111
Table 59 : Historical Production from the Tshikapa River Project.....	114
Table 60 : Summary Prospecting Pitting Results for Mvula Milenge Project Area .....	117
Table 61 : Summary Statistics from Mvula Milenge Modelling.....	117
Table 62 : Summary Mega Pitting Results for Mvula Milenge Project Area.....	119

Table 63 : Summary of Auger Drilling Results for Mvula Milenge Project Area .....	120
Table 64 : Previous Resource Statement for Tshikapa River Project (1st May 2006) .....	121
Table 65 : Volume Estimation for Mvula Milenge Project Area .....	121
Table 66 : Grade Calculation for Mvula Milenge Project Area .....	121
Table 67 : Diamond Resource Statement for the Tshikapa River Project (1 <sup>st</sup> March 2008) .....	122
Table 68 : Summary Prospecting Pitting Results for Nanzambi Project Area.....	124
Table 69 : Summary Mega Pitting Results for Nanzambi Project Area.....	126
Table 70 : Volume Estimation for Nanzambi Project Area .....	127
Table 71 : Grade Calculation for Nanzambi Project Area .....	127
Table 72 : Prospecting Pit Results for Kabula Project Area .....	132
Table 73 : Cassanguidi Project Area and Boundary Coordinates.....	133
Table 74 : Cassanguidi Project Legal Tenure .....	137
Table 75 : History of Cassanguidi Project .....	141
Table 76 : Historical Sampling Programme Parameters .....	142
Table 77 : M.A.T.S. Global Resources of the Angolan Diamond Fields (1975).....	142
Table 78 : Endiama Resources for Cabuaquece Mining Area (1991).....	147
Table 79 : Endiama Resources for Catchoque Mining Area (1991).....	147
Table 80 : Endiama Resources for Cale Project Area (1991) .....	147
Table 81 : Summary Statistics for Cassanguidi South Project Area .....	154
Table 82 : Bulk Sampling Results for Cassanguidi South Project Area .....	159
Table 83 : Summary of Pilot Mining Results on a Block by Block Basis .....	161
Table 84 : Fucauma Mine Diamond Resources (SAMREC, 2007) .....	163
Table 85 : Cassanguidi Project Resource Statement (2006) .....	168
Table 86 : Volume Estimation for Cassanguidi South Project Area .....	169
Table 87 : Grade Calculation for Cassanguidi South Project Area .....	169
Table 88 : Average Diamond Values Used for Cassanguidi Project.....	171
Table 89 : Inferred Diamond Resource Statement for the Cassanguidi Project (31 <sup>st</sup> December 2007) .....	171
Table 90 : Indicated Diamond Resource Statement for the Cassanguidi Project (31 <sup>st</sup> December 2007) .....	171
Table 91 : Preliminary Assessment at First Stage of Commercial Mining for Cassanguidi Project.....	172
Table 92 : Exploration Work Programme and Costing for Angolan Project .....	174
Table 93 : Revenue Generation for Angolan Project.....	174
Table 94 : Descriptive Statistics for the Cabuaquece Project Area.....	175
Table 95 : Volume Estimation for Cabuaquece Project Area .....	178
Table 96 : Grade Calculation for Cabuaquece Project Area .....	178
Table 97 : Descriptive Statistics for the Catchoque Project Area.....	181
Table 98 : Volume Estimation for Catchoque Project Area .....	182
Table 99 : Grade Calculation for Catchoque Project Area .....	185
Table 100 : Descriptive Statistics for the Cale Project Area.....	188
Table 101 : Volume Estimation for Cale Project Area .....	191
Table 102 : Grade Calculation for Cale Project Area .....	191
Table 103 : Bakerville Project Areas and Boundary Coordinates .....	194
Table 104 : Surface Rights Owners for the Bakerville Project .....	198

Table 105 : Legal Rights Pertaining to the Bakerville Project .....	198
Table 106 : Recorded Historical Production from the Lichtenburg Area (1926-1989) .....	201
Table 107 : Typical Gravel Layers of the Diamond Runs .....	205
Table 108 : Comparison between Geluksdal and Zamenkomst Gravels .....	208
Table 109 : Summary Statistics for Patsema Modelling .....	210
Table 110 : Summary of LDD Holes Results for the Patsema Project Area .....	214
Table 111 : Volume Estimation for Bakerville Project .....	218
Table 112 : Grade Results for the Bakerville Project .....	218
Table 113 : Independent Valuation on the Bakerville Project Diamonds .....	219
Table 114 : Diamond Resource Statement for the Bakerville Project (1 <sup>st</sup> March 2008).....	219
Table 115 : Exploration Work Programme and Costing for all the South African Projects .....	222
Table 116 : Revenue Generation for all the South African Projects.....	223
Table 117 : Summary Statistics for Geluksdal Modelling .....	225
Table 118 : Harts River Project Areas and Boundary Coordinates .....	228
Table 119 : Surface Rights Owners for the Harts River Project.....	230
Table 120 : Legal Rights Pertaining to the Harts River Project.....	231
Table 121 : Summary Statistics for the Brussels Modelling .....	239
Table 122 : Viska Bulk Sampling Results for the Brussels Project Area.....	246
Table 123 : PDF Bulk Sampling Results for the Brussels Project Area .....	248
Table 124 : Badenhorst Gamabot 733 Bulk Sampling Results for the Brussels Project Area .....	249
Table 125 : Harts River Diamond Resource Statement (2006).....	254
Table 126 : Volume Estimation for Hart River Project.....	254
Table 127 : Grade Results for the Harts River Project.....	254
Table 128 : Average Diamond Values Used for Harts River Project.....	255
Table 129 : Resource Statement for the Harts River Project – 1 <sup>st</sup> March 2008 .....	255
Table 130 : Summary Statistics for the Pampierstad Project Area .....	258
Table 131 : Bloemhof Project Areas and Boundary Coordinates.....	267
Table 132 : Surface Rights Owners for the Bloemhof Project.....	268
Table 133 : Legal Rights Pertaining to the Bloemhof Project.....	270
Table 134 : Historical Alluvial Diamond Production for the Bloemhof Project.....	272
Table 135 : Summary Statistics for the Zoutpan Project Area Modelling.....	274

#### LIST OF APPENDICES

Appendix 1 : Compararive Diamond Size Classification Schemes .....	284
Appendix 2 : Resource Classification Logic for Dimbi Project.....	285
Appendix 3 : Resource Classification Logic for Longatshimo River Project.....	286
Appendix 4 : Resource Classification Logic for Tshikapa River Project.....	287
Appendix 5 : Resource Classification Logic for Cassanguidi Project.....	288
Appendix 6 : Resource Classification Logic for the South African Project .....	289
Appendix 7 : Glossary of Terms and Abbreviations .....	290
Appendix 8 : Classification of Secondary Diamond Deposits.....	293

## 1 SUMMARY

PDF is an emerging mid-tier diamond producer and exploration company with a current portfolio of eight diamond projects located in four African countries, namely the CAR, DRC, Angola and South Africa (Figure 1). These projects are subdivided into a total of 24 project areas, each of which are addressed in this technical report.

PDF's diamond assets are at various stages of exploration development ranging from early exploration through bulk sampling to a project at pilot mining stage. A summary table of all the projects, along with PDF's effective shareholding, is highlighted in Table 1. The projects are ordered according to their country location in Africa, commencing in the north with the CAR. The PDF corporate structure and related shareholding in the various projects is illustrated in Figure 2.

Inferred Diamond Resources have been defined, according to the CIM Definition Standards for Diamond Resources and Diamond Reserves, for six of the eight projects. Indicated Diamond Resources have been declared for a single project. The Inferred and Indicated Diamond Resources are tabulated in Table 2 and Table 3, respectively.

PDF's projects are all located within geological environments with highly favourable diamond bearing potential. Whilst alluvial deposits constitute the primary focus of the company, a number of the target areas are also located within regions where primary kimberlites could potentially occur. This potential will be evaluated later on an opportunistic basis.

Since 2003, PDF has established a solid operational base with a total of 26 professionals stationed at project sites and in regional offices located in Bangui, Kinshasa, Johannesburg and Luanda.

The success of an exploration company is based upon a large number of early stage projects which require small initial amounts of capital for the primary assessment of their prospectivity, a decreasing number of projects in later stages of development and a few feasibility stage projects, which require larger amounts of capital, but which have a very high probability of being brought to production.

PDF has successfully implemented a phased approach to exploration, commencing with a small capital investment in the project until the initial results have shown to be positive. Thereafter, by increasing the scale of the operation and the size and number of the exploration samples or data points, more confidence is obtained in firstly, the volume, and secondly, the grade, of the deposit. All exploration is based upon the successful outcome of the prior phase. Only once the geological model and the presence of diamond mineralization has been confirmed are the operations scaled up into bulk sampling or, later, pilot mining. PDF's phased approach minimises the risks associated with diamond exploration. Should any project be deemed as having little or no potential, PDF quickly relinquishes the licence and transfers the staff and equipment onto the next project.

Africa is an excellent target for diamond exploration for a number of reasons. Firstly, Africa's geologically stable continental environment is suitable for kimberlite emplacement and an ideal environment for the extensive reworking of these primary deposits into secondary alluvial deposits. Secondly, it is an accepted fact that because of political difficulties the majority of the African countries have not been subject to extensive and modern exploration methods. Lastly, in 2006, Africa produced over 60% of the global diamonds.

The PDF portfolio of diamond projects is diverse both in location within the African continent and with respect to their stages of development. This diversity results in the spreading and therefore minimising of risk associated with one country in particular. This also ensures a steady stream of project development into successful mining operations over the short, medium and long term.

The inclusion of a pilot mine in a remote location in Africa provides confidence in the company's ability to operate successfully on this continent, as well as having the potential to provide a ready source of income to assist in funding the other developments in the near future.

In conclusion, PDF's diamond assets are technically sound and, with the planned exploration activities (as summarised in Table 4) by a highly capable management team, have a high probability of being brought to account.

**LOCATION OF PDF'S DIAMOND ASSETS**

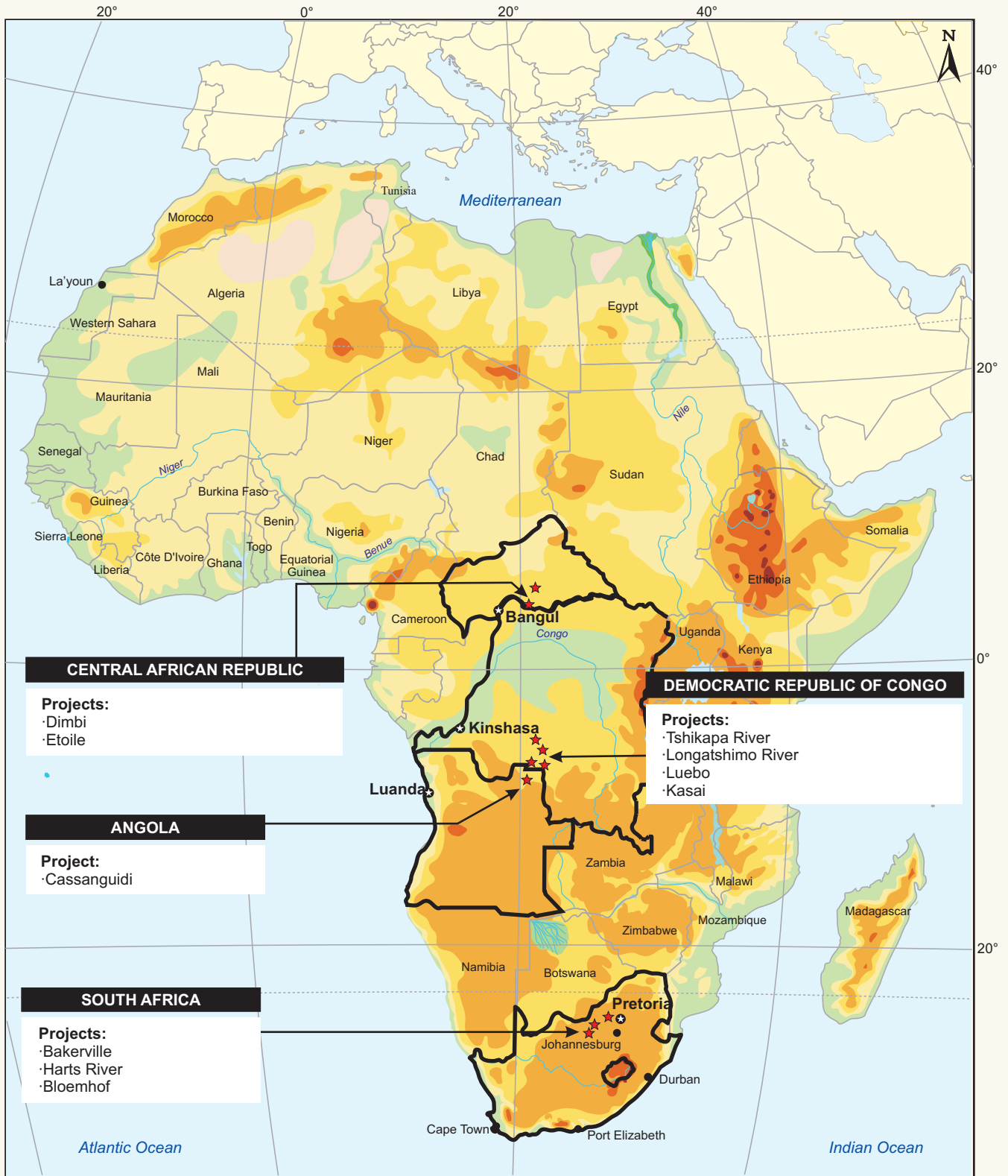

Source: 1994 MAGELLAN GeographixSM  
Santa Barbara, CA 1-800-929-4MAP

**LEGEND:**

- River
- Country Boundarie
- Ocean/Lake
- Elevation above sea level
- Project Location

This diagram and the information herein is copyrighted. It may not be reproduced or transmitted in any form or by any means without prior written permission from Venmyn Rand (Pty) Ltd. Trading as Venmyn.

**CORPORATE STRUCTURE OF PDF**

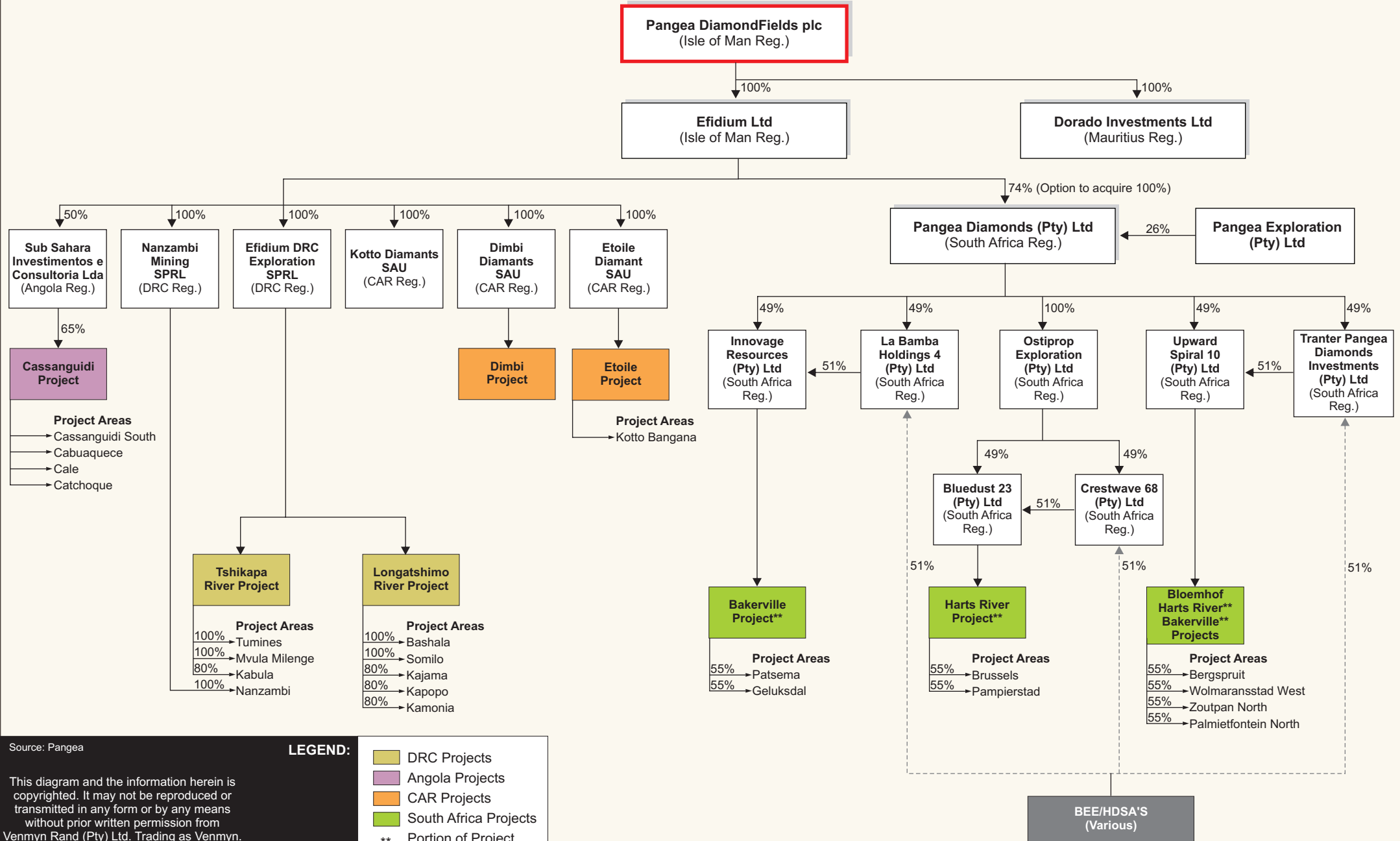

Source: Pangea

**LEGEND:**

- DRC Projects
- Angola Projects
- CAR Projects
- South Africa Projects
- \*\* Portion of Project

This diagram and the information herein is copyrighted. It may not be reproduced or transmitted in any form or by any means without prior written permission from Venmyn Rand (Pty) Ltd. Trading as Venmyn.

Table 1 : Summary of PDF's Projects

COUNTRY	PROJECT NAME	PROJECT AREA	COMPANY CURRENTLY HOLDING PDF's SHARE	PDF's EFFECTIVE INTEREST AT MAR 08	DEVELOPMENT STATUS	LICENCE AREA (km <sup>2</sup> )	LICENCE AREA (ha)	COMMENTS
CAR	Dimbi		Efidium Ltd	100%	Bulk Sampling	995.00	99,500	Drilling and bulk sampling programme underway. Pilot Mining to commence in 2008
	Etoile	Kotto-Bangana	Efidium Ltd	100%	Early Exploration	988.00	98,800	No exploration underway yet.
						962.00	96,200	No exploration underway yet.
		Nzako				922.00	92,200	Initial reconnaissance completed.
<b>TOTAL CAR</b>						<b>3,867</b>	<b>386,700</b>	
DRC	Longatshimo River	Bashala	Efidium Ltd	100%	Early Exploration	36.00	3,600	No exploration underway yet.
		Somilo		100%	Early Exploration	12.00	1,200	No exploration underway yet.
		Kajama		80%	Advanced Exploration	32.00	3,200	Pitting underway.
		Kapopo		80%	Bulk Sampling	20.00	2,000	Bulk sampling to commence. Plant commissioning near complete.
		Kamonia		80%	Bulk Sampling	36.00	3,600	Bulk sampling to commence. Plant commissioning near complete.
	Tshikapa River	Tumines	Efidium Ltd	100%	Early Exploration	12.00	1,200	No exploration underway yet.
		Nanzambi		100%	Advanced Exploration	36.00	3,600	Pitting and jigging underway.
		Mvula Milenge		100%	Advanced Exploration	35.00	3,500	Pitting, jigging and drilling underway.
		Kabula		80%	Early Exploration	9.00	900	Pitting and Mapping underway
<b>TOTAL DRC</b>						<b>228.00</b>	<b>22,800</b>	
Angola*	Cassanguidi	Cabuaquece	Efidium Ltd	33%	Advanced Exploration	112.50	11,250.00	Detailed historical sampling, no recent sampling.
		Cale			Advanced Exploration			Detailed historical sampling, no recent sampling.
		Catchoque			Advanced Exploration			Detailed historical sampling, recent drilling.
		Cassanguidi South			Pilot Mining			Annual current pilot mining production of ~80,000m <sup>3</sup> ROM from openpits. Recent drilling and pitting.
<b>TOTAL ANGOLA</b>						<b>112.50</b>	<b>11,250</b>	
South Africa	Bakerville	Patsema	Efidium Ltd	55%	Advanced Exploration	116.26	11,626	Geophysics, RC and LDD completed. Sample processing underway.
		Geluksdal		55%	Advanced Exploration	10.94	1,094	Geophysics, RC and LDD completed. Sample processing underway.
	Harts River	Brussels	Efidium Ltd	55%	Bulk Sampling	266.74	26,674	Percussion holes and initial exploration completed. Bulk sampling underway.
		Pampierstad		55%	Early Exploration	80.37	8,037	Percussion holes drilled and bulk sampling to commence in 2008.
	Bloemhof	Bergspruit	Efidium Ltd	55%	Early Exploration	90.01	9,001	No exploration underway yet.
		Wolmaransstad West		55%		112.86	11,286	No exploration underway yet.
		Zoutpan North		55%		59.46	5,946	Percussion holes have been drilled. Bulk sample to commence 2008.
		Palmietfontein North		55%		105.32	10,532	No exploration underway yet.
<b>TOTAL SOUTH AFRICA</b>						<b>841.96</b>	<b>84,196</b>	
<b>GRAND TOTAL PDF</b>						<b>5,049.46</b>	<b>504,946</b>	

\* Note that Efidium has a 50% shareholding in a company which has the right to 65% of the operating profits of the project.

Table 2 : PDF's Inferred Diamond Resources

COUNTRY	MINE / PROJECT	PROJECT AREA	RESOURCE CLASSIFICATION	GRAVEL VOLUME (m <sup>3</sup> )	RECOVERED GRADE (ct/100m <sup>3</sup> )	CARATS	DIAMOND VALUE (US\$/ct)	BOTTOM SCREEN SIZE (mm)	PDF's ATTRIBUTABLE INTEREST	PDF's ATTRIBUTABLE CARATS
CAR	Dimbi	N/A	Inferred	1,063,000	47.94	509,632	166	1.6	100%	509,632
	<b>TOTAL / AVE</b>			<b>1,063,000</b>	<b>47.94</b>	<b>509,632</b>	<b>166</b>	<b>1.6</b>		<b>509,632</b>
DRC	Longatshimo River	Kapopo	Inferred	6,253,000	28.22	1,764,671	180	1.6	80%	1,411,737
		Kamonia	Inferred	9,399,000	35.13	3,301,681	180	1.6	80%	2,641,345
	Tshikapa River	Mvula Milenge	Inferred	6,594,000	14.98	988,107	180	1.6	100%	988,107
		Nanzambi	Inferred	9,934,000	23.81	2,365,499	180	1.6	100%	2,365,499
	<b>TOTAL / AVE</b>			<b>32,180,000</b>	<b>26.17</b>	<b>8,419,958</b>	<b>180</b>	<b>1.6</b>		<b>7,406,688</b>
Angola	Cassanguidi	Cassanguidi South	Inferred	186,000	6.24	11,604	160	1.6	33%	3,771
		Cabuaquece	Inferred	2,567,000	23.62	606,366	160	1.6	33%	197,069
		Catchoque	Inferred	775,000	16.15	125,172	160	1.6	33%	40,681
		Cale	Inferred	575,000	27.57	158,523	160	1.6	33%	51,520
	<b>TOTAL / AVE</b>			<b>4,103,000</b>	<b>21.98</b>	<b>901,665</b>	<b>160</b>	<b>1.6</b>		<b>293,041</b>
South Africa	Bakerville	Patsema	Inferred	2,173,000	3.22	69,971	310	1.6	55%	38,484
	Harts River	Brussels	Inferred	22,977,000	0.55	126,374	1,050	2.0	55%	69,505
	<b>TOTAL / AVE</b>			<b>25,150,000</b>	<b>0.78</b>	<b>196,344</b>	<b>786</b>	<b>2.0</b>		<b>107,989</b>
<b>GRAND TOTAL / AVE</b>				<b>62,496,000</b>	<b>16.05</b>	<b>10,027,600</b>	<b>189</b>			<b>8,317,351</b>

Table 3 : PDF's Indicated Diamond Resources

COUNTRY	MINE / PROJECT	PROJECT AREA	RESOURCE CLASSIFICATION	GRAVEL VOLUME (m <sup>3</sup> )	RECOVERED GRADE (ct/100m <sup>3</sup> )	CARATS	DIAMOND VALUE (US\$/ct)	BOTTOM SCREEN SIZE (mm)	PDF's ATTRIBUTABLE INTEREST	PDF's ATTRIBUTABLE CARATS
CAR	Dimbi	N/A	Indicated	712,575	38.35	273,273	166	1.6	100%	273,273
Angola	Cassanguidi	Cassanguidi South	Indicated	356,394	17.73	63,206	160	1.6	33%	20,542
<b>GRAND TOTAL / AVE</b>				<b>1,068,969</b>	<b>31.48</b>	<b>336,478</b>	<b>165</b>	<b>1.6</b>		<b>293,814</b>



Table 4 : PDF's Recommended Exploration Work Programme and Costing for all Projects

COUNTRY	PROJECT	RECON* EXPLORATION		EXPLORATION		STAGE OF EXPLORATION		BULK SAMPLING		PILOT MINING		GRAND TOTAL
		COST (US\$)	COMPLETION DATE	COST (US\$)	COMPLETION DATE	ADVANCED EXPLORATION	COMPLETION DATE	COST (US\$)	COMPLETION DATE	COST (US\$)	COMPLETION DATE	
CAR	Dimbi	N/A	N/A	N/A	N/A	N/A	N/A	N/A	N/A	(3,347,000)	Q3 - 2008	(3,347,000)
	Etoile	N/A	N/A	(412,400)	Q3 - 2008	(413,700)	Q2 - 2009	(4,506,000)	Q4 - 2009	N/A	N/A	(5,332,100)
	<b>TOTAL CAR</b>	<b>0</b>		<b>(412,400)</b>		<b>(413,700)</b>		<b>(4,506,000)</b>		<b>(3,347,000)</b>		<b>(8,679,100)</b>
DRC	Longatshimo River	N/A	N/A	N/A	N/A	N/A	N/A	(2,610,800)	Q3 - 2008	(4,233,000)	Q4 - 2009	(6,843,800)
	Tshikapa River	N/A	N/A	N/A	N/A	(1,940,000)	Q1 - 2009	(6,364,000)	Q4 - 2009	N/A	N/A	(8,304,000)
	<b>TOTAL DRC</b>	<b>0</b>		<b>0</b>		<b>(1,940,000)</b>		<b>(8,974,800)</b>		<b>(4,233,000)</b>		<b>(15,147,800)</b>
Angola	Cassanguidi	N/A	N/A	N/A	N/A	N/A	N/A	N/A	N/A	(3,438,000)	Q3 - 2008	(3,438,000)
	<b>TOTAL ANGOLA</b>	<b>0</b>		<b>0</b>		<b>0</b>		<b>0</b>		<b>(3,438,000)</b>		<b>(3,438,000)</b>
South Africa	Bakerville	N/A	N/A	N/A	N/A	N/A	N/A	(2,659,000)	Q4 - 2009	N/A	N/A	(2,659,000)
	Harts River	N/A	N/A	N/A	N/A	N/A	N/A	(1,920,000)	Q4 - 2009	N/A	N/A	(1,920,000)
	Bloemhof	N/A	N/A	(70,000)	Q3 - 2008	N/A	N/A	(130,000)	Q4 - 2009	N/A	N/A	(200,000)
	<b>TOTAL SOUTH AFRICA</b>	<b>0</b>		<b>(70,000)</b>		<b>0</b>		<b>(4,709,000)</b>		<b>0</b>		<b>(4,779,000)</b>
	<b>GRAND TOTAL</b>	<b>0</b>		<b>(482,400)</b>		<b>(2,353,700)</b>		<b>(18,189,800)</b>		<b>(11,018,000)</b>		<b>(32,043,900)</b>

## Notes

\* RECON - Reconnaissance

Results of each phase determines whether a project moves into the subsequent phase or if it is terminated.

Expenditure includes capex and exploration costs.

Exploration plan as to end 2009 only.

PDF required to finance all above expenditure, even though their shareholding may be less than 100%.

Venmyn has assisted PDF in compiling the exploration programmes and budgets for each project, as summarised above.

Venmyn recommends that PDF carry out the programmes for each project, as summarised above.

Exploration and capital expenditure to be funded through capital raising and revenues from diamonds mined and sold from the project.

All operating and capital costs associated with Mining Module 1 are excluded.

## 1.1 Dimbi Project

The Dimbi Project represents an alluvial diamond asset at the bulk sampling stage of exploration. It is located in the southern CAR along the Oubangui River, which forms the border with the DRC (Figure 1). PDF currently holds 100% of the project through its subsidiary, Efidium Ltd (Efidium) (Figure 2).

The project area is underlain by mid to lower Proterozoic schists and schistose quartzites along the western boundary. These are separated from upper Proterozoic Fouroumbala Series sandstones and quartzites by a major north/south trending fault. A thick red-coloured sandy unit is preserved in the high lying areas to the east, which has been named the Dimbi Formation. The area is extensively blanketed by Kalahari sands.

The Dimbi Project is divided into three distinct mineralised environments; firstly, the typical alluvial deposits associated with the palaeo-Kotto River; secondly, the alluvial deposits associated with its tributaries and thirdly, the blanket deposits associated with the Dimbi Formation on the interfluvial plateaus. The palaeo-Kotto River originally flowed southward from a point of river capture approximately 8km north northeast of the town of Dimbi. The main palaeo-channel cut along the line of outcrop of the lower schist unit of the Fouroumbala, entering the Oubangui 2.5km northwest of Satéma, and was presumably controlled by this faulted contact. Diamonds are found in the lowermost gravel layer, characterised by a yellow colour, and associated with the palaeo-Kotto River gravels and its tributary streams. Diamonds are also located at the base of the Dimbi Formation on the high lying areas, being concentrated in the crevices of the underlying basement sandstone.

A two pronged approach to exploration has been implemented at Dimbi; the first into the alluvial river gravels and the second into the colluvial (or blanket) Dimbi Formation. Exploration of the alluvial river gravels has been conducted initially using small prospecting pits and then by drilling to define the limit and thickness of the gravels. This has been followed up by bulk sampling using trenches. The extracted bulk sample gravels were processed through a 50tph diamond pan plant. Exploration of the Dimbi Formation has been conducted using both small (prospecting) and large (mega) pits.

A resource statement has been prepared for the Dimbi Project for the palaeo-Kotto and tributary river gravels only (Table 2). The extensive and detailed exploration through auger drilling has provided sufficient information on the gravel and overburden thicknesses to allow computerised modelling of volumes.

Grade information has been provided for the various gravel types, initially through the mega pits but more recently from the bulk sampling results. As of December 2007 a total of 4,020cts had been recovered from the bulk sampling. Difficulties experienced in siting the bulk sampling pits to intersect the gravels has resulted in some of the grade information not being useful in the derivation of the resource statement. Also, the results obtained during the plant's commissioning phase may not be accurate and are likely to represent an under valuation of the grade. As a result, only the grade figures from the later three bulk sample pits were used in the resource estimation. PDF's past experiences have enabled them to correct these technical issues and the bulk sampling programme going forward is likely to yield more useful results.

A parcel of Dimbi stones has been exported to Antwerp. The sale in February 2008 amounted to a total of US\$611,150 which results in an average price of US\$166/ct being obtained for Dimbi.

The palaeo channel diamond resources at Dimbi have been classified as Indicated, whilst those associated with the tributary gravels have been classified as Inferred.

The exploration results have been verified and the methods independently checked by Venmyn. We are of the opinion that the results are reliable, where stated, and that the data density, quantity and quality are sufficient for the delineation of Inferred Resources for Dimbi.

The recommended work programme for the Dimbi Project includes the continuation of the bulk sampling programme up until the second quarter 2008 in order to confirm the grade results. Thereafter pilot mining will be carried out to demonstrate the economic viability of the project.

## 1.2 Etoile Project

The Etoile Project comprises two project areas (Nzako & Kotto-Bangana) located in eastern central CAR between 175km and 350km northeast of the capital of Bangui (Figure 1). The project areas represent alluvial potential on the Nzako and Kotto Rivers, respectively. PDF owns 100% of the project through its subsidiary Efidium (Table 1 and Figure 2). These areas have a long history of both diamond and gold production which, since the late 1960s, have predominantly been a result of artisanal activities.

The project areas are at an early stage of exploration with only an initial reconnaissance exercise having recently been completed for Nzako. As a result of this no geological model has been formulated. Initial indications are, however, that a palaeo-braided stream environment was active at Nzako. This geological environment, together with the higher elevation lateritic deposits, has yielded diamonds.

These will form the target of future exploration at Nzako. Although widespread mining has taken place within the Nzako Project Area, extensive areas still remain available for mining. This is especially the case where the artisanal miners' rudimentary techniques make extraction too difficult or costly for them. Potential also exists in large areas of the laterite gravel deposits. Although the stripping ratios appear greater than those of the river gravels, the widespread areas and dry working conditions make these a future target area.

The reconnaissance exercise has identified a number of potential target areas. These areas will be followed up through exploration during 2008 using jimbo and mega pits in order to define resources. Advanced exploration is planned to commence in the final quarter of 2008, followed by bulk sampling in the first quarter of 2009.

No information on the local geological environment pertaining to the Kotto-Bangana Project Area is available. However, the historical production records suggest that this remains a prospective area for future exploration. After initial reconnaissance, an exploration programme will be carried out in the same manner as that planned for Nzako.

## 1.3 Longatshimo River Project

The Longatshimo River Project is comprised of six licences divided into five project areas. The project is situated on the Longatshimo River in south-central DRC near the Angola border. PDF has exploration, exploitation and small mining exploitation licences, held through local Congolese parties, entitling the company to between 80% and 100% of these project areas.

The mineralisation within the Longatshimo River Project consists of alluvial diamond deposits associated with the current Longatshimo River, the palaeo channels, its tributaries and colluvial (blanket) diamond deposits within the interfluvial environments.

Exploration in the area commenced with reconnaissance mapping and satellite interpretation to obtain an understanding of the geological model. This was then followed up on the ground with the excavation, by hand, of prospecting pits. A large number of small pits, known locally as jimbos, were also excavated to provide information with respect to gravel and overburden thicknesses. In addition, the gravels were extracted and processed manually or through a Boesman jig to determine whether the gravels were diamondiferous and, if so, a first estimate of grade. Based upon the positive results of the pitting programmes, bulk sampling and processing through a DMS plant will be carried out in during the first three quarters of 2008.

Auger drilling was also carried out to provide widespread information on the overburden thickness, with particular reference to delineating the 10m overburden thickness cutoff limit.

The extensive and detailed exploration through jimbo pitting and auger drilling, within the Kapopo and Kamonia Project Areas, has provided sufficient information on the gravel and overburden thicknesses to allow computerised modelling and a more accurate determination of volumes as compared to previously.

Grade information has been provided, for the various gravel types, through the prospecting and mega pitting exercises. An initial independent diamond valuation, indicative of today's market, has been provided for a small parcel.

A resource statement was prepared for the Kamonia and Kapopo Project Areas, as shown in Table 2. The gravel thicknesses were modelled using Surfer® to determine the volumes present. The pitting has provided the associated average grades. As of December 2007, a total of 175cts had been recovered from the Longatshimo River Project. A total of 110cts, extracted from the nearby Tshikapa River Project, were independently valued in Kinshasa by the Diamond Board in order to estimate the diamond sales price. These diamond values were used for both the Longatshimo and Tshikapa River Projects.

The exploration methods, results and interpretations have been independently verified by Venmyn. The data quantity and quality was sufficient for the declaration of the Diamond Resource statement. This statement was also independently verified by Venmyn.

Bulk sampling is to be carried out on Kamonia and Kapopo during the first three quarters of 2008 in order to confirm the grade results and to provide the carats required (at least 2,000cts) to increase confidence in the current diamond price.

Reconnaissance mapping and prospecting pitting was completed for the Kajama Project Area during 2007. This will be followed up by jimbo and mega pitting in 2008.

To date, no work has been carried out on the remaining project areas to the north namely; Somilo and Bashala. Reconnaissance is planned for these two areas during 2008.

#### **1.4 Tshikapa River Project**

The Tshikapa River Project is comprised of seven licences divided into four project areas. The project is situated on the Tshikapa River in south-central DRC near the Angola border and to the west of the Longatshimo Project Area. PDF has exploration and small mining exploitation licences held through local Congolese parties entitling the company to between 80% and 100% of the project areas.

As is the case for the other DRC properties, the mineralisation consists of alluvial diamond deposits associated with the current Tshikapa River, its palaeo channel, tributaries and blanket diamond deposits within the interfluvial environments.

Exploration in the area commenced with reconnaissance mapping and satellite interpretation to obtain an understanding of the geological model. This was followed up with the excavation, by hand, of prospecting pits as well as a large number of jimbos. These were used to obtain information with respect to gravel and overburden thicknesses. In addition, the gravels were extracted and processed manually or through a Boesman jig to determine whether they were diamondiferous. If so, a first pass estimate of grade was made. The recent exploration on Mvula Milenge and Nanzambi has confirmed the latest geological model for the DRC projects.

The extensive and detailed exploration through prospecting and jimbo pitting has provided sufficient information on the gravel and overburden thicknesses to allow computerised modelling and a more accurate determination of volumes as compared to previously.

Confirmation of the grade was then carried out through the excavation of large/mega pits to extract proportionally larger samples and therefore more reliable, grade estimates.

Initial auger drilling to define the gravel and overburden thicknesses was also carried out at Mvula Milenge. The initial exploration is complete on the southern-most project area of Mvula Milenge and based upon the positive results of the pitting programmes; bulk sampling and treatment through a DMS plant will be carried out commencing in the second quarter of 2009. Advanced exploration will be continued on Nanzambi during the remainder of 2008.

A resource statement has been prepared for the Mvula Milenge and Nanzambi Project Areas, as shown in Table 2. For both Mvula Milenge and Nanzambi, the gravel thicknesses were modelled using Surfer® to determine the volumes present. The pitting has provided the associated average grades for both project areas. As of December 2007, a total of 114cts had been recovered from the Tshikapa River Project. A parcel of 110cts of these diamonds was independently valued by the Diamond Board in Kinshasa. This valuation has provided an estimate of the diamond sales price in today's market.

The exploration methods, results and interpretations have been independently verified by Venmyn. The data quantity and quality was sufficient for issue of the Diamond Resource statement. This statement has also been independently verified by Venmyn.

To date, no work has been carried out on the remaining project areas to the north and south, namely Tumines and Kabula, respectively. Reconnaissance mapping is planned for these two project areas in 2008.

### 1.5 Cassanguidi Project

The Cassanguidi Project is currently extracting alluvial diamonds through a pilot mining operation. It is located in northeastern Angola approximately 25km south of the DRC border (Figure 1). The north flowing Luembe River passes through the concession. Cassanguidi has been divided into four project areas namely; Cassanguidi South, Cabuaquece, Catchoque and Cale.

Pilot mining is currently being carried out at Cassanguidi South using conventional openpit methods and processing through a diamond pan plant. Efidium has a 50% shareholding in a company which has the right to 65% of the operating profits of the project (Table 1 and Figure 2).

The Lunda Norte area is underlain by upper and lower Archaean sequences with numerous greenstone remnants, intruded by the Quibala Granite. The basement includes the Lower Proterozoic Lunda Group, comprising shales, quartzites and conglomerates, occurring as small down-faulted windows in the south-western corner of the project area. The Calonda Formation unconformably rests on the above units. The Calonda Formation comprises a continental sedimentary sequence of conglomerates, arkoses, sandstones and shales. Diamonds, weathered and eroded from kimberlites, were deposited by fluvial processes in the conglomerates of the lower Calonda. These kimberlite pipes were intruded during the early Cretaceous and were associated with southwest-northeast striking tectonic lineaments of the so called "Lucapa Graben". This sequence was capped by the deposition of the aeolian deposits of the Kalahari Group.

Alluvial diamond mineralisation is associated with the Calonda Formation and the Luembe River, its tributaries and the hillwash deposits within the interfluvial areas. This mineralisation was extensively exploited in the tributaries between 1956 and 1987.

PDF recommenced operations in the Cassanguidi South Project Area as a pilot mining operation when it acquired its share in the project in 2005. The focus has been on testing the economic viability of the project area through increasing production rates. This was carried out through increasing the earthmoving equipment on site and installing a larger processing plant.

A resource statement was prepared for the Cassanguidi Project in 2006. This has been updated to December 2007, where recent exploration and mining information was available (Table 2 and Table 3).

At present, only a small amount of Indicated Resources have been declared for Cassanguidi South and these resources are insufficient for the preparation of a Life-of-Mine (LOM) plan. A LOM plan is one of the minimum requirements for the demonstration of economic viability and the associated conversion of Indicated Resources into Probable Reserves. Only once this has been carried out can Cassanguidi South convert from pilot mining into a fully fledged mining operation. It is for this reason that no NI43-101F Item 25 report can be prepared for Cassanguidi South at this time.

It is recommended that PDF focuses their exploration efforts on increasing the geological confidence in Cassanguidi South's Inferred Resources in order to convert them to Indicated Resources. Only once sufficient Indicated Resources have been declared can a LOM plan be developed. PDF plans to achieve this through systematic trenching over the resource areas during 2008 and 2009 in order to confirm the grades across the delimited Inferred Resource areas.

Exploration on the other three project areas was focussed on processing the extensive historical data. These results, combined with the recent mining results and diamond sales figures, have enabled diamond resources to be determined. PDF is systematically confirming these results with new pitting and drilling exercises across the various project areas.

The gravel thicknesses were modelled using Surfer® to determine the volumes present. The grades were also modelled in Surfer®, where sufficient historical data was available. Additionally, the mined grades were applied to the adjacent diamond resource blocks. Limited bulk sampling has been carried out for grade determination in a number of the blocks. As of December 2007 a total of 71,298cts had been recovered from pilot mining and was sold into the diamond market.

The exploration methods, results and interpretations have been independently verified by Venmyn, where stated. The data quantity and quality was sufficient for the declaration of the Diamond Resource statement. This statement was also independently verified by Venmyn.

## 1.6 Bakerville Project

The Bakerville Project is comprised of four licences divided into two project areas. These project areas include Patsema and Geluskdal. The project is situated in the Lichtenburg Magisterial District, North West Province of South Africa. PDF currently holds 54.8% (74% assumes that the PANEX Option is excised) of the project through its subsidiary company Efidium (Table 1 and Figure 2). The project areas are both at an advanced stage of exploration.

The project is underlain by Transvaal Dolomite Formation which is interbedded with layers of chert units. The deposit comprises secondary alluvial gravels associated with gravel runs and potholes. There are two distinct gravel layers, separated by diamictites and clays. The upper gravel layer forms the main focus of PDFs exploration.

The objective of PDF's exploration is to identify and delineate these runs and potholes. Exploration in the area commenced with interpretation of satellite imagery, high resolution airborne magnetics, infrared surveys and ground gravity surveys. The exploration was followed up with Reverse Circulation (RC) drilling to determine the vertical and horizontal extent of the deposit on a 100m grid. Once gravels were identified, a smaller grid of 20m was used to delineate the gravels on the various farms.

Bulk and surface samples were excavated on the properties in order to determine a grade and diamond value for the project. The bulk samples were sited on the potholes, whilst the surface samples were located in the runs. The recommended work programme for the Bakerville Project includes the continuation of the bulk sampling programme until the end of 2009 through systematic trenching. Full-scale mining is expected to commence at the end of 2009.

A resource statement was prepared by PDF for the Patsema Project Area, as shown in Table 2, and was independently verified by Venmyn. The gravel thicknesses were modelled in Surfer® using drilling results, to determine the volumes present for the resource. The surface samples and bulk samples have provided the associated average grades. The Diamond Resource has been classified as Inferred. As of February 2008 a total of 24.2cts had been recovered from the Bakerville Project. Of the recovered diamonds 23.24 cts have been independently valued in order to estimate the diamond sales price.

The exploration methods, results and interpretations have been independently verified by Venmyn. The data quantity and quality was sufficient for the declaration of the Diamond Resource Statement. This statement was also independently verified by Venmyn.

## 1.7 Harts River Project

The Harts River Project is comprised of five licences divided into two project areas. These include the Brussels and Pampierstad Project Areas. The Harts River Project is situated near Vryheid in the Northern Cape Province of South Africa. PDF currently holds 54.8% (74% assumes that the PANEX Option is excised) of the project through its subsidiary company, Efidium (Table 1 and Figure 2). The Brussels Project Area is at an advanced stage of exploration, whereas the Pampierstad Project Area is at an early stage exploration.

The project is underlain by the rocks of the Ventersdorp Supergroup which comprise volcanics and minor sediments. A broad strip of basement granite and a narrow strip Kraaipan greenstones outcrop in a north-south direction through the central regions of the area. The project is classified as a secondary alluvial deposit associated with the palaeo-Harts River gravels.

The objective of PDF's exploration is to identify old palaeo-channels, preferably with a long strike length and a large catchment area. The exploration at both project areas involved percussion drilling, exploration pits and a bulk sample.

The percussion drilling was utilised to determine the vertical and horizontal extent of the deposit. Bulk samples and exploration pits were excavated on the Brussels Project Area in order to determine the grade and economic merits of the project. Bulk sampling will continue by contractor in the Pampierstad Project Area and by PDF in the Brussels Project Area. In the second half of 2009, PDF will select one of the project areas for mining.

A resource statement was prepared by PDF for the Brussels Project Area, as shown in Table 2, and independently verified by Venmyn. The gravel thicknesses were modelled using the drilling results in Surfer® to determine the volumes.

The exploration trenches of the bulk sample have provided the associated average grades. The Diamond Resource has been classified as Inferred. A total of 1,130 cts had been recovered from the Harts River Project. Of these diamonds 1,094cts have been sold in today's market in order to determine the diamond sale price.

The exploration methods, results and interpretations have been independently verified by Venmyn. The data quantity and quality was sufficient for the declaration of the Diamond Resource Statement. This statement was also independently verified by Venmyn.

### **1.8 Bloemhof Project**

The Bloemhof Project is comprised of four licences, with each license forming a project area. These project areas include Bergspruit, Wolmaransstad, Palmietfontein, and Zoutpan. The project is situated north of the town of Bloemhof in the North West Province, South Africa. PDF currently holds 54.8% (74% assumes that the PANEX Option is exercised) of the project through its subsidiary company Efidium. The Bloemhof Project is at an early stage of exploration.

The project is underlain by the rocks of the Ventersdorp Supergroup which comprise of volcanics and minor sediments. A broad strip of basement granite and a narrow strip of Kraaipan greenstones outcrop in a north-south direction through the central regions of the area. The project comprises secondary alluvial deposits, associated palaeo-channel deposits.

The objective of PDF's exploration is to identify old palaeo-channels, preferably with a long strike length and a large catchment area.

Exploration commenced on the Zoutpan Project Area in early 2007 involved percussion drilling, and a bulk sample. The percussion drilling was utilised to determine the vertical and horizontal extent of the deposit. Gravel thickness and overburden was modelled from the percussion drilling.

No historical or recent exploration data was available for the Bergspruit, Wolmaransstad and Palmietfontein Project Areas.

PDF plans to commence a bulk sampling programme, using a contractor, for the Harts River Project in all the project areas within 2008 in order to define a resource for the Project.

As a result of the paucity in exploration results, no Diamond Resource Statement was issued for the project. The exploration methods, results and interpretations have been independently verified by Venmyn.

## 2 INTRODUCTION

### 2.1 Terms of Reference and Nature of Transaction

Venmyn, as independent Qualified Person/s, were requested by the Directors of PDF to prepare a technical report on the company's diamond properties. This document has been prepared in accordance with the National Instrument 43-101 – Standards of Disclosure for Mineral Projects, Form 43-101F1 and Companion Policy 43-101CP (NI43-101F), as well as the CIM Definition Standards for Mineral Resources and Mineral Reserves (CIM Standards). The guidelines are considered by Venmyn to be a concise recognition of the best practice due diligence methods for this type of mineral transaction and accord with the principles of open and transparent disclosure that are embodied in internationally accepted Codes for Corporate Governance.

PDF has been listed on the AIM Market since October 2006. Venmyn completed the Competent Persons Report for the AIM Market listing in August 2006.

The current technical report has been compiled in order to incorporate all the latest available and material information that will enable potential finance providers to make a reasoned and balanced judgement regarding the technical merits of the projects.

### 2.2 Qualified Persons Declaration

Venmyn is an independent advisory company. Its consultants have extensive experience in preparing competent persons', technical advisers' and valuation reports for mining and exploration companies. Venmyn's advisors have, collectively, more than 100 years of experience in the assessment and evaluation of mining projects and are members in good standing of appropriate professional institutions. The signatories to this report are qualified to express their professional opinions on the values of the mineral assets described. To this end, Qualified Persons Certificates are presented in Section 41.

Neither Venmyn nor its staff have or have had any interest in this project capable of affecting their ability to give an unbiased opinion, and have not and will not receive any pecuniary or other benefits in connection with this assignment, other than normal consulting fees.

### 2.3 Sources of Information

This work has been based upon technical information which has been supplied by PDF and its subsidiary companies and which has been independently due diligenced by Venmyn, where possible. Pangea has warranted in writing that it has openly provided all material information to Venmyn, which, to the best of its knowledge and understanding, is complete, accurate and true.

### 2.4 Site Visit and Field Involvement

Site visits have been carried out to all PDF's projects that are material to the transaction. The dates and persons visiting these sites are summarised in Table 5.

**Table 5 : Summary of Site Visits**

CAR	Dimbi	March 2007, November 2007	CA Telfer
	Etoile	N/A	
DRC	Longitshimo River	November 2007	CA Telfer
	Tshikapa River	November 2007	CA Telfer
	Bakerville	March 2006, November 2007	CA Telfer, AG Bloomer, S Millward
South Africa	Harts River	March 2006, November 2007	CA Telfer, AG Bloomer, S Millward
	Bloemhof	March 2006	AG Bloomer, HL Sternberg

In the case of the property that has not been visited, i.e. Etoile, the company was in the process of erecting a base camp.



### 3 RELIANCE ON OTHER EXPERTS

Venmyn has relied upon a number of experts' opinions. These are listed in Table 6, along with their specific field of expertise or opinion.

**Table 6 : List of Other Experts**

AREA OF EXPERTISE	EXPERT NAME	PROJECT	REPORT TITLE/S
Environmental	Coastal & Environmental Service	Dimbi	Preliminary Environmental Assessment Report (October 2006)
			Exploration Phase Environmental Management Plan (September 2006)
Legal	Taback and Associates (Pty) Ltd	SA	Updated Due Diligence Report - TSX Listing Final
	Maitland Advisory LLP	Various	Legal Opinion on Pangea Diamondfields plc
	Adv. MMM Cunha	Angola	Legal Opinion on Pangea Diamondfields plc
	Djunga & Risasi Avocats	DRC	Legal Opinion on Pangea Diamondfields plc
	Crepin Mboli-Goumba LL.M	CAR	Legal Opinion on Pangea Diamondfields plc
Geostatistics	Carina Lemmer	Dimbi	Independent Study of the Potential Diamond Resources of the Mbia East Portion of the Dimbi Project.

#### 4 CENTRAL AFRICAN REPUBLIC PROJECTS

PDF has interests in two alluvial diamond projects within the CAR namely, Dimbi and Etoile, which cover a total area of 3,867km<sup>2</sup>. The Dimbi project is comprised of a single area of interest, whilst the Etoile project is divided into three project areas, as indicated in Table 1. The location of the CAR projects, in relation to the country's infrastructure, is illustrated in Figure 3.

#### 5 DIMBI PROJECT

The Dimbi Project is located on the Oubangui River in south central CAR (Figure 3 and Figure 4). The project is at an advanced stage of exploration, with bulk sampling and processing through a pan plant currently taking place. The Dimbi Project forms the major focus of PDF's work in the CAR.

##### 5.1 Property Description and Location

The Dimbi Project is situated 360km east of Bangui, in the Basse-Kotto District of the CAR (Figure 3). The south flowing Kotto River passes through the concession (Figure 4). The size of the concession, along with its coordinates, are summarised in Table 7.

**Table 7 : Dimbi Project Area and Boundary Coordinates**

PROJECT	PROJECT AREA	LICENSE TYPE	PERMIT NO.	AREA (km <sup>2</sup> )	AREA (ha)	BOUNDARY COORDINATES (LATITUDE, LONGITUDE)
Dimbi	N/A	Exploration	RC4-313	995.00	99,500	(4°16'44.6"N; 21°36'31.7"E); (4°21'04.2"N; 21°36'43.9"E); (4°33'22.8"N; 21°38'56.9"E); (4°44'25.0"N; 21°41'30.0"E); (4°44'25.0"N; 21°49'57.0"E); (4°28'33.0"N; 21°49'57.0"E); (4°16'25.3"N; 21°48'36.0"E); (4°18'28.6"N; 21°44'19.6"E); (4°18'24.6"N; 21°39'02.2"E)
<b>TOTAL DIMBI</b>				<b>995.00</b>	<b>99,500</b>	

The coordinates of the license boundaries were provided by the government in the official documentation. Although these have not been surveyed on the ground by PDF, they have been confirmed using the satellite image of the property.

Alluvial diamond mineralisation is associated with the palaeo-Kotto River, its tributaries and the interfluvial areas. This mineralisation has been exploited, to varying degrees, since the early 1900s by the French and more recently by local artisanal miners. Currently only limited artisanal activities are present within the license area. Mined out areas were identified, where possible, although the rapid regeneration of vegetation in these areas can make this difficult.

##### 5.1.1 Legal Aspects and Tenure

All mining licences in the country were suspended in 2003, following the overthrow of the government. They were re-instated, in some cases with modified concession boundary coordinates, in 2004 along with the issue of a new mining code; the Mining Code of Central African Republic Ordinance 04.001. In the CAR, all minerals are owned by the State but any person may be granted access to them through a number of different permits.

An Exploration Permit was originally issued to a local CAR company, Goldiam SARL (Goldiam), in March 2006. This was then ceded to Dimbi Diamants SA (Dimbi Diamants), a CAR registered subsidiary of Efidium. The ownership structure is illustrated in Figure 5. Efidium owns 100% of the project. The exploration permit allows Dimbi Diamants to utilise all methods required to localise and assess its mineral deposits. This includes bulk sampling and laboratory analysis. The license is valid until March 2009 and can be renewed twice for two further three year terms.

Dimbi Diamants has a Mining Development Agreement, or Mining Convention, with the Central African State which covers the general, legal, financial, tax, economic, administrative, customs and social conditions agreed to between the parties pertaining to prospecting, exploration and mining. According to the Mining Convention, Dimbi Diamants is required to:-

- provide the State with a 10% free carried interest, effectively reducing PDF's share to 90%;

**LEGEND:**

- Town
- Provincial Boundary
- ~ River
- Main Road
- - - Secondary Road
- ✈ Airport
- Diamond Occurrences
- ▭ Licence Area

**LOCALITY PLAN OF CAR PROJECTS**

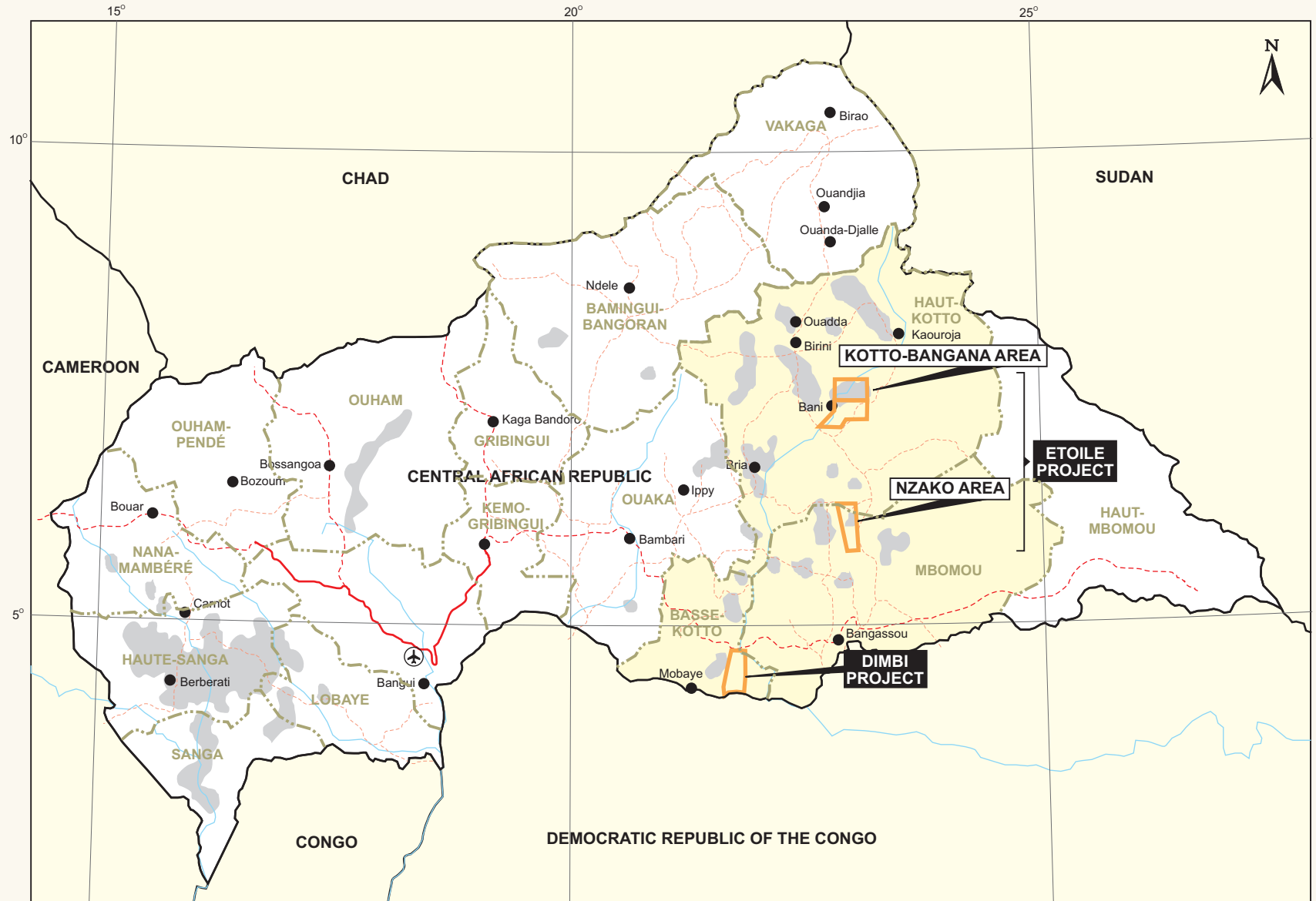

Source: Ministère Energetiques et Minerales, Bangui: Provisional Edition, June 1995

SCALE:



This diagram and the information herein is copyrighted. It may not be reproduced or transmitted in any form or by any means without prior written permission from Venmyn Rand (Pty) Ltd. Trading as Venmyn.

**INFRASTRUCTURE PLAN FOR THE CAR PROJECTS**

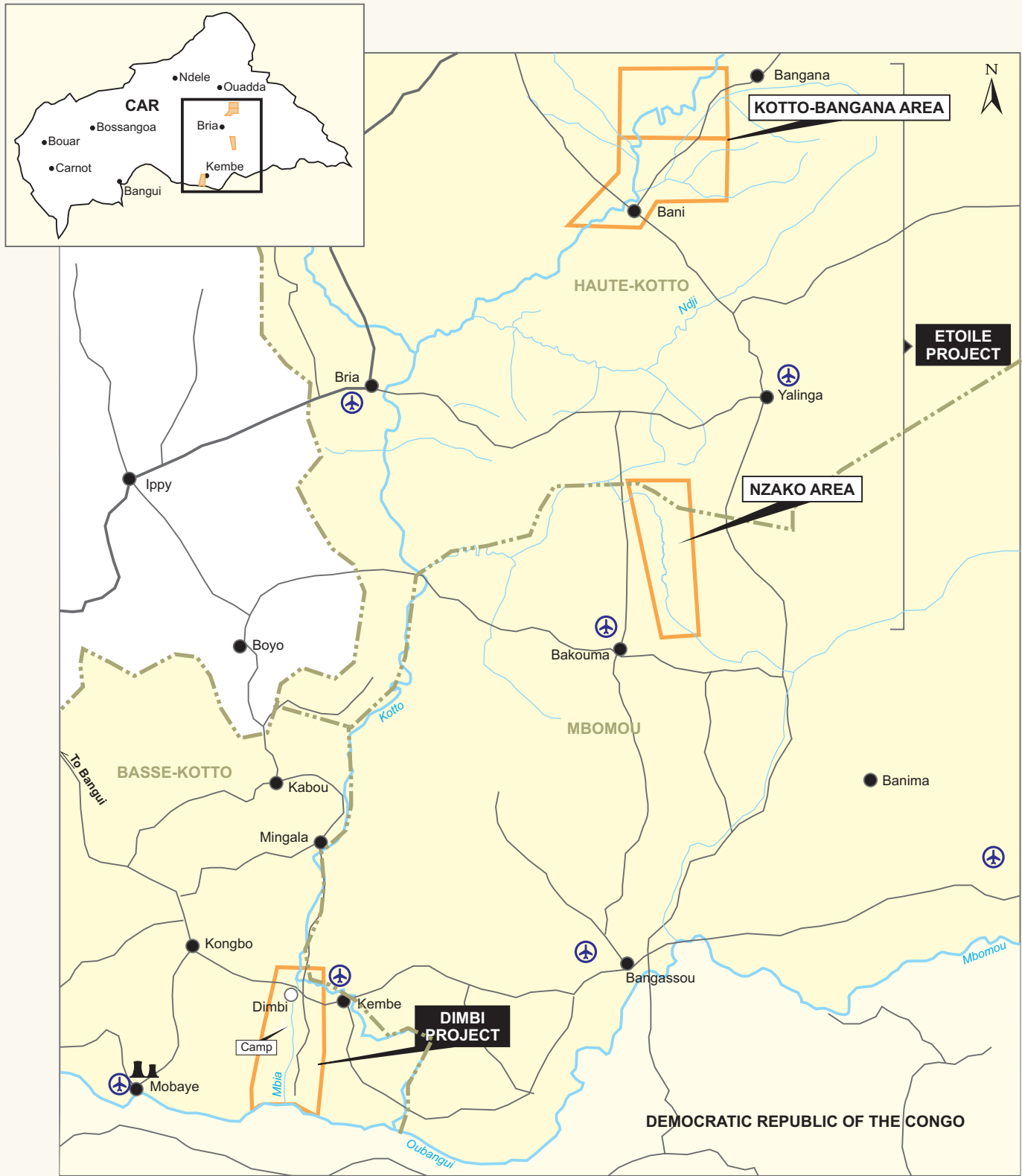

Source: Pangea

**LEGEND:**

- Exploration Permit Area
- Road
- Town
- Village
- River
- ⊕ Airstrip
- ⚡ Electricity

**SCALE:**



This diagram and the information herein is copyrighted. It may not be reproduced or transmitted in any form or by any means without prior written permission from Venmyn Rand (Pty) Ltd. Trading as Venmyn.

**OWNERSHIP OF THE DIMBI AND ETOILE PROJECTS**

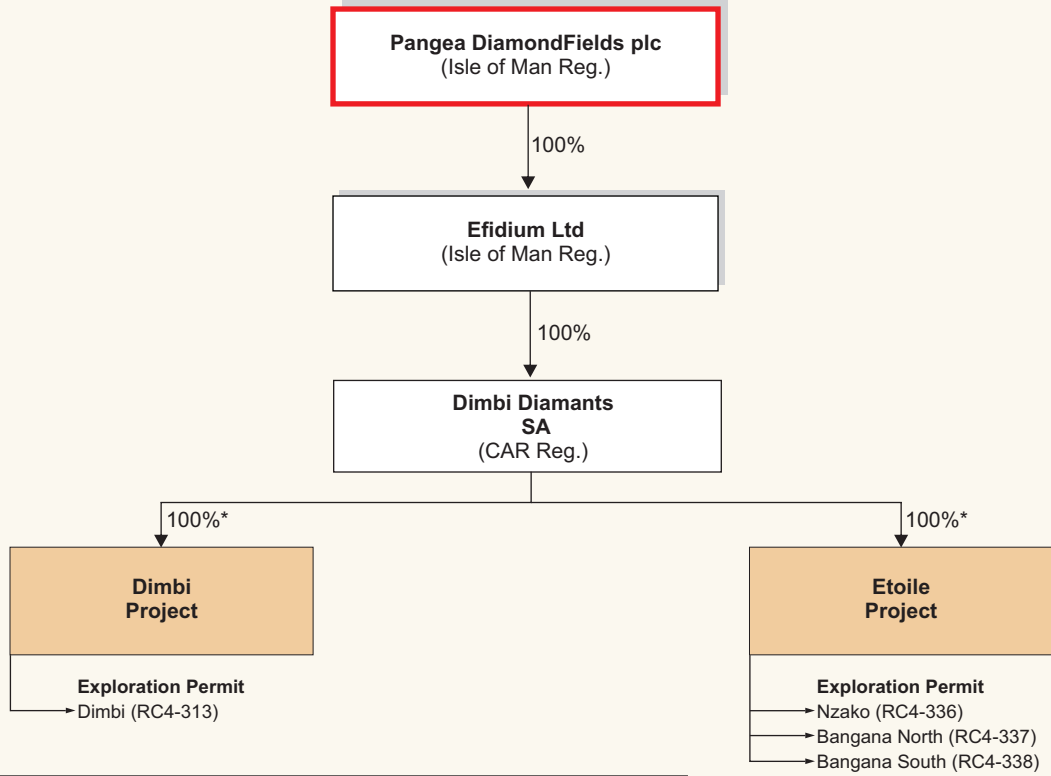

**KOTTO RIVER FALLS**



\*Note: On granting of the mining permit Efidiums share reduces to 90%, with the State getting a 10% free carried interest.

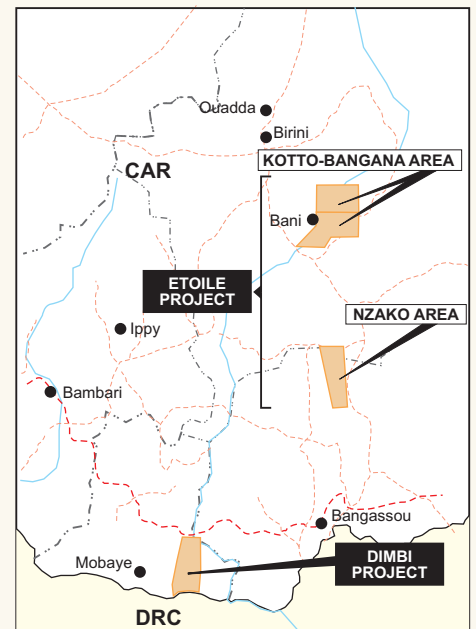

Source: Venmyn, Pangea

This diagram and the information therein are copyrighted. It may not be reproduced or transmitted in any form or by any means without prior written permission from Venmyn Rand (Pty) Ltd. Trading as Venmyn.

- pay to the State an initial amount of US\$750,000, as well as an amount equal to 10% of all recognized exploration expenses;
- provide the State with two 4x4 vehicles and four satellite telephones;
- employ local staff, wherever possible, and to implement training programmes with the ultimate objective of replacing the expatriate staff;
- use local services and raw materials as far as possible;
- take all necessary measures to protect the local environment and undertake an environmental impact study;
- enter in a reserve fund, a maximum of 5% of profits, for rehabilitation of the mining site to internationally recognised standards;
- carry out mining operations in accordance with industry accepted standards;
- preserve the infrastructure used for its operations;
- provide the State with quarterly reports on the exploration results; and
- complete a Feasibility Study provided the initial exploration results are positive.

The State, in turn, is obliged to:-

- provide Dimbi Diamants with exclusive rights to explore, develop, mine, extract, process, market and sell, on international markets, the mineral in question;
- grant Dimbi Diamants a mining permit within the exploration permit area;
- facilitate the acquisition of any ancillary permits required during the course of mining including those related to the employment of expatriate personnel;
- provide a stable financial, economic and legal environment in which to conduct business with particular reference to those items of a financial nature which are defined in the agreement; and
- provide exemption from all import taxes and duties, including value added tax (VAT), for all equipment, consumables and spares to be used in research and mining; and
- the right to freely transfer the proceeds generated from capital expenditure investment out of the country.

All rights pertain to the exploration for both alluvial and kimberlitic diamonds. The legal tenure is summarised in Table 8.

**Table 8 : Dimbi Project Legal Tenure**

PROJECT	PROJECT AREA	LICENSE TYPE	PERMIT NO.	MINERAL	LICENSE HOLDER	AREA (km <sup>2</sup> )	EXPIRY DATE	STATE'S SHARE
Dimbi	N/A	Exploration	RC4-313	Gold and Diamonds	Dimbi Diamants	995.00	Mar 2009	0%

Fees are paid to the government for the right to access the surface over the area.

### 5.1.2 Royalties, Fees and Taxes

The State requires the payment of a royalty of 6% on the parcel value, which includes 4% for Droit Sortie (DS) which are export taxes, 0.5% Redevance Equipement Informatique et Finance (REIF) which are for use of customs information and for clearances, 0.5% Secretariat Permanent du Processus de Kimberley (SPPK) for Kimberley process taxes, and 1% Projet du Development du Secteur Miniere (PDSM) to assist in financial development of the mining sector. The CAR company tax rate is 30%, and the withholding tax on dividends is set at 10%. VAT of 19% is payable on services and local purchases.

Fees are payable for the renewal or transfer of permits and for the use of the surface. These are defined in the Mining Development Agreement.

### 5.1.3 Impact of the Project on the Environment

According to the Mining Development Agreement, Dimbi Diamants is required to:-

- “take all necessary measures to protect the local environment;
- undertake an environmental impact study, prepare and implement, prior to commencement of the production, an environmental action plan;
- compile reports on its activities in accordance with the environmental action plan;
- carry out mining operations in accordance with standards accepted by the mining industry;
- rehabilitate the mining site in accordance with internationally recognised standards in the mining industry;
- at the end of each financial year, to enter in a reserve fund dedicated to the rehabilitation of the mining site, a maximum amount of 5% of the profits subject to company tax; and
- according to the recommendations of the environmental impact study, to monitor the effects of mining operations on the environment following the closure of the mine.”

In October 2006, PDF contracted the services of South African based environmental consultants, Coastal and Environmental Service, to complete a Preliminary Environmental Assessment Report and an Exploration Phase Environmental Management Plan. The first report identified the baseline data on which future environmental studies can be carried out. It concluded that, with proper management and planning, the mining of alluvial diamonds at Dimbi will have acceptable environmental impacts. The most important of these relates to the possible impact of the operation on surface water.

The second report defined the environmental control measures and reporting procedures to be used at Dimbi Project during the exploration phase.

If mining commences then PDF will employ the services of an internationally recognized environmental expert to prepare the required studies.

## 5.2 Accessibility, Climate, Local Resources, Infrastructure and Physiography

### 5.2.1 Locality, Population and Access

The Dimbi Project is situated approximately 5km west of the town of Kembe in the Basse-Kotto District of south central CAR (Figure 4). The small village of Dimbi is located within the concession area.

Access to the project area from the capital of Bangui is either by road or by air. A single primary road extends from Bangui to Kembe. This road is tarred for the first 200km and thereafter is gravel. The road is in a poor condition and the trip from Bangui to Kembe typically takes eight hours. The alternative route is by light aircraft from Bangui International Airport to the Kembe strip which takes approximately one hour. Transport by air is the most reliable, effective and the quickest method of travel.

PDF actively maintains the gravel road between Kembe and the Dimbi camp.

No railway services are present in the CAR. Although the Oubangui River is large and navigable, very little traffic is present on it east of the cataracts at Mobaye.

### 5.2.2 Infrastructure and Local Resources

A camp has been established by PDF in the Dimbi concession which comprises accommodation, ablution, offices and mess facilities for 40 staff (Figure 4 and Figure 6).

A 100tph diamond processing plant has been erected adjacent to the camp. The camp also has a small clinic.

All water is sourced from the nearby Mbia River and its tributaries. Potable water for the camp is filtered using a water purification plant prior to consumption. Power is supplied to the camp using a diesel powered generator.

The closest town to the Dimbi Project is Kembe (Figure 6) where unskilled and semi skilled labour is sourced. The town of Kembe has a dirt airstrip, a clinic and a small school. No electricity or running water is available in Kembe.

The closest large town is Mobaye, situated to the west of the project area. The size of the population living in Mobaye is unknown. Mobaye is the nearest town with electricity which is sourced from a small hydroelectric plant on the Oubangui River.

The company also has a country headoffice in Bangui. PDF has access to sufficient surface area for future potential mining and processing operations and tailing disposal.

### 5.2.3 Climate and Vegetation

The environmental study identified six vegetation or habitat zones which included the following:-

- woodland savannah. This zone covers the largest area within the concession and typically consists of dense grasses and individual or small groups of trees;
- gallery forest. This occurs within the riparian zones and comprises a closed canopy overstorey with a multilayered understorey of small trees and bushes;
- wetland complex. These are saturated areas dominated by hydrophytic plants and shrubs;
- riverine system. This includes the Mbia and Oubangui Rivers and their tributaries;
- sandstone ridges. These are rocky outcrops which are host to most of the woodland savannah vegetation; and
- transformed landscapes. This represents the cultivated landscapes which are most prevalent around villages and in the high lying areas. Crops grown by the local inhabitants include maize, cassava, plantain, groundnuts, sweet potatoes, ochra and pineapples.

The climate in the Dimbi Project area is classified as tropical with high midday maximums and moderate nightly minimums. Temperatures recorded for Bangassou vary from a midday maximum of 35°C in February to a night time minimum of 18°C in December/January. There are typically two seasons namely; a long wet season between February and October and a short dry season from November to January. No annual precipitation measurements were available, but most rainfall is precipitated as thunderstorms.

The surface area closely associated with the rivers and their tributaries is very wet during the rainy season. This prevents operations being carried out in this vicinity during this time. During the rainy season PDF concentrates their operations on the higher lying ground or away from the rivers.

### 5.2.4 Physiography

The project area is situated on or adjacent to the south flowing Mbia River. This small river flows downstream of the point where the Kotto River was blocked and diverted due to uplift and is the current day equivalent. The Mbia River drains into the major Oubangui River which forms the border between the CAR and DRC. The Oubangui River is a tributary to the Congo River.



**INFRASTRUCTURE AND EQUIPMENT AT DIMBI PROJECT CAMP**

**KEMBE TOWN**



**DIMBI CAMP**



**PAN PLANT**



**AUGER DRILL**



**DRILL SAMPLES**



**BOESMAN JIG**



**MINING EQUIPMENT**



PangeaDFieldsTSX'07Fig06.cdr

Source: Venmyn

This diagram and the information herein is copyrighted. It may not be reproduced or transmitted in any form or by any means without prior written permission from Venmyn Rand (Pty) Ltd. Trading as Venmyn.

The physiology of the project includes river valleys and interfluvial areas with a gentle gradient. Four parallel sandstone ridges and a series of isolated hills are also present. The elevation varies from a maximum of 639m above mean sea level (amsl), on the west of the concession, to a minimum of 400m amsl at the Oubangui River.

### 5.3 History

Historically, diamond exploration and mining has been focussed in the Mouka and Bria regions of eastern CAR and in the Carnot region in the west. There was little interest in the area of Dimbi in the past. The history of the diamond discoveries in the CAR and, thereafter, the history specific to the Dimbi concession are summarised in Table 9.

**Table 9 : History of Diamond Discoveries in the CAR and the Dimbi Project**

DATE	COMPANY	ACTIVITY
1914	Prospector	First diamond found in the CAR in the Mouka region to the east.
1929	Compagnie Equatoriale des Mines (CEM)	Diamond recovered from tributary of the Kotto in the region of Bria. CEM recovered >700 carats.
1930 – 1960	CEM, Compagnie Miniere de l'Oubangui Oriental & Others	Discovery and exploitation of most of the known deposits of both east and west CAR.
1959 - 1963	Bureau de Recherche Geologique et Minerale (BRGM)	Compilation of all available data on the diamond deposits up to 1963 into "Geology and Mineral Resources of the CAR". Only released in 1982.
1997	BRGM	Surveyed artisanal excavations and compiled their records of diamond production.
Sept 2005	Goldiam	Obtains a reconnaissance permit RC1-191 for Dimbi.
	Efidium	Goldiam enters a heads of agreement with Efidium for the pursuance of development of the Dimbi concession.
Mar 2006	Goldiam	Obtains a decree from the CAR government for an exploration permit RC4-313 for Dimbi.
	Efidium	Commencement of site establishment and exploration at Dimbi.

#### 5.3.1 Historical Exploration, Sampling and Production Records

During the mid 1990s BRGM came to an agreement with the local artisanal operators to publish their production results. The artisans were required to keep daily records of the number and size of stones extracted and the number of samples washed. BRGM collected these production results and confirmed the volumes of gravel by surveying the excavations. The company also noted the gravel and overburden thicknesses. The pit positions are shown on Figure 7 and the results are summarised in Table 10.















**Table 10 : BRGM Exploration Results**

PIT NO.	GRAVEL TYPE	DATE	O/B* THICKNESS (m)	GRAVEL THICKNESS (m)	GRAVEL VOLUME (m <sup>3</sup> )	CARATS	GRADE (ct/100m <sup>3</sup> )	NO. STONES	STONE SIZE (ct/stone)
1	Palaeo Kotto	1994	10.00	0.50	85	312.00	367.06	926	0.34
2	Palaeo Kotto	1993	4.00	0.50	64	448.35	700.55	9,444	0.05
12	Palaeo Kotto	1996	3.00	0.05	8	46.50	581.25	180	0.26
<b>TOTAL / AVE</b>					<b>157</b>	<b>806.85</b>	<b>513.92</b>	<b>10,550</b>	<b>0.08</b>
4	Tributary	1995	3.00	0.30	45	50.85	113.00	122	0.42
5	Tributary	1996		N/A		18.40		33	0.56
6	Tributary	1996		N/A		6.26		25	0.25
7	Tributary	1994	3.00	0.30	40	110.80	277.00	360	0.31
8	Tributary	1996	3.00	0.30	44	10.88	24.73	44	0.25
9	Tributary	1994	3.00	0.30	54	192.30	356.11	529	0.36
10	Tributary	1996		N/A		20.00		81	0.25
11	Tributary	1995		N/A		6.95		23	0.30
<b>TOTAL / AVE (for pits with gravel volumes)</b>					<b>340</b>	<b>364.83</b>	<b>107.30</b>	<b>1,055</b>	<b>0.35</b>

\* O/B = Overburden

Note that pit P2 had an exceptionally high grade but a very small stone size which skewed the average. This may in fact be a transcription error in BRGM's data, as a total of 944cts would yield a stone size of 0.47ct/stone, which is more in line with the other results.

**LEGEND:**

-  Town
-  River
-  Island
-  Exploration Licence Area
-  Palaeo Kotto (Mbia) River Gravels
-  Postulated Palaeo Kotto (Mbia)
-  Tributary Gravels
-  Phyllites (Eburnian Schists)
-  Quartzites (Mica Schists)
-  Sandstone and Quartzite
-  Dimbi Formation
-  Postulated Dimbi Formation
-  Fault
-  Historical Pits by BRGM
-  Proposed Mining Licence Boundary
-  Recent River System Prospecting Pits

**LOCAL GEOLOGY AND HISTORICAL PITTING SITES WITHIN THE DIMBI PROJECT**

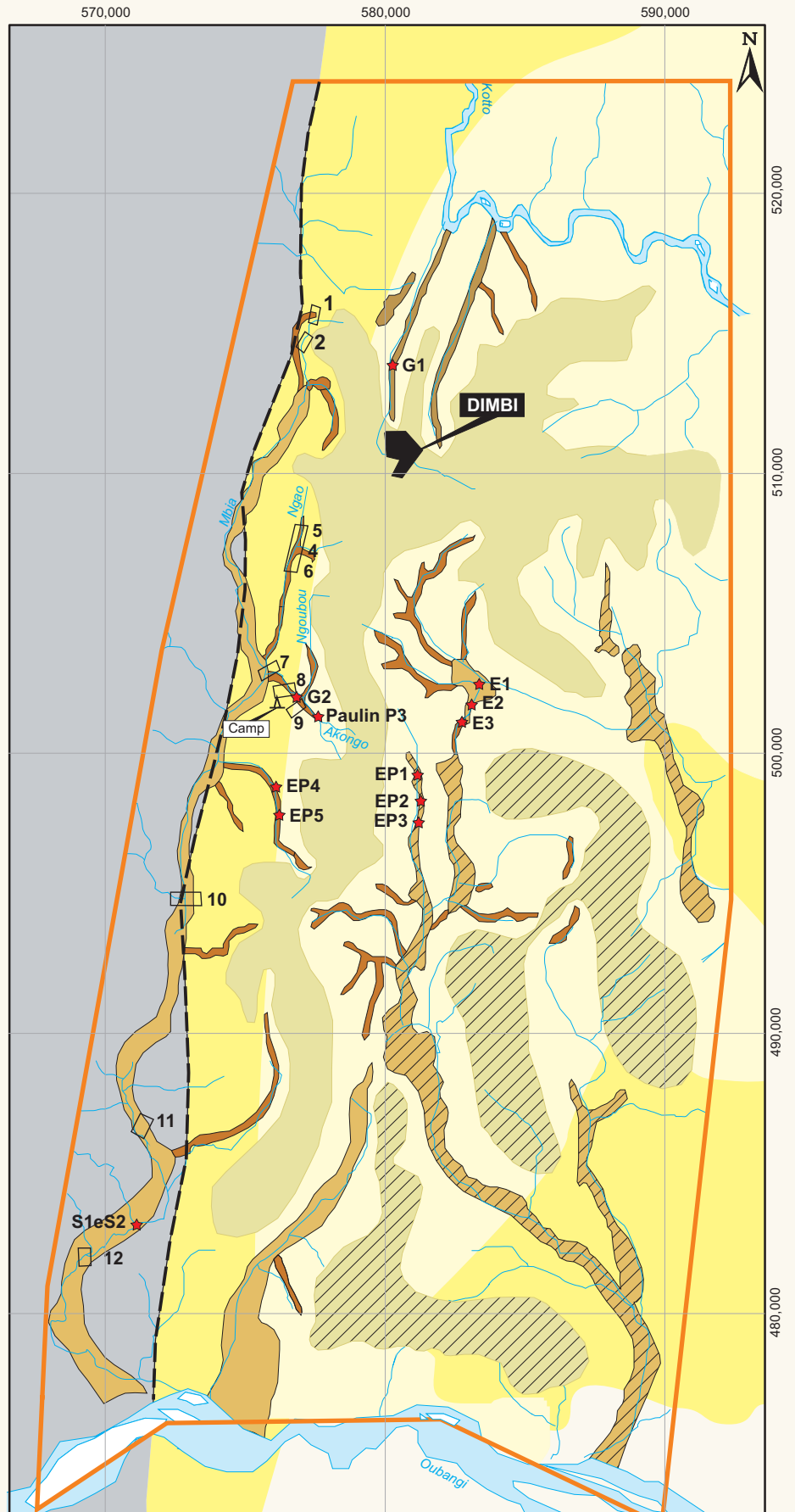

PangeaDFieldsTSX'07Fig07.cdr

Source: Ministère Energetiques et Minerales, Bangui:  
Provisional Edition, June 1995

**SCALE:**



This diagram and the information therein are copyrighted. It may not be reproduced or transmitted in any form or by any means without prior written permission from Venmyn Rand (Pty) Ltd. Trading as Venmyn.

No other historical exploration or production records were available for the Dimbi Project.

BRGM included in their publication the diamond prices obtained by the artisanal workers (Table 11). Note that the prices typically obtained by the artisan from the diamond buyers were always significantly lower than those that could be obtained on the free market. The values obtained are summarised in Table 11. The diamond values have been converted to US\$ from Communauté Financière Africaine Francs (CFA) using an estimated exchange rate of US\$1=CFA550 and then escalated to convert them into an estimate of today's relative market price.

**Table 11 : Historical Diamond Prices**

DATE	PIT NO.	GRAVEL TYPE	CARATS	VALUE (CFA/ct) (Mid 1990's)	VALUE (US\$/ct) (Mid 1990's)	EST. VALUE (US\$/ct) (2007)
1994	1	Palaeo Kotto	312.00	25,900	47	82
1993	2	Palaeo Kotto	448.35	19,300	35	61
1996	12	Palaeo Kotto	46.50	46,900	85	149
<b>TOTAL / AVE</b>			<b>806.85</b>		<b>43</b>	<b>75</b>
1995	4	Tributary	50.85	52,000	95	165
1996	5	Tributary	18.40	88,700	161	282
1996	6	Tributary	6.26	31,100	57	99
1994	7	Tributary	110.80	21,000	38	67
1996	8	Tributary	10.88	47,300	86	151
1994	9	Tributary	192.30	11,200	20	36
1996	10	Tributary	20.00	45,700	83	145
1995	11	Tributary	6.95	22,600	41	72
<b>TOTAL / AVE</b>			<b>416.44</b>		<b>46</b>	<b>81</b>
<b>Additional 30% for selling stone directly into the market</b>						<b>105</b>
<b>TOTAL / AVE Excluding P2</b>			<b>774.94</b>		<b>74</b>	<b>129</b>

It is important to note that the average price is significantly influenced by the results of Pit 2 which yielded very small diamonds fetching low prices. The remaining pits produced diamonds of similar sizes to recent sampling results and on average would have fetched a price of at least US\$206/ct in today's market.

### 5.3.2 Historical Diamond Resources

No historical Diamond Resource and Diamond Reserve estimates were available for the Dimbi Project.

## 5.4 Geological Setting

### 5.4.1 Regional Geological Setting

The CAR is underlain by Precambrian schistose and crystalline rocks, covering an area of 400,000km<sup>2</sup>, overlain, in the western and east-central parts, by flat-lying Cretaceous sandstone formations (Figure 8). The Precambrian is subdivided into three major divisions, an Archaean basement, a Lower Proterozoic metasedimentary sequence and an Upper Proterozoic sedimentary cover.

The Archaean basement comprises essentially granites, gneisses, and granitoid migmatites, with vestiges of volcano-sedimentary greenstones. The basement is overlain by a series of Lower Proterozoic quartzites and mica schists, intensely deformed during the 1,000-900Ma Kibaran orogeny. The quartzites cover approximately 50,000km<sup>2</sup> in the centre of the country, whilst the mica schists are found mainly in the south-east.





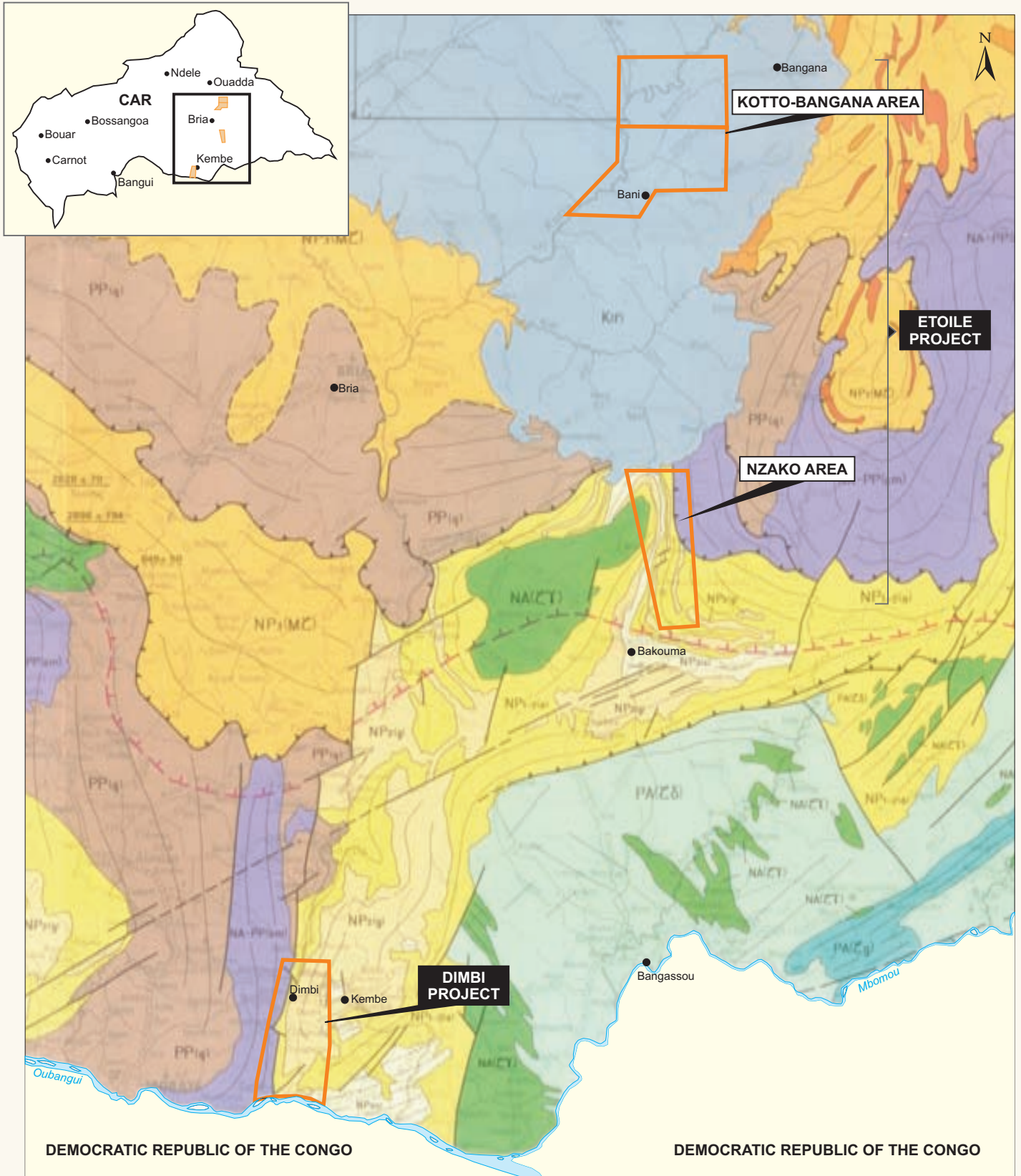



Unconformably overlying this sequence is a cover of folded Upper Proterozoic sediments which include, from the bottom upwards, a sedimentary sequence, a fluvio-glacial sequence, and an upper shale-carbonate sequence, with basic lavas in the extreme southwest. All the above sequences were affected by the Pan-African (700-600Ma) orogeny, and were intensely migmatized and granitized with over-thrusting from north to south.

**REGIONAL GEOLOGY OF THE SOUTH CENTRAL CAR**



Source: Pangea

**LEGEND:**

	<b>Cretaceous</b>	Mouka-Ouadda and Carnot Sequence
	<b>Upper Proterozoic</b>	Carbonates
		Sandstones and Quartzites
		Mica Schists and Schistose Argillites
	<b>Lower Proterozoic</b>	Eburnian Quartzites
		Eburnian Schists
	<b>Archaean</b>	Undifferentiated Basement Complex
		Syntectonic Granites
		Amphibolites and Amphibolo-pyroxenites (Greenstones?)

**SCALE:**



This diagram and the information herein is copyrighted. It may not be reproduced or transmitted in any form or by any means without prior written permission from Venmyn Rand (Pty) Ltd. Trading as Venmyn.

Thin (<400m) veneers of flat-lying sandstones, assumed to be of Cretaceous age, cover a total of some 85,000km<sup>2</sup> in two well defined shallow basins in the southwest (Carnot Formation) and the east-central area (Mouka-Ouadda Formation).

In the southwest the sandstones are underlain, below a strong unconformity, by the Mambere Formation, a mudstone-siltstone sequence with conglomeratic horizons, glacial in origin. A similar sequence, the Kombele Formation, has also been recognised in the east. Aeolian sands and clays occur on both the sandstone plateaux.

The recorded alluvial diamond deposits of the CAR are very broadly related to the outcrop areas of the Mouka-Ouadda Formation in the east and the Carnot Formation in the west. It is generally accepted that the diamonds recovered from the recent alluvial deposits in the modern drainage systems were derived from placers in the Mouka-Ouadda and Carnot Formations. This premise is based on a perceived spatial relationship between the alluvial deposits and the conglomerate sequences. However, this spatial relationship is tenuous as many recently discovered deposits are situated many kilometres from the Mesozoic outcrop areas and from river systems that do not drain the supposed source rocks.

Several other origins have been proposed. The most likely theory states that the diamonds are sourced from either intra-Carnot or immediately post-Carnot age sediments in a similar manner to the alluvial deposits found in the East Kasai Province of the DRC. The DRC diamonds are derived from typical kimberlites which pre-date these sedimentary sequences. No such event has, however, been recognised in the CAR, and none of the classical kimberlite indicator minerals have yet been positively identified in concentrates from the alluvial deposits. The primary source rock is therefore unlikely to be "normal" kimberlite, but could be a rock of lamproitic affinity or something analogous to the diamondiferous meta-kimberlite dykes of the Mitzi area (Gabon), which have none of these classical indicator minerals. It should be noted, however, that the Mitzi dykes are Proterozoic in age, and are apparently unique.

Taking into account the overall distribution of the CAR alluvial diamonds, the conclusion that at least the major primary source rock is of late- or post-Carnot age is acceptable. It is also possible that more than one primary source existed, and that the diamonds could have, in part, been derived from several sources of different ages.

#### 5.4.2 Local and Property Geology

The oldest rocks occurring in the area are members of the mid- to lower Proterozoic Eburnian Supergroup. These poorly exposed schists and schistose quartzites form an approximately 4km wide belt within and paralleling the western boundary of the concession (Figure 7). The foliation of the schists generally dips steeply towards the northwest.

To the east of the faulted contact with the Eburnian, the entire lease is underlain by a crudely synformal belt of meta-sediments of the upper Proterozoic Mokia Supergroup, known locally as the Fouroumbala Series (Figure 7). The sequence comprises, from the bottom upward; mica schists (not present in the lease area); quartzose schists; schistose sandstones and quartzites; overlain in places by carbonate rocks. The entire project area is extensively blanketed with Kalahari sand.

The geological map of the superficial deposits within the concession (Figure 7) was compiled from the interpretation of the satellite image. The Dimbi Formation had not been identified on any geological maps of the area and was discovered and colloquially named by PDF.

### 5.5 Deposit Type

The Dimbi Project is host to both alluvial and blanket diamond deposits. Alluvial diamonds have been identified by PDF from two geological environments namely the palaeo-Kotto River channel and its tributaries. Blanket diamonds have been recovered from the Dimbi Formation on the interfluvial plateaus of the high lying ground. A schematic cross section of the deposit types is illustrated in Figure 9.

**LEGEND:**

- Dimbi Formation
- Kaolinised Sediments
- Diamondiferous Sediments
- Eburian Schist
- Fouroumbula Sandstone
- Eburian Schist
- Sterile Gravel
- Fault

**SCHEMATIC CROSS SECTION OF THE DIAMONDIFEROUS DEPOSITS IN THE DIMBI PROJECT**

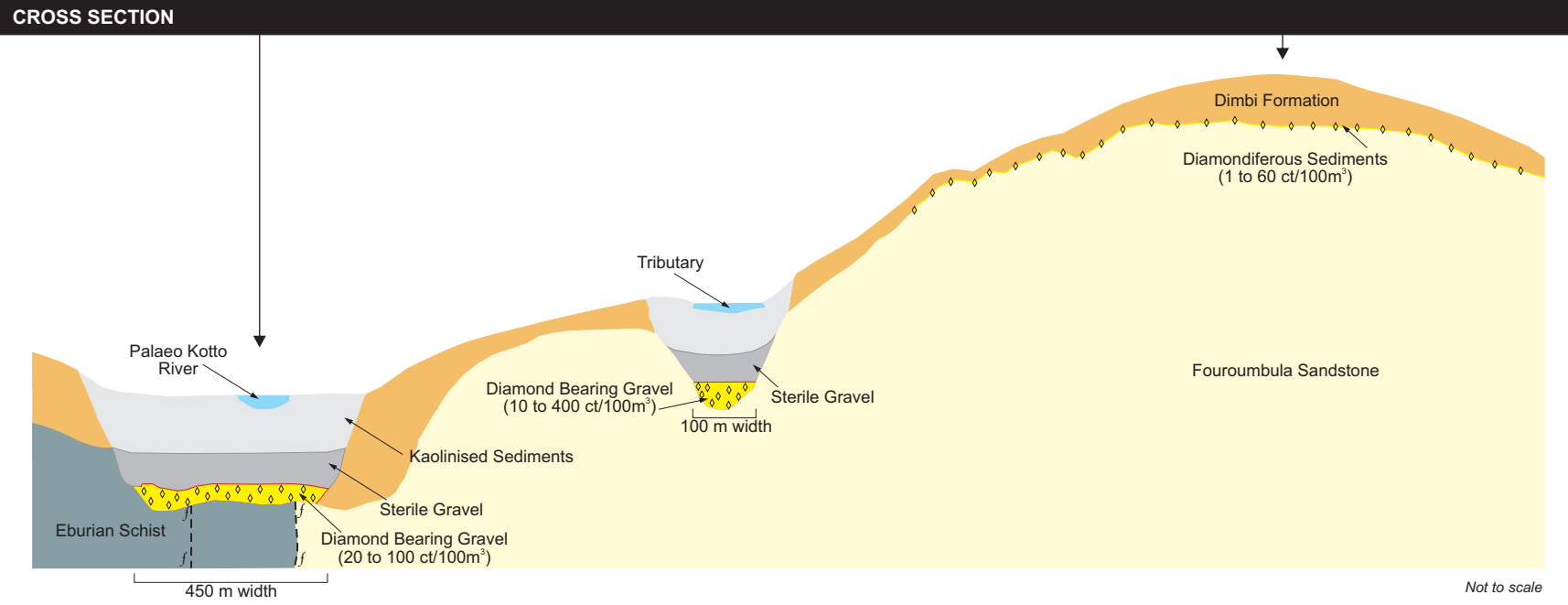

PangeaDFieldsTSX'07Fig09.cdr

This diagram and the information herein is copyrighted. It may not be reproduced or transmitted in any form or by any means without prior written permission from Venmyn Rand (Pty) Ltd. Trading as Venmyn.

These three deposit types formed the focus of PDF's exploration and, through this exploration work, resources have been defined for a portion of the alluvial deposits. Further detail on each is described in the following section on mineralization.

## 5.6 Mineralization

The diamond mineralization within the Dimbi Project has been divided into the three geological environments:-

- alluvial palaeo-Kotto River gravels (Figure 7 and Figure 9). The palaeo-channel system of the Kotto River originally flowed southward past the town of Dimbi. The main palaeo-channel was cut along the line of outcrop of the lower schist unit of the Fouroumbala, entering the Oubangui 2.5km northwest of Satéma, and was presumably controlled by the faulted contact. Alluvial gravels were originally exposed in artisanal workings in the present Mbia River.

Typical palaeo-Kotto gravels are comprised of a 2-3m thick grey/white upper sterile layer of 25mm pebbles within a fine grained matrix. This is underlain by a sandy layer. The characteristic yellow basal gravel carries the diamonds. It is typically 0.7m thick with a coarse grained matrix and well rounded pebbles of cherty quartzite and sandstone. The pebbles have an average size of 20mm. Occasional cobbles are present up to 0.5m in size. The overburden of the gravel package is kaolinised sediments up to 10m thick. Tourmaline and chromite are present in the heavy mineral fraction.

- alluvial tributary gravels (Figure 7 and Figure 9). Several small tributary streams flow into the Kotto palaeo-channel. These include the Akongo, Ngau, Ngoubou streams.

These tributary sediments are comprised of an upper sterile clay rich gravel with very small pebbles, followed by a diamondiferous basal gravel. The gravels are separated by sand lenses.

To the east of the Mbia River, the basal gravel overlies red clay, presumably situated above the sandstone bedrock. Towards the west, however, the gravels overlie a green grit indicative of the schist bedrock below. The basal gravel or rubble is small (<20mm) and angular with an average thickness of 0.5m. The gravel lies at a lower elevation than the mapped base of the Dimbi Formation and at a higher elevation than the Kotto gravels and is restricted to the slope between the two units. This unit is seen as a hill wash gravel, partially exposed by incision of the minor tributaries, rather than having been deposited by them;

- blanket Dimbi Formation sediments (Figure 7 and Figure 9). This is a thick red-coloured sandy unit preserved over a broad area on the higher ground to the east of the main Kotto palaeo-channel, and was informally named as such by PDF (Figure 7). The Dimbi Formation lies unconformably on an undulating sandstone surface. The diamondiferous gravel layer at the base of the formation varies between 0.01m and 1.50m and collects within the crevices and depressions of the bedrock. The gravel consists of a low proportion of small angular clasts within a red sandy matrix. PDF believe that the deposit was formed as a result of a deflation surface of a palaeo-Kotto floodplain, with the possibility of a small amount of reworking into channels.

## 5.7 Exploration

The exploration method utilised for the Dimbi Project has been based on a phased approach currently being applied to the river system/alluvial targets and the Dimbi Formation/blanket targets. The exploration phases are as follows:-

- Phase I. This entailed the identification of an initial area of interest and was carried out through wide-spaced drilling combined with pitting in the areas of optimal gravel development. The drilling provided typical gravel thicknesses as well as their lateral extent. The pitting comprised initial prospecting pitting which was followed by mega pitting. The prospecting pits, due to their small size and resultant small gravel volumes, were used primarily to determine whether mineralisation was present and secondly as geological controls. The mega pitting, sampling and processing of the gravels, by hand or by jig, provided indications of grade. Phase I was predominately carried out during 2006 but is still ongoing in some areas; and



- Phase II. The purpose of Phase II was to obtain a representative parcel of diamonds from Dimbi, of the order of 4,000cts, for sale to determine the average diamond price. In order to complete this, bulk sampling within a 5km radius of the plant is currently being carried out. Processing takes place through a 50tph pan plant with final recovery using a GB400 automatic grease table. Drilling continued during this phase using a tractor mounted auger. Phase II commenced in January 2007 upon the arrival of the heavy equipment and is still ongoing.

The details of the exploration phases are outlined in the sections to follow.

## **5.8 Phase I – River System Prospecting Pitting**

A total of 10 prospecting pits were excavated into the river system gravels, by hand digging, during 2006 and 2007, as indicated on Figure 7. These were used primarily to determine whether mineralisation was present and secondly as geological controls.

### **5.8.1 Sampling Method and Approach**

The pit positions were selected based upon areas where gravel was expected to be present, i.e. at river confluences and where artisanal workings existed. In some cases the pit positions were often confirmed by drilling prior to excavation.

These pits were used to identify the potential of the area and were not systematically undertaken at regular spaced intervals across the deposit. Therefore, the results were indicative of optimal gravel development areas and were not necessarily representative of the entire deposit.

The pits were numbered sequentially from 1, with an alphabetical prefix to indicate reconnaissance pits eg. EP1.

Surveys of pit positions were done using a global positioning system (GPS) by the site geologist. Dimbi Project does not employ a surveyor. The collar positions were measured repeatedly until the measurement differences were less than 9m. All pits were plotted onto 1:5,000 and 1:1,000 plans using the surveyed coordinates. Elevations were measured by barometric pressure using the GPS. These measurements were generally not very accurate and fluctuated according to the prevailing weather conditions.

The pits were all excavated by hand using the local labour force. They were dug to reach the base of the gravel and typically excavated from a pit base area of 5m by 7m using 20 litre (l) buckets. EP1 to EP3 were excavated to a bottom size of 10m x 5m.

No samples were taken of the clay beneath the gravel. Pits were stopped either in the clay beneath the gravel or, where present, in the bedrock schist.

The excavation, sampling, processing and final recovery of the diamonds were monitored by PDF staff.

### **5.8.2 Sample Preparation, Analyses and Security**

Only a single sample was taken from each pit by PDF and processed over a period of days. The sample was referred to by the pit number and the date of processing.

It must be noted that, in the case of alluvial diamond exploration, no samples are sent to a laboratory for analysis. All samples are processed on or near site by one of the following method or plants in order to extract the diamonds and thereafter calculate the grade:-

- hand washing, in a nearby source of running water using a sieve;
- jiggling and hand sorting;
- pan plant and automatic grease belt; or
- dense medium separation (DMS) and Flowsort or automatic grease belt.

**LOCATION OF RIVER SYSTEM AND BULK SAMPLING PITS FOR DIMBI PROJECT**

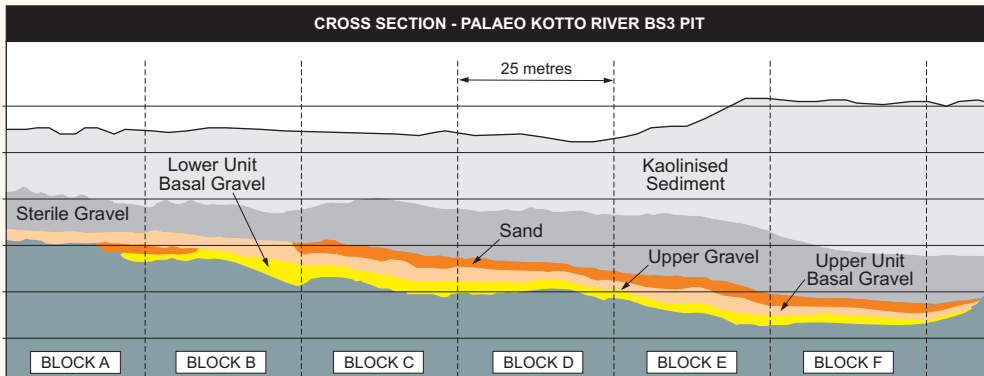
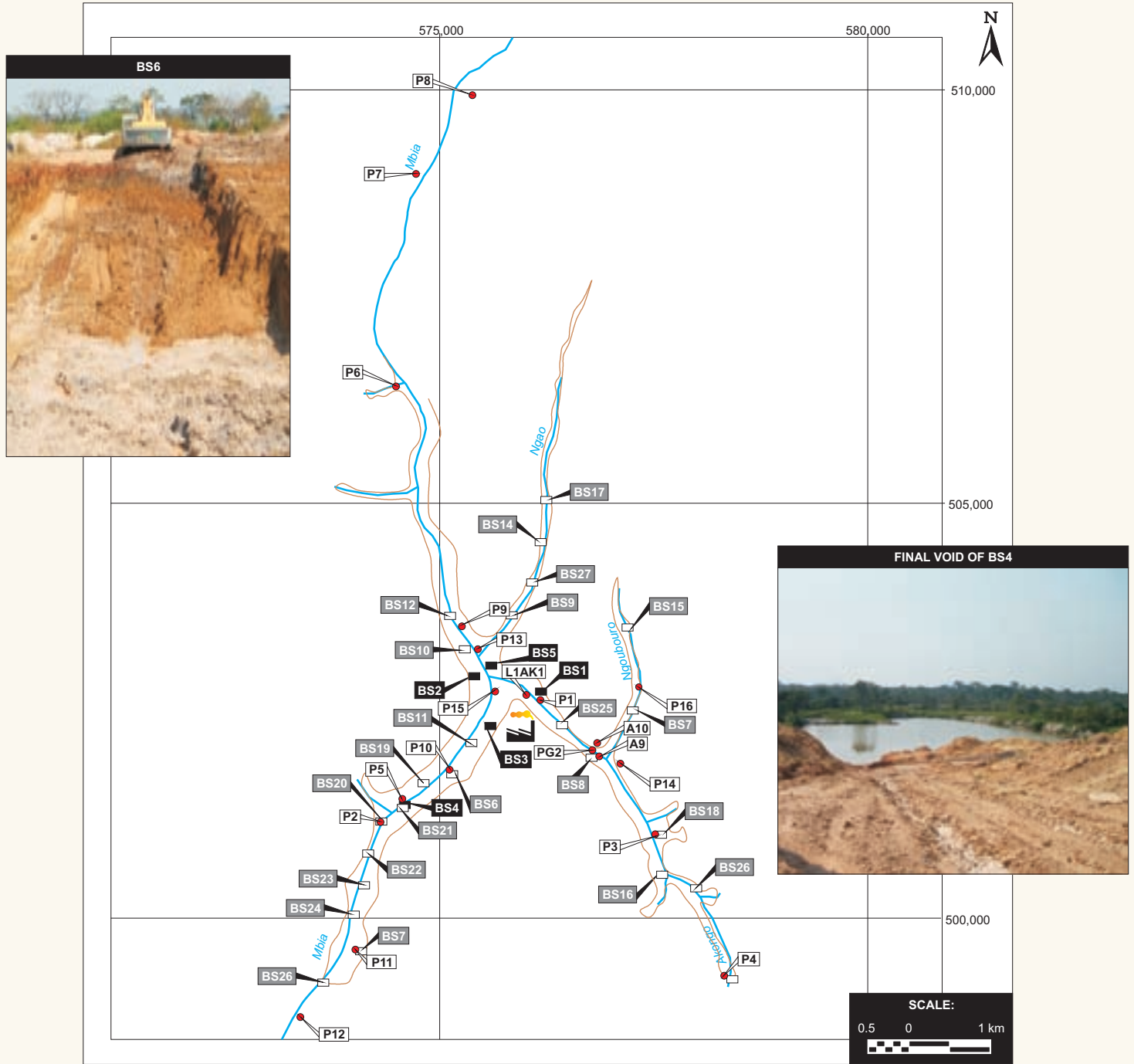

Block	Recovered Grade cts/100m <sup>3</sup>	Recovered Mined Grade (diluted to mining width) cts/100m <sup>3</sup>
Block A	21.2	9.8
Block B	15.2	9.1
Block C	54.0	30.1
Block D	88.7	47.3
Block E	81.9	44.1
Block F	56.1	28.8

Source: Pangea

**LEGEND:**

- River
- River System Pits
- Proposed/in Progress Bulk Sampling Pits
- Completed Bulk Sampling Pits
- Plant
- Floodplain

This diagram and the information therein are copyrighted. It may not be reproduced or transmitted in any form or by any means without prior written permission from Venmyn Rand (Pty) Ltd. Trading as Venmyn.

All samples taken in Phase I were manually scrubbed and then treated through a Boesman jig. Hand scrubbing was undertaken using a primitive oil drum sieve to remove the fines. Thereafter, the concentrate was treated in one of two Boesman jigs (Figure 6). The jigs, manufactured specifically for PDF by 1 Stop Engineering (Pty) Ltd (1 Stop), treated 8 tonnes per day (tpd) of feed. The bottom screen size cutoff of the jig was 1.6mm.

The feed to the jig was measured using 20l buckets. The buckets were weighed to measure density for conversion to tonnes. It is not known how often the bucket was weighed. Note that this measurement would have provided the heaped wet density of the post scrubbing material. The density was measured at 2.0-2.2t/m<sup>3</sup>. This does not provide a density measurement for the in situ gravel.

The final recovery from the jig concentrate was done by hand at the jiggling site. Sorting was done by an expatriate geologist under the watchful eye of the local chief. Each diamond was weighed.

The diamonds were then taken either to the camp or to Bangui for safe keeping. Since then these diamonds were placed in uniquely numbered sealed bags and sold.

The efficiency of the jig has occasionally been measured using tracers. These measurements were not formal and no adjustments were made to the processing as a consequence. Comments from various staff member suggest that the diamond yields may be unreliable. This is due to both the jiggling process and the associated security. As a result the area may have been under estimated with respect to grade

One of PDF's geologists and the local chief were in attendance at all times during the processing and final sorting. However, due to the fact that the processing operation was not fenced and that the ore was hand scrubbed, opportunity existed for the illegal removal of diamonds. The final sorting area was also not secured in any manner.

The method of sample preparation is adequate with respect to general alluvial diamond exploration practises in extremely remote areas. As noted above, the method of processing is not perfect both from both a recovery and a security perspective. However, this may only result in an under estimation of the grade and therefore the results are acceptable to the Qualified Person.

### **5.8.3 Data Verification**

The pit coordinates and results of the day's diamond extraction were recorded in Excel sheets. These sheets were submitted to PDF's head office in Johannesburg for verification on a regular basis. Verification included the following:-

- checking the database against the original data sheets on a random basis;
- plotting all samples position; and
- checking mathematical calculations with respect to volumes and grades.

Venmyn has verified the data set on a sample basis.

### **5.8.4 Results**

The summary of results for the prospecting pitting is tabulated, by gravel type, in Table 12. The samples were representative of the gravel types sampled.

**Table 12 : Summary of River System Prospecting Pitting For Dimbi Project**

PIT NO.	GRAVEL TYPE	O/B THICK (m)	GRAVEL THICK (m)	GRAVEL VOLUME (m <sup>3</sup> )	CARATS	NO. STONES	GRADE (ct/100m <sup>3</sup> )	STONE SIZE (ct/stone)	BOTTOM SCREEN SIZE (mm)
E1	Tributary	1.50	0.00						
E2	Tributary	1.20	0.30	2.20	0.00	0	0.00		1.6
E3	Tributary	Abandoned							
EP1	Tributary	1.50	0.00						
EP2	Tributary	4.00	0.30	1.00	0.96	4	96.00	0.24	1.6
EP3	Tributary	Abandoned							
EP4	Tributary	In progress							
EP5	Tributary								
<b>TOTAL / AVE TRIBUTARY</b>				<b>3.20</b>	<b>0.96</b>	<b>4</b>	<b>30.00</b>		
S1	Palaeo-Kotto	2.80	1.00	77.32	0.62	2	0.80	0.31	1.6
S2	Palaeo-Kotto	5.00	0.00						
<b>TOTAL / AVE PALAEO KOTTO</b>				<b>77.32</b>	<b>0.62</b>	<b>2</b>	<b>0.80</b>		

## 5.9 Phase I – River System Mega Pitting

A total of 17 mega pits were excavated into the river system gravels, by hand digging, between March 2006 and the end of 2007, as indicated on Figure 10.

### 5.9.1 Sampling Method and Approach

The purpose of the mega pits was to obtain sufficient gravel sample to process and obtain a meaningful estimation of the grade.

As was the case for the prospecting pitting, the pit positions were selected based upon areas where gravel was expected to be present, i.e. at river confluences and where artisanal workings existed. In some cases the pit positions were confirmed by drilling prior to excavation.

These pits were used to identify the potential of the area and were not systematically undertaken at regular spaced intervals across the deposit. Therefore, the results were indicative of optimal gravel development areas and were not necessarily representative of the entire deposit.

The pits were numbered sequentially from 1, i.e P1 to P16. The results of an artisanal pit was also utilised by PDF. This pit was known as Paulin's pit. Pit G2 was dug at the start of the exploration at Dimbi, and as a result has a different naming system.

Surveys of pit positions were done using a GPS by the site geologist.

The pits were all excavated by hand using the local labour force. They were dug to reach the base of the gravel. This was usually intersected at a depth of 7m. A sample of the gravel was then extracted from an area of 5m by 7m at the base of the pit using 20l buckets. P16 was excavated to a size of 10m x 10m. In order to safely maintain the sidewalls of the pits down to the required depths in the soft sediments, benching was undertaken at 2m intervals. This resulted in a maximum pit size at surface of 20m x 20m. A number of the pits collapsed due to water influx prior to extraction of the gravels.

No samples were taken of the clay beneath the gravel. Pits were stopped either in the clay beneath the gravel or, where intersected, in the bedrock schist.

The excavation, sampling, processing and final recovery of the diamonds were monitored by PDF staff.

### 5.9.2 Sample Preparation, Analyses and Security

The sample preparation, analysis and security applied to the prospecting pits was also utilised for the mega pits. This is described in detail in Section 5.8.2.

### 5.9.3 Data Verification

Again the pit coordinates and results of the day's diamond extraction were recorded in Excel sheets. These sheets were submitted to PDF's head office in Johannesburg for verification on a regular basis, as described in Section 5.8.3. Venmyn has verified the data set on a sample basis.

### 5.9.4 Results

The summary of results for the mega pitting is tabulated in Table 13.

**Table 13 : Summary of River System Mega Pitting Results for Dimbi Project**

PIT NO.	GRAVEL TYPE	O/B THICK (m)	GRAVEL THICK (m)	GRAVEL VOLUME (m <sup>3</sup> )	CTS	NO. STONES	GRADE (ct/100m <sup>3</sup> )	STONE SIZE (ct/stone)	BOTTOM SCREEN SIZE (mm)
P1	Pit collapsed, re-opened as BS1								
P6 - P14	Pits collapsed.								
G2	Tributary			30.00	3.03	7	10.10	0.43	1.6
P3	Tributary	8.00	0.45	47.50	25.59	91	53.87	0.28	1.6
Paulin	Tributary	8.00	0.45	25.00	40.99	162	163.96	0.25	
P4	Tributary	4.00	0.45	18.00	2.92	10	16.22	0.29	1.6
P16	Tributary	5.00	0.85	74.60	14.41	66	19.32	0.22	1.6
<b>TOTAL / AVE TRIBUTARY</b>				<b>195.10</b>	<b>86.94</b>	<b>336</b>	<b>44.56</b>	<b>0.26</b>	
P2	Palaeo Kotto	5.00	0.45	4.30	0.42	4	9.77	0.11	1.6
P5	Palaeo Kotto	6.00	0.60	148.90	37.93	157	25.47	0.24	1.6
P15	Palaeo Kotto	N/A	0.60	36.72	9.64	N/A	26.25		1.6
<b>TOTAL / AVE PALAEO KOTTO</b>				<b>189.92</b>	<b>47.99</b>	<b>238</b>	<b>25.27</b>	<b>0.20</b>	

A total of 134.93ct was recovered from the mega pitting exercise. The average stone size is shown in Table 13. The largest stone recovered was 1.84ct in size.

## 5.10 Phase I – Dimbi Formation Prospecting Pitting

A total of 24 small prospecting pits (Figure 11) was excavated into the Dimbi Formation by hand digging between June and November 2006.

### 5.10.1 Sampling Method and Approach

The pits were located on the upper elevations of the Dimbi concession area to intersect the Dimbi Formation blanket gravels (Figure 9). They were positioned above the elevation of the lip of the scarp slope, at approximately 560m amsl. The pits were located at a distance of approximately 500m from each other.

Except for the first pit, L20, the Dimbi Formation pits were sequentially numbered from 1 – 23 and named with a prefix of DF to indicate their location within the Dimbi Formation. The pit positions were surveyed by the geologist using a GPS as described in Section 5.9.1.

The pits were hand dug by the local labour force to bedrock, a depth of between 3-4m. The area of each pit was 2m x 2m. No benching was required as the pit sidewalls were stable (Figure 11). One of the pits namely; DF12, was extended to form a trench with a size of 36m x 12m.

The pits were mapped and the sidewalls logged by the geologist supervising the sampling process.

### 5.10.2 Sample Preparation, Analyses and Security

Each of the gravel layers covering the 2m x 2m area were excavated and treated separately. The material situated within the crevices of the bedrock was also extracted and treated separately. Separation between samples was rough and contamination between them may have occurred.

**LEGEND:**

■ Dimbi Formation Pits

**LOCATION OF DIMBI FORMATION PITS FOR THE DIMBI PROJECT**

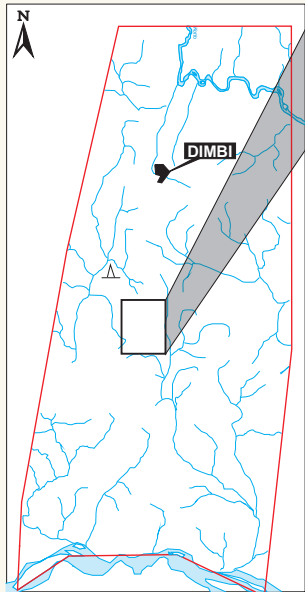

PangeaDiamondFieldsTSX'07Fig11.cdr

Source: Pangea

**SCALE:**



This diagram and the information therein are copyrighted. It may not be reproduced or transmitted in any form or by any means without prior written permission from Venmyn Rand (Pty) Ltd. Trading as Venmyn.

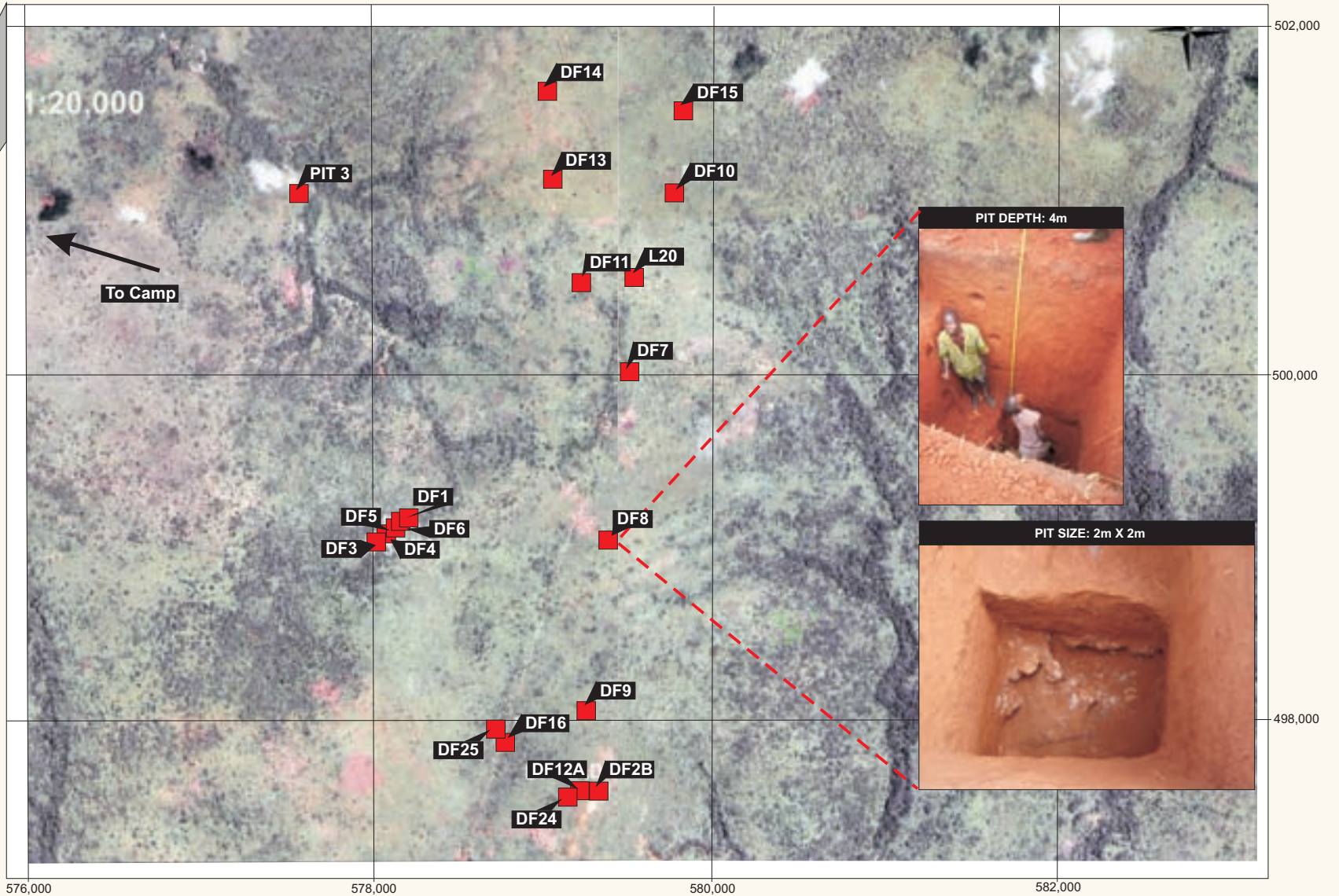

Although the samples were not allocated a particular sample number, they were referred to by the pit number and the gravel layer, eg. DF1 1<sup>st</sup> Layer, DF1 2<sup>nd</sup> Layer and DF1 Bottomlayer/bedrock. However, not all samples were provided with this gravel layer description.

The excavated samples were placed adjacent to the pit ready for transport to the nearest river by vehicle and then treatment using the jig plant. All samples taken in Phase I were manually scrubbed and then treated through a Boesman jig as described in Section 5.9.2.

The method of sample preparation is adequate with respect to general alluvial diamond exploration practises in extremely remote areas. As noted above, the method of processing is not perfect both from both a recovery and a security perspective. However, this may only result in an under estimation of the grade and therefore the results are acceptable to the Qualified Person.

### 5.10.3 Data Verification

The pit coordinates and results of the diamond extraction are recorded in separate Excel sheets. The data was entered into this sheet by the expatriate geologist on a daily basis. These sheets were regularly sent through to the PDF head office for verification (Section 5.8.3). As previously noted, Venmyn has verified each data set on a sample basis.

### 5.10.4 Results

The results of the Dimbi Formation pitting are tabulated in Table 14.

Although 3cts were recovered from the Dimbi Formation pitting exercise, the purpose of these pits was rather to obtain geological information relating to the gravel and overburden. These pits were, in general, too small to expect to recover diamonds, based upon grade indications from this area.

**Table 14 : Summary Dimbi Formation Prospecting Pitting Results for Dimbi Project**

PIT NO.	GRAVEL TYPE	O/B THICK (m)	GRAVEL THICK (m)	GRAVEL VOLUME (m <sup>3</sup> )	CARATS	NO. STONES	GRADE (ct/100m <sup>3</sup> )	STONE SIZE (ct/stone)	BOTTOM SCREEN SIZE (mm)
L20	Dimbi Fm	1.10	0.55	20.83	0	0			1.6
DF1		1.80	0.60	10.82	0	0			1.6
DF2		0.50	0.20	8.72	0	0			1.6
DF3*		2.90	1.10	1	0	0			1.6
DF4		3.30	1.80	10.6	0	0			1.6
DF5		2.90	1.60	15.8	0	0			1.6
DF6		4.90	0.70	1.52	2.88	1	189.47	2.88	1.6
DF7		0.30	0.30	N/A					
DF8		2.20	0.95	2.26	0	0			1.6
DF9		0.95	1.94	12.12	0	0			1.6
DF10		4.62	0.70	N/A					
DF11		1.40	0.80	2.42	0	0			1.6
DF12		1.70	0.4	N/A					
DF13		1.30	1.20	7.6	0	0			1.6
DF14		2.10	0.90	3.28	0.13	1	3.96	0.13	1.6
DF15		1.90	1.10	2.82	0	0			1.6
DF16*		3.10	1.55	1	0	0			1.6
DF17		0.50	0.00	N/A					
DF18*		0.50	0.80	1	0	0			1.6
DF19		2.80	0.80	3.12	0	0			1.6
DF20*		0.70	1.20	1	0	0			1.6
DF21*		2.80	2.30	1	0	0			1.6
DF22*		5.40	1.10	1	0	0			1.6
DF23	3.40	1.80	3.78	0	0			1.6	
<b>TOTAL / AVE</b>				<b>111.69</b>	<b>3.01</b>	<b>2</b>	<b>2.69</b>	<b>1.51</b>	

\* Gravel volume estimated.

## 5.11 Phase I – Dimbi Formation Mega Pitting

A total of 3 mega pits (Figure 11) was excavated into the Dimbi Formation by hand digging. The first (G1) was excavated at the start of the exploration programme and the remaining two (DF24 & DF25) during mid 2007.

### 5.11.1 Sampling Method and Approach

These pits were also located on the upper elevations of the Dimbi concession area to intersect the Dimbi Formation blanket gravels (Figure 9) as described in Section 5.10.1.

The initial pit was named G1. The two latter pits were sequentially numbered from 24 and named with a prefix of DF to indicate their location within the Dimbi Formation. The pit positions were surveyed by the geologist using a GPS as described in Section 5.9.1.

The pits were hand dug by the local labour force to bedrock to form trenches with a size of 36m x 12m. The pits were mapped and the sidewalls logged by the geologist supervising the sampling process.

### 5.11.2 Sample Preparation, Analyses and Security

In the case of pits DF24 and DF25 multiple samples were taken and these were given an alphabetical suffix to describe sequential samples along the pit/trench. This resulted in samples being named DF24a or, where the samples were treated together, DF24bcd.

The excavated samples were transported to the nearest river by vehicle for treatment. All samples taken in Phase I were manually scrubbed and then treated through the Boesman jig as described in Section 5.9.2.

### 5.11.3 Data Verification

The pit coordinates and results of the diamond extraction were recorded in separate Excel sheets. The data was entered into these sheets by the expatriate geologist on a daily basis. These sheets were regularly sent through to the PDF head office for verification (Section 5.8.3).

### 5.11.4 Results

The results of the Dimbi Formation mega pitting are tabulated in Table 15. A total of 41.84cts was recovered with an average stone size of 0.26ct/stone and a grade of 13.63ct/100m<sup>3</sup>. The largest stone extracted from the Dimbi Formation pitting was 2.88cts in size.

**Table 15 : Summary Dimbi Formation Mega Pitting Results for Dimbi Project**

PIT NO.	GRAVEL TYPE	O/B THICK (m)	GRAVEL THICK (m)	GRAVEL VOLUME (m <sup>3</sup> )	CARATS	NO. STONES	GRADE (ct/100m <sup>3</sup> )	STONE SIZE (ct/stone)	BOTTOM SCREEN SIZE (mm)
G1	Dimbi Fm	N/A	N/A	108.00	22.26	77	20.61	0.29	1.6
DF24		1.20	1.20	179.03	2.99	18	1.67	0.17	1.6
DF25		3.00	1.96	20.00	16.59	64	82.95	0.26	1.6
<b>TOTAL / AVE</b>				<b>307.03</b>	<b>41.84</b>	<b>159</b>	<b>13.63</b>	<b>0.26</b>	

## 5.12 Phase I – River System Drilling

Drilling was only undertaken in the river system deposits. An auger was used for all holes due to the soft nature of the sediments. A total of 170 holes was drilled in Phase I, as indicated on Figure 12. Drilling focussed on three rivers namely the Mbia, Ngouboro and Akongo.

### 5.12.1 Sampling Method and Approach

Boreholes were initially drilled on 300m line spacings and then on 100m line spacings. The holes were drilled at 50m intervals along these lines. The drill lines were set out at right angles to the rivers, where possible, and extended from the river banks to the projected limits of the gravel, based upon the topography. The dimensions of this grid pattern are suitable for this type of deposit.



Although a different numbering scheme was used at the start of the project, all these holes have since been renumbered sequentially from 1 upwards. A prefix of "A" is used to denote an auger hole. This is followed by a second letter to indicate the river system in which the borehole is located, i.e. A – Akongo, M – Mbisa. A typical borehole name would therefore be AA153.

Surveys of collar positions were done using a GPS by the geologist.

The drilling in Phase I was carried out using a mobile hydraulic auger drill rented from the Department of Mining of the CAR. This auger was returned to the department in December 2006 and as a result no details with respect to the manufacturer were available. The auger bit diameter was 75mm. The rig typically drilled 10m - 15m per day. The slow penetration rates were a result of the rig being underpowered in the muddy conditions. The rig initially had sufficient rods to drill to a depth of 10m. Additional rods were later obtained enabling it to drill to a maximum of 20m.

The process of augering results in the extraction of soft muddy sediments from between the auger rod spirals at selected intervals with increasing depth. Unlike core, for which depths and recoveries are measured to the nearest centimetre, the augering depths are only measured to the nearest metre. No recoveries are estimated.

A spade-full of extracted sediments was laid out on a nearby cleared surface of ground at 1m intervals (Figure 12). These small sediment piles were lithologically logged by the geologist on notepaper. The geologist also recorded the borehole number, coordinates and elevation. Since then all these boreholes have been transcribed into the standard borehole format.

Although the gravels are measured at 1m intervals, the reliability in the gravel depth measurement is relatively good as the supervisor can hear when the auger intercepts gravel and the associated depth is measured.

During the extraction of the drilled material cross contamination between samples was common. Therefore the results, with respect to the exact gravel depth and thickness, may not be accurate. The drilling does, however, confirm the presence or absence of gravel.

#### **5.12.2 Sample Preparation, Analyses and Security**

No samples of the extracted sediments were taken at this time. However, this policy was changed at the beginning of March 2007. It is planned for a geologist to go back to each of the old hole sites and, where still available, sample the sediments. Samples are stored in small sample boxes for record purposes should additional interpretation work be required. The drilling process was supervised by a geologist at all times.

#### **5.12.3 Data Verification**

At the time of drilling, no database of borehole information was kept. In January 2007 an Excel database of summary drilling information was created to house all the borehole data. All the old auger drilling has been included into the database. Data entry was done by the expatriate geologist using the original logging sheets and, where possible, in consultation with the geologist who logged the holes.

Independent verification of the data entry process was done using a random sample of boreholes. Two of the eight boreholes checked had errors in the gravel and overburden thicknesses recorded in the database.

#### **5.12.4 Results**

The results of the drilling are indicated on contour plans of gravel and overburden thickness. Contouring was carried out using the computer modelling software package, Surfer®. A detailed description of the modelling process is included in Section 5.17.2. The modelling was carried out for each river i.e Mbisa, Ngouboro and Akongo. Only areas where tributary gravel or yellow basal palaeo-Kotto River gravels were present were included in the model.

**LOCATION OF AUGER DRILLING FOR DIMBI PROJECT**

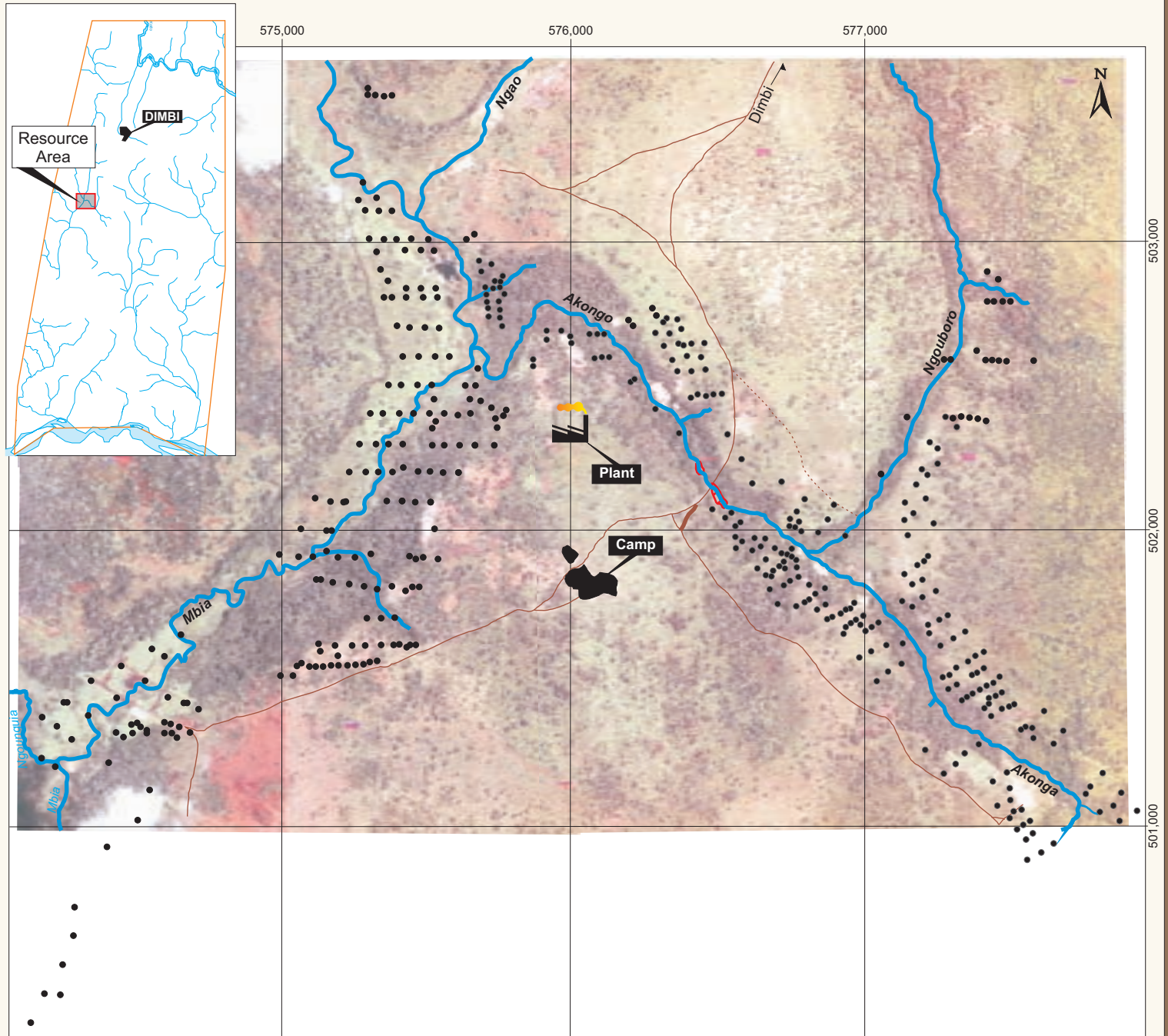

Source: Pangea

This diagram and the information therein are copyrighted. It may not be reproduced or transmitted in any form or by any means without prior written permission from Venmyn Rand (Pty) Ltd. Trading as Venmyn.

**LEGEND:**

- River
- Borehole
- Camp

**SCALE:**



The contour plots have been divided into the Mbia River and a combination of the Ngouboro and Akongo in Figure 13 and Figure 14, respectively. The summary statistics are tabulated in Table 16.

**Table 16 : Summary Statistics for Modelling**

RIVER	BLOCK	NO. DATA POINTS	GRAVEL THICKNESS (m)			OVERBURDEN THICKNESS (m)		
			MIN	MAX	MEAN	MIN	MAX	MEAN
Mbia	West	69	0.00	2.55	1.51	3.97	9.08	5.89
	East	132	0.04	3.89	1.07	2.32	18.62	6.98
	Southwest	14	0.50	1.99	1.03	2.90	8.89	5.10
	South	93	0.00	1.97	0.44	1.04	9.72	4.99
	<b>TOTAL</b>	<b>308</b>						
Akongo	N/A	130	0.14	4.14	0.98	1.23	16.12	6.52
Ngouboro	N/A	80	0.00	4.81	0.98	2.57	12.91	6.37
<b>GRAND TOTAL</b>		<b>518</b>						

The Mbia River gravels are between 0.5 and 1.5m thick over the majority of the extent of the river under investigation. There is, however, a 1km stretch of the river in the north with gravels ranging from an average thickness of 1.5m to 2.0m.

The Ngouboro River contour plots indicate a 200m long area of thick gravel development in the central portion of the river. Thin (<0.5m) gravels are present in the upper reaches of the river. The overburden thickness is highly variable but the majority of the length of the river is covered by at least 6.0m of overburden.

The Akongo River gravels are evenly distributed with a mean gravel thickness of almost 1.00m over the entire length of the modelled river. The overburden thickness is high, over 6.0m.

### 5.13 Phase II – River System Drilling

Phase II exploration commenced upon the receipt of the heavy machinery delivered to site from South Africa in early 2007. The equipment included earthmoving machinery, an auger drill and a pan and final recovery plant.

The purpose of the drilling remained to identify the thickness and extent of the gravels in the river systems and the associated thicknesses of the overburden. As of the end of December 2007, a total of 587 holes had been drilled using the new auger (Figure 6).

#### 5.13.1 Sampling Method and Approach

The drilling programme specified in Phase I was continued i.e. with holes spaced at 50m intervals along drill lines at right angles to the rivers and separated by a distance of 100m. These holes were drilled from as close to the river as possible, along the drill line, to the point at which no gravel was present.

In areas where thick gravels were identified, confirmatory drilling took place on a 50m by 50m spacing. In many cases confirmatory drilling was undertaken to firm up on the limit of the gravels by additional drilling between the last two holes in a drill line.

The numbering is a continuation of the system used in Phase I and described in Section 5.12.1.

The auger holes' x, y and z coordinates were surveyed using a GPS as in Phase I and described in Section 5.10.1. Although the elevations are recorded for each hole they are not reliable measurements as the variations are in the same order of magnitude as the total depth of the holes. The most advanced GPS available on site was tested for elevation accuracy. The test was carried out at five minute intervals for one hour over a number of days at a selected point. The results indicated that accuracy was only to 6m.

**CONTOUR PLAN OF RIVER SYSTEM GRAVEL AND OVERBURDEN THICKNESSES FOR THE MBIA RIVER**

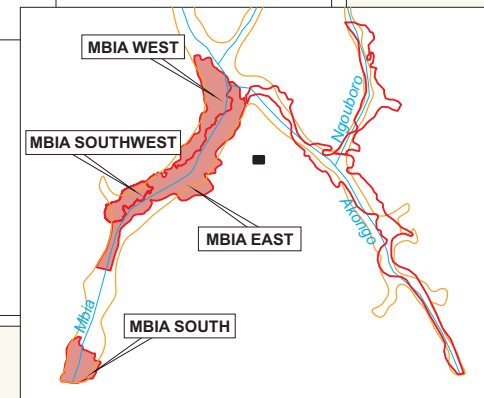
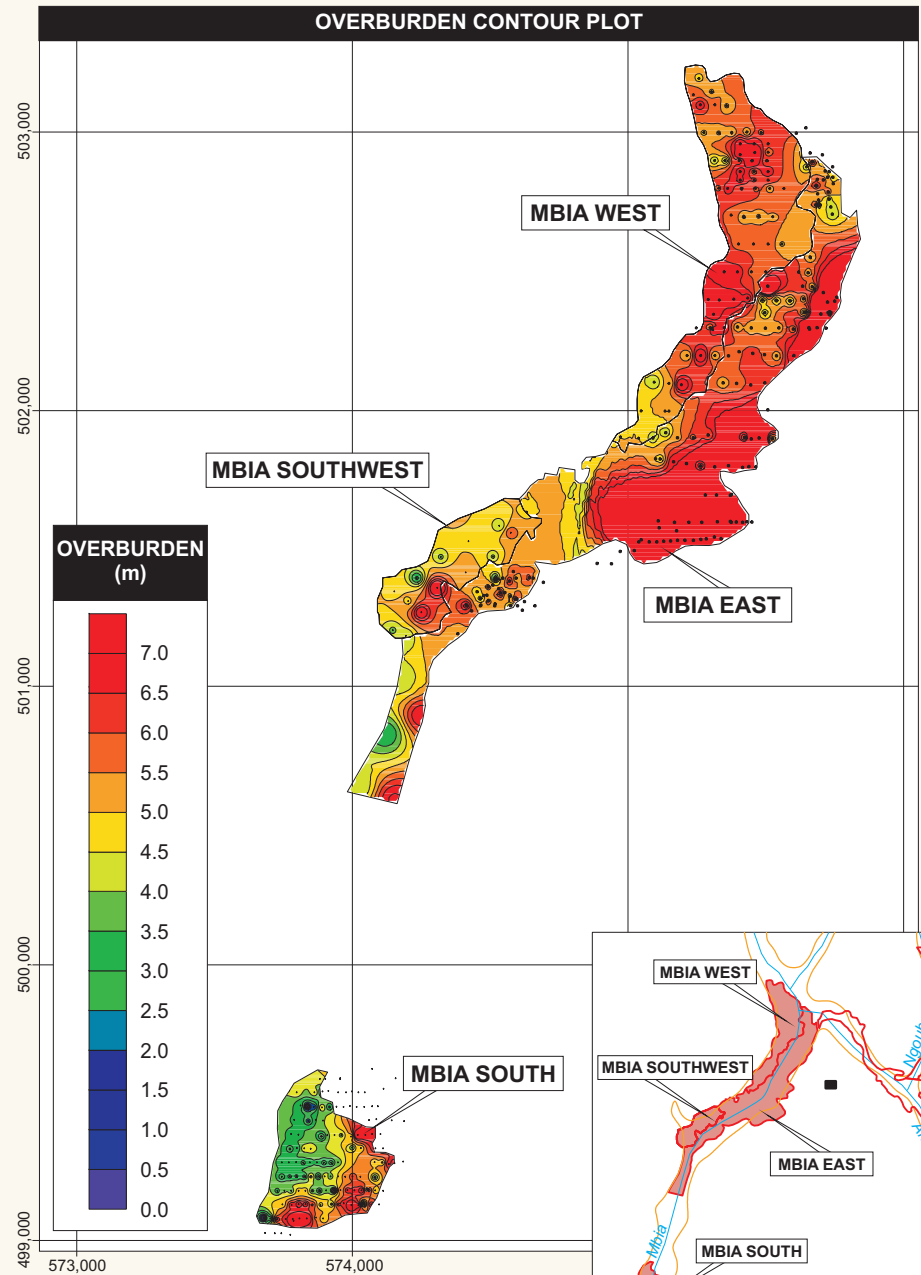
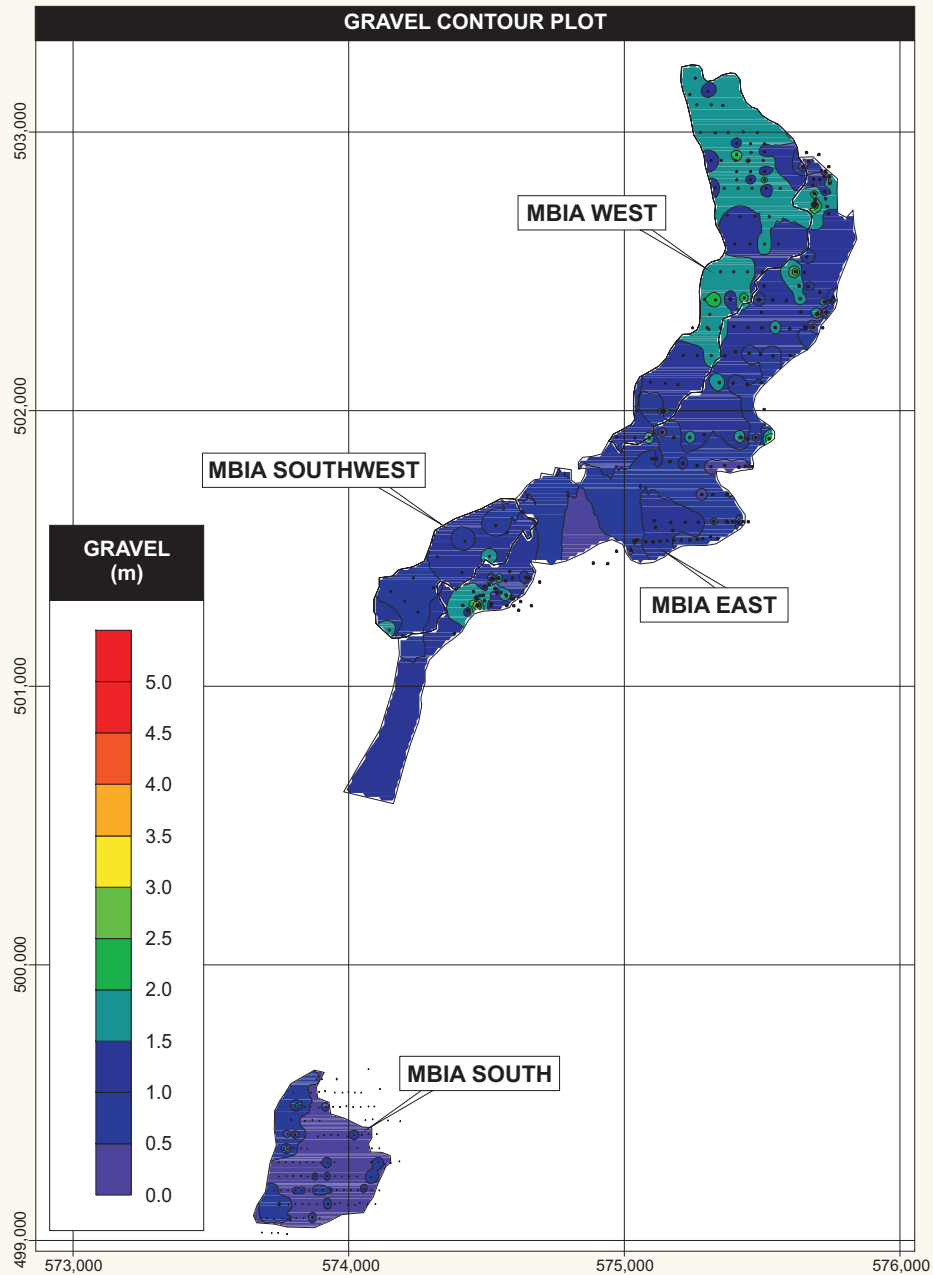

This diagram and the information therein are copyrighted. It may not be reproduced or transmitted in any form or by any means without prior written permission from Venmyn Rand (Pty) Ltd. Trading as Venmyn.



Source: Pangea  
PangeaDFieldsTSX07Fig13.cdr

**CONTOUR PLAN OF RIVER SYSTEM GRAVEL AND OVERBURDEN THICKNESSES FOR THE NGOUBORO AND AKONGO RIVERS**

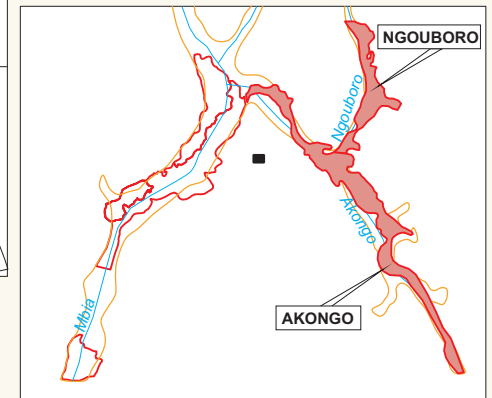
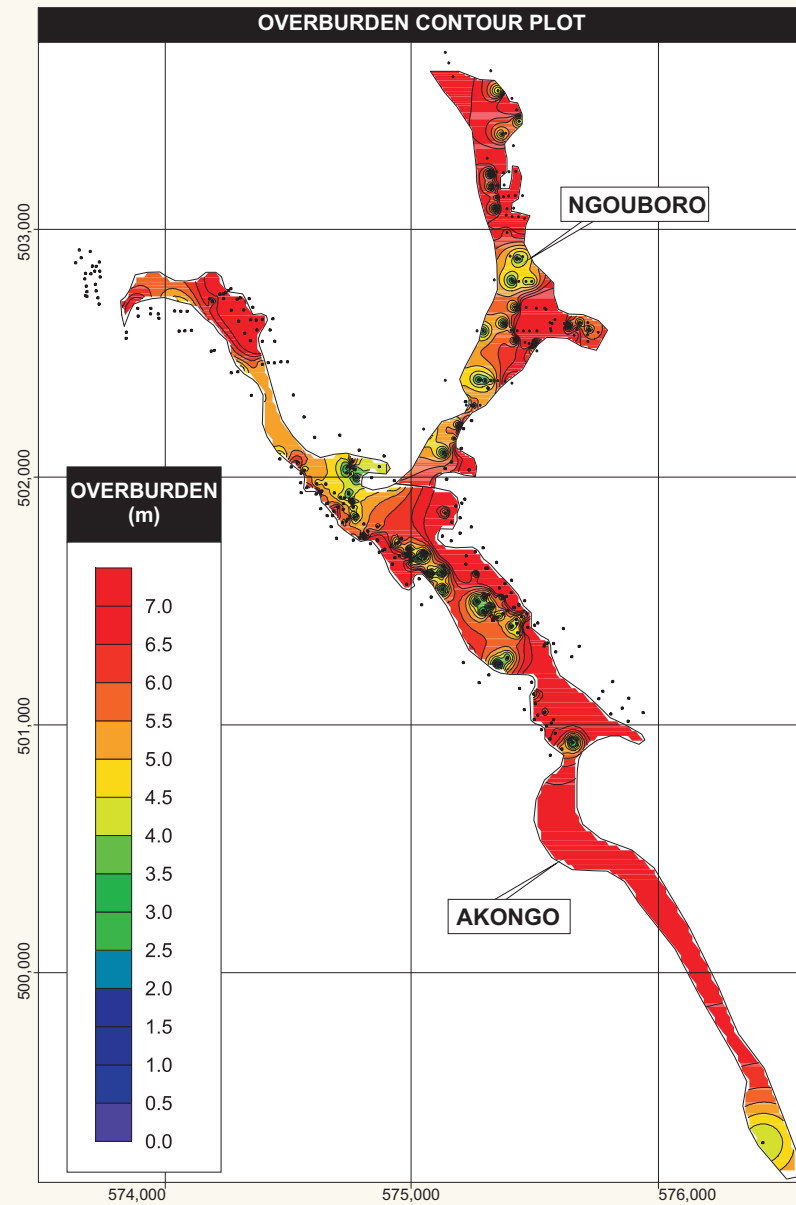
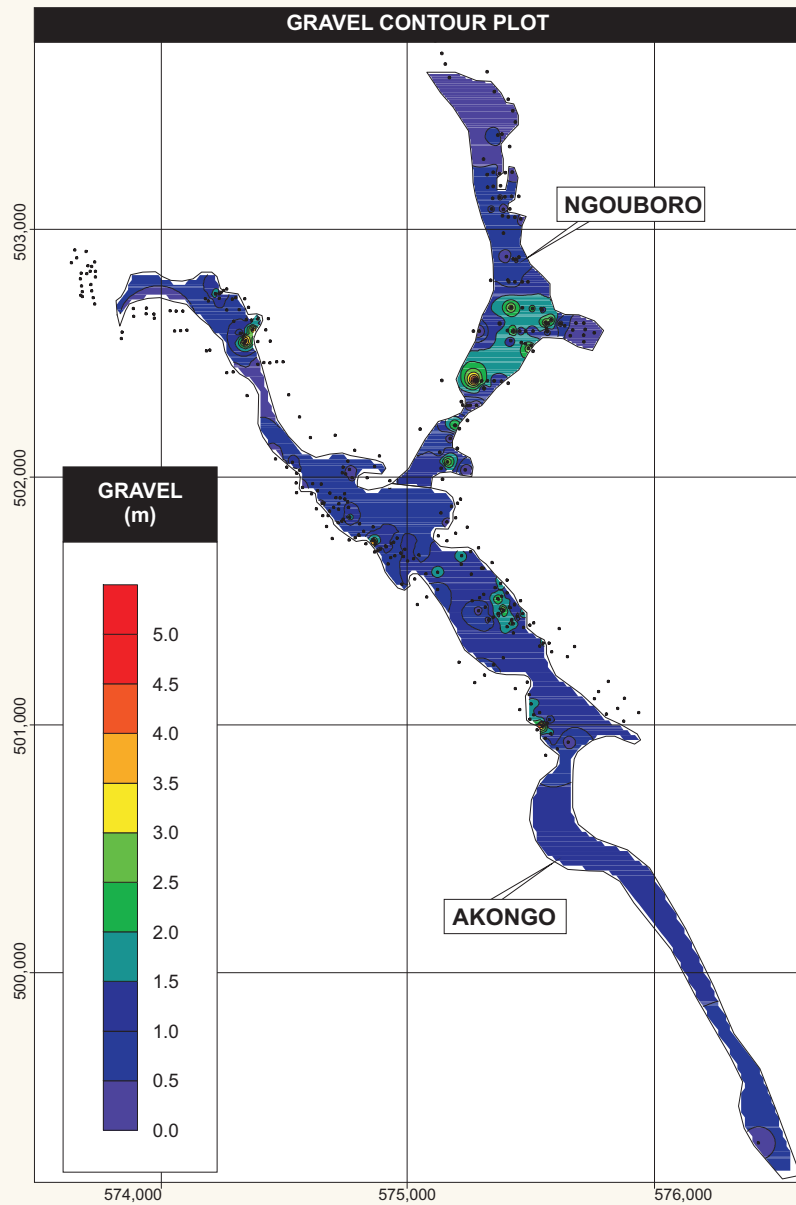

FIGURE 14

The Phase II holes were drilled using a tractor mounted auger specifically manufactured for PDF by 1 Stop (Figure 6 and Figure 12). The drill is mounted on a Massey-Ferguson tractor. It has a bit diameter of 125mm and is capable of drilling a maximum of 50m per day. Before March 2007 it had sufficient rods to drill a maximum depth of 19m. Additional rods have been purchased such that the auger can now drill to a greater depth.

The drilling process is supervised at all times by a geologist and, since March 2007, also by a representative geologist from the CAR government.

Logging is based upon the material extracted from between the auger blades at 1m depth intervals. The spade-full of material is laid out onto a cleared area at 1m intervals (Figure 12). The rods are washed before the next sample is taken. Although some contamination between samples may occur, the reliability in the gravel depth measurement is relatively good as the supervisor can hear when the auger intercepts gravel and the associated depth is measured.

The logging is undertaken by the geologist on rough paper. The geologist also measures the depth of the water table.

#### **5.13.2 Sample Preparation, Analyses and Security**

A 5cm<sup>3</sup> sample from each metre interval is placed within a plastic sample box. A box representing each borehole is kept at the site office for future reference.

#### **5.13.3 Data Verification**

Upon his return from the field, the geologist transcribes his rough log onto the standard computer log. Thereafter, the expatriate geologist checks this log with the related sample box and the logs of the adjacent boreholes to ensure that no errors have occurred with either the drilling or logging. Should any inconsistencies be identified the hole is re-drilled. All original and computer generated logs are filed.

The correct data is also included into the summary borehole database and each borehole is plotted onto the plan of the area. Venmyn independently checked eight of the logs to the database and found them all to be correct.

#### **5.13.4 Results**

The results of the drilling are included into the database of drill information and the results pertaining to the gravel and overburden thicknesses are illustrated in Figure 13 and Figure 14.

### **5.14 Phase II – Bulk Sampling**

Bulk sampling commenced with the arrival of the earthmoving equipment and pan plant in February 2007. A total of 23 large river system trenches is planned in a 5km radius of the plant (Figure 10). By the end of December 2007, a total of five bulk sample trenches had been completed.

#### **5.14.1 Sampling Method and Approach**

The trenches are planned at 500m intervals along the river and will be positioned at right angles to it. These trenches have not been positioned in the areas of maximum gravel development and as a result the samples will be representative of the orebody.

For practical purposes the first phase of trenching was situated close to the plant. Pits situated at the lower elevations will be excavated during the dry season, while those in the upper reaches of the river systems will be completed in the wet season.

The pits are numbered sequentially from 1 with a prefix of BS to indicate that they relate to the bulk sampling phase of exploration. The trench is then divided into a series of sampling blocks which are sequentially numbered using an alphabetical suffix to the trench number, e.g. BS1A, BS1B, etc.

The corners of the surface extent of the trench, as well as the extent of the area for which the gravel is removed, were surveyed using a GPS. PDF has since gone back to the final voids and measured them using a tape measure.

The planned sizes for the trenches were 200m long by up to 95m wide. Each sample block within the trench was to have dimensions of approximately 30m by 25m. BS1, however, was excavated to dimensions of 95m by 30m, with sample blocks of approximately 15m by 15m. BS3 was excavated to a size of 120m by 60m in order to obtain greater confidence in the grade results and diamond characteristics.

The overburden and sample removal is undertaken using an excavator (Figure 6) with a 3t (2.4m<sup>3</sup>) bucket size. The overburden is placed adjacent to the trench for later rehabilitation.

Due to the high level of the water table, a specific method of excavation has been designed by PDF for these trenches. Two slots are excavated along the length of the planned pit on the outer limits. These slots act as a dewatering mechanism, allowing the remainder of the trench to be excavated safely.

The pit walls are mapped by the site geologist.

#### **5.14.2 Sample Preparation, Analyses and Security**

The gravel sample is removed by the excavator and placed in a 25t (15m<sup>3</sup>) articulated dump truck (ADT) for transport to the run of mine (ROM) stockpile. Where possible the upper and lower gravel horizons are removed and sampled separately. In most cases, however, the gravels are removed together and the sample is described as "Mixed". Each truck load is noted by the geologist supervising the excavation.

The samples are delivered to the ROM stockpile situated adjacent to the plant and dumped in rows. Each sample is labelled using a stake and signboard (Figure 11). The stockpile area is currently not fenced or secured in any way. PDF advises that the area will be fenced off in the near future.

The plant is fed from the stockpile using a front end loader (FEL) with a 3m<sup>3</sup> bucket capacity. Each load is counted by the FEL driver and recorded on paper. This record is provided to both the plant supervisor and the expatriate geologist.

The method of sample preparation is adequate. The method of processing using a pan plant and final recovery through an automatic grease belt is good and as a result the Qualified Person has a high degree of confidence in the results.

#### **5.14.3 Data Verification**

The dimensions, coordinates and results from each block within each pit are recorded by an expatriate geologist on site. These are sent to head office for final verification (Section 5.8.3). Venmyn verified the initial results on a sample basis.

#### **5.14.4 Results**

The bulk sampling results are summarised in Table 17. All bulk samples were taken in palaeo channel gravel deposits.

Table 17 : Summary of Bulk Sampling Results for Dimbi Project

PIT NO.	BLOCK	O/B THICK (m)	GRAVEL THICK (m)	GRAVEL VOLUME (m <sup>3</sup> )	CARATS	NO. STONES	GRADE (ct/100m <sup>3</sup> )	STONE SIZE (ct/stone)	BOTTOM SCREEN SIZE (mm)
BS1	A	6.00	0.60	138.00	5.40	20	3.91	0.27	1.6
	B	5.50	0.80	198.40	13.04	31	6.57	0.42	1.6
	C	7.00	0.80	186.40	16.82	45	9.02	0.37	1.6
	D	8.00	1.00	240.00	17.63	64	7.35	0.28	1.6
	E	9.00	1.30	188.50	9.89	41	5.25	0.24	1.6
	<b>TOTAL / AVE</b>			<b>951.30</b>	<b>62.78</b>	<b>201</b>	<b>6.60</b>	<b>0.31</b>	
BS2	A	5.45	1.32	1,359.60	22.12	105	1.63	0.21	1.6
	B1	5.45	1.22	732.00	8.42	49	1.15	0.17	1.6
	B2	5.45	1.03	173.04	8.83	41	5.10	0.22	1.6
		<b>TOTAL / AVE</b>			<b>2,264.64</b>	<b>39.37</b>	<b>195</b>	<b>1.74</b>	<b>0.20</b>
BS3	A	4.20	0.51	378.68	80.42	285	21.24	0.28	1.6
	B	5.20	0.89	790.60	120.49	460	15.24	0.26	1.6
	C	5.70	0.78	737.10	397.94	1,458	53.99	0.27	1.6
	D	5.70	0.64	576.00	510.88	1,701	88.69	0.30	1.6
	E	7.20	0.70	567.00	464.51	1,511	81.92	0.31	1.6
	F	9.50	0.58	382.80	214.76	678	56.10	0.32	1.6
	E1	6.00	1.08	1,584.36	505.65	1,711	31.92	0.30	1.6
	D1	6.00	1.07	1,305.40	487.98	1,637	37.38	0.30	1.6
	C1	5.90	0.94	1,146.80	511.46	1,934	44.60	0.26	1.6
	<b>TOTAL / AVE</b>			<b>7,468.74</b>	<b>3,294.09</b>	<b>11,375</b>	<b>44.11</b>	<b>0.29</b>	
BS4	A1	8.25	0.50	214.50	71.03	324	33.11	0.22	1.6
	B1	7.90	0.50	227.50	56.20	255	24.70	0.22	1.6
	C1	7.55	0.50	255.00	41.06	194	16.10	0.21	1.6
	D1	7.40	0.30	123.30	27.71	141	22.47	0.20	1.6
	A2	8.10	1.10	386.10	92.06	381	23.84	0.24	1.6
	B2	10.20	0.80	315.20	63.90	313	20.27	0.20	1.6
	C2	8.70	0.55	329.45	42.55	180	12.92	0.24	1.6
	D2	8.40	0.70	147.00	8.47	41	5.76	0.21	1.6
	<b>TOTAL / AVE</b>			<b>1,998.05</b>	<b>402.98</b>	<b>1,829</b>	<b>20.17</b>	<b>0.22</b>	
BS5	A1	2.50	0.70	203.00	21.04	56	10.36	0.38	1.6
	A2	4.55	1.10	254.10	112.88	316	44.42	0.36	1.6
		<b>TOTAL / AVE</b>			<b>457.10</b>	<b>133.92</b>	<b>372</b>	<b>29.30</b>	<b>0.36</b>
<b>GRAND TOTAL / AVE</b>				<b>13,139.83</b>	<b>3,933.14</b>	<b>13,972</b>	<b>29.93</b>	<b>0.28</b>	

A total of 3,933.14cts was recovered from the bulk sampling (BS1-BS5) by December 2007. The average stone size was 0.28ct/stone, with the largest stone being 8.19ct in size.

A number of technical problems were encountered during the excavation of the first two bulk sampling pits. These issues are summarised in Table 18.

Table 18 : Technical Issues Associated with BS1 and BS2

PIT NO.	TECHNICAL ISSUE/S	EFFECT ON THE RESULTS
BS1	Position of the pit too high up the slope away from the river resulted in a poor development of the basal gravel. It was only intersected in the lowermost block.	Grade results not representative of the basal gravel and therefore should not be included in the resource estimation.
	Plant commissioning phase may have resulted in diamond losses.	Lower diamond recoveries may have resulted in an under estimation of the grade.
BS2	Very wet conditions resulted in difficult mining conditions.	Slow rate of mining, but no effect on results.
	Basal gravel poorly developed. Identified high grades only where yellow gravel was present.	Not representative of the yellow basal gravel and therefore should not be included in the resource estimation.

#### 5.14.4.1 Diamonds Characteristics and Valuation

A total of 4,020cts had been recovered from the various gravels types at Dimbi by December 2007. The diamonds are characteristically small (0.3ct/stone) with a large proportion exhibiting good colour and quality. The distribution of the diamond production is illustrated graphically in Figure 15.



**Figure 15 : Dimbi Project Number of Carats by Sieve Size**

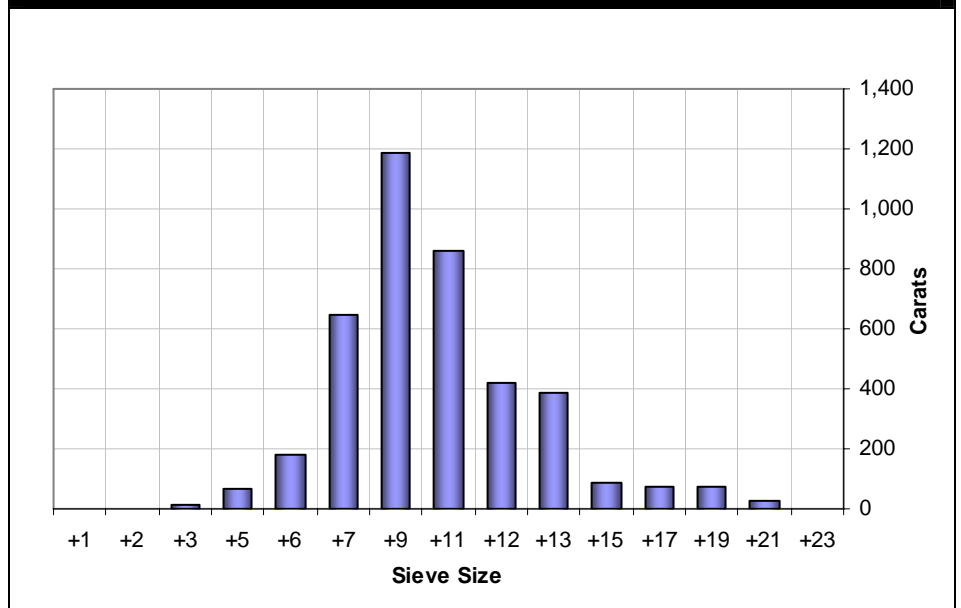

Note. Refer to Appendix 1 for comparisons of sieve size to carats.

The figure indicates the majority of the population report to the +9 and +11 sieve size (0.21ct – 0.37ct). A total of 94% of the diamonds are less than 1ct in size and the remaining 6% are between 1ct and 5cts. Until December 1007, no diamonds greater than 5cts in size had been recovered.

A single size frequency distribution (SFD) has been plotted for all the diamonds recovered from the various gravels in Figure 16. The graph indicates a typical sigmoidal distribution for diamond deposits, indicating that Dimbi is characterised by a very low percentage of very small goods and similarly for the large goods.

**Figure 16 : Dimbi Project Cumulative Size Frequency Distribution**

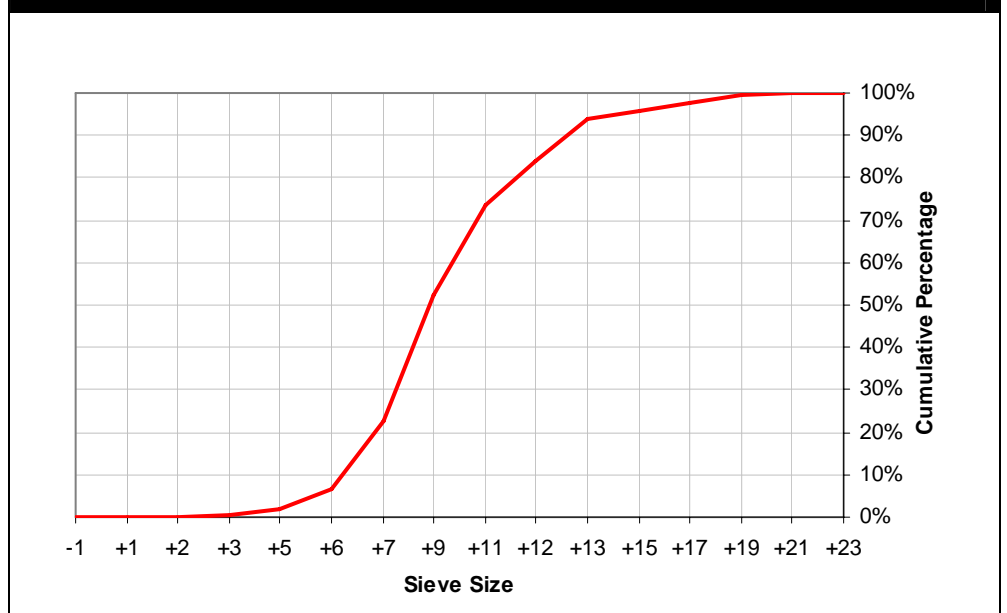

Note. Refer to Appendix 1 for comparisons of sieve size to carats.

**5.15 Adjacent Properties**

There is no information on adjacent properties as they have not been explored.

## 5.16 Mineral Processing and Metallurgical Testing

The bulk samples were taken at systematic intervals along the palaeo channel deposit and as a result can be classified as representative of the deposit.

### 5.16.1 Pan Plant

The pan plant is situated adjacent to the current openpit pilot mining operations (Figure 6 and Figure 10). The Phase II bulk samples were treated through these two 14 foot (ft) pans with final recovery using a GB400 automatic grease belt.

The pan plant was constructed by 1 Stop and arrived on site in early 2007. The plant was commissioned shortly thereafter.

The simplified plant flowsheet is shown in Figure 17. The plant's front end is designed to treat between 80-100tph of feed from the stockpile. The feed passes through a 200mm primary screen and then into the scrubber. The -1.6mm fines and sand content is removed and pumped to the slimes dam. The +32mm coarse and +25-32mm middlings fractions are also removed at this point. The remaining +1.6-25mm fraction passes into one of the two 14ft pans.

The pan plant typically treats between 30tph and 50tph at a rotational speed of approximately 6 revolutions per minute (rpm). The puddles for the pans were initially made up from the -1.6mm clay fraction from the scrubber. Thereafter the puddle is recirculated. The density of the puddle is measured using an electronic density scale.

The pans are continuously tapped using an auger. The concentrate passes into a 3t container called a "sputnik". The sputnik is transported by FEL to the front of the recovery plant. The sputniks are locked and only tapped by the plant manager who is in custody of the keys.

The efficiency of the pan plant was tested on a daily basis using tracers of various sizes with the same density as diamonds. The data is to be entered onto an Excel sheet along with the production volumes.

### 5.16.2 Final Recovery Plant

Approximately 1% of plant head feed is collected in the sputniks and reports to the recovery plant. The recovery plant consists of a scrubber, classifier, GB400 automatic grease drum and glove boxes for final sorting. Photographs of the recovery plant are shown in Figure 18 along with a simplified flowsheet.

The sputnik is delivered to the front of the recovery plant where it is opened and the concentrate scrubbed. It is then conveyed via a secure tube conveyor to the recovery plant container where it is sized as follows:-

- +1.6mm – 6.0mm;
- +6.0mm – 12.0mm;
- +12.0mm – 20.0mm; and
- +20.0mm – 25.0mm.

The first three size fractions are sorted using the GB400, whilst the largest size is hand sorted. Ore is fed onto the grease drum using a vibratory feeder with the aid of water jets. The grease rotates counter to the flow of material. The diamonds, due to their hydrophobic and oleophilic properties, adhere to the grease whilst the remaining material passes out of the machine through a tailings chute.

The grease and diamonds are scraped off the drum and fed into a tank of near boiling water. The grease melts and floats on the water whilst the diamonds pass through the hot water into a container. This container is often called the small sputnik. The diamonds are cleaned ready for final sorting.

**SCHEMATIC FLOWSHEET FOR DIMBI PROJECT PAN PLANT**

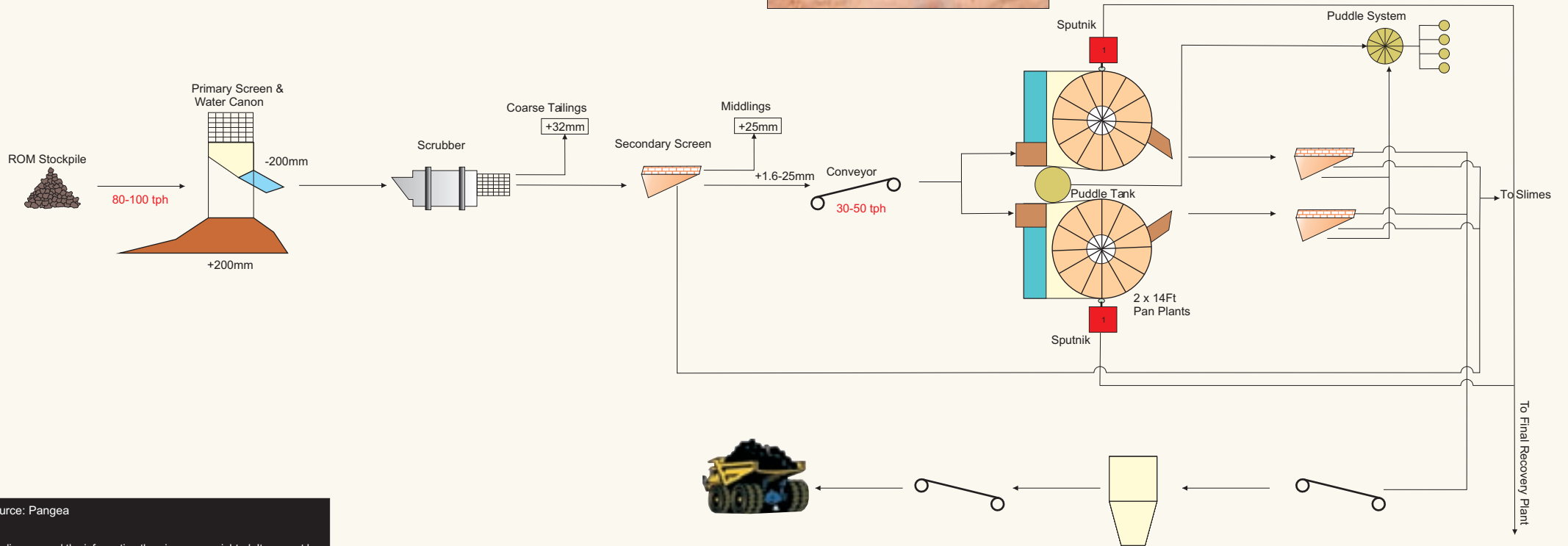

Source: Pangea

This diagram and the information therein are copyrighted. It may not be reproduced or transmitted in any form or by any means without prior written permission from Venmyn Rand (Pty) Ltd. Trading as Venmyn.

PangeaDiamondFieldsTSX'07Fig17.cdr

**SCHEMATIC FLOWSHEET FOR DIMBI PROJECT FINAL RECOVERY PLANT**

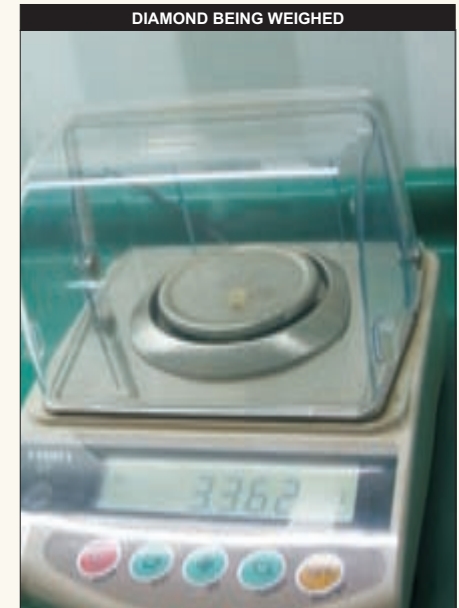
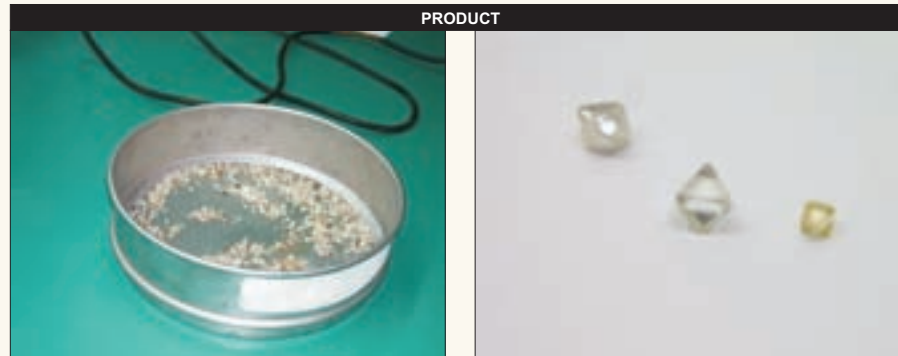
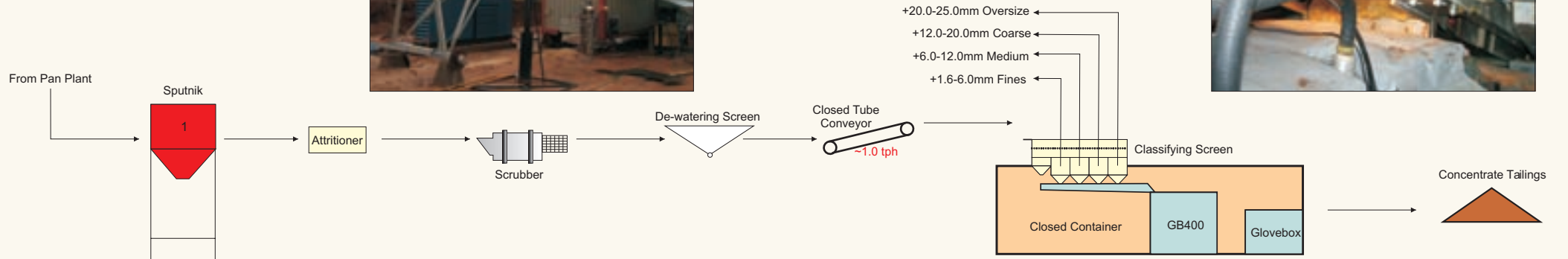

Final sorting takes place by two representatives of PDF within a double glove box. The recovered diamonds are weighed and sealed in uniquely numbered plastic bags and placed in the drop safe. This is done on a daily basis after sorting and is referenced to the bulk sample number. The diamonds are also recorded in an Excel sheet by the expatriate geologist.

The recovery efficiency of the GB400 is tested on a daily basis using hydrophobic tracers. And the daily results recorded on an Excel sheet.

The diamonds are later acid boiled, sorted according to sieve sizes and reweighed. They are then returned to the safe.

### 5.16.3 Security

The current security level in and around the pan plant is relatively low. The existing security facilities consist of the following:-

- pan feed conveyor is closed;
- final recovery feed conveyor is closed;
- three cameras around the plant area. These cameras record digital images to disk; and
- locking the sputniks using two padlocks.

The security features associated with the final recovery are satisfactory and include the following:-

- the GB400 is housed within a secure container;
- four cameras in the final recovery plant area, sorthouse, GB400, and glove box (Figure 18). As with the other cameras, the feed is stored to disk;
- the sorthouse is locked during sorting;
- sorting is carried out by two representatives from PDF in the presence of a government representative;
- the diamonds are sealed in uniquely numbered bags;
- diamonds are kept in the drop safe;
- two keys are required to open the safe; and
- the small sputnik is locked using two padlocks.

## 5.17 Diamond Resource and Diamond Reserve Estimates

### 5.17.1 Previous Resource Statements

No previous resource statements have been issued for the Dimbi Project.

### 5.17.2 Volume

The volume of the resources was estimated using the auger database of gravel thickness. This parameter was modelled using Surfer® using the inverse distances squared method of estimation. Only those data points having gravel (i.e. tributary or Palaeo-Kotto yellow basal) were included and these points set the areal limits of the modelling. All datapoints within this limit were included in the estimation process. The volume pertaining to each of the gravel types was modelled and estimated separately. The resultant volumes are tabulated in Table 19. Volumes were only calculated in those areas for which reliable grade data was available.

**Table 19 : Volume Estimation for Dimbi Project**

MINE / PROJECT	BLOCK	GRAVEL TYPE	GRAVEL VOLUME (m <sup>3</sup> )
Dimbi	Mbia East	Palaeo-Kotto Yellow Basal	712,575
	Ngouboro	Tributary	318,406
	Akongo		744,556
	<b>TOTAL</b>		

The Mbia East volume calculation was also independently modelled, and therefore verified, by Dr Carina Lemmer, an associate geostatistician of Venmyn's. The volume was less than 10% different to that calculated by PDF and the difference is therefore not material.

### 5.17.3 Density

No density measurements were required as all resources are quoted in volumes.

### 5.17.4 Grade

The grade has been calculated per gravel type as a weighted average of all the pits (mega or bulk sampling) which lie within the resource area defined in the volume calculation above. The grades are summarised in Table 20. The grades results for pit BS1 and BS2 were excluded for the reasons cited in Section 5.14.4.

**Table 20 : Grade Calculation for Dimbi Project**

MINE / PROJECT	BLOCK	GRAVEL TYPE	PITS INCLUDED IN GRADE CALC	WTD AVE REC. GRADE (ct/100m <sup>3</sup> )	CARATS
Dimbi	Mbia East	Palaeo-Kotto Yellow Basal	BS3, BS4, BS5, P2, P5, P15	38.35	273,273
	Ngouboro	Tributary	P16	19.31	61,484
	Akongo		G2, P3, Paulin, P4	60.19	448,148
	<b>TOTAL / AVE</b>				<b>44.09</b>

The mean grade for Mbia East was also calculated by Dr Lemmer and found to be 38.33ct/100m<sup>3</sup>, as compared to 38.35ct/100m<sup>3</sup> estimated by PDF (Table 20).

### 5.17.5 Diamond Value

An independent valuation of 3,013cts was carried out by Erikson D.C.W. (Pty) Ltd in (October) 2007. The results are tabulated in Table 21. In November 2007, a total of 3,671.90cts was exported to Antwerp for sale into the current market by WWW International Diamonds Consultants (WWW). The results of the sale are also included in Table 21.

**Table 21 : Results of Diamond Sale for the Dimbi Project**

DATE	VALUATOR	TOTAL VALUE (US\$)	CARATS	AVE VALUE (US\$/ct)
October 2007	Erikson D.C.W. (Pty) Ltd	434,438	3,012.82	<b>144.20</b>
February 2008	WWW International	611,159	3,671.90	<b>166.44</b>

The value of US\$166/ct, obtained for the sale into the current market, will be used in the resources statement for all gravel types.

### 5.17.6 Current Resource Statement

The Diamond Resource statement for the Dimbi Project, dated 1<sup>st</sup> March 2008, was prepared by Ms Helen Pein. This was independently verified by Ms Catherine Telfer of Venmyn and Dr Carina Lemmer, an associate to Venmyn. The statement is shown in Table 22.

**Table 22 : Diamond Resource Statement for the Dimbi Project (1<sup>st</sup> March 2008)**

MINE / PROJECT	PROJECT AREA	RESOURCE CLASSIFICATION	GRAVEL VOLUME (m <sup>3</sup> )	GRADE (ct/100m <sup>3</sup> )	CARATS	DIAMOND VALUE (US\$/ct)	BOTTOM SCREEN SIZE (mm)
Dimbi	N/A	Inferred	1,063,000	47.94	509,632	166	1.6

MINE / PROJECT	PROJECT AREA	RESOURCE CLASSIFICATION	GRAVEL VOLUME (m <sup>3</sup> )	GRADE (ct/100m <sup>3</sup> )	CARATS	DIAMOND VALUE (US\$/ct)	BOTTOM SCREEN SIZE (mm)
Dimbi	N/A	Indicated	712,575	38.35	273,273	166	1.6

The diamond resources associated with Mbia East were classified as Indicated due to the large number of auger holes and extent of mega pitting and bulk sampling. In addition, the percentage that the true mean of the volume and grade may be above or below the sampled mean, at the 95% confidence limit, was estimated to be between 10% and 20%. It is for this reason that Mbia East block has been classified as Indicated.

All resources were classified as Inferred due to the relatively low confidence associated with the grades. The logic used in the classification is tabulated in Appendix 2. The location of the Diamond Resources, in relation to the project area, is illustrated in Figure 19. Note that these resources cover a very small area in relation to the concession boundary. The potential for the remaining Mbia River and its tributaries to the east is equal to that identified in the current area of interest.

There is no known item relating to the environment, permits, legal, title, taxation, socio-economic, marketing, and political or any other issue that would have a material effect on the resources identified in the current Diamond Resource statement.

#### 5.18 Other Relevant Data and Information

A Preliminary Assessment, including an economic analysis, of the Dimbi Project has been carried out by PDF. It was based upon Inferred Resources and, to a lesser extent, Indicated Resources and is preliminary in nature. Inferred Resources are considered too speculative to have mining and economic considerations applied to them in order to be converted to Mineral Reserves. There is no certainty that the production and economic forecasts contained in the Preliminary Assessment will be realised.

The results of the preliminary assessment are summarised in Table 23. Venmyn has independently verified the input parameters for the preliminary assessment. We have found them to be fair and reasonable in light of the Dimbi Resources Statement (Table 22), PDF's operating experience and Venmyn's knowledge base of similar operations. The assessment is based upon the parameters applicable at the first stage of commercial mining.

**Table 23 : Preliminary Assessment at First Stage of Commercial Mining for Dimbi Project**

ITEM	UNITS	AMOUNT	DEFINITIONS & NOTES	ASSUMPTIONS
Capital	USD' M	11.50	Includes capital for Bulk Sampling and Pilot Mining phases (USD5.5M) already spent.	Includes a 40% of value charge for freight on all capital equipment.
Plant headfeed	m <sup>3</sup> /mth	40,000	Run of mine gravel fed to plant front-end at steady state operations.	Plant (3x scrubber @ 150m <sup>3</sup> /hr; 4x 14foot pans @ 60m <sup>3</sup> /hr; 1x reconcentrate DMS @ 10m <sup>3</sup> /hr; 1x Flowsort @ 0.5m <sup>3</sup> /hr), 3 shifts per day, 50% mining efficiency and 90% plant efficiency.
Grade	ct/100m <sup>3</sup>	35	Less than resource grade to take into account of the confidence associated with the resource classification and to mitigate any grade risk.	

ITEM	UNITS	AMOUNT	DEFINITIONS & NOTES	ASSUMPTIONS
Carats produced	cts/mth	14,000	Calculated from plant headfeed and grade.	
Operating costs	USD/m <sup>3</sup>	22	PDF has a good handle of costs from operating the project as a bulk sampling operation since early 2007. Costs expected to decrease due to economies of scale to be obtained with commercial production rates.	Based upon 24 days per month, 3 shifts and 40,000tpm.
Revenue per carat	USD/ct	160	Slightly lower the price obtained to mitigate price risk.	Based upon sale of over 3,000cts in today's market.
Cash contribution	USD/m <sup>3</sup>	34	Calculated from grade, revenue and operating costs.	Pre-tax and depreciation and on project basis ie 100%
Cash contribution	USD' M pa	16.32	Calculated from plant headfeed and cash contribution by cubic metre.	
Inferred + Indicated Resources	m <sup>3</sup>	1,700,000	Inferred Resources of 1.0m <sup>3</sup> and Indicated Resources of 0.7m <sup>3</sup> have been identified, but these cover only a small portion of the license area.	
Projected life	Years	3.54	Calculated from potential resources and plant headfeed.	
Payback period	Years	0.70	Calculated from capital and cash contribution.	
Potential start		End 2008		

### 5.19 Interpretation and Conclusions

Three gravel types have been identified which form the focus of PDF's exploration in the area. These are namely; the palaeo-Kotto River gravels, tributary gravels and blanket/Dimbi Formation gravels. The recent exploration has resulted in a confirmation of the original geological model for the Dimbi Formation with the exception of possible reworking into channels in some isolated areas. The identification of the yellow basal gravel as being the main carrier of the diamonds in the palaeo-Kotto River gravels has been a new and critical discovery to the project.

The extensive and detailed exploration through auger drilling has provided sufficient information on the gravel and overburden thicknesses to allow computerised modelling and a more accurate determination of volumes as compared to previously. The contour plots identify a number of areas where thicker gravels are developed and these should be the focus for future development.

Grade information has been provided for the various gravel types, initially through the exploration pits but more recently from the bulk sampling results. The difficulties experienced in siting the bulk sampling pits to intersect the gravels has resulted in some of the grade information not being useful in the derivation of the resource statement.

Also, the results obtained during the plant's commissioning phase may not be accurate and are likely to represent an under valuation of the grade. As a result, only the grade figures from three bulk sample pits could be used in the resource estimation. PDF's past experiences have enabled them to correct these technical issues and the bulk sampling programme going forward is likely to yield more useful results.

The diamond resources associated with the palaeo channel gravels within the Mbia East block were classified as Indicated, whilst those associated with the tributary gravels of the Ngouboro and Akongo Rivers were classified as Inferred.

Note that the resource statement related to only a small part of the Dimbi concession. The remainder of the Mbia River and its tributaries to the east also offer prospective areas for further resource identification with time.

The sale of 3,671.90cts into today's market has been provided the average value for the Dimbi Project diamonds of US\$166/ct.



**LOCATION OF DIAMOND RESOURCES FOR THE DIMBI PROJECT**

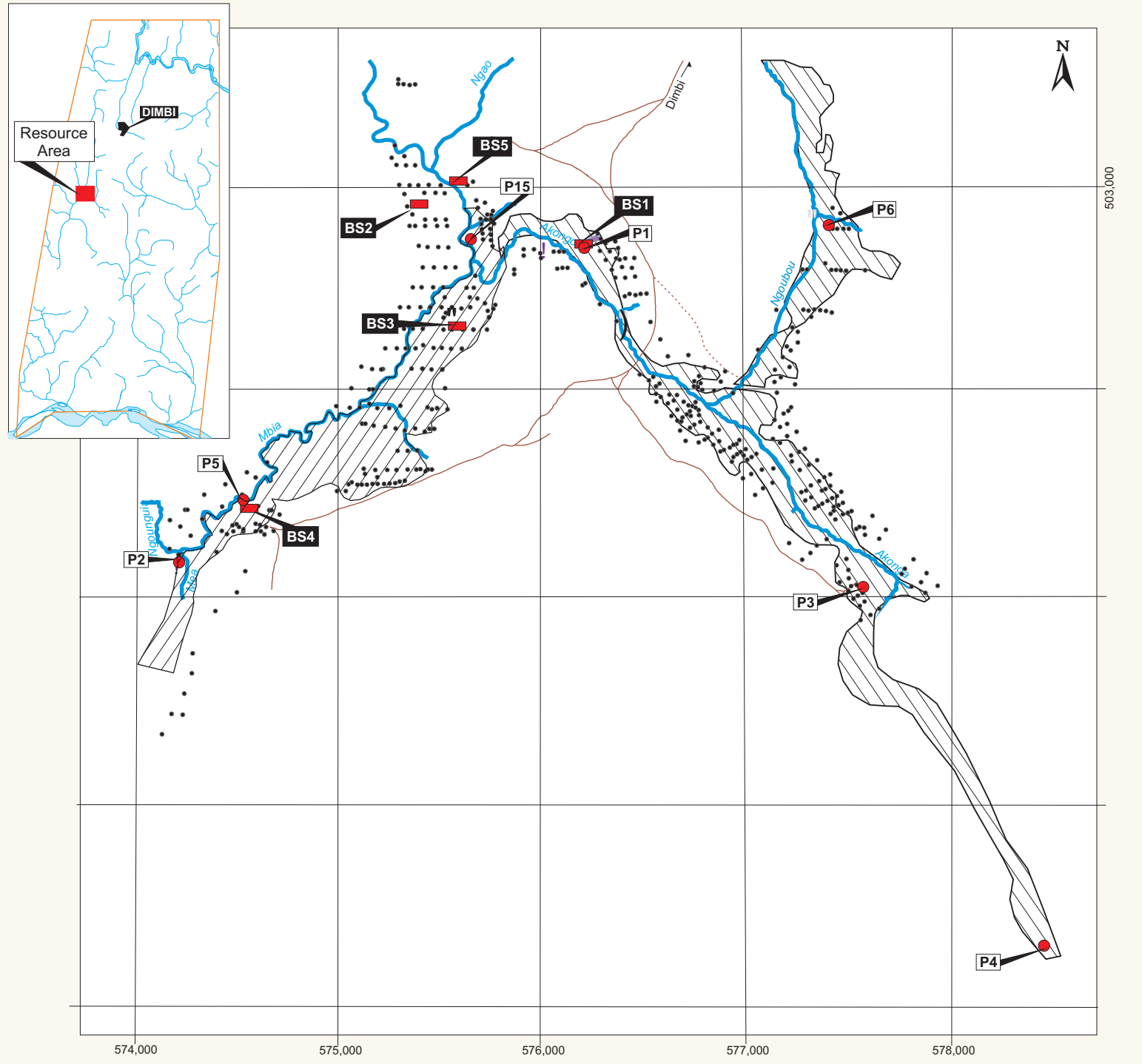

MINE / PROJECT	BLOCK	GRAVEL TYPE	RESOURCE CLASSIFICATION	GRAVEL VOLUME (m <sup>3</sup> )	WTD AVE REC. GRADE (ct/100m <sup>3</sup> )	CARATS
Dimbi	Mbisa East	Palaeo-Kotto Yellow Basal	Indicated	712,575	38.35	273,273
	<b>TOTAL / AVE</b>			<b>712,575</b>	<b>38.35</b>	<b>273,273</b>
	Ngouboro	Tributary	Inferred	318,406	19.31	61,484
	Akongo		Inferred	744,556	60.19	448,148
<b>TOTAL / AVE</b>			<b>1,062,962</b>	<b>47.94</b>	<b>509,632</b>	

Source: Pangea

**LEGEND:**

- River
- Borehole
- River System Pit
- Bulk Sampling Pit
- Camp
- Palaeo Kotto Gravel (Indicated)
- Tributary Gravel (Inferred)

**SCALE:**



This diagram and the information therein are copyrighted. It may not be reproduced or transmitted in any form or by any means without prior written permission from Venmyn Rand (Pty) Ltd. Trading as Venmyn.

The exploration results have been verified and the methods independently checked by Venmyn. We are of the opinion that the results are reliable, where stated, and that the data density, quantity and quality are sufficient for the delineation of Inferred Resources for Dimbi.

## 5.20 Recommendations

The recommended work programme for all CAR projects, including the Dimbi Project, is tabulated in Table 24. Note that each subsequent phase of exploration is only carried out upon the positive results of the previous phase. Venmyn has assisted PDF in the compilation of the work programme and budget in respect of the Dimbi Project and recommends that the company undertake the programme as stated therein. The expected revenues to be derived from the sale of diamonds extracted during exploration pitting, bulk sampling and pilot mining are shown in Table 25.

**Table 24 : Exploration Work Programme and Costing for all CAR Projects**

PROJECT	ITEM	2008				2009			
		Q2 (US\$)	Q3 (US\$)	Q4 (US\$)	Q1 (US\$)	Q2 (US\$)	Q3 (US\$)	Q4 (US\$)	
Dimbi	Exploration Expenditure	(1,522,000)	(1,825,000)	(2,460,000)	(2,500,000)	(2,500,000)	(2,500,000)	(2,500,000)	
	Capital Expenditure	(3,317,286)	(2,660,000)						
	<b>TOTAL</b>	<b>(4,839,286)</b>	<b>(4,485,000)</b>	<b>(2,460,000)</b>	<b>(2,500,000)</b>	<b>(2,500,000)</b>	<b>(2,500,000)</b>	<b>(2,500,000)</b>	
	Activity	Mega pitting to continue; resource delineation; equipment purchase to upgrade plant for Mining Module 1 and commence Pilot Mining.	Mega pitting to continue; resource delineation; equipment purchase to upgrade plant for Mining Module 1 and continue Pilot Mining.	Mega pitting to continue; resource delineation; develop Mining Module 1 plant and equipment and commission.	Mega pitting to continue; resource delineation; Mining Module 1 to scale up to full capacity	Mega pitting to continue; outside Mining Module 1 area ; resource delineation; Mining Module 1 in full production	Mega pitting to continue; outside Mining Module 1 area ; resource delineation; Mining Module 1 in full production	Mega pitting to continue; outside Mining Module 1 area ; resource delineation; Mining Module 1 in full production	
	Phase	Pilot Mining	Pilot Mining	Mining Module 1	Mining Module 1	Mining Module 1	Mining Module 1	Mining Module 1	
Etoile	Exploration Expenditure	(125,700)	(125,700)	(125,700)	(126,000)	(126,000)	(226,000)	(226,000)	
	Capital Expenditure	(143,000)	(18,000)	(18,000)	(18,000)	(4,018,000)	(18,000)	(18,000)	
	<b>TOTAL</b>	<b>(268,700)</b>	<b>(143,700)</b>	<b>(143,700)</b>	<b>(144,000)</b>	<b>(4,144,000)</b>	<b>(244,000)</b>	<b>(244,000)</b>	
	Activity	Mega pitting to continue; and resource delineation	Mega pitting to continue; and resource delineation	Mega pitting to continue; resource delineation; and evaluation limited to proposed bulk sample areas.	Mega pitting to continue; resource delineation; and evaluation limited to proposed bulk sample areas.	Mega pitting to continue; resource delineation; and evaluation limited to proposed bulk sample areas.	Mega pitting to continue; resource delineation; arrival and development and commissioning of bulk sampling equipment	Mega pitting to continue; resource delineation; arrival and development and commissioning of bulk sampling equipment	
	Phase	Exploration	Exploration	Advanced Exploration	Advanced Exploration	Advanced Exploration	Bulk Sampling	Bulk Sampling	

**Notes**

Results of each phase determines whether a project moves into the subsequent phase or if it is terminated.

Only two successive phases are included, as specified by NI43-101F

PDF required to finance all above expenditure, even though their shareholding may be less than 100%.

Exploration and capital expenditure to be funded through capital raising and revenues from diamonds mined and sold from the project.

**Table 25 : Revenue Generation for all CAR Projects**

PROJECT	ITEM	2009						
		Q2 (US\$)	Q3 (US\$)	Q4 (US\$)	Q1 (US\$)	Q2 (US\$)	Q3 (US\$)	Q4 (US\$)
Dimbi	Revenue	1,516,000	2,078,000	2,551,000	5,700,000	5,700,000	5,700,000	5,700,000
Etoile	Revenue		15,000	15,000	15,000	50,000	250,000	300,000
	<b>TOTAL</b>	<b>1,516,000</b>	<b>2,093,000</b>	<b>2,566,000</b>	<b>5,715,000</b>	<b>5,750,000</b>	<b>5,950,000</b>	<b>6,000,000</b>

**Notes**

Revenue to be derived from sale of diamonds extracted from the project during exploration pitting, bulk sampling & pilot mining.

Based upon grades and diamond values as per resource statement where available.

Alternatively based on projected estimates from geological evidence and experience in projects of a similar nature.

## 6 ETOILE PROJECT

The Etoile Project is located in eastern central CAR (Figure 1, Figure 3 and Figure 4). The project is comprised of two project areas namely, Nzako and Kotto-Bangana. Both these project areas are at an early stage of exploration. An initial reconnaissance exercise was completed for the Nzako Project Area in November 2007. No work has yet been carried out by PDF on the Kotto-Bangana Project Area situated to the north.

### 6.1 Property Description and Location

The Etoile Project is situated between 600km (Kotto-Bangana) and 500km (Nzako) east of Bangui, in the Haute-Kotto and Mbomou Districts, respectively (Figure 3). The south flowing Kotto River passes through the Bangana concession, whilst the Nzako is situated on the Nzako River, a tributary of the Kono River. The size of the project along with the coordinates are summarised in Table 26.

**Table 26 : Etoile Project Area and Boundary Coordinates**

PROJECT	PROJECT AREA	LICENSE TYPE	PERMIT NO.	AREA (km <sup>2</sup> )	AREA (ha)	BOUNDARY COORDINATES (LATITUDE, LONGITUDE)
Etoile	Nzako	Exploration	RC4-336	922.00	92,200	(06°17'00"N; 22°45'00"E); (06°17'00"N; 22°56'00"E); (05°47'00"N; 22°58'00"E); (05°47'00"N; 22°51'00"E)
	Kotto-Bangana North	Exploration	RC4-337	988.00	98,800	(07°35'00"N; 22°43'00"E); (07°35'00"N; 23°03'00"E); (07°20'30"N; 23°03'00"E); (07°20'30"N; 22°43'00"E)
	Kotto-Bangana South	Exploration	RC4-338	962.00	96,200	(07°20'30"N; 22°43'00"E); (07°20'30"N; 22°03'00"E); (07°10'00"N; 22°03'00"E); (07°10'00"N; 22°50'00"E); (07°05'00"N; 22°47'00"E); (07°05'00"N; 22°34'00"E); (07°15'00"N; 22°43'00"E)
	<b>TOTAL ETOILE</b>			<b>2,872.00</b>	<b>287,200.00</b>	

The coordinates of the license boundaries were provided by the government in the official documentation. Although these have not been surveyed on the ground by PDF, they have been located from satellite images for the properties.

As stated in the Section 5.1, alluvial diamond mineralisation is associated with the Kotto River, its tributaries and the interfluvial areas. This mineralisation has been exploited to varying degrees since the early 1900s by the French and more recently by local artisanal miners. Currently only limited artisanal activities are present within the license areas and within Nzako also include artisanal mining of gold as a by product. Mined out areas are identified, where possible, although the rapid regeneration of vegetation in these areas often makes this difficult.

#### 6.1.1 Legal Aspects and Tenure

Three Exploration Permits were issued to local CAR company, Etoile Diamants SAU (Etoile Diamants), in August 2007. The ownership is illustrated in Figure 5. Efidium owns 100% of the project. All rights pertain to the exploration for both alluvial and kimberlitic diamonds. The legal tenure is summarised in Table 27.

**Table 27 : Etoile Project Legal Tenure**

PROJECT	PROJECT AREA	LICENSE TYPE	PERMIT NO.	MINERAL	LICENSE HOLDER	AREA (km <sup>2</sup> )	EXPIRY DATE	STATE'S SHARE
Etoile	Nzako	Exploration	RC4-336	Gold & diamonds	Etoile Diamants	922.00	Aug 2010	0%
	Kotto- Bangana North	Exploration	RC4-337			988.00		
	Kotto- Bangana South	Exploration	RC4-338			962.00		

The exploration permits allow Etoile Diamants to utilise all methods required to localise and assess its mineral deposits. This includes bulk sampling and laboratory analysis. The license is valid until August 2010 and can be renewed twice for two further three year terms.

Etoile Diamants signed a Mining Development Agreement with the Central African State in February 2007 which covers the general, legal, financial, tax, economic, administrative, customs and social conditions agreed to between the parties pertaining to prospecting, exploration and mining. This is the same as that agreement signed for the Dimbi Project. The obligations of the State and Etoile Diamants are stipulated in Section 5.1.1.

Fees are paid to the government for the right to access the surface over the area. There is sufficient surface area for the current as well as any future mining operation to be carried out.

#### **6.1.2 Royalties, Fees and Taxes**

As stated in Section 5.1.2 for the Dimbi Project, the State requires the payment of a royalty of 6% of the parcel value. The CAR company tax rate is 30%, and the withholding tax on dividends is set at 10%. VAT of 19% is payable on services and local purchases.

Fees are payable for the renewal or transfer of permits and for the use of the surface. These are defined in the Mining Development Agreement.

#### **6.1.3 Impact of the Project on the Environment**

The environmental requirements for both Dimbi and Etoile are defined in the Mining Development Agreement as described in Section 5.1.3.

No environmental studies have yet been carried out on the Etoile Project.

### **6.2 Accessibility, Climate, Local Resources, Infrastructure and Physiography**

#### **6.2.1 Locality, Population and Access**

The Nzako Project Area is situated approximately 110km southeast of the large town of Bria and 35km north of the town of Bakouma in the Mbomou District of eastern central CAR (Figure 4). The village of Nzako is located within the concession area. Access to the project area from the capital of Bangui is either by road or by air. A single primary road extends from Bangui to Bakouma and then northwards to Nzako village, a distance of 50km. This road is tarred for the first 200km and thereafter is gravel. The road is in a poor condition and the trip from Bangui to Nzako typically takes 12 hours. The alternative route is by light aircraft from Bangui International Airport to the Bakouma strip which takes approximately 90 minutes. Transport by air is the most reliable, effective and the quickest method of travel. A short airstrip of 850m is located at the town of Nzako.

The Kotto-Bangana Project Area is situated approximately 135km northeast of Bria in the Haute-Kotto District of eastern central CAR (Figure 4). The village of Bani is located within the concession area. PDF has recently restored the road between Yalinga and Bani. Access to the project area, from the capital of Bangui, is either by road or by air, as described above. The route by light aircraft is from Bangui International Airport to the Bria strip, taking approximately 2 hours.

#### **6.2.2 Infrastructure and Local Resources**

PDF has established a permanent camp at the Nzako Project Area and a fly camp at Bani at the southern end of the Bangana license.

The town of Bakouma, southeast of the Nzako concession has an 800m long unpaved airstrip. PDF has visited Nzako village and identified the presence of nine churches, four mosques, a primary school and a hospital. The population of Nzako varies from 17,000 to 21,000. All water is sourced from the Nzako River. No power is available in the village.

The closest village to the Kotto-Bangana Project Area is Bani, located near the southern border of the property. No details on the infrastructure and local resources are available as PDF has not visited the village.

### 6.2.3 Climate and Vegetation

The vegetation pertaining to the Etoile Project is comprised of open flat savannah grassland on the elevated regions interspersed with riverine forest in the low lying area along the river courses.

The climate in the Etoile Project area is classified as tropical with high midday temperatures and moderate nightly minimums. As stated for the Dimbi Project in Section 5.2.3, temperatures recorded for Bangassou vary from a midday maximum of 35°C in February to a night time minimum of 18°C in December/January. There are typically two seasons namely; a long wet season between February and October and a short dry season from November to January. No annual precipitation measurements were available, but most rainfall is precipitated as thunderstorms.

The land associated with the elevated regions is generally dry and as a result operations can easily be continued throughout the year. However, the rivers tend to become swampy which may limit operations to the dry season only.

### 6.2.4 Physiography

The project area is situated on or adjacent to the south flowing Nzako River and its tributaries. The Nzako River flows into the larger Kono River.

The higher ground is divided into a western and eastern elevated region of quartzite and laterite formation at an elevation of 680m amsl, and a lower swampy area adjacent to the Nzako River at an elevation of 560m amsl.

## 6.3 History

Diamond mining in the eastern CAR was concentrated in the Mouka and Bria regions, as summarised in Table 28.

**Table 28 : History of Diamond Discoveries in the CAR and the Etoile Project**

DATE	COMPANY	ACTIVITY
1914	Prospector	First diamond found in the CAR in the Mouka region to the east.
1929	CEM	Diamond recovered from tributary of the Kotto in the region of Bria. CEM recovered >700 carats.
1936	CEM	CEM ceased exploration in the east and switched to the Carnot deposits.
1930 – 1960	CEM, Compagnie Minière de l'Oubangui Oriental & Others	Discovery and exploitation of most of the known deposits of both east and west CAR.
1959 - 1963	BRGM	Compilation of all available data on the diamond deposits up to 1963 into "Geology and Mineral Resources of the CAR". Only released in 1982.
1947 – 1950	Various companies & organisations	Intensive exploration of the eastern deposits, followed by exploitation (<35,000ct).
1950 – 1963	Various companies & organisations	Continued exploitation of both east and west. Numerous research projects into the genesis of the deposits.
1964 – 1997	Artisanal diggers	Continued exploitation of both areas, mainly by artisanal diggers. Production unknown, but partial records available at the Dept. of Mines and Geology.
1997	Central African Mining Company (CAMCO)	Evaluation of alluvial diamond and gold deposits in the CAR. Included Kotto-Bangana & Nzako concession areas.
2006	Energem Resources Inc.	Continuous oblique photography of the Kotto-Bangana concession.
2007	Etoile Diamants	Obtains exploration licences for Kotto-Bangana and Nzako Project Areas.

#### 6.3.1 Historical Exploration, Sampling and Production Records

The "Geologie et Ressources Minerales de la Republique Centrafricaine (1963)", issued in 1982, provides historical production data from various diggings within or near to the Nzako and Kotto-Bangana Project Areas. The production data is summarised in Table 29.

**Table 29 : Historical Production Data to 1963 for Nzako and Kotto-Bangana Project Areas**

PROJECT AREA	LOCAL DIGGING	TOTAL CARATS	GRADE (ct/100m3)	AVE STONE SIZE (ct/stone)
Nzako	Ambilo	38,729	37	0.85
	Bakatoha*	1,106	14	0.36
	Bamala*	257	1	0.67
	Gonda	6,843	26	0.67
	Hoda*	164	1	1.25
	Kono*	47,798	55	0.62
	Masua	1,327	22	0.44
	Mbala	398	15	0.39
	Ngoto*	580	11	0.26
	Pia	5,342	29	0.54
	Tere	7,222	42	1.08
	Tiago	21,428	29	0.96
	Zako	3,124	1	0.66
<b>TOTAL / AVE NZAKO</b>		<b>134,318</b>	<b>40</b>	<b>0.76</b>
Kotto-Bangana	Aka	11,370	120	N/A
	Yafara	14,061	70	0.91
	Gueingou	5,387	90	0.50
	Lingou	1,259	15	0.91
	Bango	301	N/A	0.13
<b>TOTAL / AVE KOTTO-BANGANA</b>		<b>206,117</b>	<b>89</b>	<b>0.79</b>

\* Digging not within the PDF concession area.

Since the late 1960s only artisanal activities continued in the area and as a result limited further official production results were available. The Department of Mines and Geology in Bangui has some results for production, believed to be up to 1997, and information on the diamonds. Complete information is not available for the diggings listed in Table 29 but the straight averages for the Nzako Project Area are illustrated in Figure 20 and Figure 21.

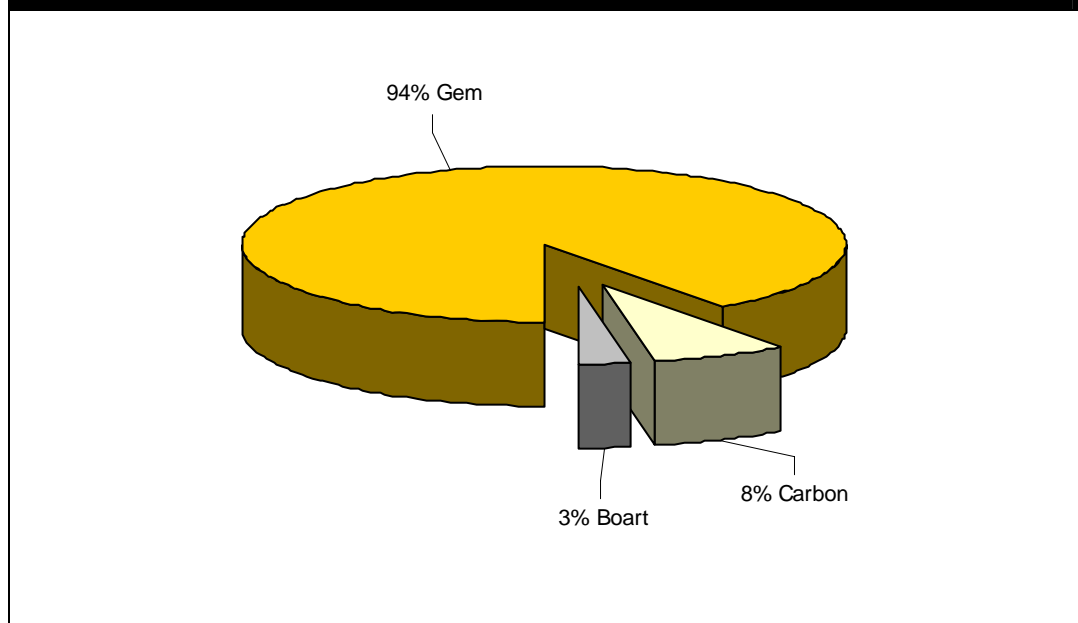
**Figure 20 : Historical Statistics on Percentage of Gem Diamonds for Nzako Project Area**

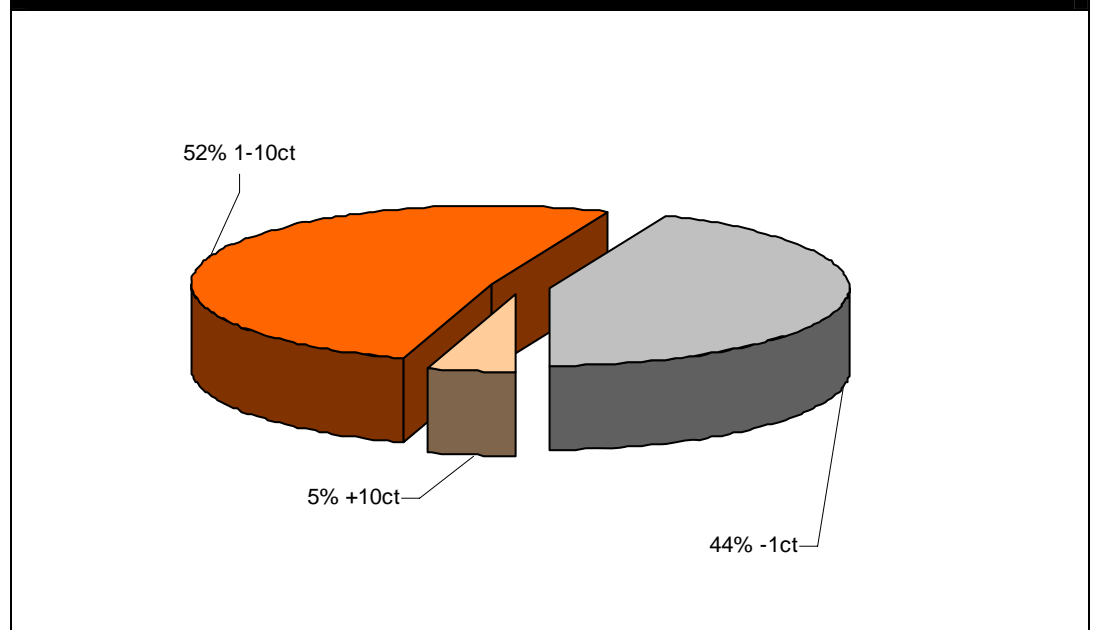
**Figure 21 : Historical Statistics on Diamond Size for Nzako Project Area**

The graphs indicate that the Nzako Project Area diamonds are potentially of good quality and size.

### 6.3.2 Historical Diamond Resources

No historical Diamond Resource data is available for the Etoile Project.

## 6.4 Geological Setting

### 6.4.1 Regional Geological Setting

The regional geological setting was described in Section 5.4.1 and the geological map of the eastern central CAR is illustrated in Figure 8.

### 6.4.2 Local and Property Geology

The local geology pertaining to the Nzako Project Area includes the following:-

- sandstones from the Mouka-Ouadda which form the high lying plateaux. Very large crevices are present on the edges of the scarp slopes and these have acted as structural traps which contain gravels and quartzite colluvium in a sandy matrix. Purple iron rich gritstones are also occasionally present;
- ferruginous laterite layers are developed as laterite banks at various elevations within the concession. The layers present at an elevation of 600m host large pebbles and boulders cemented in an iron rich matrix. The poorly sorted pebbles range from angular to well rounded; and
- younger diabase dykes associated with quartz veins. These veins are being actively mined for gold.

No details with respect to the local geology of the Kotto-Bangana concessions are available as PDF has not conducted any detailed work there. From the geological map (Figure 8) and initial reconnaissance visits by PDF geologist, however, it would appear that two alluvial diamond systems are present (when diamonds have been recovered by artisans) being the Kotto River and associated overbank (flats) deposits and the Bangana River alluvium deposits. Due to access and easier evaluation (less water) PDF has decided to commence work by establishing a fly-camp at Bani in the south of the concession to commence evaluation of the alluvials by pitting in a systematic manner. The road from Yalinga to Bani has been rehabilitated by PDF.



## 6.5 Deposit Type

The Nzako Project Area is host to alluvial deposits which have historically been extensively mined for diamonds and gold. The artisanal activities of gold and diamond extraction are ongoing.

The Kotto-Bangana Project Area is host to alluvial diamond deposits which have also been extensively worked since the early 1900s.

## 6.6 Mineralization

No geological model has been constructed for either the Nzako or Kotto-Bangana Project Areas due to the limited exploration conducted in both project areas by PDF.

However, a number of gravels have been viewed at various artisanal workings within Nzako, but further investigation into the geological setting is required. Initial observations would indicate that a braided river system may be present with primarily the western tributaries to the Nzako River carrying the diamonds. Therefore, the expected diamond distribution within the Nzako River would show increasing content at the intersection point with the western tributaries and thereafter decrease downstream (to the south) of it.

No information with respect to the mineralization can be reported for the Kotto-Bangana concessions.

## 7 ETOILE PROJECT – NZAKO PROJECT AREA

The Nzako Project Area is situated 150km to the south of the Kotto-Bangana Project Area (Figure 3 and Figure 4).

### 7.1 Exploration

PDF plans to carry out exploration at Nzako using a similar phased approach as utilised at Dimbi Project and described in Section 5.7. This will take place after an initial reconnaissance exercise.

### 7.2 Reconnaissance Exercise

PDF completed the initial reconnaissance exercise in November 2007. This included a site visit and a visit to the Department of Mines and Geology in Bangui. A satellite image of the area was obtained and used as the base plan. The purpose of the exercise was to:-

- obtain any historical information on the area;
- identify the basic infrastructure in the area;
- identify and map the extent of the mined out areas;
- obtain basic information on the topography and environment;
- assess the gravels from the artisanal workings;
- make a basic assessment of the geology; and
- identify any potential areas for future investigation.

The results of the reconnaissance exercise are illustrated on Figure 22.

### 7.3 Pitting

No pitting has been carried out within Nzako Project Area.

### 7.4 Auger Drilling

No auger drilling has been undertaken at Nzako.

### 7.5 Bulk Sampling

No bulk sampling has been carried out in the Nzako Project Area.

**EXTENT OF WORKINGS AND HISTORICAL INFORMATION FOR NZAKO PROJECT AREA**

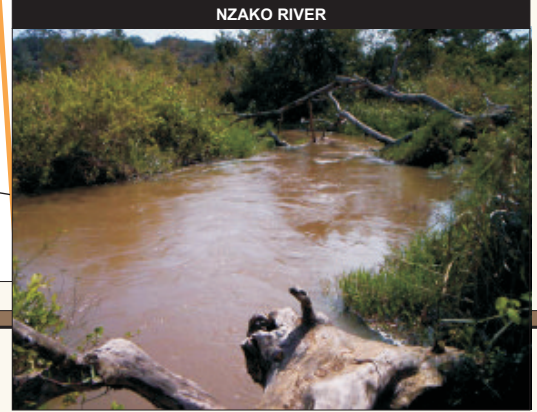
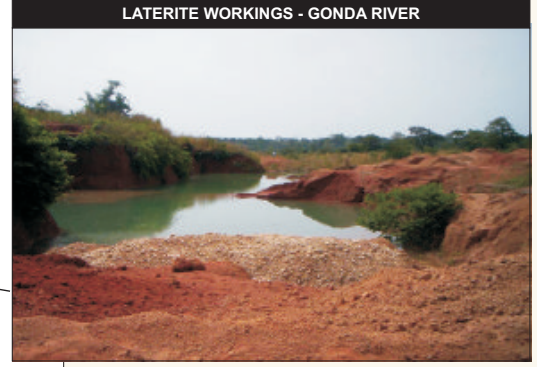
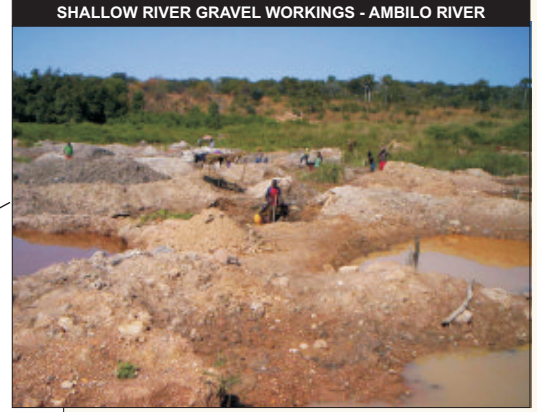
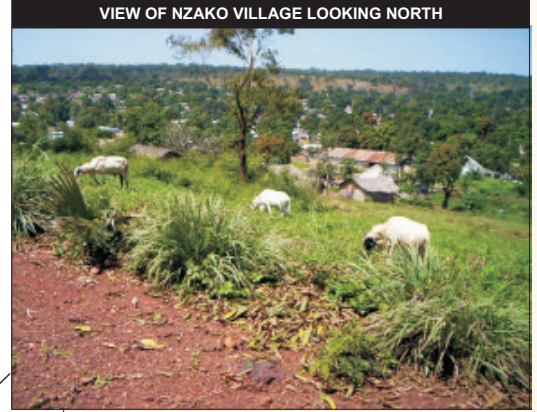
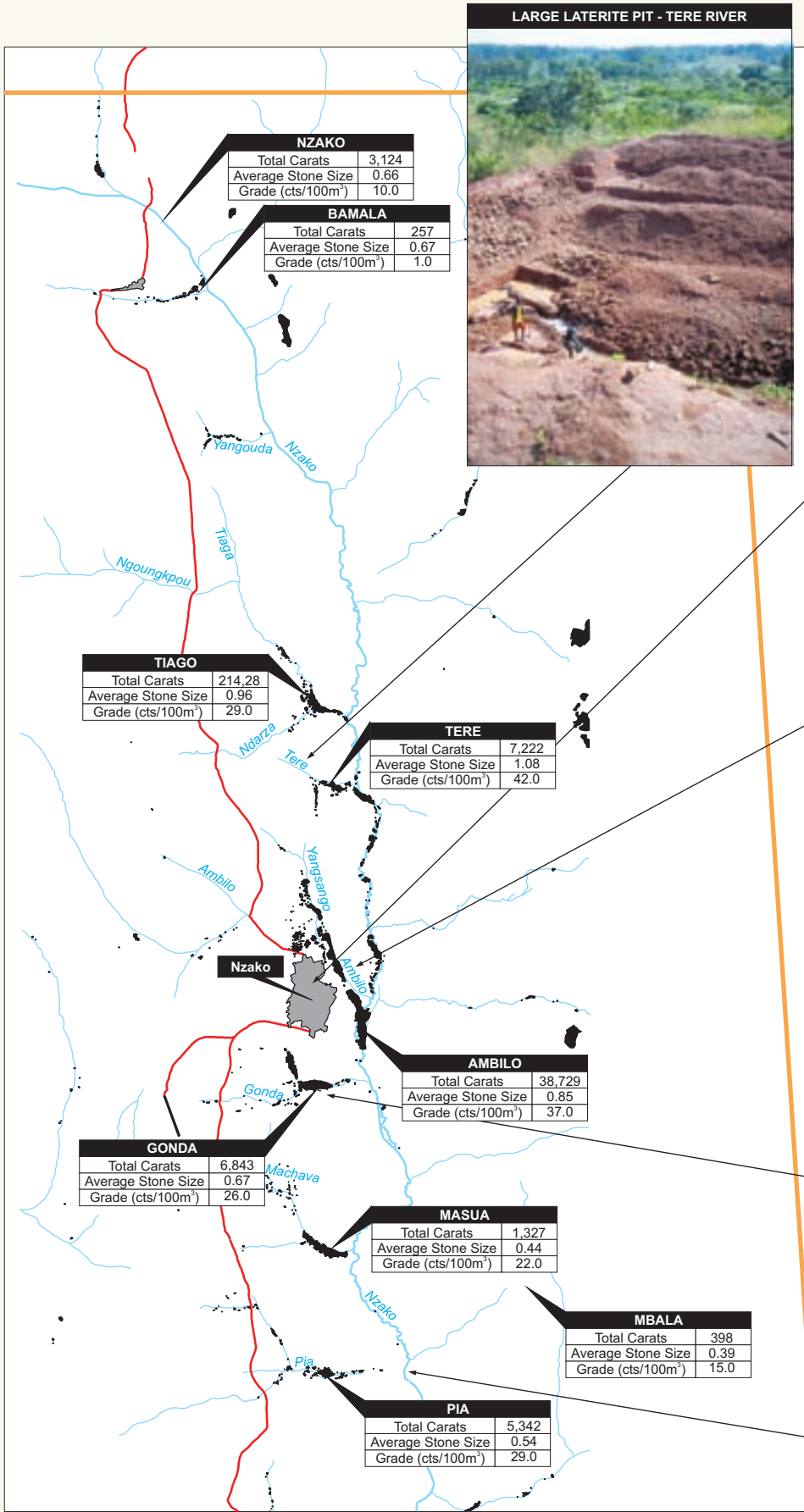

Source: Pangea

This diagram and the information therein are copyrighted. It may not be reproduced or transmitted in any form or by any means without prior written permission from Venmyn Rand (Pty) Ltd. Trading as Venmyn.

**LEGEND:**

- River
- Built-up Area
- Workings
- Licence Area

**SCALE:**



## 7.6 Adjacent Properties

Information pertaining to the historical diamond production along the Nzako River, adjacent to PDF's concession, is reported in Table 29.

## 7.7 Mineral Processing and Metallurgical Testing

No mineral processing has occurred at Nzako to date.

## 7.8 Diamond Resource and Diamond Reserve Estimates

No diamond resources are available at this early stage of exploration.

## 7.9 Other Relevant Data and Information

There is no other relevant data or information available.

## 7.10 Interpretation and Conclusions

Although widespread mining has taken place within the Nzako Project Area, extensive areas still remain available for mining. This is especially the case where the artisanal miners' rudimentary techniques make extraction for them too difficult or costly.

The reconnaissance exercise identified a number of potential target areas. These are illustrated in Figure 22 and include the following:-

- western tributary points on the Nzako River;
- Kono River;
- Ndarza River;
- Tere River;
- Pia River;
- Machava River;
- Gonda River; and
- Ambilo River

Potential also exists in large areas of the laterite gravel deposits. Although the stripping ratios appear greater than the river gravels, the widespread areas and dry working conditions make these a future target area.

## 7.11 Recommendations

The recommended work programme for all CAR projects, including the Etoile Project, is tabulated in Table 24. Venmyn has assisted PDF in the compilation of the work programme and budget in respect of the Etoile Project and recommends that the company undertake the programme as stated therein. The potential revenues are tabulated in Table 25.

## 8 ETOILE PROJECT – KOTTO-BANGANA PROJECT AREA

The Kotto-Bangana Project Area is situated 150km to the north of the Nzako Project Area (Figure 3 and Figure 4).

### 8.1 Exploration

PDF plans to carry out exploration at Kotto-Bangana using a similar phased approach as utilised at the Dimbi Project (Section 5.7) and for the Nzako Project Area. No exploration has yet been carried out at Kotto-Bangana.

### 8.2 Reconnaissance Exercise

PDF plans to carry out a reconnaissance exercise in the first quarter of 2008. The purpose of this is described in detail in Section 7.2. A base plan from the 1997 CAMCO report which located the positions of the active workings and river systems is illustrated in Figure 23.

**LOCATION OF RIVERS AND HISTORICAL WORKINGS IN THE KOTTO-BANGANA PROJECT AREA**

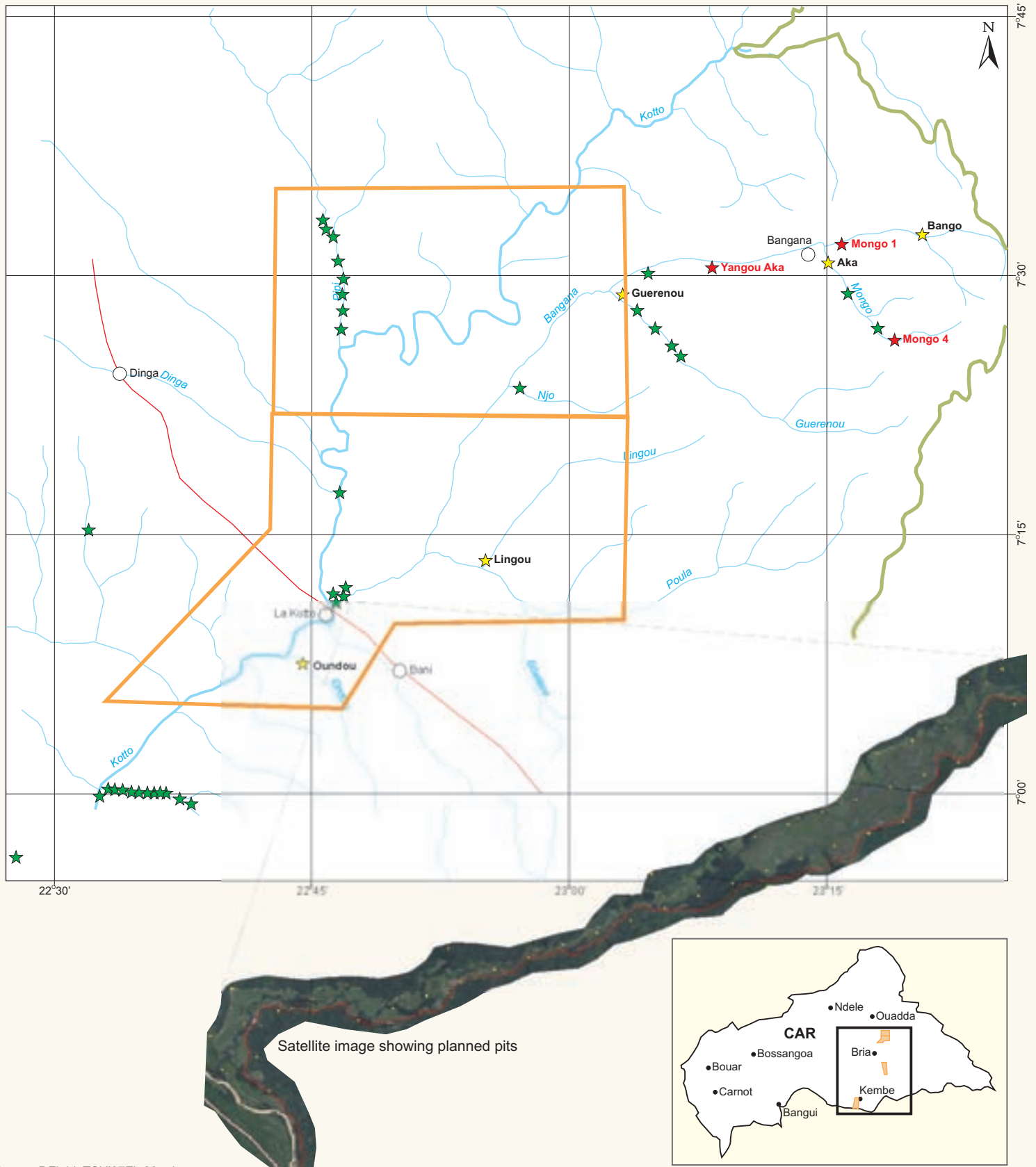

PangeaDFieldsTSX'07Fig23.cdr

Source: Bloomer



**LEGEND:**

- Lease Boundary
- Major River
- River/Stream
- Road/Track
- Eastern Limit of Mauka-Ouada Formation

- Village
- ★ Producer (1963 records)
- ★ Producer (1997)
- ★ Active Working (1997)

This diagram and the information herein is copyrighted. It may not be reproduced or transmitted in any form or by any means without prior written permission from Venmyn Rand (Pty) Ltd. Trading as Venmyn.

**8.3 Pitting**

No pitting has been carried out within the Kotto-Bangana Project Area.

**8.4 Auger Drilling**

No auger drilling has been undertaken at Kotto-Bangana.

**8.5 Bulk Sampling**

No bulk sampling has been carried out in the Kotto-Bangana Project Area.

**8.6 Adjacent Properties**

Information pertaining to the historical diamond production along the Kotto River, adjacent to PDF's concession, is reported in Table 29.

**8.7 Mineral Processing and Metallurgical Testing**

No mineral processing has occurred at Kotto-Bangana to date.

**8.8 Diamond Resource and Diamond Reserve Estimates**

No diamond resources are available at this early stage of exploration.

**8.9 Other Relevant Data and Information**

There is no other relevant data or information available.

**8.10 Interpretation and Conclusions**

No interpretations are available as no work has been conducted on the property.

The historical production records suggest that this would be a prospective area for future exploration.

**8.11 Recommendations**

The recommended work programme for the CAR, including the Etoile Project is tabulated in Table 24 and Table 25.

## 9 DEMOCRATIC REPUBLIC OF CONGO PROJECTS

PDF has access to tenure over an area of 228km<sup>2</sup> in the southern DRC, near the Angolan border. This area has been divided into two projects according to their location on the major north flowing rivers draining the area, namely the Longatshimo and Tshikapa Rivers. These have subsequently been divided into nine project areas according to their tenure, i.e. the local holder of the rights. The project locations are illustrated in relation to the DRC's infrastructure on Figure 24. Additional detail with respect to the license boundaries and the local infrastructure and drainage systems are indicated on Figure 25.

## 10 LONGATSHIMO RIVER PROJECT

The Longatshimo River Project is comprised of five project areas (six licences) located on both banks of the Longatshimo River in southern DRC (Figure 24 and Figure 25). The areas are namely, from north to south, Bashala, Somilo, Kajama, Kapopo and Kamonia. The project areas range in development from early to late stage exploration. Bulk sampling is set to commence early in 2008 at Kamonia, once the processing plant has been erected and commissioned at the Longatshimo River Project site. The Longatshimo River Project forms the primary focus of PDF's work in the DRC.

### 10.1 Property Description and Location

The Longatshimo River Project areas are situated between 28km and 58km south southeast of Tshikapa in the Kasai District of the Kasai-Occidental Province, DRC. The size of the project areas, along with their coordinates, are summarised in Table 30. The Longatshimo Project is approximately 30km from the Tshikapa River Project.

**Table 30 : Longatshimo River Project Areas and Boundary Coordinates**

PROJECT	PROJECT AREA	LICENSE TYPE	PERMIT NO.	AREA (km <sup>2</sup> )	AREA (ha)	BOUNDARY COORDINATES (LATITUDE, LONGITUDE)
Longatshimo River	Bashala	PR	992	36	3,600	(06°39'00"S; 20°57'00"E); (06°36'00"S; 20°57'00"E); (06°36'00"S; 21°00'00"E); (06°39'00"S; 21°00'00"E)
	Somilo	PR	4716	12	1,200	(6°41'30"S; 20°58'30"E); (6°40'30"S; 20°58'30"E); (6°40'30"S; 20°59'00"E); (6°39'00"S; 20°59'00"E); (06°39'00"S; 21°0'00"E); (06°41'30"S; 21°0'00"E)
	Kajama	PE	541	32	3,200	(06°46'30";20°56'00"); (06°44'00"; 20°56'00"); (06°44'00"; 20°59'00"); (06°46'30"; 20°59'00");
	Kapopo	PR	1497	9	900	(06°49'00"S; 20°54'00"E); (06°48'30"S; 20°54'00"E); (06°48'30"S; 20°54'30"E); (06°47'30"S; 20°54'30"E); (06°47'30"S; 20°56'00"E); (06°48'30"S; 20°56'00"E); (06°48'30"S; 20°55'30"E); (06°49'00"S; 20°55'30"E)
						(06°49'00"S; 20°55'30"E); (06°48'30"S; 20°55'30"E); (06°48'30"S; 20°56'00"E); (06°47'30"S; 20°56'00"E); (06°47'30"S; 20°55'30"E); (06°47'00"S; 20°55'30"E); (06°47'00"S; 20°56'30"E); (06°46'30"S; 20°56'30"E); (06°46'30"S; 20°57'00"E); (06°49'00"S; 20°57'00"E)
	Kamonia	PEPM	624	36	3,600	(06°52'00"S; 20°54'00"E); (06°49'00"S; 20°54'00"E); (06°49'00"S; 20°57'00"E); (06°52'00"S; 20°57'00"E)
<b>TOTAL LONGATSHIMO RIVER</b>				<b>136</b>	<b>13,600</b>	

The coordinates of the license boundaries were provided by the government in the official documentation. Although these have not been surveyed on the ground by PDF, they have been located from satellite images ordered for the respective properties.

Alluvial diamond mineralisation is associated with the Longatshimo River, its tributaries and the interfluvial areas. This mineralisation has been exploited to varying degrees since the early 1900s by the Belgians and more recently by local artisanal miners. Currently only limited artisanal activities are present within the license areas. Mined out areas have been identified, where possible, although the rapid regeneration of vegetation in these areas often makes this difficult.

**INFRASTRUCTURE AND LOCALITY PLAN OF DRC PROJECTS**

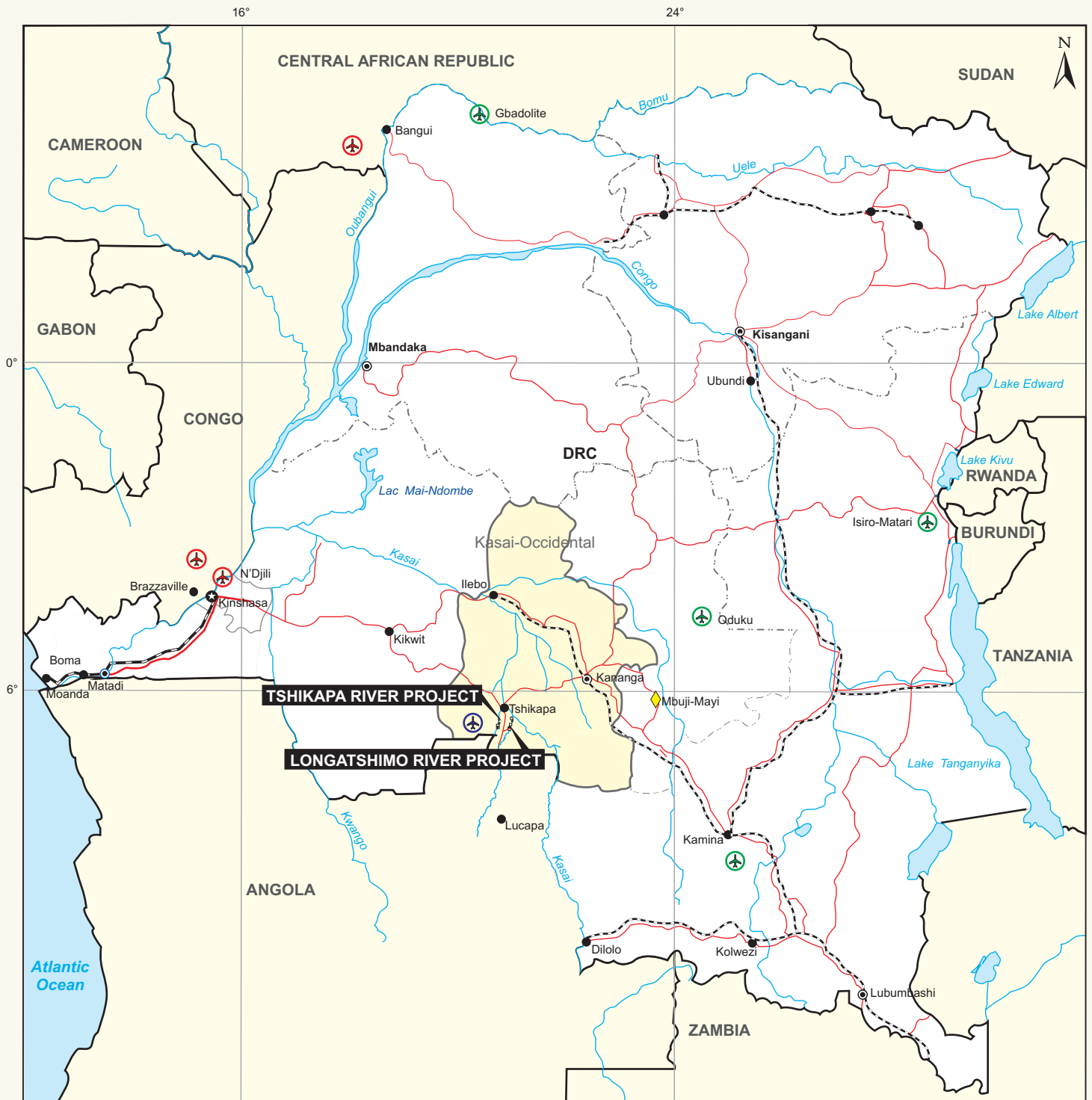

PangeaDFieldsTSX'07Fig24.cdr

Source: 1992 MACELLAN  
Geographix/SMSanta  
Barbara, CA (800) 929-4627

**LEGEND:**

- Main Road
- - - Mineral Railway
- ◆ Diamond Mine
- Town
- River
- Kasai-Occidental Province
- · - · Provincial Boundary
- ✈ International Airport
- ✈ Operational Airport
- ✈ Air Strip

**SCALE:**



This diagram and the information herein is copyrighted. It may not be reproduced or transmitted in any form or by any means without prior written permission from Venmyn Rand (Pty) Ltd. Trading as Venmyn.



**LICENSE BOUNDARIES IN RELATION TO LOCAL INFRASTRUCTURE AND DRAINAGE**

**LEGEND:**

- Road
- - - New Road made by Pangea
- ~ River
- Town
- ✈ Airstrip
- ★ Camp

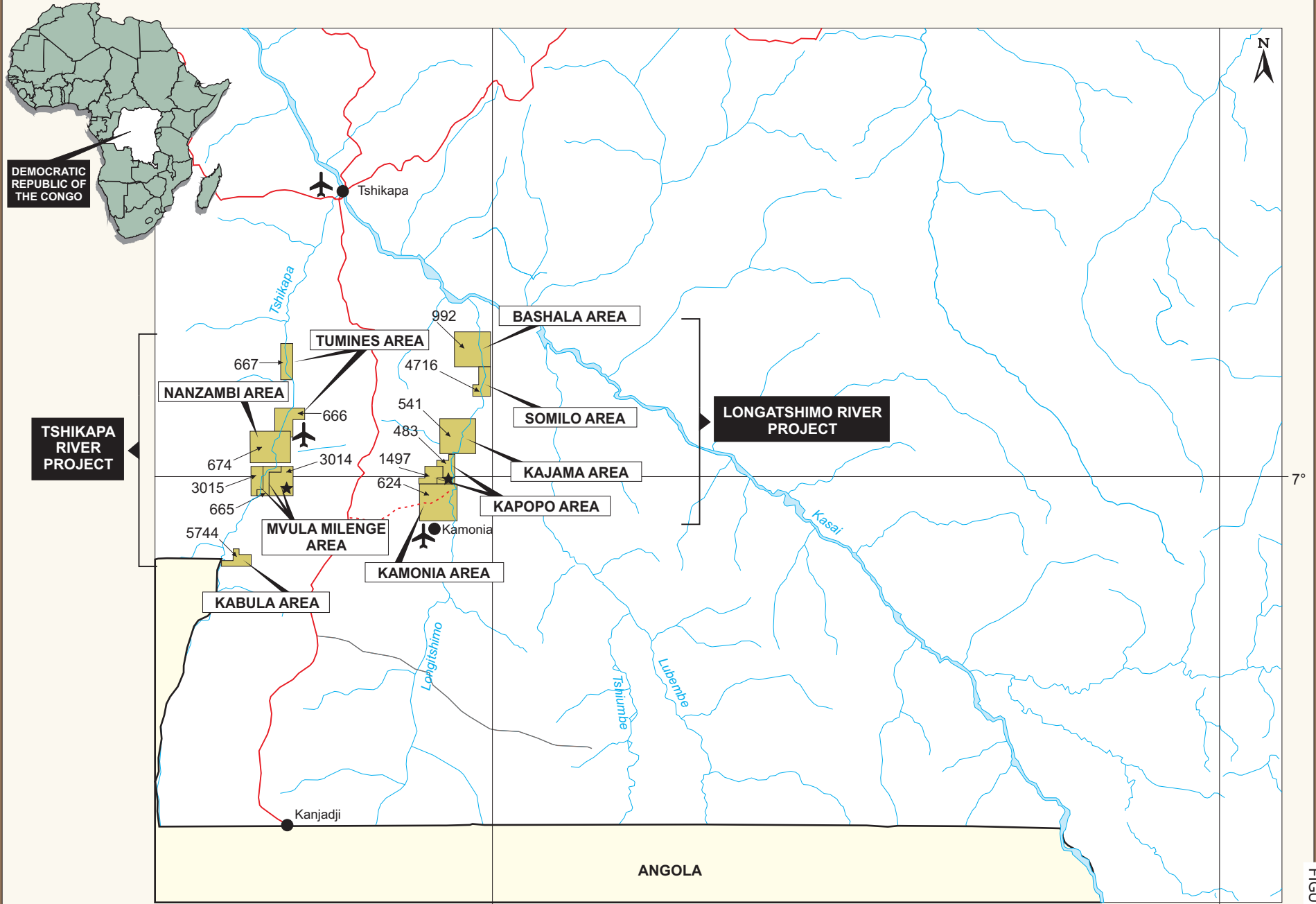

This diagram and the information therein are copyrighted. It may not be reproduced or transmitted in any form or by any means without prior written permission from Venmyn Rand (Pty) Ltd. Trading as Venmyn.



### 10.1.1 Legal Aspects and Tenure

The New Mining Code (NMC) of the DRC states that all rights to minerals are vested in the State. Licences are only granted through an agent domiciled in the DRC or through a tender process in the case of “valuable known mineral deposits”.

Four Exploration Permits (PRs), one Exploitation Permit (PE) and a single Exploitation Permit for Small Mines (PEPM) have been issued to local companies or individuals for the Longatshimo River Project properties. All rights pertain to the exploration for both alluvial and kimberlitic diamonds.

PDF, through their subsidiary, Efidium, has agreements with these local parties to obtain tenure. The entitlement of the local parties along with the tenure information is summarised in Table 31. A graphic representation of the ownership is illustrated in Figure 26.

**Table 31 : Longatshimo River Project Legal Tenure**

PROJECT	PROJECT AREA	LICENSE TYPE	PERMIT NO.	MINERAL	LICENSE HOLDER	AREA (km <sup>2</sup> )	EXPIRY DATE	APPLICATION FOR	DRC PARTNER'S RIGHT
Longatshimo River	Bashala	PR	992	Diamonds	Bashala Milandu (Bashala)	36	Oct 2007	Renewal	Royalty of 6% of revenue less costs, after 50% of capital paid back.
	Somilo	PR	4716		Somilo SPRL (Somilo)	12	Feb 2010		Royalty of 6% of revenue less costs, after 50% of capital paid back.
	Kajama	PE	541		Kajama Salambote (Kajama)	32	Jul 2006	Renewal & conversion to PE	20% free carried interest.
	Kapopo	PR	1497		Ikulu Lamajana (Kapopo)	9	Feb 2008	Renewal/ Conversion to PE	20% free carried interest.
		PR	483			11	Apr 2007	Renewal	20% free carried interest.
	Kamonia	PEPM	624		Yusufu-Musuku Mwana Kasonga (Kamonia)	36	Apr 2007	Renewal	20% free carried interest.
	<b>TOTAL LONGATSHIMO RIVER</b>						<b>136</b>		

Efidium is entitled to an 80% share of the Kajama, Kapopo and Kamonia Project Areas by spending a minimum of US\$300,000 on exploration on each over three years. Provided the results are positive, Efidium may then develop the project to Feasibility Stage at their own cost. With respect to Bashala and Somilo, Efidium holds 100% of the project area and will pay the local parties a royalty of 6% of revenue less costs once 50% of the project's capital has been paid back.

The licences for Bashala, Kajama, Kamonia and one of the Kapopo properties have expired. Applications have been made to the Mining Registry for the renewal of these. They are in progress and are likely to be issued over the next three months. PDF has no reason to believe that they will not be re-issued. Each permit renewal needs to be approved by each of the following departments: Technical, Environmental and Mining. Once all of these departments have approved the renewal in principal and have found no reason to reject such an application, a "favourable advice for renewal" is granted. Due to an apparent back log of up to 12 months for the final signature, renewal Permit Certificates by the Honourable Mining Minister have been sent as confirmation of renewal acceptance. This is further supported by Article 62: Renewal of the Exploration License, Chapter 1, and Title 2 of the DRC mining Code which states:

*“If the Minister does not reply to the renewal application which has been submitted in the appropriate manner within thirty days as of the date of filing, the renewal applied for is granted.”*

Fees are paid to the government for the right to access the surface over these properties.

**OWNERSHIP OF LONGATSHIMO RIVER PROJECT**

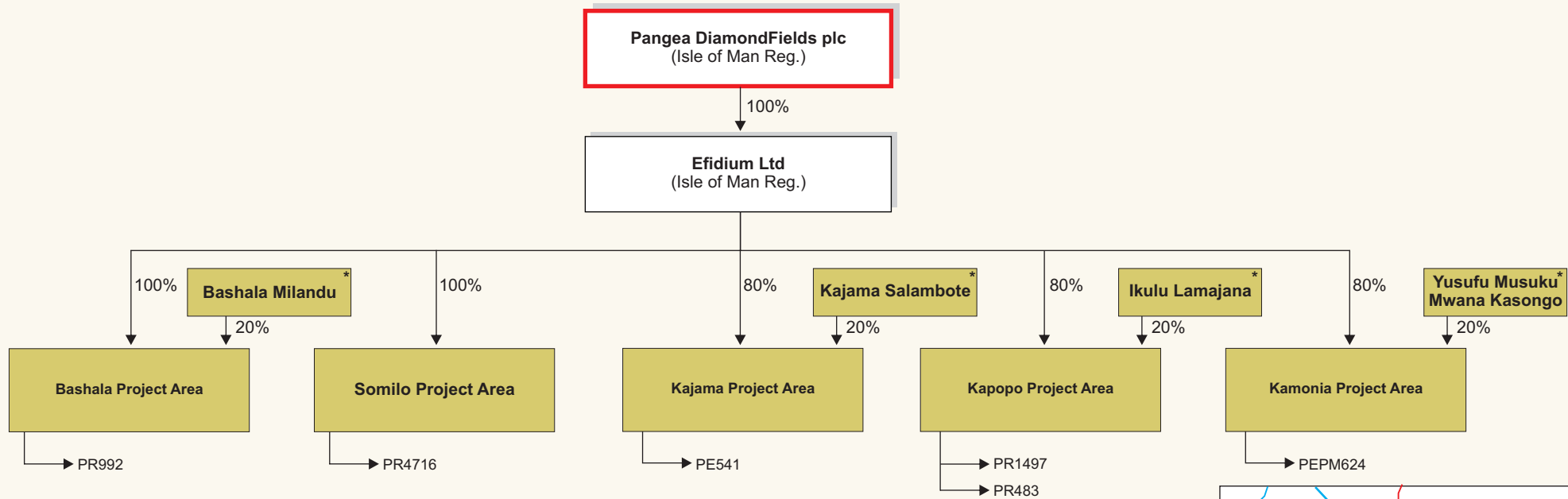

\*Holder of rights

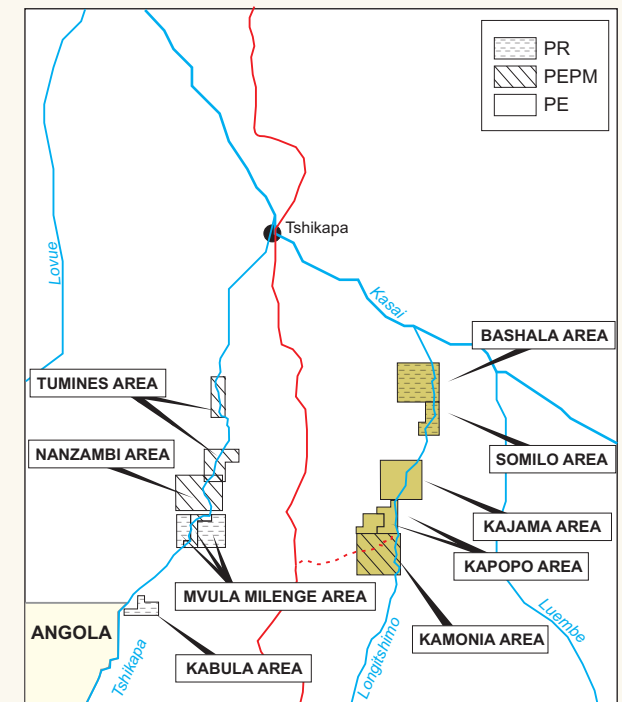
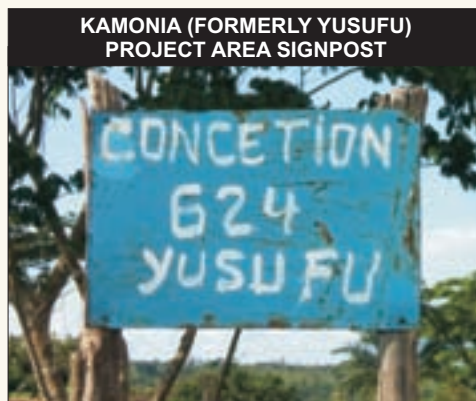

PangeaDFieldsTSX'07Fig26.cdr

This diagram and the information therein are copyrighted. It may not be reproduced or transmitted in any form or by any means without prior written permission from Venmyn Rand (Pty) Ltd. Trading as Venmyn.

The holder of the rights is obliged to complete a Plan for Mitigation and Rehabilitation (PAR). No additional obligations are specified.

The surface rights are held by the State.

### **10.1.2 Royalties, Fees and Taxes**

A mining royalty of 4% on sales, less sales transport and related costs, is payable to the government for diamonds. Customs duties on the import of equipment are 2% for the exploration permit holders and 5% for the exploitation permit holders. Fuel, lubricants and mining consumables are taxed at 3% for both permits. There is no export duty on marketable products. The DRC company tax rate is 30%, and the withholding tax on dividends is set at 10%.

### **10.1.3 Impact of the Project on the Environment**

PDF has paid the government between US\$4,000 and US\$20,000 per license for the preparation of the required PARs. There are no existing environmental liabilities on the properties. All current exploration activities will be rehabilitated by PDF as required. An estimate of the liability has not yet been prepared.

If mining commences then PDF will employ the services of an internationally recognized environmental expert to prepare the required Environmental Impact Study (EIE) and Environmental Management Plan (PGEP).

## **10.2 Accessibility, Climate, Local Resources, Infrastructure and Physiography**

### **10.2.1 Locality, Population and Access**

The Longatshimo River Project is situated near the town of Kamonia in the Kasai District of the Kasai-Occidental Province in southern DRC (Figure 25). Kamonia town is estimated to have a population of about 50,000 people.

The town has an airstrip which is serviced by five small commercial airline companies and private carriers. It can be reached either from Kinshasa (Figure 24), which is accessible from the Atlantic Ocean port of Moanda, or from Lubumbashi in the south along the border with Zambia. From Moanda, cargo can be transported on the Congo River to Matadi, whereafter it can be railed to Kinshasa, a distance of 305km.

There are three land access routes which can be used to reach Tshikapa from Kinshasa. The first option is by road 530km to Kikwit and 361km to Tshikapa. The second option is by 3t boat along the Congo and then Kasai Rivers to Ilebo, a distance of 740km and then by road to Tshikapa. The third route is to use the 936km railway line from Lubumbashi to Kananga and then to drive the remaining distance of 253km by road to Tshikapa. Kamonia and Kapopo Project Areas are located approximately 50km from the town of Tshikapa.

PDF has established a fourth land access route direct to the Longatshimo River Project via Angola. This has recently been utilised by the convoy carrying the processing plant and earthmoving equipment to the Longatshimo River camp. The route travels from Luanda, in Angola, to Saurimo and Lucapa in the northeast of the country and on to the border post at Kanjadji. The route also passes PDF's Cassanguidi Project. A new road has been prepared from existing tracks from the border post directly to the Longatshimo River camp, a distance of 84km.

Access to the project areas from Tshikapa is either by four wheel drive vehicle or motorcycle along gravel tracks, by boat where feasible or by a small Russian Antonov 2 aircraft requiring limited landing facilities. A new access route has been made from Kananga Town to Tshikapa, which is a 10 hour drive. An airstip is located at Mushapo, situated adjacent to and northeast of the Nanzmbi Project Area (Figure 27).

Transport by air is the most reliable, effective and the quickest method of travel within the DRC. The roads in the country are in poor condition and many are impassable. River crossings are often problematic due to the poor state of repair of bridges and ferries. Rail and boat links are a far better alternative for the transport of heavy cargo.

**INFRASTRUCTURE AND EQUIPMENT AT LONGATSHIMO RIVER PROJECT CAMP AND SURROUNDS**

**AERIAL VIEW OF VEGETATION**



**AIRSTRIIP AT MUSHAPO**



**CAMP**



**OFFICES**



**LOCAL TRANSPORT**



**GENERATOR**



**TRACTOR MOUNTED AUGER DRILL**



**AUGER RODS**



Source: Venmyn

This diagram and the information herein is copyrighted. It may not be reproduced or transmitted in any form or by any means without prior written permission from Venmyn Rand (Pty) Ltd. Trading as Venmyn.

PangeaDFieldsTSX'07Fig27.cdr

### 10.2.2 Infrastructure and Local Resources

A camp has been established by PDF on the Kamonia/Kapopo license boundary. The camp consists of accommodation, ablution, offices and mess facilities for 22 senior staff and 15 junior staff (Figure 27). A 10tph jig is also situated on site for processing samples. The concession is traversed by motorcycle and four wheel drive vehicles.

A 65tph DMS diamond processing plant has been erected adjacent to the camp. PDF is in the process of building a small clinic on site and have contracted the services of a local doctor.

All process water is sourced from the Longatshimo River and its tributaries. Potable water for the camp is sourced from a nearby spring and filtered prior to consumption.

Power is supplied to the camp using a diesel powered generator (Figure 27).

The closest large village to the Longatshimo Project is Kamonia (Figure 25) where unskilled and semi skilled labour is sourced. The town has a school and clinic. The closest large town is Tshikapa where the local infrastructure includes power sourced from a hydroelectric plant, an intermittent supply of running water, hospitals, schools and an airstrip.

A smaller village, Kate Mosolo, is situated on the Kamonia Project Area.

PDF has access to sufficient surface area for future potential mining and processing operations and tailing disposal.

### 10.2.3 Climate and Vegetation

The vegetation found within the Longatshimo River Project is comprised of open flat savannah grassland interspersed with riverine forest in the low lying area along the river courses (Figure 27). The forests typically comprise a dense closed canopy of large trees with a multilayered understorey of smaller trees, shrubs, lianas and herbaceous vegetation. The grasslands are burnt annually by the local inhabitants during the dry season.

The climate in the Tshikapa area is classified as tropical with high midday temperatures (30°C) and moderate nightly minimums (19°C). There are two seasons namely; a long wet season between October and April and a short dry season for the remaining part of the year. Annual precipitation is estimated at 1501mm and falls as tropical thunderstorms.

The land associated with the Longatshimo River Project is generally dry and as a result operations can easily be continued throughout the year. However, roads may become temporarily impassable during heavy storms.

### 10.2.4 Physiography

The project areas are all situated on or adjacent to the Longatshimo River, a major north flowing river draining into the Kasai and then Congo River. The physiology of the project area includes river valleys and interfluvial areas with a gentle gradient. The elevation varies from a maximum of 650m amsl to a minimum of 500m amsl.

## 10.3 History

The Longatshimo Project is situated within the Tshikapa Diamondfield, a well known diamond area with a long history of alluvial diamond production. The Tshikapa Diamond Field is situated within the West Kasai Region of the DRC in the Kasai-Occidental Province (Figure 24 and Figure 28), within the Congo-Angola diamond province. The diamonds occurring within it are believed to have been eroded from numerous kimberlite occurrences concentrated within the structural lineament of the "Lucapa Graben" which stretched from Angola into the southern DRC. The Tshikapa Diamondfield lies directly downstream of the alluvial and kimberlitic diamond fields of northeastern Angola.

As a result of recent indicator mineral discoveries in the Kasai-Occidental Province, there is now also evidence of kimberlites within the DRC and these are being actively searched for by numerous exploration companies.

**GEOLOGY AND HISTORICAL PRODUCTION OF THE TSHIKAPA DIAMONDFIELD**

- LEGEND:**
- Rivers
  - Kalahari Super Group
  - Kwango Formation Conglomerates (Diamond Bearing)
  - Lualaba Formation (Barren)
  - Basement Granite, Gneiss & Gabbros
  - ✕ Mines (1960)
  - Licence Boundary
  - ◇ Diamond Occurrences
  - ▬ Dredges
  - ▭ Historical Forminiere Production up until 1961

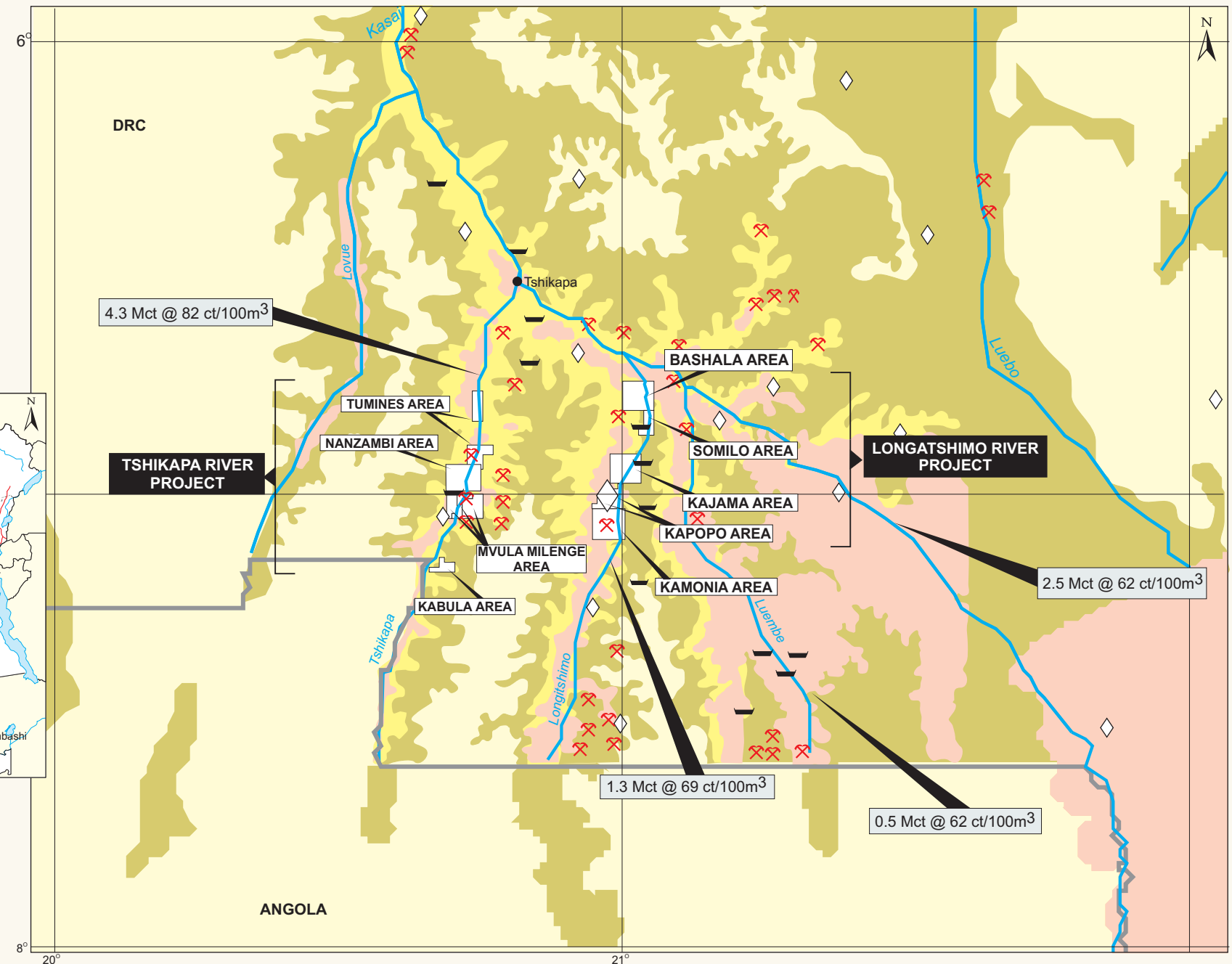
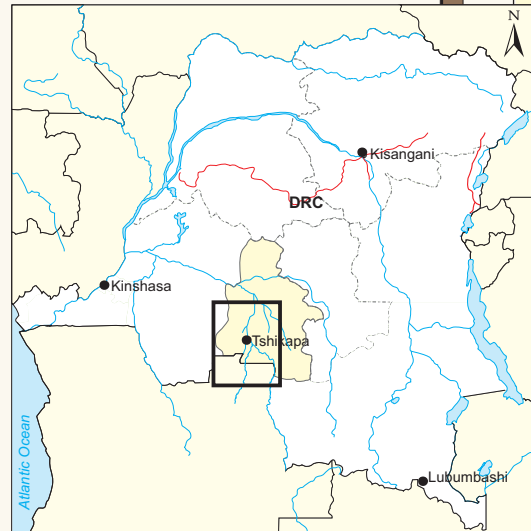

PangeaDFieldsTSX'07Fig28.cdr

SCALE



This diagram and the information therein are copyrighted. It may not be reproduced or transmitted in any form or by any means without prior written permission from Venmyn Rand (Pty) Ltd. Trading as Venmyn.

Diamonds were first discovered in West Kasai in 1907, when a small stone was found in the Tshiminina River, a tributary of the Kasai River. Production from the field commenced in 1912, and the total recorded production until 1961 amounted to 21Mcts at an overall grade of 0.9ct/m<sup>3</sup>, 65% of which were gem quality.

Production from the diamondfield was dominated by the Belgian company Societe Internationale Forestiere et Miniere du Congo (Forminiere) until independence in the early 1960s. Figure 28 indicates the operational mines at this time and the total recorded production. Since then official records of production are sketchy and unreliable as artisanal miners took control of mining in the area. Historical production from the diamondfield was primarily sourced from active rivers and alluvial terraces along the river banks and, to a lesser extent, from the Kwango Formation conglomerates.

The prior ownership of the Longatshimo River properties and their historical ownership changes are unknown. It is likely, however, that these have changed hands many times between the local Congolese owners and artisanal miners since Forminiere exited in the 1960s. No records of these changes were forthcoming.

### 10.3.1 Historical Exploration, Sampling and Production Records

Forminiere systematically sampled the gravels within the Tshikapa Diamondfield between the early 1900s until independence in 1960. The company tested the gravels at the base of the flood plains and terraces by manually pitting or excavating until bedrock was intersected.

Approximately 0.5 – 1.0m<sup>3</sup> of gravel was then removed from each pit and the diamonds extracted. The pits were excavated on grid lines of between 100m – 160m. All the pit positions were recorded on plans, as well as the associated overburden thickness, gravel thickness and grade. The reported diamond grades did not take into account the volumes attributed to any large boulders that may have been too large to be extracted and were therefore left in the bottom of the pit.

Extensive historical data is archived at the Royal Museum for Central Africa (RMCA) in the Tervuren Institute, Belgium. Efidium has, on two occasions, visited the Institute and researched all available relevant data.

Historical production results obtained for the entire Longatshimo River state that 1.3Mct were recovered at an average grade of 69ct/100m<sup>3</sup>. The production associated with PDF's project areas are tabulated in Table 32

**Table 32 : Historical Production within PDF's Longatshimo Project**

PROJECT	PROJECT AREA	TRIBUTARY	YEAR	GRAVEL VOLUME (m <sup>3</sup> )	GRADE (ct/100m <sup>3</sup> )	CARATS
Longatshimo River	Kapopo	Kapopo	1925	2,330	95.06	2,215
			1927	65,001	84.00	54,601
			1935	296,099	73.55	217,792
			<b>TOTAL / AVE</b>	<b>363,430</b>	<b>75.56</b>	<b>274,608</b>

Historical records state that approximately 65% of the diamonds produced from the field are of gem quality. Unpublished reports from 2001 state the diamonds from the southern reaches of the diamondfield consistently sell for US\$180/ct, while those from the northern parts sell for between US\$60/ct and US\$80/ct.

### 10.3.2 Historical Diamond Resources

No historical Diamond Resource and Diamond Reserve estimates are available for the Longatshimo Project.

## 10.4 Geological Setting

### 10.4.1 Regional Geological Setting

The geology of southwestern DRC comprises upper and lower Archaean sequences consisting of granites, gneisses and gabbros (Figure 28). These are overlain by the Proterozoic – Pan African metasediments of the Congo Craton. In early Cretaceous times these metasediments were unconformably overlain by the Lualaba Formation. The late Cretaceous Kwango Formation conglomerates were then deposited, followed by the Pleistocene Kalahari Formation sands. These sequences were subject to erosion by rivers in recent times as a result of two periods of uplift.

The alluvial diamond deposits of the Kasai region are associated with the vast sheet of conglomerate lenses at the base of the fluvio-deltaic Kwango Formation, correlated with the Calonda Formation in Angola. The Kwango comprises a lower Lungudi-Lunganda unit and an upper Kabemba facies, the latter derived from local reworking of the former. The Kabemba only outcrops at the eastern and southern border of the Kasai Depression, and is believed to have higher average diamond grades than the Lungudi. This is presumed to be the result of the local reworking.

The general distribution of diamonds within the Kasai Depression is related to a south to north transport of the Lungudi sediments during the Cretaceous, the diamonds being derived from kimberlites in Angola. No kimberlites have yet been found in the Tshikapa Diamond Field, although indicator minerals have been identified in certain areas and associated localised increases in diamond grades and sizes. There is additional reworking and re-concentration of diamonds from the Kwango Formation in the current river systems.

### 10.4.2 Local and Property Geology

The local geology of the Tshikapa Diamondfield comprises flat Cretaceous sediments unconformably overlying the basement rocks (Figure 29). The Cretaceous sediments are comprised of the Loia and Bukungu Series. The Loia comprises a basal conglomerate dominated with basement clasts followed by arkoses and fine orange-brown sandstones and the Bukungu contains sandstones and local conglomerate. These formations are not diamondiferous. The Loia and Bukungu are overlain by the diamondiferous Kwango Formation. This formation is comprised of a deltaic basal conglomerate succeeded by sandstones. The formation's conglomerates are characterised by an abundance of agates and a heavy mineral content of garnet, staurolite and magnetite. The Kwango Formation is covered by Kalahari Supergroup sands.

Recent deposits are located downslope of the Kwango Formation (Figure 29). These are a result of later erosional processes by rivers and deflation surfaces. These concentrate the Kwango diamonds and any additional diamonds moving into the system from upstream during recent times.

## 10.5 Deposit Type

The Longatshimo River Project is host to both alluvial and blanket diamond deposits. Diamonds have been recovered, by PDF, from a number of geological environments including the palaeo-Longatshimo River channels, floodplain deposits adjacent to the Longatshimo River and its tributaries as well as from the colluvial (blanket) gravels situated upon the bedrock schists. These three deposit types formed the focus of PDF's exploration and, through this exploration work, resources have been defined for each. Further detail on each is described in the following section on mineralization.

## 10.6 Mineralization

The diamond mineralization within the Longatshimo River Project has been divided into the following geological environments:-

- present day Longatshimo River and associated gravel deposits within it (Figure 29), including potholes. These have not been researched by PDF and as a result no detailed description of the gravels is available;



**LEGEND:**

- Kalahari Group
- Ochre Sand Formation (sand and clay)
- Kwango Formation (Argillite, arkose and conglomerate)
- Basal Kwango Conglomerate
- Bukungu Series
- Loia Series
- Possible Kimberlite
- Basement Schist
- Recent Sand
- Eluvial Gravel
- Terrace Gravel
- Gravel with associated diamonds

**SCHEMATIC CROSS SECTION OF THE DIAMONDIFEROUS DEPOSITS IN THE TSHIKAPA DIAMONDFIELD**

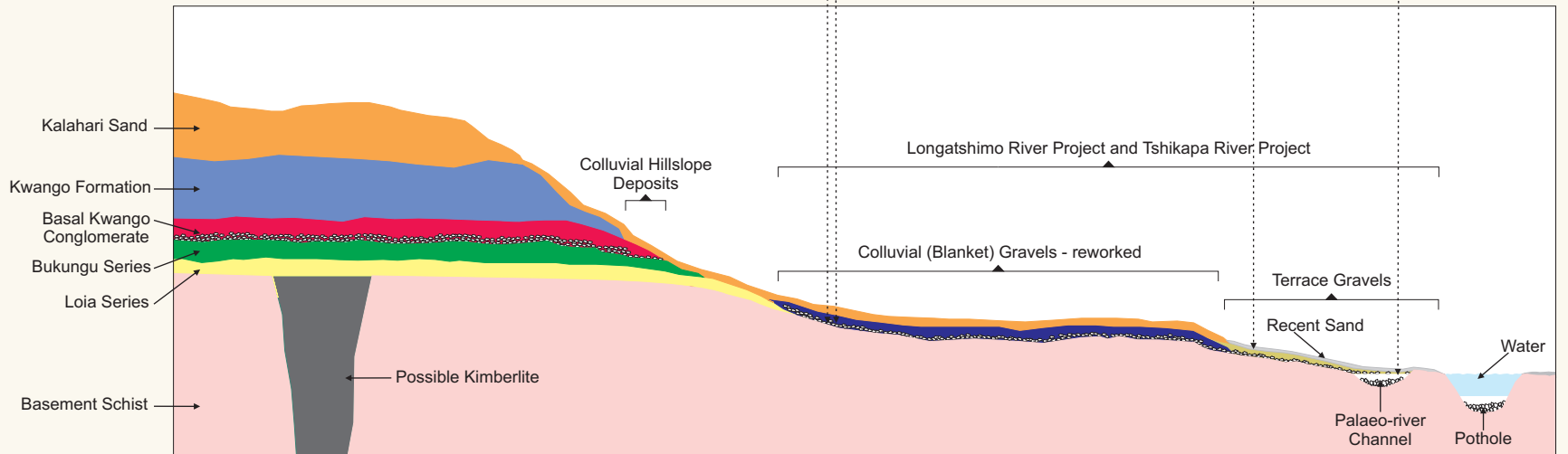

PangeaDFieldsTSX'07Fig29.cdr

- palaeo-Longatshimo River gravels (Figure 29). These light brown gravels are characterised by multiple fining upward layers with an average thickness of 1.5m each. The diamonds are associated with the basal gravel unit. The gravels are comprised of well sorted, well rounded pebbles with an average diameter of 30mm. The pebbles include quartz, jasper and chert. The oversize (+160mm) cobbles consist of quartzite and silcrete. Heavy minerals present associated with the gravel matrix include ilmenite and magnetite;
- floodplain deposits. These are often associated with the tributaries of the Longatshimo River. The gravels comprise a single fining upward layer with a thickness of between 0.30 and 0.45m. The well rounded pebbles are quartz, chert, jasper and agates with an average size of 20mm. Approximately 10%, by volume, is comprised of oversize of sub rounded to sub angular boulders and cobbles of silcrete and quartz. The gravels are overlain by clean white, recent sand deposits (Figure 29). Further north they are overlain by red Kalahari sand; and
- colluvial or blanket gravels. These gravels occur between the terraces in the interfluvial areas. PDF believe that they were formed as a result of a widespread deflation surface. The gravels rest on the undulating contact with the basement schists. The gravels are characterised by well rounded quartz pebbles of 20-30mm in size and reach an average thickness of 0.5m. In addition to the pebbles, there is a significant portion of large (70-100mm) angular quartzite cobbles (Figure 29). These are believed to be derived from vein quartz present in the basement gneisses.

PDF has derived the geological model from the exploration carried out within the Kamonia, Kapopo and Kajama Project Areas. The extent of the various gravel horizons is discussed in detail in the relevant section for each respective project area.

## 11 LONGATSHIMO RIVER PROJECT – KAPOPO PROJECT AREA

The Kapopo Project Area is the most advanced with respect to exploration within the Longatshimo River Project. Exploration within Kapopo commenced in July 2006.

### 11.1 Exploration

The exploration method utilised for the DRC projects, and Kapopo in particular, involves the following systematic approach:-

- reconnaissance mapping to understand the geology of the area and to form a geological model;
- prospecting pitting to identify the types of gravels, determine their lateral extent and to test if they are diamondiferous. The treated gravels also provide an initial indication of grade;
- jimbo pitting to map the lateral and vertical extent of the gravels and overburden. The extracted gravels are treated to determine the depth and thickness of the overburden and gravel;
- mega pitting to obtain a larger gravel sample for more accurate grade determination;
- auger drilling to define the upper limit of the gravel and overburden thickness on a small grid size; and
- bulk sampling to determine the economic merits of the project through the extraction of a sufficiently large parcel of diamonds.

PDF has carried out all the above exploration on Kapopo except for the final stage of bulk sampling. This will commence upon commissioning of the plant in early 2008. The details of each type of exploration are outlined in the sections to follow.

### 11.2 Reconnaissance Mapping

PDF commenced reconnaissance mapping in July 2006. A low resolution Landsat satellite image, with contours, was purchased and used as the basis for the mapping exercise (Figure 30).

**LEGEND:**

- River
- Tributary
- Gneiss
- Mined Area
- Blanket Gravel
- Palaeo Channel Gravel
- Floodplain Gravel
- Mega Pit
- Prospecting Pit
- Auger Hole
- Jimbo Pit

**EXTENT OF GRAVELS AND SAMPLE POSITIONS FOR THE KAPOPO PROJECT AREA**

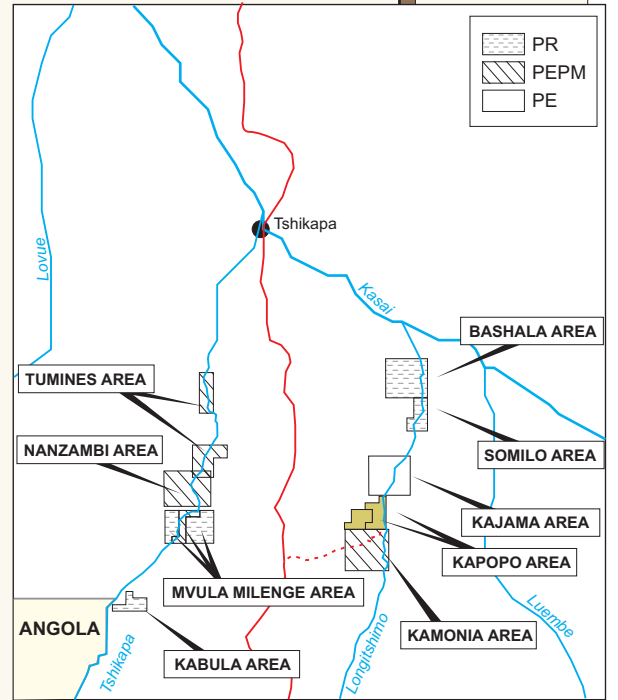
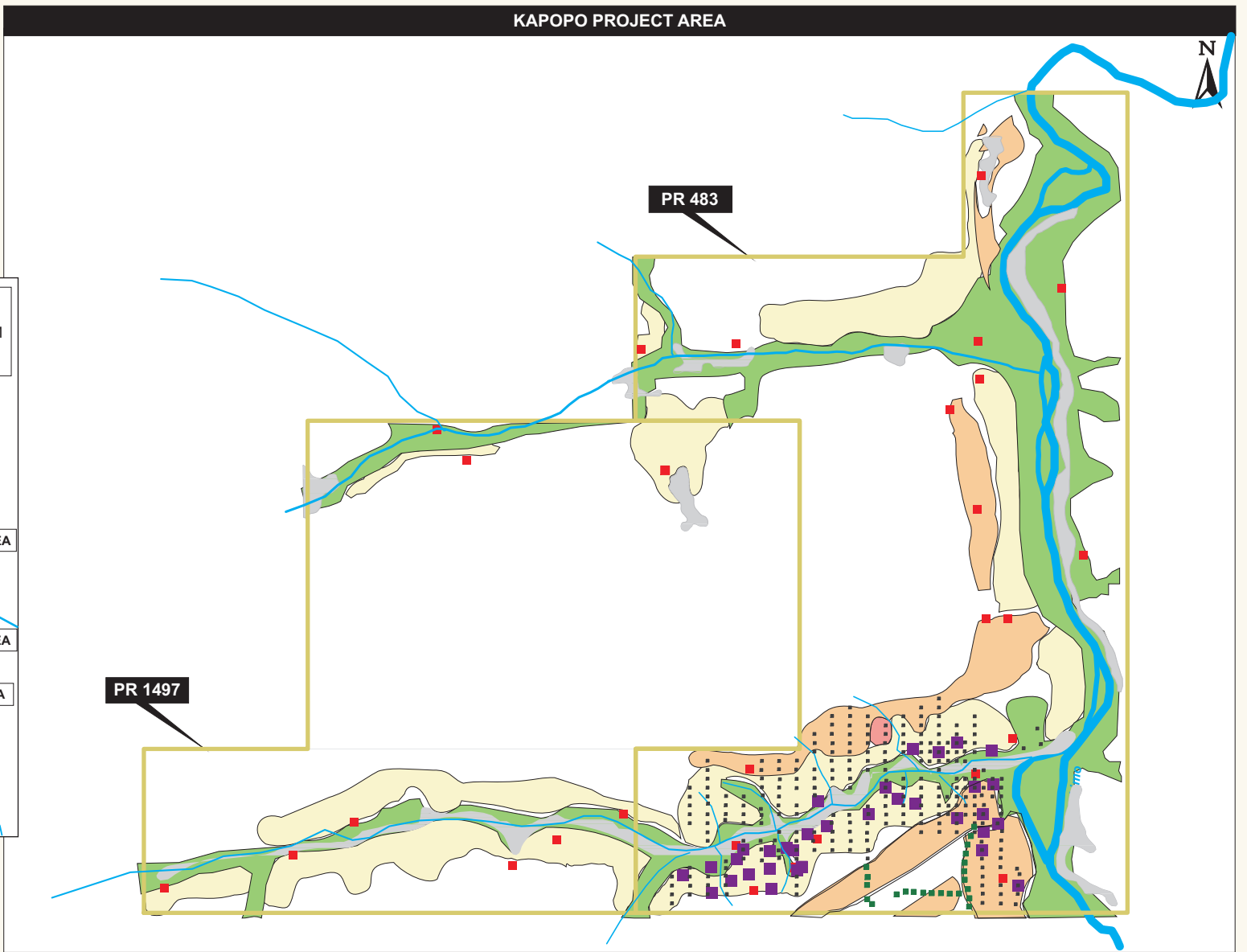

PangeaDiamondFields\TSX\07Fig30.cdr

This diagram and the information therein are copyrighted. It may not be reproduced or transmitted in any form or by any means without prior written permission from Venmyn Rand (Pty) Ltd. Trading as Venmyn.

Geological mapping was carried out on a 1:25,000 scale. The ground was traversed by suitably qualified and experienced geologists to identify the rock and gravel types and investigate all artisanal workings in the area. Particular attention was paid to defining the limits of previously mined out areas. The results were collated into a geological map of the area for both the Kapopo and Kamonia Project Areas (Figure 30).

The mapping identified the number and extent of the various gravel deposits in the area. These were initially identified as lower and upper terraces. Later exploration work has shown that the gravels should rather be divided into floodplain gravels and palaeo channel gravels. All additional results from the pitting programmes were used to maintain an updated geological map of the area.

### **11.3 Prospecting Pitting**

Prospecting pitting also commenced in July 2006 and was used to identify the various types of gravel present and whether they contained diamonds. A total of 29 pits were excavated.

#### **11.3.1 Sampling Method and Approach**

Prospecting pits were dug by hand using local labour. These pits were typically 1x2m or 2x2m in size and excavated to intersect the bedrock. Pits were sited in areas where gravel was expected to be from the mapping results. Figure 30 indicates the position of the prospecting pits within Kapopo. The pits were numbered sequentially with a PI prefix to indicate that they were prospecting pits excavated within Kapopo.

#### **11.3.2 Sample Preparation, Analyses and Security**

The gravel samples were excavated, bagged and numbered under the supervision of the geologist. The bags were not sealed. A single sample was taken for each pit. The samples were then transported, under the supervision of the geologist, to the nearest river where they were hand washed and the diamonds extracted. This was also carried out under the direct supervision of the PDF geologist.

The method of sample preparation is adequate with respect to general alluvial diamond exploration practises in extremely remote areas. As previously noted, the method of processing is not perfect both from both a recovery and a security perspective. However, this may only result in an under estimation of the grade and therefore the results are acceptable to the Qualified Person.

#### **11.3.3 Data Verification**

All results were entered into an Excel spreadsheet recording the gravel and overburden thicknesses, gravel volume, carats and number of stones recovered. The coordinates of the pits were also recorded using a GPS. The data sheets were checked and verified by the PDF geologist at their head office in South Africa. Verification included the following:-

- checking the database against the original data sheets on a random basis;
- plotting all samples position; and
- checking mathematical calculations with respect to volumes and grades.

Venmyn has not verified the data in detail but has witnessed the rigorous process of verification which PDF's headoffice geologist carries out. As a result, the Qualified Person is satisfied that the potential for any error to occur is minimised.

#### **11.3.4 Results**

The summary of results for the prospecting pitting, according to gravel type, is tabulated in Table 33.

**Table 33 : Summary Prospecting Pitting Results for Kapopo Project Area**

PIT NO.	GRAVEL TYPE	O/B THICK (m)	GRAVEL THICK (m)	GRAVEL VOLUME (m <sup>3</sup> )	CARATS	NO. STONES	GRADE (ct/100m <sup>3</sup> )	STONE SIZE (ct/stone)	BOTTOM SCREEN SIZE (mm)	
PI2	Blanket	5.20	2.00	2.00	0.35	3	17.50	0.12	1.6	
PI3	Blanket	6.10	0.90	1.20	0.00	0	0.00		1.6	
PI4	Blanket	7.00	1.50	2.00	0.00	0	0.00		1.6	
PI5	Blanket	6.00	0.80	4.00	0.65	4	16.25	0.16	1.6	
PI7	Blanket	4.70	1.00	2.00	0.10	1	5.00	0.10	1.6	
PI8	Blanket	13.00	0.50	3.00	0.15	3	5.00	0.05	1.6	
PI9	Blanket	4.50	0.45	4.00	2.50	5	62.50	0.50	1.6	
PI10	Blanket	3.50	0.70	2.00	0.01	1	0.50	0.01	1.6	
PI13	Blanket	8.70	0.80	2.50	0.50	2	20.00	0.25	1.6	
PI14	Blanket	5.00	0.50	2.00	0.03	1	1.50	0.03	1.6	
PI15	Blanket	9.00	1.00	2.00	0.25	2	12.50	0.13	1.6	
PI17	Blanket	9.50	2.70	4.00	0.00	0	0.00		1.6	
PI18	Blanket	2.50	0.30	2.00	0.02	1	1.00	0.02	1.6	
PI19	Blanket	3.20	1.15	2.00	0.00	0	0.00		1.6	
PI21	Blanket	7.20	1.10	1.50	1.00	1	66.67	1.00	1.6	
PI23	Blanket	11.00	0.70	1.50	0.00	0	0.00		1.6	
PI24	Blanket	4.00	0.60	2.00	0.00	0	0.00		1.6	
PI27	Blanket	6.00	0.50	2.00	1.00	7	50.00	0.14	1.6	
PI28	Blanket	3.20	0.40	2.00	0.00	0	0.00		1.6	
<b>TOTAL / AVE BLANKET</b>					<b>43.70</b>	<b>6.56</b>	<b>31</b>	<b>15.01</b>	<b>0.21</b>	
PI1	Floodplain	5.30	0.95	2.20	0.92	7	41.82	0.13	1.6	
PI6	Floodplain	4.00	0.80	2.00	0.65	6	32.50	0.11	1.6	
PI25	Floodplain	5.00	0.40	2.00	0.00	0	0.00		1.6	
PI29	Floodplain	4.20	0.85	2.00	1.06	3	53.00	0.35	1.6	
<b>TOTAL / AVE FLOODPLAIN</b>					<b>8.20</b>	<b>2.63</b>	<b>16</b>	<b>32.07</b>	<b>0.16</b>	
PI11	Palaeo channel	10.30	1.70	2.00	0.00	0	0.00		1.6	
PI12	Palaeo channel	7.60	1.00	2.00	0.70	3	35.00	0.23	1.6	
PI16	Palaeo channel	9.50	1.50	2.00	0.00	0	0.00		1.6	
PI20	Palaeo channel	10.20	1.30	2.00	0.00	0	0.00		1.6	
PI22	Palaeo channel	6.40	1.20	2.00	0.20	3	10.00	0.07	1.6	
PI26	Palaeo channel	9.60	3.00	3.00	0.40	3	13.33	0.13	1.6	
<b>TOTAL / AVE PALAEO CHANNEL</b>					<b>13.00</b>	<b>1.30</b>	<b>9</b>	<b>10.00</b>	<b>0.14</b>	

The gravel and overburden thickness and depth to bedrock results have been included with similar results obtained for the other types of exploration. This data was modelled in Surfer® using all data points with gravel. Details of the modelling methods are described in Section 11.10.2. The three types of gravel were modelled as a single unit as it is unlikely that they will overlap to any significant degree. Plots of the contoured gravel and overburden thicknesses are shown in relation to the gravel types in Figure 31. The summary statistics for the Surfer® modelling of the complete data set on Kapopo is located in Table 34. The gravel thickness plots clearly illustrate a trend of increasing gravel thickness away from the Longatshimo River and its tributaries. These areas of thickened gravel correspond to the palaeo channels. The overburden increases away from the rivers, which is a function of topographic controls.

**Table 34 : Summary Statistics for Kapopo Modelling**

GRAVEL TYPE	NO. DATA POINTS	GRAVEL THICKNESS (m)			OVERBURDEN THICKNESS (m)		
		MIN	MAX	MEAN	MIN	MAX	MEAN
Blanket	183	0.1	2.0	0.8	1.3	13.0	6.3
Floodplain	42	0.2	1.0	0.6	3.1	8.3	3.3
Palaeo channel	106	0.3	3.0	1.9	3.2	10.3	6.8
<b>TOTAL</b>	<b>331</b>						

A total of 10.49cts were recovered from the prospecting pits which were used in the resource modelling. The various stone sizes obtained are shown in Table 33.

**CONTOUR PLOT OF GRAVEL AND OVERBURDEN THICKNESSES FOR THE KAPOPO PROJECT AREA**

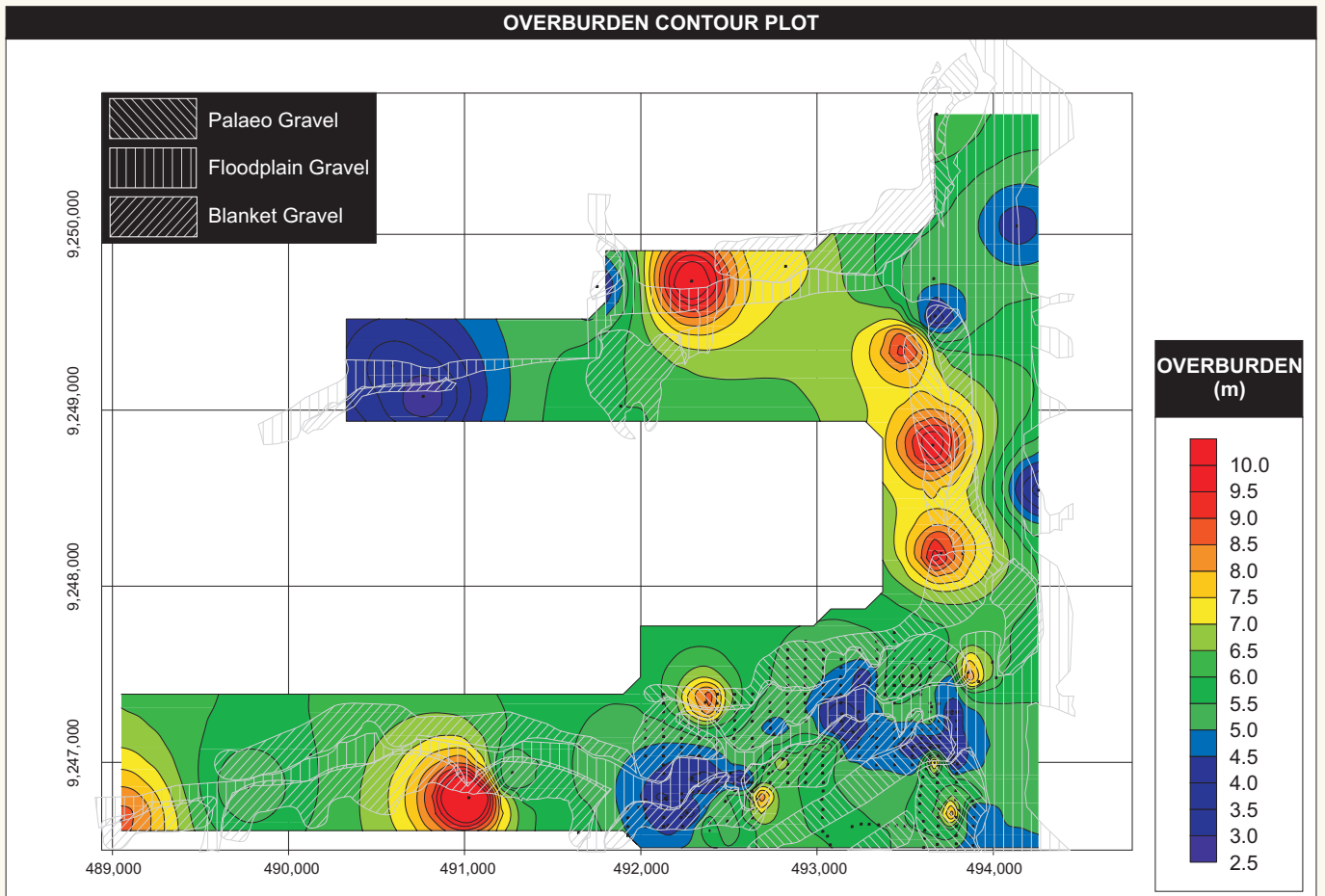
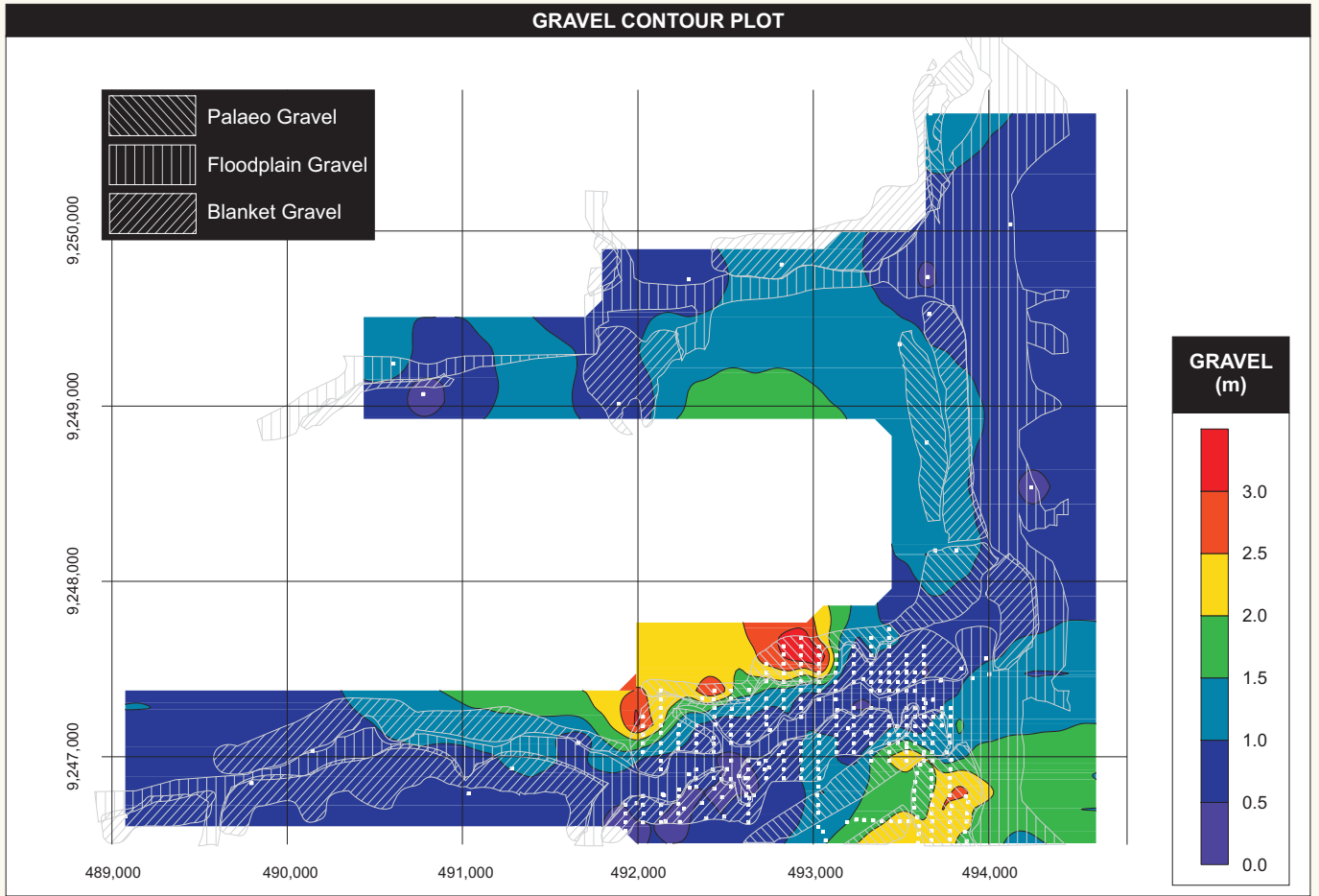

## 11.4 Jimbo Pitting

PDF commenced with jimbo pitting in the Kapopo Project Area in March 2007 (Figure 32). This is a highly effective means of exploration as the process is quick and the results are accurate with respect to the gravel and overburden thicknesses and also with respect to the identification of the gravel type. A total of 191 jimbo pits had been excavated to December 2007. This method of exploration is still ongoing.

### 11.4.1 Sampling Method and Approach

Jimbo pits were excavated by hand using local labour. These pits were circular with a 1m diameter and excavated to the bedrock (Figure 32). The pits were sited at regular 50m intervals on north/south lines laid out 100m apart to form a grid (Figure 30). For safety reasons pits were not dug deeper than 10m. Any pits, for which the gravel has not been intersected at this depth, were abandoned.

The jimbo pits were named alphanumerically with 'T' as a prefix. All material excavated from the pit was laid out in piles according to type. Detailed measurements were made of the overburden and gravel thicknesses and depth to the bedrock.

### 11.4.2 Sample Preparation, Analyses and Security

No samples were taken from the jimbo pits.

### 11.4.3 Data Verification

All results were entered into an Excel spreadsheet which was verified by PDF's head office staff on a regular basis. The verification method is described in Section 11.3.3.

### 11.4.4 Results

The results of the jimbo pitting with respect to gravel and overburden thicknesses are included with the other exploration results and illustrated as contour plots in Figure 31. The summary results by gravel type are tabulated in Table 35. Out of the 191 pits, 16 did not intersect gravel within PDF's safety specification depth for jimbo pits.

**Table 35 : Summary Jimbo Pitting Results for Kapopo Project Area**

GRAVEL TYPE	NO. OF PITS	AVE O/B THICK (m)	AVE GRAVEL THICK (m)
Blanket	109	4.81	0.91
Floodplain	17	2.79	0.86
Palaeo Channel	49	5.07	2.14
No gravel	16		
<b>TOTAL</b>	<b>191</b>		

Jimbo results indicate that the palaeo channels have the thickest gravels, over 2m. The blanket and floodplain gravels average less than 1m as would be expected from the geological processes related to their formation. These results are also included in the Surfer® modelling illustrated in Figure 31.

## 11.5 Mega Pitting

The first three mega pits were dug in 2006 by the local artisanal miners and the results obtained by PDF. In 2007 PDF commenced with its own mega pitting programme. A total of 36 mega pits had been excavated by December 2007 as indicated on Figure 30. Mega pits were excavated in order to obtain a larger sample size for reliable grade estimation. They also provide detailed information on gravel and overburden thicknesses and the type of gravel intersected.

### 11.5.1 Sampling Method and Approach

The mega pits were typically 4x4m in size and sited according to data obtained from jimbo pits including bedrock profiles and gravels types. The mega pits were also sited near old workings, by Forminere and local people, which provide a positive indication of areas with high grade. These hand dug pits were numbered sequentially with an alphabetical prefix to indicate who was responsible for its excavation.

**PHOTOGRAPHS OF EXPLORATION AND SAMPLING TECHNIQUES**

**SAMPLE PROCESSING AREA**



**INITIAL SCRUBBING AND CLASSIFYING**



**BOESMAN JIG**



**CONCENTRATE OF VARIOUS SIZE FRACTIONS READY FOR FINAL RECOVERY**



**SAMPLE BAGS AND NUMBER**



**FINAL RECOVERY ON SORTING TABLE**



**TRACER AND DIAMOND**

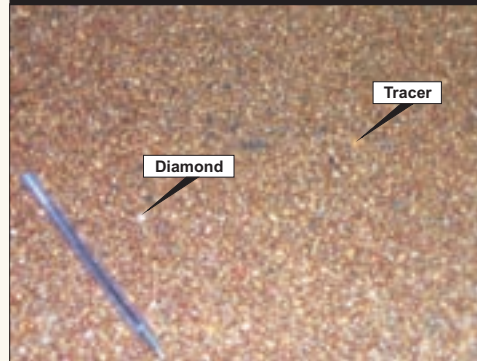

**DIAMOND WEIGHING**



**JIMBO PIT**



**AUGER HOLE (TT17)**



Source: Venmyn

This diagram and the information herein is copyrighted. It may not be reproduced or transmitted in any form or by any means without prior written permission from Venmyn Rand (Pty) Ltd. Trading as Venmyn.

PangeaDFieldsTSX'07Fig32.cdr



All pits were excavated to intersect bedrock. The bedrock and any large boulders, which were too large to be removed, were carefully swept to ensure that all potentially diamondiferous material was recovered.

### 11.5.2 Sample Preparation, Analyses and Security

All gravels were extracted, bagged and numbered under the scrutiny of the PDF site geologist. The bags were not sealed. Where multiple gravel layers were intersected, these were sampled separately. The samples were numbered according to the pit number with a sequential alphabetical suffix indicating multiple samples from the same pit. For example MNS1A and MNS1B indicates multiple samples with A being the upper layer.

The samples were then transported to the processing area by the geologist. The delivered bags were labelled to ensure no samples were mixed. The gravel was fed into a classifier along with water. The classifier removed the -1.6mm fraction and the oversize (+16mm). The remaining material entered the Boesman jig where it was sorted into four screens of +1.6mm – 3.4mm in size (Figure 32).

The jiggling process concentrated the dense particles, including the diamonds, at the base of each screen towards the centre. Each screen was then removed and overturned onto a sorting table for final diamond recovery (Figure 32).

PDF used tracers to ensure that the process was working efficiently. Also, all the remaining concentrates were rewashed in the nearby river, by hand, to ensure that no diamonds had been missed. The process was closely supervised by PDF staff although the area is not secured by way of fencing. After each sample was processed the jig and associated equipment was cleaned with water to ensure no contamination occurred. All diamonds recovered were weighed individually on a daily basis (Figure 32).

As noted previously, the method of sample preparation is adequate. The method of processing is not perfect both from both a recovery and a security perspective. However, this may only result in an under estimation of the grade and therefore the results are acceptable to the Qualified Person. The fact that PDF utilises tracers on a regular basis and rewashes the gravels increases the confidence in the result of the recovery.

### 11.5.3 Data Verification

The results were recorded into a database which was verified by PDF's head office staff. Verification included the following:-

- checking the database against the original data sheets on a random basis;
- plotting all samples position; and
- checking mathematical calculations with respect to volumes and grades.

Venmyn has not verified the data in detail but has witnessed the rigorous process of verification which PDF's headoffice geologist carries out. As a result, the Qualified Person is satisfied that the potential for any error to occur is minimised.

### 11.5.4 Results

The mega pitting results are tabulated in Table 36. A total of 59.21ct was recovered from the mega pitting exercise. The average stone size is shown in Table 36 and varies from 0.21ct/stone for the sheet deposits to 0.37ct/stone for the channels.

Table 36 : Summary Mega Pitting Results for Kapopo Project Area

PIT NO	GRAVEL TYPE	O/B THICK (m)	GRAVEL THICK (m)	GRAVEL VOLUME (m3)	CARATS	NO STONES	GRADE (ct/100m3)	STONE SIZE (ct/stone)	BOTTOM SCREEN SIZE (mm)	
MPI-3	Blanket		0.55	9.00	0.57	5	6.33	0.11	1.6	
SH3	Blanket	4.10	0.26	2.54	1.35	5	53.15	0.27	1.6	
SH4	Blanket	10.10	N/A	N/A	N/A	N/A	N/A	N/A	1.6	
SH8	Blanket	2.92	1.25	6.81	0.00	0	0.00	0.00	1.6	
SH10	Blanket	3.68	0.60	8.15	0.00	0	0.00	0.00	1.6	
SH11	Blanket	6.80	0.16	2.40	0.00	0	0.00	0.00	1.6	
SH12	Blanket	7.35	0.61	5.17	1.00	3	19.34	0.33	1.6	
SH13	Blanket	5.91	0.28	2.80	0.41	3	14.64	0.14	1.6	
SH14	Blanket	4.31	0.29	3.11	0.07	1	2.25	0.07	1.6	
SH15	Blanket	N/A	N/A	N/A	N/A	N/A	N/A	N/A	N/A	
SH17	Blanket	5.43	0.60	5.08	2.44	12	48.03	0.31	1.6	
SH18	Blanket	4.82	0.23	3.12	0.06	1	1.92	0.06	1.6	
SH19	Blanket	3.20	0.47	5.15	1.53	4	29.71	0.38	1.6	
MNS1	Blanket	3.95	0.50	6.28	2.52	7	40.13	0.36	1.6	
MNS2	Blanket	4.90	0.30	4.81	0.87	2	18.09	0.44	1.6	
MNS5	Blanket	3.70	0.13	1.11	0.00	0	0.00	0.00	1.6	
MTX5	Blanket	6.20	0.86	34.76	1.42	9	4.09	0.16	1.6	
MTE1	Blanket	2.10	0.40	50.00	0.83	5	1.66	0.17	1.6	
MTF9	Blanket	6.77	1.54	12.24	0.20	3	1.63	0.07	1.6	
MTR13	Blanket	1.10	1.60	23.23	3.12	15	13.43	0.21	1.6	
MTI8	Blanket	4.15	1.00	10.44	0.46	5	4.41	0.09	1.6	
MTY6	Blanket	6.53	0.53	3.49	0.83	3	23.78	0.28	1.6	
MJ1	Blanket	4.55	1.60	3.03	0.16	1	5.28	0.16	1.6	
<b>TOTAL / AVE BLANKET</b>					<b>202.72</b>	<b>17.84</b>	<b>84</b>	<b>8.80</b>	<b>0.21</b>	
MPI-1	Floodplain		0.25	13.20	18.17	66	137.65	0.28	1.6	
MPI-2	Floodplain		0.50	5.00	1.31	12	26.20	0.11	1.6	
SH1	Floodplain	8.30	0.30	1.61	0.00	0	0.00	0.00	1.6	
SH2	Floodplain	3.31	0.20	3.73	0.93	5	24.93	0.19	1.6	
MTT15	Floodplain	3.98	0.80	22.88	5.33	27	23.30	0.20	1.6	
<b>TOTAL / AVE FLOODPLAIN</b>					<b>46.42</b>	<b>25.74</b>	<b>110</b>	<b>55.45</b>	<b>0.23</b>	
MNS3	Palaeo channel	3.22	0.31	5.86	0.78	3	13.31	0.26	1.6	
MNS4	Palaeo channel	5.35	0.83	6.77	0.51	4	7.53	0.13	1.6	
MNS6	Palaeo channel	8.80	1.10	0.00	0.00	0	0.00	0.00	1.6	
MNS7	Palaeo channel	3.18	1.62	11.26	0.62	4	5.51	0.16	1.6	
MTM9	Palaeo channel	3.68	0.76	17.54	11.38	27	64.88	0.42	1.6	
MAA17	Palaeo channel	3.20	0.98	6.69	0.07	1	1.05	0.07	1.6	
MTB10	Palaeo channel	2.57	0.66	6.83	3.05	7	44.66	0.44	1.6	
MTM13	Palaeo channel	5.77	1.50	1.37	0.00	0	0.00	0.00	1.6	
<b>TOTAL / AVE PALAEO CHANNEL</b>					<b>50.46</b>	<b>15.63</b>	<b>43</b>	<b>30.98</b>	<b>0.36</b>	

## 11.6 Auger Drilling

Due to the soft nature of the sediments in central Africa, auger drilling was used effectively to obtain detailed information on the presence and depth of the gravel. PDF had drilled a total of 25 auger holes in the Kapopo Project Area between October and December 2007. This exploration is ongoing.

### 11.6.1 Sampling Method and Approach

Drilling was carried out on 2 north-south lines (N1 and N2) stretching from the Kapopa in the Kapopo concession southwards to the Congolo in the Kamonia concession and 3 east-west lines (E1, E2, E3) connecting the north-south lines. Two of the east-west lines are in Kamonia and only one in Kapopo. The drilling utilised a specially designed 140mm diameter auger mounted onto a Massey Ferguson 440 tractor. Vertical holes were drilled at 50m spacings along selected drill lines. Auger drill rods were available to drill to a maximum depth of 20m. The auger was capable of drilling 100m per day, making this a time and cost effective means of exploration. This auger cannot penetrate hard rock or gravel and, as a result, only the depth to the top of the gravel or bedrock is measured in each hole. This provides an indication of the stripping ratio.

Holes are numbered sequentially with a prefix to indicate the direction and number of the drill line, eg. N1-39.

#### 11.6.2 Sample Preparation, Analyses and Security

No samples were taken from the auger holes.

#### 11.6.3 Data Verification

Measurements were entered into an Excel database by the local geologist on site and then verified by both PDF's expatriate and head office geologists. The database entries were checked with the original auger logging sheets on a random basis.

#### 11.6.4 Results

The results of the drilling were included into the database of information obtained from the various exploration methods for the entire project area. The results pertaining to the depth of the gravel (i.e. overburden thickness) is illustrated in (Figure 31) and tabulated in Table 37.

**Table 37 : Summary of Auger Drilling Results for Kapopo Project Area**

GRAVEL TYPE	NO. OF PITS	AVE O/B THICK (m)
Blanket	6	10.08
Floodplain	0	
Palaeo Channel	19	9.01
<b>TOTAL</b>	<b>25</b>	

#### 11.7 Bulk Sampling

No bulk sampling has been carried out in the Kapopo Project Area.

#### 11.8 Adjacent Properties

Relevant information pertaining to the adjacent properties is discussed in the sections to follow as they are also held by PDF.

#### 11.9 Mineral Processing and Metallurgical Testing

No mineral processing has occurred at Kapopo to date. A mobile process plant has arrived on site and is currently being commissioned.

The process plant is a 20tph DMS with a 120tph scrubber at the front end (Figure 33). All +150mm material will be scalped off at the tipping bin grizzly. The -150mm material will pass through a scrubber and the -1.6mm material will be removed to slime. The +32mm size fraction will be scalped off at the scrubber. The +1.6mm – 32mm fraction will pass over a vibrating screen to separate the material into a small size fraction (+1.6mm – 12.0mm) and large size fraction (+12.0mm – 32.0mm). The small and large fractions will pass through the DMS separately.

The DMS concentrate will move via a tube conveyor into the containerised final recovery unit. The material is then classified into four size fractions prior to passing over the GB400 automatic grease belt for the final recovery stage. All recovered diamonds will be weighed and recorded into a diamond inventory.

#### 11.10 Diamond Resource and Diamond Reserve Estimates

##### 11.10.1 Previous Resource Statements

A Diamond Resource statement was issued for the Longatshimo River Project, which included the Kapopo Project Area, on 1<sup>st</sup> May 2006 (Table 38). This was prepared by PDF's Qualified Person, Ms Helen Pein, and independently verified by Venmyn's Qualified Person, Ms Catherine Telfer.

**SCHEMATIC FLOWSHEET FOR LONGATSHIMO RIVER PROJECT PLANT**

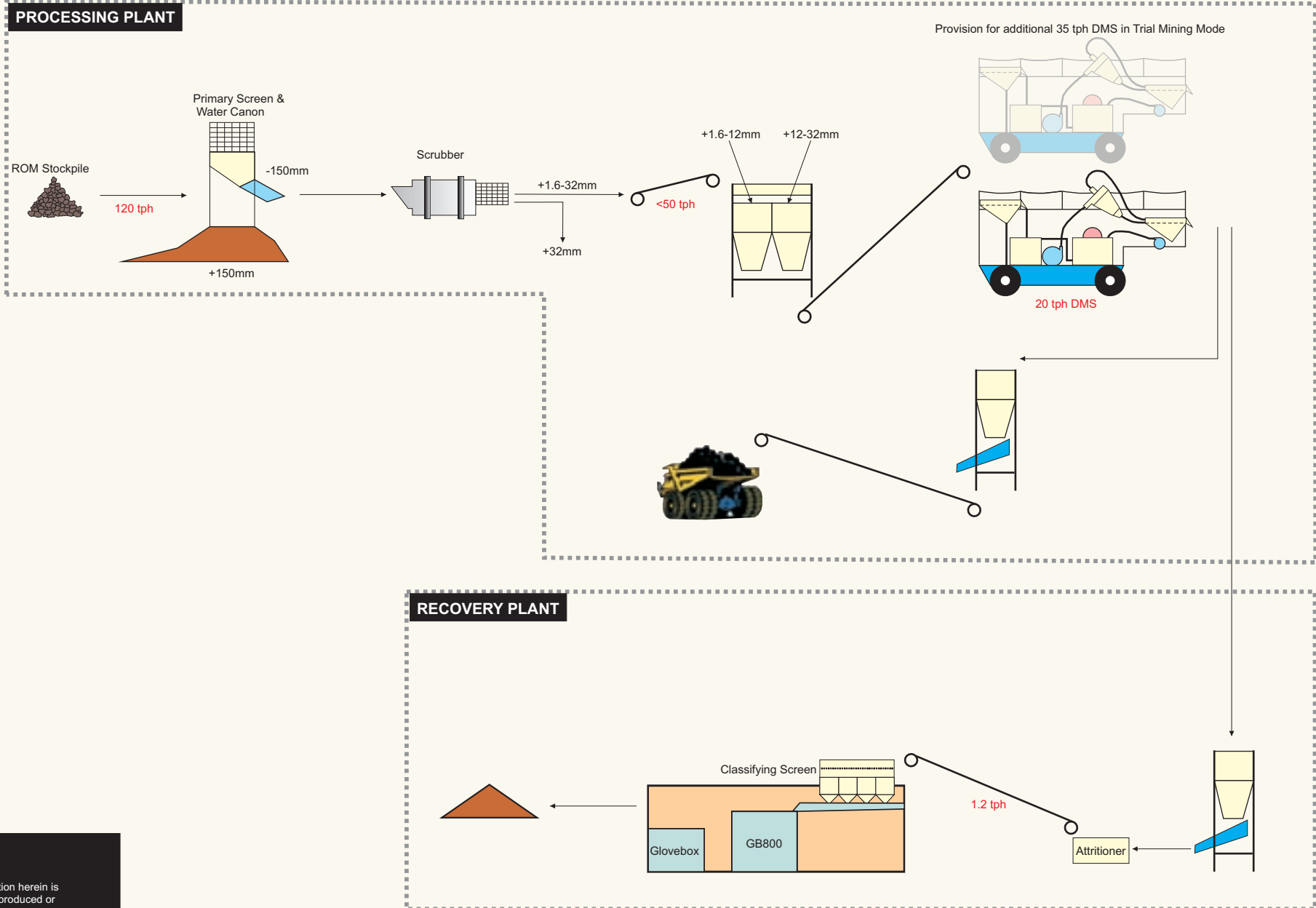

Source: Venmyn

This diagram and the information herein is copyrighted. It may not be reproduced or transmitted in any form or by any means without prior written permission from Venmyn Rand (Pty) Ltd. Trading as Venmyn.

PangeaDFieldsTSX'07Fig33.cdr

**Table 38 : Previous Resource Statement for Longatshimo River Project (1st May 2006)**

MINE / PROJECT	PROJECT AREA	RESOURCE CLASSIFICATION	GRAVEL VOLUME (m <sup>3</sup> )	GRADE (ct/100m <sup>3</sup> )	CARATS	DIAMOND VALUE (US\$/ct)	BOTTOM SCREEN SIZE (mm)
Longatshimo River	Kapopo	Inferred	6,814,000	41.00	2,793,740	150.00	1.6
	Kamonia	Inferred	5,944,000	101.00	6,003,440	150.00	1.6
<b>GRAND TOTAL / AVE INFERRED RESOURCES</b>			<b>12,758,000</b>	<b>68.95</b>	<b>8,797,180</b>	<b>150.00</b>	<b>1.6</b>

This statement has subsequently been updated using the latest exploration results as described in the sections to follow.

### 11.10.2 Volume

The volume of the resources was estimated using the database of gravel thickness. This parameter was modelled using Surfer®, a geological contouring computer software package, using the inverse distance squared method of estimation. All datapoints were utilised in the estimation process. The volume pertaining to each of the gravel types was modelled and estimated separately. The resulting volumes are tabulated in Table 39.

**Table 39 : Volume Estimation for Kapopo Project Area**

MINE / PROJECT	PROJECT AREA	GRAVEL TYPE	GRAVEL VOLUME (m <sup>3</sup> )
Longatshimo River	Kapopo	Blanket	2,247,163
		Floodplain	1,897,997
		Palaeo channel	2,108,017
<b>TOTAL / AVE KAPOPO PROJECT AREA</b>			<b>6,253,177</b>

### 11.10.3 Density

No density measurements are required as all resources are quoted in volumes.

### 11.10.4 Grade

The grade has been calculated per gravel type as a weighted average of all the pits which lie within the defined resource area included above in the volume calculation. The grades are summarised in Table 40.

**Table 40 : Grade Calculation for Kapopo Project Area**

MINE / PROJECT	PROJECT AREA	GRAVEL TYPE	REC. GRADE (ct/100m <sup>3</sup> )	CARATS
Longatshimo River	Kapopo	Blanket	11.90	267,412
		Floodplain	51.90	985,060
		Palaeo channel	24.30	512,248
<b>TOTAL / AVE KAPOPO PROJECT AREA</b>			<b>28.22</b>	<b>1,764,721</b>

### 11.10.5 Diamond Value

By December 2007, a total of 175cts were produced from both the Kapopo and Kamonia Project Areas. These stones have not been sold as the size of the parcel is too small. A parcel of approximately 2,000cts would produce a more reliable result. A total of 81% of these diamonds are less than 1ct in size, whilst the remaining 19% occur in the size range of between 1ct and 5cts. No diamonds greater than 5cts in size had been recovered by December 2007.

In order to estimate a diamond value for the mineral resource statement for the Kapopo Project Area, we have utilised the results obtained from the nearby Tshikapa River Project. A total of 110cts recovered from the Tshikapa River, were independently valued by a licensed diamond buyer in Kinshasa, DRC, in December 2007. The average price for the parcel is shown in Table 41. This diamond price was utilised for the Longatshimo River Projects.

**Table 41 : Average Diamond Price for Tshikapa River Project**

MINE / PROJECT	DATE	CARATS	TOTAL VALUE (US\$)	AVE VALUE (US\$/ct)
Tshikapa River	December 2007	110	19,800	180

In addition, historical records state that approximately 65% of the diamonds produced from the Tshikapa Diamond Field are of gem quality. Unpublished reports from 2001 state the diamonds from the southern reaches of the diamond field consistently sell for US\$180/ct, while those from the northern parts sell for between US\$60/ct and US\$80/ct.

Therefore, the estimated diamond price used in the resource statement for both the Longatshimo and Tshikapa River Projects is US\$180/ct.

#### 11.10.6 Current Resource Statement

The Diamond Resource statement for the Kapopo Project Area, dated 1<sup>st</sup> March 2008, was prepared by Ms Helen Pein. This was independently verified by Ms Catherine Telfer of Venmyn by checking the input parameters, the calculation mathematics and the logic of the classification. The statement for the Longatshimo Project, including the Kapopo Project Area is shown in Table 42.

**Table 42 : Diamond Resource Statement for the Longatshimo Project (1<sup>st</sup> March 2008)**

MINE / PROJECT	PROJECT AREA	RESOURCE CLASSIFICATION	GRAVEL VOLUME (m <sup>3</sup> )	REC. GRADE (ct/100m <sup>3</sup> )	CARATS	DIAMOND VALUE (US\$/ct)	BOTTOM SCREEN SIZE (mm)
Longatshimo River	Kapopo	Inferred	6,253,000	28.22	1,764,671	180	1.6
	Kamonia	Inferred	9,399,000	35.13	3,301,681	180	1.6
<b>GRAND TOTAL / AVE INFERRED RESOURCES</b>			<b>15,652,000</b>	<b>32.37</b>	<b>5,066,352</b>	<b>180</b>	<b>1.6</b>

All diamond resources were classified as Inferred due to the low confidence associated with the grade and the lack of a sufficiently large parcel sold in today's market. The logic used in the classification is tabulated in Appendix 3. The location of the Diamond Resources, in relation to the project area, is illustrated in Figure 34.

There are no known items relating to the environment, permits, legal, title, taxation, socio-economic, marketing, political or any other issue that would have a material effect on the resources identified in the current Diamond Resource statement.

#### 11.11 Other Relevant Data and Information

A Preliminary Assessment, including an economic analysis, of the Longatshimo Project (including the Kapopo and Kamonia Project Areas) has been carried out by PDF. It was based upon Inferred Resources and is preliminary in nature. Inferred Resources are considered too speculative to have mining and economic considerations applied to them in order to be converted to Mineral Reserves. There is no certainty that the production and economic forecasts contained in the Preliminary Assessment will be realised.

The results of the preliminary assessment are summarised in Table 43. Venmyn has independently verified the input parameters for the preliminary assessment. We have found them to be fair and reasonable in light of the Dimbi Resources Statement (Table 42), PDF's operating experience and Venmyn's knowledge base of similar operations.

**Table 43 : Preliminary Assessment at First Stage of Commercial Mining for Longatshimo River Project**

ITEM	UNITS	AMOUNT	DEFINITIONS & NOTES	ASSUMPTIONS
Capital	USD' M	11.50	Includes capital for Bulk Sampling phase (USD3.5 M) already spent plus Pilot Mining phase.	Includes a 40% of value charge for freight on all capital equipment.
Plant headfeed	m <sup>3</sup> /mth	40,000	Run of mine gravel fed to plant front-end at steady state operations.	Plant (3x scrubber @ 150m <sup>3</sup> /hr; 2x 20tph DMS @ 20m <sup>3</sup> /hr; 2x 30tph DMS @ 34m <sup>3</sup> /hr; 1x Flowsort @ 0.5m <sup>3</sup> /hr), 3 shifts per day, 50% mining efficiency and 90% plant efficiency.

ITEM	UNITS	AMOUNT	DEFINITIONS & NOTES	ASSUMPTIONS
Grade	ct/100m <sup>3</sup>	40	Average grade of the Inferred resources = 32ct/100m <sup>3</sup> . PDF plan to identify and mine higher grade areas within the large (15.6Mm <sup>3</sup> ) volume base already identified.	High grade areas will be identified and mined from the Inferred resources.
Carats produced	cts/mth	16,000	Calculated from plant headfeed and grade.	
Operating costs	USD/m <sup>3</sup>	20	PDF has a good handle of costs from operating the Cassanguidi and Dimbi Projects in similar conditions and having operated Longatshimo River as an exploration project since 2006.	Based upon 24 days per month, 3 shifts and 40,000tpm.
Revenue per carat	USD/ct	175	Slightly lower the price obtained to mitigate price risk.	Based upon valuation of 110cts in today's market from the adjacent Tshikapa River.
Cash contribution	USD/m <sup>3</sup>	50	Calculated from grade, revenue and operating costs.	Pre-tax and depreciation and on project basis ie 100%
Cash contribution	USD' M pa	24	Calculated from plant headfeed and cash contribution by cubic metre.	
Inferred Resource	m <sup>3</sup>	3,000,000	Inferred resource of 15.6Mm <sup>3</sup> has been identified. Resource volume used is significantly less but will have a higher grade due to selection.	Identification of smaller volumes with higher average grade.
Projected life	Years	6.25	Calculated from potential resources and plant headfeed.	
Payback period	Years	0.48	Calculated from capital and cash contribution.	
Potential start		1H 2009		

### 11.12 Interpretation and Conclusions

The recent exploration has resulted in a modification to the original geological model for the DRC projects, and Kapopo in particular. Four gravel types have been identified, three of which form the focus of PDF's exploration in the area. These are namely; the palaeo channel gravels, floodplain gravels and blanket gravels.





The extensive and detailed exploration through jimbo pitting and auger drilling, within the Kapopo Project Area, has provided sufficient information on the gravel and overburden thicknesses to allow computerised modelling and a more accurate determination of volumes as compared to previously. The modelling indicates that the palaeo channel gravels are the thickest (over 2m), whilst those of the sheet deposits have an average thickness of less than 1m.

Grade information has been provided, for the various gravel types, through the prospecting and mega pitting exercises. These grade results will be verified through the bulk sampling exercise commencing in the first quarter of 2008.

An initial independent diamond valuation, indicative of today's market, has been provided for a small parcel. The bulk sampling programme will provide the carats required (at least 2,000cts) to increase confidence in the current diamond price.

The exploration results have been verified and the methods independently checked by Venmyn. We are of the opinion that the results are reliable and that the data density, quantity and quality are sufficient for the delineation of Inferred Resources for Kapopo.

**LEGEND:**

-  River
-  Tributary
-  Palaeo Gravel
-  Floodplain Gravel
-  Blanket Gravel

**LOCATION OF DIAMOND RESOURCES FOR THE KAPOPO PROJECT AREA**

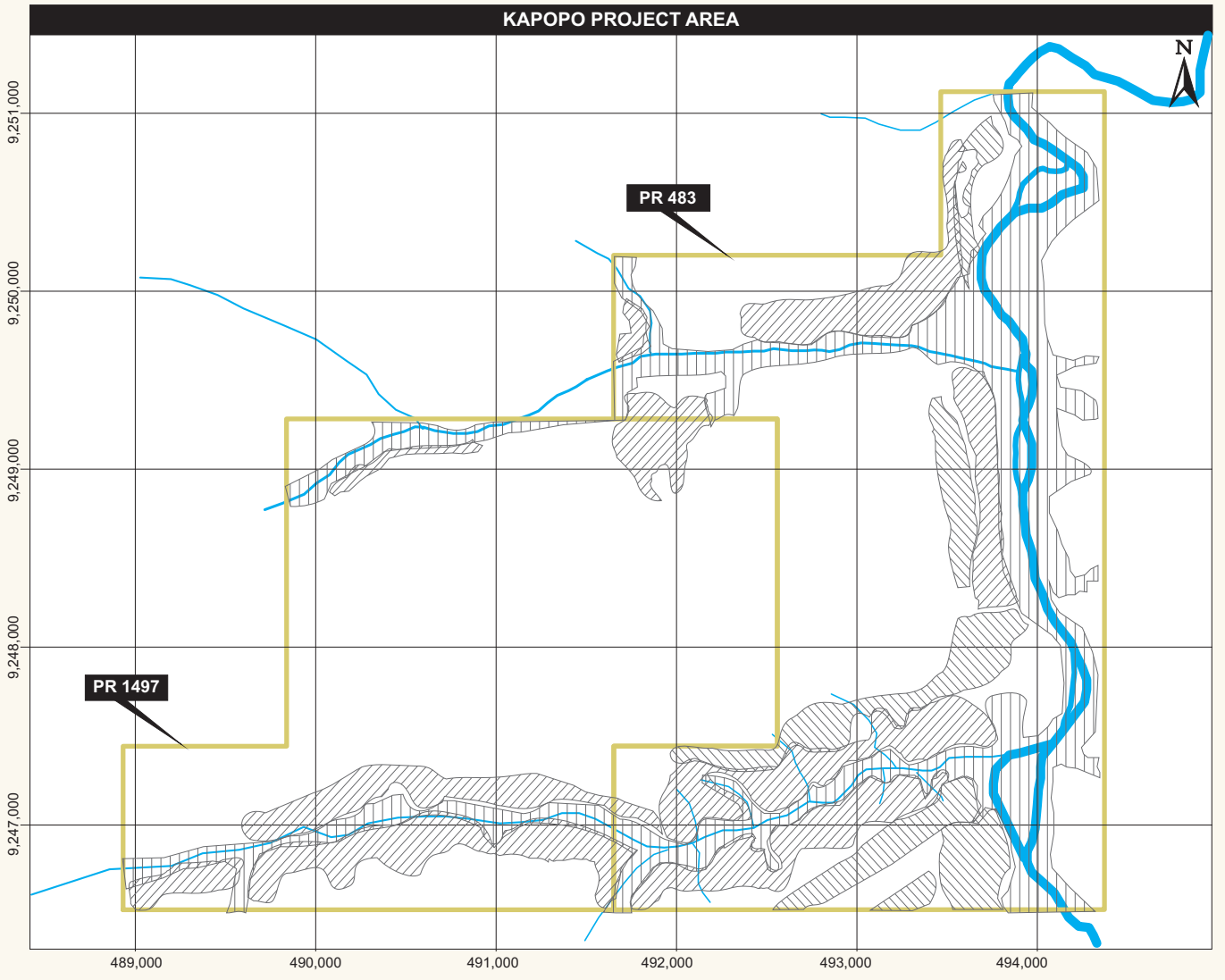
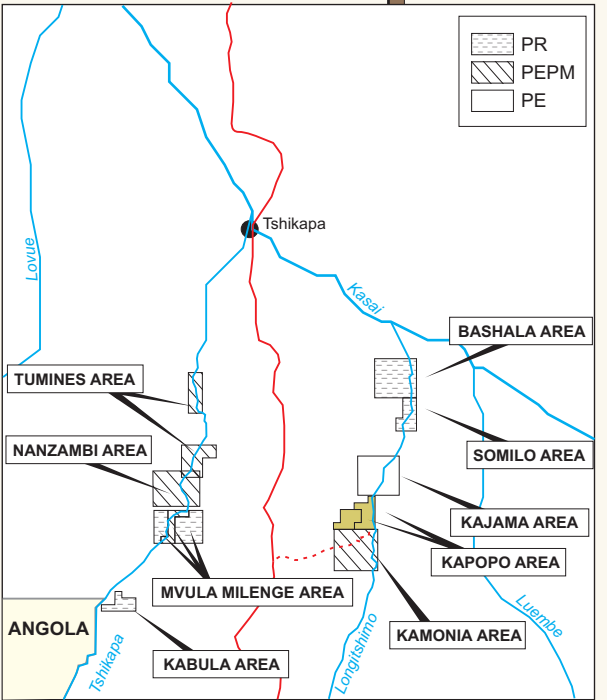

MINE / PROJECT	PROJECT AREA	GRAVEL TYPE	GRAVEL VOLUME (m <sup>3</sup> )	REC. GRADE (ct/100m <sup>3</sup> )	CARATS	DIAMOND VALUE (US\$/ct)	BOTTOM SCREEN SIZE (mm)
Longatshimo River	Kapopo	Palaeo channel	2,108,017	24.30	512,248	180	1.6
		Floodplain	1,897,997	51.90	985,060	180	1.6
		Blanket	2,247,163	11.90	267,412	180	1.6
<b>TOTAL / AVE IKULU PROJECT AREA</b>			<b>6,253,177</b>	<b>28.22</b>	<b>1,764,721</b>	<b>180</b>	<b>1.6</b>

PangeaDFieldsTSX'07Fig34.cdr

Source: Pangea

This diagram and the information therein are copyrighted. It may not be reproduced or transmitted in any form or by any means without prior written permission from Venmyn Rand (Pty) Ltd. Trading as Venmyn.



### 11.13 Recommendations

The recommended work programme for the DRC projects, including Longatshimo River Project is tabulated in Table 44. Venmyn has assisted PDF in the compilation of the work programme and budget in respect of the Longatshimo River Project and recommends that the company undertake the programme as stated therein. The expected revenues to be derived from the sale of diamonds extracted during exploration pitting, bulk sampling and pilot mining are shown in Table 45.

## 12 LONGATSHIMO RIVER PROJECT – KAMONIA PROJECT AREA

The Kamonia Project Area is situated adjacent and directly to the south of the Kapopo Project Area (Figure 24 and Figure 25).

### 12.1 Exploration

Exploration also commenced on the Kamonia Project Area in July 2006. All work was carried out using the same base camp and personnel as used on the Kapopo Project Area. The exploration method utilised was also the same as that which was applied for the Kapopo Project Area. A full description of this method is presented in Section 12.1.

PDF has carried out reconnaissance mapping, prospecting, jimbo and mega pitting as well as auger drilling on the Kamonia property. The methods and results are described in the sections to follow. Final stage bulk sampling will commence at Kamonia concurrently with the bulk sampling on Kapopo. This is scheduled to be carried out in the first quarter of 2008.

### 12.2 Reconnaissance Mapping

PDF commenced reconnaissance mapping in July 2006. The method that was used is described in Section 11.2. The results of the mapping exercise are illustrated on Figure 35. All additional results from the pitting programmes were used to maintain an updated geological map for the area.

### 12.3 Prospecting Pitting

Prospecting pitting commenced in July 2006 and was used to identify the various types of gravel present and whether they contained diamonds. A total of 31 prospecting pits was excavated on the Kamonia property, as indicated on Figure 35.

#### 12.3.1 Sampling Method and Approach

Prospecting pits were excavated as described in Section 11.3. The pits were numbered sequentially with a PY prefix to indicate that they were excavated on the Kamonia property. Of the 31 pits, 26 were excavated by PDF, whilst the results for the remaining five pits were purchased from the local artisanal miners.

#### 12.3.2 Sample Preparation, Analyses and Security

The same process described in Section 11.3.2 for Kapopo was utilised for Kamonia.

#### 12.3.3 Data Verification

The data verification method described in Section 11.3.3 was also used for Kamonia.

#### 12.3.4 Results

The summary of results for the prospecting pitting, according to gravel type, is tabulated in Table 46.

**Table 44 : Exploration Work Programme and Costing for all the DRC Projects**

PROJECT	ITEM	2008				2009			
		Q2 (US\$)	Q3 (US\$)	Q4 (US\$)	Q1 (US\$)	Q2 (US\$)	Q3 (US\$)	Q4 (US\$)	
Longatshimo River	Exploration Expenditure	(1,388,800)	(1,222,000)	(1,328,000)	(1,200,000)	(2,000,000)	(2,000,000)	(2,000,000)	
	Capital Expenditure	(1,705,000)	-	(3,000,000)	(3,000,000)	-	-	-	
	<b>TOTAL</b>	<b>(3,093,800)</b>	<b>(1,222,000)</b>	<b>(4,328,000)</b>	<b>(4,200,000)</b>	<b>(2,000,000)</b>	<b>(2,000,000)</b>	<b>(2,000,000)</b>	
	Activity	Mega pitting to continue; resource delineation; equipment purchase to upgrade plant; and bulk Sampling.	Mega pitting to continue; resource delineation; assess bulk sampling results; and bulk sampling to continue on other areas in project.	Mega pitting to continue; resource delineation; pilot mining in area selected; and bulk sampling to continue on other areas in Project	Mega pitting to continue; resource delineation; pilot mining; and bulk sampling to continue on other areas in project .	Mega pitting to continue; resource delineation; develop Mining Module 1 plant and equipment and commission.	Mega pitting to continue; resource delineation; Mining Module 1 to scale up to full capacity.	Mega pitting to continue outside Mining Module 1 area ; resource delineation; Mining Module 1 in full production.	
Phase	Bulk Sampling	Bulk Sampling	Pilot Mining	Pilot Mining	Mining Module 1	Mining Module 1	Mining Module 1		
Tshikapa River	Exploration Expenditure	(335,000)	(335,000)	(335,000)	(635,000)	(750,000)	(750,000)	(750,000)	
	Capital Expenditure				(4,414,000)				
	<b>TOTAL</b>	<b>(335,000)</b>	<b>(335,000)</b>	<b>(335,000)</b>	<b>(5,049,000)</b>	<b>(750,000)</b>	<b>(750,000)</b>	<b>(750,000)</b>	
	Activity	Mega pitting to continue; resource delineation. Mainly Dier Licence.	Mega pitting to continue; resource delineation. Mainly Dier Licence.	Mega pitting to continue; resource delineation; and evaluate results, Mainly Dier Licence.	Mega pitting to continue on Tumines Licence; resource delineation; plant construction; and bulk sampling.	Mega pitting to continue on Tumines Licence; resource delineation and bulk Sampling.	Bulk sampling	Bulk sampling	
Phase	Advanced Exploration	Advanced Exploration	Advanced Exploration	Advanced Exploration	Bulk Sampling	Bulk Sampling	Bulk Sampling		

Notes

Results of each phase determines whether a project moves into the subsequent phase or if it is terminated.

\* Recon - Reconnaissance

PDF required to finance all above expenditure, even though their shareholding may be less than 100%.

Exploration and capital expenditure to be funded through capital raising and revenues from diamonds mined and sold from the project.

**Table 45 : Revenue Generation for all the DRC Projects**

PROJECT	ITEM	2008				2009			
		Q2 (US\$)	Q3 (US\$)	Q4 (US\$)	Q1 (US\$)	Q2 (US\$)	Q3 (US\$)	Q4 (US\$)	
Longatshimo River	Revenue		671,000	2,400,000	2,400,000	5,000,000	5,000,000	5,000,000	
Tshikapa River	Revenue	10,000	10,000	20,000	50,000	150,000	150,000	200,000	
	<b>TOTAL</b>	<b>10,000</b>	<b>681,000</b>	<b>2,420,000</b>	<b>2,450,000</b>	<b>5,150,000</b>	<b>5,150,000</b>	<b>5,200,000</b>	

Notes

Revenue to be derived from sale of diamonds extracted from the project during exploration pitting, bulk sampling &amp; pilot mining.

Based upon grades and diamond values as per resource statement where available.

Alternatively based on projected estimates from geological evidence and experience in projects of a similar nature.

**Table 46 : Summary Prospecting Pitting Results for Kamonia Project Area**

PIT NO.	GRAVEL TYPE	OVERBURDEN THICK (m)	GRAVEL THICK (m)	GRAVEL VOLUME (m <sup>3</sup> )	CARATS	NO. STONES	GRADE (ct/100m <sup>3</sup> )	STONE SIZE (ct/stone)	BOTTOM SCREEN SIZE (mm)	
PY2	Blanket	7.60	0.70	0.55	0.15	1	27.28	0.15	1.6	
PY4	Blanket	7.45	0.70	0.55	0.00		0.00		1.6	
PY6	Blanket	15.40	3.50	2.75	0.00		0.00		1.6	
PY7	Blanket	5.00	1.00	0.79	0.00		0.00		1.6	
PY8	Blanket	8.60	0.80	0.63	0.00		0.00		1.6	
PY9	Blanket	0.00	2.50	1.96	0.00		0.00		1.6	
PY11	Blanket	9.00	1.20	0.94	3.10	3	328.92	3.10	1.6	
PY12	Blanket		1.40	1.10	0.00		0.00		1.6	
PY13	Blanket	16.30	2.10	2.00	0.00		0.00		1.6	
PY14	Blanket	7.20	1.20	0.90	0.00		0.00		1.6	
PY15	Blanket	13.90	3.30	2.59	0.35	1	13.50	0.35	1.6	
PY16	Blanket	5.00	1.50	2.00	4.25	11	212.50	4.25	1.6	
PY18	Blanket		0.37	0.50	0.00		0.00		1.6	
PY19	Blanket		0.70	2.00	0.25	1	12.50	0.25	1.6	
PY20	Blanket		0.30	2.00	0.75	1	37.50	0.75	1.6	
PY21	Blanket	4.20	1.17	1.00	0.05	1	5.00	0.05	1.6	
PY22	Blanket	20.05	1.50	1.50	0.00		0.00		1.6	
PY23	Blanket	9.80	1.00	1.00	0.05	1	5.00	0.05	1.6	
PY24	Blanket	12.65	0.85	2.00	0.00		0.00		1.6	
PY28	Blanket	3.85	0.95	2.50	1.20	3	48.00		1.6	
PY29	Blanket	15.30	0.60	2.00	0.05	1	2.50	0.05	1.6	
<b>TOTAL / AVE BLANKET</b>					<b>31.26</b>	<b>10.20</b>	<b>24</b>	<b>32.63</b>	<b>0.43</b>	
PY1	Floodplain	5.30	0.95	2.00	0.00	0	0.00		1.6	
PY3	Floodplain	5.30	0.90	0.71	1.05	3	148.54	1.05	1.6	
PY5	Floodplain	5.00	0.60	2.00	0.00		0.00		1.6	
PY10	Floodplain	4.50	1.00	2.00	0.03	1	1.50	0.03	1.6	
PY17	Floodplain	4.60	1.60	2.50	3.35	10	134.00	3.35	1.6	
PY25	Floodplain	5.74	0.30	1.50	0.00		0.00		1.6	
PY26	Floodplain	4.00	0.70	0.50	0.00		0.00		1.6	
PY27	Floodplain	0.10	1.95	3.50	0.07	1	2.00	0.07	1.6	
PY30	Floodplain	28.60	2.40	0.00			0.00		1.6	
LPY1	Floodplain	9.00	1.00	2.00	4.30	3	215.00	1.43	1.6	
<b>TOTAL / AVE FLOODPLAIN</b>					<b>16.71</b>	<b>8.80</b>	<b>18</b>	<b>52.66</b>	<b>0.49</b>	

The gravel and overburden thickness and depth to bedrock results have been included with similar results obtained for the other types of exploration. This data has been modelled in Surfer, as described in Section 11.12. Plots of the contoured gravel and overburden thicknesses are shown in Figure 36. The summary statistics for the Surfer® modelling are indicated in Table 47.

**Table 47 : Summary Statistics for Kamonia Modelling**

GRAVEL TYPE	NO. DATA POINTS	GRAVEL THICKNESS (m)			OVERBURDEN THICKNESS (m)		
		MIN	MAX	MEAN	MIN	MAX	MEAN
Blanket	24	0.3	2.5	0.8	2.2	12.8	5.7
Floodplain	40	0.4	1.6	0.9	0.2	5.7	3.8
Palaeo channel	75	1.0	3.3	2.5	1.0	16.5	8.4
<b>TOTAL</b>	<b>139</b>						

A total of 19cts was recovered from the prospecting pitting exercise. The average stone size pertaining to the various gravels is shown in Table 46.

The contour plots indicate that the gravel thicknesses of the floodplain deposits are generally low, whilst those pertaining to the palaeo channel and blanket gravels are highly variable. The overburden contours indicate a rapid increase in the far north, south and are as a result of topographic highs. A large proportion of the Longatshimo River has a wide open valley with thin overburden which would be an ideal stripping ratio for mining.

**EXTENT OF GRAVELS AND SAMPLE POSITIONS FOR THE KAMONIA PROJECT AREA**

**KAMONIA PROJECT AREA**

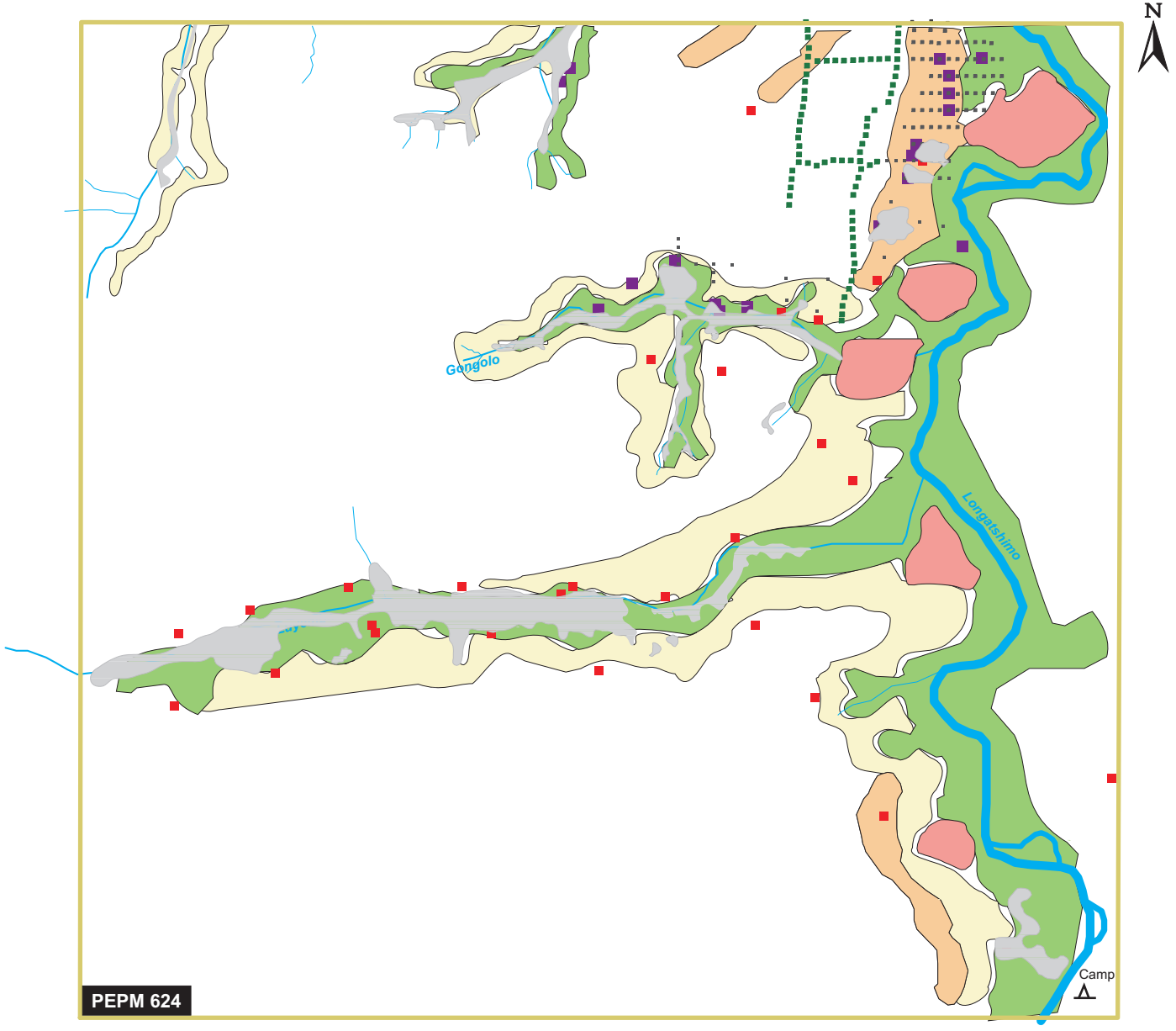

PangeaDFieldsTSX'07Fig35.cdr

Source: Pangea

**LEGEND:**

- River
- Tributary
- Gneiss
- Mined Area
- Blanket Gravel
- Palaeo Channel Gravel
- Floodplain Gravel
- Mega Pit
- Prospecting Pit
- Auger Hole
- Jimbo Pit

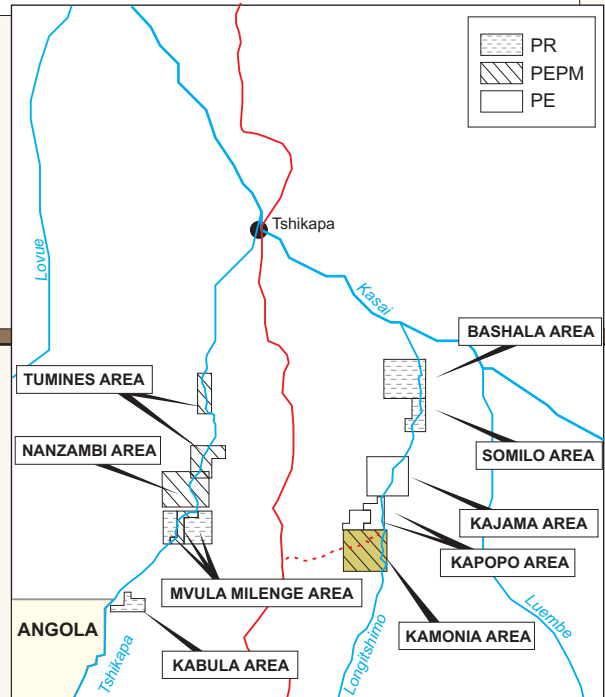

This diagram and the information therein are copyrighted. It may not be reproduced or transmitted in any form or by any means without prior written permission from Venmyn Rand (Pty) Ltd. Trading as Venmyn.

## 12.4 Jimbo Pitting

PDF commenced with jimbo pitting in the Kamonia Project Area in March 2007 (Figure 30). A total of 182 jimbo pits had been excavated to December 2007. This pitting is still ongoing.

### 12.4.1 Sampling Method and Approach

The sampling method and approach used for the jimbo pits are described in Section 11.4.1. The pits were named alphanumerically at Kamonia with either a 'T' or a 'K' prefix to indicate a jimbo.

### 12.4.2 Sample Preparation, Analyses and Security

No samples were taken from the jimbo pits.

### 12.4.3 Data Verification

As described in Section 11.4.3, all results were entered into an Excel spreadsheet which was verified by PDF's head office staff.

### 12.4.4 Results

The results of the jimbo pitting with respect to gravel and overburden thicknesses were included with the other exploration results and illustrated as contour plots in Figure 36. The summary results, by gravel type, are tabulated in Table 48.

**Table 48 : Summary Jimbo Pitting Results for Kamonia Project Area**

GRAVEL TYPE	NO. OF PITS	AVE O/B THICK (m)	AVE GRAVEL THICK (m)
Blanket	54	5.65	0.73
Floodplain	21	3.86	0.94
Palaeo Channel	79	5.29	2.36
No gravel	28		
<b>TOTAL</b>	<b>182</b>		

The average gravel thickness of the palaeo channels is significantly higher than that of the sheet deposit gravels of the blanket and floodplains. The results are very similar to those obtained for Kapopo, as would be expected.

## 12.5 Mega Pitting

PDF commenced with its mega pitting programme in early 2007. A total of 18 mega pits had been excavated by December 2007.

### 12.5.1 Sampling Method and Approach

The sampling method and approach used at Kamonia was identical to that used for Kapopo and is described in Section 11.5.1. The pits were numbered sequentially with an alphabetical prefix to indicate who was responsible for its excavation.

### 12.5.2 Sample Preparation, Analyses and Security

The sample preparation, analyses and security is commented upon in Section 11.5.2. The Boesman jig, used at Kapopo, was transported and utilised to process the samples at Kamonia.

### 12.5.3 Data Verification

Again the results were recorded into a database which was verified by PDF's head office staff, as described in Section 11.5.3.

### 12.5.4 Results

The mega pitting results are tabulated in Table 49.

**CONTOUR PLOT OF GRAVEL AND OVERBURDEN THICKNESSES FOR THE KAMONIA PROJECT AREA**

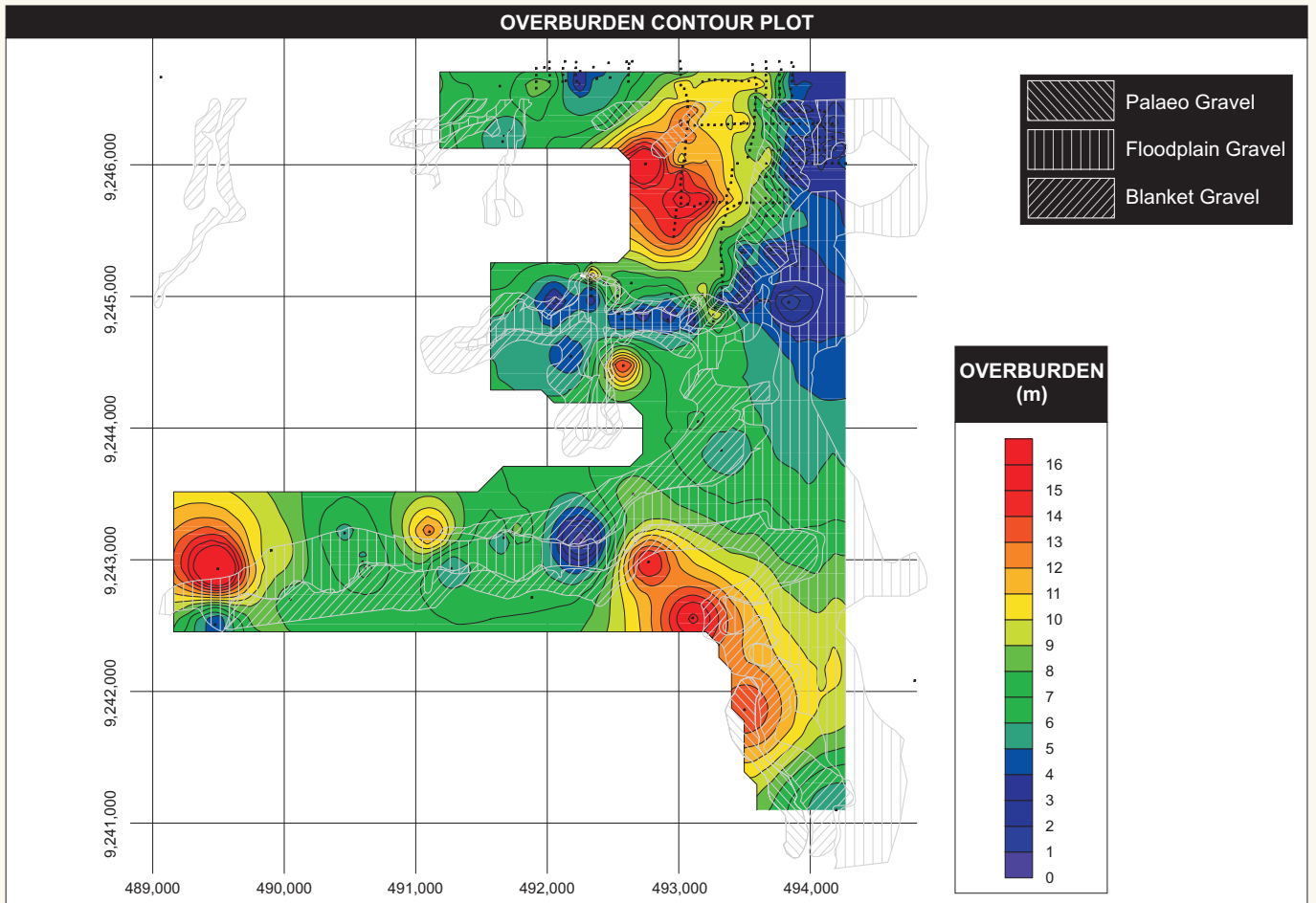
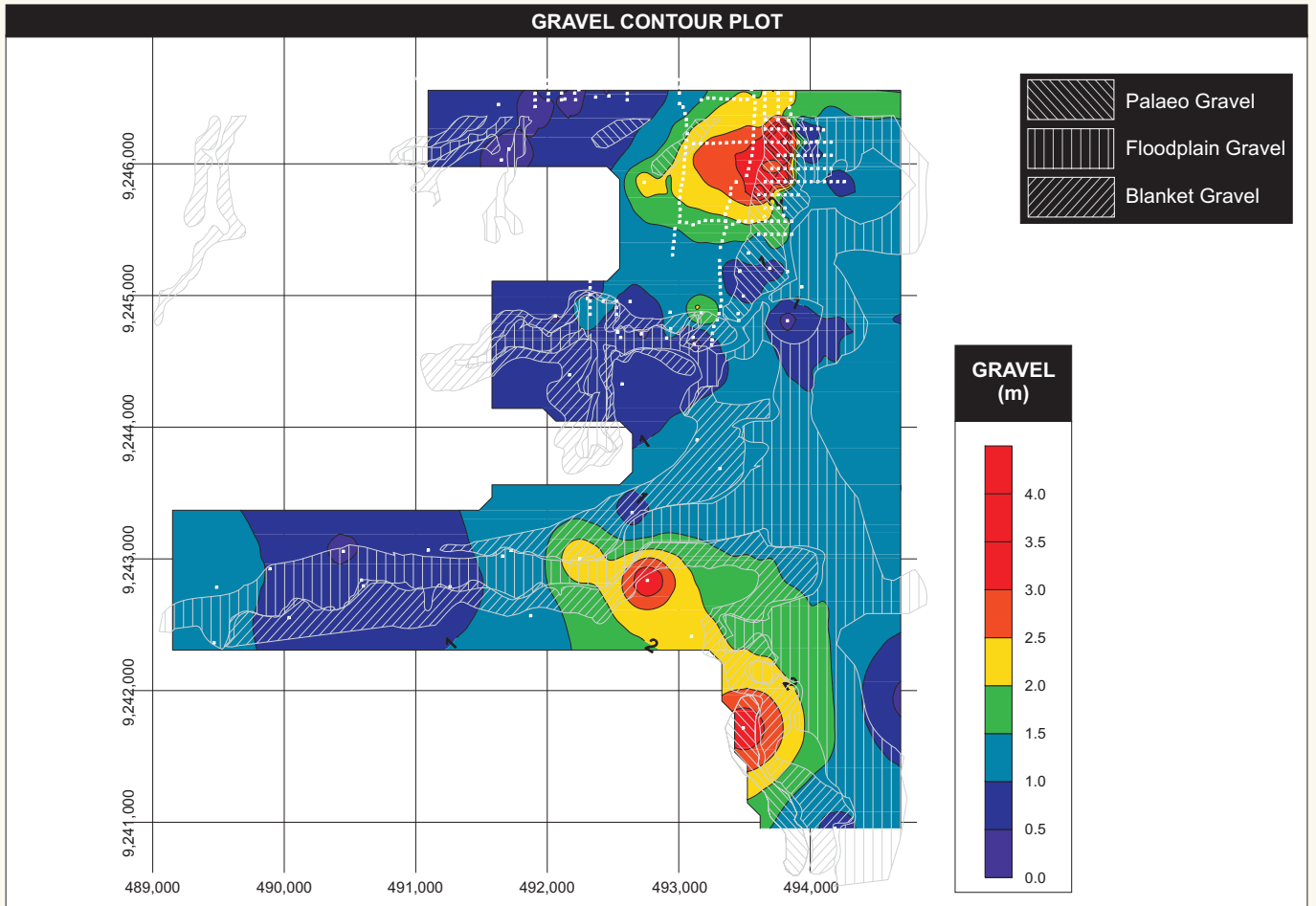

**Table 49 : Summary Mega Pitting Results for Kamonia Project Area**

PIT NO.	GRAVEL TYPE	O/BT HICK (m)	GRAVEL THICK (m)	GRAVEL VOLUME (m <sup>3</sup> )	CARATS	NO. STONES	GRADE (ct/100m <sup>3</sup> )	STONE SIZE (ct/stone)	BOTTOM SCREEN SIZE (mm)
DM5.2	Blanket	3.03	0.29	5.62	0.31	3	5.52	0.10	1.6
DM6	Blanket	3.95	0.99	7.49	1.51	2	20.16	0.76	1.6
DM7	Blanket	2.21	0.38	7.97	0.25	1	3.14	0.25	1.6
<b>TOTAL / AVE BLANKET</b>				<b>21.08</b>	<b>2.07</b>	<b>6</b>	<b>9.82</b>	<b>0.35</b>	
MNS9	Floodplain	4.86	0.40	5.61	6.70	20	119.43	0.34	1.6
MNS10	Floodplain	4.60	0.40	2.00	0.00	0	0.00	0.00	1.6
DM5	Floodplain	3.60	0.35	6.43	3.24	11	50.39	0.29	1.6
DM5.1	Floodplain	3.92	0.60	6.21	0.32	3	5.15	0.11	1.6
<b>TOTAL / AVE FLOODPLAIN</b>				<b>20.25</b>	<b>10.26</b>	<b>34</b>	<b>50.67</b>	<b>0.30</b>	
MNS8	Palaeo channel	10.90	1.30	2.39	1.57	2	65.69	0.79	1.6
DM2	Palaeo channel	2.96	1.47	22.46	3.98	8	17.72	0.50	1.6
DM3	Palaeo channel	2.74	0.66	9.47	1.03	4	10.88	0.26	1.6
DM9	Palaeo channel	5.00	1.57	6.78	0.00	0	0.00	0.00	1.6
DM10	Palaeo channel	1.68	1.09	7.19	0.00	0	0.00	0.00	1.6
DM11	Palaeo channel	5.00	1.20	3.61	0.12	1	3.32	0.12	1.6
DM12	Palaeo channel	3.70	1.14	7.53	0.41	2	5.44	0.21	1.6
MKA9A	Palaeo channel	1.00	2.10	7.30	0.08	1	1.10	0.08	1.6
MKA9B	Palaeo channel	3.10	2.70	3.26	0.15	2	4.60	0.08	1.6
MKA9C	Palaeo channel	5.50	1.60	N/A	N/A	N/A	N/A	N/A	
MKA9D	Palaeo channel	7.40	1.90	18.90	0.00	0	0.00	0.00	1.6
<b>TOTAL / AVE PALAEO CHANNEL</b>				<b>88.89</b>	<b>7.34</b>	<b>20</b>	<b>8.26</b>	<b>0.37</b>	

A total of 19.67cts were recovered from the mega pitting exercise. The average stone size is shown in Table 49 to vary between 0.08ct/stone and 0.79ct/stone.

## 12.6 Auger Drilling

PDF had drilled a total of 74 auger holes in the Kamonia Project Area between October and December 2007. This exploration is ongoing.

### 12.6.1 Sampling Method and Approach

The sampling method and approach is the same as that utilised for Kapopo and is described in Section 11.6.1. The same numbering system is used for Kamonia.

### 12.6.2 Sample Preparation, Analyses and Security

No samples were taken from the auger holes.

### 12.6.3 Data Verification

As described in Section 11.6.3, measurements were entered into an Excel database by the local geologist on site and then verified by both PDF's expatriate and head office geologists.

### 12.6.4 Results

The results for the auger drilling are shown in Table 50. The results of the drilling are included into the database of information obtained from the various exploration methods for the entire project area. The results pertaining to the depth of the gravel (i.e. overburden thickness) are illustrated in Figure 36.

**Table 50 : Summary of Auger Drilling Results for Kamonia Project Area**

GRAVEL TYPE	NO. OF PITS	AVE O/B THICK (m)
Blanket	40	12.93
Floodplain	0	
Palaeo Channel	34	9.34
<b>TOTAL</b>	<b>74</b>	

## 12.7 Bulk Sampling

No bulk sampling has been carried out in the Kamonia Project Area.

## 12.8 Adjacent Properties

Relevant information pertaining to the adjacent Kapopo property was discussed in Section 11. No information is available for the property situated to the south of Kamonia.

## 12.9 Mineral Processing and Metallurgical Testing

No mineral processing has occurred at Kamonia to date. A mobile process plant has arrived on site and will be commissioned in January 2008 and used to treat Kamonia samples. The plant flowsheet is described in Section 11.9 and shown graphically in Figure 33.

## 12.10 Diamond Resource and Diamond Reserve Estimates

### 12.10.1 Previous Resource Statements

As noted in Section 11.10.1, a Diamond Resource statement was issued for the Longatshimo River Project, including the Kamonia Project Area, on 1<sup>st</sup> May 2006 (Table 38). This was prepared by PDF's Qualified Person, Ms Helen Pein. The statement was independently verified by Venmyn's Qualified Person, Ms Catherine Telfer, by checking all the input parameters, the calculation mathematics and the logic of the classification. This statement has subsequently been updated using the latest exploration results.

### 12.10.2 Volume

The volume of the resources was estimated using the database of gravel thickness and modelled in Surfer, as described in Section 11.10.2. The resultant volumes for the various gravel types are tabulated in Table 51.

**Table 51 : Volume Estimation for Kamonia Project Area**

MINE / PROJECT	PROJECT AREA	GRAVEL TYPE	GRAVEL VOLUME (m <sup>3</sup> )
Longatshimo River	Kamonia	Blanket	2,807,797
		Floodplain	4,487,949
		Palaeo channel	2,103,263
<b>TOTAL / AVE KAMONIA PROJECT AREA</b>			<b>9,399,008</b>

### 12.10.3 Density

No density measurements are required as all resources are quoted in volumes.

### 12.10.4 Grade

The grade has been calculated per gravel type as a weighted average of all the pits which lie within the defined resource area included in the volume calculation above. The grades are summarised in Table 52.

**Table 52 : Grade Calculation for Kamonia Project Area**

MINE / PROJECT	PROJECT AREA	GRAVEL TYPE	REC. GRADE (ct/100m <sup>3</sup> )	CARATS
Longatshimo River	Kamonia	Blanket	26.26	737,327
		Floodplain	49.87	2,238,140
		Palaeo channel	15.51	326,216
<b>TOTAL / AVE KAMONIA PROJECT AREA</b>			<b>35.13</b>	<b>3,301,684</b>

### 12.10.5 Diamond Value

As noted in Section 11.10.5, no diamonds have been sold from the Longatshimo River Project as a sufficiently large parcel (at least 2,000cts) has not yet been produced. A total of 175cts was produced from the Kapopo and Kamonia Project Areas combined by December 2007. A small parcel produced from the nearby Tshikapa River Project was independently valued and this value was utilised for the Kamonia and Kapopo Project Areas (Table 41).



There are a number of other diamond values recorded which relate directly to the Kamonia Project Area. However, these are less reliable than the recent valuation because they were carried out:-

- on very small numbers of stones; and
- date back to 2005 and 2006.

In 2006, PDF approached a local Tshikapa diamond buyer with the diamonds produced from PY16 and PY17 in order to obtain an indication of the potential diamond values. The results are indicated in Table 53.

**Table 53 : Indicative Diamond Valuations for Kamonia**

PIT NO.	CARATS	TOTAL VALUE (US\$)	AVE VALUE (US\$/ct)
PY16	4.25	914.75	215.24
PY17	3.35	233.60	69.73
<b>TOTAL / AVE</b>	<b>7.60</b>	<b>1,148.35</b>	<b>151.10</b>

The confidence in the accuracy of this diamond value is low as it is estimated from only 7.6cts and diamonds are typically highly variable in both quality and size.

Additional diamond values were quoted by the DRC agent (Mr Kamonia Kasongo) in his environmental report to the government. Official receipts of the sales were included in his report. The results shown in Table 54 are very similar to those noted above. However, the direct sale of diamonds into the international market is likely to achieve a higher price than those offered locally to the artisanal workers

**Table 54 : Sales Records from Artisanal Miners**

DATE	CARATS	TOTAL VALUE (US\$)	AVE VALUE (US\$/ct)
April 2005	26.40	1,300	49.24
June 2005	3.47	3,000	864.55
June 2005	5.20	600	115.38
<b>TOTAL / AVE</b>	<b>35.07</b>	<b>4,900</b>	<b>139.72</b>

For the reasons noted above, the estimated diamond price used in the resource statement for both the Longatshimo and Tshikapa River Projects is US\$180/ct.

### 12.10.6 Current Resource Statement

The Diamond Resource statement for the Kamonia Project Area, dated 1<sup>st</sup> March 2008, was prepared by Ms Helen Pein. This was independently verified by Ms Catherine Telfer of Venmyn by checking the input parameters, the calculation mathematics and the logic of the classification. The statement for the Longatshimo Project, including the Kamonia Project Area is shown in Table 42.





All resources are classified as Inferred due to the low confidence associated with the grade and the lack of a sufficiently large parcel sold in today's market. The logic used in the classification is tabulated in Appendix 2. The location of the Diamond Resources, in relation to the project area, is illustrated in Figure 37.

There are no known items relating to the environment, permits, legal, title, taxation, socio-economic, marketing, political or any other issue that would have a material effect on the resources identified in the current Diamond Resource statement.

### 12.11 Other Relevant Data and Information

The reader is referred to Section 11.11 for the results of a Preliminary Assessment of the Kamonia Project Area in conjunction with the Kapopo Project.

**LEGEND:**

-  River
-  Tributary
-  Palaeo Gravel
-  Floodplain Gravel
-  Blanket Gravel

**LOCATION OF DIAMOND RESOURCES FOR THE KAMONIA PROJECT AREA**

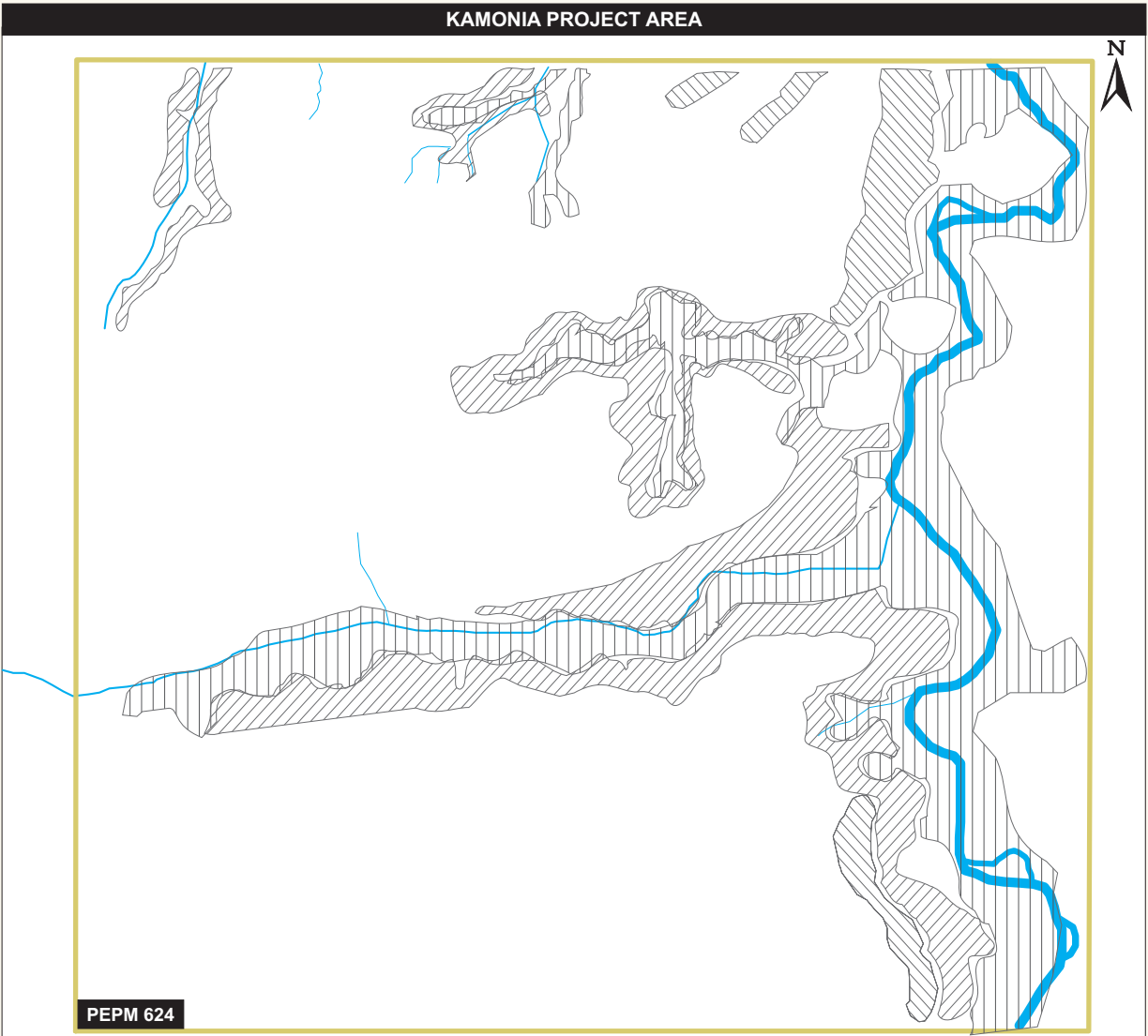
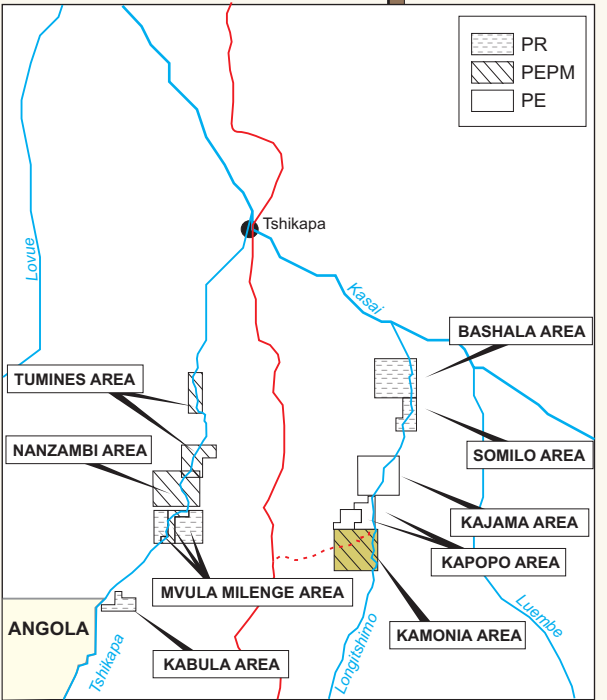

MINE / PROJECT	PROJECT AREA	GRAVEL TYPE	GRAVEL VOLUME (m <sup>3</sup> )	REC. GRADE (ct/100m <sup>3</sup> )	CARATS	DIAMOND VALUE (US\$/ct)	BOTTOM SCREEN SIZE (mm)
Longatshimo River	Kamonia	Palaeo channel	2,103,263	15.51	326,216	180	1.6
		Floodplain	4,487,949	49.87	2,238,140	180	1.6
		Blanket	2,807,797	26.26	737,327	180	1.6
<b>TOTAL / AVE YUSUFU PROJECT AREA</b>			<b>9,399,008</b>	<b>35.13</b>	<b>3,301,684</b>	<b>180</b>	<b>1.6</b>

PangeaDFieldsTSX'07Fig37.cdr

Source: Pangea

This diagram and the information therein are copyrighted. It may not be reproduced or transmitted in any form or by any means without prior written permission from Venmyn Rand (Pty) Ltd. Trading as Venmyn.

## 12.12 Interpretation and Conclusions

As was the case for Kapopo, the extensive and detailed exploration through jimbo pitting and auger drilling, within the Kamonia Project Area, has provided sufficient information on the gravel and overburden thicknesses to allow computerised modelling and a more accurate determination of volumes as compared to previously.

Modelling has indicated that in general the thickest gravels are situated within the palaeo channel but these are highly variable. The floodplain and blanket gravels are thinner but, at a thickness of just less than 1m, still have economic potential.

Grade information has been provided, for the various gravel types, through the prospecting, jimbo and mega pitting exercises. These grade results will be verified through the bulk sampling exercise commencing in the first quarter of 2008.

An initial independent diamond valuation, indicative of today's market, has been provided for a small parcel. The bulk sampling programme will provide the carats required (at least 2,000cts) to increase confidence in the current diamond price.

The exploration results have been verified and the methods independently checked by Venmyn. We are of the opinion that the results are reliable and that the data density, quantity and quality are sufficient for the delineation of Inferred Resources for Kamonia.

## 12.13 Recommendations

The recommended work programme for the DRC projects, including the Kapopo Project Area is tabulated in Table 44. The expected revenues to be derived from the sale of diamonds extracted during exploration pitting, bulk sampling and pilot mining are shown in Table 45.

## 13 LONGATSHIMO RIVER PROJECT – KAJAMA PROJECT AREA

The Kajama Project Area is situated partially adjacent and to the north of the Kapopo Project Area (Figure 24 and Figure 25).

### 13.1 Exploration

Exploration commenced on the Kajama Project Area in June 2007. A fly camp was set up within the Kajama block for ease of access. The exploration method was the same as that applied to the Kapopo and Kamonia Project Areas. A full description of this method is presented in Section 12.1.

PDF has carried out reconnaissance mapping and jimbo pitting in the Kajama Project Area, the methods and results are described in the sections to follow. Exploration is ongoing and will be followed up during 2008 with mega pitting and auger drilling. Bulk sampling will be carried out in 2009, dependent upon a positive outcome of the mega pitting programme.

### 13.2 Reconnaissance Mapping

PDF commenced reconnaissance mapping in June 2007 on the concession area to the west of the Longatshimo River. The exploration was only carried out to the west because of access constraints. The reconnaissance mapping method used is described in Section 11.2. The results of the mapping exercise are illustrated on Figure 38.

The results from the pitting programme were used to confirm the reconnaissance mapping results and were used to maintain an updated geological map for the area.

### 13.3 Prospecting Pitting

No prospecting pitting has been carried out as jimbo pitting has been found to be a more cost and time effective means of obtaining the required information than using prospecting pitting.

### 13.4 Jimbo Pitting

PDF commenced with jimbo pitting in the Kajama Project Area in June 2007 (Figure 38). A total of 143 jimbo pits had been excavated to December 2007. This pitting is still ongoing.

**Pangea DiamondFields plc**

**EXTENT OF GRAVELS AND SAMPLE POSITIONS FOR THE KAJAMA PROJECT AREA**

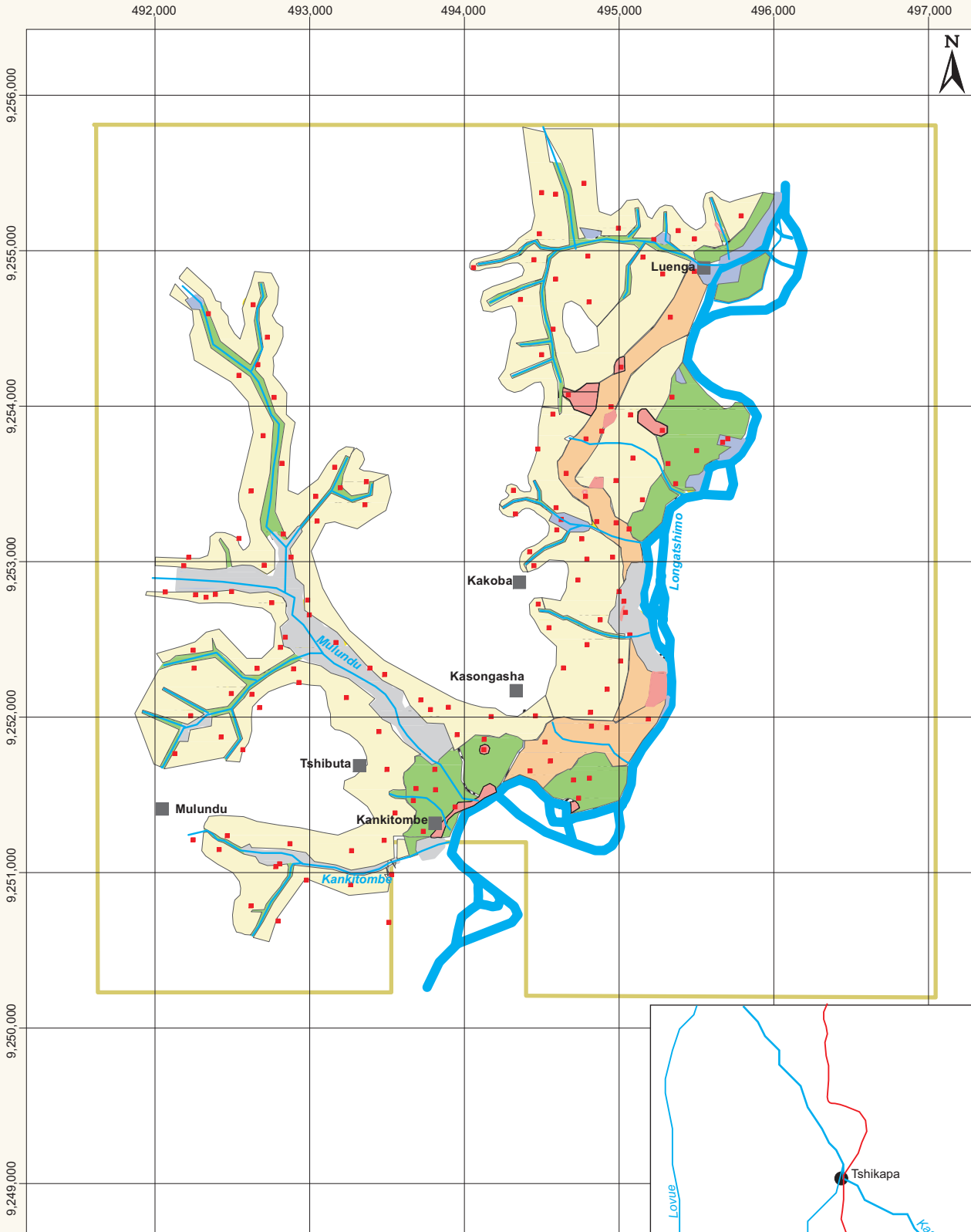

PangeaDFieldsTSX'07Fig38.cdr

Source: Pangea

**LEGEND:**

- River
- Gneiss
- Mined Area
- Blanket Gravel
- Palaeo Channel Gravel
- Floodplain Gravel
- Prospecting Pit
- Village

**SCALE:**



This diagram and the information therein are copyrighted. It may not be reproduced or transmitted in any form or by any means without prior written permission from Venmyn Rand (Pty) Ltd. Trading as Venmyn.

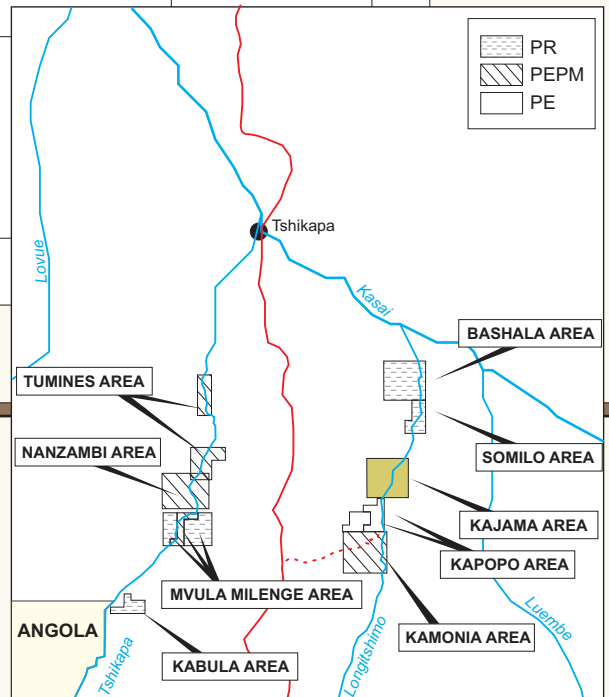

#### 13.4.1 Sampling Method and Approach

The method of jimbo pitting is described in detail in Section 11.4.1. The pits were numbered sequentially at Kajama with a prefix of 'K'. The pits were placed at 300m to 400m intervals adjacent to the Longatshimo River and its tributaries.

#### 13.4.2 Sample Preparation, Analyses and Security

No samples were washed from the jimbo.

#### 13.4.3 Data Verification

As described in previous sections, all results were entered into an Excel spreadsheet which was verified by PDF's head office staff.

#### 13.4.4 Results

The results of the jimbo pitting with respect to gravel and overburden thicknesses are tabulated in Table 55. The positions of the pits are indicated on Figure 38. No computerised modelling has been carried out for the gravel and overburden thicknesses.

**Table 55 : Summary Jimbo Pitting Results for Kajama Project Area**

GRAVEL TYPE	NO. OF PITS	AVE O/B THICK (m)	AVE GRAVEL THICK (m)
Blanket	109	5.28	0.57
Floodplain	17	2.43	0.43
Palaeo Channel	17	2.36	0.41
<b>TOTAL</b>	<b>143</b>		

Initial volumes were calculated for the Kajama Project Area based upon the average gravel thicknesses multiplied by the surface areas. These volumes were then reduced by any mined out areas that had been identified. The results of the volume calculations are shown in Table 56.

**Table 56 : Initial Gravel Volume Calculations for the Kajama Project Area**

MINE / PROJECT	PROJECT AREA	GRAVEL TYPE	GRAVEL VOLUME (m <sup>3</sup> )
Longatshimo River	Kajama	Blanket	2,606,455
		Floodplain	289,923
		Palaeo channel	203,288
		<b>TOTAL</b>	<b>3,099,666</b>

#### 13.5 Mega Pitting

No mega pitting has been carried. PDF plans to commence with a mega pitting programme in 2009.

#### 13.6 Auger Drilling

No auger drilling has been undertaken at Kajama as the drill rig is currently being used at the Kamonia and Kapopo Project Areas.

#### 13.7 Bulk Sampling

No bulk sampling has been carried out in the Kajama Project Area.

#### 13.8 Adjacent Properties

Relevant information pertaining to the adjacent Kapopo property was discussed in Section 11. No information is available for the property situated to the north of Kamonia.

#### 13.9 Mineral Processing and Metallurgical Testing

No mineral processing has occurred at Kajama to date.

#### 13.10 Diamond Resource and Diamond Reserve Estimates

No previous or current Diamond Resource statements are available for Kajama.

### 13.11 Other Relevant Data and Information

There is no other relevant data or information which should be presented to ensure that this report is not misleading in any way.

### 13.12 Interpretation and Conclusions

Initial reconnaissance mapping has indicated that gravels, similar to those encountered in the Kamonia and Kapopo Project Areas, are also present in Kajama, although the presence of blanket gravel has not yet been tested. Due to the paucity of sampling information at Kajama, no diamond resource can be declared. The initial exploration results have been verified and the methods independently checked by Venmyn.

### 13.13 Recommendations

The recommended work programme for the DRC projects, including the Longatshimo River Project, is tabulated in Table 44. The expected revenues to be derived from the sale of diamonds extracted during exploration pitting, bulk sampling and pilot mining are shown in Table 45.

## 14 LONGATSHIMO RIVER PROJECT – SOMILO PROJECT AREA

The Somilo Project Area is situated 412km north of the Kajama Project Area (Figure 24 and Figure 25).

### 14.1 Exploration

PDF obtained the rights to this project area in September 2007. The company plans to commence with reconnaissance mapping at Somilo in the 3<sup>rd</sup> quarter of 2008. PDF has successfully implemented its exploration programme of reconnaissance mapping, pitting and augering in the project areas to the south. As staff becomes available, the company will move progressively northwards into their new concessions. PDF plans to obtain the rights to a significant stretch of the Longatshimo River to ensure maximum potential resource identification and flexibility in mining thereafter.

### 14.2 Reconnaissance Mapping

No reconnaissance mapping has been carried out at Somilo.

### 14.3 Prospecting Pitting

No prospecting pitting has been carried out on the property.

### 14.4 Jimbo Pitting

No jimbo pitting has commenced in the Somilo Project Area.

### 14.5 Mega Pitting

No mega pitting has been carried out.

### 14.6 Auger Drilling

No auger drilling has been undertaken at Somilo. Drilling will only commence after the rig has drilled the Kajama property.

### 14.7 Bulk Sampling

No bulk sampling has been carried out in the Somilo Project Area.

### 14.8 Adjacent Properties

No information is available for the properties directly adjacent to Somilo.

### 14.9 Mineral Processing and Metallurgical Testing

No mineral processing has occurred at Somilo to date.

### 14.10 Diamond Resource and Diamond Reserve Estimates

No previous or current Diamond Resource statements are available for Somilo.

#### 14.11 Other Relevant Data and Information

There is no other relevant data or information which should be presented to ensure that this report is not misleading in any way.

#### 14.12 Interpretation and Conclusions

Due to the paucity of exploration results no interpretations or conclusions can be made at this point in time.

#### 14.13 Recommendations

The recommended work programme for the DRC projects, including the Longatshimo River, is tabulated in Table 44.

### 15 LONGATSHIMO RIVER PROJECT – BASHALA PROJECT AREA

The Bashal Project Area is situated adjacent to and directly north of the Somilo Project Area (Figure 24 and Figure 25). The Northern license boundary is 5km south of the Longitshimo and Kasai river confluence.

#### 15.1 Exploration

PDF obtained the rights to Bashala in June 2007. As a result of its recent acquisition and the availability of staff no exploration has been conducted on the property. According to PDF's plan to explore the Longatshimo River Project from south to north, the Bashala Project Area will be the last to be explored.

#### 15.2 Reconnaissance Mapping

No reconnaissance mapping has been carried out for the Bashala Project Area.

#### 15.3 Prospecting Pitting

No prospecting pitting has been carried out at Bashala.

#### 15.4 Jimbo Pitting

No jimbo pitting has commenced in the Bashala Project Area.

#### 15.5 Mega Pitting

No mega pitting has been carried out.

#### 15.6 Auger Drilling

No auger drilling has been undertaken at Bashala.

#### 15.7 Bulk Sampling

No bulk sampling has been carried out within the Bashala Project Area.

#### 15.8 Adjacent Properties

No information is available for the properties directly adjacent to Bashala.

#### 15.9 Mineral Processing and Metallurgical Testing

No mineral processing has occurred at Bashala to date.

#### 15.10 Diamond Resource and Diamond Reserve Estimates

No previous or current Diamond Resource statements are available for Bashala.

#### 15.11 Other Relevant Data and Information

There is no other relevant data or information which should be presented to ensure that this report is not misleading in any way.

**15.12 Interpretation and Conclusions**

Due to the paucity of exploration results, no interpretations or conclusions can be made.

**15.13 Recommendations**

The recommended work programme for the DRC projects, including the Longatshimo River Project, including Bashala is tabulated in Table 44. The expected revenues to be derived from the sale of diamonds extracted during exploration pitting, bulk sampling and pilot mining are shown in Table 45.



## 16 TSHIKAPA RIVER PROJECT

The Tshikapa River Project is comprised of four project areas located on both banks of the Tshikapa River in southern DRC (Figure 24 and Figure 25) which cover a total area of 109km<sup>2</sup>. The project areas are namely, from north to south, Tumines, Nanzambi, Mvula Milenge and Kabula. The project areas range in development from early to late stage exploration. Bulk sampling is planned to commence early in 2009 at Mvula Milenge.

### 16.1 Property Description and Location

The Tshikapa River Project areas are situated from 23.4km south southwest of Tshikapa town to the Angolan border in the Kasai District of the Kasai-Occidental Province, DRC. The size of the project areas, along with the coordinates of each license, are summarised in Table 57.

**Table 57 : Tshikapa River Project Areas and Boundary Coordinates**

PROJECT	PROJECT AREA	LICENSE TYPE	PERMIT NO.	AREA (km <sup>2</sup> )	AREA (ha)	BOUNDARY COORDINATES (LATITUDE, LONGITUDE)
Tshikapa River	Tumines	PEPM	667	12	1,200	(06°40'00"S; 20°42'30"E); (06°37'00"S; 20°42'30"E); (06°37'00"S; 20°43'30"E); (06°40'00"S; 20°43'30"E)
		PEPM	666	17	1,700	(06°44'30"S; 20°42'00"E); (06°42'30"S; 20°42'00"E); (06°42'30"S; 20°44'30"E); (06°43'30"S; 20°44'30"E); (06°43'30"S; 20°43'30"E); (06°45'00"S; 20°43'30"E); (06°45'00"S; 20°43'00"E); (06°44'30"S; 20°43'00"E)
	Nanzambi	PEPM	674	36	3,600	(06°47'00"S; 20°40'00"E); (06°44'30"S; 20°40'00"E); (06°44'30"S; 20°43'00"E); (06°47'00"S; 20°43'00"E)
	Mvula Milenge	PEPM	665	8	800	(06°50'00"S; 20°40'30"E); (06°49'30"S; 20°40'30"E); (06°49'30"S; 20°41'00"E); (06°47'30"S; 20°41'00"E); (06°47'30"S; 20°42'30"E); (06°48'00"S; 20°42'30"E); (06°48'00"S; 20°41'30"E); (06°50'00"S; 20°41'30"E)
		PR	3014	18	1,800	(06°50'00"S; 20°41'30"E); (06°48'00"S; 20°41'30"E); (06°48'00"S; 20°42'30"E); (06°47'30"S; 20°42'30"E); (06°47'30"S; 20°43'30"E); (06°50'00"S; 20°43'30"E)
		PR	3015	9	900	(06°50'00"S; 20°40'00"E); (06°47'30"S; 20°40'00"E); (06°47'30"S; 20°41'00"E); (06°49'30"S; 20°41'00"E); (06°49'30"S; 20°40'30"E); (06°50'00"S; 20°40'30"E)
	Kabula	PR	5744	9	900	(06°56'00"S; 20°37'30"E); (06°55'30"S; 20°37'30"E); (06°55'30"S; 20°38'30"E); (06°54'30"S; 20°38'30"E); (06°54'30"S; 20°39'00"E); (06°55'00"S; 20°39'00"E); (06°55'00"S; 20°40'00"E); (06°56'00"S; 20°40'00"E)
	<b>TOTAL TSHIKAPA RIVER</b>				<b>109</b>	<b>10,900</b>

The coordinates of the license boundaries were provided by the government in the official documentation. The perimeter of PEPM 665, PR3014 and PR 3015 were surveyed in 2006 by CAMI (Cadestre Minier), which is the official Mines Department in DRC. Official demarcating beacons have been erected on the property. The remaining permit boundaries have been located on satellite images ordered for the respective properties.

Alluvial diamond mineralisation is associated with the Tshikapa River, its tributaries and the interfluvial areas. The Tshikapa River appear to have migrated from east to west and its tributaries appear to have migrated in a predominantly northerly direction. These abandoned paleo-channels have been mapped and explored. This mineralisation has been exploited to varying degrees since the early 1900s by the Belgians and more recently by local artisanal miners. Currently only limited artisanal activities are present within the license areas. Mined out areas are identified, where possible, although the rapid regeneration of vegetation in these areas can make this difficult.

### 16.1.1 Legal Aspects and Tenure

Three Exploration Permits (PRs) and four Exploitation Permit for Small Mines (PEPM) have been issued to local companies or individuals for the Tshikapa River Project properties. All rights pertain to the exploration for both alluvial and kimberlitic diamonds.

Efidium has agreements with these local parties to obtain tenure. However, in the case of the Nanzambi Project Area, the rights have been transferred from the DRC agent to a DRC registered company, Nanzambi Mining Corporation (Nanzambi), of which Efidium currently owns 100%. The tenure information is summarised in Table 58 and illustrated in Figure 39.

**Table 58 : Tshikapa River Project Legal Tenure**

PROJECT	PROJECT AREA	LICENSE TYPE	PERMIT NO.	MINERAL	LICENSE HOLDER	AREA (km <sup>2</sup> )	EXPIRY DATE	APPLICATION FOR	DRC PARTNER'S RIGHT	
Tshikapa River	Tumines	PEPM	667	Diamonds	Societe Ntumbamines (Tumines)	12	Jul 2007	Renewal	Royalty of 6% of revenue less costs, after 50% of capital paid back.	
		PEPM	666	Diamonds	Tumines	17	Jul 2007	Renewal	Royalty of 6% of revenue less costs, after 50% of capital paid back.	
	Nanzambi	PEPM	674	Diamonds	Nanzambi Mining Corporation (Nanzambi)	36	Nov 2007	Renewal	Efidium holds 100%	
	Mvula Milenge	PEPM	665		Leta Mbavu (Leta)	8	Jul 2007	Approved	Royalty of 12% of revenue less costs, after 50% of capital paid back.	
		PR	3014		Leta Mbavu (Leta)	18	Sept 2009		Royalty of 12% of revenue less costs, after 50% of capital paid back.	
		PR	3015		Leta Mbavu (Leta)	9	Sept 2009		Royalty of 12% of revenue less costs, after 50% of capital paid back.	
	Kabula	PR	5744		Diamonds	Kamba Kabula (Kabula)	9	Nov 2010		20% free carried interest.
	<b>TOTAL TSHIKAPA RIVER</b>						<b>100</b>			

Efidium has negotiated 100% share of the Nanzambi Project Area. The company will pay royalties to the DRC agents as stipulated in Table 58. Efidium is required to spend a minimum of US\$300,000 on exploration of the concession over three years. Provided the results are positive, Efidium may then develop the project to Feasibility Stage at their own cost.

The licences for Tumines, Nanzambi and one from Mvula Milenge have expired (Table 58). Applications have been made to the Mining Registry for the renewal of these. They are in progress and are likely to be issued over the next three months. As stated in Section 10.1.1 on the Longatshimo Project, PDF has no reason to believe that they will not be re-issued as, according to the New Mining Code, PRs can be renewed for two 2yr periods after the initial 4yr period in the case of PRs. PEPMs are issued for approximately 10yrs with renewals of several additional 10yr periods. PEPM 665 has received favourable approval.

The surface rights are held by the State. Fees are paid to the government for the right to access the surface over these properties.

The holder is obliged to complete a PAR. No additional obligations are specified.

### 16.1.2 Royalties, Fees and Taxes

The royalties, fees and taxes are outlined in Section 10.1.2.

### 16.1.3 Impact of the Project on the Environment

PDF has paid the government between US\$4,000 and US\$20,000 per license for the preparation of the required PARs for the Tshikapa Project. There are no existing environmental liabilities on the properties. All current exploration activities will be rehabilitated by PDF as required. An estimate of the liability has not yet been prepared.

As noted previously, if mining commences then PDF will employ the services of an internationally recognized environmental expert to prepare the required EIE and PGEP.

**OWNERSHIP OF THE TSHIKAPA RIVER PROJECT**

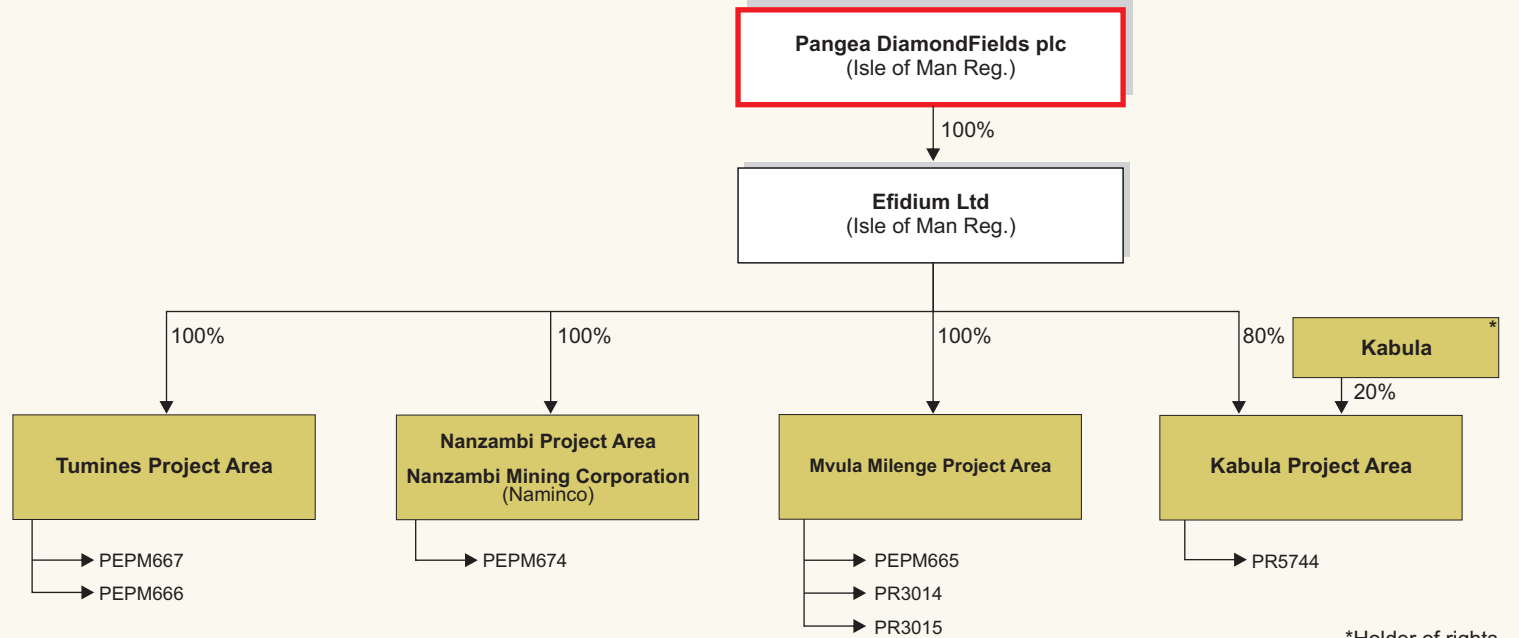
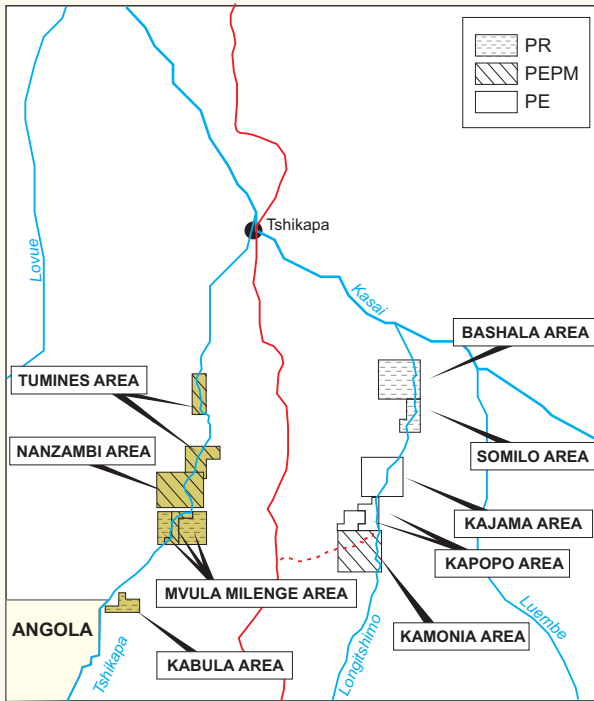

\*Holder of rights

**VIEW OF 6FT PAN PLANT IN EARLY 1900'S  
ON KAPOPO RIVER (TSHIKAPA RIVER TRIBUTARY)**

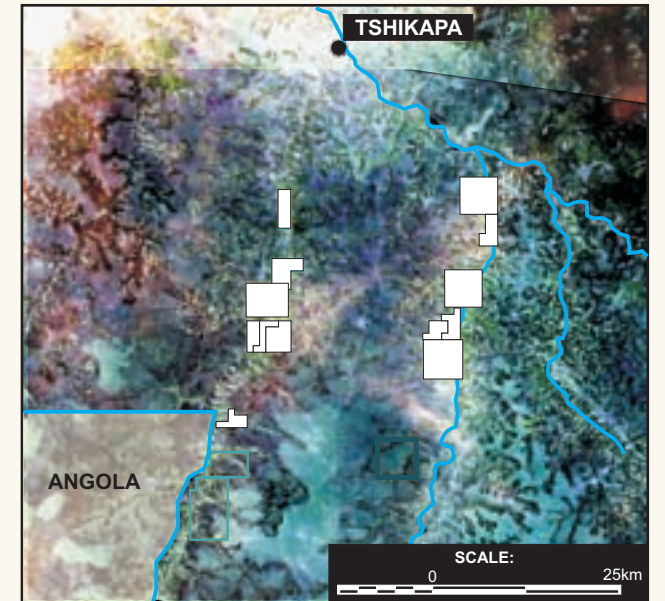

PangeaDFieldsTSX'07Fig39.cdr

This diagram and the information therein are copyrighted. It may not be reproduced or transmitted in any form or by any means without prior written permission from Venmyn Rand (Pty) Ltd. Trading as Venmyn.

## **16.2 Accessibility, Climate, Local Resources, Infrastructure and Physiography**

### **16.2.1 Locality, Population and Access**

The Tshikapa River Project is situated south southwest of the town of Tshikapa in the Kasai District of the Kasai-Occidental Province in southern DRC (Figure 25). A detailed description of Tshikapa town, its infrastructure and access can be found in Section 10.2.1.

Access to the Tshikapa River Project is via dirt track off the new road constructed by PDF to access the Longatshimo River Project. This route travels from Luanda, in Angola, to Saurimo and Lucapa in the northeast of the country and on to the border at Kanjadji.

Access to the project areas from Tshikapa is either by four wheel drive vehicle or motorcycle along gravel tracks, by boat where feasible or by small Russian aircraft requiring limited landing facilities. The closest airstrip is located at Mushapo.

As previously noted, transport by air is the most reliable, effective and the quickest method of travel within the DRC. The roads in the country are in poor condition and many are impassable. River crossings are often problematic due to the poor state of repair of bridges and ferries. Rail and boat links are a far better alternative for the transport of heavy cargo.

The road from Kanango to Tshikapa has been repaired and upgraded by Vodacom. This road connects Tshikapa to an international airport at Kanango which has immigrations customs facilities.

### **16.2.2 Infrastructure and Local Resources**

A camp was established by PDF in 2005 within the Mvula Milenge Project Area to service the Tshikapa River Project. A new camp was built and completed in September 2007. This camp comprises accommodation, ablution, offices and mess facilities for 10 senior staff.

All process water is sourced from the Tshikapa River and its tributaries. Potable water for the camp is sourced from a fresh water spring which is a tributary of the Tshikapa River and filtered prior to consumption. Power is supplied to the camp using a diesel powered generator.

The closest village to the Tshikapa Project is also Kamonia where unskilled and semi skilled labour is sourced. The town has a school and clinic. The closest large town is Tshikapa where the local infrastructure includes power sourced from a hydroelectric plant, an intermittent supply of running water, hospitals, schools and an airstrip.

PDF has access to sufficient surface area for future potential mining and processing operations and tailing disposal.

### **16.2.3 Climate and Vegetation**

The climate and vegetation pertaining to the Tshikapa River Project is similar to that of the Longatshimo River Project which is described in detail in Section 10.2.3.

The land associated with the Tshikapa River Project is generally dry and as a result operations can easily be continued throughout the year. However, roads may become temporarily impassable during heavy storms.

### **16.2.4 Physiography**

The project areas are all situated on or adjacent to the Tshikapa River, a major north flowing river draining into the Congo via the Kasai River. The physiography of the project includes river valleys and interfluvial areas with a gentle gradient. The elevation varies from a maximum of 665m to a minimum of 545m.

## **16.3 History**

The Tshikapa River Project is situated within the Tshikapa Diamondfield, a well known diamond area with a long history of alluvial diamond production. A discussion into the history of the Tshikapa Diamond Field is given in Section 10.3 and historical production figures are illustrated in Figure 28.

The prior ownership of the Tshikapa River properties specifically and their historical ownership changes are unknown. It is likely, however, that these have changed hands many times between the local Congolese owners and artisanal miners since Forminiere exited in the 1960s. No records of these changes were forthcoming.

### 16.3.1 Historical Exploration, Sampling and Production Records

A detailed description of the historical sampling methods carried out on some tributaries on the project area, by Forminiere is located in Section 10.3.1. Historical production results obtained for four of the Tshikapa River's tributaries are tabulated Table 59.

**Table 59 : Historical Production from the Tshikapa River Project**

PROJECT	PROJECT AREA	TRIBUTARY	YEAR	GRAVEL VOLUME (m <sup>3</sup> )	GRADE (ct/100m <sup>3</sup> )	CARATS
Tshikapa River	Nanzambi and Tumines	Nabondo	1935	241,439	76.50	184,707
		Nabonbo flats	1951	630,851	63.50	400,563
		M'Pasu flats	1927	17,140	69.00	11,826
			1951	30,145	45.75	13,792
	Mvula Milenge	Malembe flats	1951	17,271	36.62	6,324
	<b>TOTAL / AVE</b>				<b>936,846</b>	<b>65.88</b>

### 16.3.2 Historical Diamond Resources

No historical Diamond Resource and Diamond Reserve estimates are available for the Tshikapa River Project.

## 16.4 Geological Setting

### 16.4.1 Regional Geological Setting

The regional geology of southwestern DRC is described in Section 10.4.1 and shown graphically on Figure 28.

### 16.4.2 Local and Property Geology

The local geology of the Tshikapa area is discussed in Section 10.4.2 and illustrated in Figure 29. The geological models pertaining to both the Longatshimo and Tshikapa River projects are the same.

## 16.5 Deposit Type

As is the case with the Longatshimo River Project, the Tshikapa River Project is host to both alluvial and blanket diamond deposits. Diamonds have been recovered by PDF from a number of geological environments including the palaeo Tshikapa River channels, from terrace or flat deposits adjacent to the Tshikapa River and its tributaries as well as from the blanket gravels situated upon the bedrock schists. These three deposit types formed the focus of PDF's exploration and, through this exploration work, resources have been defined for each.

## 16.6 Mineralization

The diamond mineralization identified within the Longatshimo River Project is applicable to the Tshikapa River Project and is described in detail in Section 10.6. The gravel types present within the Tshikapa River Project include the following:-

- present day Tshikapa River and associated gravels deposits within it, including potholes. These have not been researched by PDF and as a result no detailed description of the gravels is available;
- palaeo Tshikapa River gravels. These light brown gravels are characterised by a single fining upward layer with a maximum thickness of 1.0m. The gravels are deposited on an undulating bedrock gneiss surface and as a result potholes are evident. The gravels are comprised of well sorted, well rounded pebbles with an average diameter of 35mm and boulders. The pebbles are primarily comprised of quartz. The oversize (+160mm) boulders have an average size of 450mm and consist of quartzite and silcrete;

- terrace or floodplain deposits. These are associated with the tributaries of the Tshikapa River. The gravels comprise a single fining upward layer with a thickness of between 0.30 and 0.40m. The gravels consist of angular quartz breccias and minor (<20%) well rounded pebbles. The matrix is clean sand. The overburden varies from approximately 1.0m to 1.5m in thickness; and
- blanket gravels. These gravels occur between the terraces in the interfluvial areas. PDF believe that they were formed as a result of a widespread deflation surface. The gravels rest on the undulating contact with the basement schists. The gravels are characterised by well rounded quartz pebbles of 20-30mm in size and the gravel reaches an average thickness of 0.5m. There is only a small percentage of oversize present.

PDF derived the DRC geological model from the exploration carried out within the Kamonia, Kapopo and Kajama Project Areas and this has been confirmed from the exploration carried out within the Mvula Milenge and Nanzambi Project Areas. PDF have identified a trend of increasing grade from the blanket deposits towards the paleo-channel deposits.

## **17 TSHIKAPA RIVER PROJECT – MVULA MILENGE PROJECT AREA**

The Mvula Milenge Project Area is the most advanced with respect to exploration within the Tshikapa River Project. Exploration within Mvula Milenge commenced in May 2006.

### **17.1 Exploration**

The exploration method utilised for the DRC projects is outlined in Section 11.1 and includes reconnaissance mapping, various types of pitting, auger drilling and bulk sampling. PDF has carried out mapping, auger drilling and pitting within the Mvula Milenge concession.

### **17.2 Reconnaissance Mapping**

PDF commenced reconnaissance mapping in May 2006. The method of mapping is outlined in Section 11.2, whilst the results are illustrated for Mvula Milenge on Figure 40. All additional results from the pitting programmes were used to maintain an updated geological map of the area.

### **17.3 Prospecting Pitting**

Prospecting pitting also commenced in May 2006 and was used to identify the various types of gravel present and whether they contained diamonds. A total of 116 pits were excavated.

#### **17.3.1 Sampling Method and Approach**

The sampling method is discussed in Section 11.3.1. Figure 40 indicates the position of the prospecting pits within Mvula Milenge. The first 27 pits were numbered sequentially with a PM prefix to indicate that they were pits excavated within Mvula Milenge and these were typically circular in shape. The remaining pits were numbered sequentially with an MP prefix and were excavated as square pits. The same information was collected from both of these types of prospecting pits, namely gravel and overburden thickness, bedrock type, diamond grades and the number of stones.

#### **17.3.2 Sample Preparation, Analyses and Security**

The gravel samples were excavated, bagged and numbered under the supervision of the geologist. The bags were not sealed. A single sample was taken for each pit. The samples were then transported by the geologist to the site where the Boesman jig was used to extract the diamonds. This was also carried out under the direct supervision of the PDF geologist.

The Boesman jig was originally set up with a minimum scrubber/classifier sieve size of 2.5mm which resulted in the small -2.5mm diamonds not being recovered. This adversely effected the grade measurements. The first 7 pits were processed using this bottom screen size. A new bottom screen with a size of 1.6mm was then fitted and this used for the processing of all subsequent samples both within the Tshikapa River and Longatshimo River Projects. All samples were first put through a 1m classifier to remove silt and oversize (+25mm).

**LEGEND:**

- Blanket Gravel
- Palaeo Gravel
- Floodplain Gravel
- Mega Sample Pits
- Prospecting Pits
- Jimbo, Prospecting Pits
- Auger Drillhole

**EXTENT OF GRAVELS AND SAMPLE POSITION FOR THE MVULA MILENGE PROJECT AREA**

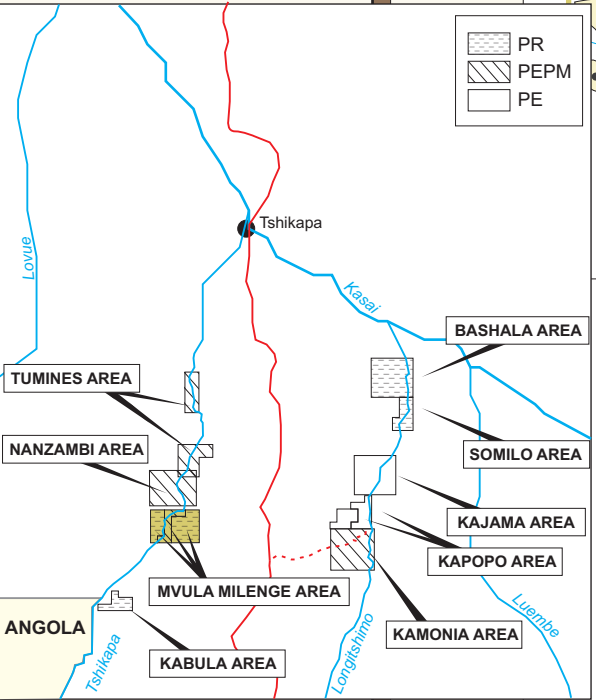
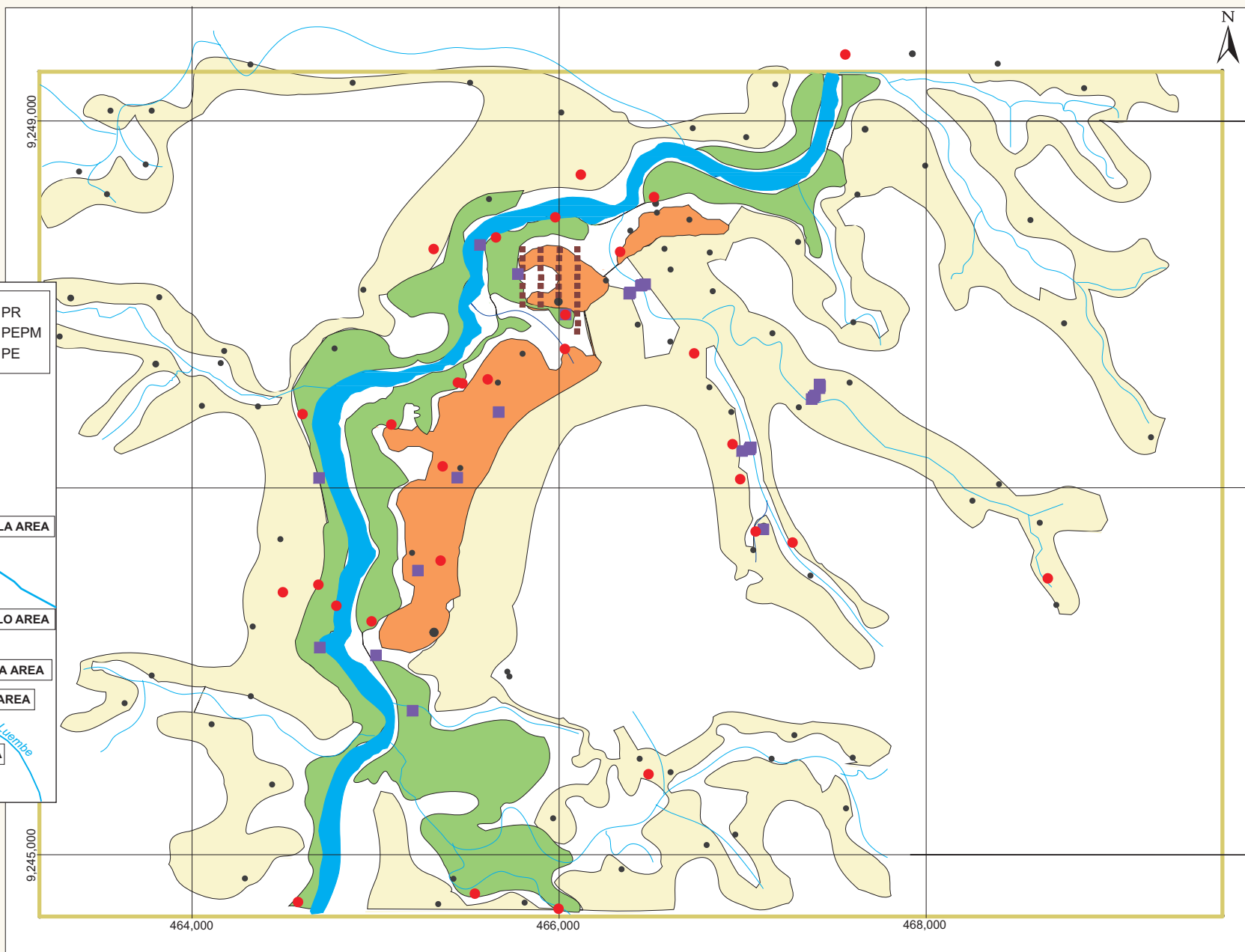

PangeaDFieldsTSX'07Fig40.cdr

This diagram and the information therein are copyrighted. It may not be reproduced or transmitted in any form or by any means without prior written permission from Venmyn Rand (Pty) Ltd. Trading as Venmyn.

**FIGURE 40**

There were no fencing or additional security measures in place at the processing and final diamond recovery site.

As noted in the section on the Longatshimo River Project, the method of sample preparation is adequate. The method of processing is not perfect both from both a recovery and a security perspective. However, this may only result in an under estimation of the grade and therefore the results are acceptable to the Qualified Person. The fact that PDF utilises tracers on a regular basis and re washes the gravels increases the confidence in the results of the recovery.

### 17.3.3 Data Verification

As noted in Section 11.3.3, all results were entered into an Excel spreadsheet and these were checked and verified by the PDF geologist at their head office in South Africa. Venmyn has not verified the data in detail but has witnessed the rigorous process of verification which PDF's headoffice geologist carries out. As a result, the Qualified Person is satisfied that the potential for any error to occur is minimised.

### 17.3.4 Results

The summary of results for the prospecting pitting, according to gravel type, is tabulated in Table 60. A total of 9.2cts were recovered from the prospecting pitting exercise. The average stone size is shown in Table 60.

**Table 60 : Summary Prospecting Pitting Results for Mvula Milenge Project Area**

GRAVEL TYPE	NO. OF PITS	AVE O/B THICK (m)	AVE GRAVEL THICK (m)	TOTAL GRAVEL VOLUME (m <sup>3</sup> )	TOTAL CARATS	TOTAL NO. STONES	AVE REC. GRADE (ct/100m <sup>3</sup> )	AVE STONE SIZE (ct/stone)	BOTTOM SCREEN SIZE (mm)
Blanket	90	4.87	0.84	141.10	1.91	13	1.35	0.15	1.6 & 2.5
Floodplain	9	3.51	0.62	71.80	5.45	36	7.59	0.15	1.6
Palaeo channel	17	6.91	1.02	32.90	1.84	5	5.59	0.37	1.6 & 2.5
<b>TOTAL / AVE</b>	<b>116</b>			<b>245.80</b>	<b>9.20</b>	<b>54</b>	<b>3.74</b>	<b>0.17</b>	

The gravel and overburden thicknesses and depth to bedrock results have been included with similar results obtained for the other types of exploration. This data has been modelled in Surfer®. Details of the modelling methods are described in Section 11.10.2. Plots of the contoured gravel and overburden thicknesses are shown in Figure 41. The summary statistics relating to the Surfer® modelling are presented in Table 61.

**Table 61 : Summary Statistics from Mvula Milenge Modelling**

PROJECT AREA	GRAVEL TYPE	LOCATION	NO. DATA POINTS	GRAVEL THICKNESS (m)			OVERBURDEN THICKNESS (m)		
				MIN	MAX	MEAN	MIN	MAX	MEAN
Mvula Milenge	Blanket	East	43	0.20	1.50	0.69	1.40	9.80	4.92
		West	24	0.20	4.10	1.22	0.20	12.50	5.63
	Floodplain	East	15	0.20	1.30	0.47	0.80	6.10	2.71
		West	5	0.10	1.40	0.74	2.30	3.70	3.06
	Palaeo channel	N/A	20	0.30	2.90	1.28	3.20	11.00	6.40

The gravel thickness plot indicates that all three types of gravel have highly variable thicknesses. The thickest gravels are located in the north and eastern central portion of the project area. The overburden increases away from the Tshikapa River but still remains low within the tributaries.

## 17.4 Mega Pitting

Mega pitting commenced in the Mvula Milenge Project Area in April 2007. These pits were used to obtain larger samples for the primary purpose of grade estimation. A total of 40 megapits were excavated at Mvula Milenge by December 2007.



**CONTOUR PLOT OF GRAVEL AND OVERBURDEN THICKNESSES FOR THE MVULA MILENGE PROJECT AREA**

**GRAVEL CONTOUR PLOT**

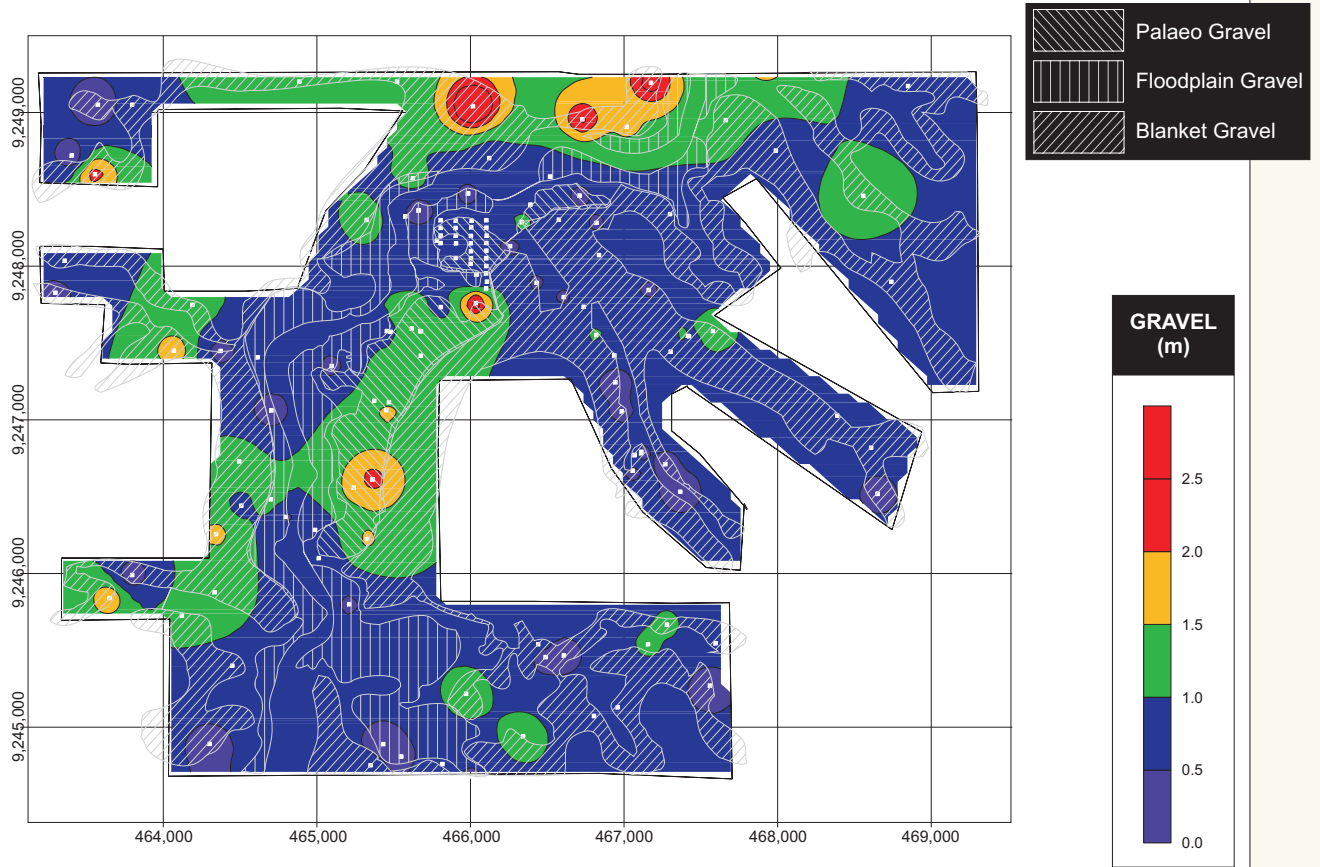

**OVERBURDEN CONTOUR PLOT**

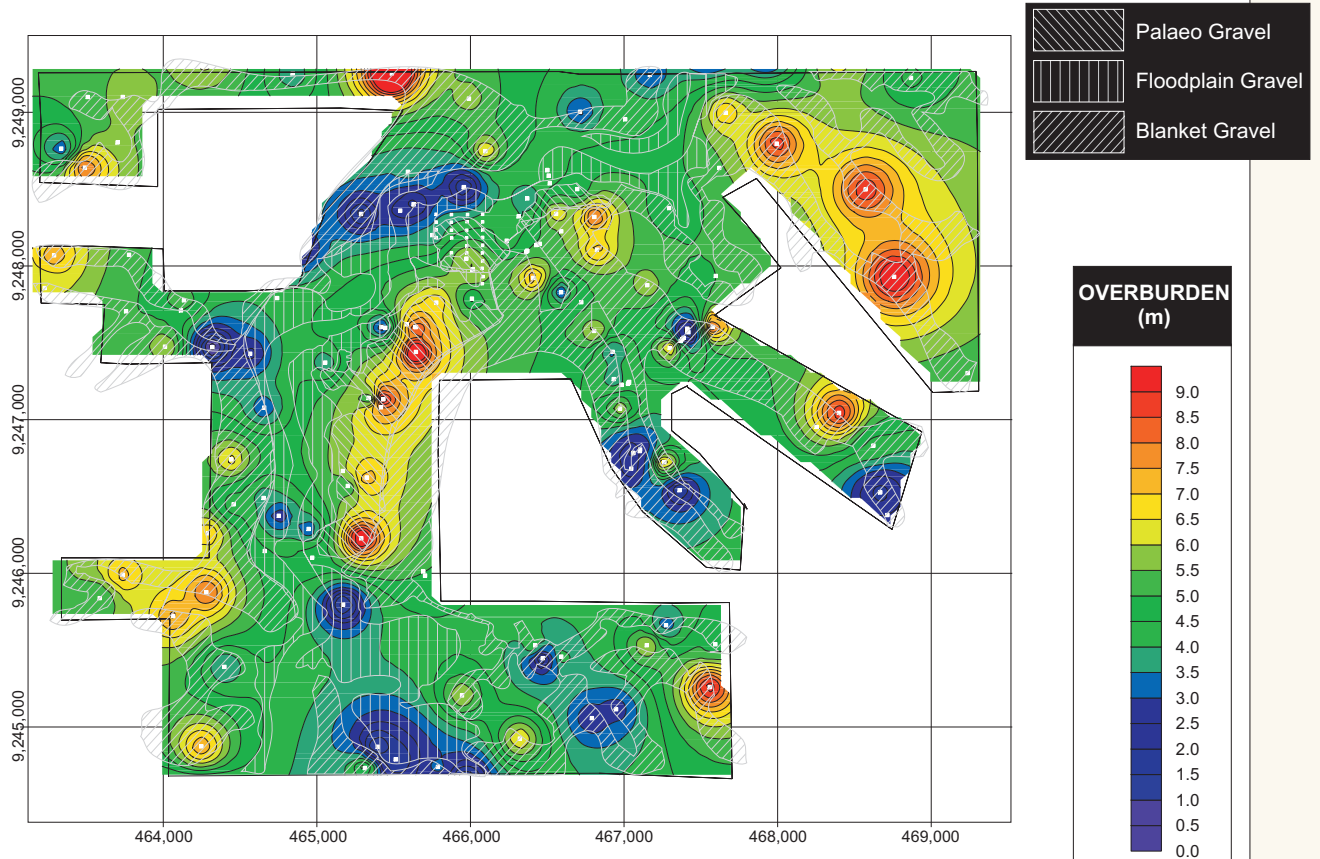

#### 17.4.1 Sampling Method and Approach

The mega pits were typically 4x4m in size, however, when possible larger pits of between 15 to 30m<sup>3</sup> were dug. The pit sites were selected on the basis of the well developed gravels identified in areas during the prospecting phase as well as those areas with reasonable stripping ratios. These hand dug pits were also numbered sequentially with an MP prefix. There was no indication in naming protocol to show the difference between these mega pits and the prospecting pits. Further details on the method are provided in Section 11.5.1.

#### 17.4.2 Sample Preparation, Analyses and Security

All gravels were extracted, bagged and numbered under the scrutiny of the PDF site geologist. The bags were not sealed. The samples were numbered according to the pit number with multiple samples given an alphabetical suffices, eg. MP52B. The samples were then transported by four wheel drive to the Boesman jig by the geologist. The sample processing method, described in Section 11.5.1, was applied to the mega pit samples. The processing site was not secured in any way.

#### 17.4.3 Data Verification

Again the results were recorded into a database which was verified by PDF's head office staff.

#### 17.4.4 Results

The mega pitting results are tabulated in Table 62.

**Table 62 : Summary Mega Pitting Results for Mvula Milenge Project Area**

PIT NO.	GRAVEL TYPE	O/B THICK (m)	GRAVEL THICK (m)	GRAVEL VOLUME (m <sup>3</sup> )	CARATS	NO. STONES	GRADE (ct/100m <sup>3</sup> )	STONE SIZE (ct/stone)	BOTTOM SCREEN SIZE (mm)
MP028	Blanket	1.40	0.50	11.30	0.00		0.00		1.6
MP029	Blanket	2.60	0.40	9.00	1.55	3	17.22	0.52	1.6
MP29B	Blanket	1.80	0.80	25.90	4.39	20	16.95	0.22	1.6
MP29B (repeat)	Blanket	1.80	0.80	9.60	2.79	14	29.06	0.20	1.6
MP29C	Blanket	7.30	0.40	4.80	0.09	1	1.88	0.09	1.6
MP29D	Blanket	6.00	0.40	4.70	0.00		0.00		1.6
MP95C	Blanket	2.30	0.50	10.00	0.07	1	0.70	0.07	1.6
MP95B	Blanket	2.00	0.30	6.00	0.31	3	5.17	0.10	1.6
MP92B	Blanket	4.20	0.90	12.80	0.00		0.00		1.6
MP70B	Blanket	1.20	1.50	5.30	0.28	1	5.28	0.28	1.6
MP69B	Blanket	6.70	0.60	7.20	0.00		0.00		1.6
MP54B	Blanket	1.40	0.30	7.60	0.24	3	3.16	0.08	1.6
MP53B	Blanket	5.00	0.70	8.00	0.22	1	2.75	0.22	1.6
MP52B	Blanket	3.70	0.20	3.50	0.39	2	11.14	0.20	1.6
MP100B	Blanket	1.80	0.50	7.20	0.54	3	7.50	0.18	1.6
MP100B (repeat)	Blanket	1.90	0.40	5.60	0.47	3	8.39	0.16	1.6
<b>TOTAL / AVE BLANKET</b>		<b>3.19</b>	<b>0.58</b>	<b>138.50</b>	<b>11.34</b>	<b>55</b>	<b>8.19</b>	<b>0.21</b>	
MP034	Floodplain	0.80	0.20	3.60	0.78	5	21.67	0.16	1.6
MP91C	Floodplain	2.50	0.40	2.50	0.71	2	28.40	0.36	1.6
MP91B	Floodplain	3.70	1.30	9.60	1.10	4	11.46	0.28	1.6
MP72B	Floodplain	2.30	0.50	4.50	2.43	16	54.00	0.15	1.6
MP65B	Floodplain	3.90	1.30	20.80	3.35	8	16.11	0.42	1.6
MP65B (repeat)	Floodplain	4.30	0.30	8.30	0.84	1	10.12	0.84	1.6
MP47C	Floodplain	3.10	0.60	9.60	0.24	3	2.50	0.08	1.6
MP42C	Floodplain	3.60	0.30	4.40	1.31	5	29.77	0.26	1.6
MP38B	Floodplain	1.00	0.40	12.00	1.29	8	10.75	0.16	1.6
MP35C	Floodplain	2.50	0.60	7.80	1.49	12	19.10	0.12	1.6
MP34B(repeat)	Floodplain	1.50	0.40	9.00	1.09	25	12.11	0.04	1.6
MP34B	Floodplain	1.50	0.40	12.60	1.38	14	10.95	0.10	1.6
MP2D (repeat)	Floodplain	1.80	0.30	1.90	4.70	11	247.37	0.43	1.6
MP2D	Floodplain	1.80	0.30	2.00	4.18	33	209.00	0.13	1.6
MP2C (repeat)	Floodplain	1.50	0.40	2.60	1.10	5	42.31	0.22	1.6
MP2C	Floodplain	1.50	0.40	5.70	23.30	69	408.77	0.34	1.6
MP109B	Floodplain	1.50	0.90	8.10	6.76	32	83.46	0.21	1.6
<b>TOTAL / AVE FLOODPLAIN</b>		<b>2.28</b>	<b>0.53</b>	<b>125.00</b>	<b>56.05</b>	<b>253</b>	<b>44.84</b>	<b>0.22</b>	

PIT NO.	GRAVEL TYPE	O/B THICK (m)	GRAVEL THICK (m)	GRAVEL VOLUME (m <sup>3</sup> )	CARATS	NO. STONES	GRADE (ct/100m <sup>3</sup> )	STONE SIZE (ct/stone)	BOTTOM SCREEN SIZE (mm)
MP47B	Palaeo channel	7.00	1.80	32.10	0.67	5	2.09	0.13	1.6
MP42B	Palaeo channel	4.70	0.90	12.80	0.28	2	2.19	0.14	1.6
MP3C	Palaeo channel	4.40	2.90	39.80	2.37	17	5.95	0.14	1.6
MP3B	Palaeo channel	6.00	0.70	13.70	0.19	2	1.39	0.10	1.6
MP39B	Palaeo channel	3.90	1.20	9.60	0.10	1	1.04	0.10	1.6
MP36B	Palaeo channel	6.20	1.80	18.00	3.55	14	19.72	0.25	1.6
MP35B	Palaeo channel	3.30	1.10	17.80	4.35	30	24.44	0.15	1.6
<b>TOTAL / AVE PALAEO CHANNEL</b>		<b>5.07</b>	<b>1.49</b>	<b>143.80</b>	<b>11.51</b>	<b>71</b>	<b>8.00</b>	<b>0.16</b>	

A total 78cts were recovered from the mega pitting exercise. The average stone size varies between 0.16ct/stone for the palaeo channel to 0.22ct/stone for the floodplain gravels.

## 17.5 Auger Drilling

Auger drilling commenced at Mvula Milenge in August 2007 and is still ongoing. A total of 30 holes had been drilled by December 2007. Five of these auger holes collapsed and no valuable information was recorded.

### 17.5.1 Sampling Method and Approach

Drilling was carried out on 4 north-south lines at a distance of 100m apart, in an area to the south of the Tshikapa River (Figure 40). These vertical holes were drilled at a distance of 50m apart along each line using the tractor mounted auger drill described in Section 11.6.1. The thicknesses of the gravel and overburden were measured in each hole. Holes are numbered sequentially with an alphabetical prefix to indicate the name of the drill line, eg. A1; C3. The majority of these holes were drilled to intersect palaeo-channel gravels.

### 17.5.2 Sample Preparation, Analyses and Security

No samples were taken from the auger holes.

### 17.5.3 Data Verification

Measurements of overburden and gravel thickness were entered into an Excel database by the local geologist on site and then verified by both PDF's expatriate and head office geologists.

### 17.5.4 Results

A summary of the results is shown in Table 63. These results were not included in the modelling as they had only recently been completed.

**Table 63 : Summary of Auger Drilling Results for Mvula Milenge Project Area**

GRAVEL TYPE	NO. OF PITS	AVE O/B THICK (m)	AVE GRAVEL THICK (m)
Blanket	0		
Floodplain	3	8.18	1.00
Palaeo channel	22	7.29	0.64
<b>TOTAL</b>	<b>25</b>		

## 17.6 Bulk Sampling

No bulk sampling has been carried out in the Mvula Milenge Project Area. This is scheduled to commence in the second quarter of 2009.

## 17.7 Adjacent Properties

Relevant information pertaining to the adjacent properties is discussed in the sections to follow as they are also held by PDF.

## 17.8 Mineral Processing and Metallurgical Testing

No mineral processing has taken place at Mvula Milenge to date.

## 17.9 Diamond Resource and Diamond Reserve Estimates

### 17.9.1 Previous Resource Statements

A Diamond Resource statement was issued for the Tshikapa River Project, which included the Mvula Milenge Project Area, on 1<sup>st</sup> May 2006 (Table 64). This was prepared by PDF's Qualified Person, Ms Helen Pein, and independently verified by Venmyn's Qualified Person, Ms Catherine Telfer.

**Table 64 : Previous Resource Statement for Tshikapa River Project (1st May 2006)**

MINE / PROJECT	PROJECT AREA	RESOURCE CLASSIFICATION	GRAVEL VOLUME (m <sup>3</sup> )	GRADE (ct/100m <sup>3</sup> )	CARATS	DIAMOND VALUE (US\$/ct)	BOTTOM SCREEN SIZE (mm)
Tshikapa River	Mvula Milenge	Inferred	5,816,000	10.00	581,600	150.00	1.6
	Nanzambi	Inferred	9,124,000	28.00	2,554,720	150.00	1.6
<b>GRAND TOTAL / AVE INFERRED RESOURCES</b>			<b>14,940,000</b>	<b>20.99</b>	<b>3,136,320</b>	<b>150.00</b>	<b>1.6</b>

This statement has subsequently been updated using the latest exploration results as described in the sections to follow.

### 17.9.2 Volume

The volume of the resources was estimated using the database of gravel thickness and modelled using Surfer®, as described in Section 11.10.2. The volume pertaining to each of the gravel types was modelled and estimated separately. These volumes were then reduced by the known mined out areas in the floodplain and blanket gravels. The resultant volumes are tabulated in Table 65.

**Table 65 : Volume Estimation for Mvula Milenge Project Area**

MINE / PROJECT	PROJECT AREA	GRAVEL TYPE	GRAVEL VOLUME (m <sup>3</sup> )
Tshikapa River	Mvula Milenge	Blanket	4,560,974
		Floodplain	905,237
		Palaeo channel	1,128,051
<b>TOTAL / AVE MVULA MILENGE PROJECT AREA</b>			<b>6,594,261</b>

### 17.9.3 Density

No density measurements are required as all resources were quoted in volumes.

### 17.9.4 Grade

The grade has been calculated per gravel type as a weighted average of all the mega pits which lie within the resource area defined above in the volume calculation. The grades are summarised in Table 66.

**Table 66 : Grade Calculation for Mvula Milenge Project Area**

MINE / PROJECT	PROJECT AREA	GRAVEL TYPE	REC. GRADE (ct/100m <sup>3</sup> )	CARATS
Tshikapa River	Mvula Milenge	Blanket	6.52	297,376
		Floodplain	62.85	568,941
		Palaeo channel	10.80	121,829
<b>TOTAL / AVE MVULA MILENGE PROJECT AREA</b>			<b>14.98</b>	<b>988,146</b>

### 17.9.5 Diamond Value

To date, no diamonds have been sold from the Tshikapa River Project as a sufficiently large parcel (at least 2,000cts) has not yet been produced. A total of 114cts has been produced from the Mvula Milenge and Nanzambi Project Areas combined.

An amount of 110cts of these carats were independently valued by a licensed diamond buyer in Kinshasa, DRC, in December 2007. The average price for the parcel is shown in Table 41. The estimated diamond price used in the resource statement for both the Mvula Milenge and Nanzambi Project Areas is US\$180/ct.

### 17.9.6 Current Resource Statement

The Diamond Resource statement for the Mvula Milenge Project Area, dated 1<sup>st</sup> March 2008, was prepared by Ms Helen Pein. This was independently verified by Ms Catherine Telfer of Venmyn through checking all the input parameters, the calculation mathematics and the classification logic. The statement for the Tshikapa River Project, including the Mvula Milenge Project Area is shown in Table 67.

**Table 67 : Diamond Resource Statement for the Tshikapa River Project (1<sup>st</sup> March 2008)**

MINE / PROJECT	PROJECT AREA	RESOURCE CLASSIFICATION	GRAVEL VOLUME (m <sup>3</sup> )	REC. GRADE (ct/100m <sup>3</sup> )	CARATS	DIAMOND VALUE (US\$/ct)	BOTTOM SCREEN SIZE (mm)
Tshikapa River	Mvula Milenge	Inferred	6,594,000	14.98	988,107	180	1.6
	Nanzambi	Inferred	9,933,605	23.81	2,365,405	180	1.6
<b>GRAND TOTAL / AVE INFERRED RESOURCES</b>			<b>16,527,605</b>	<b>20.29</b>	<b>3,353,512</b>	<b>180</b>	<b>1.6</b>

All resources are classified as Inferred due to the low confidence associated with the grade and the lack of a sufficiently large parcel sold in today's market. The logic used in the classification is tabulated in Appendix 4. The location of the Diamond Resources, in relation to the project area, is illustrated in Figure 42.

There are no known items relating to the environment, permits, legal, title, taxation, socio-economic, marketing, political or any other issue that would have a material effect on the resources identified in the current Diamond Resource statement.

### 17.10 Other Relevant Data and Information

There is no other relevant data or information which should be presented to ensure that this report is not misleading in any way.

### 17.11 Interpretation and Conclusions

The recent exploration on Mvula Milenge has confirmed the latest geological model for the DRC projects. Four gravel types have been identified, three of which form the focus of PDF's exploration in the area. These are namely; the palaeo channel gravels, floodplain gravels and blanket gravels.

The extensive and detailed exploration through prospecting and jimbo pitting has provided sufficient information on the gravel and overburden thicknesses to allow computerised modelling and a more accurate determination of volumes as compared to previously.

Modelling has indicated that the gravel thicknesses are variable. The palaeo channel gravels have an average thickness of over 1m, whilst those pertaining to the floodplain and blanket gravels are just less than 1m.

Grade information has been provided, for the various gravel types, through the prospecting and mega pitting exercises. PDF have identified a trend of increasing grade from the blanket deposits towards the paleo-channel deposits. The grade results obtained from the exploration will be verified through the bulk sampling exercise commencing in the second quarter of 2009.





An initial independent diamond valuation, indicative of today's market, has been provided for a small parcel. The bulk sampling programme will provide the carats required (at least 2,000cts) to increase confidence in the diamond value.

The exploration results have been verified and the methods independently checked by Venmyn. We are of the opinion that the results are reliable and that the data density, quantity and quality are sufficient for the delineation of Inferred Resources for Mvula Milenge.

### 17.12 Recommendations

The recommended work programme for the DRC projects, including the Tshikapa River Project is tabulated in Table 44. Venmyn has assisted PDF in the compilation of the work programme and budget in respect of the Tshikapa River Project and recommends that the company undertake the programme as stated therein. The expected revenues to be derived from the sale of diamonds extracted during exploration pitting, bulk sampling and pilot mining are shown in Table 45.

**LEGEND:**

-  River
-  Tributary
-  Palaeo Gravel
-  Floodplain Gravel
-  Blanket Gravel

**LOCATION OF DIAMOND RESOURCES FOR THE MVULA MILENGE PROJECT AREA**

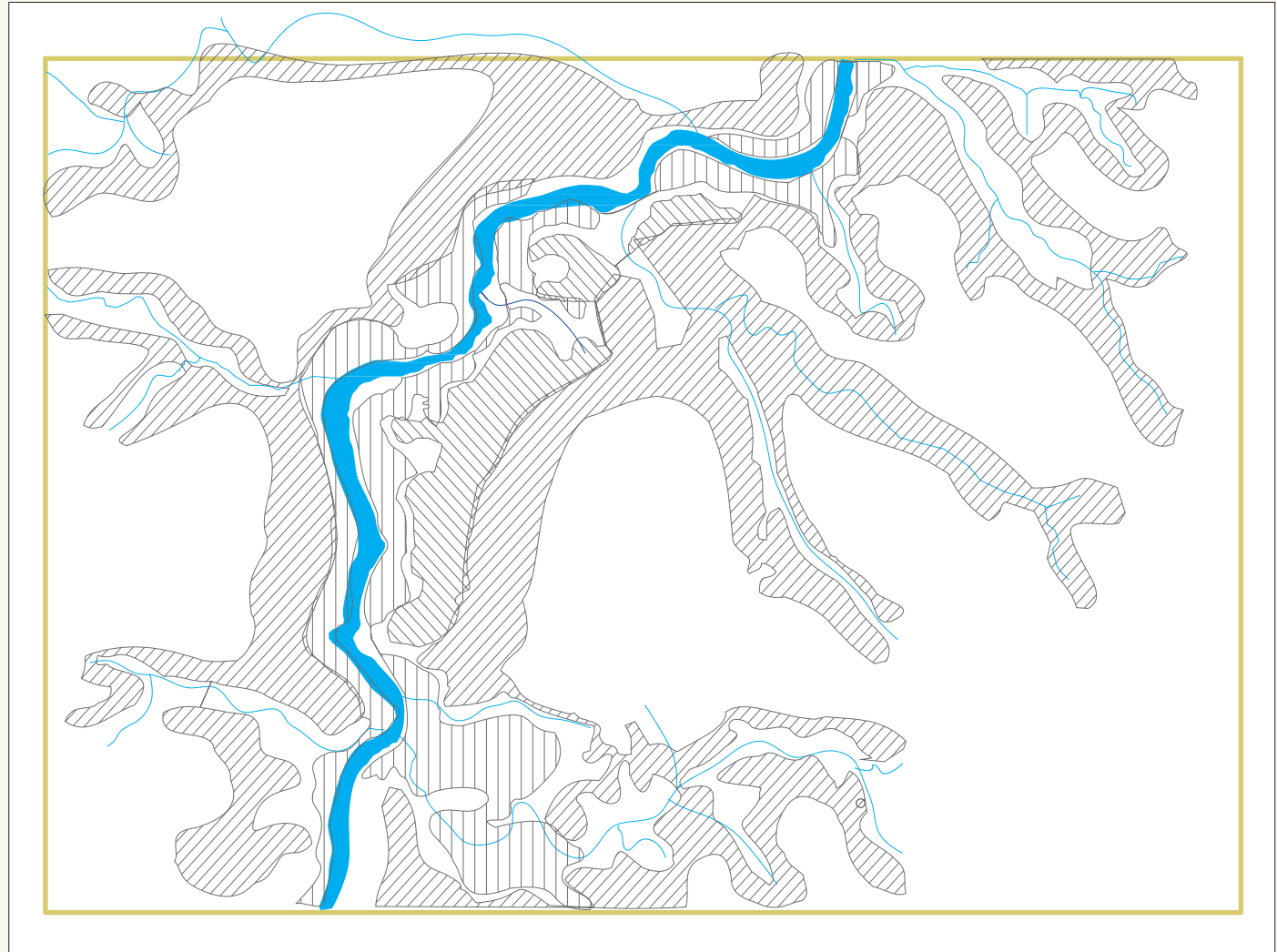
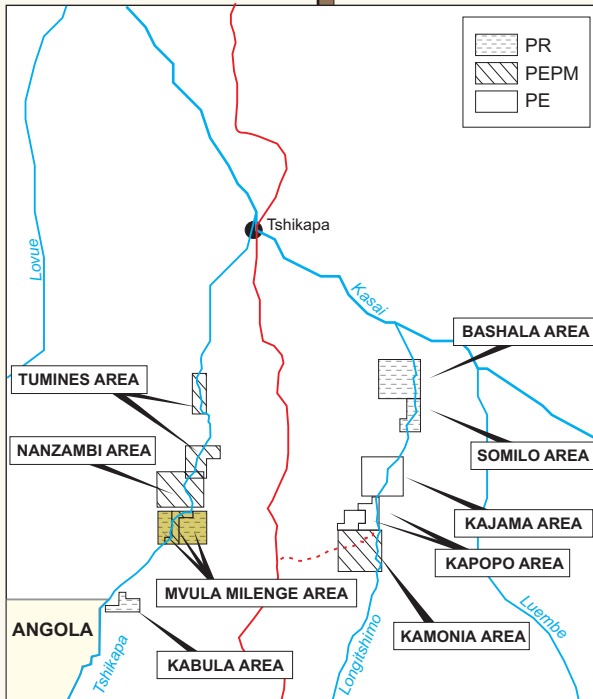

MINE / PROJECT	PROJECT AREA	GRAVEL TYPE	GRAVEL VOLUME (m <sup>3</sup> )	REC. GRADE (ct/100m <sup>3</sup> )	CARATS	DIAMOND VALUE (US\$/ct)	BOTTOM SCREEN SIZE (mm)
Tshikapa River	Mvula Milenge	Palaeo channel	1,128,051	10.80	121,829	180	1.6
		Floodplain	905,237	62.85	568,941	180	1.6
		Blanket	4,560,974	6.52	297,376	180	1.6
<b>TOTAL / AVE MVULA MILENGE PROJECT AREA</b>			<b>6,594,261</b>	<b>14.98</b>	<b>988,146</b>	<b>180</b>	<b>1.6</b>

*Includes reduction due to mined out areas*  
*Includes reduction due to mined out areas*

## 18 TSHIKAPA RIVER PROJECT – NANZAMBI PROJECT AREA

The Nanzambi Project Area is located to the north of Mvula Milenge, but the project areas are separated by a 0.42km strip of land (Figure 24 and Figure 25).

### 18.1 Exploration

The exploration method used for Nanzambi is the same as that utilised for the DRC projects (Section 11.1). PDF has carried out mapping and a small amount pitting within the concession.

### 18.2 Reconnaissance Mapping

PDF commenced reconnaissance mapping in May 2006 as described in Section 11.2. The resultant geological map is illustrated on Figure 43 along with the sample positions. All results from the pitting programmes were also used to maintain an updated geological map of the area.

### 18.3 Prospecting Pitting

Prospecting pitting also commenced in May 2006 and was carried out by artisanal miners in the area. A total of 8 pits were excavated.

#### 18.3.1 Sampling Method and Approach

The prospecting pits were not excavated by PDF. The pits were excavated by the local artisanal miners and the gravels purchased from them. This method proved to be both time and cost effective. The pits were all surveyed and mapped by the PDF geologist.

Figure 43 indicates the position of the prospecting pits within Nanzambi. The pits were numbered sequentially with a PD prefix to indicate that they were pits excavated within the Nanzambi concession. This concession was originally called Dier, after the local DRC agent who held the tenure.

#### 18.3.2 Sample Preparation, Analyses and Security

The purchased gravels were then bagged and transported to the nearest river for hand washing or processing using jigs. All washing and diamond extraction took place under the direct supervision of the PDF geologist on site. The washing process is described in Section 11.3.2.

#### 18.3.3 Data Verification

As noted in Section 11.3.3, all results were entered into an Excel spreadsheet and these were checked and verified by the PDF geologist at their head office in South Africa.

#### 18.3.4 Results

The summary of results for the prospecting pitting, according to gravel type, is tabulated in Table 60.

**Table 68 : Summary Prospecting Pitting Results for Nanzambi Project Area**

PIT NO.	GRAVEL TYPE	O/B THICK (m)	GRAVEL THICK (m)	GRAVEL VOLUME (m <sup>3</sup> )	CTS	NO. STONES	GRADE (ct/100m <sup>3</sup> )	STONE SIZE (ct/stone)	BOTTOM SCREEN SIZE (mm)
PD 5	Blanket	0.90	2.50	2.00	0.40	8	20.00	0.05	1.6
PD 8	Blanket	2.80	2.10	1.50	0.45	7	30.00	0.06	1.6
<b>TOTAL / AVE BLANKET</b>			<b>2.33</b>	<b>3.50</b>	<b>0.85</b>	<b>15</b>	<b>24.29</b>	<b>0.06</b>	<b>1.6</b>
PD 1	Floodplain	1.50	1.00	2.00	0.45	5	22.50	0.09	1.6
PD 4	Floodplain	4.10	0.40	2.00	0.85	5	42.50	0.17	1.6
<b>TOTAL / AVE FLOODPLAIN</b>			<b>0.70</b>	<b>4.00</b>	<b>1.30</b>	<b>10</b>	<b>32.50</b>	<b>0.13</b>	<b>1.6</b>
PD 2	Palaeo channel	3.80	0.45	2.00	0.60	1	30.00	0.60	1.6
PD 3	Palaeo channel	8.30	0.40	2.00	0.15	3	7.50	0.05	1.6
PD 6	Palaeo channel	3.70	0.50	1.50	0.25	3	16.67	0.08	1.6
PD 7	Palaeo channel	1.80	0.40	2.00	1.05	1	52.50	1.05	1.6
<b>TOTAL / AVE PALAEO CHANNEL</b>			<b>0.43</b>	<b>7.50</b>	<b>2.05</b>	<b>8</b>	<b>27.33</b>	<b>0.26</b>	<b>1.6</b>

**EXTENT OF GRAVELS AND SAMPLE POSITION FOR THE NANZAMBI PROJECT AREA**

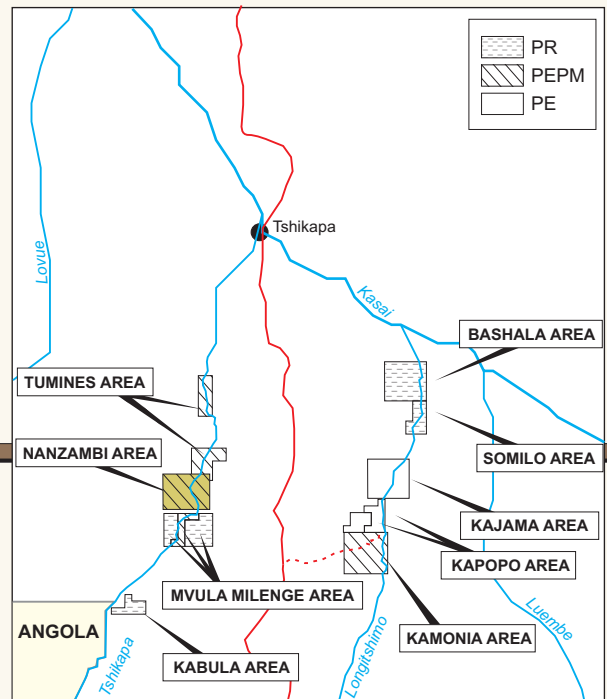
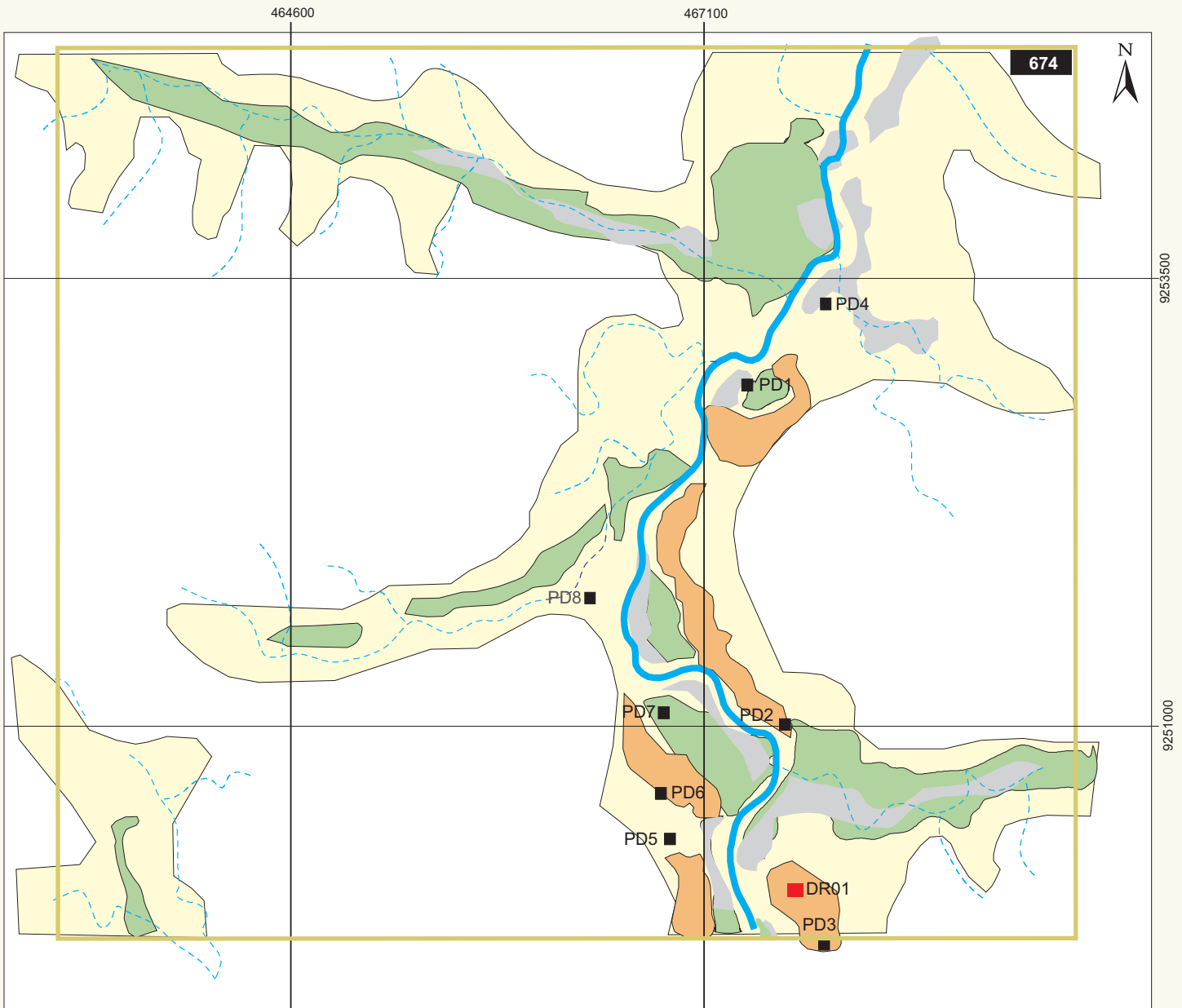

PangeaDFieldsTSX'07Fig43.cdr

**LEGEND:**

- Blanket Gravel
- Palaeo Gravel
- Floodplain Gravel
- Mined Area
- Pits dug by Pangea 2005

This diagram and the information therein are copyrighted. It may not be reproduced or transmitted in any form or by any means without prior written permission from Venmyn Rand (Pty) Ltd. Trading as Venmyn.



The same model as used on the Mvula Milenge Project Area has been extended northwards to include the Nanzambi Project Area. The current pit results together with field mapping and satellite interpretation has been used to assist in delineating the gravel types. The limits of the various gravels are indicated on Figure 43.

A total of 4.20cts was recovered from the prospecting pitting. The average stone size is shown in Table 68.

#### 18.4 Jimbo Pitting

No jimbo pitting has been carried out on Nanzambi.

#### 18.5 Mega Pitting

A single mega pit had been excavated on the concession.

##### 18.5.1 Sampling Method and Approach

The mega pits was 4x4m in size and sited in an area of good gravel development and a reasonable stripping ratio. This hand dug pits was numbered DP01. Further details on the method are provided in Section 11.5.1.

##### 18.5.2 Sample Preparation, Analyses and Security

The sample was processed using the Boesman jig as described in Section 10.1.2.

##### 18.5.3 Data Verification

The result was recorded into a database which was verified by PDF's head office staff.

##### 18.5.4 Results

The mega pitting result is tabulated in Table 69.

**Table 69 : Summary Mega Pitting Results for Nanzambi Project Area**

PIT NO.	GRAVEL TYPE	OVERBURDEN THICK (m)	GRAVEL THICK (m)	GRAVEL VOLUME (m <sup>3</sup> )	CARATS	NO. STONES	GRADE (ct/100m <sup>3</sup> )	STONE SIZE (ct/stone)	BOTTOM SCREEN SIZE (mm)
DR01	Palaeo channel	6.60	1.10	3.10	0.11	1	3.55	0.11	1.6

A single diamond of 0.11cts was recovered from the mega pitting exercise.

#### 18.6 Auger Drilling

No auger drilling has been carried out within Nanzambi.

#### 18.7 Bulk Sampling

No bulk sampling has been carried out in the Nanzambi Project Area.

#### 18.8 Adjacent Properties

Relevant information pertaining to the adjacent properties is discussed in the previous sections as they are also held by PDF.

#### 18.9 Mineral Processing and Metallurgical Testing

No mineral processing has taken place at Nanzambi to date.

## 18.10 Diamond Resource and Diamond Reserve Estimates

### 18.10.1 Previous Resource Statements

A Diamond Resource statement was issued for the Tshikapa River Project, which included the Nanzambi Project Area, on 1<sup>st</sup> May 2006 (Table 64). This was prepared by PDF's Qualified Person, Ms Helen Pein, and independently verified by Venmyn's Qualified Person, Ms Catherine Telfer. This statement has subsequently been updated using the results from the mega pit.

### 18.10.2 Volume

The volume of each of the gravel horizons were calculated from the mapped areas and multiplied by the average gravel thicknesses as determined from the straight average of the pitting results. The extent of the gravels was determined excluding the mined out areas which was estimated at 7%.

No computerised modelling was undertaken due to the limited number of pits in the area. The volume calculation is shown in Table 70.

**Table 70 : Volume Estimation for Nanzambi Project Area**

MINE / PROJECT	PROJECT AREA	AREA (m <sup>2</sup> )	AVE GRAVEL THICK (m)	GRAVEL VOLUME (m <sup>3</sup> )
Tshikapa River	Nanzambi	10,136,331	0.98	9,933,605

The delineation of the gravels closely corresponds to the limit of the gravels, as defined by extensive exploration at Mvula Milenge, Kamonia and Kapopo, providing confidence in the delineation method.

### 18.10.3 Density

No density measurements are required.

### 18.10.4 Grade

The weighted average grade of the mega and prospecting pits was used in the diamond resource statement (Table 71). The same grade was used for all gravels present.

**Table 71 : Grade Calculation for Nanzambi Project Area**

MINE / PROJECT	PROJECT AREA	GRAVEL TYPE	REC. GRADE (ct/100m <sup>3</sup> )	CARATS
Tshikapa River	Nanzambi	Various	23.81	2,365,405
<b>TOTAL / AVE NANZAMBI PROJECT AREA</b>			<b>23.81</b>	<b>2,365,405</b>

### 18.10.5 Diamond Value

The diamond value, as discussed in Section 17.9.5, was applied to the Nanzambi Project Area, i.e. US\$180/ct.

### 18.10.6 Current Resource Statement

The Diamond Resource statement for the Nanzambi Project Area, dated 1<sup>st</sup> March 2008, was prepared by Ms Helen Pein. This was independently verified by Ms Catherine Telfer of Venmyn through checking all the input parameters, the calculation mathematics and the classification logic. The statement for the Tshikapa River Project, including the Nanzambi Project Area is shown in Table 67.

All diamond resources were classified as Inferred due to the low confidence associated with the volume (i.e. no modelling), grade and the lack of a sufficiently large parcel sold in today's market. The logic used in the classification is tabulated in Appendix 4. The location of the Diamond Resources, in relation to the project area, is illustrated in Figure 44.

There are no known item relating to the environment, permits, legal, title, taxation, socio-economic, marketing, political or any other issue that would have a material effect on the resources identified in the current Diamond Resource statement.

#### **18.11 Other Relevant Data and Information**

There is no other relevant data or information which should be presented to ensure that this report is not misleading in any way.

#### **18.12 Interpretation and Conclusions**

Only limited exploration that has been conducted on the Nanzambi Project Area. No computerised modelling has been carried out and as a result the Diamond Resource area remains unchanged since the previous Resource statement was issued in May 2006.

An initial independent diamond valuation, indicative of today's market, has been provided for a small parcel from an adjacent project.

The exploration results to date have been verified and the methods independently checked by Venmyn. We are of the opinion that the results are reliable and that the data density, quantity and quality are sufficient for the delineation of Inferred Resources for .

#### **18.13 Recommendations**

The recommended work programme for the DRC projects, including the Tshikapa River Project is tabulated in Table 44. The expected revenues to be derived from the sale of diamonds extracted during exploration pitting, bulk sampling and pilot mining are shown in Table 45.

### **19 TSHIKAPA RIVER PROJECT – TUMINES PROJECT AREA**

The Tumines Project Area is comprised of two concessions, one located adjacent to and directly north of the Nanzambi Project Area and the other located 4.5km to the north (Figure 24 and Figure 25).

#### **19.1 Exploration**

PDF obtained the rights to Tumines in May 2007. As a result of its recent acquisition and the focus of activities on Mvula Milenge, no exploration has been conducted on the property.

#### **19.2 Reconnaissance Mapping**

Limited reconnaissance mapping and field visits were conducted on the Tumines Project Area has been carried out for the Tumines Project Area.

#### **19.3 Prospecting Pitting**

No prospecting pitting has been carried out at Tumines.

#### **19.4 Jimbo Pitting**

No jimbo pitting has commenced in the Tumines Project Area.

#### **19.5 Mega Pitting**

No mega pitting has been carried out.

#### **19.6 Auger Drilling**

No auger drilling has been undertaken at Tumines.

#### **19.7 Bulk Sampling**

No bulk sampling has been carried out within the Tumines Project Area.

**LEGEND:**

- Resource Area
- River
- Project Area

**LOCATION OF DIAMOND RESOURCES FOR THE NANZAMBI PROJECT AREA**

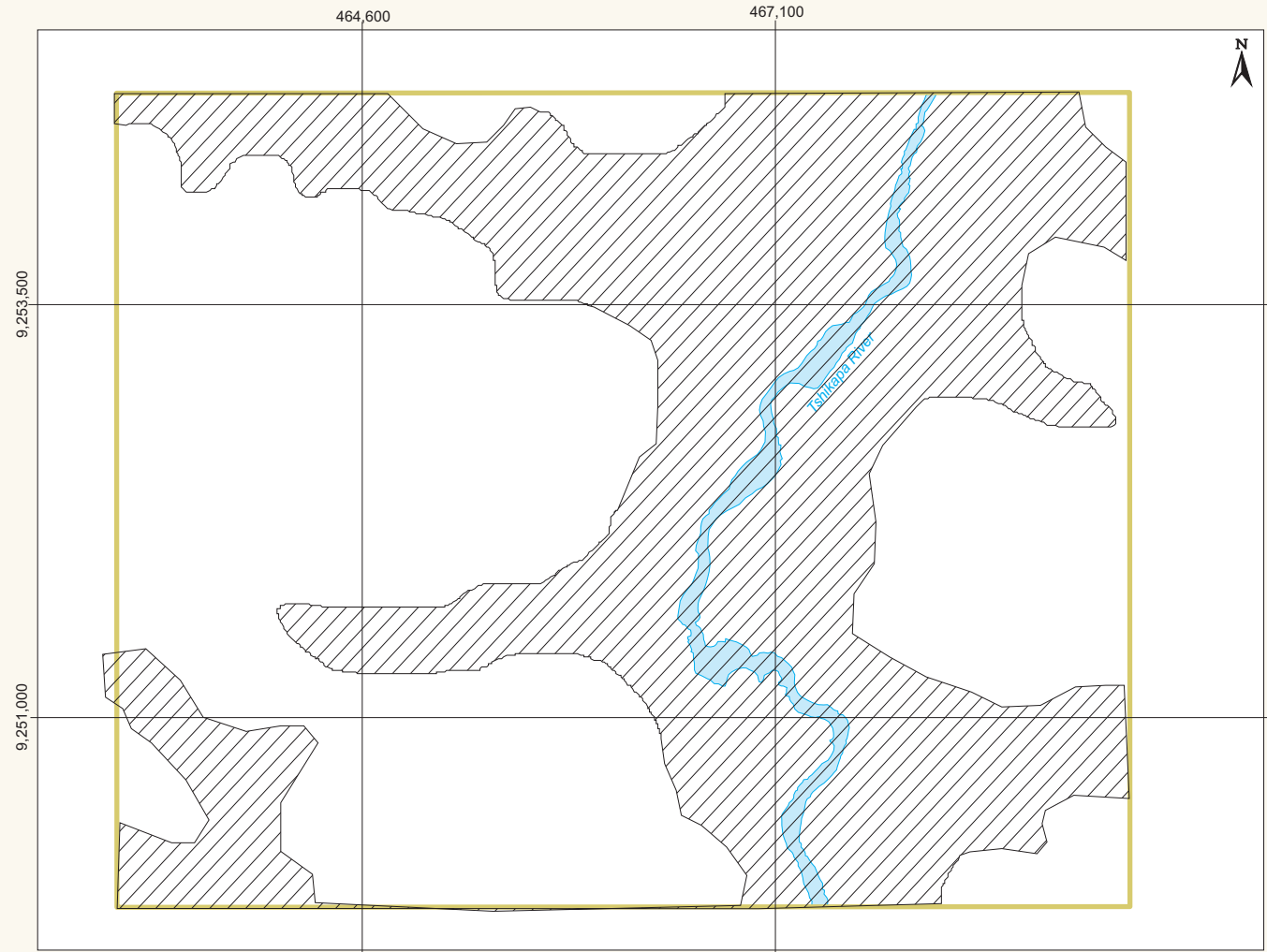
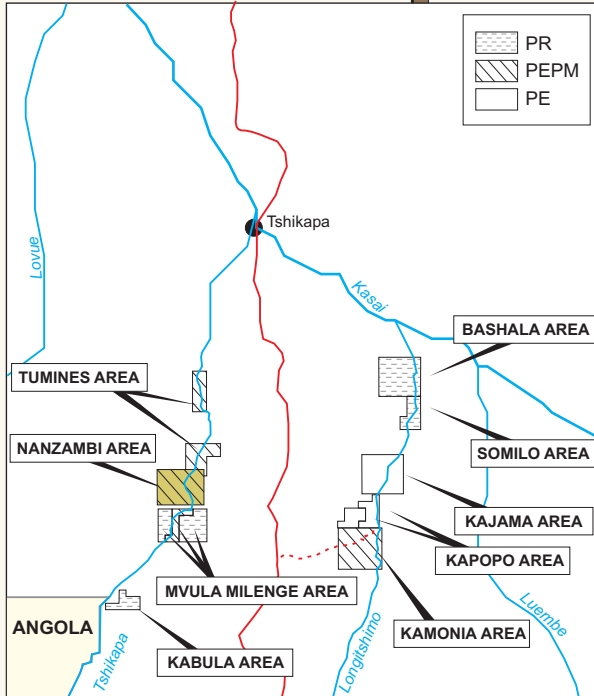

MINE / PROJECT	PROJECT AREA	GRAVEL TYPE	AVE GRAVEL THICKNESS (m)	AREA (m <sup>2</sup> )	GRAVEL VOLUME (m <sup>3</sup> )	REC. GRADE (ct/100m <sup>3</sup> )	CARATS	DIAMOND VALUE (US\$/ct)	BOTTOM SCREEN SIZE (mm)
Tshikapa River	Nanzambi	N/A	0.98	10,136,331	9,933,605	23.81	2,365,405	180	1.6
<b>TOTAL / AVE NAMINCO PROJECT AREA</b>					<b>9,933,605</b>	<b>23.81</b>	<b>2,365,405</b>	<b>180</b>	<b>1.6</b>

This diagram and the information therein are copyrighted. It may not be reproduced or transmitted in any form or by any means without prior written permission from Venmyn Rand (Pty) Ltd. Trading as Venmyn.

### 19.8 Adjacent Properties

Information relating to adjacent properties was discussed in the previous section.

### 19.9 Mineral Processing and Metallurgical Testing

No mineral processing has occurred at Tumines to date.

### 19.10 Diamond Resource and Diamond Reserve Estimates

No previous or current Diamond Resource statements are available for Tumines.

### 19.11 Other Relevant Data and Information

There is no other relevant data or information which should be presented to ensure that this report is not misleading in any way.

### 19.12 Interpretation and Conclusions

Due to the paucity of exploration results, no interpretations or conclusions can be made.

### 19.13 Recommendations

The recommended work programme for the DRC projects, including the Tshikapa River Project is tabulated in Table 44. The expected revenues to be derived from the sale of diamonds extracted during exploration pitting, bulk sampling and pilot mining are shown in Table 45.

## 20 TSHIKAPA RIVER PROJECT – KABULA PROJECT AREA

The Kabula Project Area is situated on the Angola border 25km to the south of the Mvula Milenge Project Area (Figure 24 and Figure 25). The nearest large village is Kamabonzo which is situated approximately 5km south of the concession.

### 20.1 Exploration

As was the case for Tumines, the recent acquisition of Kabula and the focus of PDF on Mvula Milenge have resulted in only a small amount of exploration being conducted on the property.

### 20.2 Reconnaissance Mapping

Limited reconnaissance mapping was carried out for the Kabula Project Area. A large floodplain in the southwest corner of the concession was identified as a positive initial target area.

### 20.3 Prospecting Pitting

Two prospecting pits were excavated by PDF during July and August 2007.

#### 20.3.1 Sampling Method and Approach

The prospecting pits were excavated by hand using contract labour and the pits surveyed and mapped by a geotechnician contracted to PDF. The locations of the pits are indicated on Figure 45. The pits were excavated to a size of 4m x 4m.

The pits were numbered sequentially with a K prefix to indicate that they were excavated within the Kabula Project Area. An additional E or W in the prefix indicates direction in relation to each other. The first pits excavated for Kabula were incorrectly sited and the results therefore cannot be utilised.

#### 20.3.2 Sample Preparation, Analyses and Security

The gravels were removed, bagged and transported to the nearest river for hand washing. All washing and diamond extraction took place under the direct supervision of the geotechnician on site. The washing process is described in Section 11.3.2.

#### 20.3.3 Data Verification

As noted in Section 11.3.3, all results were entered into an Excel spreadsheet and these were checked and verified by the PDF geologist at their head office in South Africa.

**LEGEND:**

- River
- Project Area
- Road
- Pits

**LOCATION OF PITS ON THE KABULA PROJECT AREA**

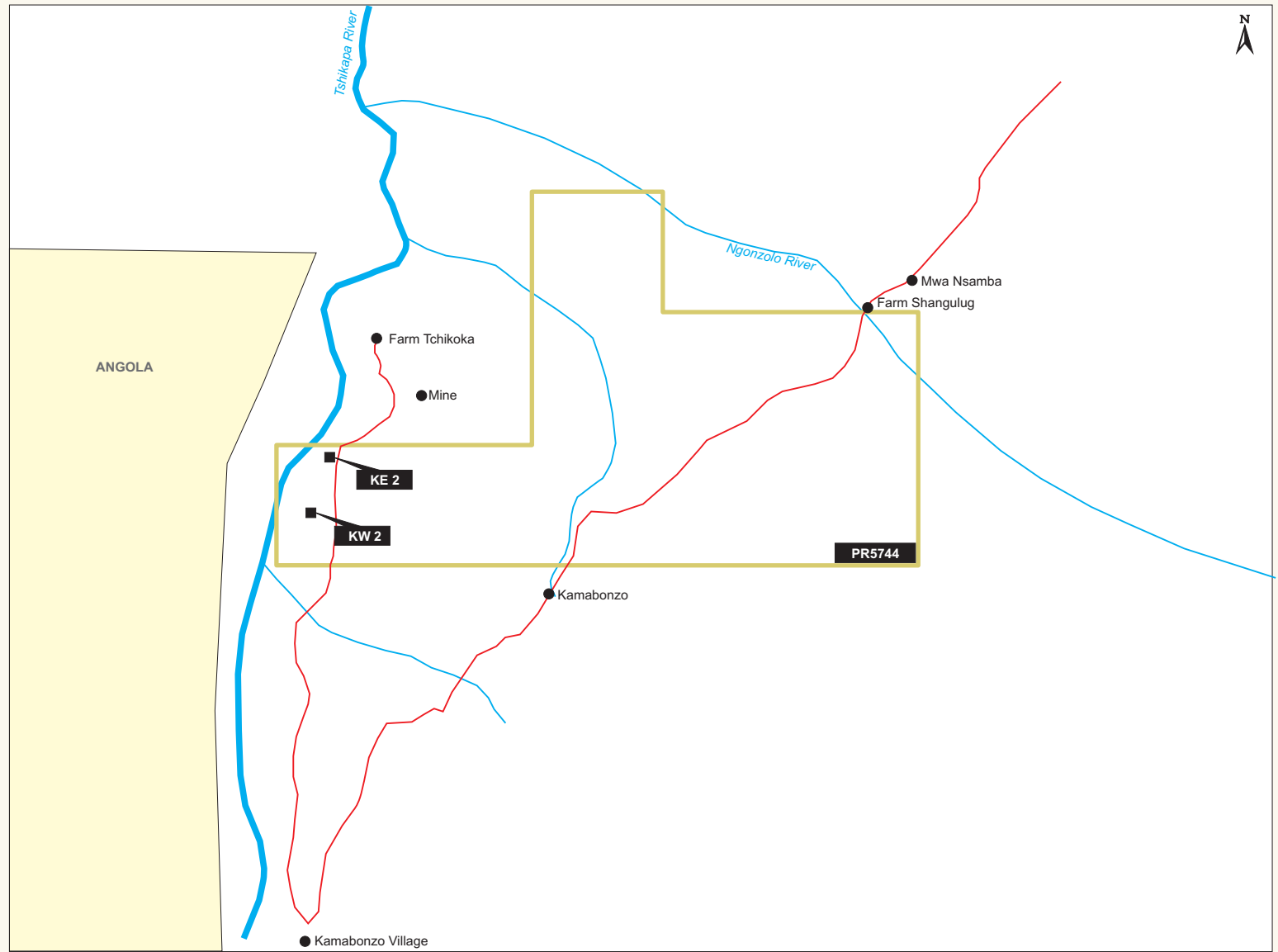
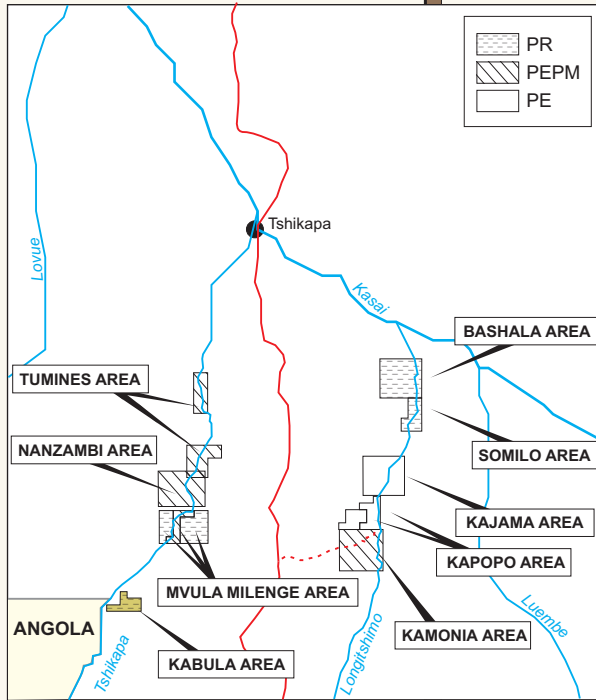

This diagram and the information therein are copyrighted. It may not be reproduced or transmitted in any form or by any means without prior written permission from Venmyn Rand (Pty) Ltd. Trading as Venmyn.

### 20.3.4 Results

The summary of the results for the pits are tabulated in Table 72. The grade results have been poor.

**Table 72 : Prospecting Pit Results for Kabula Project Area**

PIT NO.	GRAVEL TYPE	O/BTHICK (m)	GRAVEL THICK (m)	GRAVEL VOLUME (m <sup>3</sup> )	CARATS	NO. STONES	GRADE (ct/100m <sup>3</sup> )	STONE SIZE (ct/stone)	BOTTOM SCREEN SIZE (mm)
KE2	N/A	5.96	0.43	6.80	0.29	N/A	4.26	N/A	1.6
KW2	N/A	4.44	1.08	17.23	0.00	0	0.00		1.6
<b>TOTAL</b>				<b>24.03</b>	<b>0.29</b>		1.21		

### 20.4 Jimbo Pitting

No jimbo pitting has commenced in the Kabula Project Area.

### 20.5 Mega Pitting

No mega pitting has been carried out.

### 20.6 Auger Drilling

No auger drilling has been undertaken at Kabula.

### 20.7 Bulk Sampling

No bulk sampling has been carried out within the Kabula Project Area.

### 20.8 Adjacent Properties

No information is available for the properties directly adjacent to Kabula.

### 20.9 Mineral Processing and Metallurgical Testing

No mineral processing has occurred at Kabula to date.

### 20.10 Diamond Resource and Diamond Reserve Estimates

No previous or current Diamond Resource statements are available for Kabula.

### 20.11 Other Relevant Data and Information

There is no other relevant data or information which should be presented to ensure that this report is not misleading in any way.

### 20.12 Interpretation and Conclusions

Due to the paucity of exploration results, no interpretations or conclusions can be made, although initial sampling has indicated a low grade. It is expected that better grade results will be achieved from pits situated closer to the Tshikapa River.

### 20.13 Recommendations

The recommended work programme for DRC projects, including the Tshikapa River Project is tabulated in Table 44. The expected revenues to be derived from the sale of diamonds extracted during exploration pitting, bulk sampling and pilot mining are shown in Table 45.

## 21 ANGOLAN PROJECT

PDF has interests in a single project, Cassanguidi, in northeastern Angola. The Cassanguidi Project has been divided into four project areas which range in development from advanced exploration to pilot mining (Figure 46 and Figure 47).

## 22 CASSANGUIDI PROJECT

The Cassanguidi Project is currently extracting alluvial diamonds through a pilot mining operation. It has been divided into four project areas namely; Cassanguidi South, Cabuaquece, Catchoque and Cale (Figure 48). Pilot mining is currently being carried out at Cassanguidi South using conventional openpit methods and processing through a diamond pan plant.

### 22.1 Property Description and Location

The Cassanguidi Project is located in the Lunda Norte Province of northeastern Angola, approximately 16km from the DRC border (Figure 46 and Figure 48). The north flowing Luembe River passes through the concession. The size of the concession along with its coordinates are summarised in Table 73.

**Table 73 : Cassanguidi Project Area and Boundary Coordinates**

PROJECT	PROJECT AREA	LICENSE TYPE	PERMIT NO.	AREA (km <sup>2</sup> )	AREA (ha)	BOUNDARY COORDINATES (LATITUDE, LONGITUDE)
Cassanguidi	Cassanguidi South	Mining	N/A (PROESDA)	112.5	11,250	(07°25'13"S; 21°15'13"E);
	Cabuaquece					(07°25'13"S; 21°24'57"E);
	Cale					(07°28'41"S; 21°24'57"E);
	Cachoque					(07°28'41"S; 21°15'13"E)

The coordinates of the license boundaries were provided by the government in the official documentation. Although these have not been surveyed on the ground by PDF, they have been confirmed using the satellite image for the property.

Alluvial diamond mineralisation is associated with the Luembe River, its tributaries and the hillwash deposits within the interfluvial areas. This mineralisation was extensively exploited in the tributaries between 1956 and 1987. Mined out areas are identified and illustrated on Figure 48.

#### 22.1.1 Legal Aspects and Tenure

All minerals in Angola belong to the State. The Geological and Mining Activities Act (Law No. 1 of 1992 and Law 16 of 1994) governs the industry which includes prospecting, mining, processing and marketing. According to the Act, rights can be granted to State owned and/or private companies for a Prospecting Title or a Mining Title. The rights take the form of a contract negotiated between the companies concerned and the State, and are not transferable without State consent. The State requires a report indicating the technical and economic viability (E.V.T-E.) of the project prior to awarding the various titles.

With respect to the diamond mining sector, the Diamonds Act (Law No. 16 of 1994) grants the exclusive right to diamonds to Empresa Nacional de Diamantes de Angola (Endiama). This parastatal organisation was established in 1981 from the previous State owned company, Companhia de Diamantes de Angola (Diamang). Diamang and subsequently Endiama historically explored for and sampled diamond deposits across the country.

In 1999 Endiama created a subsidiary, the Diamond Commercialisation Society of Angola (Sodiam), which controls the marketing of diamonds in Angola. All diamonds must be sold in Angola using the services of Sodiam.

In order for a private company to obtain a mineral right to diamonds in Angola, all ventures require that Endiama be a partner in the operation. The share in the partnership is negotiated on a case by case basis from an initial maximum 50% interest for Endiama.



**INFRASTRUCTURE AND LOCALITY PLAN OF PDF'S ANGOLA PROJECT**

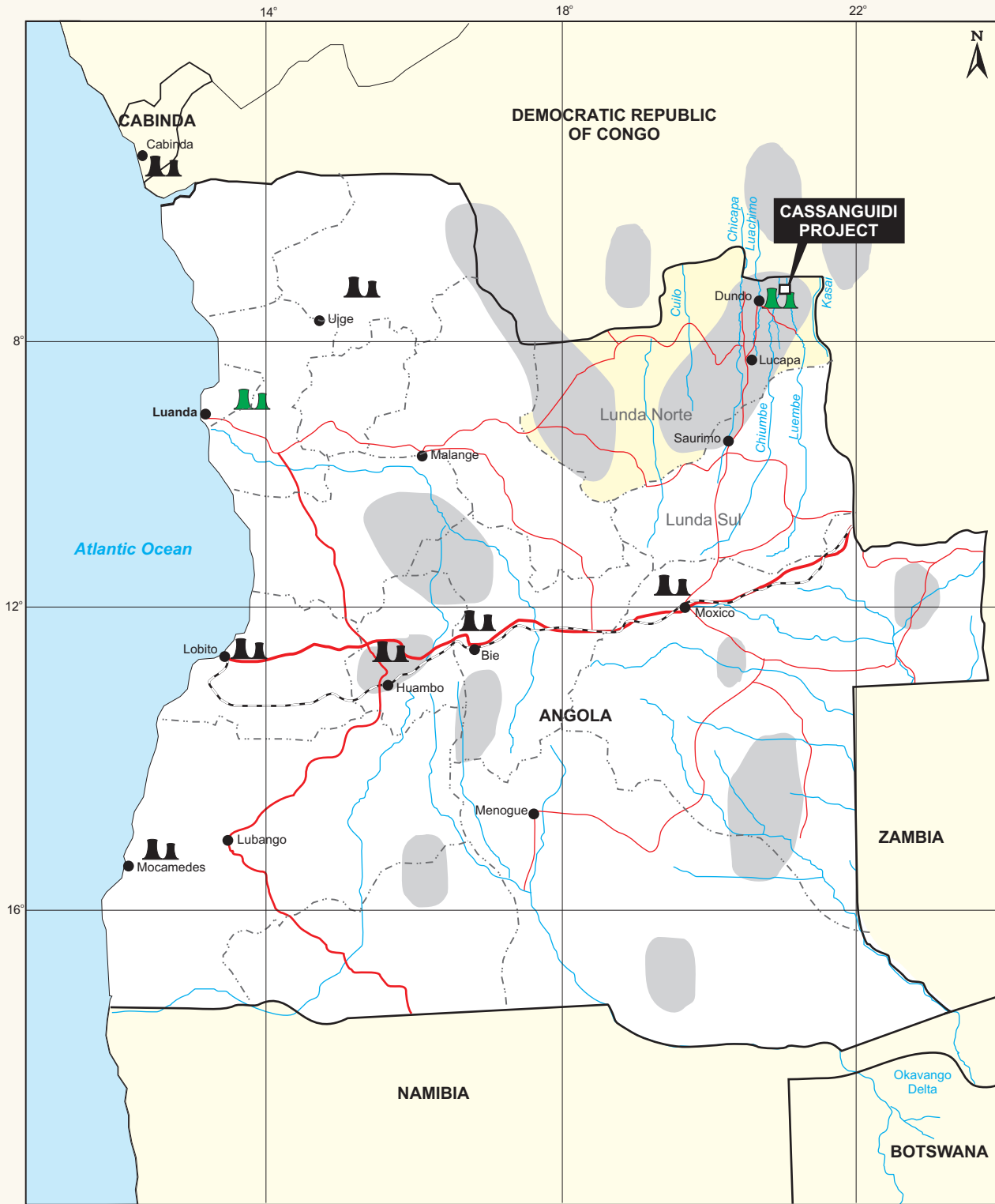

Source: I992 MAGELLAN GeographixSM

**LEGEND:**

- Lunda Norte Province
- Main Road
- Other Road
- Defunct Railway
- Active Power Station
- Defunct Power Station
- Diamond Occurrence
- River

**SCALE:**



This diagram and the information therein are copyrighted. It may not be reproduced or transmitted in any form or by any means without prior written permission from Venmyn Rand (Pty) Ltd. Trading as Venmyn.



**INFRASTRUCTURE OF NORTHEASTERN ANGOLA**

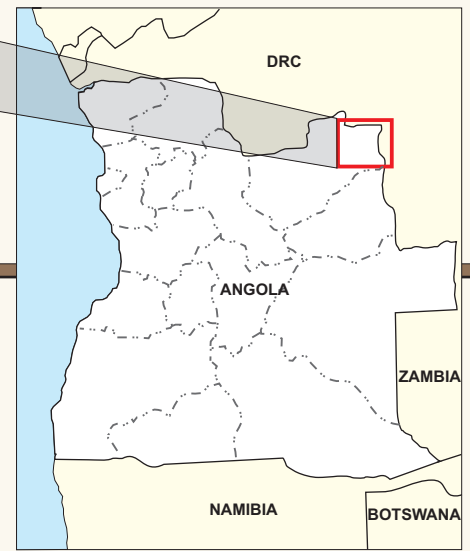
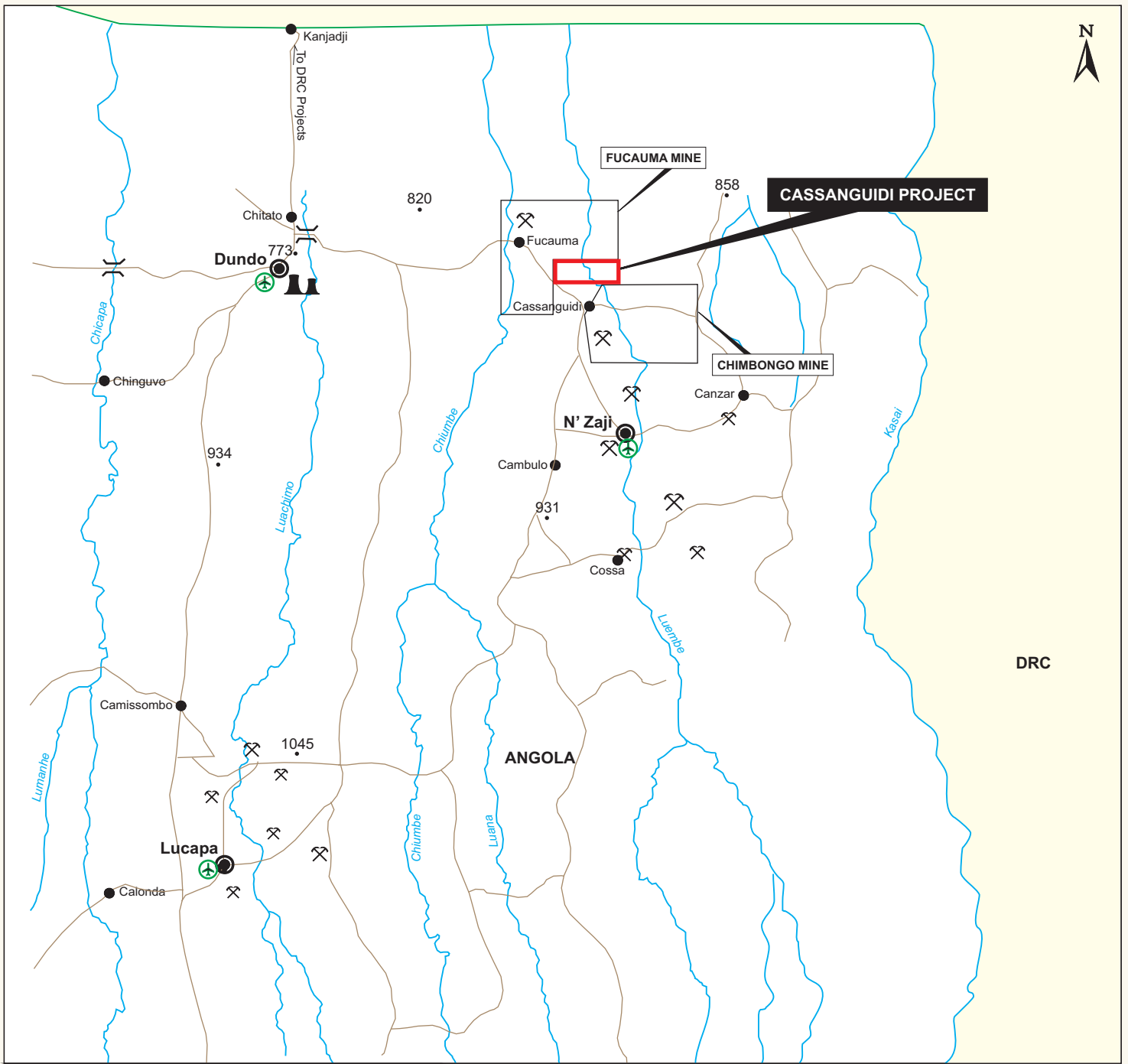

PangeaDFieldsTSX'07Fig47.cdr

Source: Carta Geologica de Angola, Scale 1: 1 000 000

**LEGEND:**

- Bridge
- River
- Road
- Historical and Operating Mine
- Operational Airstrip
- Project Area
- Power
- 1045 Spot Height (m amsl)

**SCALE:**



This diagram and the information therein are copyrighted. It may not be reproduced or transmitted in any form or by any means without prior written permission from Venmyn Rand (Pty) Ltd. Trading as Venmyn.

**CASSANGUIDI PROJECT INFRASTRUCTURE AND SATELLITE IMAGE**

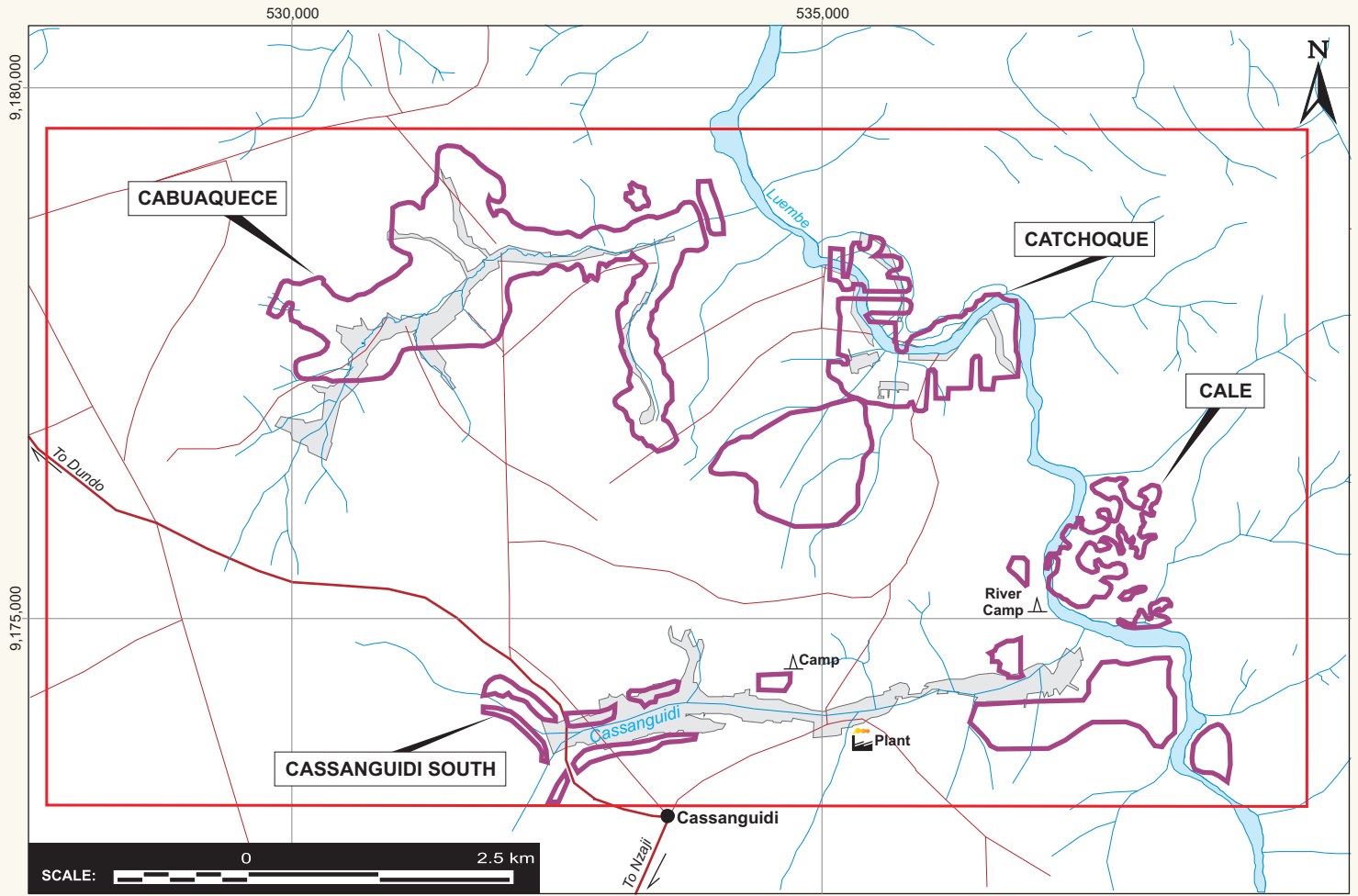

**SATELLITE IMAGE**

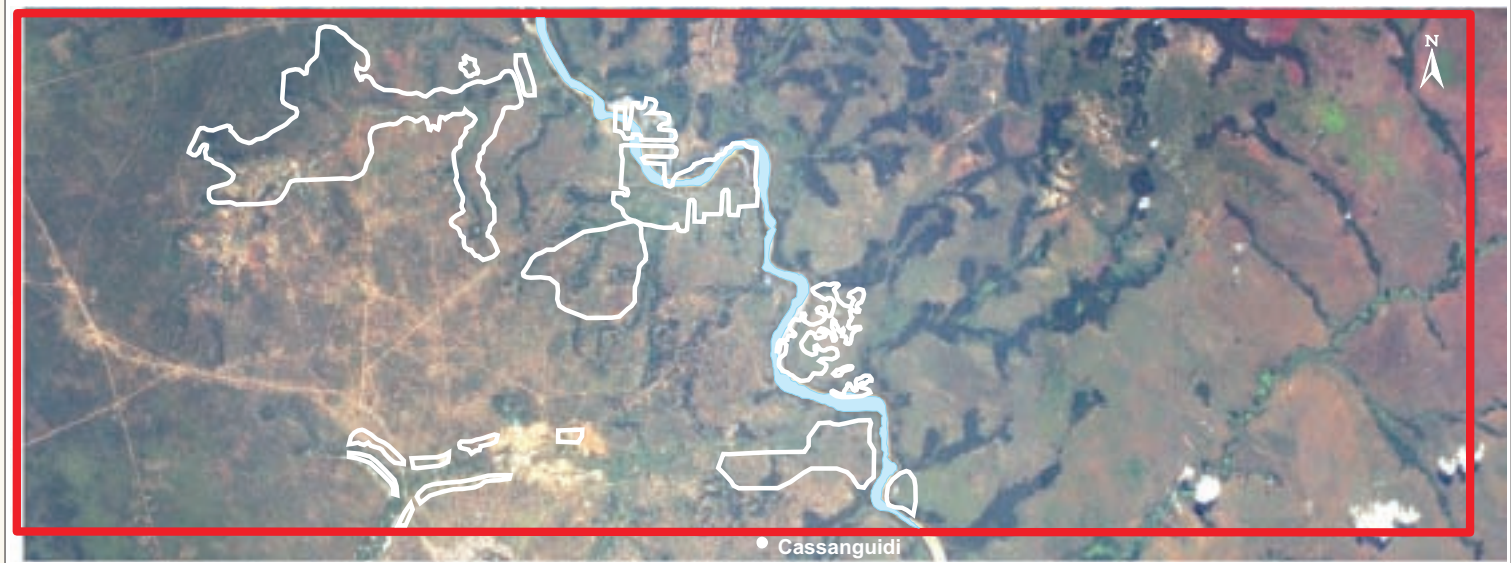

**LEGEND:**

- Mining Licence Area
- Project Area
- Tarred Road
- Other Road
- River
- Mined Out Area
- Town

The rights to exploit the Cassanguidi Project are held by Marsanto-Pesca e Sua Industrializaco i Exportaco Lda (Marsanto) as illustrated in Figure 49.

**Table 74 : Cassanguidi Project Legal Tenure**

PROJECT	PROJECT AREA	LICENSE TYPE	PERMIT NO.	MINERAL	LICENSE HOLDER	AREA (km <sup>2</sup> )	EXPIRY DATE	STATE'S SHARE
Cassanguidi	Cassanguidi South	Mining	N/A (PROESDA)	Diamonds	Marsanto	112.5	Valid for the time required to deplete the reserves as economically viable deposits.	0%
	Cabuaquece							
	Catchoque							
	Cale							

The license, in the form of an operating contract with Endiama, was signed under the PROESDA system in 1997. This system allows Angolan companies, where permitted, to explore and mine a concession free of any kind of equity participation obligation.

Marsanto entered into a contracting agreement with Luembe Mining (Pty) Ltd (Luembe) in terms of which Luembe provides capital and technical expertise to Marsanto in return for an agreed percentage of the net profits so derived (Figure 49). This amounts to 65% of net profits. Luembe, in turn, assigned its rights and obligations in terms of this agreement to Sub Sahara Investimentos e Consultoria Lda (Sub Sahara), an Angolan registered company. Efidium had a 50% shareholding in Sub Sahara. The net effect is that PDF holds 50% of a 65% share in net profits.

According to the operating contract with Endiama, the licensee is required to ensure the following with respect to the mining operation:-

- opportunity for the professional training of workers to ensure the gradual replacement of foreign experts with Angolan nationals;
- preference to Angolan workers and service companies, based upon their competence;
- industrial security with particular reference to the protection and safe-keeping of the diamonds;
- the most efficient exploitation of the resources and prevention of selective mining of high grade areas only;
- the necessary precautions to avoid negative effects on the environment;
- unrestricted access to the property for agents of Endiama and the Ministry of Geology and Mines; and
- keep detailed records of all production and accounting activities.

Endiama is required to provide all available geological and mineralogical information pertaining to the license area, as well as information on any demarcated mining reserves or ore blocks.

### 22.1.2 Royalties, Fees and Taxes

The Angolan company tax rate is currently 35% of net profit.

The government typically charges a 5% royalty on the gross value of a parcel sold in order to compensate for the historical exploration costs carried by Diamang and later, Endiama. Sodiam charges a valuation tax of 2.5% and an industrial tax of 1.0% on the gross value of all diamonds sold.

In the case of Cassanguidi, as per the operating contract, Endiama must be paid 10% of the sales value, free of any charges, in recognition of all the historical work carried out by Endiama in the project area. This amount is deemed to be inclusive of all royalties and charges to the State.

**Pangea DiamondFields plc**

**OWNERSHIP OF THE CASSANGUIDI PROJECT**

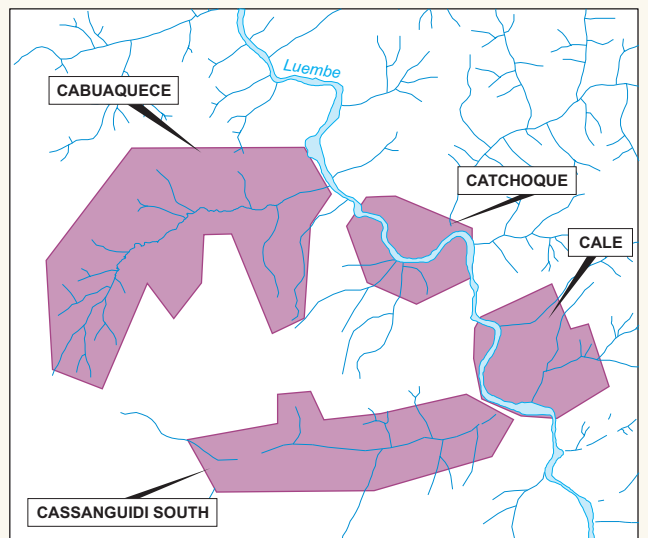
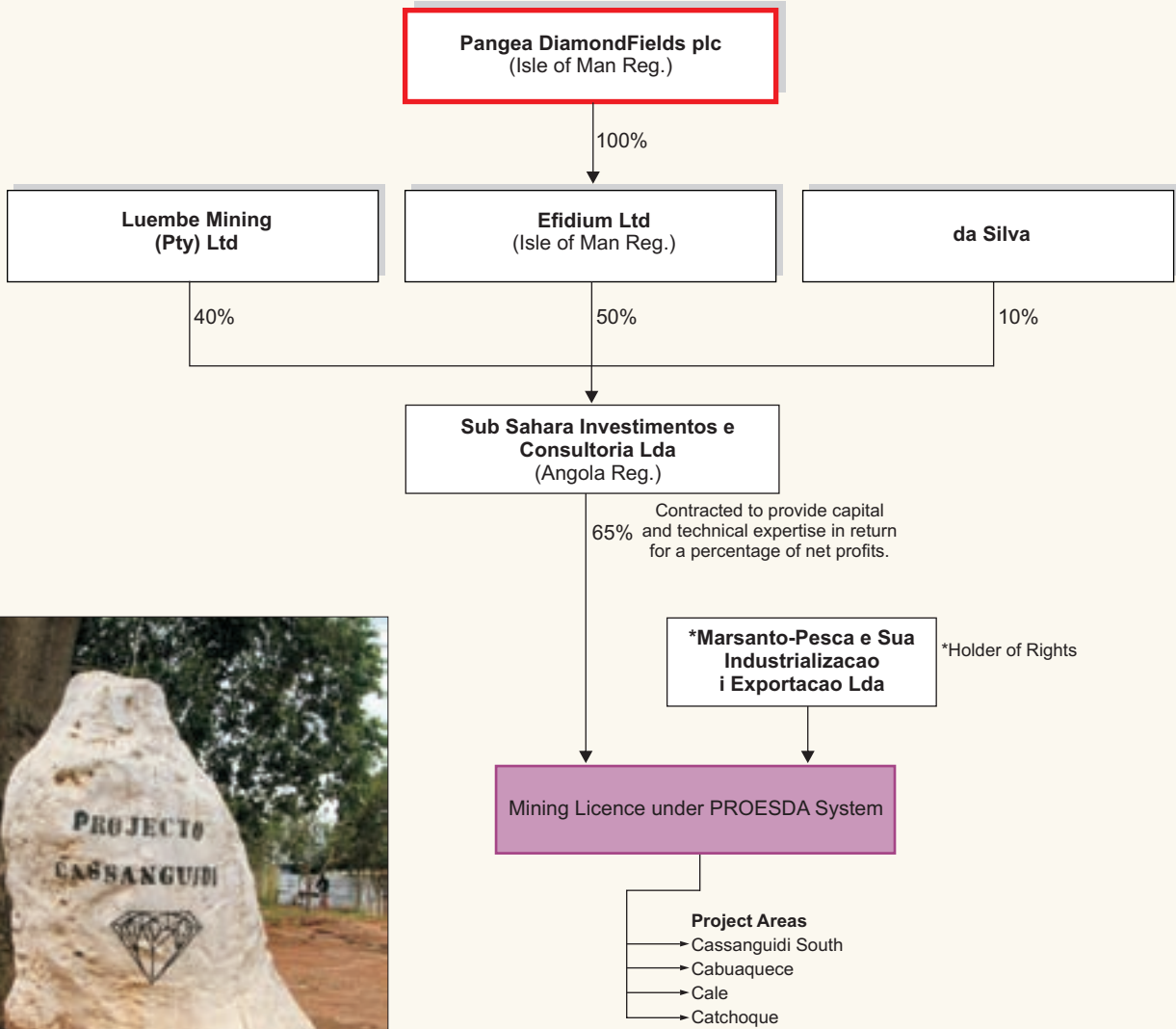

PangeaDFieldsTSX'07Fig49.cdr

### 22.1.3 Impact of the Project on the Environment

The Environmental Protection Act (Law No. 5 of 1998) describes the legal requirements with respect to the protection of the environment from the normally destructive nature of mining. The environmental law does not require that an Environmental Impact Assessment (EIA) be completed. However, it does require that the intentions of the company with respect to environmental issues be specified in the E.V.T-E. document and in the Mining Agreement.

According to the current environmental legislation in Angola, an EIA is not required. In the operating contract between Marsanto and Endiama, Marsanto is required to “take the necessary precautions to avoid negative effects on the environment, hampering in particular the pollution of water flows, the unnecessary destruction of the soil, fauna and flora and adopting the necessary measures to re-establish, as much as possible, the natural conditions immediately after the completion of operations.”

Cassanguidi has not completed any environmental studies but, according to management, endeavours to undertake responsible disposal of waste from the mining operation and minimal impact on the surrounding environment. The company plans to re-vegetate the slimes dams when their capacity is reached. The oversize, pan and recovery tailings dumps will not be rehabilitated as Endiama regards them as future possible resources.

Slimes from the pilot mining being carried out at Cassanguidi South are pumped into slimes dams situated adjacent to the Cassanguidi River. Water is removed by evaporation. The dams are built by the project using their earth moving equipment when required. Oversize material and pan and recovery tailings are stockpiled in tailings dumps also situated adjacent to the Cassanguidi River.

## 22.2 Accessibility, Climate, Local Resources, Infrastructure and Physiography

### 22.2.1 Locality, Population and Access

The Cassanguidi Project is situated approximately 80km east of Dundo and 30km north of Nzaji in Lunda Norte Province (Figure 46 and Figure 47). The license area, within which the project is located, is transected by the perennial northward flowing Luembe River. It lies 2km north of the Cassanguidi town.

Access to the project from the towns of Dundo and Nzaji is via narrow tarred roads with potholes. Nzaji can be reached from Luanda by air. The airstrip, although gravel, is in excellent condition. Dundo, which has a tarred strip, can also be reached from Luanda by air. The strips are large enough to land a Boeing 727 or a small Antonov. Alternatively, Cassanguidi can be reached by road from Luanda, a distance of approximately 1,600km. The condition of these roads is moderate to poor.

PDF has recently developed a 4,600km overland route from South Africa to the Cassanguidi Project for the transport of heavy equipment to site.

Within the concession area, the gravel roads are well maintained.

### 22.2.2 Infrastructure and Local Resources

An exploration camp comprising tents, buildings and modified containers has been established within the concession (Figure 50). These are used as accommodation, ablution, mess facilities and offices. The camp can accommodate a maximum of 60 personnel. The majority of the local employees live in the nearby Cassanguidi township, which is within walking distance of the project.

Two pan plants and a single final recovery plant are located close to the current exploration areas and the camp (Figure 48).

Water is readily available for both the plant and the camp from the Cassanguidi River. Water is purified for domestic use. Bottled water is supplied for drinking.

**CASSANGUIDI PROJECT INFRASTRUCTURE AND EQUIPMENT**

**CASSANGUIDI CAMP**



**GUEST HOUSE**



**BUILDING CONSTRUCTION**



**FURUKAWA FRONT END LOADER**



**GRADER**



**MINING TRENCH**



**DIESEL GENERATOR**



**GRAVEL DEPOSIT EXPOSED IN TRENCH SIDEWALL**



Source: Venmyn

This diagram and the information herein is copyrighted. It may not be reproduced or transmitted in any form or by any means without prior written permission from Venmyn Rand (Pty) Ltd. Trading as Venmyn.

Hydro-electric power is generated in Dundo. This power is available, via the national grid, in Nzaji and the associated powerline passes within approximately 2km of the edge of the license area. The project, however, generates its own electricity using diesel generators because the national supply is unreliable. Fuel is readily available in Dundo and Nzaji.

There is sufficient surface area for the current as well as any future mining operation to be carried out.

The company also has a country office in Luanda.

### 22.2.3 Climate and Vegetation

The climate is temperate in the dry season and hot and humid in the wet season. Temperatures range from a maximum of 35°C to a minimum of 12°C, with a mean of 22°C. The dry season occurs between May and October and the rainy season between November and April. Rainfall occurs almost daily during this season as heavy thunderstorms. Total annual rainfall, as measured at Saurimo, is 1,350mm.

The vegetation is comprised of savannah grassland with occasional small trees interspersed by riverine forest within the river valleys.

### 22.2.4 Physiography

Cassanguid Project is drained by the major northward flowing Luembe River. Multiple tributaries flow into the Luembe River in an easterly and westerly direction.

The concession area lies at an elevation of between 690m and 810m amsl. The topography comprises gently rolling hills covered in grass with occasional small trees. The hills are dissected by river valleys vegetated by riverine forest.

## 22.3 History

The history of activities relating to the diamond mining in the Lunda Norte Province, with particular reference to the Cassanguidi Project, is summarised in Table 75.

**Table 75 : History of Cassanguidi Project**

DATE	COMPANY	ACTIVITY
1912	Johnston and MacVey	First discovery of diamonds in the Chiumbe River in Lunda Norte Province.
1920		Commencement of diamond mining in Angola under the Portuguese.
1950's		Discovery of diamonds in the Calonda Formation in Lunda Norte Province.
1956 - 1987		Exploration pitting and resource blocking in the Cabuaquece, Cale/Luamona, Cachoque Blocks at Cassanguidi by Diamang (later Endiama).
Late 1980's - 1992		Disruption of mining activities in Lunda Province due to the civil war.
1992 - 1997	UNITA	Controls the diamond areas in eastern Lunda Norte.
1997	Marsanto	Obtains a PROESDA mining license over the Cassanguidi Concession. Estimated production from Cassanguidi of 40,000cts
1998 - 2003		Intermittent production.
2003	Luembe	Enters into contracting agreement with Marsanto.
2004		Establishes additional infrastructure and plant on site amounting to US\$7m. Establishment of office in Luanda.
		Professional Geoscience Services
2005	Marsanto	Pilot mining re-commenced in January 2005.
2006	Luembe/Efidium	Investment of US\$2m in capital expansion programme.

### 22.3.1 Historical Exploration, Sampling and Production Records

Extensive prospecting for, and sampling of, both kimberlites and alluvial deposits was conducted in northeastern Angola by Diamang and Mineral and Technical Services (M.A.T.S) in the mid 1900s. The sampling programme was comprehensive and undertaken using the stages described in Table 76.



**Table 76 : Historical Sampling Programme Parameters**

PROSPECTING STAGE	GRID SPACING (m)	PIT SPACING (m)	APPLICATION	MAP SCALE
Reconnaissance	400 x 400	200 x 200	Previously unprospected areas.	1:10,000
Systematic	200 x 200	100 x 100	Prospective areas.	1:5,000
Detailed	100 x 100	50 x 50	Block delimitation.	1:2,000

Individual gravel samples ranged between 2m<sup>3</sup> and 8m<sup>3</sup>. The data recorded for each sample pit were the nature of bedrock, nature and thickness of the gravel, nature and thickness of the overburden, size distribution of the gravel and diamond grade.

It is understood that a single sample was taken per pit and washed and screened by hand in the nearest source of water. The lowest screen size is estimated to have been approximately 1mm.

No specific information of the particular gravel unit sampled, eg. Calonda, colina, lezeria, etc. were recorded and, in some cases, the pit and line spacings stated above were inconsistent. Sampling data sheets as well as resource block plans were obtained from Endiama for the sampling programmes conducted between 1956 and 1987.

The sampling sheets indicated a line spacing of generally 100m, with pits at 50m intervals along the lines. Lines were placed at right angles to the drainage system. The sampling plan showed readings for the overburden thickness, gravel thickness and grade. In the Cassanguidi area 1,873 pits were excavated by Diamang, as illustrated in Figure 53, Figure 52 and Figure 53, for the Cabuaquece, Catchoque and Cale Project areas respectively. Although historical pitting would have occurred along the Cassanguidi River within the Cassanguidi South Project Area, this information has not been found at the Endiama offices. Therefore no pitting results are available for this project area.

Diamang historically mined the Cassanguidi Project, primarily within the river beds and, to a lesser extent, on the low level terrace deposits. The mined out areas are indicated on Figure 51 to Figure 54 and were focussed on the Cassanguidi and Cabuaquece Rivers. No details on the monthly production tonnages and grades from the area were available.

### 22.3.2 Historical Diamond Resources

In 1975, M.A.T.S used the sampling results to compile a global resource for the various diamondiferous horizons within the Angolan diamond fields (Table 77). Alluvial deposits are quoted on a block and drainage basin basis. Unfortunately, no maps were available to show the exact locations of the respective blocks and drainages. The results for the Cassanguidi Project are shown in bold.

**Table 77 : M.A.T.S. Global Resources of the Angolan Diamond Fields (1975)**

SOURCE HORIZON	GRAVEL VOLUME (m <sup>3</sup> )	GRADE (ct/100m <sup>3</sup> )	TOTAL CARATS
Chingufo	526,765	67	354,190
Dundo	212,704	40	85,082
Fucauma	369,484	68	249,537
<b>Cassanguidi</b>	<b>1,075,126</b>	<b>67</b>	<b>718,227</b>
Luxilo M.D.1	498,698	75	372,998
Andrada	1,198,172	71	847,468
Maludi	213,871	73	155,488
Luaco	427,857	59	250,899
Laurica	670,890	73	490,898
Lucapa	3,460,751	79	2,741,145
Calonda Norte	2,023,774	53	1,080,004
Calonda	2,913,548	74	2,148,529
Luo	937,708	116	1,087,741
Lova	117,747	169	198,992
Cuango	5,071,553	89	4,508,287
<b>TOTAL/AVE ALLUVIAL DEPOSITS</b>	<b>19,718,648</b>	<b>0.78</b>	<b>15,289,485</b>

**LEGEND:**

- River
- Project Area
- Resource Area
- Mined Out Area
- Endiama Pit
- Riverbed
- Alluvium
- Kalahari
- Conglomerates & Argillites
- Basement Granite & Gneiss
- Endiama Blocks

**LOCATION OF HISTORICAL EXPLORATION AND MINING FOR THE CABUAQUECE PROJECT AREA**

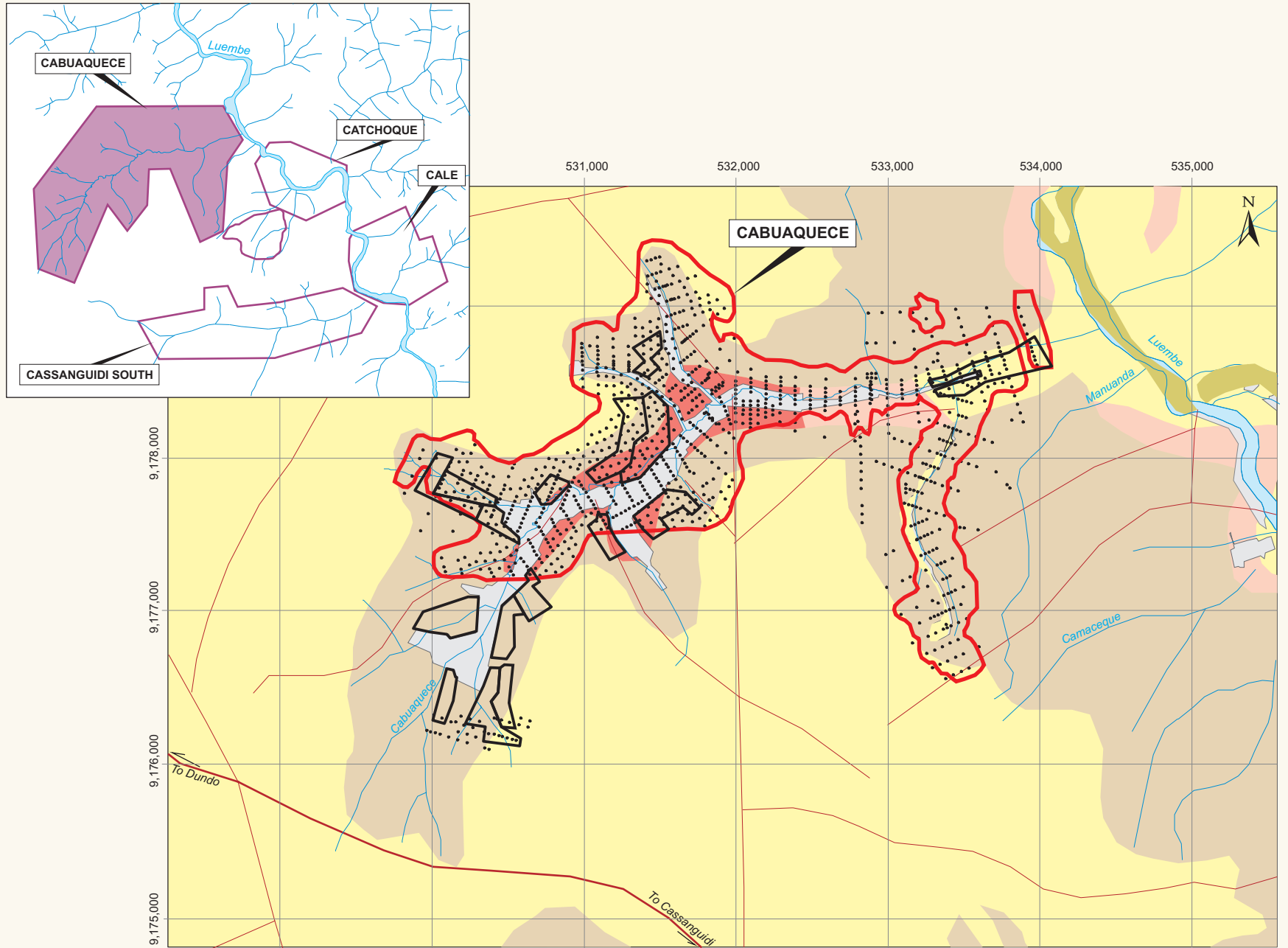

PangeaDFieldsTSX'07Fig51.cdr

Source: Pangea

SCALE:

0 1 km

This diagram and the information therein are copyrighted. It may not be reproduced or transmitted in any form or by any means without prior written permission from Venmyn Rand (Pty) Ltd. Trading as Venmyn.

**LOCATION OF HISTORICAL EXPLORATION AND MINING FOR THE CATCHOQUE PROJECT AREA**

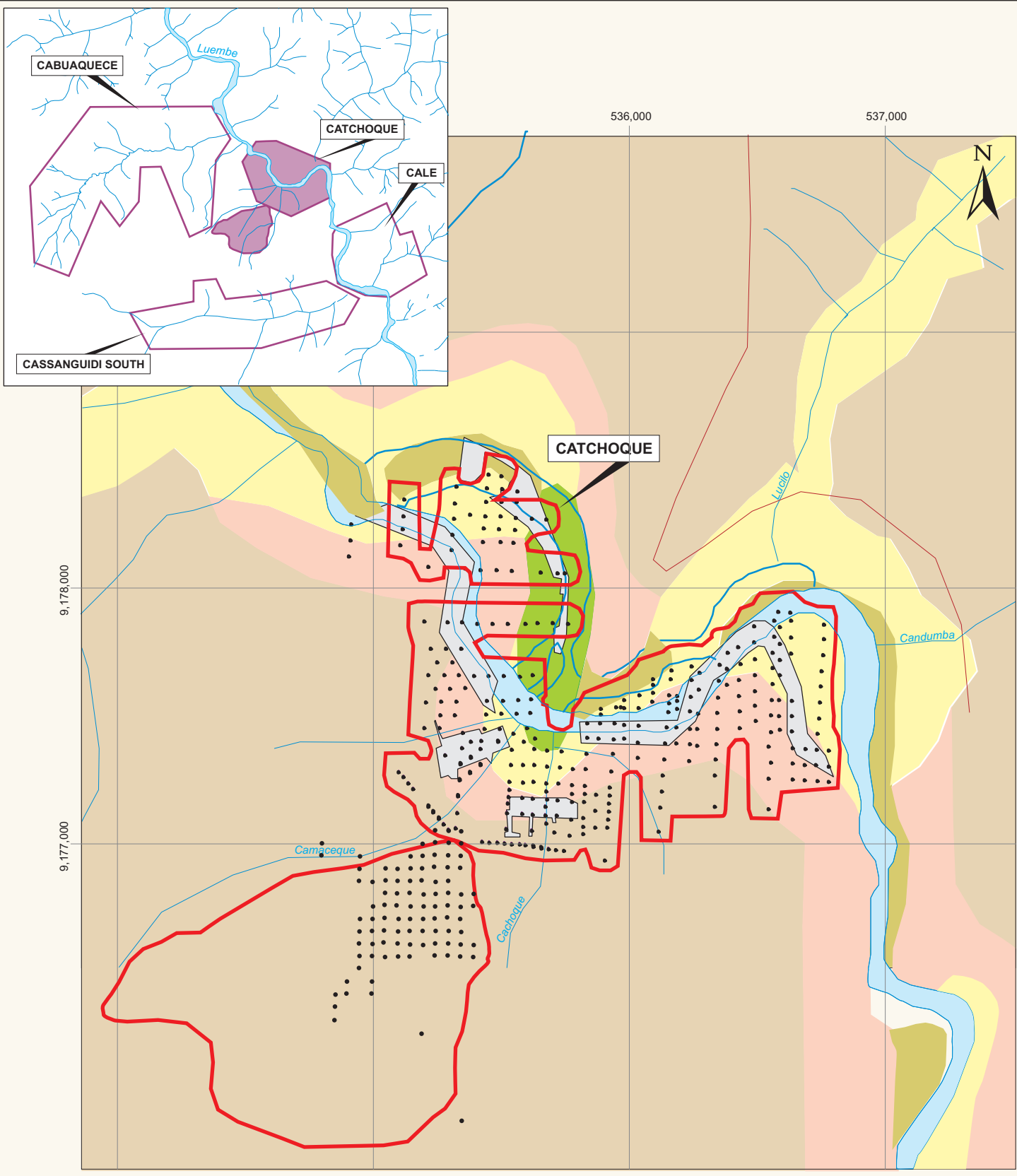

PangeaDFieldsTSX'07Fig52.cdr

Source: Pangea

**LEGEND:**

- River
- Project Area
- Resource Area
- Mined Out Area
- Endiama Pit
- Alluvium
- Kalahari
- Greenstones
- Basement Granite & Gneiss
- River Bed

SCALE:



This diagram and the information therein are copyrighted. It may not be reproduced or transmitted in any form or by any means without prior written permission from Venmyn Rand (Pty) Ltd. Trading as Venmyn.

**LOCATION OF HISTORICAL EXPLORATION, HISTORICAL MINING AND RECENT EXPLORATION FOR THE CALE PROJECT AREA**

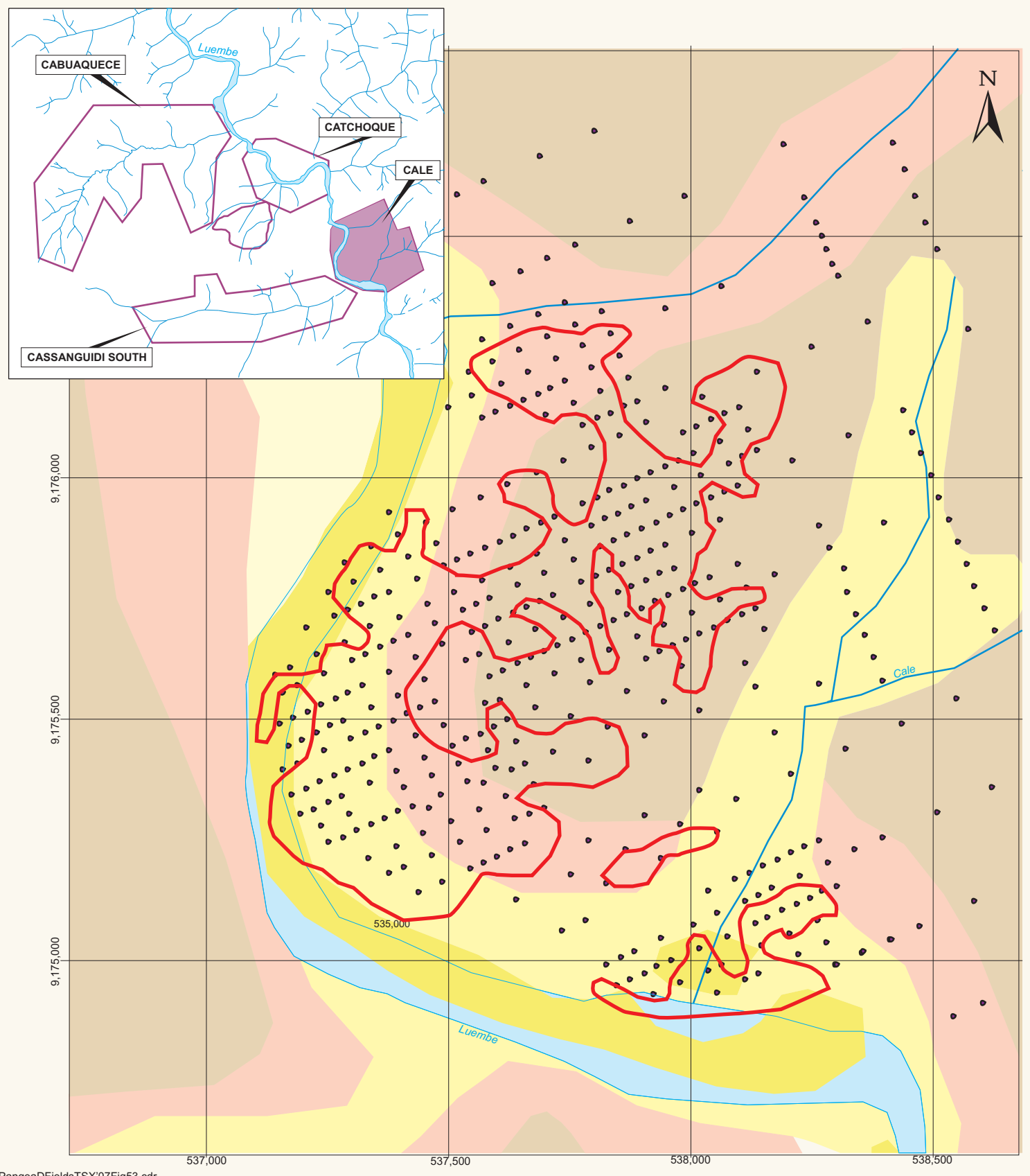

PangeaDFieldsTSX'07Fig53.cdr

Source: Pangea

**LEGEND:**

- River
- Project Area
- Resource Area
- Endiama Pit
- Riverbed
- Alluvium
- Kalahari
- Basement Granite & Gneiss

**SCALE:**



This diagram and the information therein are copyrighted. It may not be reproduced or transmitted in any form or by any means without prior written permission from Venmyn Rand (Pty) Ltd. Trading as Venmyn.

**LOCATION OF HISTORICAL MINING, RECENT EXPLORATION AND RECENT MINING FOR THE CASSANGUIDI SOUTH PROJECT AREA**

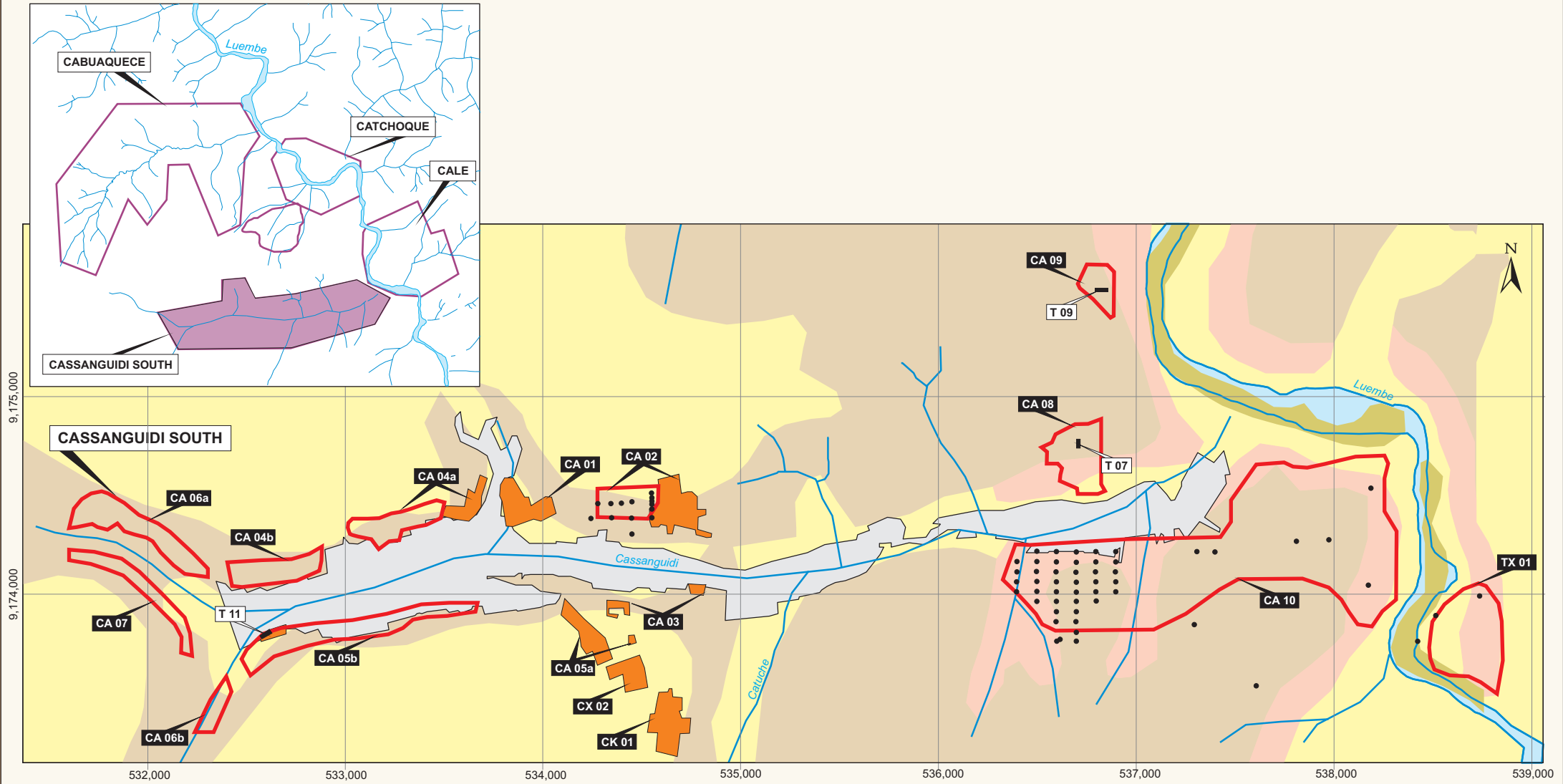

Source: Pangea

**LEGEND:**

- River
- Project Area
- Resource Area
- Mined Out Area
- Endiama Pit
- Recent Bulk Sampling
- Riverbed
- Alluvium
- Kalahari
- Basement Granite & Gneiss
- Recently Mined-out Area



This diagram and the information therein are copyrighted. It may not be reproduced or transmitted in any form or by any means without prior written permission from Venmyn Rand (Pty) Ltd. Trading as Venmyn.

Note that these resources were not prepared in accordance with any resource reporting codes (E.g. CIM Standards, SAMREC Code etc.). Also, although the sampling methods and results have proved to be reliable for this region of Angola, the details with respect to the way the resources volumes were measured and grades estimated are unknown. Therefore, these results should be treated circumspectly and not be used for any resource determination.

In 1991, Endiama divided Cassanguidi into four project areas based upon the historical Diamang exploration data. These included, from north to south, Cabuaquece, Catchoque, Cale and Cassanguidi South. The company identified blocks within the first three areas and calculated the volumes and grades associated with each. The results are tabulated for each of the three project areas in Table 78 to Table 80. The outline of the Endiama resource blocks are indicated on Figure 51, Figure 52 and Figure 53.

**Table 78 : Endiama Resources for Cabuaquece Mining Area (1991)**

PROJECT AREA	BLOCK	TYPE	GRAVEL VOLUME (m <sup>3</sup> )	CARATS	O/B THICK (m)	GRAVEL THICKNESS (m)	GRADE (ct/100m <sup>3</sup> )	STONE SIZE	STRIP RATIO
Cabuaquece	CB10	Colina	135,592	20,286	3.93	0.88	15	0.20	3.32
	CB16		94,832	20,770	5.61	0.71	22	0.20	5.55
	CB20		55,020	15,681	5.53	0.70	29	0.11	5.53
	CB21		72,738	10,862	5.43	0.96	15	0.18	4.32
	CB22		65,520	8,928	3.61	1.33	14	0.16	2.22
	CB28		58,800	16,200	7.00	0.70	28	0.15	7.00
	CB29		43,369	9,120	2.99	0.72	21	0.14	2.94
	CB30		67,692	13,385	5.55	0.92	20	0.17	4.55
	CB31		48,486	14,328	6.61	0.88	30	0.13	5.59
	Unknown	240,166	25,258	6.06	2.18	11	0.15	2.44	
	CB36	Channel	173,600	31,400	14.20	2.80	18	0.20	4.58
	CB23	Lezeria	36,079	8,580	3.62	0.64	24	0.17	4.63
	CB32		43,273	41,462	5.15	0.65	96	0.23	6.55
	Unknown		28,522	6,057	1.02	0.45	21	0.12	1.68
	Unknown		49,037	5,971	1.66	0.48	12	0.11	2.64
	CB25	Terrace	36,735	9,333	4.75	0.73	25	0.15	4.62
	CB33		56,700	12,500	8.50	0.70	22	0.20	8.50
	CB37T	Rejects	94,380	94,380			100	1.60	0.00
	CB38T		94,250	10,085			11	0.22	0.00
	<b>TOTAL/AVE CABUAQUECE MINING AREA</b>			<b>1,306,161</b>	<b>270,121</b>	<b>7.50</b>	<b>1.77</b>	<b>21</b>	<b>0.17</b>

**Table 79 : Endiama Resources for Catchoque Mining Area (1991)**

PROJECT AREA	BLOCK	TYPE	GRAVEL VOLUME (m <sup>3</sup> )	CARATS	O/B THICK (m)	GRAVEL THICKNESS (m)	GRADE (ct/100m <sup>3</sup> )	STONE SIZE	STRIP RATIO
Catchoque	CQ08T	Rejects	43,550	7,970	N/A	N/A	18	0.19	N/A

**Table 80 : Endiama Resources for Cale Project Area (1991)**

PROJECT AREA	BLOCK	TYPE	GRAVEL VOLUME (m <sup>3</sup> )	CARATS	O/B THICK (m)	GRAVEL THICKNESS (m)	GRADE (ct/100m <sup>3</sup> )	STONE SIZE	STRIP RATIO
Cale	CE01	Terrace	75,319	8,272	1.29	0.11	11	0.31	1.95
	CE02		169,575	23,910	4.60	1.13	14	0.22	3.23
	CE03		106,432	28,623	4.18	0.87	27	0.31	3.58
	CE04		261,712	56,199	2.37	1.13	21	0.22	1.66
	CE05	Lezeria	93,052	22,302	1.56	0.81	24	0.34	1.67
	CE07		26,832	8,613	2.57	0.47	32	0.18	4.13
<b>TOTAL/AVE CALE MINING AREA</b>			<b>732,922</b>	<b>147,919</b>	<b>4.26</b>	<b>1.76</b>	<b>20</b>	<b>0.25</b>	<b>2.42</b>

Note again that these resources were not prepared in accordance with any resource reporting codes (E.g. CIM Standards, SAMREC Code etc.) and the details with respect to the way the resource volumes were measured and grades estimated are unknown. Therefore, these results should be treated circumspectly and not be used in any resource calculation.

## 22.4 Geological Setting

### 22.4.1 Regional Geological Setting

The Lunda Norte area is underlain by upper and lower Archaean sequences comprising granite gneisses, with numerous greenstone remnants, including amphibolites, schists and itabirites, with a generally north-south structural trend. The Archaean is intruded by the biotite-porphyroblastic Quibala Granite (Figure 55). The basement includes the Lower Proterozoic Lunda Group, comprising shales, quartzites and conglomerates, occurring as small down-faulted windows in the south-western corner of the project area.

Sediments of the Karoo Supergroup (Lutoe Group) are conspicuously absent from the region as a whole, either due to non-deposition, or total removal prior to deposition of the Calonda Formation. The Calonda and Kwanga Formations unconformably rest on the above units and are dated at mid- to late-Cretaceous (80-100Ma). These Formations comprise a continental sedimentary sequence of conglomerates, arkoses, sandstones and shales. Diamonds, weathered and eroded from kimberlites, were deposited by fluvial processes in the conglomerates of the lower Calonda and Kwanga. The provenance of the sediments of the Calonda Formation is thought to have been from the south of the basin, and a large "channel", trending from south to north, has been mapped.

Kimberlite pipes were intruded in the early Cretaceous, dated at approximately 130Ma, and were associated with southwest-northeast striking tectonic lineaments of the "Lucapa Graben".

Deposition of the Calonda and Kwanga Formations was followed by a period of uplift and stable arid climatic conditions, leading to extensive silicification and the formation of silcretes.

This was followed by the deposition of the aeolian deposits of the Kalahari Group. A return to humid conditions led to the formation of the present north-south drainage pattern, which is suspected to follow the prevailing Kalahari dune direction.

#### 22.4.1.1 Basement Formations

The basement of the general area (Figure 55) comprises poorly exposed, deeply weathered granite and granite gneiss, with enclaves and xenoliths of greenstone lithologies, including mica schists, amphibolites and strongly altered mafic volcanic rocks, cut by irregular quartz veins. The generally coarse grained granites weather to a structureless reddish-brown clay matrix riddled with angular grey quartz grains, whilst the gneissic rocks preserve their original texture and tend to be micaceous. It is not known if the weathering predates the overlying Calonda Formation or not, but the presence of feldspathic arkose in the Calonda suggests that it is dominantly post-Calonda.

#### 22.4.1.2 Calonda Formation

The basement is overlain by fine-grained to conglomeratic arkose of the Calonda Formation (Figure 55), which is characterised by a pervasive violet to reddish-brown colouration, particularly in the lower parts, presumed to be ferruginous staining derived from the underlying basement, together with white kaolin spotting, from the weathering of feldspar.

Towards the base, the Calonda comprises a gravel of angular, sub-angular and rounded boulders, cobbles and pebbles of quartz, quartzite and occasional itabirite, together with weathered gneiss, schist and amphibolite, set in a variegated clayey sand matrix, locally cemented to form a conglomerate. The gravel is in turn overlain by a semi-consolidated to silicified sandstone. The Calonda is a typical upward-fining fluvial sequence and is diamondiferous.

#### 22.4.1.3 Kalahari Group Including Gres Polymorphe

Aeolian and other sediments of the Kalahari Group (Figure 55) cover most of the interfluvial ridges between the drainages. At the base of the Kalahari is the so-called "gres polymorphe", (or polymorphic sandstone).

**GEOLOGY OF LUNDA NORTE PROVINCE**

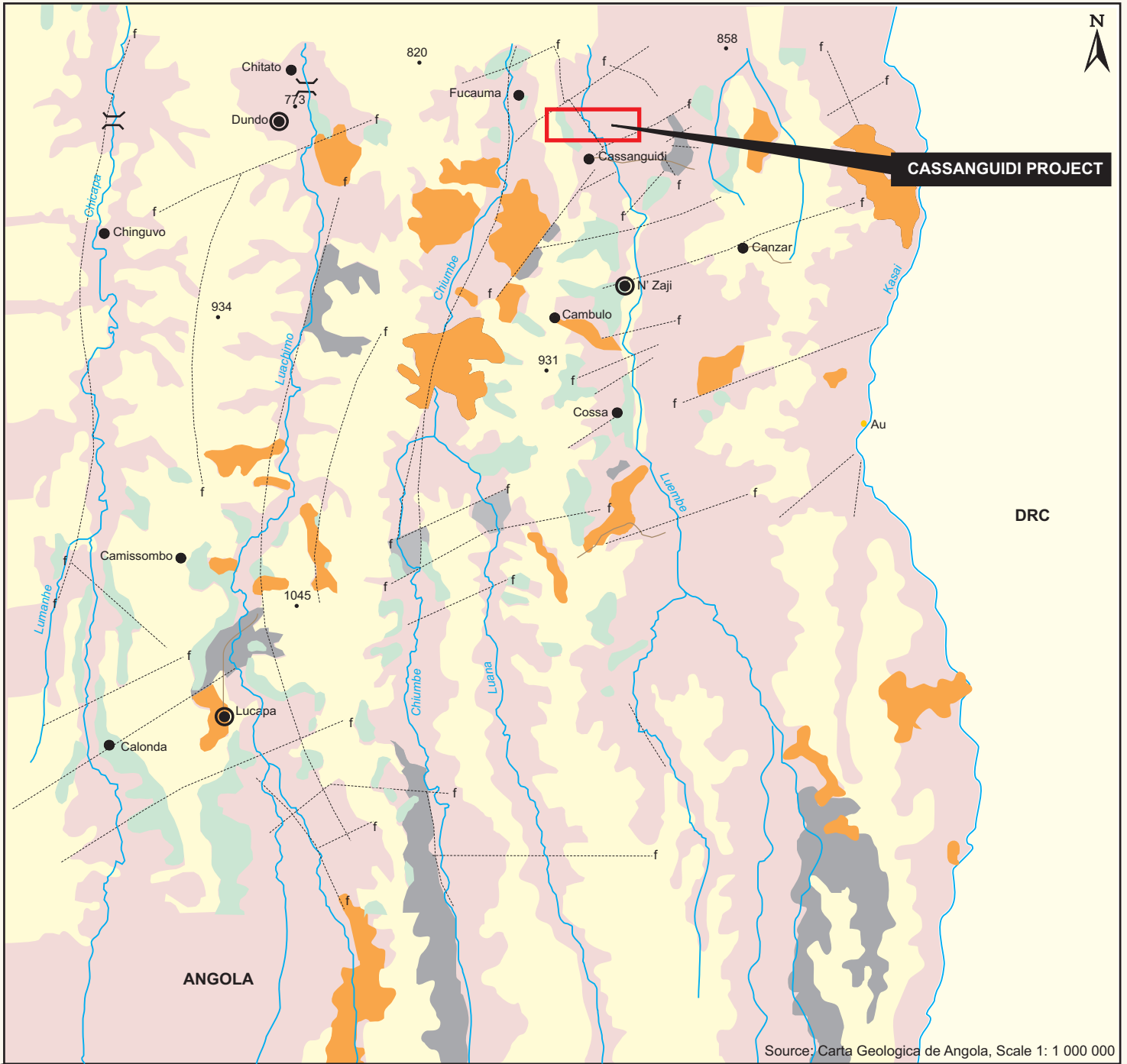

Source: Carta Geologica de Angola, Scale 1: 1 000 000

PangeaDFieldsTSX'07Fig55.cdr

Source: Carta Geologica de Angola, Scale 1: 1 000 000

**LEGEND:**

- Kalahari Group
- Ochre Sand Formation (sand and clay)
- Calonda Formation
- (Argillite, arkose and conglomerate)
- Lunda Group
- (Shale, quartzite and conglomerate)
- Quibala Granite
- (Biotite porphyroblastic granite)
- Archaean Granites

**SCALE:**



This diagram and the information therein are copyrighted. It may not be reproduced or transmitted in any form or by any means without prior written permission from Venmyn Rand (Pty) Ltd. Trading as Venmyn.

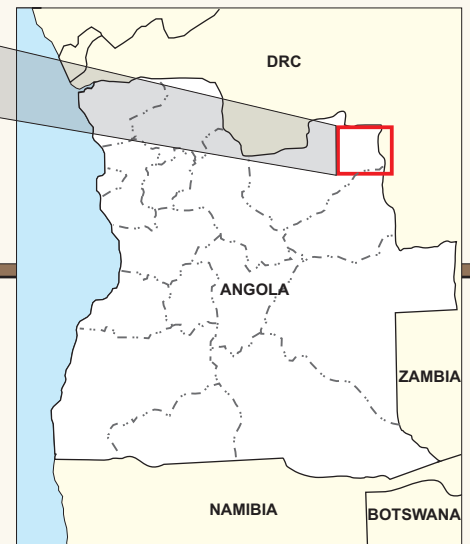



The fining-upward gravel comprises angular blocks and nodular boulders of silcrete, which are either amorphous or silicified gravel, and sand. The gravel unit is generally considered to be part of the Kalahari sequence. However, the presence of nodular and brecciated silcrete within the unit, together with well-rounded pebbles similar to those of the underlying Calonda suggests that it should be regarded as a silicified fluvial/lag deposit overlying the Calonda, being pre-Kalahari rather than part of the Kalahari proper.

It is suspected that the unit was formed by the silicification of a lag/fluvial deposit derived from weathering and erosion of the Calonda, silcrete having formed at surface as a discontinuous to nodular layer within, and adjacent to, the gravel. This layer was subsequently broken up by limited fluvial action and covered by aeolian Kalahari sand.

Historically the gres polymorphe has been shown to be diamondiferous, the diamonds presumably being derived from kimberlites, deflation of the underlying Calonda, and possibly from erosion of the Kwango formation, if this once occurred within the Chiumbe, Luana and Luembe basin. No information is available as to grades.

#### **22.4.1.4 Colinas (Hill-wash Deposits)**

Down-cutting of the river systems has given rise to extensive hill-wash deposits (Figure 55) comprising heterogeneous gravels on hill slopes below the level of the gres polymorphe. At higher levels below the gres polymorphe, but above the sub-outcrop of the Calonda, the colina gravels comprise boulders of silcrete, silicified sandstone, silicified gravel and pebbles derived from the gres polymorphe, admixed with angular blocks of vein quartz derived from the local basement. This deposit is referred to here as upper colina and more than one layer of gravel may be present in this unit. Below the level of sub-outcrop of the Calonda, the hill-wash comprises either a discrete gravel unit or, more commonly, the gravel is overlain by a pebbly arkosic grit or coarse sand (gres cascalho), both of which are diamondiferous. This deposit is referred to here as the lower colina, as where both units are present the gres polymorphe derived wash invariably overlies the Calonda derived wash.

The quartz veins present in the weathered bedrock, and small pothole-like depressions in the bedrock can give rise to local trap sites with diamond enrichment. Diamond grades for the colina deposits are stated to be generally somewhat higher than those of the source gravels.

#### **22.4.1.5 Terraces and Lezirias (Flood-plain Deposits)**

Genetically, there is little difference between the terraces and lezirias, a terrace being an old flood plain into which the river has incised, leaving a "perched" terrace (Figure 55). A leziria can be considered to be a low-level terrace. These deposits are generally developed in the major river valleys of Lunda Norte, and are important producers of diamonds.

Bedrock morphology plays a more important role in diamond concentration in the terraces and lezerias than in the colinas. Differences in bedrock composition can lead to the development of potholes, small plunge pools and gullies, in which diamonds can be highly concentrated. Such traps are known locally as "marmitas".

#### **22.4.1.6 Present River Bed**

The gravels of the present river beds (Figure 55) in the area, both main rivers and their tributaries, represent the most transported and reworked deposits. This multiple reworking has led to a general increase in grade over that of their source gravels, and the river deposits have been a major target of artisanal activity, both pitting and diving.

A conspicuous feature of the lower level gravels is the presence of a much wider range of clast lithologies than in the colina, pebbles of Proterozoic conglomerate, altered volcanic and ultramafic rocks and bedded cherts having been noted.

#### **22.4.2 Local and Property Geology**

The local geology of the Cassanguidi Project is illustrated by area in Figure 51 to Figure 54 and shown schematically in cross section in Figure 56.

The basement, where exposed, comprises strongly weathered granite, represented by coarse angular fragments of quartz, set in a structureless matrix of red clay. Weathering extends to a depth of several metres. Enclaves of weathered amphibolite, representing xenoliths of greenstone lithologies, are seen in the trenches, and a large remnant of greenstone has been mapped. Although the Calonda and grés polymorphe are expected to be present in the concession, they are not exposed. Other than in the river valleys, the concession is covered by an overburden of Kalahari sand.

### **22.5 Deposit Type**

The Cassanguidi Project hosts alluvial and colluvial diamond deposits. The various deposits are schematically illustrated in Figure 56 and are described in the section below on mineralisation

### **22.6 Mineralization**

#### **22.6.1 Colinas**

The primary exploration target in the Cassanguidi concession is currently colina deposits, and these were seen in all the prospecting trenches visited.

The colina package typically comprises the lower unit, with pebbles and cobbles derived from the Calonda, overlain by grés cascalho and the upper unit, derived from the grés polymorphe (Figure 56). As seen in the trenches adjacent to the camp, the package is variable in thickness, from about 0.6m to a maximum of about 1.4m. In the trenches in the vicinity of the plant, the package comprises mixed upper and lower units, is generally thinner, and may be reduced to a narrow zone of scattered small pebbles resting on weathered bedrock.

Despite the poor development of the colina here, the horizon is diamondiferous, with high grades. The colina deposits are overlain by somewhat clayey Kalahari sand, and appear to be pre-Kalahari in age.

#### **22.6.2 Terraces**

Lower terraces have been extensively worked, but the workings are now partially collapsed, and in-situ gravels were not seen. Spoil heaps indicate that the terrace comprises a well-rounded and well-sorted gravel of quartz, quartzite and chert pebbles and cobbles, together with clasts of Proterozoic conglomerate, altered volcanic and ultramafic rocks and bedded cherts.

#### **22.6.3 Lezirias**

The lezirias or flood plain deposits seen at Cassanguidi comprise lenticular mounds of well-rounded and well-sorted small to medium pebbled gravels overlain by grey organic-rich silt, typical of a braided stream environment. The deposits have been a major target for artisanal mining activities.

#### **22.6.4 Present River Bed**

Little can be said about the overall make-up of the river bed gravels as they are submerged.

**LEGEND:**

- Diamondiferous Gravels
- Calonda Formation (Argillite, arkose and conglomerate)
- Basement

**CASSANGUIDI PROJECT SCHEMATIC CROSS SECTION OF LOCAL GEOLOGY**

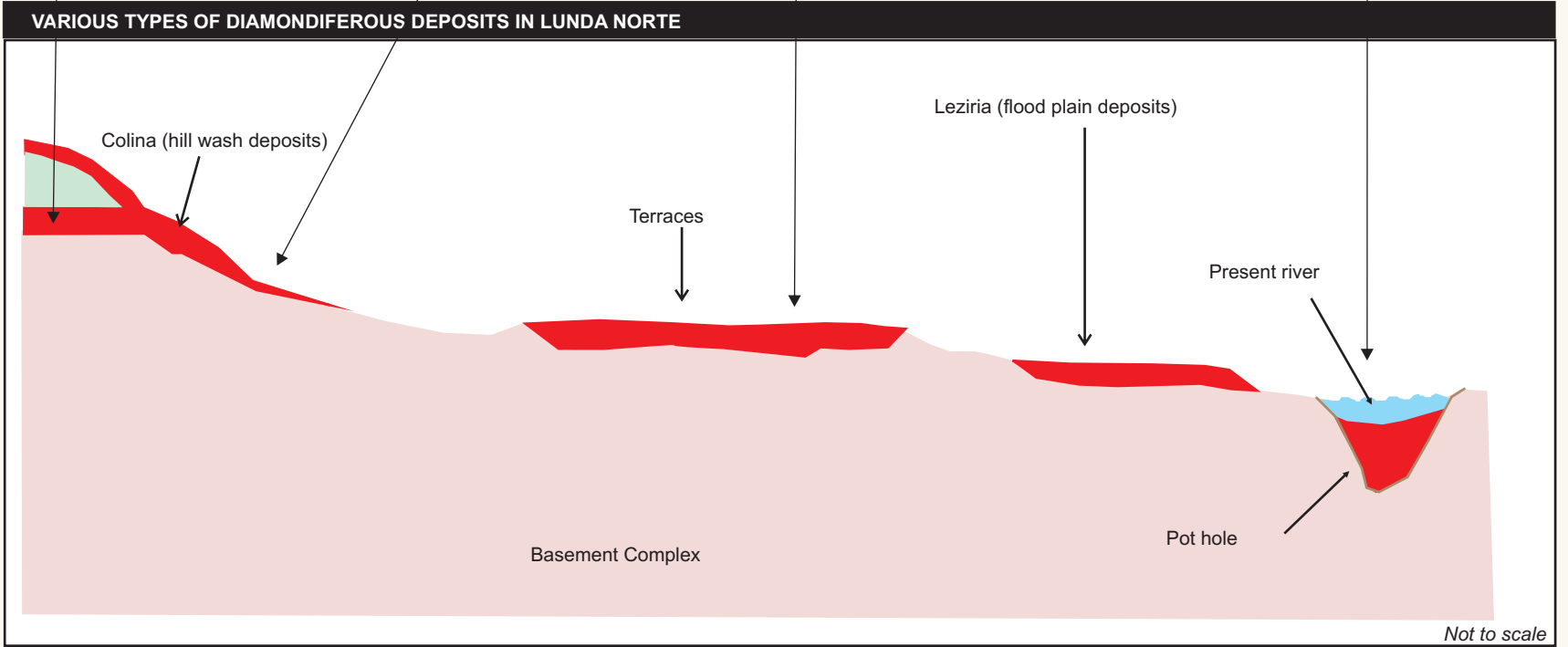
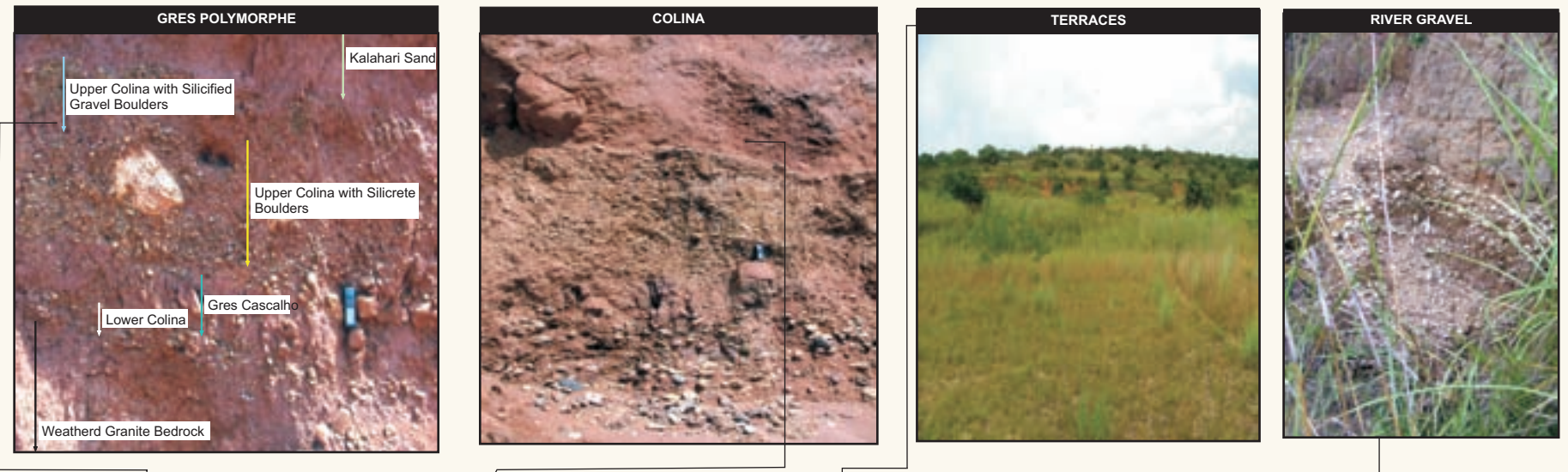

PangeaDFieldsTSX'07Fig56.cdr

This diagram and the information therein are copyrighted. It may not be reproduced or transmitted in any form or by any means without prior written permission from Venmyn Rand (Pty) Ltd. Trading as Venmyn.

Not to scale

## 23 CASSANGUIDI PROJECT – CASSANGUIDI SOUTH PROJECT AREA

Cassanguidi South is the southern most project area and extends along the east flowing Cassanguidi River, a tributary of the Luembe River.

### 23.1 Exploration

Exploration within this project area had previously focussed on pilot mining in close proximity to the plant. However, during 2007, exploration commenced to identify potential resources in the adjacent areas. A pitting and bulk sampling programme was initiated in order to accomplish this. The pitting provided information on the vertical and lateral extent of the gravels, whilst the bulk samples provided grade data.

### 23.2 Pitting

The purpose of the pitting exercise was to define the vertical and lateral extent of the gravel within the project area. In some cases the results have been used to model the gravel volumes in Surfer®.

#### 23.2.1 Sampling Method and Approach

Pits were dug by hand or excavator to bedrock on either a 100m by 100m grid spacing or a 50m by 100m grid over the area under investigation. The size of the pits was typically 1m diameter jimbos or 4m by 4m pits. Each pit was mapped, measured and information gathered on the overburden thickness, gravel characteristics, gravel thickness and bedrock type. The pit coordinates were recorded using a GPS. The pits were sequentially named with an alphanumeric, eg. A01; B03, etc. Pits within the same block were given the same alphabetical prefix.

Pitting was carried out to the north and south of the Cassanguidi River (Figure 54) and also along the Tximi River to the east of the Cassanguidi/Luembe confluence. The delineated gravel areas were named according to a block number, with a two letter prefix indicating the project area in which they were located, followed by the sequential numbering of the blocks.

This method of exploration was carried out on blocks CA02; CA08; CA09, CA10 and TX01 within Cassanguidi South Project Area. The positions of the pits are indicated on Figure 54.

#### 23.2.2 Sample Preparation, Analyses and Security

The pits associated with Block TX01 were tested for the presence of diamonds. The gravels were excavated by hand and a single gravel sample removed, bagged and weighed. The bags were then sealed and transported to a nearby water source. There the samples were hand washed by local artisans employed as casual labourers under the supervision of Cassanguidi's security personnel. The bottom screen size used was 1mm. The purpose of the sampling was to provide an indication of whether mineralization was present. No grade results were reported.

Due to the fact that no grade results were reported a comment on the authors opinion of the sampling is not required.

#### 23.2.3 Data Verification

The pit coordinates and mapping results were recorded in Excel sheets. These sheets were submitted to PDF's head office in Johannesburg for verification on a regular basis. As previously stated, Venmyn has not verified the data in detail but has witnessed the rigorous process of verification which PDF's headoffice geologist carries out. As a result, the Qualified Person is satisfied that the potential for any error to occur is minimised.

#### 23.2.4 Results

A total of 94 pits were excavated into the blocks, as indicated in Table 81, along with the results. Of these pits, 89 were utilised in the modelling exercise.

**Table 81 : Summary Statistics for Cassanguidi South Project Area**

PROJECT AREA	BLOCK NO.	NO. PITS	GRAVEL THICKNESS (m)			OVERBURDEN THICKNESS (m)			GRADE (ct/100m <sup>3</sup> )		
			MIN	MAX	AVE	MIN	MAX	AVE	MIN	MAX	AVE
Cassanguidi South	CA02	5	0.26	3.00	1.11	3.00	7.88	5.60	N/A	N/A	20.00
	CA08	20	0.50	4.00	1.96	0.21	3.89	1.86	N/A	N/A	5.50
	CA09	17	0.50	19.80	0.99	0.12	4.80	1.91	N/A	N/A	9.62
	CA10	44	0.10	2.18	0.66	0.01	9.63	3.64	No grade figures		
	TX01	3	0.45	0.79	0.58	0.40	1.85	1.15	No grade figures		
	<b>TOTAL/AVE</b>	<b>89</b>									

The pitting results for blocks CA02, CA08, CA09 and CA10 were modelled using the computer orebody modelling software package, Surfer®. The grids were prepared using the inverse distance squared method of estimation, which is suitable for orebodies with a tabular nature such as the gravels present at the Cassanguidi Project. The estimation was carried out using all data points with no search radius specified. Modelling was carried out on all the gravels as a single unit with no separation according to gravel type. This is acceptable as the gravel types generally do not overlap.

The results of the pitting are illustrated as contour plots in Figure 57 to Figure 60.

The modelling of CA02 indicates (Figure 57) that the overburden thickness decreases to the southeast whilst the associated gravel thicknesses increase in a similar direction. As a result the mining conditions are most favourable in this portion of the block.

The CA08 pitting and modelling results indicate (Figure 58) a thickening of the gravels to the southwest, along with a decrease in the overburden. Therefore the stripping ratio is at a minimum in this area.

In the case of CA09 (Figure 59), the overburden decreases to the northeast. The gravel thickness, however, is greatest to the west and east of the block. Optimal stripping ratios will, therefore be prevalent in the east.

Block CA10 exhibits large variations in gravel thickness (Figure 60). This is evident in the west of the block and is most likely to be related to a topographic high. The resultant stripping ratios in this area are likely to prohibit mining. Gravel thicknesses are greatest to the south of this topographic high.

No modelling of grade was carried out as only bulk sampling results were available. These are reported upon in the section to follow.

### 23.3 Bulk Sampling

The purpose of the bulk sampling exercise was to identify the grade of the gravels associated with the areas delimited through pitting or, where necessary, to confirm grades in areas prior to mining.

#### 23.3.1 Sampling Method and Approach

A single bulk sampling pit was dug by excavator in each of the following blocks; CA05b, CA08 and CA09 (Figure 54), to obtain a gravel sample. The sizes of the pits were typically 50m by 15m with the aim of obtaining a gravel sample size of approximately 600m<sup>3</sup>. The position of the bulk samples was located according to the gravel configuration i.e. being a representative section of the characteristics of that particular block. The pit coordinates were recorded using a GPS. The positions of the pits are illustrated on Figure 54.

**CONTOUR PLOT OF GRAVEL AND OVERBURDEN THICKNESSES FOR THE CA02 BLOCK, CASSANGUIDI SOUTH PROJECT AREA**

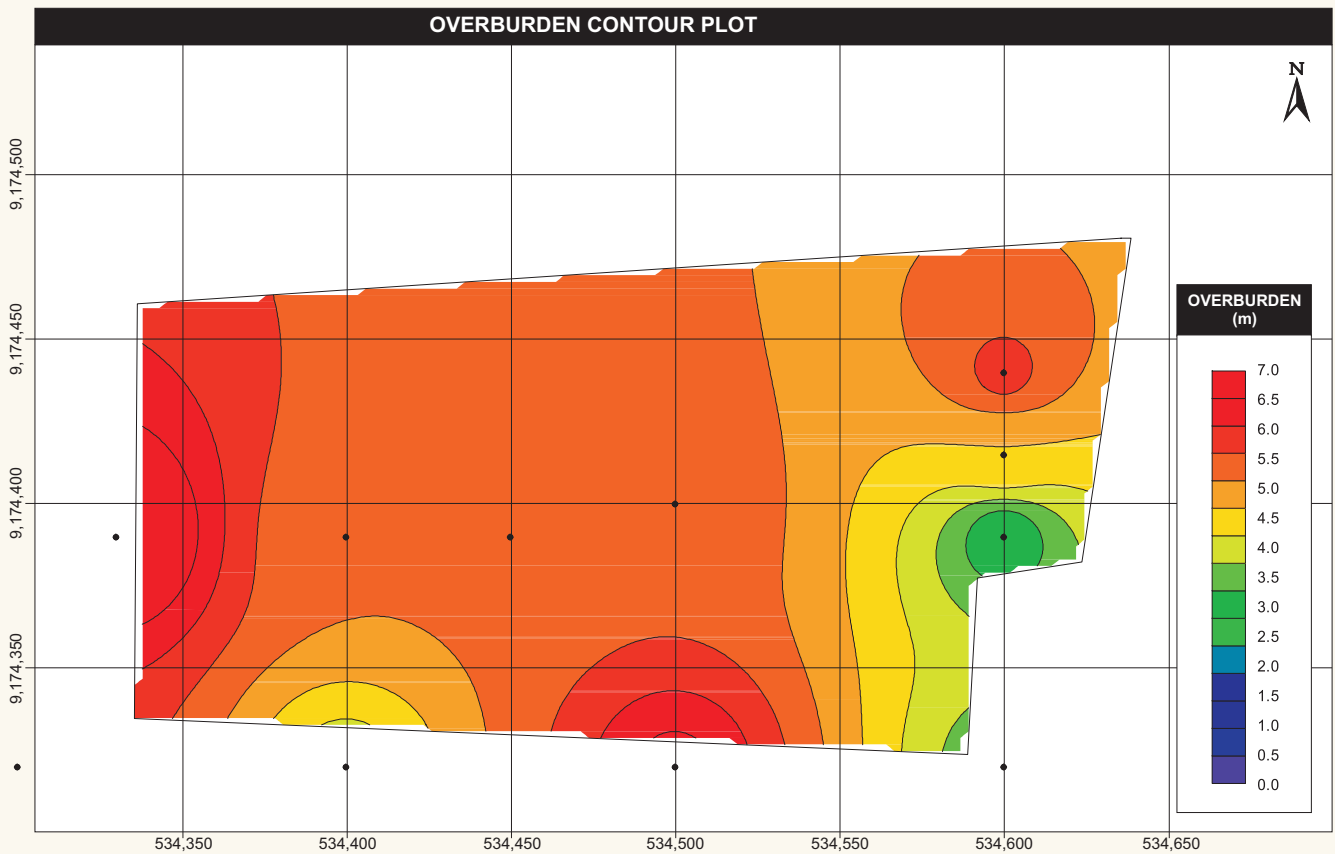
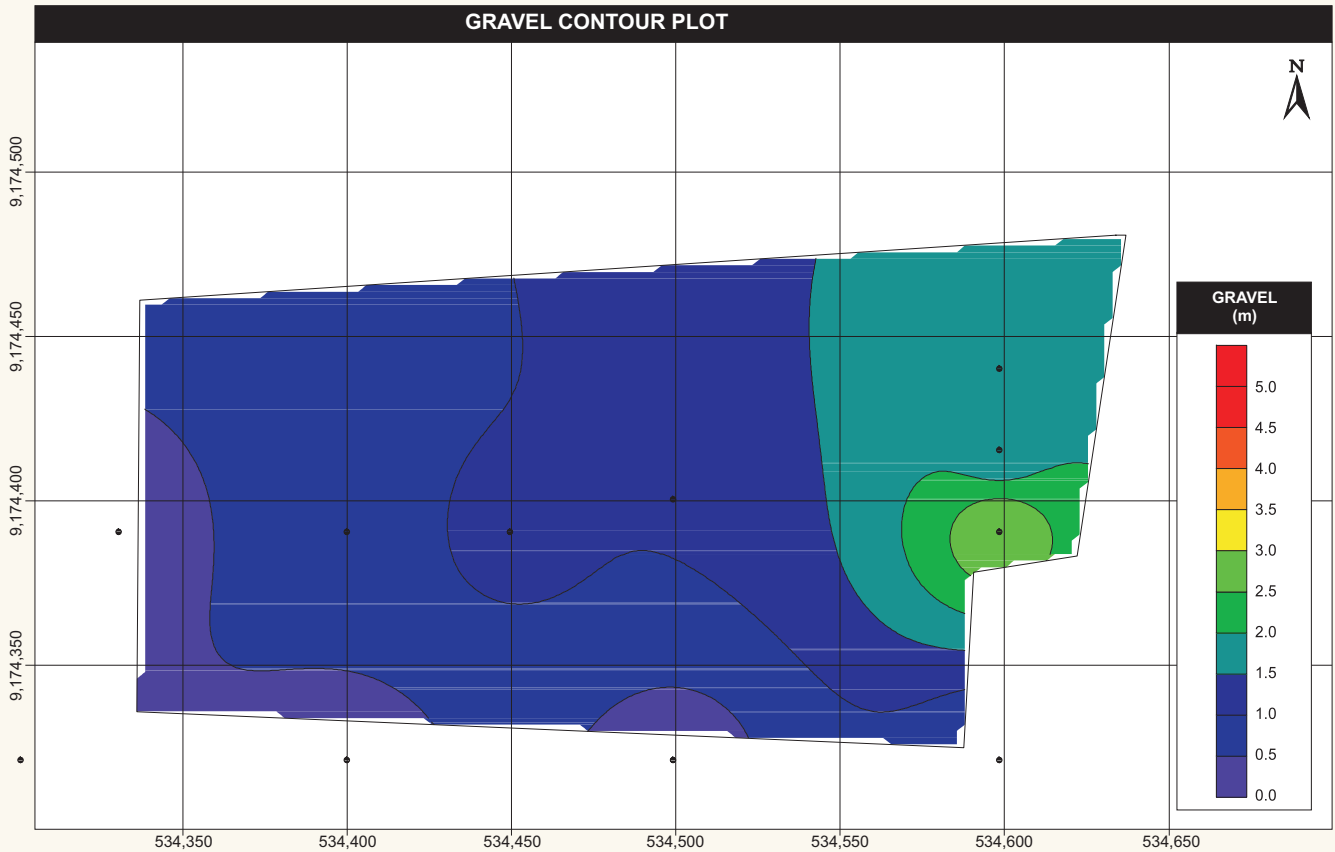

PangeaDFieldsTSX'07Fig57.cdr

Source: Venmyn

This diagram and the information herein is copyrighted. It may not be reproduced or transmitted in any form or by any means without prior written permission from Venmyn Rand (Pty) Ltd. Trading as Venmyn.



• Pit

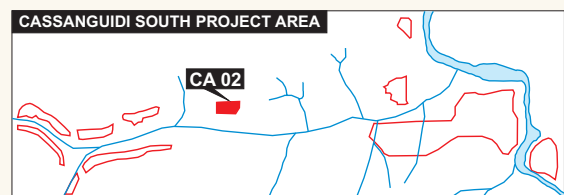

**CONTOUR PLOT OF GRAVEL AND OVERBURDEN THICKNESSES FOR THE CA08 BLOCK, CASSANGUIDI SOUTH PROJECT AREA**

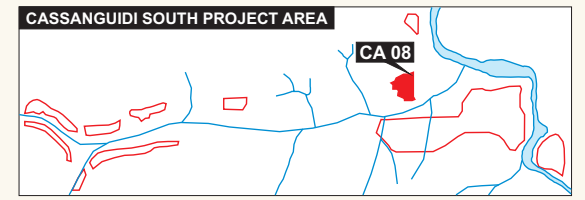
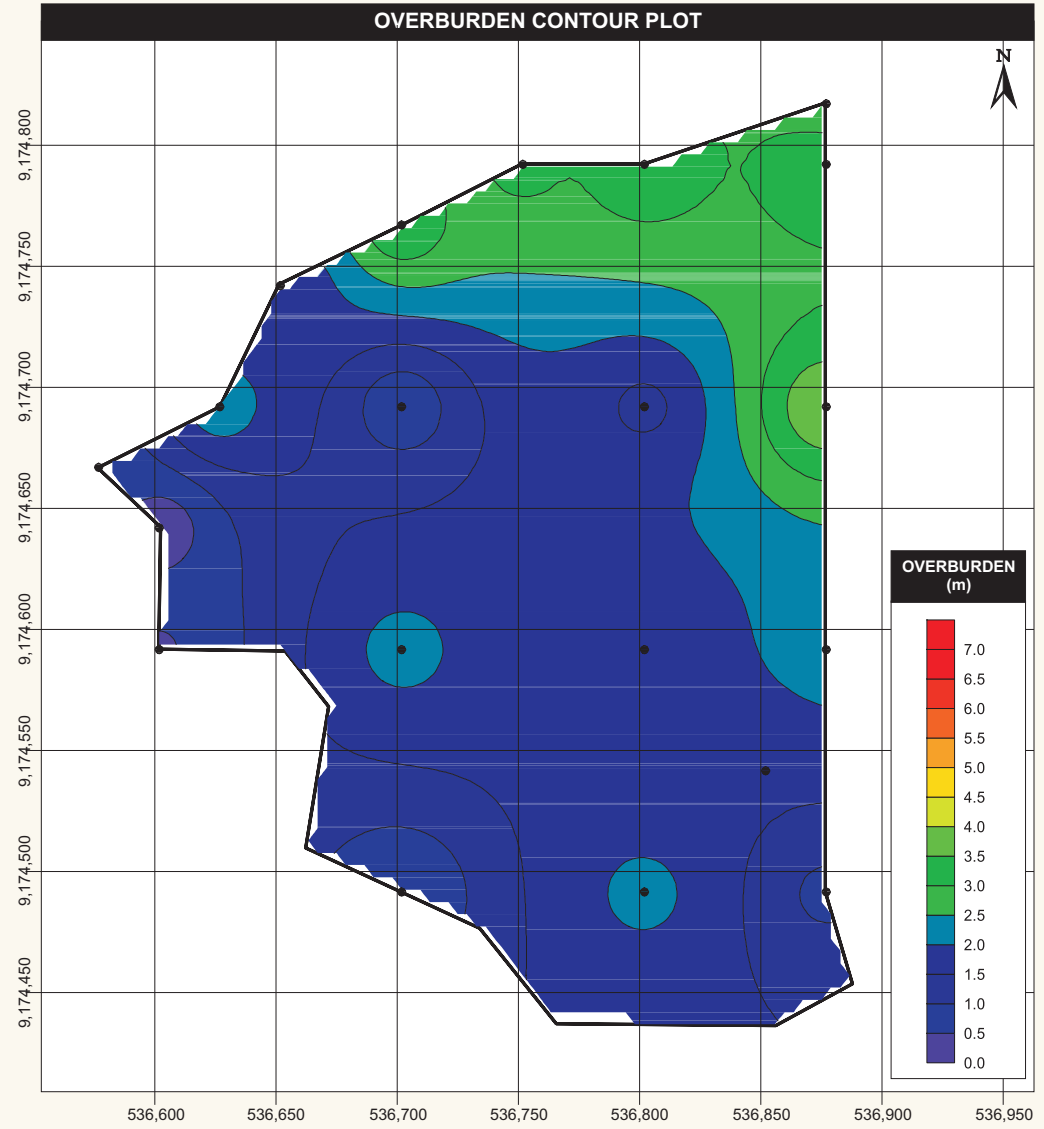
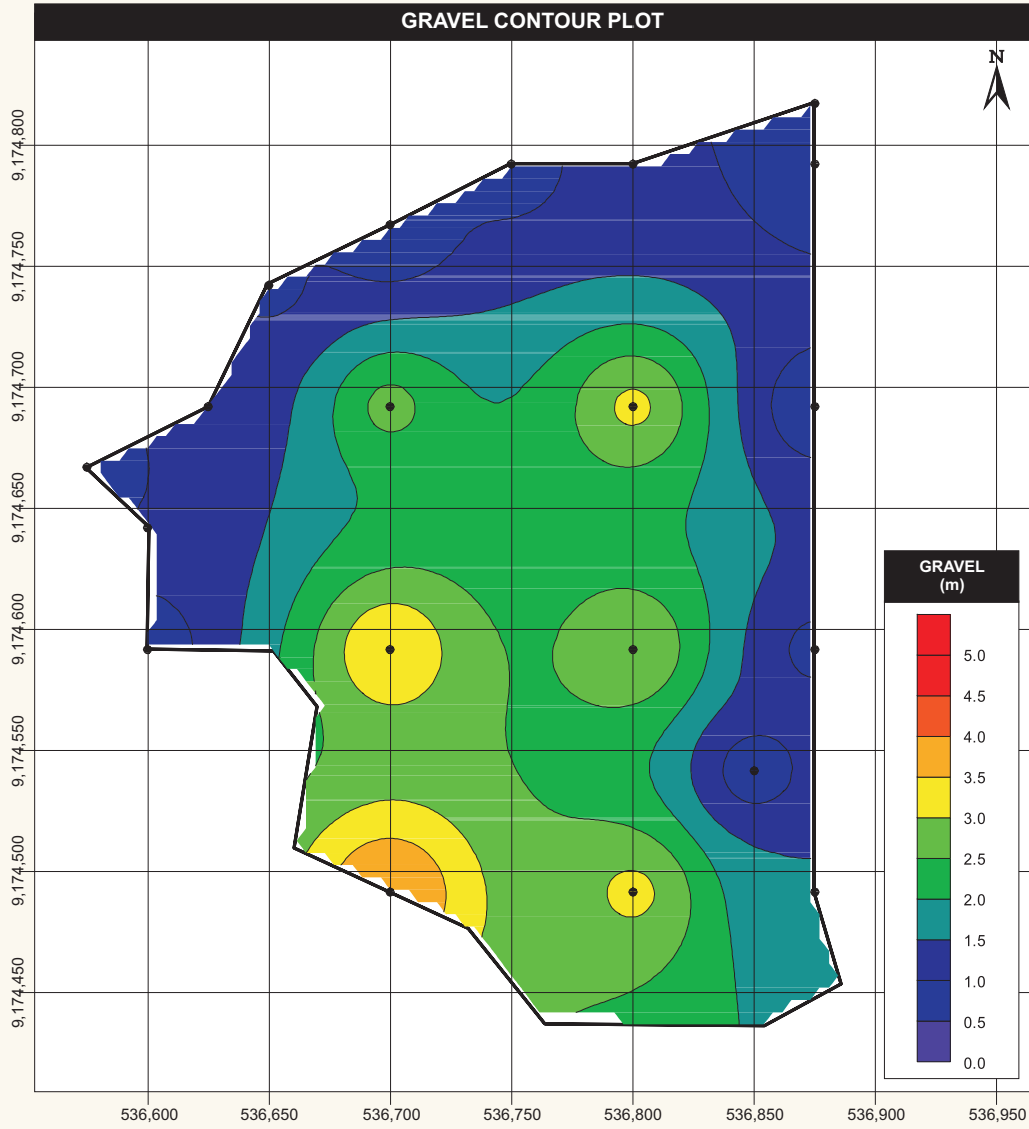

Source: Venmyn

This diagram and the information herein is copyrighted. It may not be reproduced or transmitted in any form or by any means without prior written permission from Venmyn Rand (Pty) Ltd. Trading as Venmyn.



• Pit

PangeaDFieldsTSX'07Fig58.dsr

**CONTOUR PLOT OF GRAVEL AND OVERBURDEN THICKNESSES FOR THE CA09 BLOCK, CASSANGUIDI SOUTH PROJECT AREA**

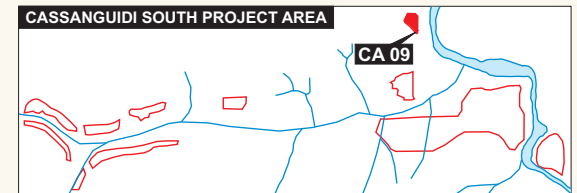
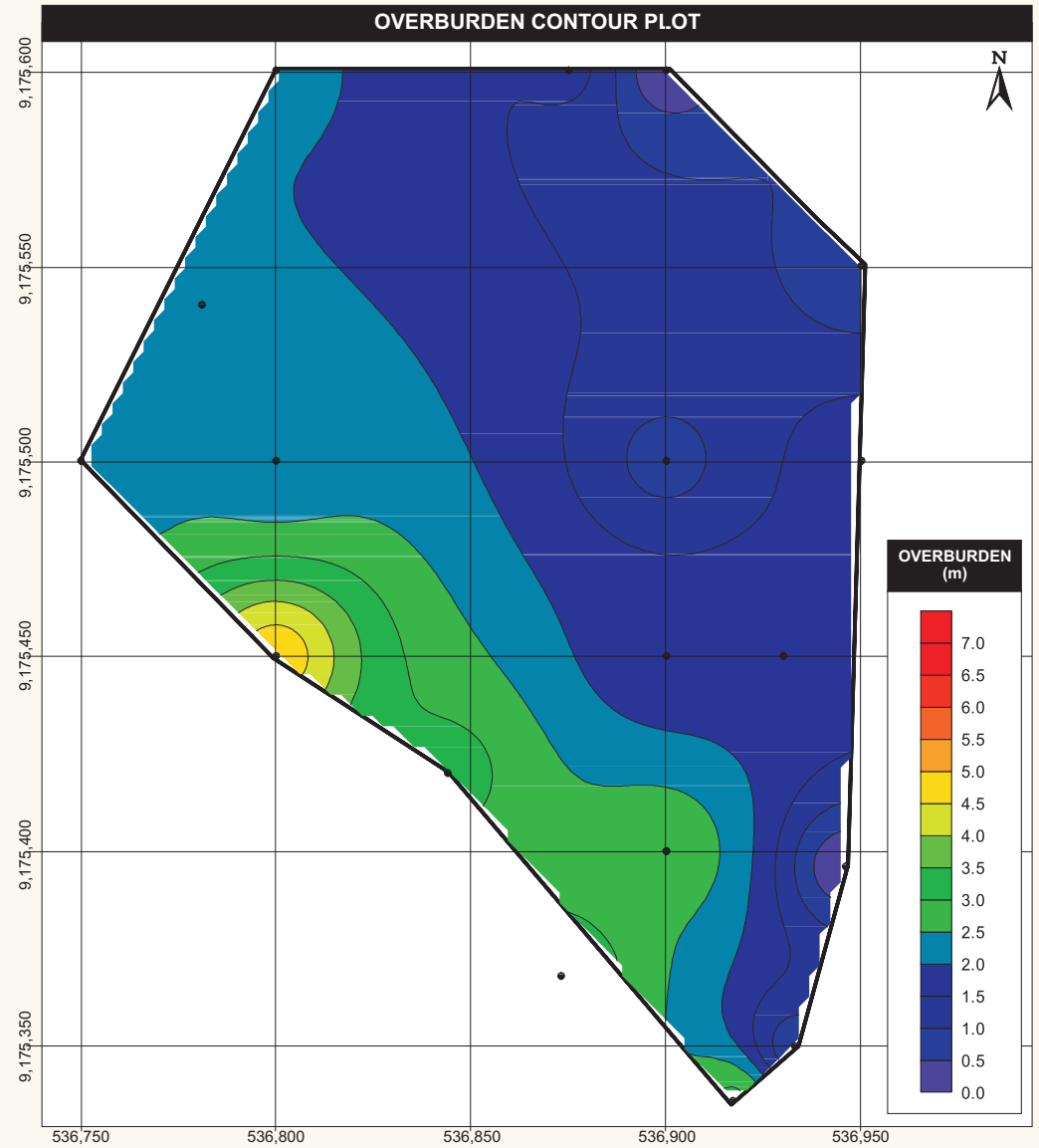
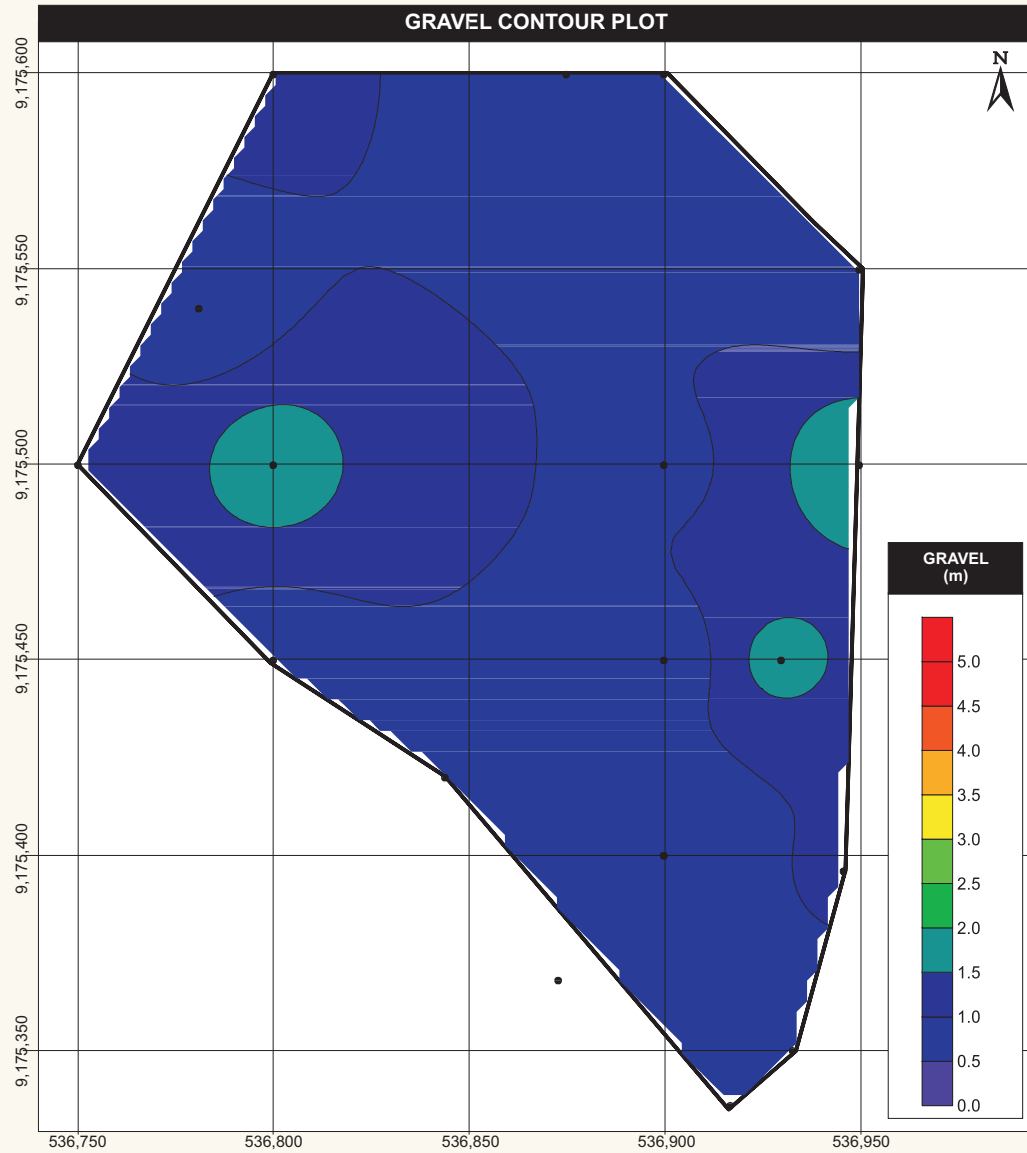

Source: Venmyn

This diagram and the information herein is copyrighted. It may not be reproduced or transmitted in any form or by any means without prior written permission from Venmyn Rand (Pty) Ltd. Trading as Venmyn.



• Pit



**CONTOUR PLOT OF GRAVEL AND OVERBURDEN THICKNESSES FOR THE CA10 BLOCK, CASSANGUIDI SOUTH PROJECT AREA**

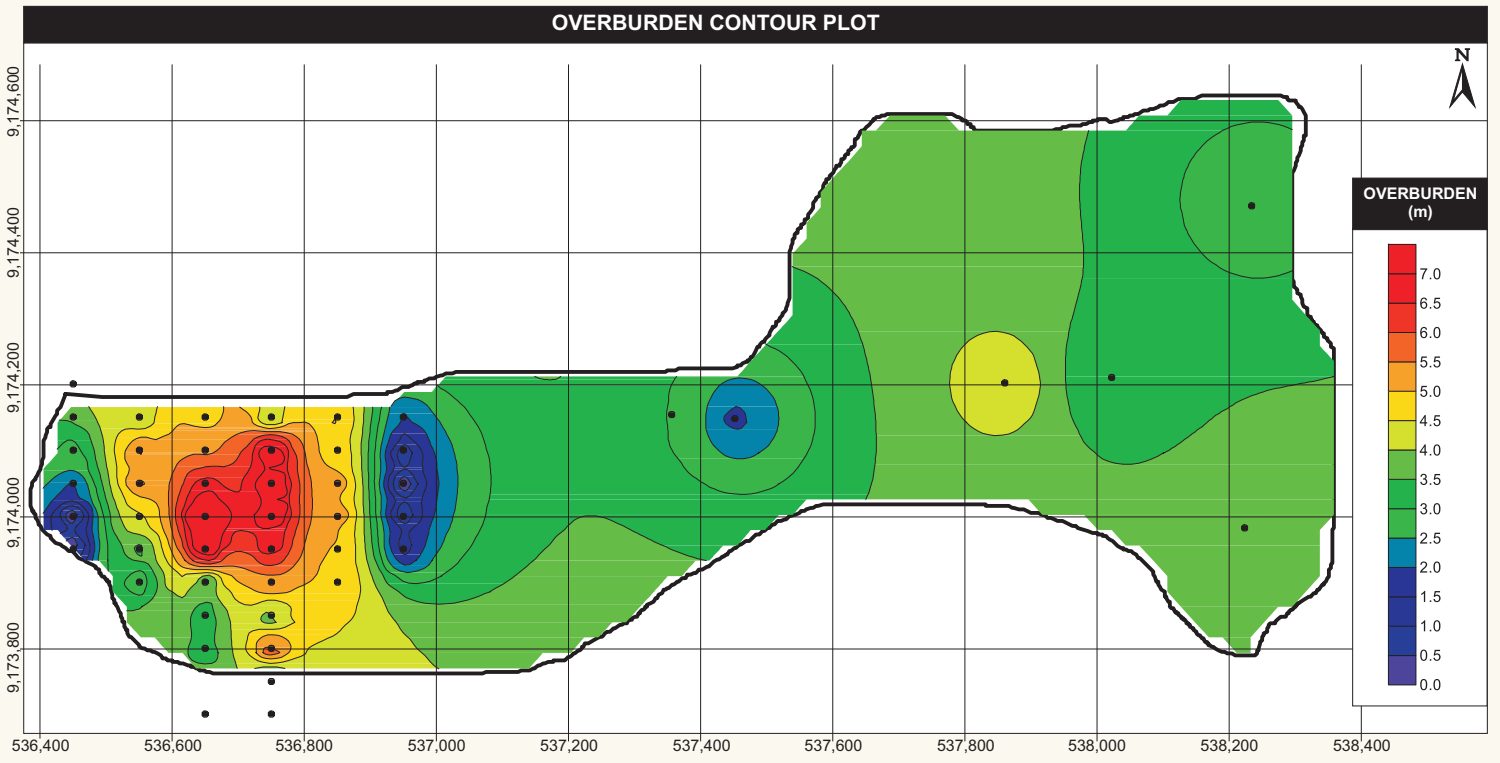
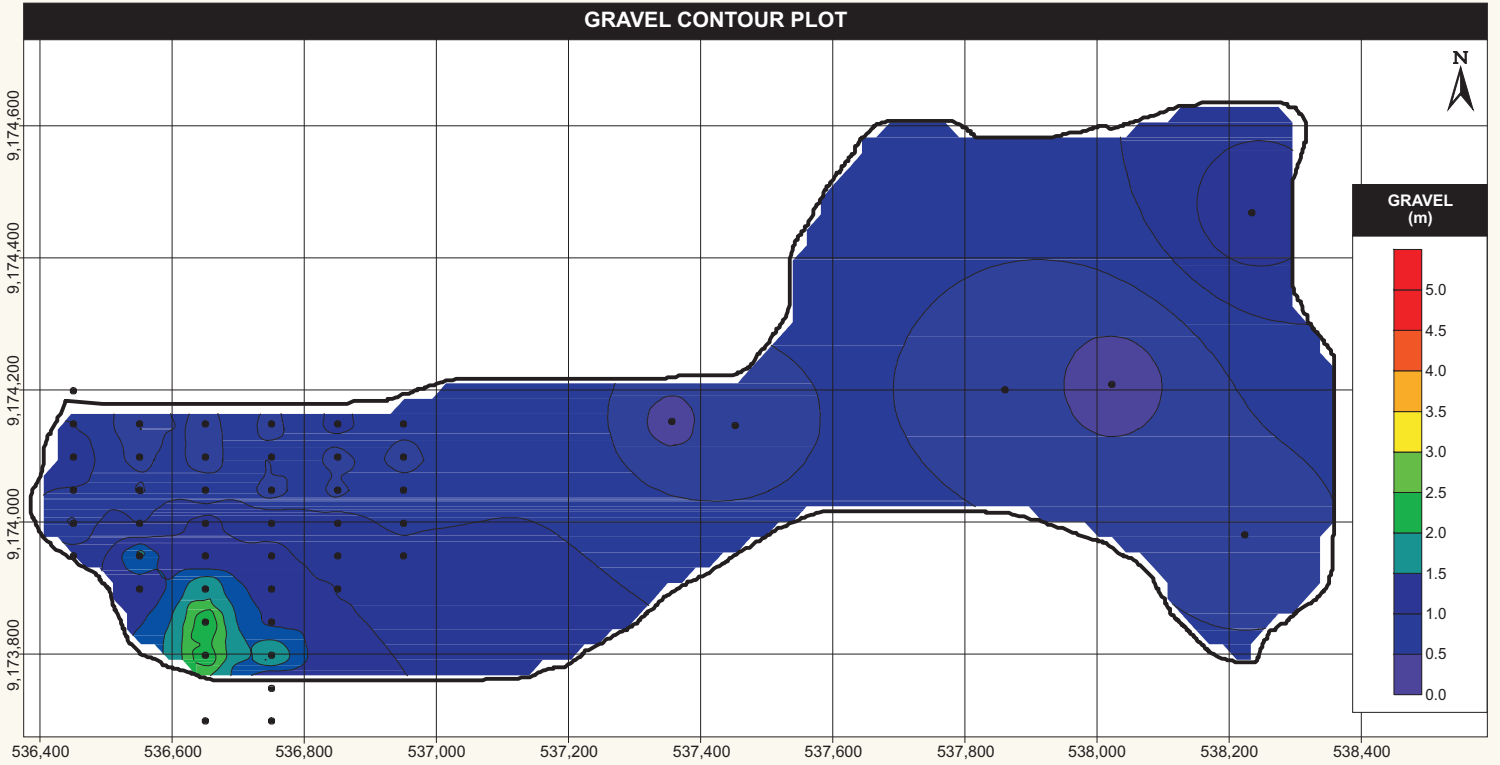

PangeaDFieldsTSX'07Fig60.cdr

Source: Venmyn

This diagram and the information herein is copyrighted. It may not be reproduced or transmitted in any form or by any means without prior written permission from Venmyn Rand (Pty) Ltd. Trading as Venmyn.



• Pit

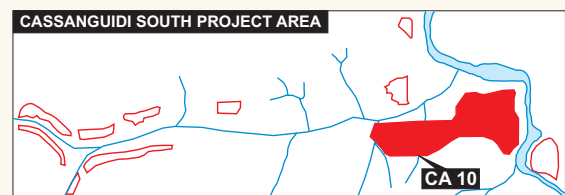

### 23.3.2 Sample Preparation, Analyses and Security

A single sample was taken from each pit and processed using the pan plant. Each sample was referred to by its pit number which is a combination of the block name and the sequence of bulk samples taken (eg. CA05b – T11). The samples were extracted by excavator and transported to the plant using ADTs. The sample was kept isolated in the stockpile until it was processed through the plant. Prior to processing, the plant was flushed out to prevent contamination. The bottom screen size cutoff was 1.6mm, as described in further detail in Section 23.6.

The method of sample preparation is adequate. The method of processing using a pan plant is good. However, the utilisation of open grease tables does pose a security risk. This may result in the under estimation of the grade and, as a result, the Qualified Person has accepted these results. PDF will be upgrading their security in the final recovery plant as a matter of priority.

### 23.3.3 Data Verification

The pit coordinates and diamonds recovered were recorded in an Excel sheet. The final void was measured to confirm the volume extracted for grade calculation. These sheets were submitted to PDF's head office in Johannesburg for verification. Although Venmyn has not verified the data in detail we have witnessed the rigorous process of verification which PDF's headoffice geologist carries out. As a result, the Qualified Person is satisfied that the potential for any error to occur is minimised.

### 23.3.4 Results

The result of the bulk sampling pits are summarised in Table 82.

**Table 82 : Bulk Sampling Results for Cassanguidi South Project Area**

BLOCK NO.	GRAVEL TYPE	O/B THICK (m)	GRAVEL THICK (m)	GRAVEL VOLUME (m <sup>3</sup> )	CARATS	NO. STONES	GRADE (ct/100m <sup>3</sup> )	STONE SIZE (ct/stone)	BOTTOM SCREEN SIZE (mm)
CA05b	Sand Bar	4.30	2.40	1,800	281.74	1,053	15.65	0.27	1.6
CA08	Colina	1.44	1.80	870	47.86	300	5.50	0.16	1.6
CA09	Colina	1.50	1.17	1,200	115.43	678	9.62	0.17	1.6
<b>TOTAL/AVE</b>				<b>3,870</b>	<b>445.03</b>	<b>2,031</b>	<b>11.50</b>	<b>0.22</b>	

A total of 445cts has been extracted with an average stone size of 0.22ct/stone.

## 23.4 Pilot Mining

Activities commenced at Cassanguidi South in January 2005 as a pilot mining operation.

### 23.4.1 Sampling Method and Approach

Trenches or pilot mining cuts were excavated within the Cassanguidi South Project Area using conventional openpit mining methods. The locations of the recent mining blocks are illustrated in Figure 54.

The overburden was stripped using bulldozers and excavators and the gravel extracted using excavators. All overburden and gravel is soft and unconsolidated and requires no blasting. The ore was then transported to the plant by ADTs for processing. The mining equipment currently available on site includes three excavators, three FEL's, three ADT's and a bulldozer.

The trenches were typically 15m by 50m in size. The average stripping ratio for the mining to December 2007 was calculated at 1:3.67 (gravel m<sup>3</sup> : overburden m<sup>3</sup>). The economic stripping ratio cutoff, based upon the grade and current cost profile of the operation is 1:7.

The monthly pilot mining production volumes for the last six months have varied between 8,000m<sup>3</sup> and 18,000m<sup>3</sup> and the associated recovered grades between 3.43ct/100m<sup>3</sup> and 6.15ct/100m<sup>3</sup>.

### 23.4.2 Sample Preparation, Analyses and Security

The gravels are hauled to the pan plant by ADTs and then fed into the plant using FELs. The gravels are treated using either the main pan plant or the auxiliary plant, depending on the clay content of the ore. A detailed description of the pan plants, the final recovery plant and the associated security area provided in Section 23.6. The author's comments on the sampling are summarised in Section 23.3.2.

### 23.4.3 Data Verification

All volumes extracted from the various trenches were calculated from measurements of height, length and breadth using a tape measure. These were reconciled with the volumes entering the plant measured from the FEL bucket volumes and a bulking factor. The volumes were, on average, within 7% of each other. This is not considered as a material difference. The trench volume measurements were considered most accurate and these were used to calculate grades. Footwall dilution was also measured for each trench and currently varies between 10% and 13%.

All results are recorded in Excel spreadsheets on a daily basis. Results are also sent through to the head office in South Africa for verification. Venmyn has previously verified the production data and found it to be accurate. As a result the Qualified Person has relied upon the data supplied by the mine and verified by headoffice.

### 23.4.4 Results

The total mine production tonnages and recovered grades, on a monthly basis since 2005, are graphed in Figure 61.

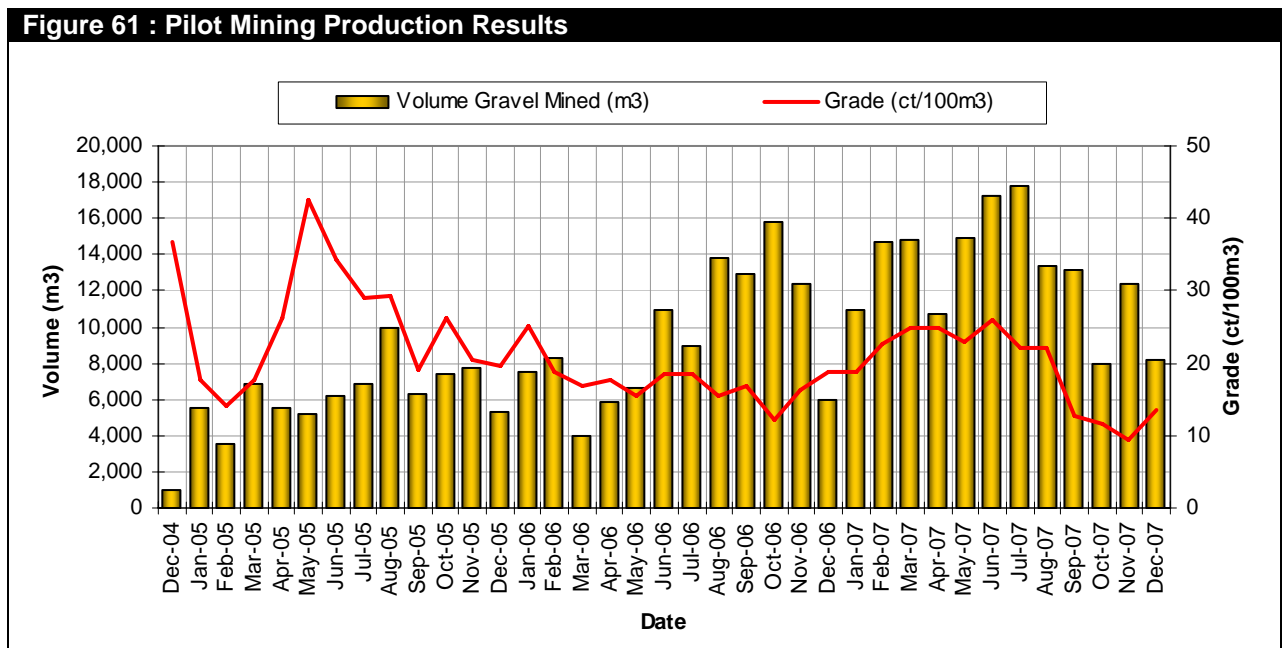

The recent decline in production grade and tonnage has been a result of mechanical breakdown and is not a reflection of the orebody grades. The excavator, which was used to strip overburden, experienced a breakdown in mid-August 2007. As a result of the lack of equipment for stripping, a low grade ore stockpile has been processed in order to supplement the plant feed. This has resulted in the decrease in grade.

The pilot mining results are also recorded on a block by block basis for use in resource grade determination. These results are tabulated in. The locations of the blocks are indicated on Figure 54.

It is important to note that, in the case of CA05b, we have bulk sampling results (Table 82) as well as pilot mining results (Table 83). The results are very similar which provides comfort in the estimation of grades using bulk sampling.

**Table 83 : Summary of Pilot Mining Results on a Block by Block Basis**

BLOCK NO.	GRAVEL TYPE	O/BT HICK (m)	GRAVEL THICK (m)	GRAVEL VOLUME (m <sup>3</sup> )	CARATS	NO. STONES	GRADE (ct/100m <sup>3</sup> )	STONE SIZE (ct/stone)	BOTTOM SCREEN SIZE (mm)
CA01	Colina	3.50	0.85	24,849	6,295.08	19,091	25.33	0.33	1.6
CA02	Colina	5.80	1.40	54,716	14,724.55	40,040	26.91	0.37	1.6
CA03	Terrace	2.70	0.64	10,263	1,592.75	6,476	15.52	0.25	1.6
CA04a	Colina	10.50	3.18	43,854	7,111.46	23,030	16.22	0.31	1.6
CA04b	Colina	4.50	1.15	1,259	204.87	728	16.27	0.28	1.6
CA05a	Colina	8.20	2.00	67,162	11,943.44	49,457	17.78	0.24	1.6
CA05b	Sand bar	4.30	1.91	12,561	2,096.00	7,099	16.69	0.30	1.6
CX01	Colina	8.40	1.60	78,493	12,196.95	50,851	15.54	0.24	1.6
CX02	Colina	9.60	1.83	43,583	12,314.97	49,293	28.26	0.25	1.6
<b>TOTAL/AVE</b>				<b>336,740</b>	<b>68,480.07</b>	<b>246,065</b>	<b>20.34</b>	<b>0.28</b>	

A total of 71,298cts was produced by pilot mining from Cassanguidi South between February 2005 and December 2007. The average stone sizes for the production are indicated on Figure 62. Stone sizes for the openpit operation have varied between 0.23ct/stone and 0.42ct/stone, with an average of 0.28ct/stone.

A total of 92% of these diamonds are less than 1ct in size, 6% occur in the size range of between 1ct and 5cts and 2% are greater than 5ct in size.

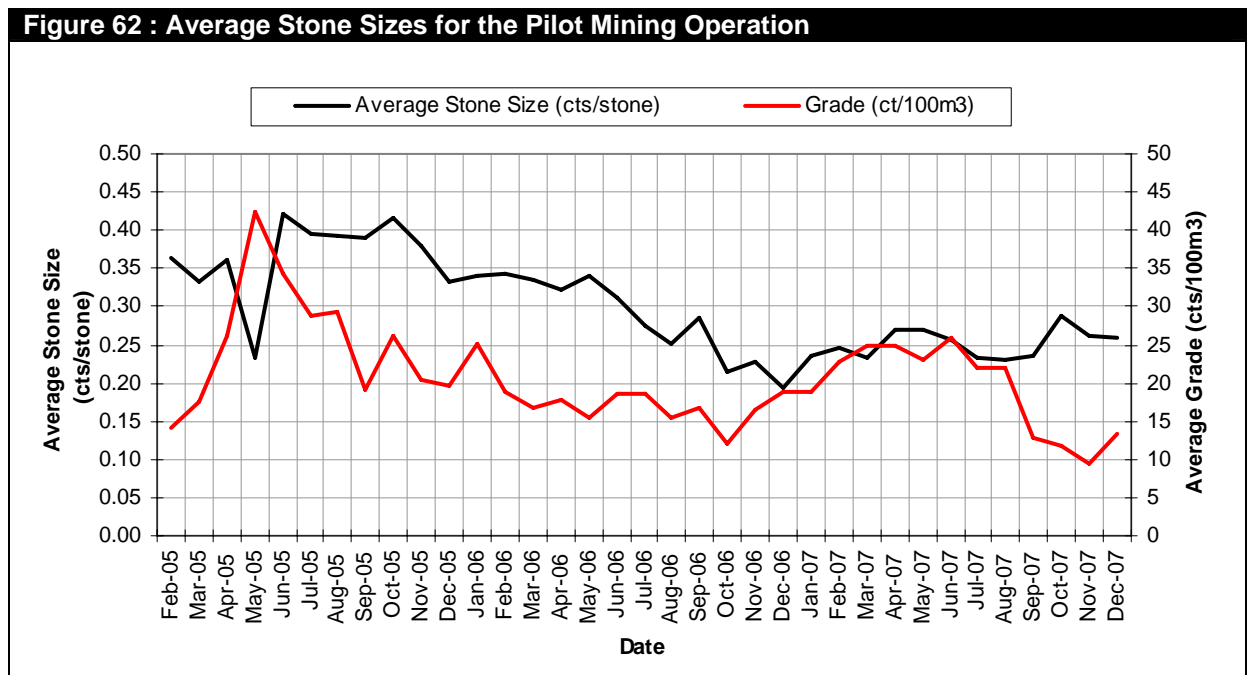

The diamonds were sorted by the mine personnel into various size fractions post acid wash and pre-shipment. The resultant cumulative SFD for each parcel until January 2008, along with the average for all the parcels, was plotted in Figure 63.

The similarity of subsequent SFD curves indicates that the diamond parcels, extracted to date, are representative of the source. Therefore future production can be expected to be similar to the average curve. As a consequence, average diamond prices received to date will also be indicative of values likely for the future production. The further to the left the curve is situated on the graph, the greater is the relative percentage of small stones and the lower the average diamond price is likely to be.

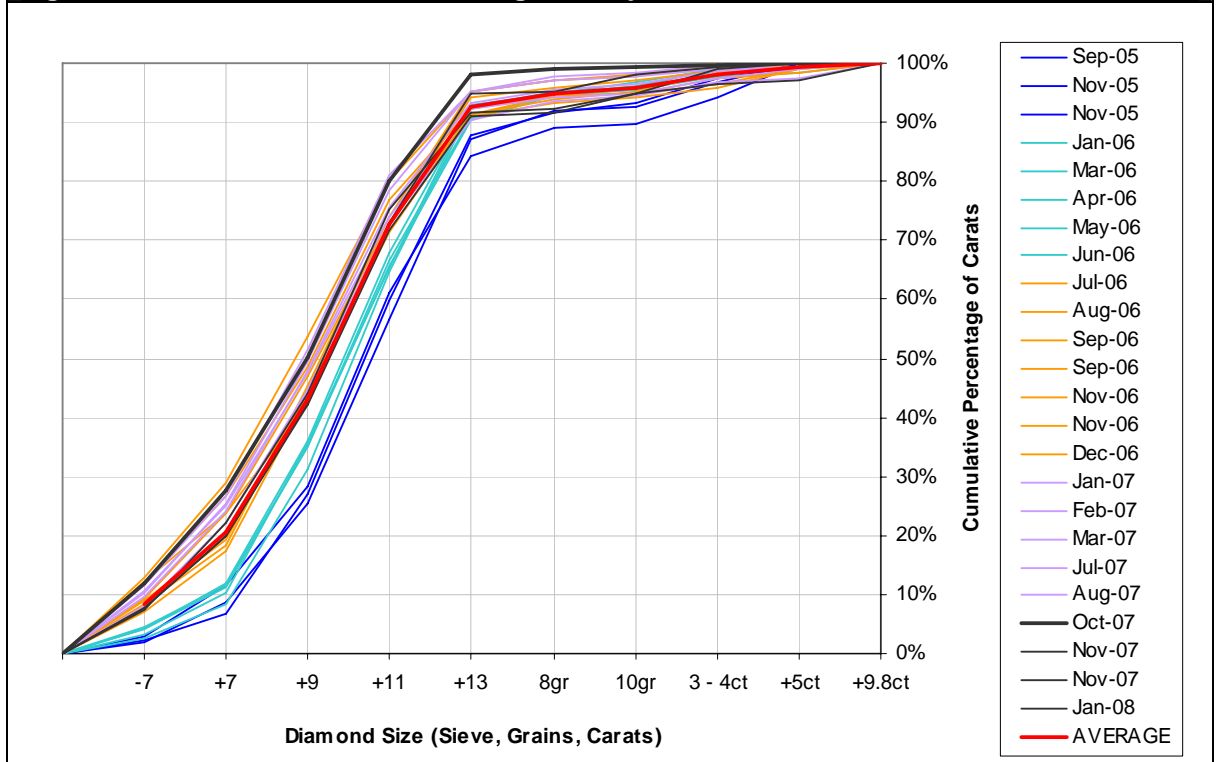
**Figure 63 : Cumulative SFD for Cassanguidi Project**

The parcels of 2005 show a low (<math><10\%</math>) relative percentage of small (+7 sieve size) stones. This percentage increases marginally (~10%) during the first six months of 2006. During the latter half of 2006 the percentage of small (+7 sieve size) stones increases to almost 20% of the total parcel. During this period the relative percentage of medium to large stones decreases in proportion. Further increases in the relative percentage of the small stones continue in 2007. The greatest proportion of small stones is obtained in the October 2007. This is most probably a direct result of the lack of stripping and the resultant treatment of large proportions of low grade stockpiles.

The increasing relative proportion of small stones could be related to one or more of the following aspects of the operation:-

- the processing plant. An increase in small stones can result from a decrease in the bottom screen size. This has not been carried out at Cassanguidi;
- the security situation. The security associated with Cassanguidi has recently been tightened with the employment of a new security manager and the installation of cameras on the grease tables. However in order to further minimise any potential for theft, PDF plans to install a hands off final recovery method in the near future; and
- the orebody characteristics. A decrease in the average stone size of the diamond produced would cause the relative percentage of small stones to increase. It is evident from the graph in Figure 62, that a trend in decreasing average stone size has occurred since 2005. Although this has flattened significantly in the last couple of months. As a result we would expect the average stone size and SFD curves to improve going forward.

### 23.5 Adjacent Properties

Two operating alluvial diamond mines are located adjacent to the Cassanguidi Project. The Fucauma Mine, owned in part by South African listed company Trans Hex Group Ltd (Trans Hex), is situated to the north and west of the Cassanguidi Project. The Chimbongo Mine, owned by the Portuguese Bank, Espirito Santo Investment (ESCOM) is situated to the south.

Due to Transhex being a publically listed company, information on Fucauma is freely available in Trans Hex's annual report.

Fucauma Mine's concession area covers the Luembe and Chiumbe Rivers and their associated tributaries. Details of the gravel types under production are not provided in Trans Hex's annual report and as a result a direct comparison with Cassanguidi cannot be made. However, the mine has reported production of 83,000cts in 2006 and 73,000cts in 2007. The mine has declared Indicated and Inferred Diamond resources prepared in accordance with the SAMREC Code. These are shown in Table 84. According to the CIM Standards the classification result would be the same as that tabulated below.

**Table 84 : Fucauma Mine Diamond Resources (SAMREC, 2007)**

MINE	INDICATED DIAMOND RESOURCES			INFERRED DIAMOND RESOURCES		
	GRAVEL VOLUME (m <sup>3</sup> )	GRADE (ct/100m <sup>3</sup> )	CARATS (cts)	GRAVEL VOLUME (m <sup>3</sup> )	GRADE (ct/100m <sup>3</sup> )	CARATS (cts)
Fucauma	2,581,000	18.32	472,839	6,025,000	14.47	871,818

Source : Trans Hex Group Ltd Annual Report (2007)

It must be noted that Venmyn's qualified person has not verified the information. In addition, the information is not necessarily indicative of the mineralization on the property that is the subject of this technical report.

### 23.6 Mineral Processing and Metallurgical Testing

The ore processed through the bulk sampling and pilot mining are considered to be representative of the deposit. The close comparison of the bulk sampled grade with the mined grade provides evidence of this.

#### 23.6.1 Main Pan Plant

The pan plant is situated adjacent to the current openpit pilot mining operations (Figure 54). The plant is comprised of a 100tph scrubber and two 14ft pans capable of treating feed at a combined rate of 50tph.

Ore is fed into the plant by FEL. Feed volumes are measured via the loader bucket and reconciled to measured volumes extracted from the excavation. The feed passes through a scrubber with a top reject size of 25mm. The ore is deslimed at bottom screen size cutoff of 1.6mm. The slimes are fed to a purpose built puddle dam with the excess reporting to a slimes dam down slope of the plant.

The +1.6mm-25mm fraction passes over a dewatering screen and is conveyed to a clean product stockpile.

The product is fed into two 14ft pans. Feed volumes are again calculated on the loader bucket size. The pans are operated in parallel at a rate of 50tph and rotational speed of 8rpm. The amount of puddle required to maintain the correct viscosity for each pan is pumped from the puddle dam. Concentrate is extracted from the pan through continuous tapping using an auger.

The concentrate is then washed and passes via a closed tube conveyor to a hopper ready for final recovery.

Recovery tests are conducted on a regular basis using tracer blocks inserted at various points along the circuit. According to management, the test results indicate a 95% recovery rate for the plant. The simplified flowsheet for the plant is illustrated in Figure 64.

The processing results for Cassanguidi South Project Area are graphically illustrated in Figure 65.

**SCHEMATIC FLOWSHEET FOR CASSANGUIDI SOUTH PROJECT AREA MAIN PAN PLANT**

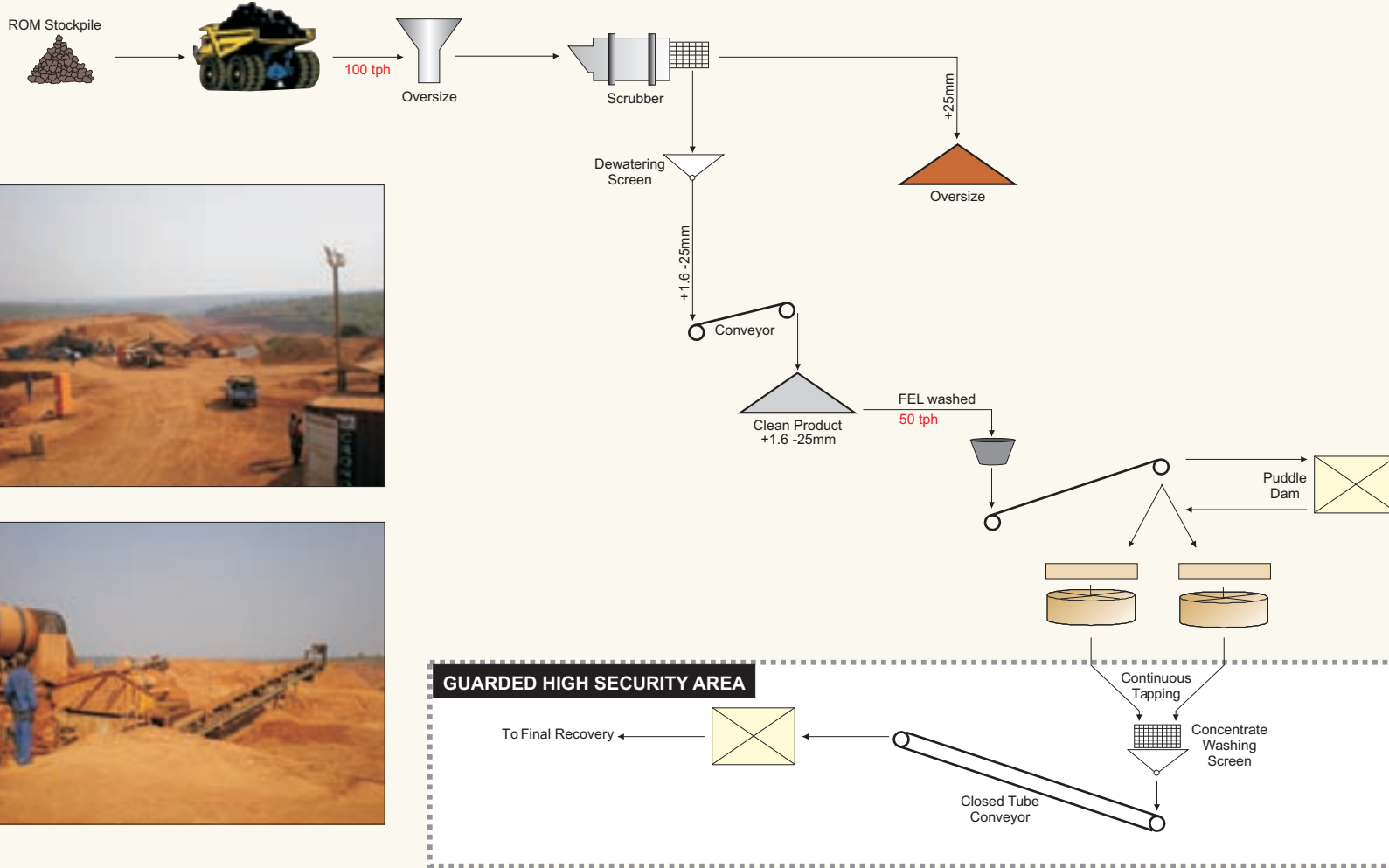

Source: Venmyn

This diagram and the information herein is copyrighted. It may not be reproduced or transmitted in any form or by any means without prior written permission from Venmyn Rand (Pty) Ltd. Trading as Venmyn.

PangeaDFieldsTSX'07Fig64.cdr

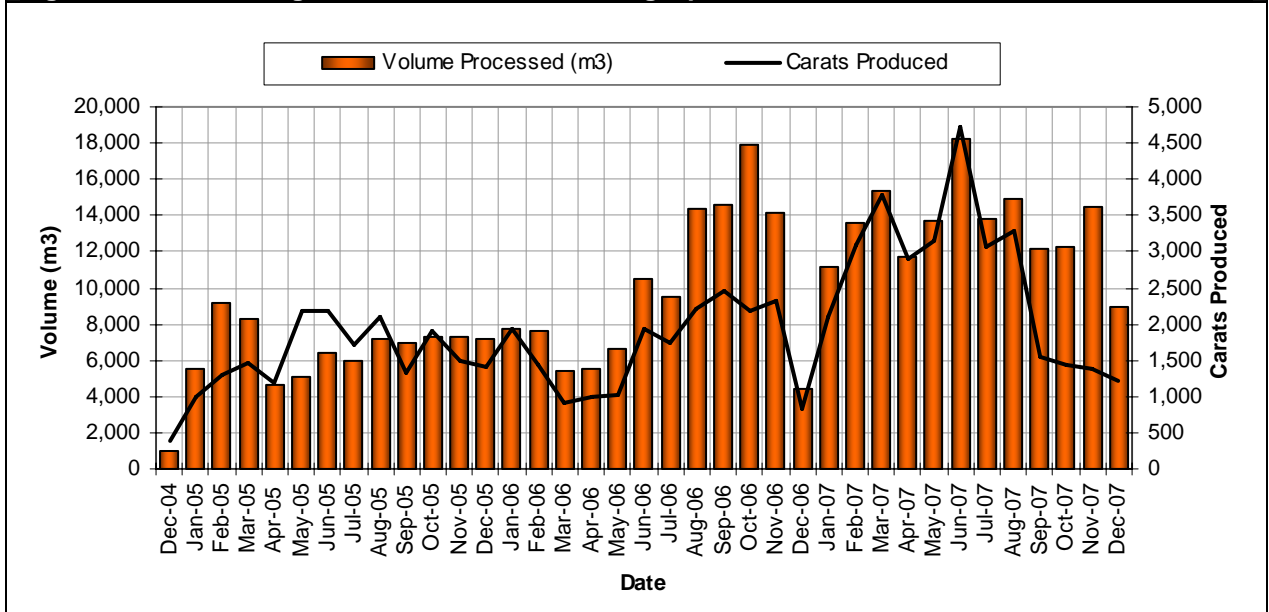
**Figure 65 : Processing Results for the Pilot Mining Operation**

### 23.6.2 Auxiliary Pan Plant

The auxiliary pan plant is comprised of a single 16ft pan with a trommel on the front end. It has no scrubber. This plant represents spare capacity which is typically utilised for ore with a low clay content which requires no scrubbing. The schematic flowsheet is graphically represented in Figure 66.

The auxiliary plant is fed using a FEL at a rate of 50tph. The ore then passes through the trommel to remove the +32mm oversize. The -32mm fraction is fed into the pan soaker box which constantly feeds gravel in slurry into the pan. The pan's viscosity is maintained through the controlled addition of water plus additional puddle makeup material, if required. The bottom screen size of the Main Plant is 1.6mm.

Pan concentrate is tapped on a continuous basis using an auger into a sputnik. The concentrates are then delivered to the final recovery plant for diamond extraction.

### 23.6.3 Final Recovery Plant

The final recovery plant is comprised of three double-pad grease tables. The schematic flowsheet is illustrated in Figure 67.

Concentrate is fed from the main or auxiliary plant into a washing screen. Post washing the concentrate passes via a closed tube conveyor into the final recovery container. The concentrate is classified into three size fractions, each of which reports to a specific grease table. The size fractions are:-

- +1.6mm – 6.0mm;
- +6.0mm – 12.0mm;
- +12.0mm – 25.0mm.

The grease tables utilise a double padded layout which eliminates the need for full time monitoring of the concentrate passing over the tables. The grease is regularly collected off the tables and heated using boiling water in order to release the final concentrate containing the diamonds. This is transported to the sort house under armed guard.

The sort house is situated within a double locked container at the camp. Here the diamonds are extracted by hand from the final concentrate and sorted according to size and weighed. They are stored in a double locked safe for shipment, generally on a monthly basis. The diamonds are acid cleaned shortly before shipment.



**SCHEMATIC FLOWSHEET FOR CASSANGUIDI SOUTH PROJECT AREA AUXILLIARY PAN PLANT**

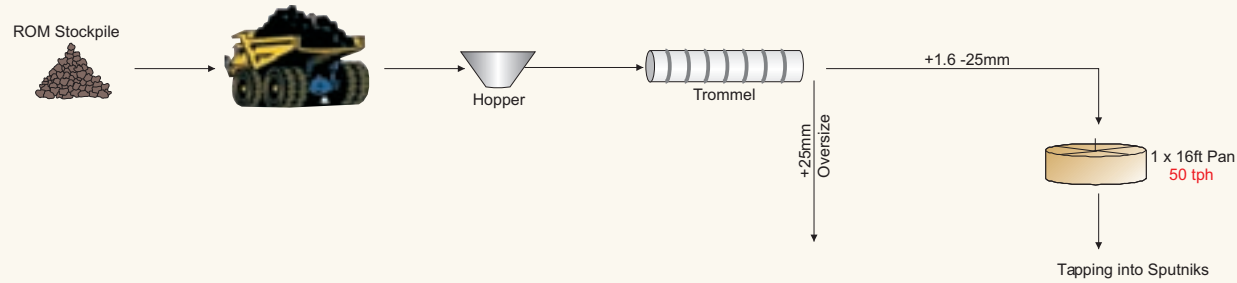

Note: Used for ROM with low clay content which does not require scrubbing

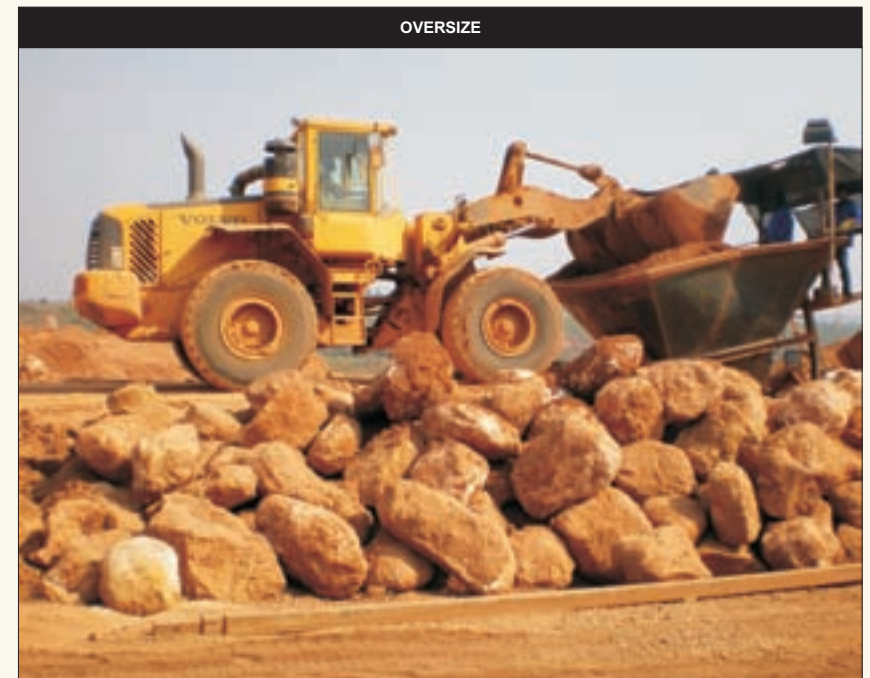

Source: Venmyn

This diagram and the information herein is copyrighted. It may not be reproduced or transmitted in any form or by any means without prior written permission from Venmyn Rand (Pty) Ltd. Trading as Venmyn.

PangeaDFieldsTSX'07Fig66.cdr

**SCHEMATIC FLOWSHEET FOR CASSANGUIDI SOUTH PROJECT AREA FINAL RECOVERY PLANT**

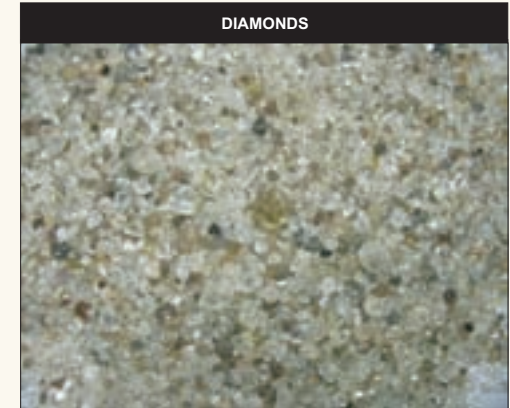
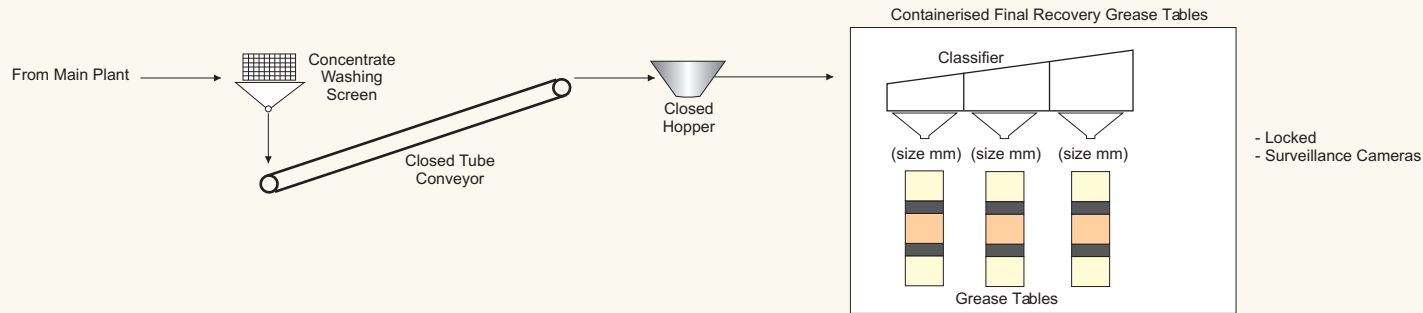

Source: Venmyn

This diagram and the information herein is copyrighted. It may not be reproduced or transmitted in any form or by any means without prior written permission from Venmyn Rand (Pty) Ltd. Trading as Venmyn.

PangeaDFieldsTSX'07Fig67.cdr

### 23.6.4 Security

The current security level in and around the pan plant is relatively low. The current security facilities consist of the following:-

- pans are under continuous scrutiny by security personnel; and
- final recovery feed conveyor is closed.

The security features associated with the final recovery are reasonable and include the following:-

- access to the final recovery area is controlled by armed security and limited to authorised personnel only;
- the plant is located within a secure container modified specifically for this purpose;
- the final recovery plant product is locked and is transported to the sort house under armed guard;
- the sort house is full containerised and locked at all times;
- diamonds are stored in a double locked safe for shipment
- two keys are required to open the safe; and
- both the final recovery and sorthouse are under video surveillance when operating. The video footage is stored on a central server with restricted access.

PDF concedes that security in its final recovery could be improved and is planning a capital investment to implement a “hands free” recovery process. It is anticipated that this could improve both grade and average revenue although the difference is currently not quantifiable.

## 23.7 Diamond Resource and Diamond Reserve Estimates

### 23.7.1 Previous Resource Statements

PDF prepared a diamond resource statement for the Cassanguidi South Project Area in 2006. This statement was reported in their prospectus for listing on the AIM Market on the London Stock Exchange. It was prepared in compliance with the SAMREC Code and was independently verified by Venmyn. All Cassanguidi South Project Area’s diamond resources were classified as Indicated. The diamond resource statement for the entire Cassanguidi Project is tabulated in Table 85.

**Table 85 : Cassanguidi Project Resource Statement (2006)**

MINE / PROJECT	PROJECT AREA	RESOURCE CLASSIFICATION	GRAVEL VOLUME (m <sup>3</sup> )	IN SITU GRADE (ct/100m <sup>3</sup> )	CARATS	DIAMOND VALUE (US\$/ct)	BOTTOM SCREEN SIZE (mm)	
Cassanguidi	Cabuaquece	Inferred	2,567,000	23.62	606,366	180.00	1.6	
	Cachoque	Inferred	784,000	18.10	141,943		1.6	
	Cale	Inferred	625,000	32.13	200,799		1.6	
	<b>TOTAL / AVE INFERRED</b>			<b>3,976,000</b>	<b>23.87</b>	<b>949,109</b>	<b>180.00</b>	<b>1.6</b>
	Cassanguidi South	Indicated	198,521	22.74	45,147	180.00	1.6	
	<b>TOTAL / AVE INDICATED</b>			<b>198,521</b>	<b>22.74</b>	<b>45,147</b>	<b>180.00</b>	<b>1.6</b>

Since 2006, additional diamond resource blocks have been defined and pilot mining extraction has taken place in other blocks.

### 23.7.2 Volume

The volumes of the resource blocks were calculated using one of the following methods:-

- the Surfer® model of gravel thickness was used to derive the volume (Blocks CA02; CA08 and CA09); or
- the average gravel thickness, as determined from recent mining faces in the adjacent block, historical mining faces and artisanal pits was multiplied by the area (Blocks CA04a; CA04b; CA05b).

The surface area was limited by the cutoff stripping ratio of 7m<sup>3</sup>:1m<sup>3</sup>. The resultant volumes are tabulated in Table 86. The location of the resource blocks are indicated on Figure 68.

**Table 86 : Volume Estimation for Cassanguidi South Project Area**

MINE / PROJECT	PROJECT AREA	BLOCK	GRAVEL TYPE	GRAVEL VOLUME (m <sup>3</sup> )
Cassanguidi	Cassanguidi South	CA02	Colina	43,962
		CA04a	Colina	94,808
		CA04b	Colina	75,596
		CA05b	Sand bar	142,029
		CA08	Colina	152,052
		CA09	Colina	33,681
			<b>TOTAL</b>	<b>542,127</b>

### 23.7.3 Density

No density measurements are required as all resources are quoted in volumes. All plant related measurements were carried out using bucket volumes multiplied by a bulking factor. As a result, no density measurements have been carried out for the Cassanguidi Project.

### 23.7.4 Grade

The grade has been calculated as, either:-

- a weighted average of all mining production results from the adjacent blocks (Blocks CA02; CA04a; CA04b and CA05b). There is a high confidence in these grades due to the large volumes which they were derived from; or
- from a single bulk sample result within the block (CA08 and CA09). Due to the small volumes associated with the bulk samples, the confidence in these results is low.

The grades are summarised in Table 87.

**Table 87 : Grade Calculation for Cassanguidi South Project Area**

MINE / PROJECT	PROJECT AREA	BLOCK	GRAVEL TYPE	REC. GRADE (ct/100m <sup>3</sup> )
Cassanguidi	Cassanguidi South	CA02	Colina	26.91
		CA04a	Colina	16.22
		CA04b	Colina	16.27
		CA05b	Sand bar	16.69
		CA08	Colina	5.50
		CA09	Colina	9.62

### 23.7.5 Diamond Value

The diamond values used for the Cassanguidi Project are based upon the sale of approximately 75,000cts between the beginning of 2005 and December 2007. The variations in the sales values obtained are shown graphically in Figure 69.

**LOCATION OF CASSANGUIDI SOUTH PROJECT AREA DIAMOND RESOURCES BLOCKS**

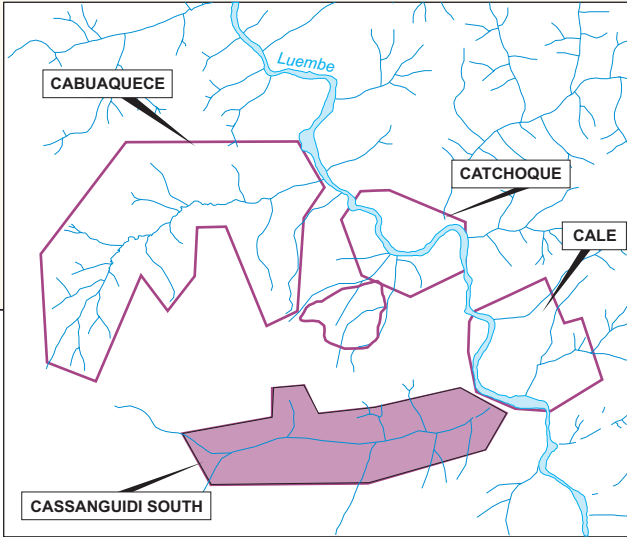

MINE / PROJECT	PROJECT AREA	BLOCK	GRAVEL TYPE	GRAVEL VOLUME (m <sup>3</sup> )	REC. GRADE (ct/100m <sup>3</sup> )	CARATS	DIAMOND VALUE (US\$/ct)	BOTTOM SCREEN SIZE (mm)	RESOURCE CLASSIFICATION	
Cassanguidi	Cassanguidi South	CA02	Colina	43,962	26.91	11,831	160.00	1.6	Indicated	
		CA04a	Colina	94,808	16.22	15,374	160.00	1.6	Indicated	
		CA04b	Colina	75,596	16.27	12,301	160.00	1.6	Indicated	
		CA05b	Sand bar	142,029	16.69	23,700	160.00	1.6	Indicated	
		<b>TOTAL/AVE INDICATED</b>			<b>356,394</b>	<b>17.73</b>	<b>63,206</b>	<b>160.00</b>	<b>1.6</b>	<b>Indicated</b>
		CA08	Colina	152,052	5.50	8,365	160.00	1.6	Inferred	
		CA09	Colina	33,681	9.62	3,240	160.00	1.6	Inferred	
		<b>TOTAL/AVE INFERRERD</b>			<b>185,733</b>	<b>6.25</b>	<b>11,604</b>	<b>160.00</b>	<b>1.6</b>	<b>Inferred</b>

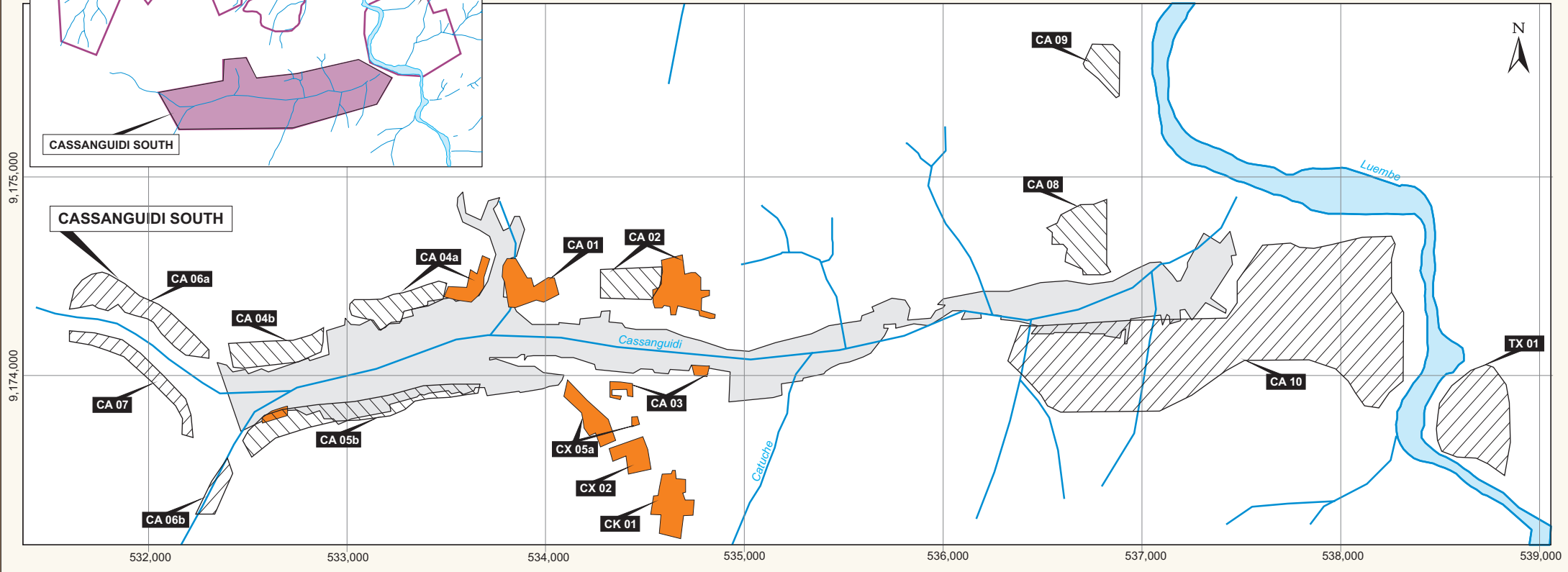

Source: Pangea

**LEGEND:**

- River
- Project Area
- Resource Area
- Inferred
- Indicated
- Mined Out Area
- Recently Mined Out Area

SCALE: 0 1 km

This diagram and the information therein are copyrighted. It may not be reproduced or transmitted in any form or by any means without prior written permission from Venmyn Rand (Pty) Ltd. Trading as Venmyn.

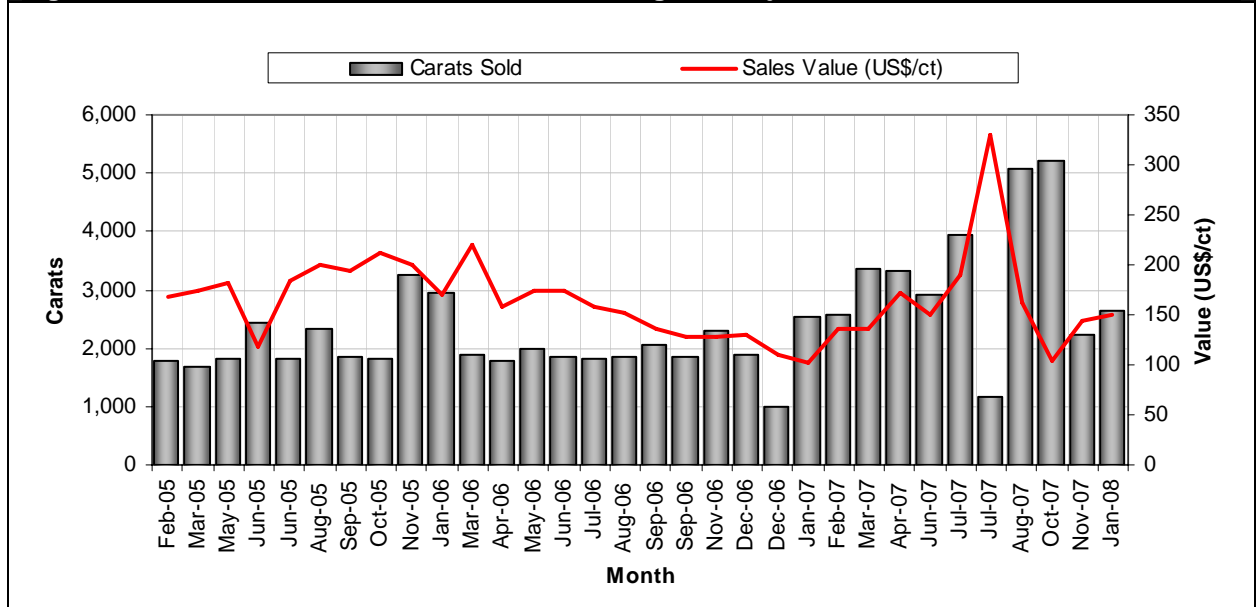
**Figure 69 : Diamond Sales Results for the Cassanguidi Project**

The diamond value applied to all the project areas was calculated as the weighted average over the whole production period. No escalations were utilised, nor any adjustments made to the prices for variations in the market and the time value of money.

**Table 88 : Average Diamond Values Used for Cassanguidi Project**

DATE	CARATS	TOTAL VALUE (US\$)	AVE VALUE (US\$/ct)
Total sales from Jan 2005 - Jan 2008	76,934.90	12,306,159	159.96

### 23.7.6 Current Resource Statement

The Diamond Resource statement for the Cassanguidi South Project Area, dated 31<sup>st</sup> December 2007, was prepared by Mr Manuel Novo, stationed at Cassanguidi in accordance with the SAMREC Code. This was independently verified by PDF, as well as by Mrs Catherine Telfer of Venmyn. The statement is shown in Table 89 and Table 90.

**Table 89 : Inferred Diamond Resource Statement for the Cassanguidi Project (31<sup>st</sup> December 2007)**

MINE / PROJECT	PROJECT AREA	RESOURCE CLASSIFICATION	GRAVEL VOLUME (m <sup>3</sup> )	REC. GRADE (ct/100m <sup>3</sup> )	CARATS	DIAMOND VALUE (US\$/ct)	BOTTOM SCREEN SIZE (mm)
Cassanguidi	Cassanguidi South	Inferred	186,000	6.24	11,604	160	1.6
	Cabuaquece	Inferred	2,567,000	23.62	606,366	160	1.6
	Catchoque	Inferred	775,000	16.15	125,172	160	1.6
	Cale	Inferred	575,000	27.57	158,523	160	1.6
	<b>TOTAL / AVE INFERRED</b>			<b>4,103,000</b>	<b>21.98</b>	<b>901,665</b>	<b>160</b>

**Table 90 : Indicated Diamond Resource Statement for the Cassanguidi Project (31<sup>st</sup> December 2007)**

MINE / PROJECT	PROJECT AREA	RESOURCE CLASSIFICATION	GRAVEL VOLUME (m <sup>3</sup> )	REC. GRADE (ct/100m <sup>3</sup> )	CARATS	DIAMOND VALUE (US\$/ct)	BOTTOM SCREEN SIZE (mm)
Cassanguidi	Cassanguidi South	Indicated	356,394	17.73	63,206	160	1.6
	<b>TOTAL / AVE INDICATED</b>			<b>356,394</b>	<b>17.73</b>	<b>63,206</b>	<b>160</b>

Blocks CA02, CA04a, CA04b and CA05b within the Cassanguidi South Project Area were classified as Indicated as a result of a reasonable level of confidence with respect volume, grade and diamond value. Blocks CA08 and CA09 were classified as Inferred due to a low confidence in the grade measurements, although the volume and diamond values were associated with a reasonable level of confidence. The logic used in the classification is tabulated in Appendix 5.

There is no known item relating to the environment, permits, legal, title, taxation, socio-economic, marketing, and political or any other issue that would have a material effect on the resources identified in the current Diamond Resource statement.

### 23.8 Other Relevant Data and Information

A Preliminary Assessment, including an economic analysis, of the Cassanguidi Project (including the Cassanguid South, Catchoque, Cabuaquece and Cale Project Areas) has been carried out by PDF. It was based upon Inferred Resources and is preliminary in nature. Inferred Resources are considered too speculative to have mining and economic considerations applied to them in order to be converted to Mineral Reserves. There is no certainty that the production and economic forecasts contained in the Preliminary Assessment will be realised.

The results of the preliminary assessment are summarised in Table 91. Venmyn has independently verified the input parameters for the preliminary assessment. We have found them to be fair and reasonable in light of the Cassanguidi Resources Statement (Table 89), PDF's operating experience and Venmyn's knowledge base of similar operations.

**Table 91 : Preliminary Assessment at First Stage of Commercial Mining for Cassanguidi Project**

ITEM	UNITS	AMOUNT	DEFINITIONS & NOTES	ASSUMPTIONS
Capital	USD' M	3.00	Expansion and replacement capital.	
Plant headfeed	m <sup>3</sup> /mth	35,000	Run of mine gravel fed to plant front-end at steady state operations.	Based upon 3 shifts per day, 50% mining efficiency and 80% plant efficiency.
Grade	ct/100m <sup>3</sup>	22	Average grade of the Inferred resources = 22ct/100m <sup>3</sup> . Planned to identify and mine higher grade area within this, therefore use of 22ct/100m <sup>3</sup> will mitigate grade risk.	High grade areas will be identified and mined from the Inferred resources.
Carats produced	cts/mth	7,700	Calculated from plant headfeed and grade.	
Operating costs	USD/m <sup>3</sup>	22	PDF has a good handle of costs from operating the project as a pilot mining operation since early 2005.	Based upon 24 days per month, 3 shifts and 35,000tpm.
Revenue per carat	USD/ct	150	Slightly lower the price obtained to mitigate price risk.	Based upon sale of over 76,000cts in today's market.
Cash contribution	USD/m <sup>3</sup>	11	Calculated from grade, revenue and operating costs.	Pre-tax and depreciation and on project basis ie 100%
Cash contribution	USD' M pa	4.62	Calculated from plant headfeed and cash contribution by cubic metre.	
Inferred Resources	m <sup>3</sup>	2,000,000	Inferred resource of 4.1Mm <sup>3</sup> has been identified. Resource volume used is less but will have a higher grade due to selection.	Identification of smaller volumes with higher average grade.
Projected life	Years	4.76	Calculated from potential resources and plant headfeed.	
Payback period	Years	0.65	Calculated from capital and cash contribution.	
Potential start		2H 2008		

### 23.9 Interpretation and Conclusions

Although the Cassanguidi South Project Area has historically been focussed on pilot mining, recent exploration results have enabled additional resources to be identified.

The exploration has provided information on the lateral and vertical extent of the gravels. These gravels have subsequently been modelled using computer modelling software to determine gravel volumes. Where these have been accompanied by bulk sampling results to obtain grade figure, new Inferred Diamond Resources have been declared.

The modelling of the gravels has indicated that in many cases the gravel thickness is inversely proportional to the overburden thickness thus resulting in certain areas having very favourable stripping ratios.

The large volumes mined and processed, as part of the pilot mining operations, have provided a reasonable level of confidence with respect to grade and diamond values for the adjacent blocks at Cassanguidi South. As a result, these blocks have been declared as Indicated Diamond Resources.

Recent production results have shown a decrease in grade and diamond values. This has been a direct result of mechanical breakdown and the resultant inability to strip the ROM ore. This does not indicate an inherent decrease in the orebody grade.

The exploration results have been verified and the methods independently checked by Venmyn. We are of the opinion that the results are reliable, where stated, and that the data density, quantity and quality are sufficient for the delineation of Inferred and Indicated Diamond Resources where appropriate.

At present, only a small amount of Indicated Resources have been declared for Cassanguidi South and these resources are insufficient for the preparation of a LOM plan. A LOM plan is one of the minimum requirements for the demonstration of economic viability and the associated conversion of Indicated Resources into Probable Reserves. Only once this has been carried out can a project develop from pilot mining into a fully fledged mining operation.

### **23.10 Recommendations**

It is recommended that Cassanguidi South focus their exploration efforts on increasing the geological confidence in their Inferred Resources in order to convert them to Indicated Resources. Only once sufficient Indicated Resources have been declared can a LOM plan be developed.

PDF plans to achieve this through systematic trenching over the resource areas during 2008 and 2009 in order to confirm the grades across the delimited Inferred Resource areas.

The summary of planned work programmes for the Angolan Project, including the Cassanguidi South Project Area, is tabulated in Table 99. Venmyn has assisted PDF in the compilation of the work programme and budget in respect of the Cassanguid Project and recommends that the company undertake the programme as stated therein. The expected revenues to be derived from the sale of diamonds extracted during exploration pitting, bulk sampling and pilot mining are shown in Table 100.

## **24 CASSANGUIDI PROJECT – CABUAQUECE PROJECT AREA**

Cabuaquece is the northern most area within the Cassanguidi Project and extends along the east flowing Cabuaquece River, a tributary to the Luembe River.

### **24.1 Exploration**

Detailed historical exploration was carried out by Diamang in the Cabuaquece Project Area, as described in Section 22.3.1. Recent work conducted within the Project Area only included data processing and modelling. No further physical exploration or sampling was carried out by PDF.



**Table 92 : Exploration Work Programme and Costing for Angolan Project**

PROJECT	ITEM	2008				2009			
		Q2 (US\$)	Q3 (US\$)	Q4 (US\$)	Q1 (US\$)	Q2 (US\$)	Q3 (US\$)	Q4 (US\$)	
Cassanguidi	Exploration Expenditure	(1,719,000)	(2,313,000)	(2,492,000)	(2,400,000)	(2,400,000)	(2,400,000)	(2,400,000)	
	Capital Expenditure	(2,800,000)							
	<b>TOTAL</b>	<b>(4,519,000)</b>	<b>(2,313,000)</b>	<b>(2,492,000)</b>	<b>(2,400,000)</b>	<b>(2,400,000)</b>	<b>(2,400,000)</b>	<b>(2,400,000)</b>	
	Activity	Trenching systematic; resource delineation; and bulk sampling of trenching material.	Trenching systematic; resource delineation; and bulk sampling of trenching material. Mining Module 1 equipment arriving on site	Trenching systematic for ongoing resource delineation; Mining Module 1 developed and commissioned.	Trenching systematic for ongoing resource delineation; Mining Module 1 scaled up to full capacity.	Trenching systematic for ongoing resource delineation; Mining Module 1 at full capacity.	Trenching systematic for ongoing resource delineation; Mining Module 1 at full capacity.	Trenching systematic for ongoing resource delineation; Mining Module 1 at full capacity.	
	Phase	Pilot Mining	Pilot Mining	Mining Module 1	Mining Module 1	Mining Module 1	Mining Module 1	Mining Module 1	

## Notes

Results of each phase determines whether a project moves into the subsequent phase or if it is terminated.

PDF required to finance all above expenditure, even though their shareholding may be less than 100%.

Exploration and capital expenditure to be funded through capital raising and revenues from diamonds mined and sold from the project.

**Table 93 : Revenue Generation for Angolan Project**

PROJECT	ITEM	2008				2009			
		Q2 (US\$)	Q3 (US\$)	Q4 (US\$)	Q1 (US\$)	Q2 (US\$)	Q3 (US\$)	Q4 (US\$)	
Cassanguidi	Revenue	1,543,000	3,038,000	3,038,000	3,500,000	3,500,000	3,500,000	3,500,000	
	<b>TOTAL</b>	<b>1,543,000</b>	<b>3,038,000</b>	<b>3,038,000</b>	<b>3,500,000</b>	<b>3,500,000</b>	<b>3,500,000</b>	<b>3,500,000</b>	

## Notes

Revenue to be derived from sale of diamonds extracted from the project during exploration pitting, bulk sampling & pilot mining.

Based upon grades and diamond values as per resource statement.

## 24.2 Data Modelling

### 24.2.1 Method and Approach

In May 2004, CJ Muller of Professional Geoscience Services (PGS) was contracted to evaluate the Cassanguidi concession. PGS computerised all the information and geo-referenced the pits. The average sample spacing was 50m by 50m (Figure 51). PGS analysed the geological trends and statistics pertaining to the concession's data and the resource blocks originally delineated by Diamang.

PDF utilised the digital data and modelled the gravels in Surfer®. They used the inverse distance squared method of estimation and a search radius of 200m. The outer limit of the modelled area was based upon the limit of the gravel. The variations in the overburden and gravel thicknesses as well as the grade were modelled.

### 24.2.2 Data Verification

The positioning of the pit data in relation to the current river systems was problematic and the exact positions may have an associated displacement error. However, the positions of the pits in relation to each other are correct and as a result the gravel volume calculations will be reliable.

### 24.2.3 Results

The descriptive statistics for the Cabuaquece mining area, based upon PDF's results, are shown in Table 94. The results are shown as contour plots in Figure 70 and Figure 71.

**Table 94 : Descriptive Statistics for the Cabuaquece Project Area**

PROJECT AREA	BLOCK NO.	NO. PITS	GRAVEL THICKNESS (m)			OVERBURDEN THICKNESS (m)			GRADE (ct/100m <sup>3</sup> )		
			MIN	MAX	MEAN	MIN	MAX	MEAN	MIN	MAX	MEAN
Cabuaquece	N/A	1,254	0.00	17.95	0.84	0.00	23.85	5.63	0.01	667.32	29.18
	<b>TOTAL/AVE</b>	<b>1,254</b>									

The gravel thickness plot illustrates that the majority of the area has a consistent gravel thickness of up to 1.0m. A single pit in the north provides a gravel thickness reading of over 17m. This thick gravel package may be a result of a geological process but is more likely to be an error in the original data. In general, however, the gravel thickness tends to increase away from the tributaries.

As expected, the overburden plot shows a rapid increase away from the Luembe tributary rivers as a result of the increasing topography.

The grade varies from 0cts/100m<sup>3</sup> to a maximum of 667ct/100m<sup>3</sup>. The contour plot indicates that the majority of the project area has a grade of less than 50ct/100m<sup>3</sup>. High grade areas tend to occur close to the tributary rivers and this is where the majority of the historical mining has taken place. A further increase in grade is evident to the southwest.

## 24.3 Adjacent Properties

A brief discussion on the adjacent properties is located in Section 23.5.

## 24.4 Mineral Processing and Metallurgical Testing

No mineral processing has been carried out for the Cabuaquece Project Area.

**CONTOUR PLOT OF GRAVEL AND OVERBURDEN THICKNESSES FOR THE CABUAQUECE PROJECT AREA**

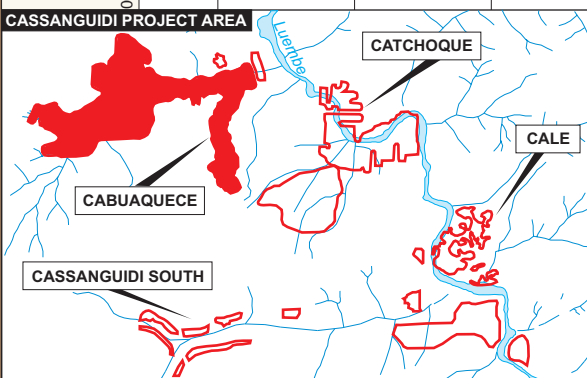
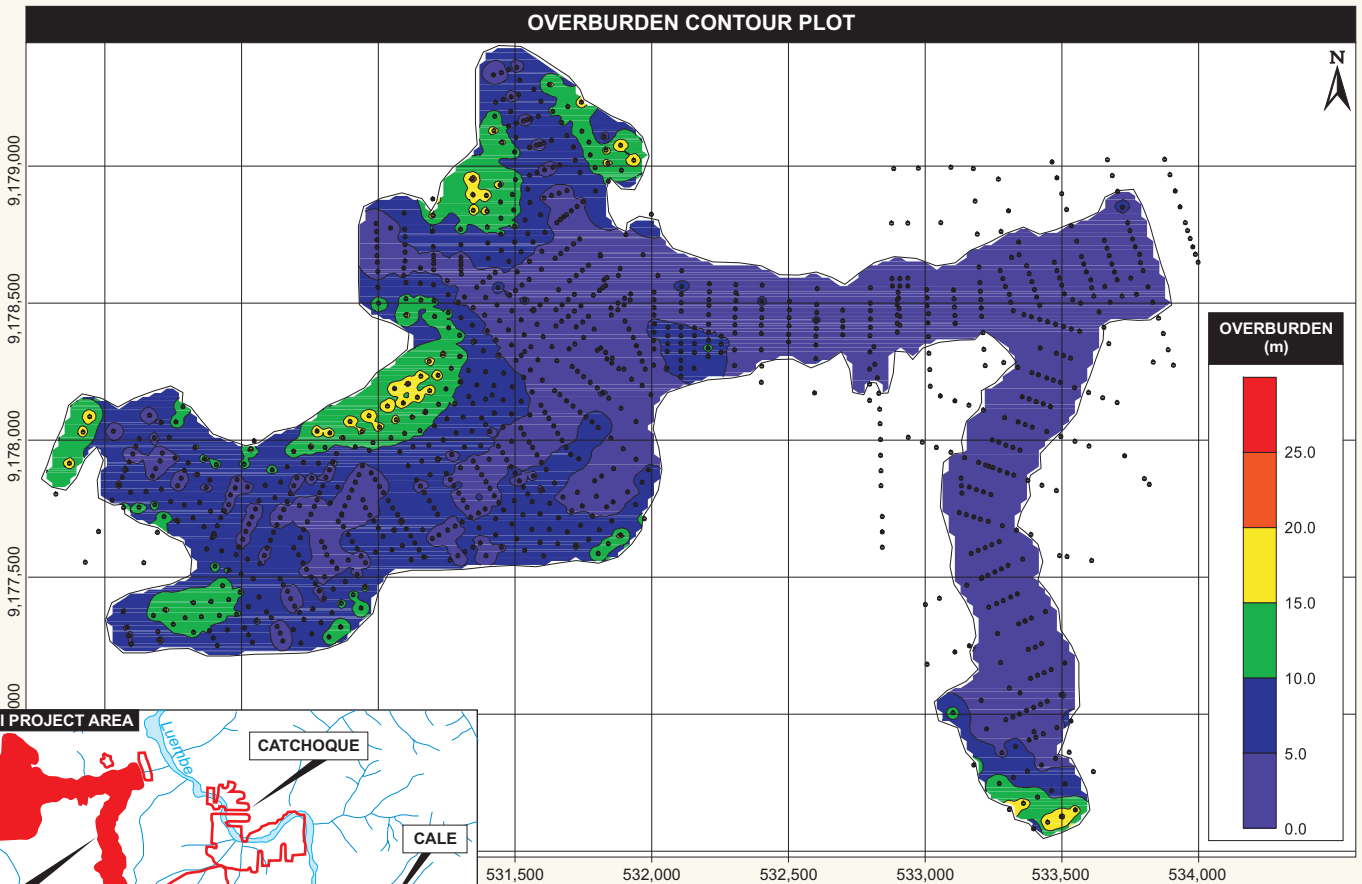
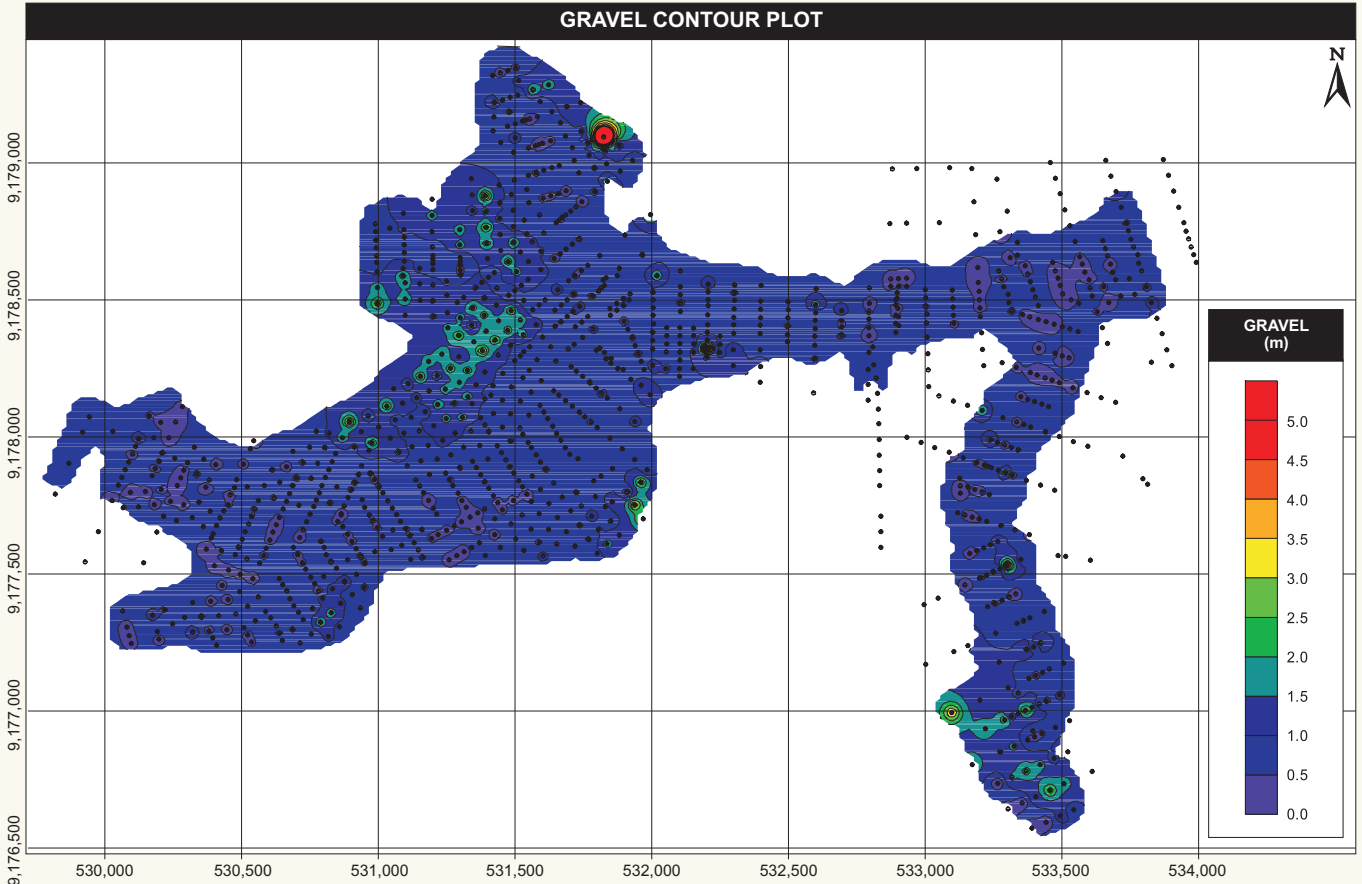

• Pit

Source: Venmyn

This diagram and the information herein is copyrighted. It may not be reproduced or transmitted in any form or by any means without prior written permission from Venmyn Rand (Pty) Ltd. Trading as Venmyn.

PangeaDFieldsTSX'07Fig70.cdr

**SCALE:**



**CONTOUR PLOT OF GRADE VARIATIONS FOR THE CABUAQUECE PROJECT AREA**

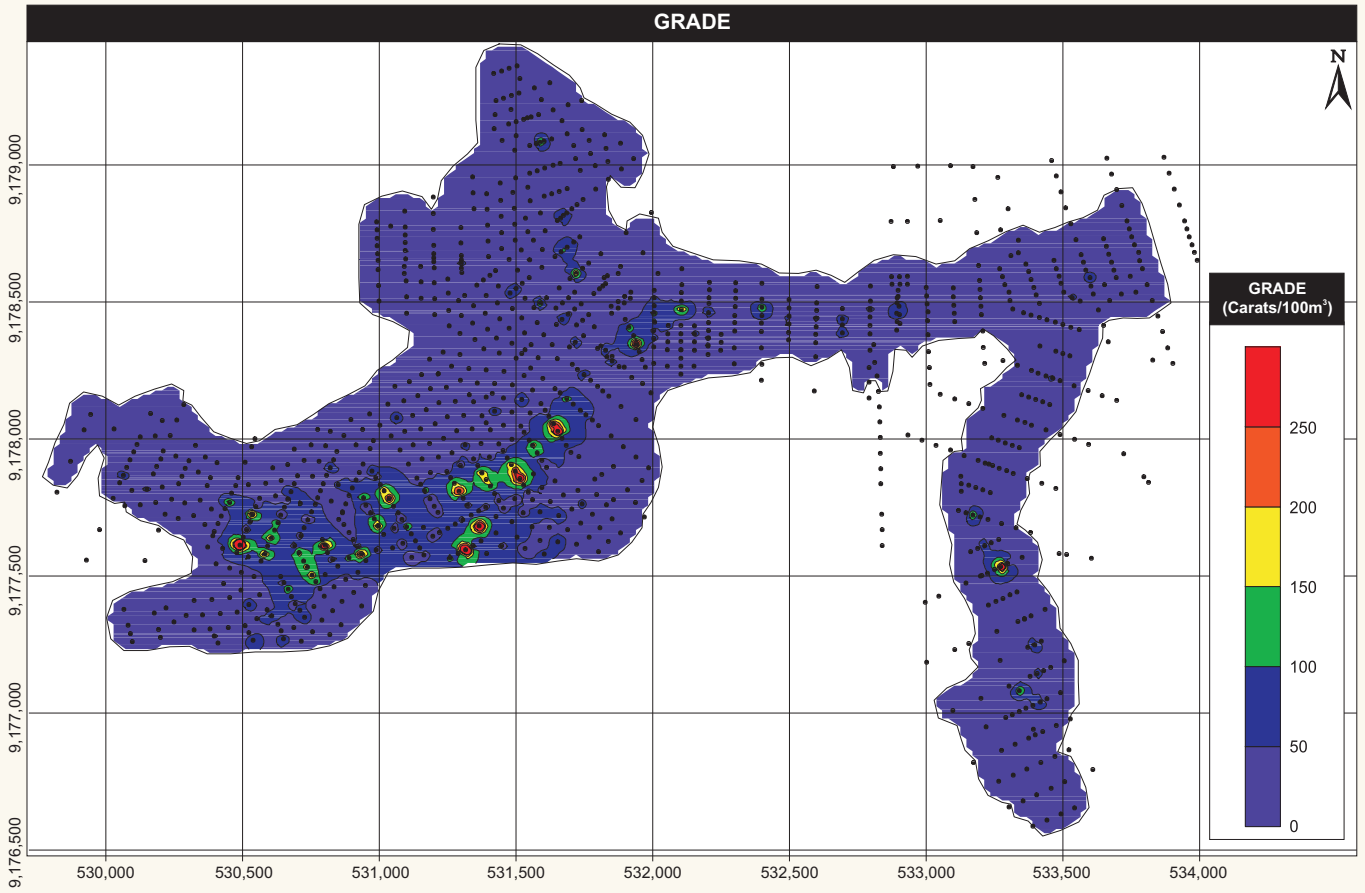
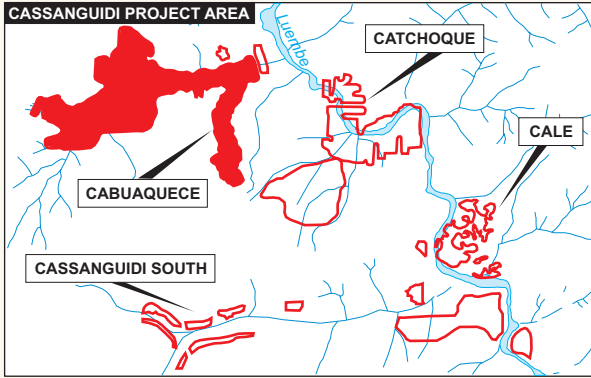

Source: Venmyn

SCALE:

• Pit

This diagram and the information herein is copyrighted. It may not be reproduced or transmitted in any form or by any means without prior written permission from Venmyn Rand (Pty) Ltd. Trading as Venmyn.



## 24.5 Diamond Resource and Diamond Reserves Estimate

### 24.5.1 Previous Resource Statements

As noted in Section 23.7.1, a SAMREC compliant diamond resource statement was issued by PDF in 2006 for the Cabuaquece Project Area. The resources are tabulated in Table 85.

### 24.5.2 Volume

The volume of the resources was re-estimated in January 2008 using the pit database of gravel thickness. This parameter was modelled using Surfer®, as described in Section 24.2.1. The resultant volumes were then decreased by the historically mined out areas to arrive at the remaining gravel volume (Table 95).

**Table 95 : Volume Estimation for Cabuaquece Project Area**

MINE / PROJECT	PROJECT AREA	BLOCK	GRAVEL TYPE	GRAVEL VOLUME (m <sup>3</sup> )
Cassanguidi	Cabuaquece	N/A	Lezeria	3,212,325
		Less mined out areas	Lezeria	563,056
	<b>TOTAL/AVE CABUAQUECE</b>			<b>2,567,201</b>

The recent volume calculations resulted in a small difference in the volumes compared to that previously issued in 2006. This was due to a slight difference in the block outline.

### 24.5.3 Density

No density measurements were required as all resources are quoted in volumes.

### 24.5.4 Grade

The grade was also re-modelled in Surfer® in January 2008. It was carried out using the inverse distance squared method of estimation and all data points. The grades were then reduced to take into account the mined out area, predominately associated within the high grade areas situated near the river. The grades are summarised in Table 96.

**Table 96 : Grade Calculation for Cabuaquece Project Area**

MINE / PROJECT	PROJECT AREA	BLOCK	GRAVEL TYPE	CARATS	REC. GRADE (ct/100m <sup>2</sup> )
Cassanguidi	Cabuaquece	N/A	Lezeria	1,032,985	29.18
		Less mined out areas	Lezeria	426,618	75.77
	<b>TOTAL/AVE CABUAQUECE</b>			<b>606,366</b>	<b>23.62</b>

The current average grades reported relate to the modelled mean and not to the straight average grade, as used in previous statements.

### 24.5.5 Diamond Value

Due to the fact that no diamonds were available for sale or valuation from Cabuaquece, the weighted average diamond value for Cassanguidi South was utilised in the resource statement.

### 24.5.6 Current Resource Statement

The Diamond Resource statement for the Cabuaquece Project Area, dated 1<sup>st</sup> March 2008, was prepared by Mr Manuel Novo. This was independently verified by Mrs Catherine Telfer of Venmyn. The statement is shown in Table 89.

All resources were classified as Inferred due to the paucity of recent exploration activities which resulted in a low confidence associated with the grade, volumes and diamond values. The logic used in the classification is tabulated in Appendix 5. The location of the Diamond Resources, in relation to the project area, is illustrated in Figure 72.

There is no known item relating to the environment, permits, legal, title, taxation, socio-economic, marketing, and political or any other issue that would have a material effect on the resources identified in the current Diamond Resource statement.

**LEGEND:**

- River
- Project Area
- Resource Area
- Mined Out Area

**LOCATION OF DIAMOND RESOURCES FOR THE CABUAQUECE PROJECT AREA**

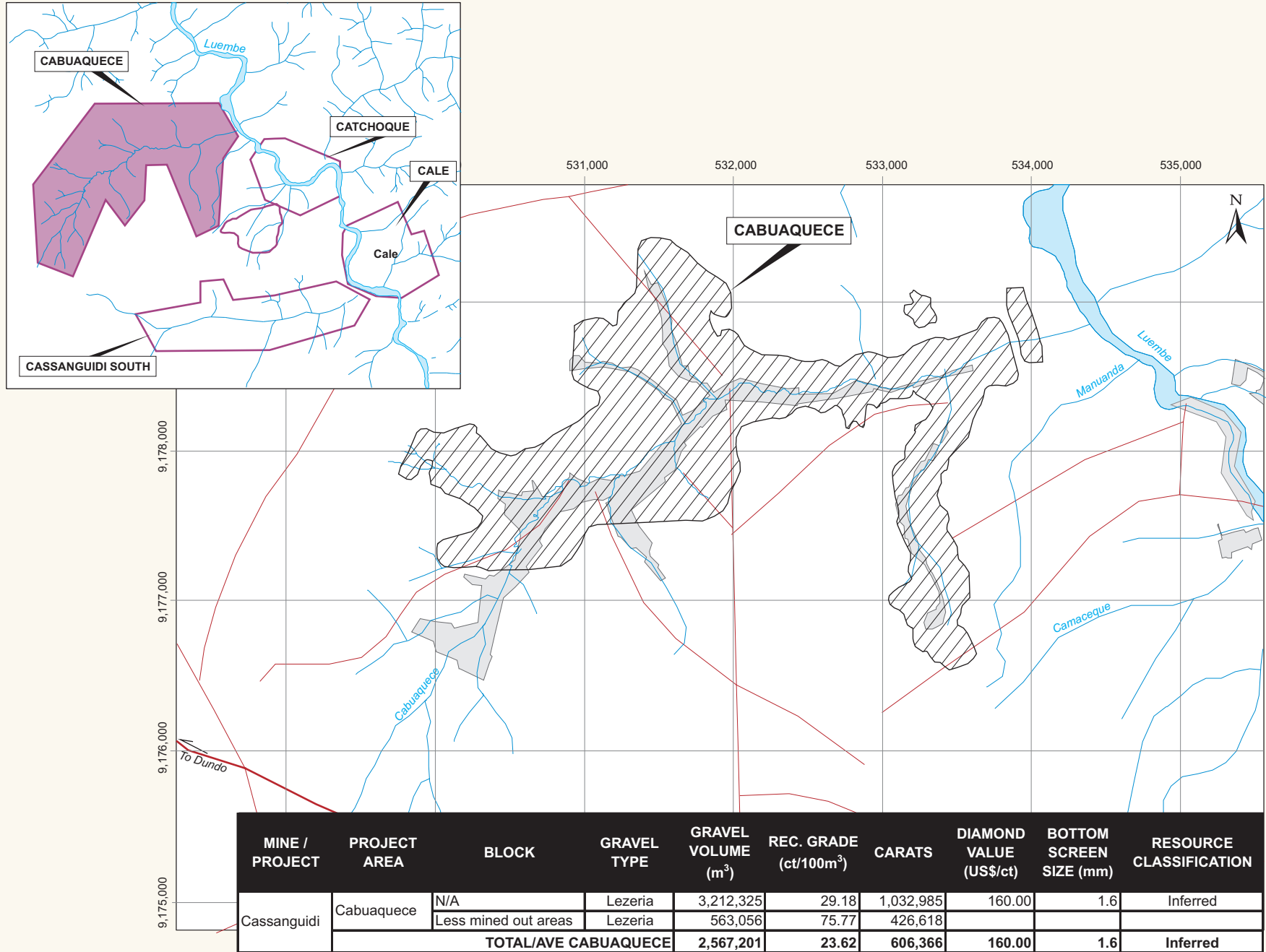

PangeaDFieldsTSX'07Fig72.cdr

Source: Pangea

SCALE:



This diagram and the information therein are copyrighted. It may not be reproduced or transmitted in any form or by any means without prior written permission from Venmyn Rand (Pty) Ltd. Trading as Venmyn.

## 24.6 Other Relevant Data and Information

The reader is referred to Section 12.11 for the results of a Preliminary Assessment of the current Project Area in conjunction with the other Project Areas associated with Cassanguid.

## 24.7 Interpretation and Conclusions

The historical information relating to Cabuaquece has enabled three dimensional modelling to be carried out on the gravel and overburden thicknesses as well as the grade.

Modelling has indicated little variations in the gravel thickness about the mean, except for a small area in the north which shows a gravel thickness spike. The grades show an increasing trend towards the river, where the majority of the historical mining has occurred. This results in the resource grades being less than the average grade of the deposit prior to mining. The overburden increases rapidly away from the rivers as would be expected by the topography of the area. This parameter forms the limiting factor for any mining activities. The cutoff stripping ratio applied at Cassanguidi South  $7\text{m}^3:1\text{m}^3$ .

Although the grade and volumes of the resources have only been based upon historical data, experience in Angola by the qualified person as well as other operators in the area has shown that the Endiama results are a reliable indication of the gravel deposits.

The recent diamond sales results from Cassanguidi South have been utilised in the Cabuaquece statement of Inferred Diamond Resources.

The Diamang exploration results and the methods were verified where possible by PGS. We are of the opinion that the results are reliable, where stated, and that the data density, quantity and quality are sufficient for the delineation of Inferred Diamond Resources.

## 24.8 Recommendations

As noted in Section 23.9 and Section 23.10, the focus on the recommended exploration for the Cassanguidi South Project Area must be on increasing the confidence in the Inferred Resources in order to increase the Indicated Resources that can be declared. A similar focus must be adopted for all the other Project Areas surrounding Cassanguidi South with the aim of preparing a LOM plan. The planned exploration programme and associated budget is detailed in Table 99. The expected revenues to be derived from the sale of diamonds extracted during exploration pitting, bulk sampling and pilot mining are shown in Table 100.

## 25 CASSANGUIDI PROJECT – CATCHOQUE PROJECT AREA

The Catchoque Project Area is situated to the east of Cabuaquece and lies on both the eastern and western banks of the north flowing Luembe River.

### 25.1 Exploration

Detailed historical exploration was carried out by Diamang in the Catchoque Project Area, as described in Section 22.3.1. Recent work conducted within the Project Area has included data processing and modelling of the historical data. In 2006, a drilling programme commenced on the gravels associated with the CatchoqueRiver, a tributary of the Luembe River from the west.

### 25.2 Data Modelling

#### 25.2.1 Method and Approach

In May 2004, PGS computerised all the information pertaining to the Catchoque Project Area and geo-referenced the pits as described in Section 24.2.1. The average sample spacing was also 50m by 50m (Figure 52).

Again PDF utilised the digital data and modelled the gravels in Surfer® using the inverse distance squared method of estimation and a search radius of 200m. The outer limit of the modelled area was based upon the limit of the gravel. The variations in the overburden and gravel thicknesses as well as the grade were modelled.

### 25.2.2 Data Verification

As stated in Section 24.2.2, the positioning of the pit data in relation to the current river systems was problematic and the exact positions may have an associated displacement error. However, the positions of the pits in relation to each other are correct and as a result the gravel volume calculations will be reliable.

### 25.2.3 Results

The descriptive statistics for the Cachoque mining area, based upon PDF's results, are shown in Table 97. The results are shown as contour plots in Figure 73 and Figure 74.

**Table 97 : Descriptive Statistics for the Cachoque Project Area**

PROJECT AREA	BLOCK NO.	NO. PITS	GRAVEL THICKNESS (m)			OVERBURDEN THICKNESS (m)			GRADE (ct/100m <sup>3</sup> )		
			MIN	MAX	MEAN	MIN	MAX	MEAN	MIN	MAX	MEAN
Cachoque	CQ01	86	0.10	1.98	0.61	0.01	6.18	2.76	No grade figures		
	CQ02	298	2.45	2.64	0.63	0.21	3.69	1.67	0.00	252.57	20.10
	CQ03	37	0.06	1.59	0.63	0.27	3.46	1.54	0.01	178.14	10.44
	<b>TOTAL/AVE</b>	<b>421</b>									

The gravel plot shows a general thinning of this layer near to the current river channel and the historically mined out areas. Gravels thicken to the south, reaching a maximum of 2.64m.

The overburden shows a general thickening to the east as a result of topographic influences. Thin overburden is present to the southwest of blocks CQ02 and CQ03.

The grade varies from 0cts/100m<sup>3</sup> to a maximum of 296ct/100m<sup>3</sup>. The contour plot indicates that the majority of the project area has a grade of around 20ct/100m<sup>3</sup>. Isolated areas of high grade ore are scattered across the project area. Very little historical mining has occurred in these high grade areas.

## 25.3 Auger Drilling

The purpose of the auger drilling was to define the vertical and lateral extent of the gravel within the project area. These results have been used to model the gravel and overburden thicknesses in Surfer®.

### 25.3.1 Sampling Method and Approach

Auger drilling was carried out within the CQ01 block of the Cachoque Project Area situated to the west of the historical exploration pits (Figure 52). The delineated gravel area was named according to a block number. This followed on from the mining block naming scheme and included a two letter prefix (indicating the project area) followed by a sequential numbering of the block.

The augering was undertaken on a 50m by 50m grid using a tractor mounted auger. The drilling rate was dependent on the depth and time required to extract the sample. With a skilled team of operators drilling was typically carried out at a rate of 10m/hr. Each rod has a length of 2m and a diameter of 150mm. The maximum drill depth was 20m.

All holes were drilled until bedrock was intersected. Information on the overburden thickness, gravel thickness and characteristics and bedrock type and depth were recorded for each hole.

A total of 94 holes were drilled into CQ01. The drilling programme is still ongoing.

### 25.3.2 Sample Preparation, Analyses and Security

No samples were sent for processing or grade determination.



### 25.3.3 Data Verification

All data is recorded into Excel sheets by the field geologist and verified by the mine geologist on a regular basis. Data files were also sent through to the headoffice in Johannesburg for further verification and use in modelling.

### 25.3.4 Results

The drilling results were modelled using Surfer® and the gravel and overburden thicknesses plotted using contours as shown in Figure 73. Modelling was carried out using the inverse distance squared estimation method taking into account all data points. The results and summarised statistics are highlighted in Table 97.

The gravel thickness plot indicates that this layer is fairly constant throughout the block about the mean of 0.61m. The overburden thickness increases to a maximum of 6.18m in the northern/central portion of CQ01. The grade shows very little variation up to a grade of 50ct/100m<sup>3</sup>. Occasional high grade areas are scattered across the project area.

## 25.4 Adjacent Properties

The adjacent mine, Fucauma, is described in Section 23.5.

## 25.5 Mineral Processing and Metallurgical Testing

No mineral processing has been carried out the Catchoque Project Area.

## 25.6 Diamond Resource and Diamond Reserves Estimate

### 25.6.1 Previous Resource Statements

As noted in Section 23.7.1, a SAMREC compliant diamond resource statement was issued by PDF in 2006 for the Catchoque Project Area. The resources are tabulated in Table 85.

### 25.6.2 Volume

The volume of the resources was estimated using the pit database of gravel thickness. This parameter was re-modelled using Surfer® in January 2008, as described in Section 24.2.1. The resultant volumes were again decreased by the historically mined out areas to obtain the remaining gravel volume (Table 95).

**Table 98 : Volume Estimation for Catchoque Project Area**

MINE / PROJECT	PROJECT AREA	BLOCK	GRAVEL TYPE	GRAVEL VOLUME (m <sup>3</sup> )
Cassanguidi	Catchoque	CQ02	Lezeria	820,833
		CQ03	Lezeria	164,059
		Less mined out areas	Lezeria	209,562
<b>TOTAL/AVE CATCHOQUE</b>				<b>775,330</b>

The recent volume calculations resulted in a small difference in the volumes compared to that previously issued in 2006. This was due to a slight difference in the block outline.

Although a volume has been calculated for CQ01 from the Surfer® modelling, this cannot be included into the diamond resources as no grade has been measured for the block.

### 25.6.3 Density

No density measurements were required as all resources are quoted in volumes.

### 25.6.4 Grade

As described in Section 24.5.4 for Cabuaquece, the grade was also re-modelled in Surfer® in January 2008. The grade was again reduced to take into account the mined out area. The grades are summarised in Table 99.

**CONTOUR PLOT OF GRAVEL AND OVERBURDEN THICKNESSES FOR THE CATCHOQUE PROJECT AREA**

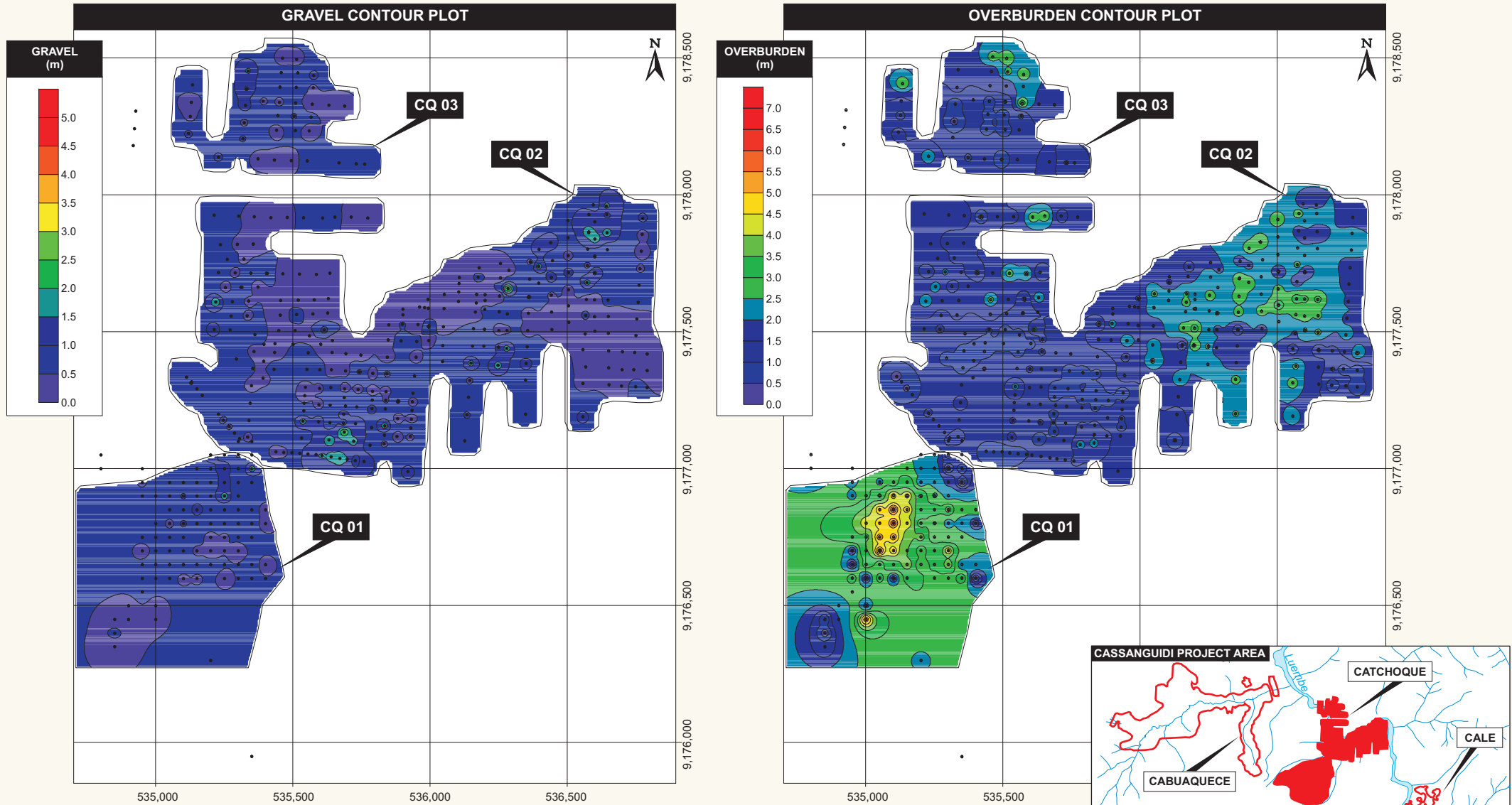

PangeaDFieldsTSX'07Fig73.cdr

Source: Venmyn

This diagram and the information herein is copyrighted. It may not be reproduced or transmitted in any form or by any means without prior written permission from Venmyn Rand (Pty) Ltd. Trading as Venmyn.



• Pit

**CONTOUR PLOT OF GRADE VARIATIONS FOR THE CATCHOQUE PROJECT AREA**

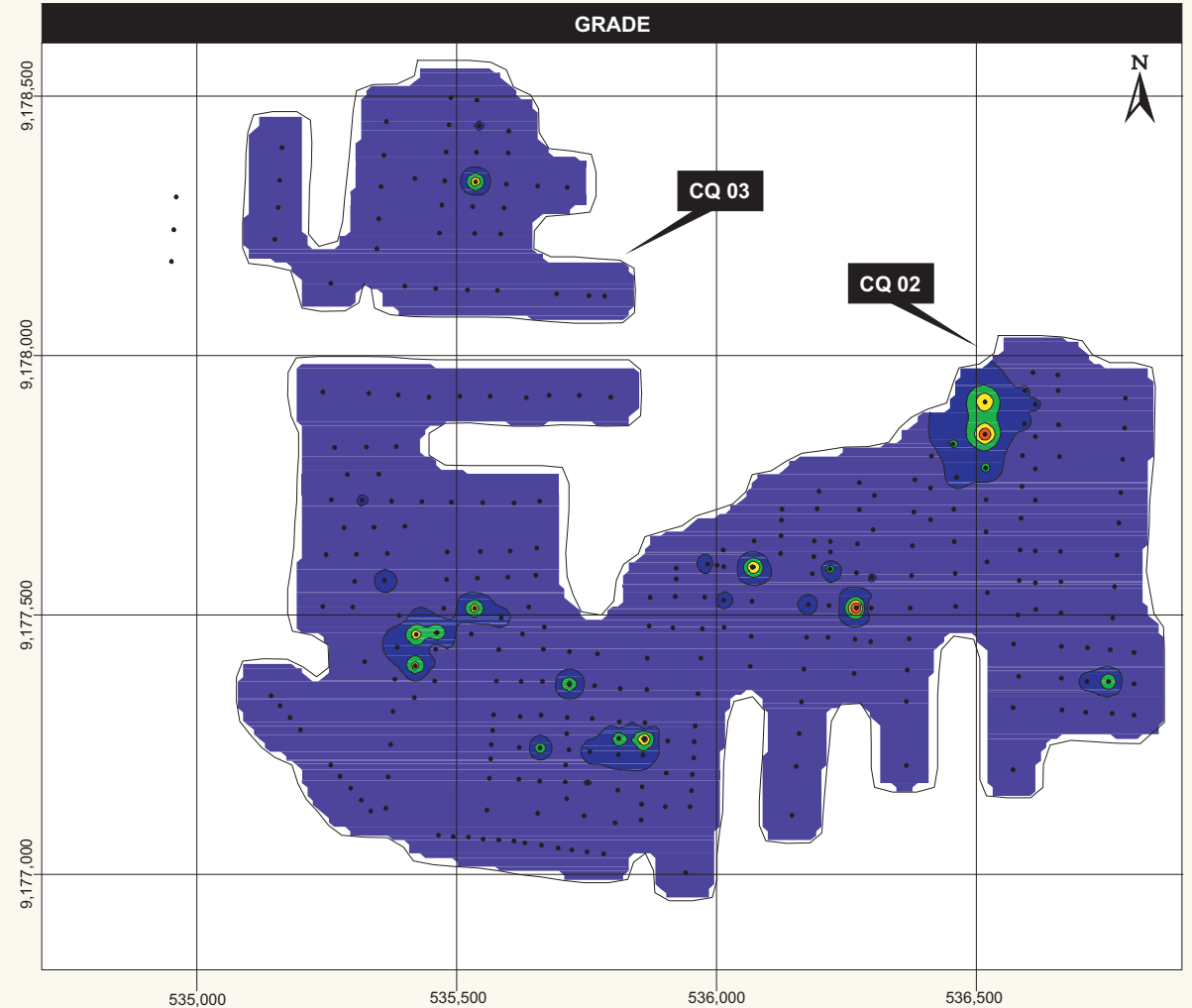
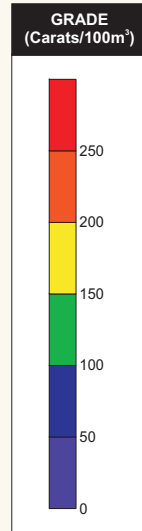
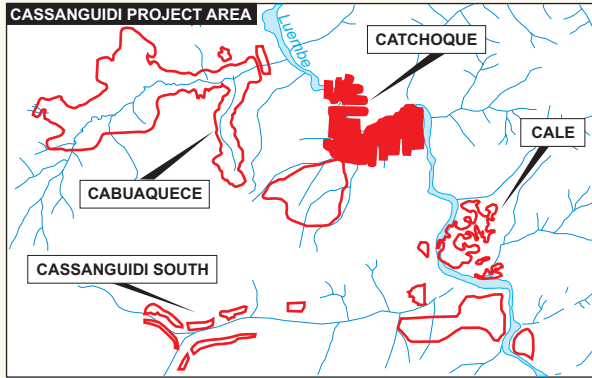

• Pit

PangeaDFieldsTSX'07Fig74.cdr

Source: Venmyn

This diagram and the information herein is copyrighted. It may not be reproduced or transmitted in any form or by any means without prior written permission from Venmyn Rand (Pty) Ltd. Trading as Venmyn.



**Table 99 : Grade Calculation for Catchoque Project Area**

MINE / PROJECT	PROJECT AREA	BLOCK	GRAVEL TYPE	CARATS	REC. GRADE (ct/100m <sup>3</sup> )
Cassanguidi	Catchoque	CQ02	Lezeria	164,987	20.10
		CQ03	Lezeria	17,128	10.44
		Less mined out areas	Lezeria	56,943	27.17
	<b>TOTAL/AVE CATCHOQUE</b>			<b>125,172</b>	<b>16.14</b>

Only blocks CQ02 and CQ03 were included into the resources as no indications of grade were available for CQ01. The current average grades reported relate to the modelled mean and not to the straight average grade, as used in previous statements.

#### 25.6.5 Diamond Value

As was the case for the Cabuaquece Project Area, Catchoque does not have extracted diamonds for sale (Section 24.5.5). As a result, the diamond values received for Cassanguidi South will be utilised in the diamond resources statement.

#### 25.6.6 Current Resource Statement

The Diamond Resource statement for the Cabuaquece Project Area, dated 1<sup>st</sup> March 2008, was prepared by Mr Manuel Novo. This was independently verified by Mrs Catherine Telfer of Venmyn. The statement is shown in Table 89 along with the other project areas.

All resources are classified as Inferred due to the paucity of recent exploration activities which resulted in a low confidence associated with the grade, volumes and diamond values. The logic used in the classification is tabulated in Appendix 5. The location of the Diamond Resources, in relation to the project area, is illustrated in Figure 75.

There is no known item relating to the environment, permits, legal, title, taxation, socio-economic, marketing, and political or any other issue that would have a material effect on the resources identified in the current Diamond Resource statement.

#### 25.7 Other Relevant Data and Information

The reader is referred to Section 12.11 for the results of a Preliminary Assessment of the current Project Area in conjunction with the other Project Areas associated with Cassanguidi.

#### 25.8 Interpretation and Conclusions

The historical information relating to Catchoque has enabled three dimensional modelling to be carried out on the gravel and overburden thicknesses as well as the grade.

Modelling has indicated little variations in the gravel thickness about the mean. The grades show isolated areas of high grade which; fortunately have not been previously mined out. The overburden increases rapidly away from the rivers as would be expected from the topography of the area. This parameter forms the limiting factor for any mining activities and as a result also forms the cutoff on the resources.

As mentioned in Section 25.6, although the grade and volumes of the resources have only been based upon historical data, experience in Angola by the qualified person as well as other operators in the area has shown that the Endiama results are a reliable indication of the gravel deposits.

The recent diamond sales results from Cassanguidi South have been utilised in the Cabuaquece statement of Inferred Diamond Resources.

The Diamang exploration results and the methods were verified where possible by PGS. We are of the opinion that the results are reliable, where stated, and that the data density, quantity and quality are sufficient for the delineation of Inferred Diamond Resources.

Recent exploration to the west has identified additional gravel deposits which have the potential for being included into the diamond resources once the grade has been tested. Through this PDF is in the process of accomplishing the aim of their exploration programme.

**LOCATION OF DIAMOND RESOURCES FOR THE CATCHOQUE PROJECT AREA**

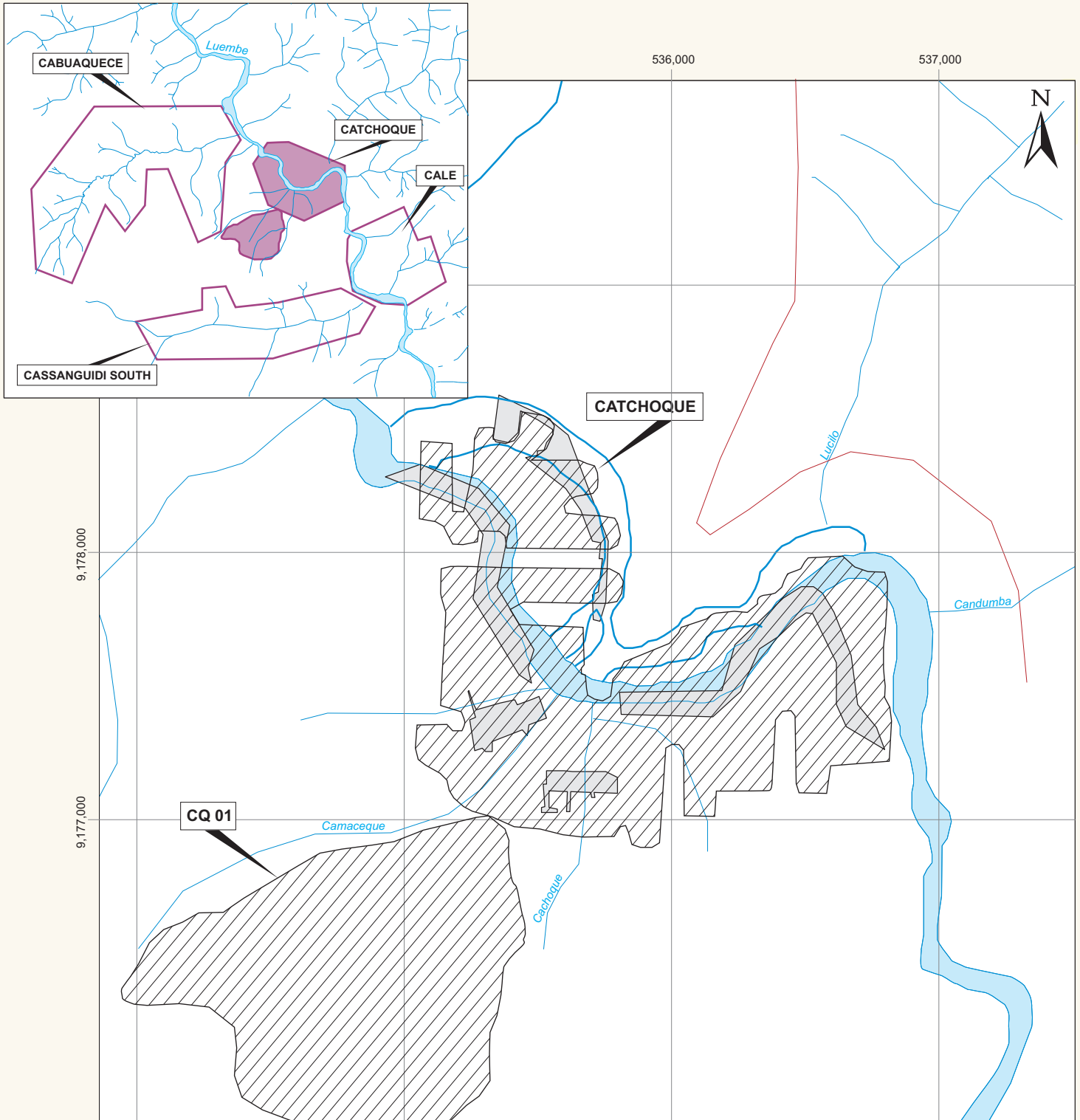

MINE / PROJECT	PROJECT AREA	BLOCK	GRAVEL TYPE	GRAVEL VOLUME (m <sup>3</sup> )	REC. GRADE (ct/100m <sup>3</sup> )	CARATS	DIAMOND VALUE (US\$/ct)	BOTTOM SCREEN SIZE (mm)	RESOURCE CLASSIFICATION
Cassanguidi	Catchoque	CQ02	Lezeria	820,833	20.10	164,987	160.00	1.6	Inferred
		CQ03	Lezeria	164,059	10.44	17,128	160.00	1.6	Inferred
		Less mined out areas	Lezeria	209,562	27.17	56,943	160.00	1.6	Inferred
	<b>TOTAL/AVE CACHOQUE</b>				<b>775,330</b>	<b>16.14</b>	<b>125,172</b>	<b>160.00</b>	<b>1.6</b>

Source: Pangea

**LEGEND:**

- River
- Project Area
- Resource Area
- Mined Out Area

SCALE:

0 500 m



This diagram and the information therein are copyrighted. It may not be reproduced or transmitted in any form or by any means without prior written permission from Venmyn Rand (Pty) Ltd. Trading as Venmyn.

## 25.9 Recommendations

As noted in Section 23.9 and Section 23.10, the focus on the recommended exploration for the Cassanguidi South Project Area must be on increasing the confidence in the Inferred Resources in order to increase the Indicated Resources that can be declared. A similar focus must be adopted for all the other Project Areas surrounding Cassanguidi South with the aim of preparing a LOM plan.

The exploration programme and budget for the Angola Project, including the Cassanguidi Project and supplied in Table 99. The expected revenues to be derived from the sale of diamonds extracted during exploration pitting, bulk sampling and pilot mining are shown in Table 100.

## 26 CASSANGUIDI PROJECT – CALE PROJECT AREA

The Cale Project Area is situated to the south of Catchoque and to the northeast of the Cassanguidi South Project Areas. It lies on the eastern side of the Luembe River.

### 26.1 Exploration

Detailed historical exploration was carried out by Diamang in the Cale Project Area, as described in Section 22.3.1. Recent work conducted within the Project Area has included data processing and modelling of the historical data. No recent exploration or sampling has been carried out.

### 26.2 Data Modelling

#### 26.2.1 Method and Approach

In May 2004, PGS computerised all the information pertaining to the Cale Project Area and geo-referenced the pits as described in Section 24.2.1. The average sample spacing was also 50m by 50m (Figure 53).

This original work was re-assessed in detail by PGS in October 2004. The positions of the previously digitised pits were updated using the latest Landsat satellite images. A total of 466 sample points was used.

PGS evaluated the resources using two scenarios. The first scenario, termed the constrained model, included the areas which pits had yielded diamonds. This model utilised 241 pits of which 11% had zero grade measurement.

The second scenario, termed the unconstrained model, utilised all pits with gravel, but not necessarily diamonds. A total of 355 pits was used in this model, and of these 46% registered a zero grade value.

The two models were analysed geostatistically. This analysis included descriptive statistics, histograms, probability plots and trend analysis. Variography was also undertaken to understand the spatial continuity trends as well as the nugget effect. Thereafter, the gravel and overburden thicknesses and the gravel grades were modelled in Datamine software using both Kriging and the inverse distance squared methods of estimation.

The optimal results were obtained using the constrained model. A trend analysis of the grades within the Cale project area indicated a distinct increase in grades towards the Luembe River.

Optimal block modelling results were obtained in Datamine using the following parameters:-

- Kriging method of estimation for diamond grades;
- inverse distance squared method of estimation for gravel and overburden thicknesses;
- search distance used the variogram ranges with a maximum of 200m;
- a minimum of two samples per block;
- maximum of 20 samples per block; and
- block size of 25m by 25m.

PDF have checked the PGS calculations using the Diamang data and the PGS resource outline. PDF also utilised the digital data and modelled the gravels in Surfer® using the inverse distance squared method of estimation and a search radius of 200m. The outer limit of the modelled area was based upon PGS' criteria. The variations in the overburden and gravel thicknesses as well as the grade were modelled.

### 26.2.2 Data Verification

As stated in Section 24.2.2, the positioning of the pit data in relation to the current river systems was problematic and the exact positions may have an associated displacement error. However, the positions of the pits in relation to each other were correct and as a result the gravel volume calculations will be reliable.

As noted above, PDF has verified all the previous calculations undertaken by PGS.

### 26.2.3 Results

The descriptive statistics for the Cale mining area, based upon PDF's results, are shown in Table 100. The results are shown as contour plots in Figure 76 and Figure 77.

**Table 100 : Descriptive Statistics for the Cale Project Area**

PROJECT AREA	BLOCK NO.	NO. PITS	GRAVEL THICKNESS (m)			OVERBURDEN THICKNESS (m)			GRADE (ct/100m <sup>3</sup> )		
			MIN	MAX	MEAN	MIN	MAX	MEAN	MIN	MAX	MEAN
Cale	CL01	209	0.15	3.35	1.05	0.05	6.94	3.06	0.00	942.43	26.79
	CL02	2	0.19	0.70	0.52	2.30	2.92	2.55	9.29	23.28	15.47
	CL03	19	0.16	1.74	0.75	1.36	2.92	2.29	1.23	176.89	37.46
	<b>TOTAL/AVE</b>	<b>230</b>									

The plot of gravel thickness indicates that the majority of the area is covered by gravel of between 0.5m and 1.5m in thickness. The overburden shows the influence of the topography with a rapid increase in its thickness away from the river to the northeast.

The grade plot shows little variation with only occasional small areas of high grade gravels. The grade varies from 0cts/100m<sup>3</sup> to a maximum of 942ct/100m<sup>3</sup>. The contour plot indicates that the majority of the project area has a grade of around 26ct/100m<sup>3</sup>. There is no obvious evidence of historical mining within the Cale Project Area.

## 26.3 Adjacent Properties

Information on an adjacent operation was provided in Section 23.5.

## 26.4 Mineral Processing and Metallurgical Testing

No mineral processing has occurred within the Cale Project Area.

## 26.5 Diamond Resource and Diamond Reserves Estimate

### 26.5.1 Previous Resource Statements

As noted in Section 23.7.1, a SAMREC compliant diamond resource statement was issued by PDF in 2006 for the Cale Project Area. The resources are tabulated in Table 85. This resource statement has remained unchanged except modifications in the average diamond value.

### 26.5.2 Volume

The volume of the resources was re-estimated using the pit database of gravel thickness in January 2008. This parameter was modelled using Surfer®, as described in Section 24.2.1. The resultant volumes are tabulated in Table 101. No reduction in volume was carried out as there is no evidence of historical mining. The resource areas have been limited based upon the PGS work and as a result have formed three separate block. These were sequentially named by PDF from north to south using a prefix to indicate the Cale Project Area eg. CA01.

**CONTOUR PLOT OF GRAVEL AND OVERBURDEN THICKNESSES FOR THE CALE PROJECT AREA**

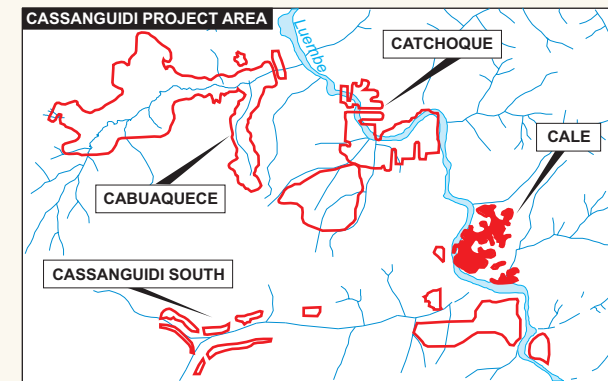
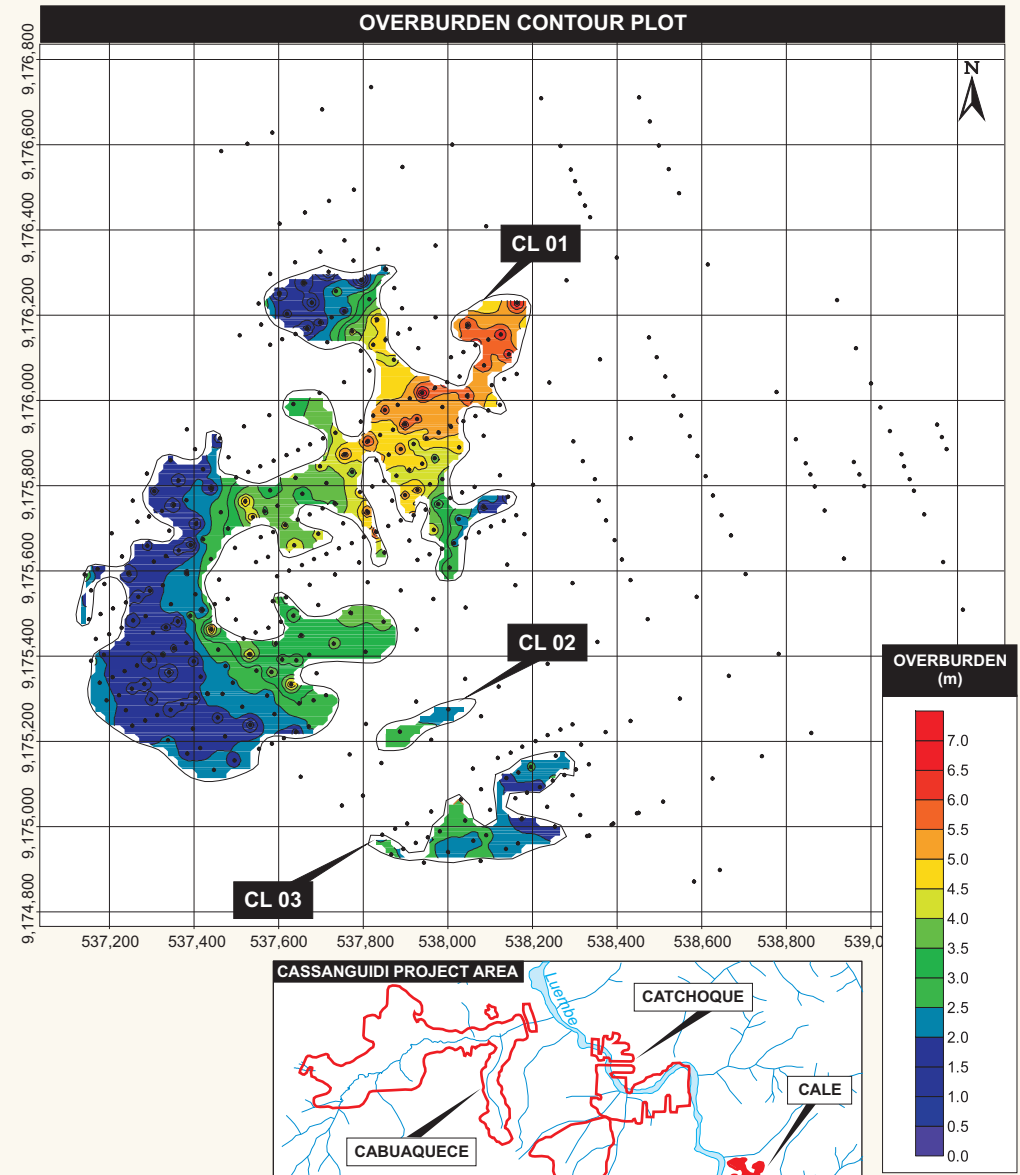
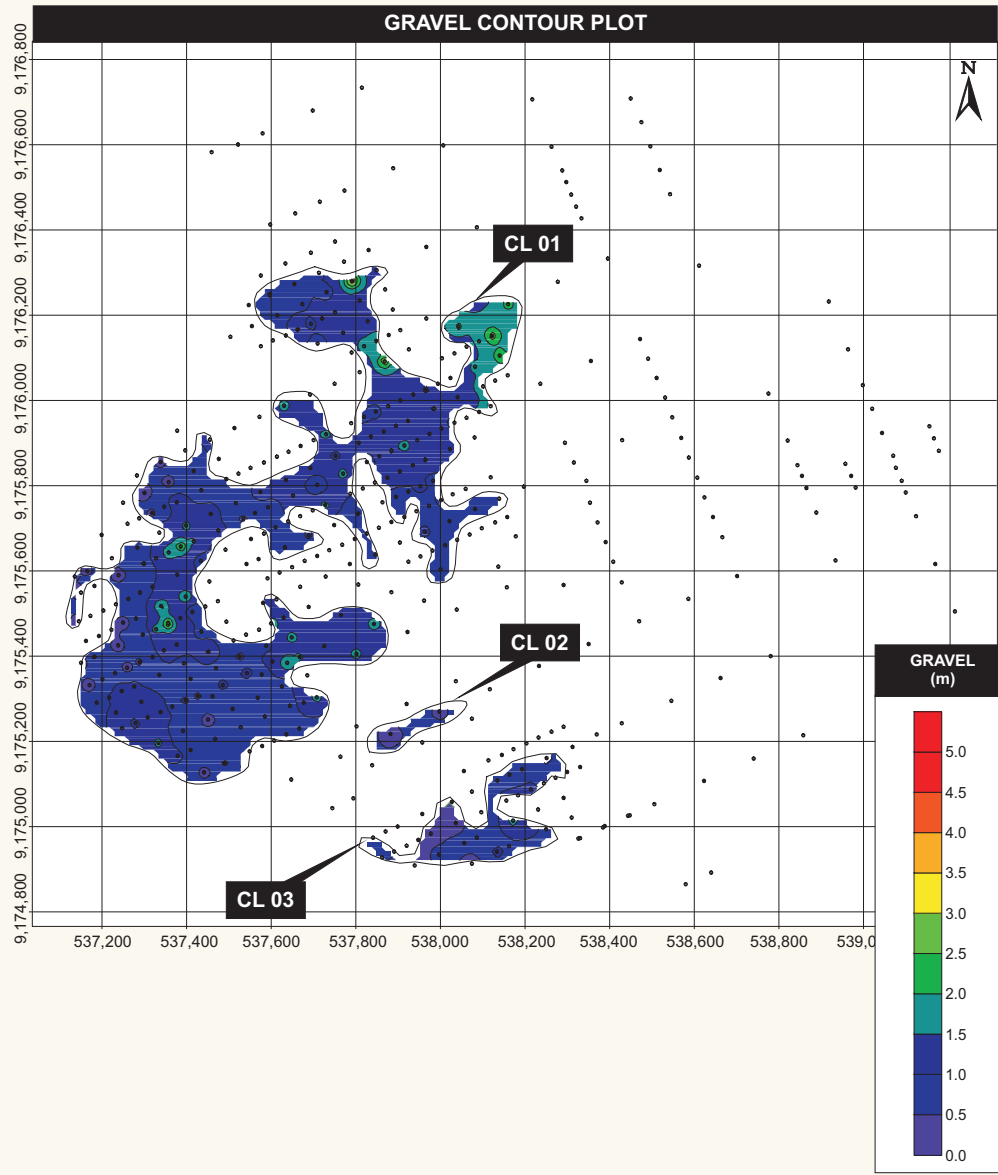

PangeaDFieldsTSX'07Fig76.cdr

Source: Venmyn

This diagram and the information herein is copyrighted. It may not be reproduced or transmitted in any form or by any means without prior written permission from Venmyn Rand (Pty) Ltd. Trading as Venmyn.



• Pit



**CONTOUR PLOT OF GRADE VARIATIONS FOR THE CALE PROJECT AREA**

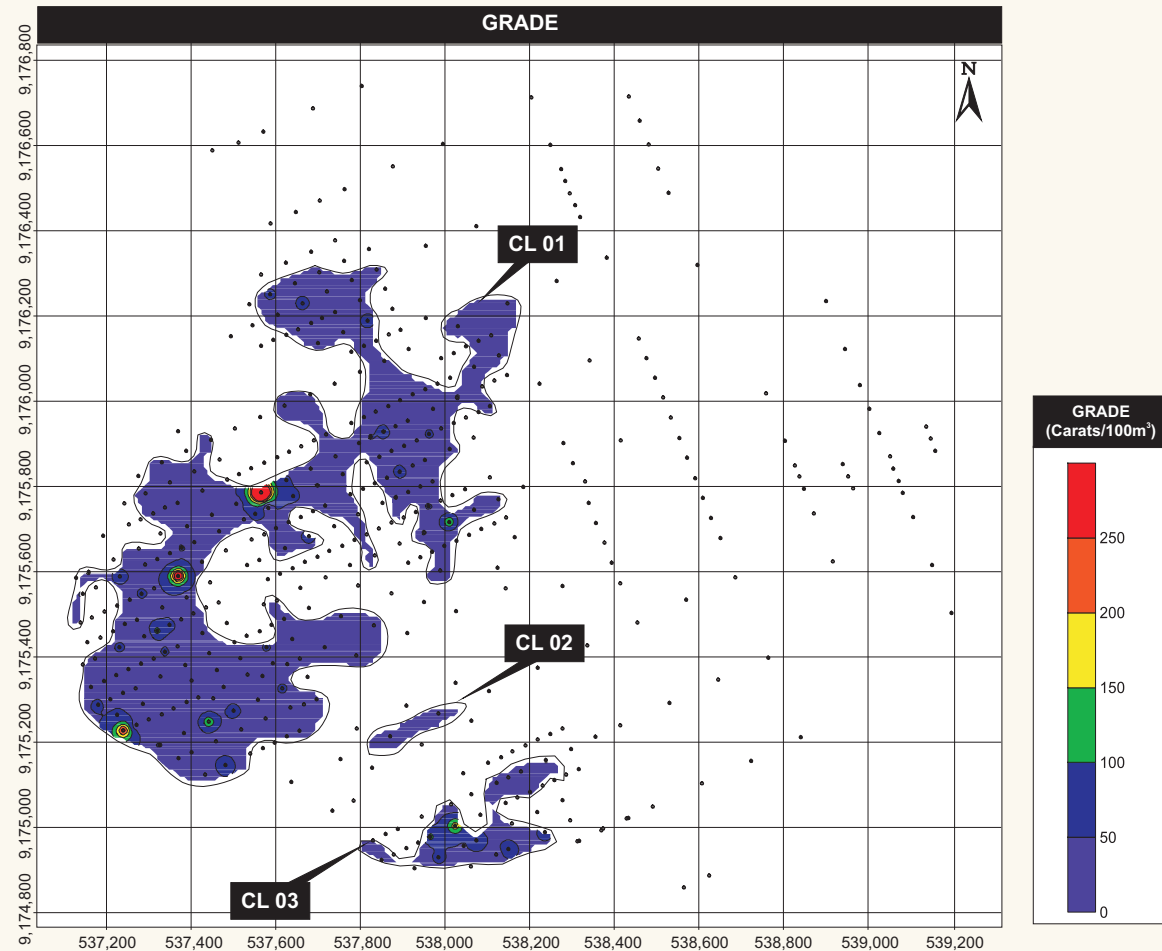
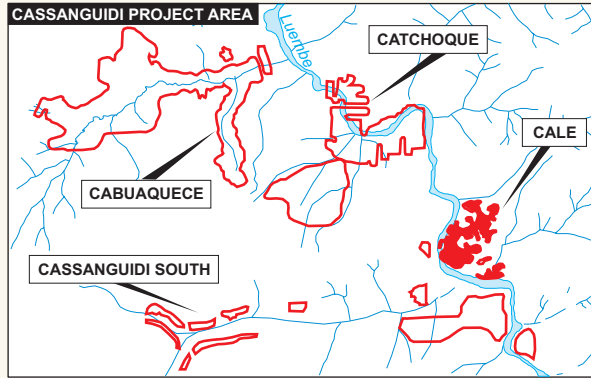

PangeaDFieldsTSX'07Fig77.cdr

Source: Venmyn

This diagram and the information herein is copyrighted. It may not be reproduced or transmitted in any form or by any means without prior written permission from Venmyn Rand (Pty) Ltd. Trading as Venmyn.



• Pit

**Table 101 : Volume Estimation for Cale Project Area**

MINE / PROJECT	PROJECT AREA	BLOCK	GRAVEL TYPE	GRAVEL VOLUME (m <sup>3</sup> )
Cassanguidi	Cale	CL01	Lezeria	519,705
		CL02	Lezeria	6,045
		CL03	Lezeria	49,008
			<b>TOTAL/AVE CALE</b>	<b>574,758</b>

The recent volume calculations resulted in a small difference in the volumes compared to that previously issued in 2006. This was due to a slight difference in the block outline.

### 26.5.3 Density

No density measurements are required as all resources are quoted in volumes.

### 26.5.4 Grade

As described in Section 24.5.4 for Cabuaquece, the grade was also re-modelled in Surfer® in January 2008. The grades are summarised in Table 102. No modification in grade was carried out as there is no evidence of historical mining.

**Table 102 : Grade Calculation for Cale Project Area**

MINE / PROJECT	PROJECT AREA	BLOCK	GRAVEL TYPE	CARATS	REC. GRADE (ct/100m <sup>3</sup> )
Cassanguidi	Cale	CL01	Lezeria	139,229	26.79
		CL02	Lezeria	935	15.47
		CL03	Lezeria	18,358	37.46
			<b>TOTAL/AVE CALE</b>	<b>158,523</b>	<b>36.42</b>

The current average grades reported relate to the modelled mean and not to the straight average grade, as used in previous statements.

### 26.5.5 Diamond Value

As was the case for the Cabuaquece Project Area, Catchoque also does not have extracted diamonds for sale (Section 24.5.5). As a result, the diamond values received for Cassanguidi South will be utilised in the diamond resources statement.

### 26.5.6 Current Resource Statement

The Diamond Resource statement for the Cale Project Area, dated 1<sup>st</sup> March 2008, was prepared by Mr Manuel Novo. This was independently verified by Mrs Catherine Telfer of Venmyn. The statement is shown in Table 89 along with the other project areas.

All resources are classified as Inferred due to the paucity of recent exploration activities which resulted in a low confidence associated with the grade, volumes and diamond values. The logic used in the classification is tabulated in Appendix 5. The location of the Diamond Resources, in relation to the project area, is illustrated in Figure 78.

There is no known item relating to the environment, permits, legal, title, taxation, socio-economic, marketing, and political or any other issue that would have a material effect on the resources identified in the current Diamond Resource statement.

## 26.6 Other Relevant Data and Information

The reader is referred to Section 12.11 for the results of a Preliminary Assessment of the current Project Area in conjunction with the other Project Areas associated with Cassanguidi.

## 26.7 Interpretation and Conclusions

The historical information relating to Cale has enabled three dimensional modelling to be carried out on the gravel and overburden thicknesses as well as the grade. Modelling has indicated that the Cale Project Area gravels vary little across the area. Occasional high grade areas are present, but these are isolated. Overburden increases to the northeast as a result of the topographic influences.

**LOCATION OF DIAMOND RESOURCES FOR THE CALE PROJECT AREA**

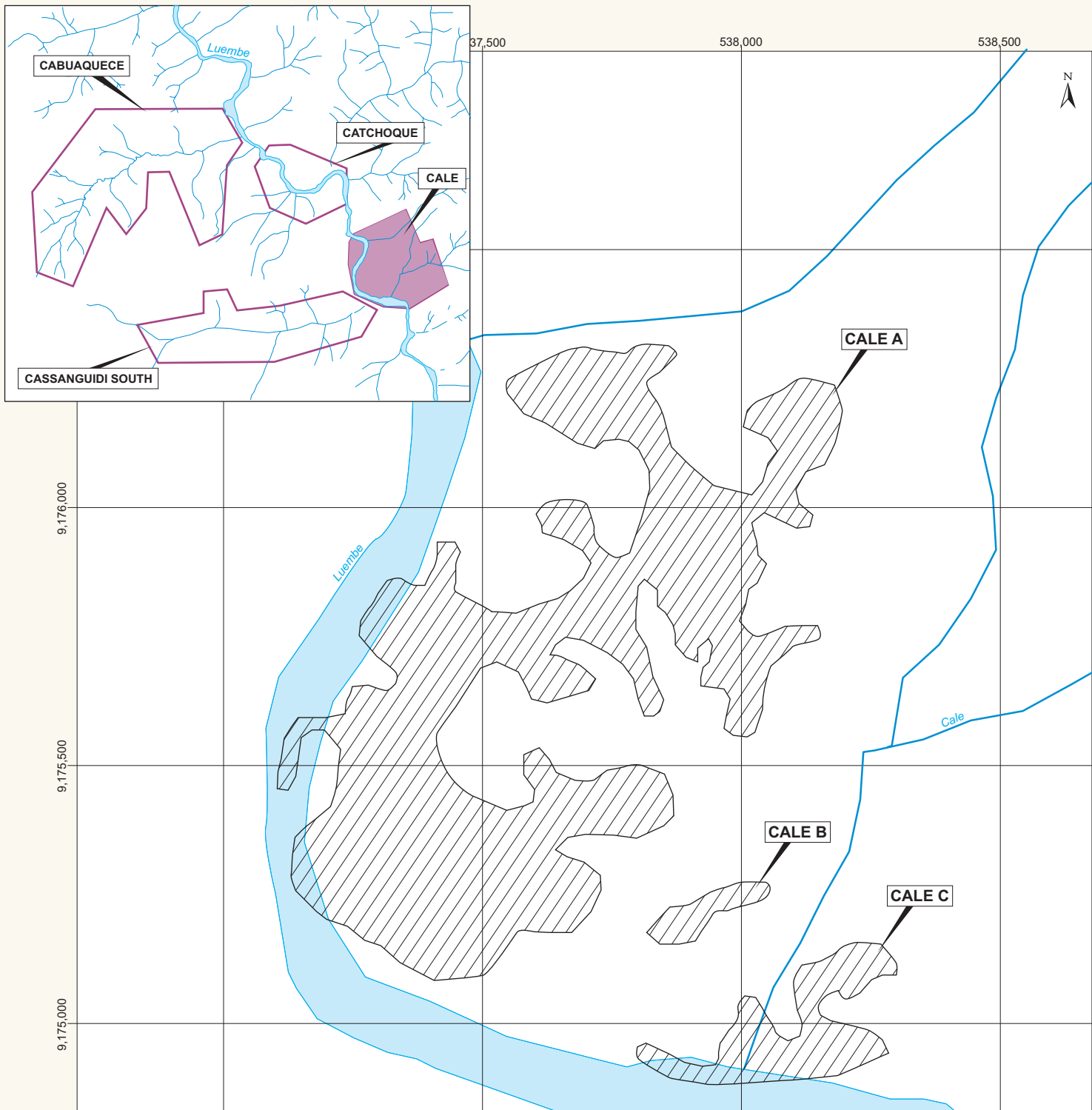

MINE / PROJECT	PROJECT AREA	BLOCK	GRAVEL TYPE	GRAVEL VOLUME (m <sup>3</sup> )	REC. GRADE (ct/100m <sup>3</sup> )	CARATS	DIAMOND VALUE (US\$/ct)	BOTTOM SCREEN SIZE (mm)	RESOURCE CLASSIFICATION
Cassanguidi	Cale	CL01	Lezeria	519,705	26.79	139,229	160.00	1.6	Inferred
		CL02	Lezeria	6,045	15.47	935	160.00	1.6	Inferred
		CL03	Lezeria	49,008	37.46	18,358	160.00	1.6	Inferred
			<b>TOTAL/AVE CALE</b>		<b>574,758</b>	<b>36.42</b>	<b>158,523</b>	<b>160.00</b>	<b>1.6</b>

Source: Pangea

**LEGEND:**

- River
- Project Area
- Resource Area

SCALE:



This diagram and the information therein are copyrighted. It may not be reproduced or transmitted in any form or by any means without prior written permission from Venmyn Rand (Pty) Ltd. Trading as Venmyn.

As mentioned in Section 26.5, although the grade and volumes of the resources have only been based upon historical data, experience in Angola by the qualified person as well as other operators in the area has shown that the Endiama results are a reliable indication of the gravel deposits.

The recent diamond sales results from Cassanguidi South have been utilised in the Case statement of Inferred Diamond Resources.

The Diamang exploration results and the methods were verified where possible by PGS. PGS's work has also been verified by PDF, with the resultant resource calculations being of a similar magnitude. This provides comfort in the results obtained.

We are of the opinion that the results are reliable, where stated, and that the data density, quantity and quality are sufficient for the delineation of Inferred Diamond Resources.

## **26.8 Recommendations**

As noted in Section 23.9 and Section 23.10, the focus on the recommended exploration for the Cassanguidi South Project Area must be on increasing the confidence in the Inferred Resources in order to increase the Indicated Resources that can be declared. A similar focus must be adopted for all the other Project Areas surrounding Cassanguidi South with the aim of preparing a LOM plan.

The exploration programme and budget for the Angola Project, including the Cassanguidi Project in Table 99. The expected revenues to be derived from the sale of diamonds extracted during exploration pitting, bulk sampling and pilot mining are shown in Table 100.

## 27 SOUTH AFRICAN PROJECTS

The South African diamond projects comprise three alluvial projects located in the Northwest and Northern Cape Provinces. The three projects include Bakerville, Harts River and Bloemhof and are shown in relation to South African the infrastructure in Figure 79 and Figure 80. These projects are divided into a number of project areas according to their tenure as illustrated in Table 1.

## 28 BAKERVILLE PROJECT

The Bakerville Project, which includes the Patsema and Geluksdal Project Areas, is situated approximately 250km west of Johannesburg, in the Lichtenburg Magisterial District (Figure 81). Development of both project areas is at an advanced stage of exploration.

### 28.1 Property Description and Location

The Patsema and Geluksdal Project Areas are located approximately 20km north of Lichtenburg (Figure 81). The Patsema Project Area comprises portions of four farms namely, Zamenkomst 4IP, Houthaaldooms 2IP, Welverdiend 361JP and Witklip 6IP which covers a total of 11,626ha. The Geluksdal Project Area comprises the remaining portion of the Geluksdal 337 JP Farm and covers an area of 1,094ha. The license boundaries (Table 103) have been surveyed by a professional surveyor as required by the Department of Minerals and Energy (DME).

**Table 103 : Bakerville Project Areas and Boundary Coordinates**

PROJECT NAME	PROJECT AREA	LICENSE TYPE	AREA (km <sup>2</sup> )	AREA (ha)	BOUNDARY COORDINATES (WG27 System) (X;Y)
Bakerville	Patsema	PR	116	11,626	(+2881590.35;+87864.94); (+2884592.23;+93846.38); (+2880934.98;+94099.86); (+2878970.29;+94845.73); (+2878186.95;+93005.69); (+2876132.47;+88934.88); (+2875564.23;+87617.93); (+2873435.44;+84147.13); (+2880762.93;+81942.39); (+2883130.67;+87563.65); (+2881590.35;+87864.94); (+2872305.68;+82488.69); (+2872303.11;+82319.51); (+2872251.67;+82069.24); (+2872212.66;+81806.35); (+2872217.13;+81656.54); (+2873556.92;+81006.96); (+2874542.41;+80584.63); (+2875579.73;+80029.37); (+2876127.87;+79762.55); (+2876102.74;+80320.48); (+2875595.33;+80585.72); (+2875621.01;+81075.58); (+2875664.38;+82136.80); (+2874740.33;+82576.97); (+2874657.92;+82132.06); (+2874627.28;+81596.18); (+2874108.11;+81861.21); (+2873615.59;+82108.80); (+2877708.74;+82876.98); (+2877458.51;+77898.98); (+2883406.46;+74516.65); (+2883764.15;+74452.05); (+2885146.57;+78906.99); (+2880465.22;+80705.29); (+2880406.64;+80725.33); (+2880698.98;+81428.02); (+2880587.46;+81458.53); (+2880810.07;+81995.90)
	Geluksdal	PR	11	1,094	(+2862674.01;+87101.68); (+2862680.14;+85206.50); (+2865049.66;+86218.44); (+2864832.05;+86309.76); (+2865980.54;+87781.33); (+2866474.05;+88468.84); (+2865303.42;+88956.72); (+2864227.25;+89409.15); (+2863360.67;+88127.28)
	<b>TOTAL BAKERVILLE</b>			<b>127</b>	<b>12,720</b>

The surface rights owners for the Bakerville Project are listed in Table 104. PDF have contacted these owners and obtained permission to conduct exploration programmes on their farms. No royalties or payments are required to be made to the surface rights owners.

The mineralization is associated with diamond runs and potholes which have formed in the area as a result of physical and chemical erosional processes.

**LEGEND:**

- Kimberlite Cluster
- Alluvial Diamond Concentration
- Pangea Diamondfields Projects**
- Bakerville Area
- Harts River
- Harts River/Bloemhof Area
- River
- Inferred Major Palaeo-Drainage
- Town
- Provincial Boundary

**LOCATION OF SOUTH AFRICAN PROJECTS IN RELATION TO LOCAL DIAMOND DEPOSITS**

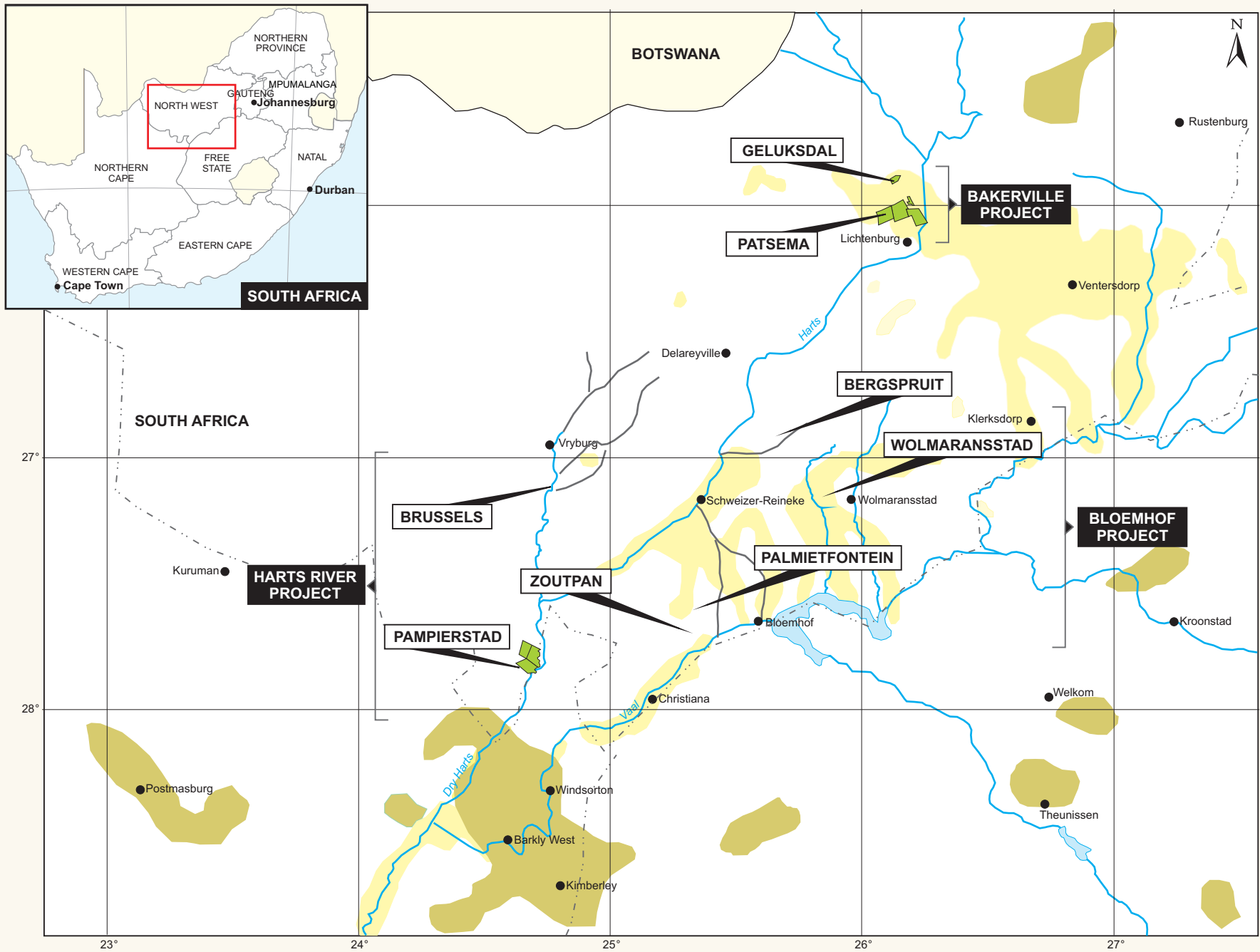

PangeaDFieldsTSX'07Fig79.cdr

Source: Pangea Exploration (Pty) Limited

**SCALE:**



This diagram and the information therein are copyrighted. It may not be reproduced or transmitted in any form or by any means without prior written permission from Venmyn Rand (Pty) Ltd. Trading as Venmyn.

FIGURE 79

**LEGEND:**

- ◆ Kimberlites
- ◆ Alluvial diamond deposits
- Towns
- Railway
- Main Road
- River
- PDF Project Areas

**INFRASTRUCTURE AND LOCALITY PLAN OF SOUTH AFRICA N PROJECTS**

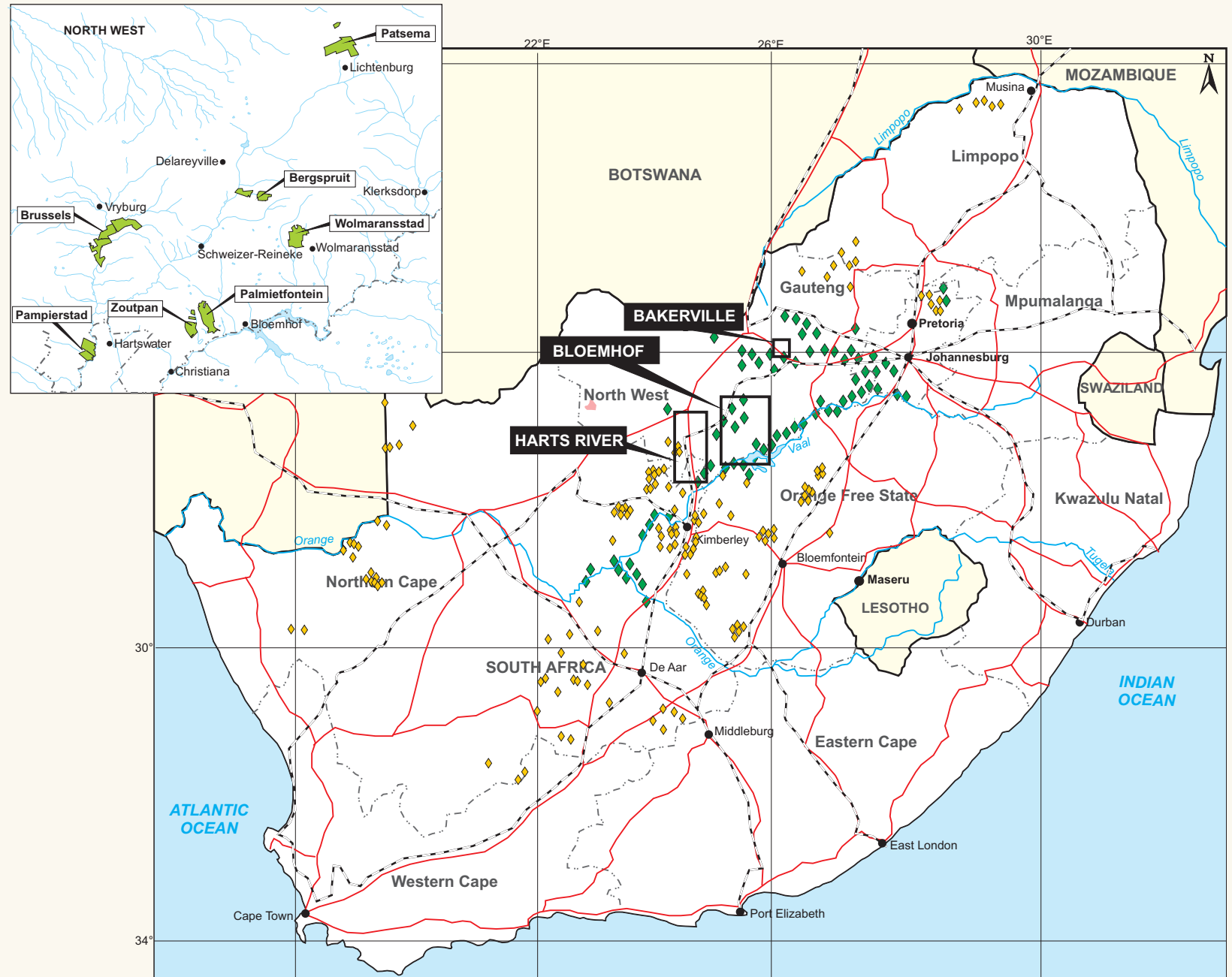

Source: MAGELLAN



This diagram and the information therein are copyrighted. It may not be reproduced or transmitted in any form or by any means without prior written permission from Venmyn Rand (Pty) Ltd. Trading as Venmyn.

**LOCALITY PLAN FOR BAKERVILLE PROJECT**

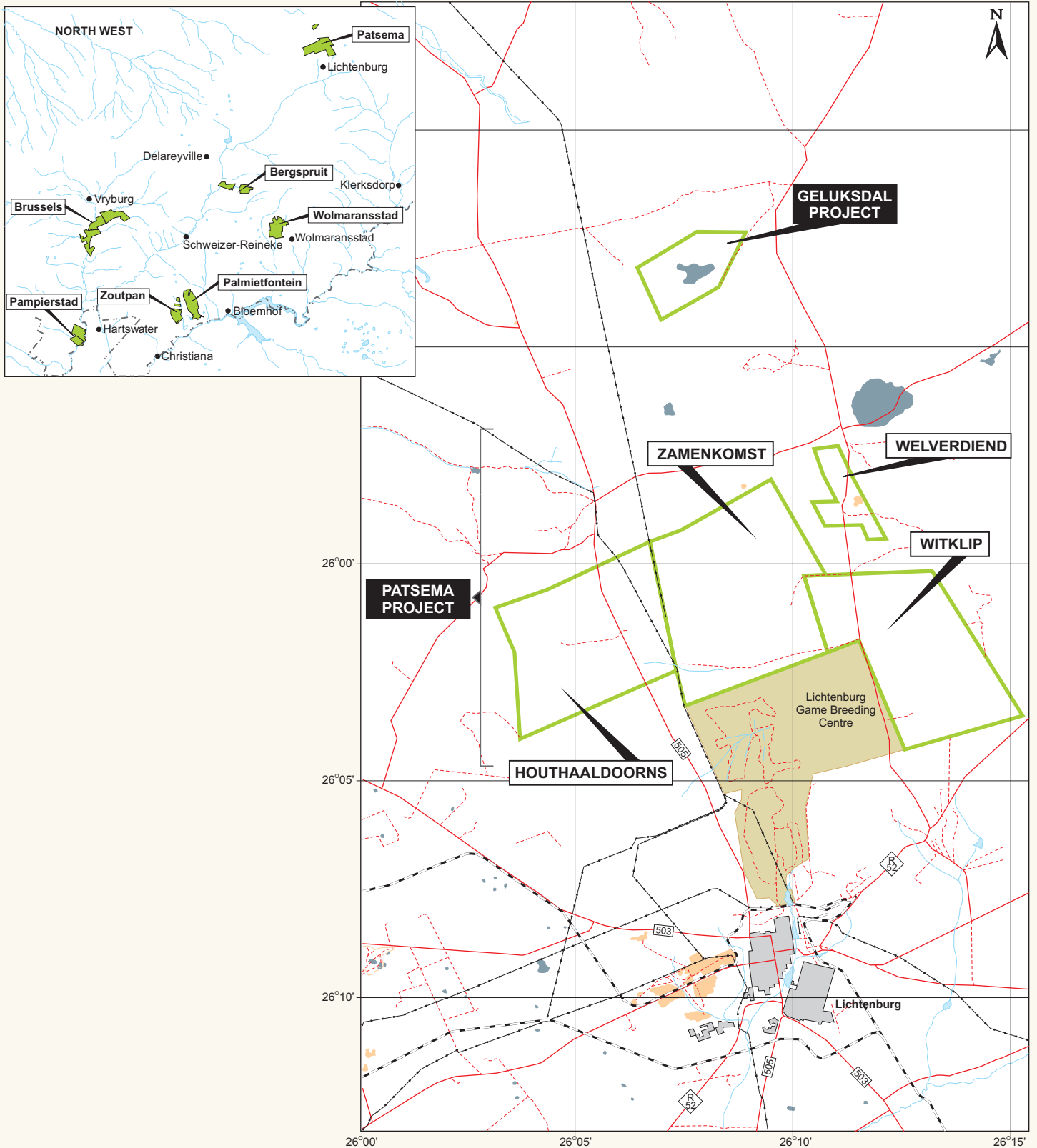

Source: 1:50 000 SA Map 2626 AA/CC

**LEGEND:**

- Main Road
- - - Secondary Road
- - - Rail
- - - Powerline
- Built-up Area
- River
- Patsema Area
- Mine Dump
- Dry Pan

**SCALE:**



This diagram and the information therein are copyrighted. It may not be reproduced or transmitted in any form or by any means without prior written permission from Venmyn Rand (Pty) Ltd. Trading as Venmyn.



**Table 104 : Surface Rights Owners for the Bakerville Project**

PROJECT AREA	FARM NO.	FARM NAME	PORTION	SURFACE OWNER	TITLE DEED NO.	
Patsema	2	Houthaaldoorns	(RE Ext)	Kuhn-Kuhn (Pty) Ltd	T44660/1989	
			1	Klipveld Trust	T1255/2000	
			3	Dirksdal Boerdery, also trading as Beyplas (Pty) Ltd	T57129/2000	
	4	Zamenkomst	(RE Ext)	JH Nel	T92914/2002	
			1	Geelong Inv (Pty) Ltd	T119314/2000	
			2 (RE Ext)	Schalk WJ Swanepoel	T20315/2006	
			3	Josef AJ van Dyk	T34499/1966	
			4	Plaas Neltie (Pty) Ltd	T24198/2002	
			5	Anton C van Dyk	T26114/1999	
	361	Welverdiend	1,8, 12,13, 33,34, 35,48	6/2	JE Bornman	T7258/1966
	6	Witklip	(RE Ext) & 3	HHW Schulenburg & Seun (Pty) Ltd	T30825/1985	
			1	Tony Teixeira Trust	T100313/1996	
2			MG Jesus de Melim	T125832/2004		
Geluksdal	337	Geluksdal	0	Carroll Broers Boerdery Bk	T76335/04	

### 28.1.1 Legal Aspects and Tenure

The ownership of the Bakerville Project is illustrated in Figure 82. Efidium owns 55% of the project through Innovage Resources (Pty) Ltd (Innovage) and Upward Spiral 10 (Pty) Ltd (Upward Spiral).

The Bakerville Project consists of four Prospecting Rights (PR) issued in the names of two subsidiary companies of PDF. All licences are issued for alluvial diamonds, except for Geluksdal 337JP, which was issued for kimberlite diamonds only. PDF have recently submitted an application to include alluvial diamonds in this right. No problems are foreseeable in obtaining this inclusion. The status of the PR applications is shown in Table 105.

**Table 105 : Legal Rights Pertaining to the Bakerville Project**

PROJECT AREA	FARM NAME	PTN NO.	PERMIT NO.	LICENSE HOLDER	AREA (ha)	EXPIRY DATE	EMP APPROVED	REHAB MONIES PAID (ZAR)
Patsema	Houthaaldoorns 2 IP	All	NW 30/5/1/1/2/90	Innovage	3,456	Mar 2011	Approved	12,000
	Zamenkomst 4 IP	All	PR		4,137			
	Welverdiend 361 JP	1,8, 12,1 3, 33,3 4, 35,4 8	NW 30/5/1/1/2/137 PR	Innovage	476	Dec 2011	Approved	7,100
	Witklip 6 IP	1,2, RE, 3	NW 30/5/1/1/2/199 PR	Innovage	3,557	Dec 2011		
Geluksdal	Geluksdal 337 JP	RE	NW 30/5/1/1/2/950 PR	Upward Spiral	1,094	Jan 2010	Approved	15,000
<b>TOTALS</b>					<b>12,720</b>			<b>45,100</b>

Tabacks Corporate Law Advisors (Tabacks) reviewed the legal status of the Bakerville Project licences and found the following:-

- the licences are valid, binding and enforceable;
- there are no impediments to prospecting and mining activities relating to the prospecting right;
- the holders of the prospecting rights are in compliance with their obligations under the prospecting rights; and
- PDF has paid all applicable prospecting fees.

**OWNERSHIP OF BAKERVILLE PROJECT**

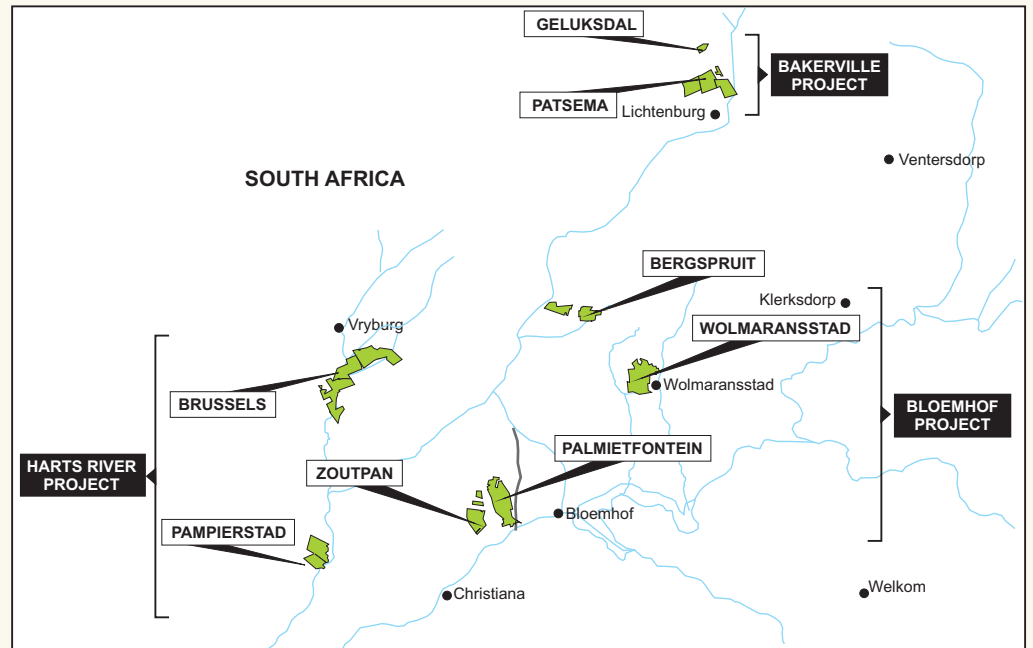
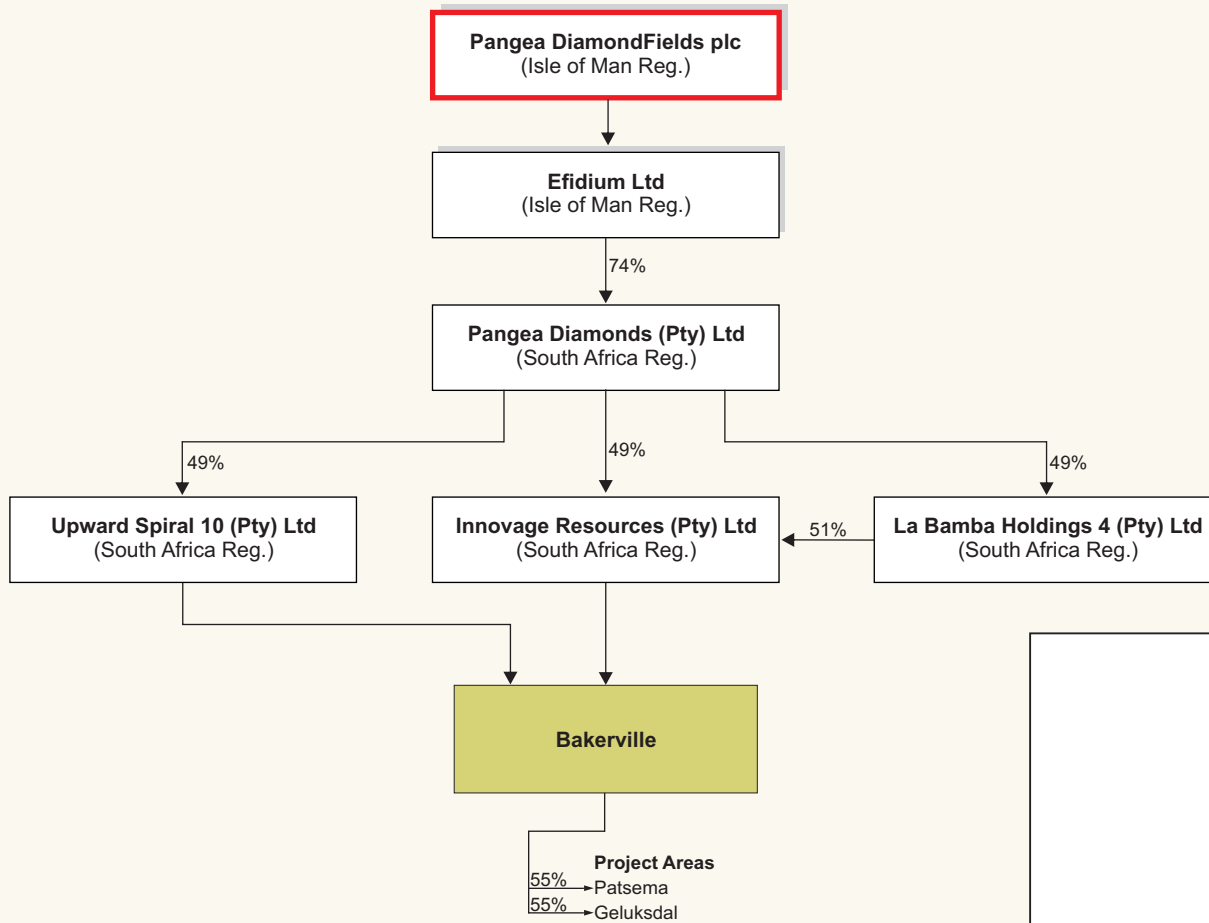

Geoimpact (Pty) Limited (Geoimpact) have an option for an 11.11% participation right on Houthaaldoorns 2 IP and Zamenkomst 4IP if, at the time of the bankable feasibility on these farms, they fund their share of the ongoing costs. Alternatively, if they don't exercise that option, they will have a 7.30% free carried interest at mine development stage.

### **28.1.2 Royalties, Fees and Taxes**

The Royalty Bill for South Africa is expected to be instituted in 2009 and in a report published in October 2006; a royalty of 5% was suggested for unpolished diamonds. The South African company tax rate is 30%. VAT of 14% is payable on all local services and purchases.

### **28.1.3 Impact of the Project on the Environment**

Environmental Management Plan (EMP's) for the Bakerville Project have been approved by the DME. An amount of ZAR45,000 has been paid by PDF into an exploration rehabilitation trust fund, as required by the DME, for the rehabilitation of the two project areas, as indicated in Table 105. Pangea aims to keep the impact on the environment to a minimum.

## **28.2 Accessibility, Climate, Local Resources, Infrastructure and Physiography**

### **28.2.1 Locality, Population and Access**

The Bakerville Project is situated in the Lichtenburg Magisterial District, within the Lichtenburg Diamond Field, approximately 250km west of Johannesburg (Figure 81). The Bakerville Project is situated in the North-West Province of SA, which has an approximate population of 3,7 million, which accounts for about 8.2% of the total population in SA.

Access to the Patsema and Geluksdal Project Areas is by well maintained tarred and gravel roads. To access the project areas from Lichtenburg, travel north on the main arterial route, R505, for a distance of 25km. There are several farm tracks and dirt roads providing access to the project areas.

An airstrip is located in Lichtenburg approximately 25km from the project area.

The nearest railhead is Lichtenburg.

### **28.2.2 Infrastructure and Local Resources**

The general infrastructure of the South Africa is shown in Figure 80.

A Genset is used to generate electricity for the project area and electricity is also supplied to the project area via the national grid, which will be used in the future for mining.

Water is sourced from boreholes on the farms located within the Project. This source of water is adequate for domestic and agricultural purposes. No governmental approvals were required to pump water from these boreholes and will only be used for domestic purposes. The borehole water is sufficient for the plant and for expansion to full-scale mining. Additional boreholes will be drilled for water and these will be equipped with large pumps. The water obtained from these additional boreholes will be stored in holding dams.

The Bakerville Project has five workers which are sourced from the local town Lichtenburg. The camp facilities include a caravan, water supply and chemical toilets. Lichtenburg is in close proximity to the project areas, thus only simple facilities are required on site.

A processing plant is located on the farm Zamenkomst 4IP, where all material from both the Patsema and Geluksdal Project Areas are processed.

### **28.2.3 Climate and Vegetation**

The Bakerville Project experiences warm summers (September to April) and moderately cool winters (May to August). The mid-day temperatures range from 22°C to 34°C in summer and 15°C to 22°C in winter. Annual precipitation is estimated at 600mm and is precipitated as thunderstorms. The climate at the Bakerville Project allows for an all year round operation.

The vegetation comprises typical highveld savannah grasslands.

#### 28.2.4 Physiography

The topography of the Bakerville Project is typically flat, with an elevation ranging from 1,500m amsl and 1,600m amsl. Areas surrounding the project are generally flat and consist primarily of open veld areas. Very little or poor drainage occurs within the property.

### 28.3 History

The Lichtenburg Diamond Field has been worked extensively since the 1920s.

#### 28.3.1 Historical Exploration, Sampling and Production Records

A record of the production from 1926 to 1989 for the Lichtenburg Diamondfields area is listed in Table 106. Highlighted in grey is production that came directly from the Patsema Project Area.

Production reached a peak in 1931, and gradually tailed off after that. In the late 1970s, approximately 30 small-scale diggers were recovering about 650cts per year.

It is estimated that the Bakerville diggings produced more than 7.5Mcts of diamonds, the bulk of which are reputed to have been derived from nine potholes with grades ranging from 2.5 to 250ct/100m<sup>3</sup>. The average grade for the Lichtenburg fields was estimated by Du Toit (1951) to vary between 16ct/100m<sup>3</sup> and 25ct/100m<sup>3</sup>. The remainder came from stretches along the numerous runs at an average grade ranging from 8ct/100m<sup>3</sup> to 12ct/100m<sup>3</sup>. Individual potholes contained between 200,000cts and 1,000,000cts. The most famous of these structures were the Bakerville Run and Malan's, Welverdiend and Pienaar's Potholes (Figure 83), all located immediately north of the Patsema Project Area.

**Table 106 : Recorded Historical Production from the Lichtenburg Area (1926-1989)**

FARM NAME	PRODUCTION (Cts)
Grasfontein	2,466,344
Uitgevonden	2,022,884
Wolverdiend	1,577,957
Ruigtelaagte	539,247
Klipkuil	299,307
Manana	138,067
Witklip	139,891
Elizabeth	111,944
Vlakplaats	74,130
Hendriksdal	68,881
La Rey's Stryd	66,864
Pypklip	19,887
Honingklip	9,406
Trekdrift	2,775
Graslaagte	1,450
Doornplaat	71
Houthaaldoorns	6
<b>GRAND TOTAL</b>	<b>7,539,115</b>

In the early 1980's, interest in the area was renewed with the release of a government survey report which indicated that undiscovered diamondiferous gravels may occur beneath sand cover within sinkholes and channels outside of the known major runs. This period saw the arrival of foreign and local mining and exploration companies in the area.

With the introduction of geophysical prospecting techniques during the 1980's, it became possible to probe karst dolomitic areas blanketed by superficial cover. Solution cavities hidden beneath younger overburden were detected through the application of gravity techniques.

**LEGEND:**

- Gravel Runs
- Sand Runs interpreted from Satellite images
- Current Project Area
- Diamond Production
- Main Road
- Road
- Farm Boundary
- 9 Diamond Production
- Powerline
- Pothole

**THE PATSEMA PROSPECT IN RELATION TO ALLUVIAL DIAMOND DIGGINGS**

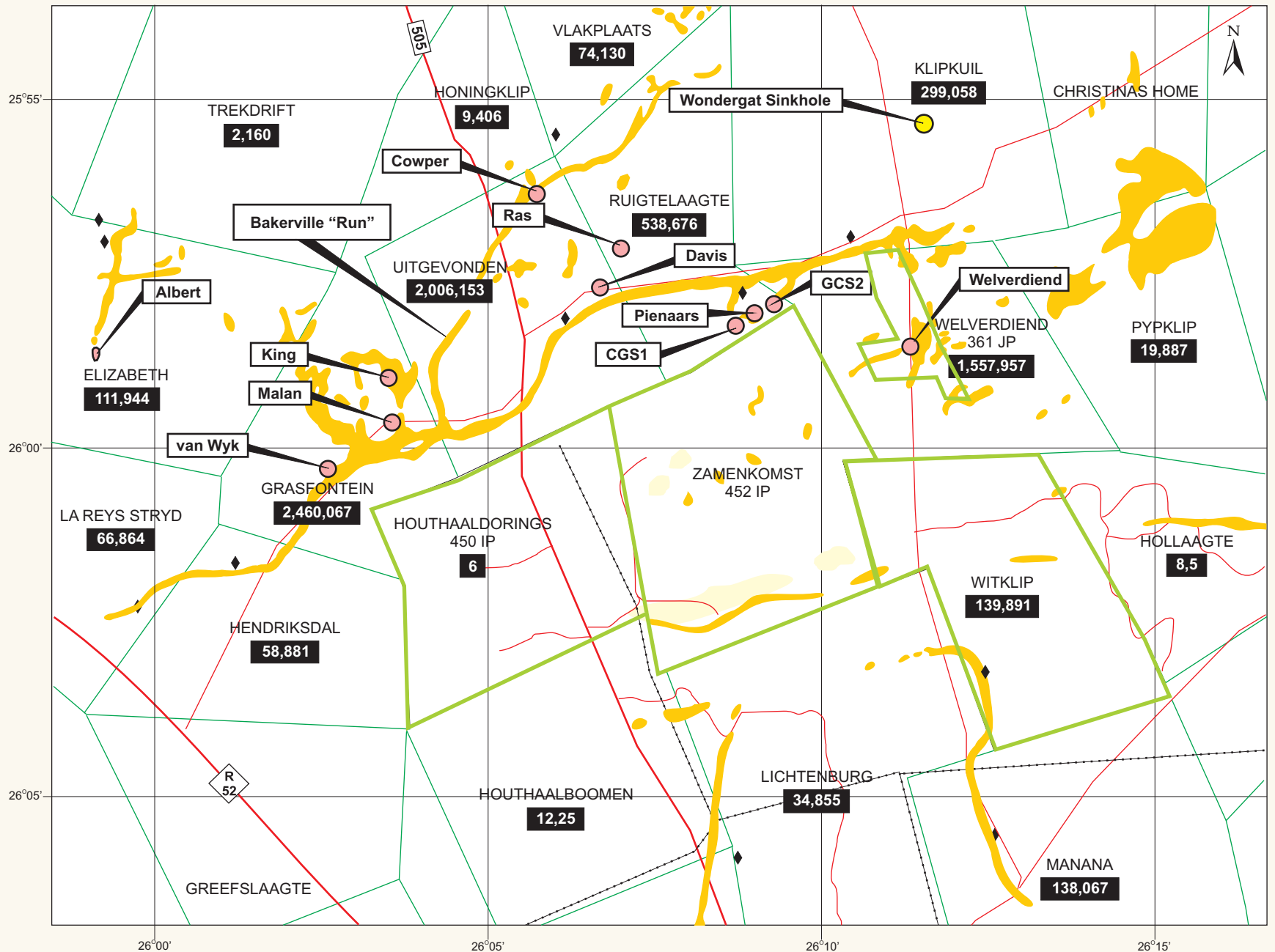

PangeaDFieldsTSX'07Fig83.cdr

Source: Marshall 1987 from Diamond Production 1926-1985



This diagram and the information therein are copyrighted. It may not be reproduced or transmitted in any form or by any means without prior written permission from Venmyn Rand (Pty) Ltd. Trading as Venmyn.

Note: The exact position of the gravel runs in relation to the Project Area will be confirmed by mapping

However, gravity anomalies and the presence of cavities in the dolomite, whilst being indicative of potential gravel traps, do not necessarily imply an accumulation of diamond-bearing alluvium.

Under the previous South African mineral laws, the mineral rights over many of the prospective properties in the area were held by the large mining houses, indefinitely neutralising them from exploration by outside parties. The new law Mineral and Petroleum Resource Development Act No. 28 of 2002 (MPRDA) has unlocked previously neutralised property, providing opportunities for new entrants, such as PDF.

The rights on the Zamenkomst and Houthaaldoorns farms of the Bakerville Project were previously owned by De Beers and PDF acquired the rights through their subsidiary companies, as a result of changes in the mineral legislation, which uses a “use it or lose it” slogan for all mineral rights in the land.

### **28.3.2 Historical Diamond Resources**

There have been no historical Diamond resource statements completed for the Bakerville Project.

## **28.4 Geological Setting**

### **28.4.1 Regional Geological Setting**

The regional geology of the project is comprised of the Transvaal Basin which is characterised by a major unconformity that separates the underlying dolomite and iron formation sequence (Chuniespoort Group) and the overlying Pretoria Group sediments. The unconformity is characterised by a predominant chert breccia and chert-dominated conglomerates on a palaeo-karst surface. The alluvial deposits of the Lichtenburg area overlie the irregular bedrock of Transvaal Dolomite, (Lyttleton and Monte Christo Formations) which comprises dolomite inter-bedded with chert units.

The Bakerville Project Area occurs within the Welverdiend-Ruigtelaagte-Grasfontein run near Lichtenburg. The gravels occur as runs, representing an ancient braided drainage system running east to west and covering an extensive floodplain. The runs now form a positive topographic expression. This is due to the hard gravels protecting the underlying strata from being eroded whilst the rest of the floodplain is denuded.

Large dolomitic palaeo-karst sinkholes or potholes of often present either within or outside of the runs. These potholes are formed by dissolution in areas of increased groundwater flow, usually in areas of structural weaknesses or faulting. The potholes were either formed during or post the run deposition and contain gravels. The development of a pothole is illustrated in Figure 84. The gravel within the potholes exhibits steep dips, and even overturning in places, indicating that solution subsidence was active both during and after deposition of the gravel. The pothole fill is normally a complex mixture of its own alluvial fill, together with collapsed material from the adjacent deposits. The diamond grades recorded in the potholes are therefore dependant not only on the morphology of the pothole, but also to a great extent on where it is situated relative to the run.

The source of the diamonds is unknown.

### **28.4.2 Local and Property Geology**

The gravels found in runs and potholes were deposited in three stages in the karst channels, resulting in a stratigraphic package of breccia, channel run gravel and sheet (Rooikoppie) gravel. The gravels are characterised by well-rounded clasts and are generally diamond-bearing. An overall thickening of these gravels packages from east to west has been observed. These gravels are described in Table 107.

**THE DEVELOPMENT OF A POTHOLE**

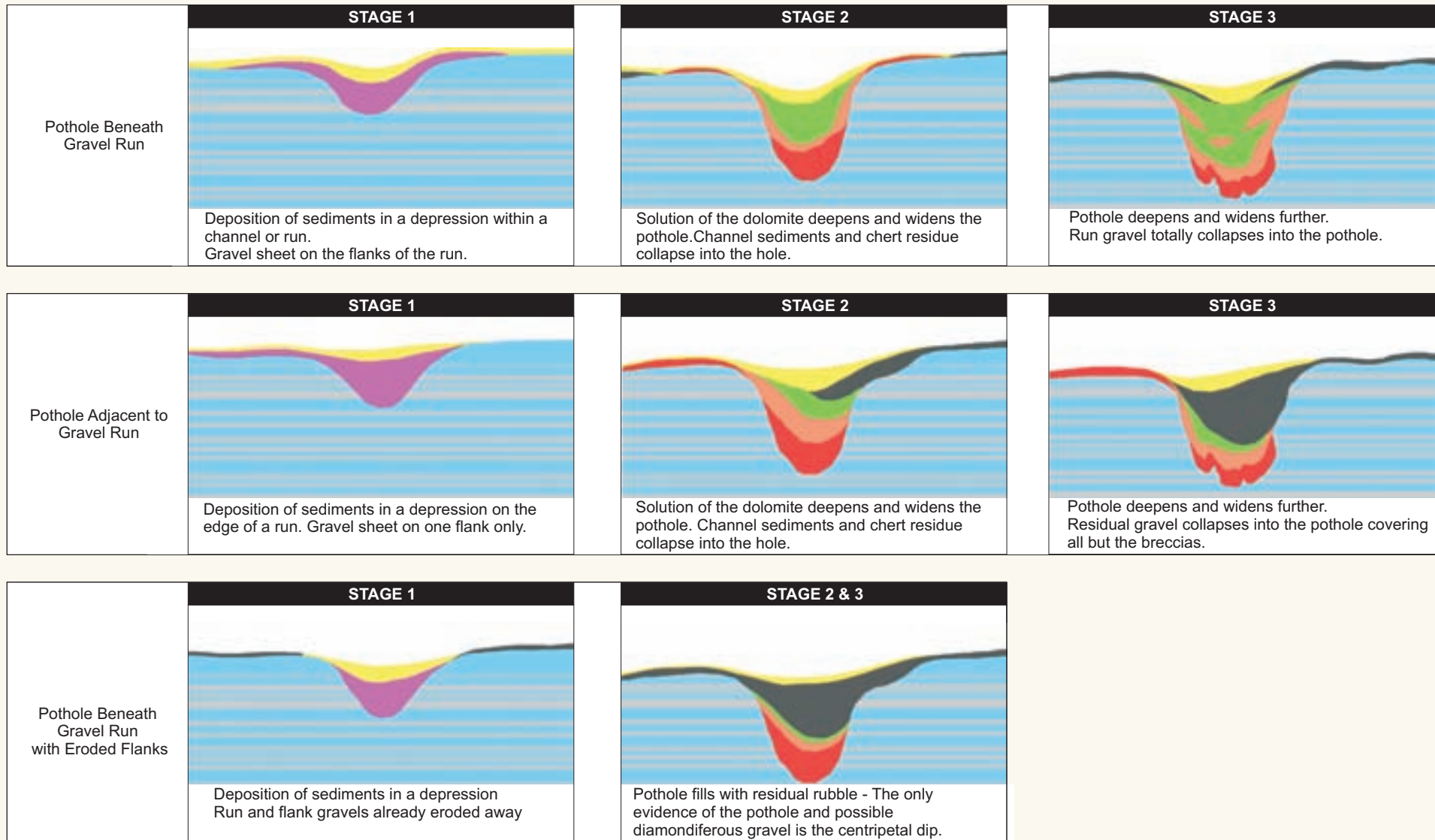

Source: AG Bloomer

**LEGEND:**

- Sand, silt, windblown sand and rubble
- Residual chert breccia, usually barren
- Moderate to lower grade breccia
- Diamondiferous alluvial gravel
- Moderate to high grade breccia
- Interbedded dolomite and chert bedrock

This diagram and the information therein are copyrighted. It may not be reproduced or transmitted in any form or by any means without prior written permission from Venmyn Rand (Pty) Ltd. Trading as Venmyn.

**Table 107 : Typical Gravel Layers of the Diamond Runs**

NAME	DESCRIPTION OF GRAVELS
Breccia (Lower Gravel)	<ul style="list-style-type: none"> <li>• Oldest gravels;</li> <li>• Scree from immediate bedrock;</li> <li>• Angular chert fragments;</li> <li>• Very little heavy mineral concentration;</li> <li>• Very little clay matrix; and</li> <li>• Appears white to grey in the field.</li> </ul>
Channel (Middle Gravel)	<ul style="list-style-type: none"> <li>• Generally channelised, occur in meanders of ancient river system;</li> <li>• River load;</li> <li>• Channels vary in dimension from few cm deep and 1m wide to depths of 5m and widths of 40m;</li> <li>• One main channel has been identified;</li> <li>• Gravels occur in this palaeo-channel overlying the main dolerite dyke running east-west across the property.</li> <li>• Similar gravels converge or shoot-off from this main channel, giving the deposit a braided character;</li> <li>• Physically resemble Sheet Gravels some boulder beds evident; and</li> <li>• Indications are that there are a lot more channels on the property.</li> </ul>
Sheet (Upper Gravel)	<ul style="list-style-type: none"> <li>• Youngest gravels;</li> <li>• Covers whole area under claim;</li> <li>• Reworked gravels during sheet floods;</li> <li>• Between 10 to 50cm thick;</li> <li>• Poorly sorted;</li> <li>• Sheet-like character;</li> <li>• Recognized as a white to pink layer;</li> <li>• Generally well rounded grit to cobble sized clasts;</li> <li>• Well-rounded clasts;</li> <li>• Clasts are mainly chert ,with some quartzite and shale also present;</li> <li>• Heavy mineral fraction consists mainly of magnetite, haematite and manganese nodules with minor amounts of ilmenite and spinel;</li> <li>• Heavy mineral fraction is generally grit to pebble size; and</li> <li>• Appreciable thickening observed over channels.</li> </ul>

There are at least four potholes present within the project area, which have been identified through reverse circulation (RC) drilling. The potholes range up to 40m in depth.

A characteristic of the Lichtenburg diamond fields is the wide variation in diamond quality over short distances. Each deposit has its own specific diamond suite and associated diamond sales value. This variation in shape, size and composition of the diamond-bearing gravel bodies is a factor that has had an important bearing on their economic potential.

### 28.5 Deposit Type

The Bakerville Project deposits are secondary diamond deposits. These include alluvial runs and potholes.

### 28.6 Mineralization

The Bakerville Project is characterised by alluvial runs and potholes (Figure 85), found on both project areas. The pothole in the Geluksdal Project Area is approximately 400m x 150m x ~40m. The dimensions of the four potholes on the Patsema Project Area are the following:-

- 100m x 75m x ~40m;
- 80m x 80m x ~40m;
- 100m x 120m x ~40m; and
- 90m x 50m x ~40m.

The Patsema and Geluksdal Project Areas show a similar stratigraphy, Figure 86, between the gravel filled potholes, wherein, both consist of a thick upper and lower gravel zone, separated by clays, diamictites and sand. They do, however, differ significantly in the gravel content, as described in Table 108.



**LEGEND:**

- Resource Block
- Drill Delineated Pothole
- Mapped and Drill Intersected Gravel Runs
- Farm Boundary

**PATSEMA GRAVEL RUNS AND POTHOLES**

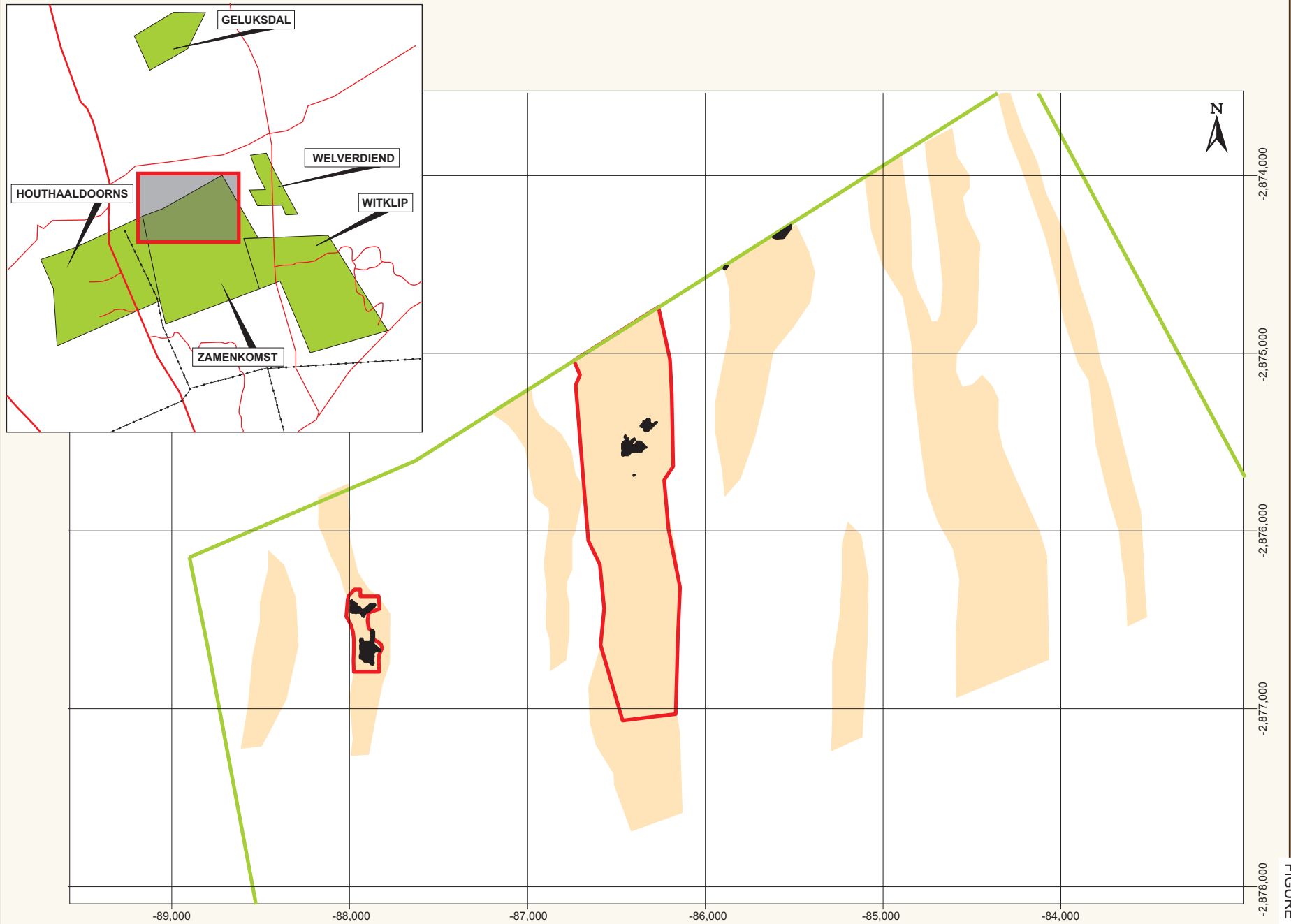

PangeaDFieldsTSX'07Fig85.cdr

Source: Pangea

SCALE:



This diagram and the information therein are copyrighted. It may not be reproduced or transmitted in any form or by any means without prior written permission from Venmyn Rand (Pty) Ltd. Trading as Venmyn.

**LEGEND:**

- Surface Gravel
- Gravity Low
- Drill Delineated Pothole
- Drill Delineated Gravel Runs
- RC Drillholes
- LDD Drillholes
- Surface Sample
- Project Area Boundary
- Resource Area

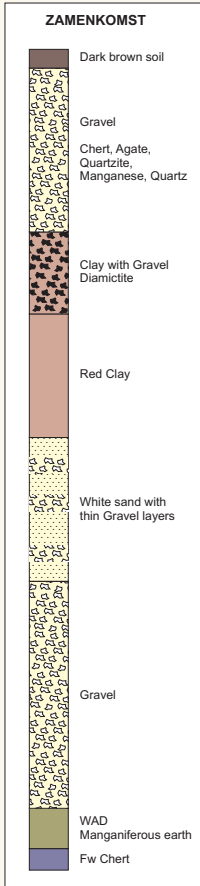

SCALE:



This diagram and the information therein are copyrighted. It may not be reproduced or transmitted in any form or by any means without prior written permission from Venmyn Rand (Pty) Ltd.

**STRATIGRAPHIC COLUMN AND LOCATION OF EXPLORATION WITHIN THE PATSEMA PROJECT AREA**

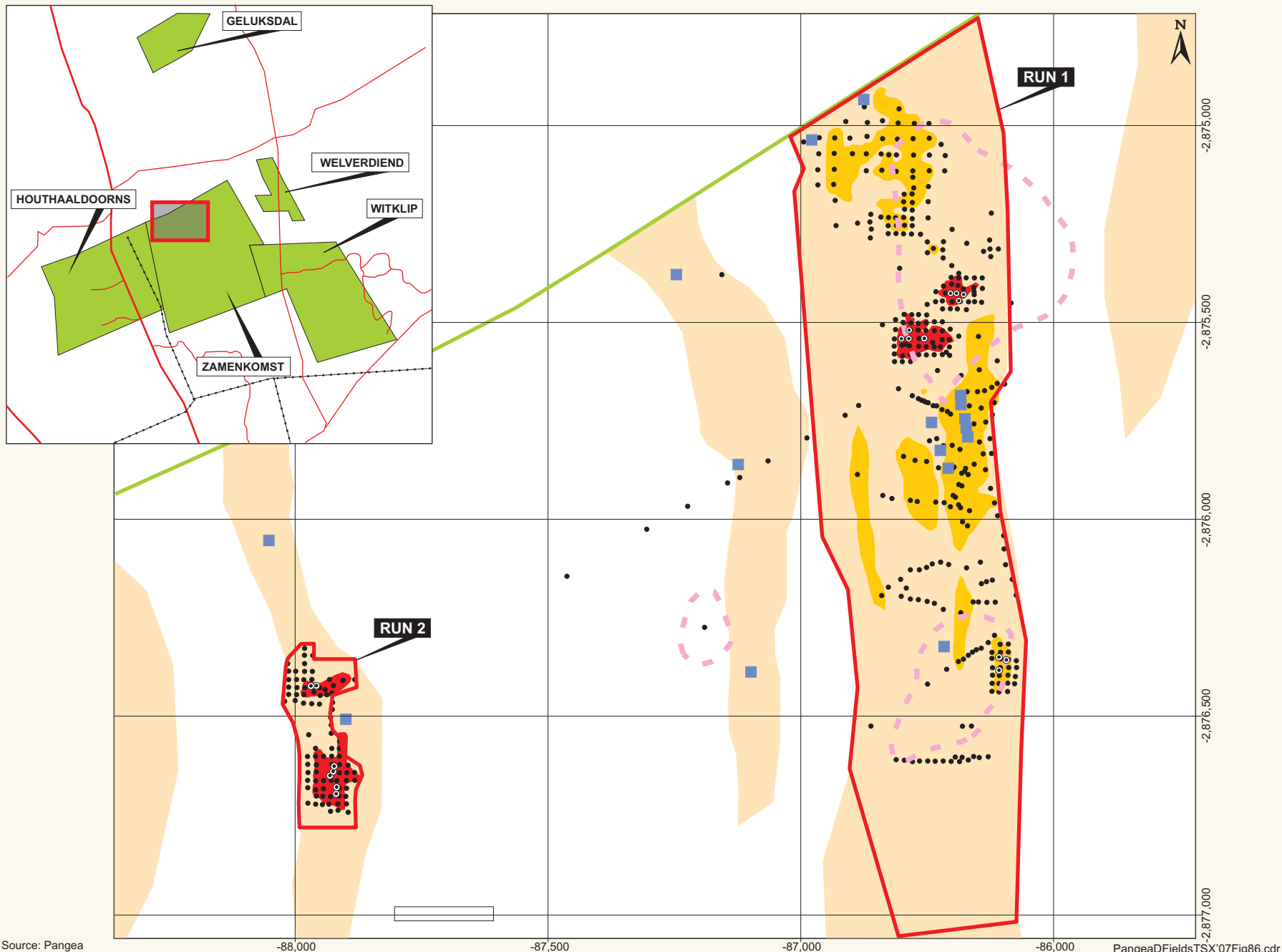

Source: Pangea

PangeaDFieldsTSX'07Fig86.cdr

**Table 108 : Comparison between Geluksdal and Zamenkomst Gravels**

CONTENTS	GELUKSDAL	ZAMENKOMST
Major Gravel Component	Chert	Chert
	Limonite	Manganese
	Manganese	Agate
Minor Gravel Component	Quartzite	Quartzite
	Quartz	Quartz
	Siderite	
Pebble Size	Between 1 and 22cm	Between 1 and 10cm
Pebble Shape	Angular to sub-angular	Rounded to sub-angular

Geluksdal Project Area shows a north-south trend thinning towards the east and west, and reaches a maximum thickness of 12m in the centre of the channel.

## 29 BAKERVILLE PROJECT – PATSEMA PROJECT AREA

### 29.1 Exploration

The objective of PDF's exploration programme was to define diamond resources within the runs and associated potholes within the property area. Exploration commenced in 2005 with the first phase of reconnaissance exploration involving the use of satellite imagery, high resolution airborne magnetics, infrared surveys and ground gravity surveys. Thereafter, drilling was carried out to define the lateral and vertical extent of the gravels. Grade estimates were made using large diameter drill (LDD) holes and surface pitting. The samples were processed through a mobile dense medium separation (DMS) plant.

### 29.2 Reconnaissance Exploration

Reconnaissance exploration commenced in 2005 and was conducted until the end of 2006. Airborne magnetics was used to identify structures, including dykes and lineaments. The ground gravity survey was completed on a portion of the Zamenkomst Farm and was conducted on a 30m x 30m grid (Figure 87). The data obtained from this survey was combined with data obtained from a Master of Science degree (MSc). completed by Edgar Stetler in the late 1970s. The gravity survey was used to identify possible gravels in the form of both runs and potholes in areas of low gravity.

Analyses of the results of these surveys, and the regional geological synthesis that followed, resulted in the identification of target areas and their extents. This was then followed up with drilling.

### 29.3 RC Drilling

The purpose of the RC drilling was to delineate the extent of the gravels and commenced in October 2006. The location of the drilling is indicated on Figure 86.

#### 29.3.1 Sampling Method and Approach





The RC drilling was conducted on a 100m grid to intersect gravel which had been previously identified in the gravity survey and from outcrop. Drilling was infilled on a 20m grid in order to delineate the extent of the gravel runs and potholes.

Drill cuttings from the RC drilling are returned to surface inside the rods. Reverse circulation is achieved by blowing air down the rods which creates a differential pressure in the rod. The differential pressure creates air lift within the rod, causing the water and cuttings to move up and out the inner tube of the rod. The samples are collected in a sample bag.

PDF used a 12.5cm to 20.0cm in diameter drill bit at Patsema. The penetration rate is dependent on the type of material, whether consolidated or unconsolidated material, where 1m/5min was achieved at Patsema. The maximum drill depth was dependant on the footwall and range from 7m to 45m. The number of holes drilled in a day ranged from five to seven holes a day.

The RC rig consists of a support vehicle, an auxiliary vehicle, as well as the rig itself.

**LEGEND:**

-  Farm Boundaries
-  Potholes
-  Areas of Historical Mining
-  Project Limit
-  Prospecting Target Zone

**PATSEMA PROSPECT GRAVITY SURVEY 2005**

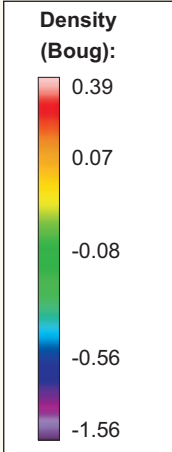
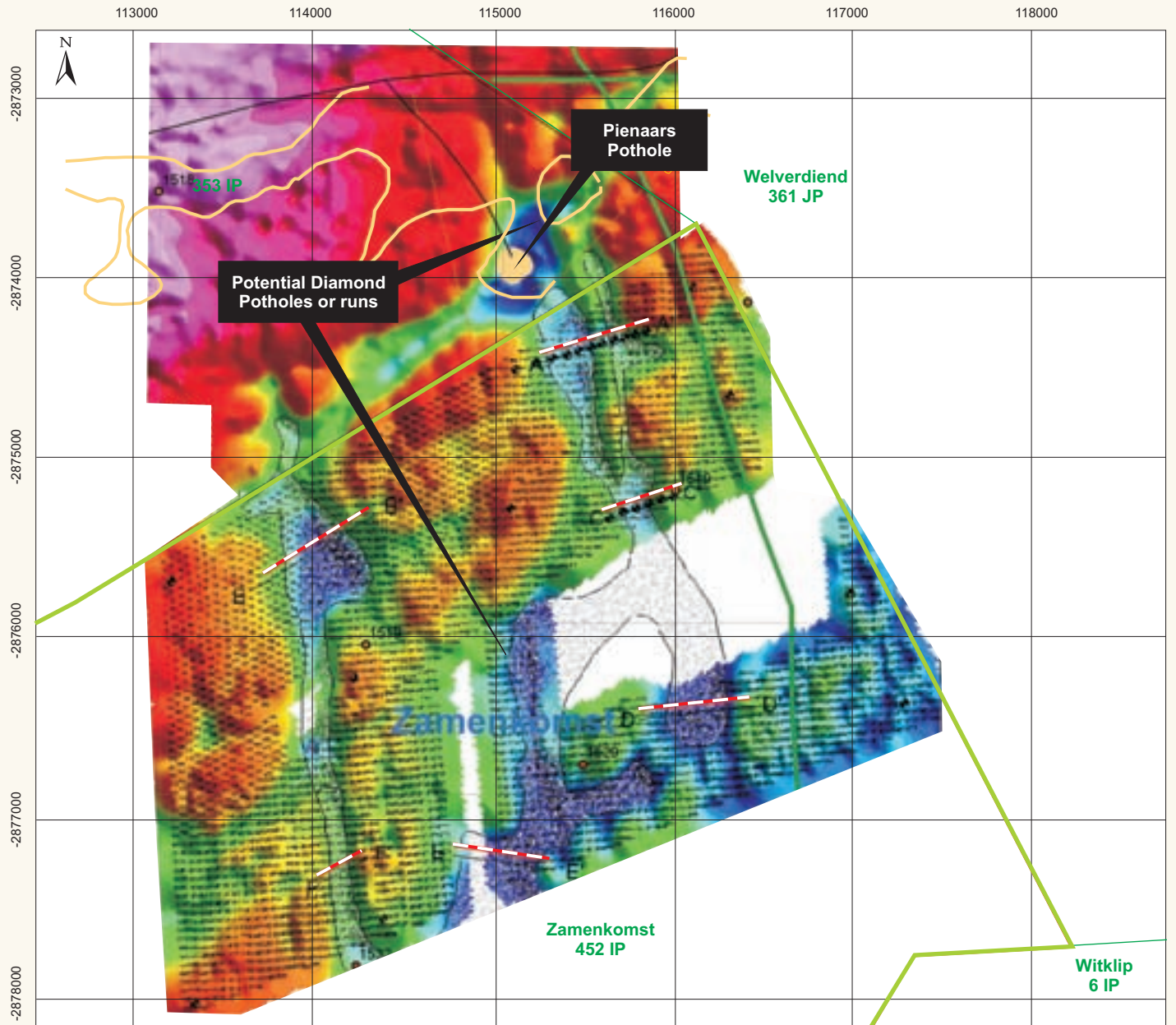
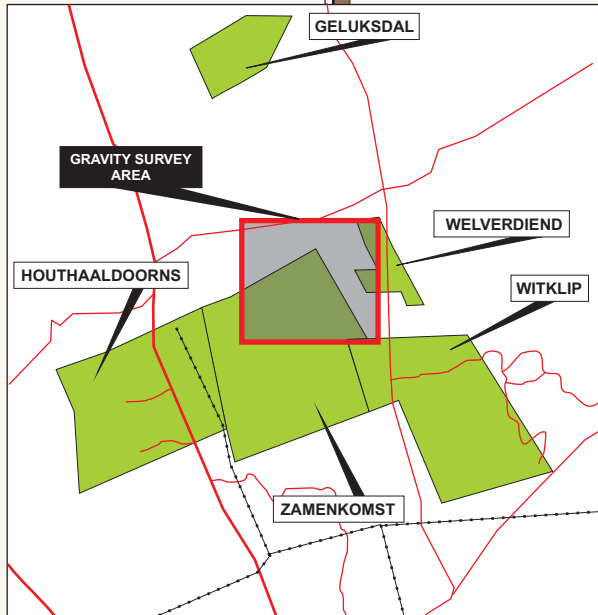

PangeaDFieldsTSX'07Fig87.cdr

Source: Council of Geoscience

**SCALE:**



This diagram and the information therein are copyrighted. It may not be reproduced or transmitted in any form or by any means without prior written permission from Venmyn Rand (Pty) Ltd. Trading as Venmyn.

The samples were numbered sequentially from 1, with an alphabetical prefix Z which indicates the farm Zamenkomst, e.g. Z1.

All holes were surveyed using a handheld GPS.

Samples were taken at 1m intervals and placed in chip trays. The 1m samples were labelled according to the borehole number and depth of the sample, written with a permanent marker on the plastic top of the chip tray. The samples were logged by hand on site by the geologist on logsheets and later digitally captured.

These logs were then sent to PDF. The samples were transported, on a daily basis, to the geologist's office in Lichtenburg where the samples are stored. A total of 571 boreholes were drilled. The total length of the holes was 9,338m.

### 29.3.2 Sample Preparation, Analyses and Security

The samples were stored in chip trays for future verification. No samples were taken for diamond grade determinations.

### 29.3.3 Data Verification

The database of results was checked by PDF at their head office in South Africa. The data was verified by checking random samples in the database from the logsheets. Senior geologists from PDF also conduct spot checks onsite, again using random checks of the logging of samples both onsite and in the storeroom, and the checks compared well with the original logs.

Venmyn has not verified the database in detail but has witnessed the rigorous process of verification which PDF's headoffice geologist undertakes. This being the case, the Qualified Person is satisfied that this process of verification will minimise error in data entry and identify any inconsistencies in the actual sample data and the database entries.

### 29.3.4 Results

Gravel runs and potholes were delineated in the Patsema Project Area during the RC drilling programme. The current RC drilling and delineated areas are illustrated in Figure 86. The gravels were found to occur on surface; therefore no overburden was present. The gravel thicknesses were modelled in the computer orebody modelling software package, Surfer® for both the runs and the potholes in the Patsema Project Area and are shown in Figure 88 and Figure 89.

The thicknesses were modelled by gridding the data using an inverse distance squared method of estimation. No search radius was used for the data; therefore, all data points were used in order to obtain a more accurate thickness value for the Patsema Project Area. The grid line geometry used was 200 by 200 grid lines. The limits of the modelling were chosen using the delineated gravel areas. Modelling was completed on both runs and the four potholes separately.

The gravel thickness database also included the results of the LDD drilling. The summary statistics for the modelling is indicated in Table 109.

**Table 109 : Summary Statistics for Patsema Modelling**

PROJECT AREA	BLOCK	NO. DATA POINTS	GRAVEL THICKNESS (m)			OVERBURDEN THICKNESS (m)		
			MIN	MAX	AVE	MIN	MAX	AVE
Patsema	Run 1	369	0	10.46	1.99	0	0	0
	Run 2	90	0	10.31	3.41	0	0	0
	Run 1 Pothole A	29	0	11.88	4.26	0	9.53	2.16
	Run 1 Pothole B	43	0	34.61	6.42	0	3.69	2.13
	Run 2 Pothole A	18	0	16.69	4.93	0	9.86	3.17
	Run 2 Pothole B	33	0	30.92	7.99	0	11.95	4.63
	<b>TOTAL</b>	<b>582</b>						

The gravel thickness plots for Run 1 (Figure 88) at Patsema show that the gravel thickness increases from the south to the north, with the thickest regions in the northeast, which range from 3.0m to 5.0m. There is no overburden for the runs, which make it a good target for mining. The potholes located in Run 1 show a thick development of gravels, with the majority of the gravels ranging between 8m and 4.5m.

The gravel thickness plots for Run 2 (Figure 89) show that the gravels become thicker towards to the south of the run, with the average thickness in the south of the run at 5.0m deep. The potholes in Run 2, as with in Run 1, show a thick development of gravels, reaching on average a thickness between 5.0m and 8.0m. The runs in Patsema are ideal for mining as there is no overburden.

## 29.4 LDD Holes

The purpose of the LDD holes was to determine the grade primarily of the potholes. This drilling commenced in July 2007.

### 29.4.1 Sampling Method and Approach

The LDD holes were positioned on the potholes over existing RC drillsites. This enabled the accuracy of the RC drilling to be verified in the process. The diameter of the LDD holes was 2.50m, with 5m<sup>3</sup> of material being extracted per metre drilled. A total of 19 holes was drilled vertically, as shown on Figure 86.

The Bauer BG-type drill rig is a track-mounted base carrier with mast attachment. A front-end loader is required at the drill site in order to complete the following tasks:-

- to clear the discharge area next to the drill;
- to handle the sample, by stockpiling the samples near the drill; and
- to handle to the overburden and backfill.

The drilling bucket collects the sample in drilling cycles of 0.5m deep. The 2.5m drill hole diameter yields an average of 10t – 12t bulk samples per a metre drilled. On average two to four holes were drilled on a daily basis, reaching a depth of 20m to 45m.

The holes are numbered sequentially from 1 and are labelled with a prefix of BB, which indicates the Bauer Borehole.

All LDD holes were surveyed by the on site geologist using a handheld GPS.

### 29.4.2 Sample Preparation, Analyses and Security

The top, middle and bottom gravel layers, previously identified during the RC drilling, were split into different samples during the LDD drilling and stockpiled separately. The sample information was recorded on site by the geologist. The stockpiles were labelled using chalk black boards which included the following information:-

- farm name;
- borehole number; and
- heap or sample number.

The samples were transported to the plant using two 15t trucks, under the supervision of the geologist.

The plant used to process the samples is discussed in detail in Section 29.7.

The method of sample preparation is adequate. The method of processing is not faultless both with regards to recovery and security, since an open grease belt is used for recovery purposes. However, this may only result in an under estimation of the grade and therefore the results are acceptable to the Qualified Person. PDF have also informed Venmyn that a Flow Sort® x-ray recovery will replace the grease belt recovery.

**CONTOUR PLOTS OF THE GRAVEL THICKNESS FOR RUN 1 AND ASSOCIATED POTHOLES**

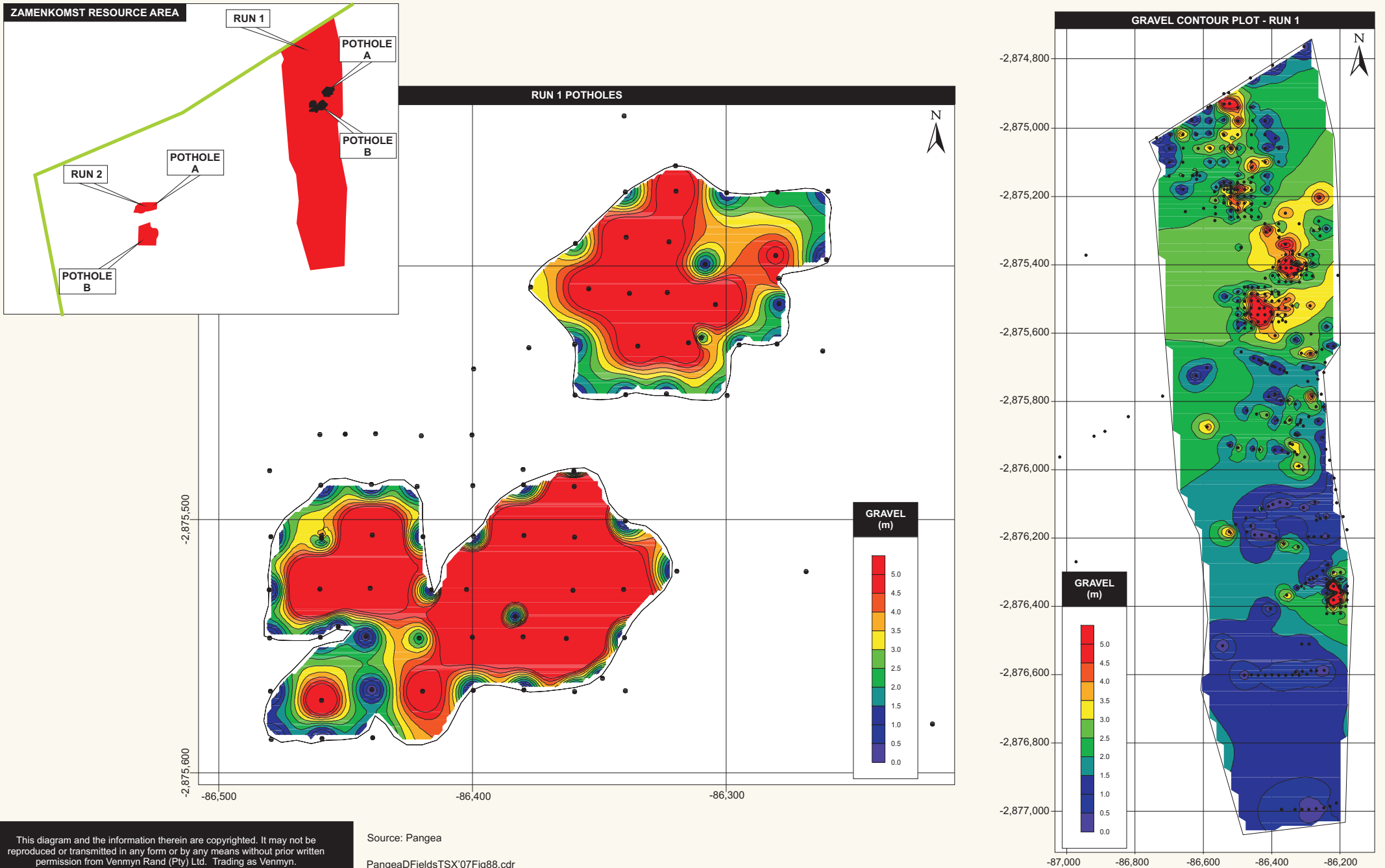

This diagram and the information therein are copyrighted. It may not be reproduced or transmitted in any form or by any means without prior written permission from Venmyn Rand (Pty) Ltd. Trading as Venmyn.

Source: Pangea

PangeaDFieldsTSX'07Fig88.cdr

**CONTOUR PLOTS OF GRAVEL THICKNESS FOR RUN 2 AND ASSOCIATED POTHOLES**

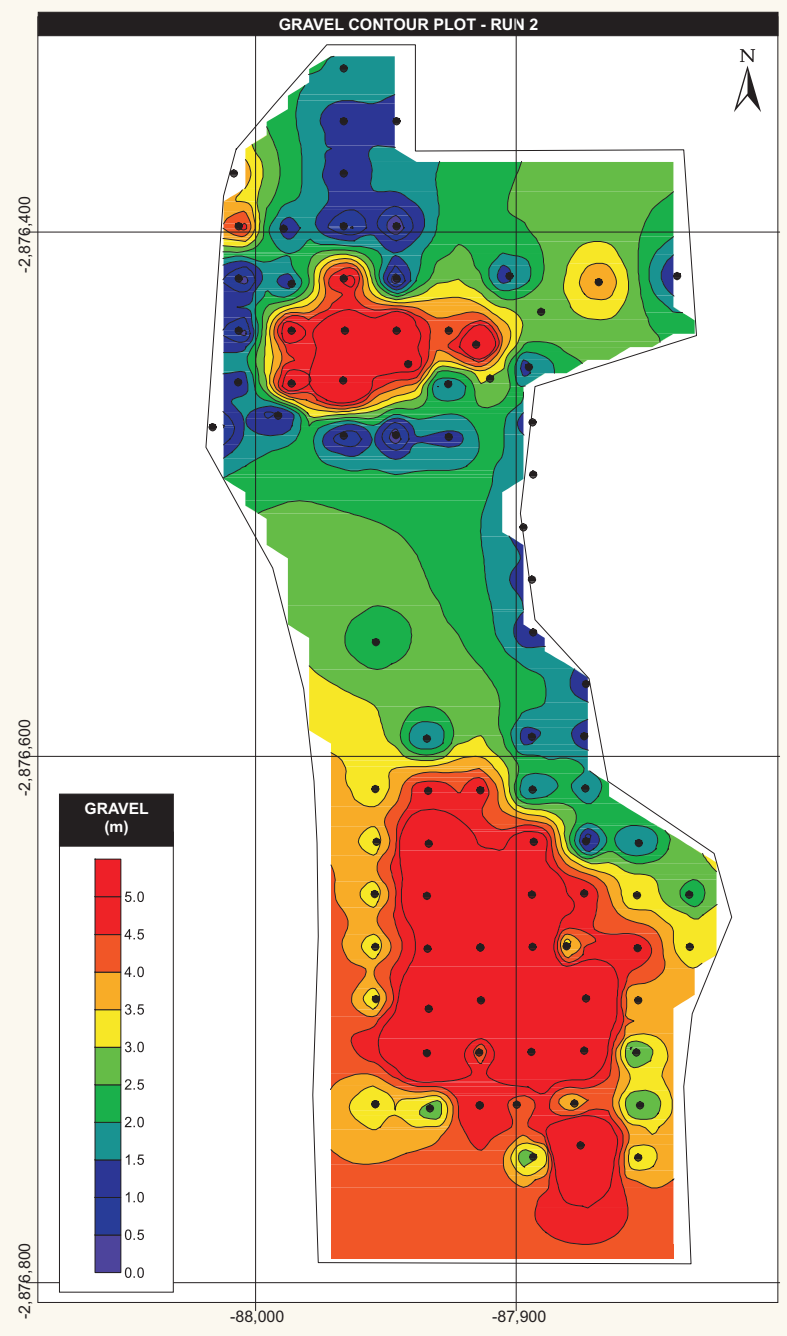
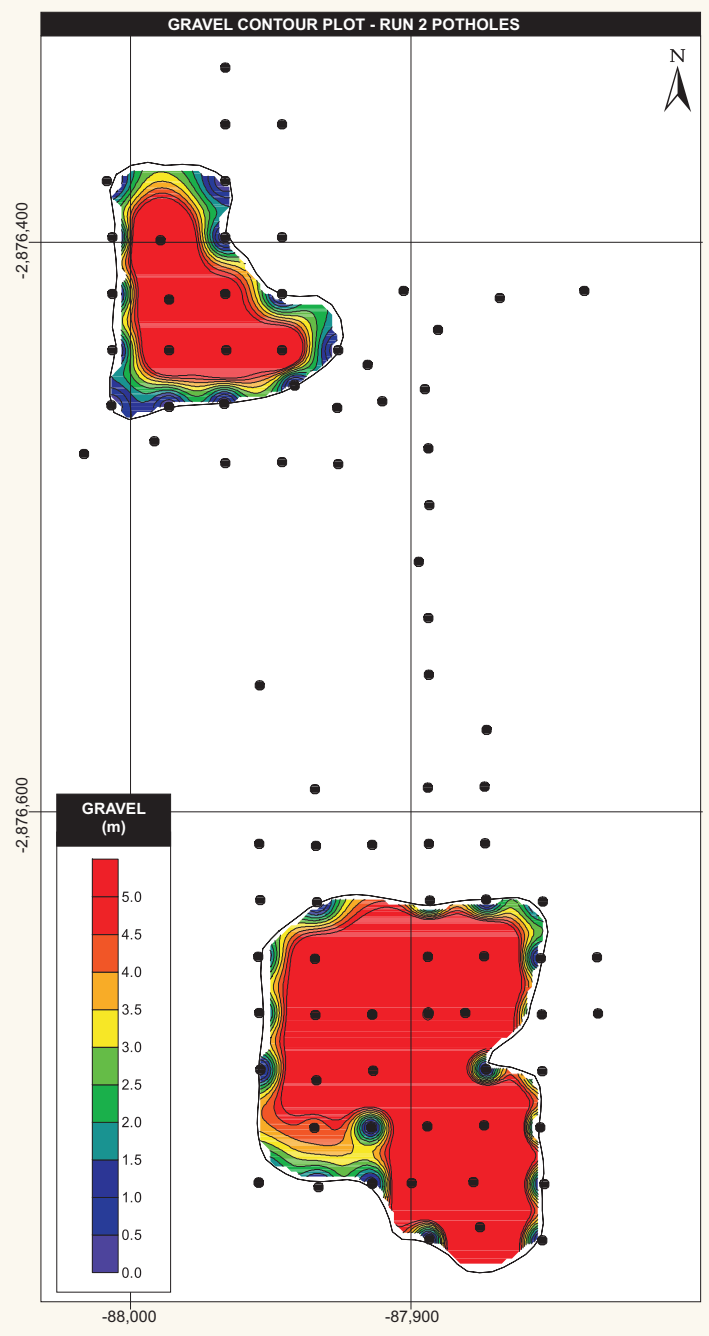
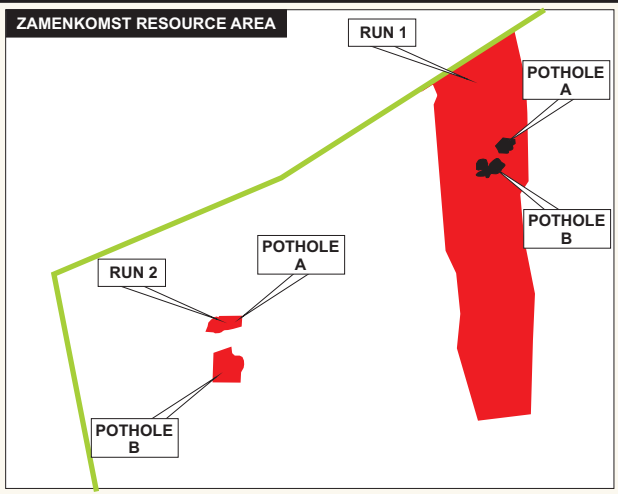

Source: Pangea  
PangeaDFieldsTSX'07Fig89.cdr

This diagram and the information therein are copyrighted. It may not be reproduced or transmitted in any form or by any means without prior written permission from Venmyn Rand (Pty) Ltd. Trading as Venmyn.



### 29.4.3 Data Verification

The database of results is checked by PDF at their head office in South Africa by checking random samples in the database to the original logsheets, as described in Section 29.3.3.

Venmyn has not verified the database in detail but has witnessed the rigorous process of verification which PDF's headoffice geologist undertakes. This being the case, the Qualified Person is satisfied that this process of verification will minimise error in data entry and identify any inconsistencies in the actual sample data and the database entries

### 29.4.4 Results

The preliminary results from 12 of the 19 LDD holes are tabulated in Table 110 and included with the RC results in the contour plots in Figure 88 and Figure 89. A total of 53 diamonds was recovered, with an average stone size of 0.46cts. The largest stone recovered was 2.65cts. The four potholes of the Patsema have shown low grades with high stripping ratios.

**Table 110 : Summary of LDD Holes Results for the Patsema Project Area**

SAMPLE NO.	GRAVEL TYPE	O/B THICK (m)	GRAVEL THICK (m)	GRAVEL VOLUME (m <sup>3</sup> )	TOTAL CARATS	NO. STONES	GRADE (ct/100m <sup>3</sup> )	STONE SIZE (ct/stone)	BOTTOM SCREEN SIZE (mm)
BB006	Run 1	1	6	29	0.57	2	1.94	0.3	2.0
BB008	Run 1	0	5	22	2.40	5	10.86	0.5	2.0
BB009	Run 1	0	4	20	0.68	3	3.46	0.2	2.0
BB010	Run 1	3	6	29	0.34	1	1.15	0.3	2.0
BB022	Run 1	0	5	25	0.20	1	0.80	0.2	2.0
BB023	Run 1	0	5	25	0.56	4	2.28	0.1	2.0
BB018	Run 2	2	4	20	2.65	1	13.50	2.7	2.0
BB014	Run 2	5	13	64	0.53	2	0.83	0.3	2.0
<b>TOTAL/AVE</b>		<b>11</b>	<b>48</b>	<b>234</b>	<b>7.93</b>	<b>19</b>	<b>3.39</b>	<b>0.4</b>	<b>2.0</b>

## 29.5 Surface Samples

Surface sampling commenced in the runs in November 2007, to confirm the results from the upper gravels obtained from the LDD holes.

### 29.5.1 Sampling Method and Approach

Surface samples were positioned randomly within the gravel run. They were excavated using a loader with a bucket size of 5t to remove the upper 2m of the run, as it is was shown in the RC drilling that this layer contains the maximum diamond grade. The sample pit dimensions are generally 2m x 3m and between 1.5m and 2m deep. Approximately 10m<sup>3</sup> to 12m<sup>3</sup> material was removed from each sample. All surface sample pits were logged using a GPS by the on-site geologist.

The samples were numbered sequentially beginning with S1, where the prefix, S, represents the surface samples.

The samples were stockpiled at the plant, and labelled in a similar manner to the LDD holes (Section 29.3.1). A total of 12 samples have been excavated to date, as shown in Figure 86.

### 29.5.2 Sample Preparation, Analyses and Security

The sample preparation for the surface samples is similar to that of the LDD holes which is described in detail in Section 29.4.2. The samples were processed using the plant described in detail in Section 29.7.

As mentioned, the method of sample preparation is adequate. The method of processing is not faultless both with regards to recovery and security, since an open grease belt is used for recovery purposes. However, this may only result in an under estimation of the grade and therefore the results are acceptable to the Qualified Person. PDF have also informed Venmyn that a Flow Sort® x-ray recovery will replace the grease belt recovery.

### 29.5.3 Data Verification

The database of results was verified by PDF at their head office in South Africa, as described in Section 29.3.3.

Venmyn has not verified the database in detail but has witnessed the rigorous process of verification which PDF's headoffice geologist undertakes. This being the case, the Qualified Person is satisfied that this process of verification will minimise error in data entry and identify any inconsistencies in the actual sample data and the database entries.

### 29.5.4 Results

To date, PDF have only begun processing these samples and no results were obtained at the time of completing this report.

## 29.6 Adjacent Properties

Production for the adjacent properties is shown in Figure 83. These production figures can not be verified and therefore, the qualified person, for the purpose of this report, has not verified the aforementioned information.

## 29.7 Mineral Processing and Metallurgical Testing

The samples processed through the bulk sampling are considered to be representative of both the runs and the potholes.

### 29.7.1 Processing Plant

The processing plant is situated in close proximity to the exploration area, on the Zamenkomst farm. The samples were processed through a 20tph DMS plant with a grease table and Flowsort® final recovery plant (Figure 90). The plant is fed by a 5t capacity FEL.

The plant feed is scrubbed at a top size of 25mm and deslimed at a bottom screensize cutoff of 1.6mm. The slimes are fed to a slimes dam adjacent to the plant and the oversize (+25mm) portion is stockpiled. This is resent through the scrubber on every third load. The +1.6mm -25mm is fed through vibrating screens and conveyed to a surge bin that provides a constant feed to the 20tph DMS. The DMS is fed into an attritioner to be cleaned once again.

### 29.7.2 Final Recovery

The simplified flowsheet for the final recovery is illustrated in Figure 91. The concentrate from the attritioner is passed through a classifying screen where it is sized as follows:-

- +19.0mm – 25.0mm;
- +12.0mm – 19.0mm;
- +8.0mm – 12.0mm;
- +4.0mm – 8.0mm; and
- +1.6mm – 4.0mm.

The four size fractions are passed over a grease table, where diamonds are extracted. All concentrate which has passed over the table is bagged with a sample number label placed inside the bag. The bags are sealed with cable ties, and sent for final recovery at a nearby Flow Sort® at Honingklip in Ottosdal, a distance of 125km. The bags are transported by light delivery vehicle by the geologist.

PDF have advised Venmyn that they have subsequently made changes to the process in mid-February to reduce the top cut-off size to 19mm and have introduced a Flow Sort® x-ray recovery facility to replace the previous grease-table recovery.

**SCHEMATIC FLOWSHEET FOR THE BAKERVILLE PROJECT PLANT**

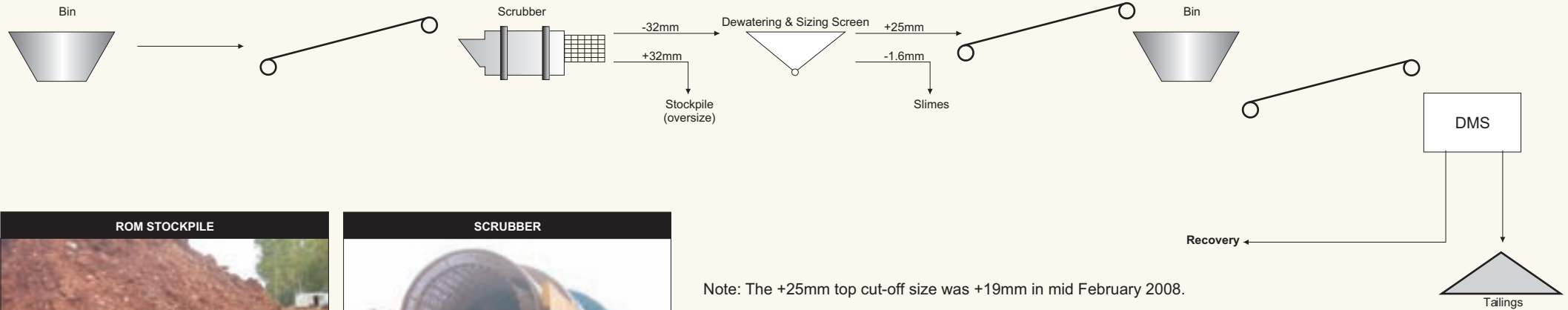

Note: The +25mm top cut-off size was +19mm in mid February 2008.

Source: Venmyn

This diagram and the information herein is copyrighted. It may not be reproduced or transmitted in any form or by any means without prior written permission from Venmyn Rand (Pty) Ltd. Trading as Venmyn.

PangeaDFieldsTSX'07Fig90.cdr

**SCHEMATIC FLOWSHEET FOR THE BAKERVILLE FINAL RECOVERY**

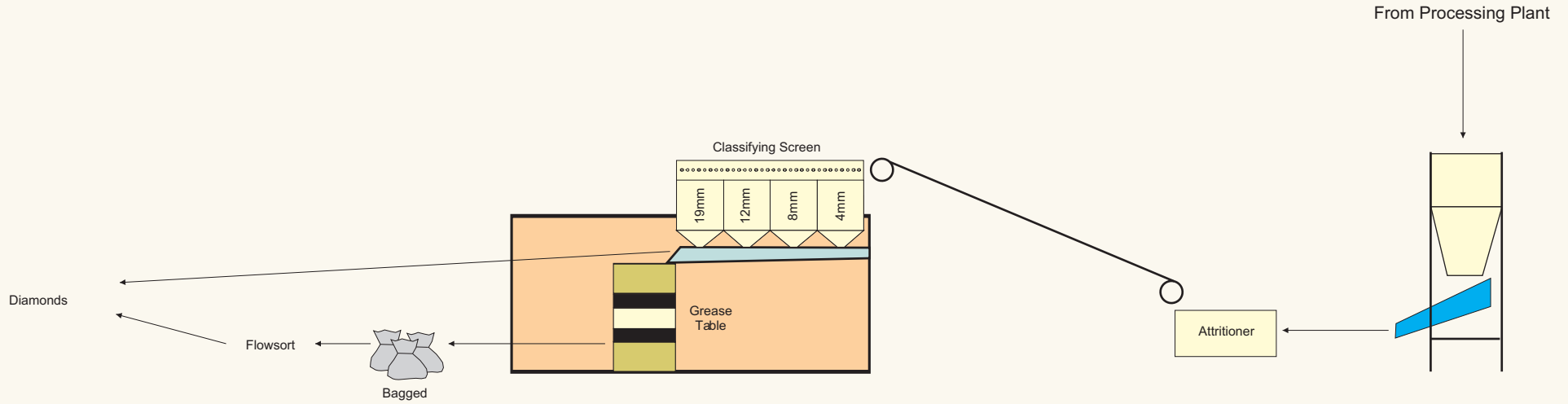

Note: A new Flowsort Plant was commissioned in February 2008, to replace the Grease Table.



Source: Venmyn

This diagram and the information herein is copyrighted. It may not be reproduced or transmitted in any form or by any means without prior written permission from Venmyn Rand (Pty) Ltd. Trading as Venmyn.

PangeaDFieldsTSX'07Fig91.cdr

### 29.7.3 Security

The current security level in and around the processing plant is relatively low. The plant site is currently being fenced. The existing security facilities consist of the following:-

- the concentrate from the DMS is fed by a tube conveyor to the final recovery;
- the grease belt is kept within a locked container; and
- final recovery and sorting is always undertaken with at least two PDF representatives present.

PDF have advised that once this project has reached production stage, they will increase the security to the property.

## 29.8 Diamond Resource and Diamond Reserves Estimate

### 29.8.1 Previous Resource Statements

No previous resource statements have been issued for the Bakerville Project.

### 29.8.2 Volume

The volume of the resources was calculated using the RC drilling results for the runs and using the LDD holes for both the runs and potholes. The volumes were modelled in Surfer® using the extended trapezoidal rule. The resultant volumes are summarised in Table 111.

**Table 111 : Volume Estimation for Bakerville Project**

PROJECT	PROJECT AREA	GRAVEL TYPE	GRAVEL VOLUME (m <sup>3</sup> )
Bakerville	Patsema	Run	2,173,334
	TOTAL/AVE		2,173,334

### 29.8.3 Density

No density measurements are required as all resources are quoted in volumes.

### 29.8.4 Grade

The LDD holes were drilled through the run and into the potholes, in order to determine the grade for the runs. The method used to calculate the grade is a weighted average for the samples. A summary of the grades is shown in Table 112.

**Table 112 : Grade Results for the Bakerville Project**

PROJECT	PROJECT AREA	GRAVEL TYPE	LDD HOLES INCLUDED IN GRADE CALC	WTD AVE GRADE (ct/100m <sup>3</sup> )	CARATS
Bakerville	Patsema	Run	BB06, BB08, BB09, BB010, BB022, BB023, BB014, BB018.	2,173,334	70,008
	TOTAL			2,173,334	70,008

Indicative grades for the surrounding properties were obtained from the surrounding operations owners which were shown to vary between 2cts/100m<sup>3</sup> to 5.5cts/100m<sup>3</sup> for the gravel run material and between 17.5cts/100m<sup>3</sup> and 40cts/100m<sup>3</sup> in the potholes. Venmyn has low confidence in these figures.

### 29.8.5 Diamond Value

No diamonds have been sold for the Bakerville Project as a sufficiently large parcel (at least 2,000cts) has not yet been produced. A total of only 24.2cts have been recovered produced from the Patsema and Geluksdal Project Areas combined. Of the 24.2cts recovered 23.24cts were available at the time of the diamond valuation.

Preliminary estimates of the diamond value for the Bakerville Project have been made using verbal reports of average diamond sales for the areas surrounding the Bakerville project. An average diamond value of between US\$120/ct and US\$180/ct for the smaller stones (<1.0ct) and US\$1,200/ct for the larger stones (>1.0cts) has been communicated by the surrounding operations. Venmyn has low confidence in these values. Diamonds were valued by an independent diamond valuator, Erikson, in January 2008. The results are shown in Table 113.

**Table 113 : Independent Valuation on the Bakerville Project Diamonds**

DATE	GRAVEL TYPE	TOTAL VALUE (US\$)	CARATS	AVE VALUE (US\$/ct)
Jan-08	All	7,210.8	23.24	310

The latest value, as tabulated above, will be utilised in the diamond resource statement.

### 29.8.6 Current Resource Statement

The Diamond Resource statement for the Patsema Project Area, dated 1<sup>st</sup> March 2008, was prepared by Mr. Anton Esterhuizen. This was independently verified by Ms Catherine Telfer of Venmyn. The statement for the Patsema Project Area is shown in Table 114.

All resources are classified as Inferred (Figure 92) due to the low confidence associated with the grade and the lack of a sufficiently large parcel sold in today's market. The logic used in the classification is tabulated in Appendix 6.

**Table 114 : Diamond Resource Statement for the Bakerville Project (1<sup>st</sup> March 2008)**

PROJECT	PROJECT AREA	RESOURCE CLASSIFICATION	GRAVEL VOLUME (m <sup>3</sup> )	REC GRADE (ct/100m <sup>3</sup> )	CARATS	DIAMOND VALUE (US\$/ct)	BOTTOM SCREEN SIZE (mm)
Bakerville	Patsema	Inferred	2,173,000	3.22	69,971	310.28	1.6
	TOTAL/AVE		2,173,000	3.22	69,971	310.28	1.6

There are no known items relating to the environment, permits, legal, title, taxation, socio-economic, marketing, political or any other issue that would have a material effect on the resources identified in the current Diamond Resource statement.

### 29.9 Other Relevant Data and Information

There is no other relevant data or information which should be presented to ensure that this report is not misleading in any way.

### 29.10 Interpretation and Conclusions

In the Bakerville Project two gravel types have been the focus of PDF's exploration, namely the gravel runs and the potholes. The two gravel types were identified using reconnaissance mapping and geophysical survey. These were confirmed by RC drilling.

In the gravel runs, two gravel layers were identified. The potholes, explored thus far, were found to have lower grades and the focus is currently the surface gravels, whilst exploring for more potholes, which may have higher grades. Potholes are being identified on the property on an on-going basis and each one will be evaluated as they are located.

LDD drilling was used to obtain large samples (5m<sup>3</sup> for every metre drilled) which were processed to obtain diamond grade. The LDD holes were drilled into the potholes in both project areas and are believed to show no bias, as it is the top gravel layer which is PDF's focus and this layer is the same layer targeted in the gravel runs. Random surface samples were taken to confirm the grades. A total of 24.2cts have been recovered for the Patsema Project Area.

The information obtained from the exploration drilling allowed for the modelling of the volumes in Surfer®. The modelling of the gravels has indicated favourable conditions for the mining of the runs, as there are well developed gravels with no overburden. The modelling of the potholes showed thick gravels with a thick overburden, however, the LDD drilling identified low grades, thus resulting in unfavourable stripping ratios for the low grades.

**LEGEND:**

- Current Project Area
- Road
- Farm Boundary
- Resource Area

**LOCATION OF DIAMOND RESOURCES FOR THE PATSEMA PROJECT AREA**

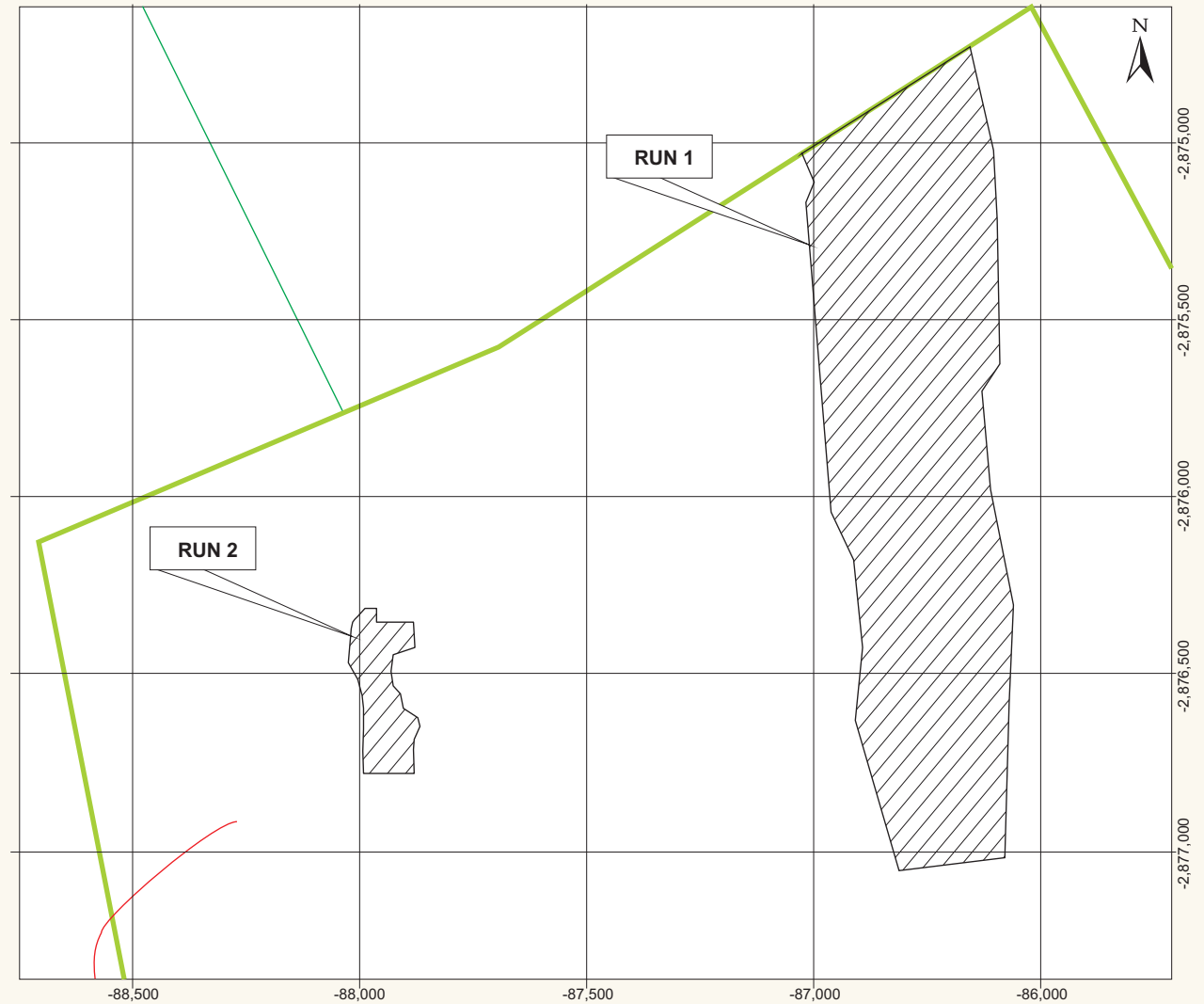
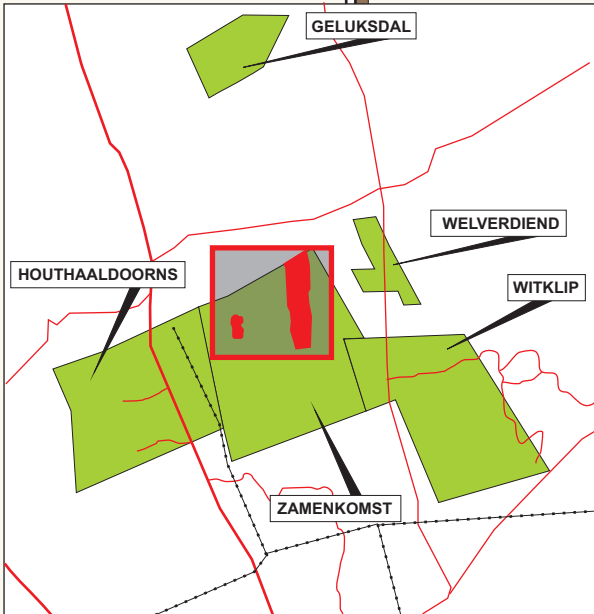

PangeaDFieldsTSX'07Fig92.cdr

Source: Marshall 1987 from  
Diamond Production 1926-1985

SCALE:



This diagram and the information therein are copyrighted. It may not be reproduced or transmitted in any form or by any means without prior written permission from Venmyn Rand (Pty) Ltd. Trading as Venmyn.

PROJECT	PROJECT AREA	RESOURCE CLASSIFICATION	GRAVEL VOLUME (m <sup>3</sup> )	REC GRADE (ct/100m <sup>3</sup> )	CARATS	DIAMOND VALUE (US\$/ct)	BOTTOM SCREEN SIZE CUTOFF
Bakerville	Patsema	Inferred	2,173,000	3.22	69,971	310.28	1.6
		<b>TOTAL/AVE</b>	<b>2,173,000</b>	<b>3.22</b>	<b>69,971</b>	<b>310.28</b>	<b>1.6</b>

The diamond value has been determined as US\$310/ct.

The exploration results have been verified and the methods of modelling independently checked by Venmyn. Venmyn are of the opinion that the results are reliable, where stated, and that density, quantity and quality of the exploration are sufficient to delineate an Inferred Resource for the Patsema Project Area.

### 29.11 Recommendations

The recommended work programme for the South African projects, including the Bakerville Project, is tabulated in Table 122. Venmyn has assisted PDF in the compilation of the work programme and budget in respect of the Bakerville Project and recommends that the company undertake the programme as stated therein. The expected revenues to be derived from the sale of diamonds extracted during exploration pitting, bulk sampling and pilot mining are shown in Table 123.

## 30 BAKERVILLE PROJECT – GELUKSDAL PROJECT AREA

### 30.1 Exploration

The exploration method utilised for the Geluksdal Project Area involved initial reconnaissance work followed by RC and LDD drilling to delineate any gravel runs and potholes and obtain bulk samples.

### 30.2 Reconnaissance

Reconnaissance exploration consisted of the following exploration techniques:-

- surface mapping of the geology on the farm of Geluksdal;
- geophysical surveys. Both airborne magnetics and ground gravity were used, which identified a possible kimberlite target. Once drilling commenced it became evident that the magnetic target was not a kimberlite, but a pothole;
- detailed structural analysis; and
- pattern recognition using satellite imagery.

### 30.3 RC Drilling

#### 30.3.1 Sampling Method and Approach

The RC drilling was completed in the same manner as for the Patsema Project Area, and is detailed in Section 29.3.1. Drilling was initially done on a 100m grid to locate gravels. Where gravels were found, RC Drilling was completed on a 20m grid in order to delineate the extent of the gravel runs and potholes. A total of 36 boreholes was drilled, as shown in Figure 93. The total length of the holes was 1,600m. The location of the drill sites is indicated on Figure 93.

The drill rig description is described in Section 29.3.1.

The holes were numbered sequentially starting at 1, labelled with the prefix GD to indicate Geluksdal. The drilling was continually supervised by the onsite geologist, and the holes were logged and surveyed using a handheld GPS by the same geologist.

#### 30.3.2 Sample Preparation, Analyses and Security

The sample preparation used for Patsema is also applicable to Geluksdal and is discussed in Section 29.3.2.

#### 30.3.3 Data Verification

All results were entered into an Excel database which was checked and verified by the PDF geologist at head office in South Africa, as described in Section 29.3.3. Venmyn has not verified the database in detail but has witnessed the rigorous process of verification which PDF's headoffice geologist undertakes. This being the case, the Qualified Person is satisfied that this process of verification will minimise error in data entry and identify any inconsistencies in the actual sample data and the database entries.



Table 115 : Exploration Work Programme and Costing for all the South African Projects

PROJECT	ITEM	2008			2009			
		Q2 (US\$)	Q3 (US\$)	Q4 (US\$)	Q1 (US\$)	Q2 (US\$)	Q3 (US\$)	Q4 (US\$)
Bakerville	Exploration Expenditure	(237,000)	(237,000)	(237,000)	(237,000)	(237,000)	(237,000)	(237,000)
	Capital Expenditure	(1,000,000)						
	<b>TOTAL</b>	<b>(1,237,000)</b>	<b>(237,000)</b>	<b>(237,000)</b>	<b>(237,000)</b>	<b>(237,000)</b>	<b>(237,000)</b>	<b>(237,000)</b>
	Activity	Trenching systematic; resource delineation; and bulk sampling of trenching material.	Trenching systematic; resource delineation; and bulk sampling of trenching material.	Trenching systematic; resource delineation; and bulk sampling of trenching material.	Trenching systematic; resource delineation; bulk sampling of trenching material; and drilling potholes.	Trenching systematic; resource delineation; bulk sampling of trenching material; and drilling potholes.	Trenching systematic; resource delineation; and bulk sampling of trenching material.	Trenching systematic full scale mining; lan for full mining plant; pilot mining not required.
	Phase	Bulk Sampling	Bulk Sampling	Bulk Sampling	Bulk Sampling	Bulk Sampling	Bulk Sampling	Bulk Sampling
Harts River	Exploration Expenditure	(110,000)	(135,000)	(135,000)	(135,000)	(135,000)	(135,000)	(135,000)
	Capital Expenditure	(1,000,000)						
	<b>TOTAL</b>	<b>(1,110,000)</b>	<b>(135,000)</b>	<b>(135,000)</b>	<b>(135,000)</b>	<b>(135,000)</b>	<b>(135,000)</b>	<b>(135,000)</b>
	Activity	Continue bulk sampling in two blocks.	Continue bulk sampling in two blocks.	Continue bulk sampling in two blocks.	Continue bulk sampling in two blocks.	Continue bulk sampling in two blocks.	Continue bulk sampling in two blocks.	Continue bulk sampling in two blocks.
	Phase	Bulk Sampling	Bulk Sampling	Bulk Sampling	Bulk Sampling	Bulk Sampling	Bulk Sampling	Bulk Sampling
Bloemhof	Exploration Expenditure	(20,000)	(50,000)	(20,000)	(20,000)	(50,000)	(20,000)	(20,000)
	Capital Expenditure							
	<b>TOTAL</b>	<b>(20,000)</b>	<b>(50,000)</b>	<b>(20,000)</b>	<b>(20,000)</b>	<b>(50,000)</b>	<b>(20,000)</b>	<b>(20,000)</b>
	Activity	Contractor bulk sampling.	Contractor bulk sampling; and Pangea drilling.	Contractor bulk sampling.	Contractor bulk sampling.	Contractor bulk sampling; and Pangea drilling.	Contractor bulk sampling.	Contractor bulk sampling.
	Phase	Exploration	Exploration	Bulk Sampling	Bulk Sampling	Bulk Sampling	Bulk Sampling	Bulk Sampling

## Notes

Results of each phase determines whether a project moves into the subsequent phase or if it is terminated.

PDF required to finance all above expenditure, even though their shareholding may be less than 100%.

Exploration and capital expenditure to be funded through capital raising and revenues from diamonds mined and sold from the project.

**Table 116 : Revenue Generation for all the South African Projects**

PROJECT	ITEM	2008			2009			
		Q2 (US\$)	Q3 (US\$)	Q4 (US\$)	Q1 (US\$)	Q2 (US\$)	Q3 (US\$)	Q4 (US\$)
Bakerville	Revenue		50,000	100,000	100,000	100,000	100,000	100,000
Harts River	Revenue							
Bloemhof	Revenue			20,000	20,000	20,000	20,000	20,000
<b>TOTAL</b>		<b>-</b>	<b>50,000</b>	<b>120,000</b>	<b>120,000</b>	<b>120,000</b>	<b>120,000</b>	<b>120,000</b>

## Notes

Revenue to be derived from sale of diamonds extracted from the project during exploration pitting, bulk sampling & pilot mining.

Based upon grades and diamond values as per resource statement where available.

Alternatively based on projected estimates from geological evidence and experience in projects of a similar nature.

**STRATIGRAPHIC COLUMN AND LOCATION OF EXPLORATION ON THE GELUKSDAL PROJECT AREA**

**LEGEND:**

- RC Drillhole
- ⊙ Bauer Drillhole

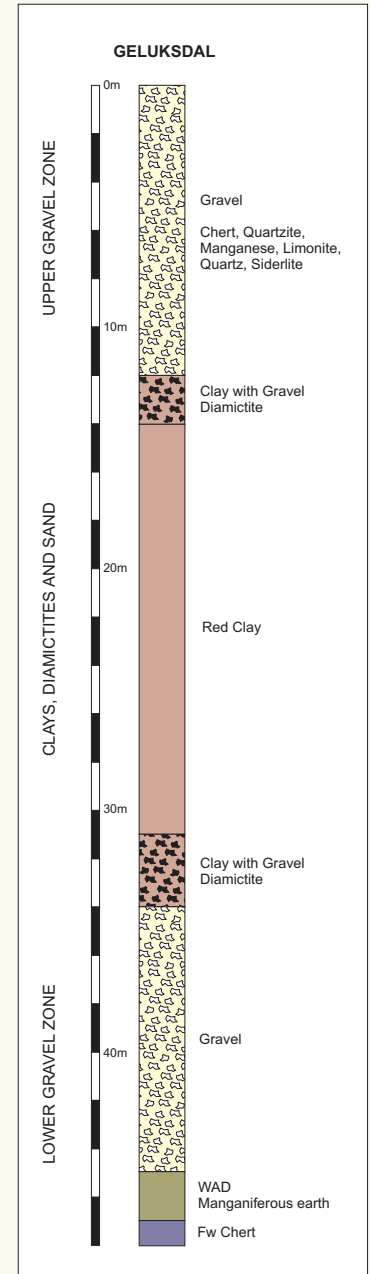
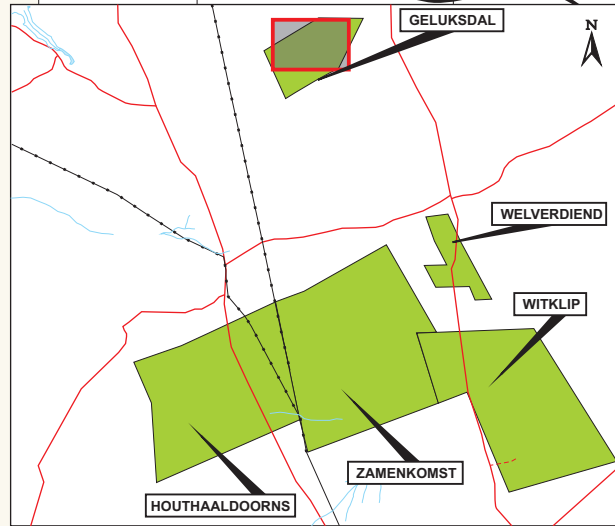
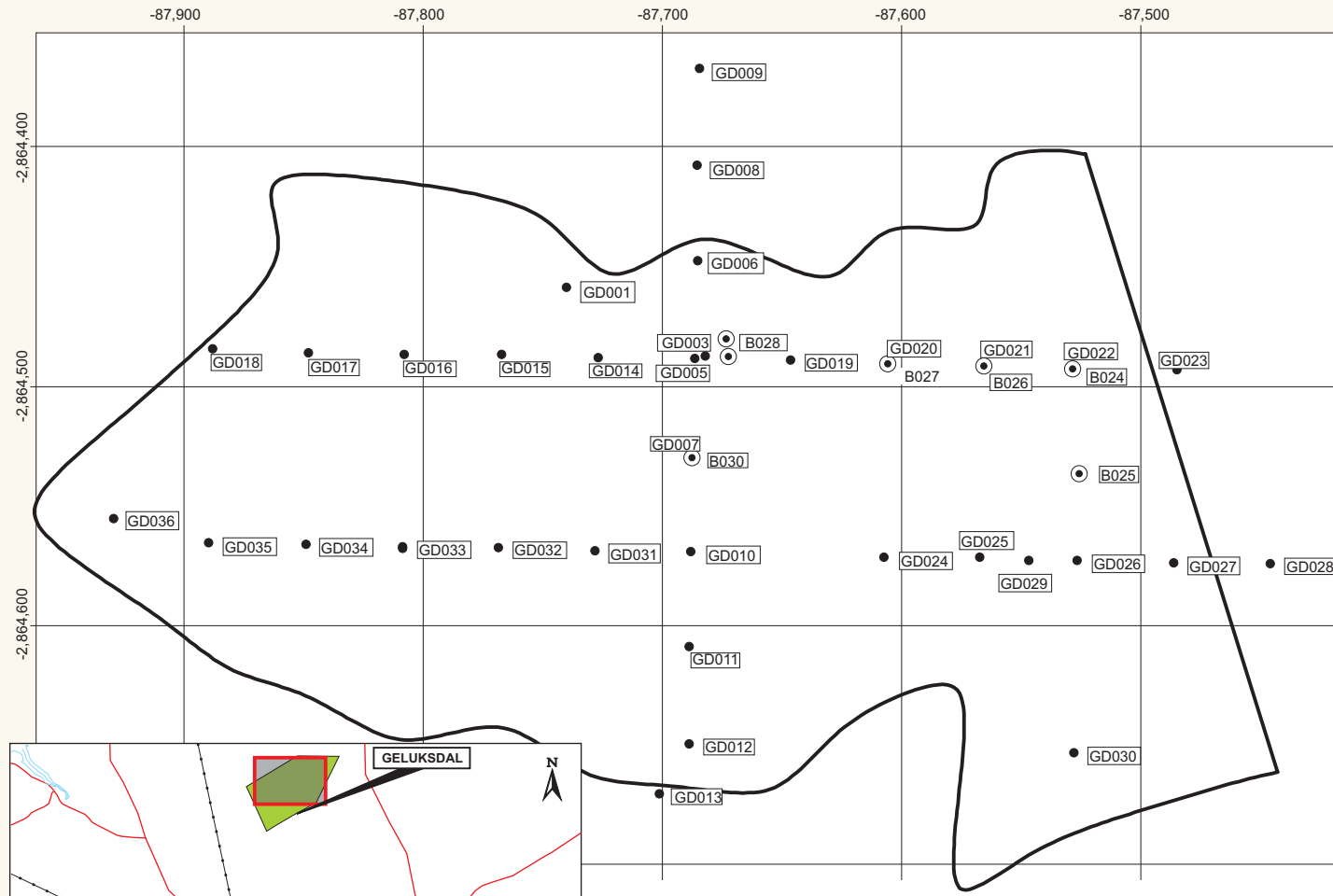

PangeaDFieldsTSX'07Fig93.cdr

Source: Pangea

This diagram and the information therein are copyrighted. It may not be reproduced or transmitted in any form or by any means without prior written permission from Venmyn Rand (Pty) Ltd. Trading as Venmyn.

### 30.3.4 Results

The gravel and overburden thicknesses were modelled using Surfer®, as illustrated in Figure 94. The method used for the modelling in Surfer® is described in Section 29.3.4. Modelling was completed for the pothole.

The summary statistics of the Surfer® modelling is shown in Table 117.

**Table 117 : Summary Statistics for Geluksdal Modelling**

PROJECT AREA	BLOCK	NO. DATA POINTS	GRAVEL THICKNESS (m)			OVERBURDEN THICKNESS (m)		
			MIN	MAX	AVE	MIN	MAX	AVE
Geluksdal	Pothole	23	2.06	43.1	18.68	0	0	0
	<b>TOTAL</b>	<b>23</b>						

The gravel thickness plots (Figure 94) for Geluksdal show a relatively constant thickening of the gravels towards the east with the average thickness of 18.68m across the pothole. This is also shown in Figure 94. There is no overburden for the Geluksdal pothole.

## 30.4 LDD Holes

### 30.4.1 Sampling Method and Approach

LDD holes were used to extract samples from the pothole identified on Geluksdal (Figure 93). These holes were positioned on existing RC drillsites, in order to assess the accuracy of the RC drilling. The width of the LDD holes was 2.50m.

A description of the Bauer drilling rig is provided in Section 29.4.1.

The LDD holes were labelled with the prefix BB to indicate the Bauer Borehole and the labelling was done sequentially, in increments of one, beginning at 24. All LDD holes were surveyed using a handheld GPS by the on site geologist.

The thickness of the top and bottom gravel layers were identified during the RC drilling, which made it easier for separating the layers during the LDD drilling. The top and bottom gravel layers were stockpiled separately on the Zamenkomst Farm at the Patsema Project Area. The stockpiles were labelled using the same procedures as detailed in Section 29.4.1.

### 30.4.2 Sample Preparation, Analyses and Security

A description of the LDD holes sample preparation method is described in Section 29.4.2. Samples were processed through the plant used for the Patsema Project Area which was described in Section 29.7.

As mentioned, the method of sample preparation is adequate. The method of processing is not faultless both with regards to recovery and security, since an open grease belt is used for recovery purposes. However, this may only result in an under estimation of the grade and therefore the results are acceptable to the Qualified Person. PDF have also informed Venmyn that a Flow Sort® x-ray recovery will replace the grease belt recovery.

### 30.4.3 Data Verification

All results were entered into an Excel database which was checked and verified by the PDF geologist at head office in South Africa, as is described in Section 29.3.3.

Venmyn has not verified the database in detail but has witnessed the rigorous process of verification which PDF's headoffice geologist undertakes. This being the case, the Qualified Person is satisfied that this process of verification will minimise error in data entry and identify any inconsistencies in the actual sample data and the database entries.

**CONTOUR PLOT OF GRAVEL THICKNESS MODELLING FOR GELUKSDAL PROJECT AREA**

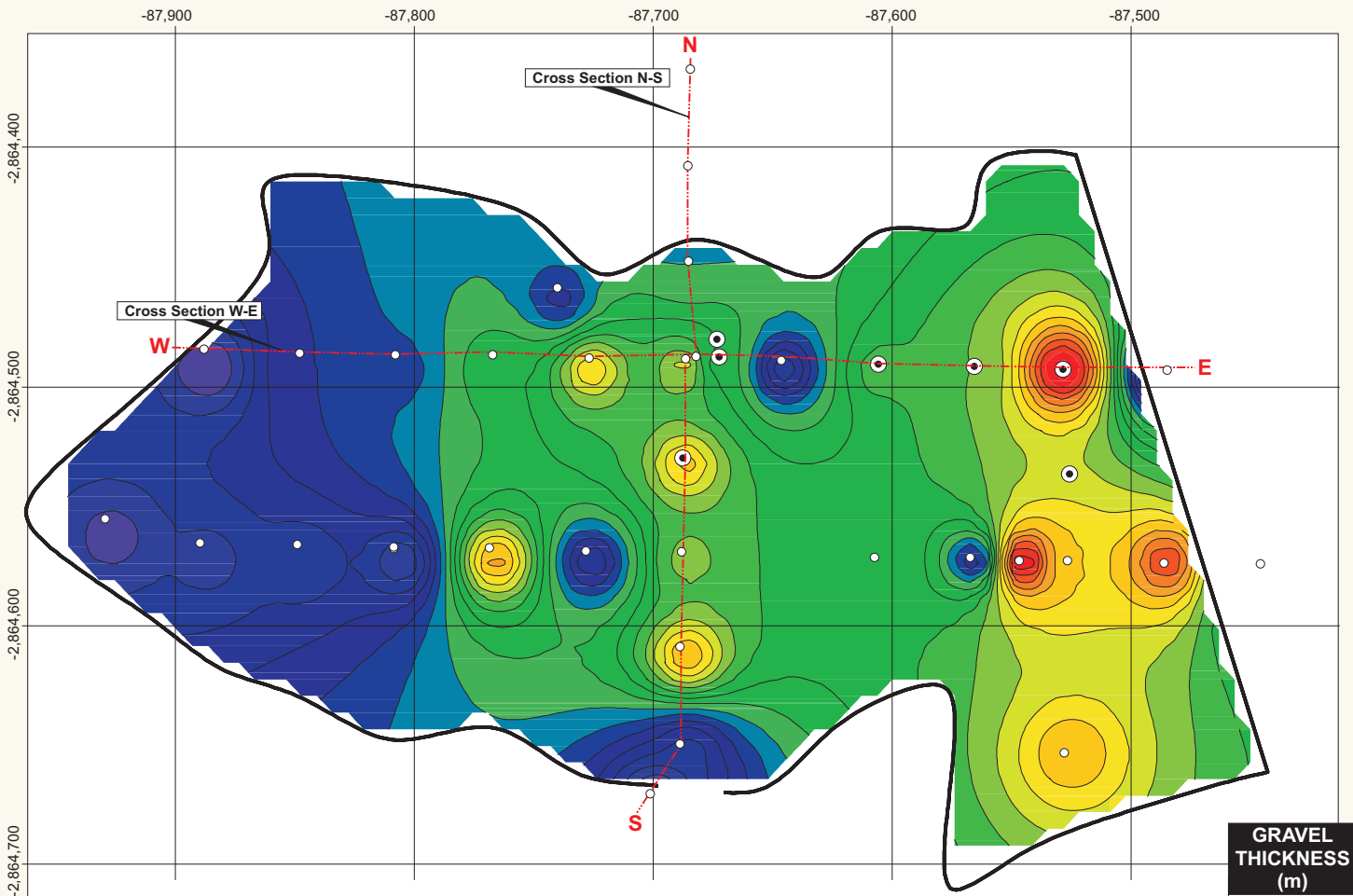

**GRAVEL THICKNESS (m)**

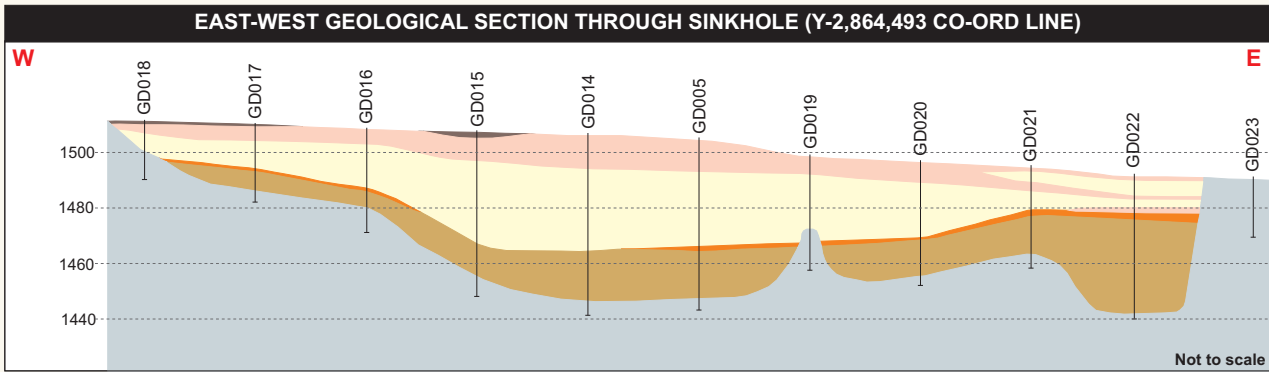
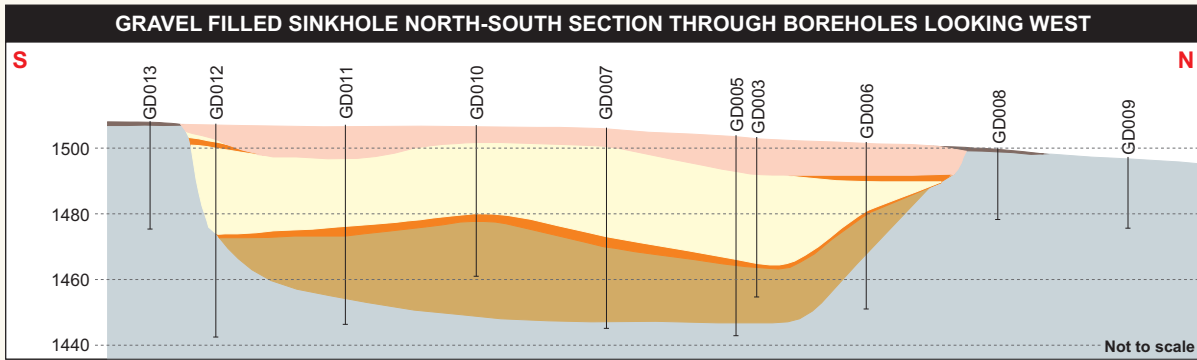
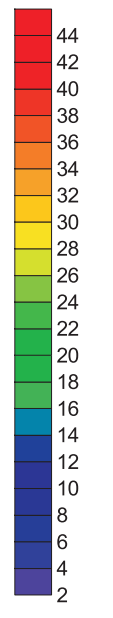

Source: Pangea

**LEGEND:**

- RC Drillhole
- ⊙ Bauer Drillhole
- Dark Brown Soil
- Top Gravel
- Diamictite
- Red Clay
- Bottom Gravel and Clay
- Dolomite and Chert
- ⬮ Drill Delineated Pothole

This diagram and the information therein are copyrighted. It may not be reproduced or transmitted in any form or by any means without prior written permission from Venmyn Rand (Pty) Ltd. Trading as Venmyn.

#### **30.4.4 Results**

Sampling and processing are still in progress. Results were not captured at the time of writing this report; however there is an indication that the results are not encouraging.

#### **30.5 Adjacent Properties**

There is no relevant information available for the adjacent properties.

#### **30.6 Mineral Processing and Metallurgical Testing**

The ore processed from the bulk sampling are considered to be representative of the deposit. The mineral processing plant is described in detail in Section 29.7.

#### **30.7 Diamond Resource and Diamond Reserves Estimate**

No diamond resource statement can be considered until the sample processing has been completed in order to determine the grade.

#### **30.8 Other Relevant Data and Information**

There is no other relevant data or information which should be presented to ensure that this report is not misleading in any way.

#### **30.9 Interpretation and Conclusions**

As with the case for the Patsema Project Area, the exploration in the Geluksdal Project Area was aimed at identifying the kimberlite and subsequently to delineate the pothole and to estimate the associated grades and volumes.

Grade will be determined for the various gravel types from the LDD holes, whilst the RC holes supplied gravel thickness information.

Gravel thickness was modelled in Surfer®. The contour plots identified overall thick gravels for the pothole, especially in the east; however, there are indications that the grade results are not encouraging.

The exploration results have been verified and the methods of modelling independently checked by Venmyn.

#### **30.10 Recommendations**

The recommended work programme for the South African projects, including the Bakerville Project is tabulated in Table 122. The expected revenues to be derived from the sale of diamonds extracted during exploration pitting, bulk sampling and pilot mining are shown in Table 123.

**31 HARTS RIVER PROJECT**

The Harts River Project comprises two project areas situated in the Northern Cape Province of South Africa between Vryburg and Warrenton, namely the Brussels and Pampierstad Project Areas (Figure 95).

**31.1 Property Description and Location**

The Brussels Project Area is located 20km south of Vryburg and stretches for approximately 25 km from north to south. The Pampierstad Project is located 65km north of Warrenton. The farms on which the Project Areas are located are summarised along with the respective areas in Table 118. These project areas are at an advanced exploration stage and cover an area of 34,711ha. The license boundaries are shown in Table 118 and were determined by a professional surveyor, as required by the DME.

**Table 118 : Harts River Project Areas and Boundary Coordinates**

PROJECT NAME	PROJECT AREA	LICENSE TYPE	AREA (km <sup>2</sup> )	AREA (ha)	BOUNDARY COORDINATES LO 25 System (Clarke 1880/Cape) (+X; +Y)
Harts River	Brussels	PR	267	26,674	(2998804.86; 25470.2); (2998439.11; 24773.11); (2998584.31; 24776.54); (2998771; 24723.2); (2999061.94; 24572.73); (2999238.96; 24599.44); (2999776.53; 24786.56); (3002665.73; 24931.29); (3002665.73; 24903.43); (3003021.23; 24941.48); (3004093.19; 27169.31); (2996945.42; 21729.39); (2995082.04; 22181.32);(2994695.94; 21399.72); (2993326.82; 18630.31); (2995045.3; 17705.82); (2995789.02; 19280.65); (2998405.47; 24696.71); (2997783.92; 23505.02); (3001341.3; 21502.64); (3002913.12; 24802.11); (3002666.22; 24799.55); (3002666.22; 24825.98); (2999766.22; 24675.78); (2999256.27; 24511.71); (2999075.18; 24474.7); (2998744.58; 24637.73); (2998586.92; 24681.75); (3006017.54; 32400.82); (3005843.8; 31195.19); (3007552.03; 31252.9); (3007587.43; 29606.77); (3008020.78; 29498.53); (3009036.71; 30190.93); (3009308.62; 30082.86); (3009968.22; 31172.42); (3009632.8; 31309.88); (3008000.39; 31792.96); (3003699.68; 29653.7); (3002875.9; 27902.36); (3004078.14; 27167.24); (3003047.72; 25017); (3003283.14; 25024.73); (3003287.11; 24948.32); (3006601.75; 25624.18); (3007604.68; 27285.45); (3003348.25; 24852.82); (3002982.1; 23106.33); (3003115.72; 20448.92); (3003505.7; 20218.74); (3005418.73; 19074.17); (3006603.45; 21861.3); (3007870.17; 24841.81); (3010628.57; 28218.63); (3010414.8; 27879.34); (3009877.56; 27007.53); (3008810.47; 25234.26); (3009458.96; 25287.78); (3009714.87; 25299.66); (3009875.6; 25323.53); (3010042.18; 25365.22); (3010433.02; 25515.17); (3010643.03; 25587.32); (3010620.75; 25650.76); (3010774.02; 25716.21); (3010805.06; 25655.13); (3011071.49; 25758.88); (3001233.27; 25790.68); (3011500.63; 25795.48); (3012736.46; 25882.83); (3013181.37; 25914.71); (3014129.02; 25943.04); (3015775.01; 26029.18); (3014482.8; 23470); (3015729.14; 22842.89); (3018475.91; 24526.92); (3021518.1; 25192.37); (3016912.22; 28280.72); (3016815.79; 28090.13); (3013649.62; 29388.22); (3012389.93; 27294.14); (3010955.42; 28041.02); (3004187; 30728); (3003690; 29665); (3007588; 27268); (3009276; 30077); (3009039; 30214); (3007977; 29479); (3006598; 25621); (3008377; 24518); (3011875; 30339); (2991322.65; 19718.21); (2991012.55; 18283.34); (2990882.44; 17685.85); (2991241.21; 17483.72); (2991148.75; 17036.08); (2990785.29; 17211.75); (2990715.17; 16887.89); (2990186.26; 14410.46); (2989281.73; 12805.42); (2990349.67; 12063.49); (2991022.53; 10701.17); (2990193.19; 9714.68); (2990958.48; 5385.35); (2991624.73; 4748.15); (2991756.3; 4622.16); (2995069.1; 1479.46); (2996252.22; 3068.88); (2996812.95; 3818.22); (2997434.7; 4669.83); (2995100.71; 7159.98); (2993918.23; 7170.53); (2994920.1; 10254.58); (2994724.77; 10336.4); (2994897.93; 10733); (2995144.58; 11218.73); (2995484.19; 11887.12); (2996718.44; 13339.08); (2997716.67; 14483.75); (2998671.2; 15623.99); (2996083.26; 17114.65); (2992760.57; 17807.86); (2991871.91; 18218.06); (2992461.18; 17224.23); (3067345.18; 35303.76); (3069340.8; 31699.16); (3071274.9; 28215.75); (3079092.36; 29372.36); (3081830.6; 33253.05); (3077276.96; 37976.09); (3075332.9; 33870.87); (3073506.15; 36766.85);
	Pampierstad	PR	80	8,037	
	<b>TOTAL HARTS RIVER</b>			<b>347</b>	<b>34,711</b>

**Pangea DiamondFields plc**

**LEGEND:**

- Farm Boundary
- Main Road
- Other Road
- - - Rail
- River
- Built-up Area

**LOCALITY PLAN FOR HARTS RIVER PROJECT**

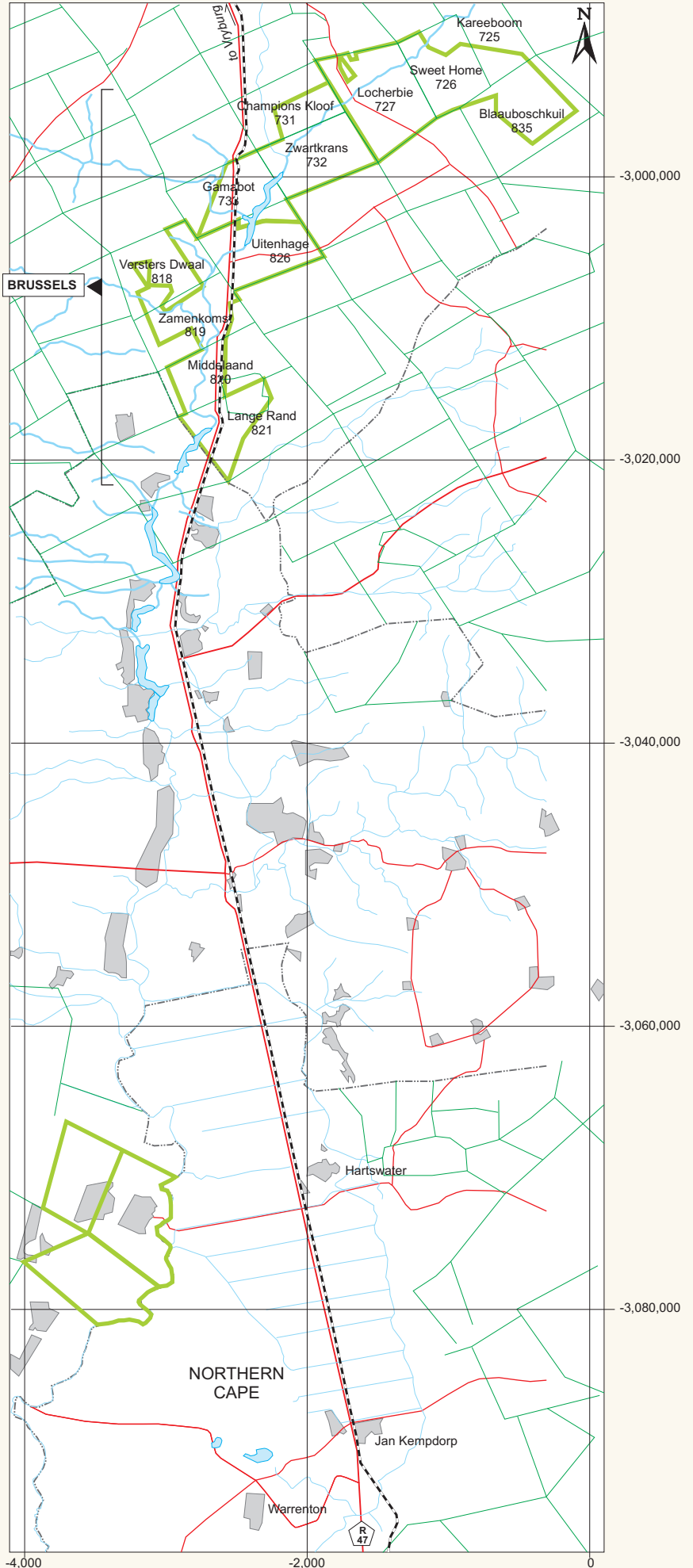
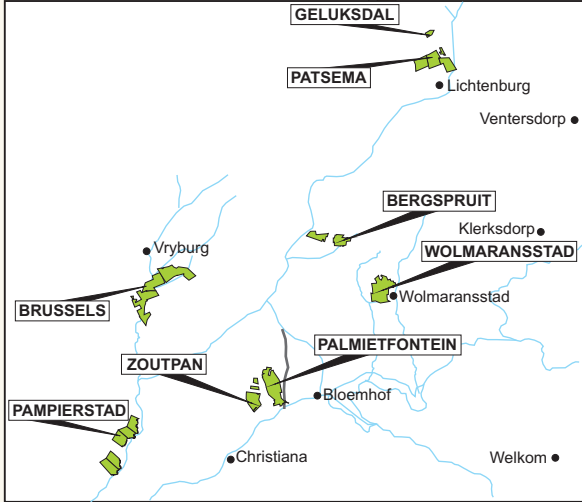

PangeaDiamondFieldsTSX'07Fig95.cdr

Source: South Africa 1:250 000 2724

**SCALE:**



This diagram and the information therein are copyrighted. It may not be reproduced or transmitted in any form or by any means without prior written permission from Venmyn Rand (Pty) Ltd. Trading as Venmyn.



The surface rights owners listed in Table 119 were contacted for permission to carry out exploration activities on their properties.

**Table 119 : Surface Rights Owners for the Harts River Project**

PROJECT AREA	FARM NO.	FARM NAME	PORTION	SURFACE OWNER	TITLE DEED NO.
Brussels	818	Verstersdwaal	1	Roos Johannes Stefanus	T1477/1996
			3*	Breytenbach Stephanus Jacobus	T1442/2000
			4*	Breytenbach Wilhelmina Catharina Jacoba	T1442/2000
			RE*	Veldberg Boerdery (Edms) Bpk	T52/1979
	819	Zamenkomst	RE1*	Samekoms Boerdery (Edms) Bpk	T1071/1985
			5	Sebopedi Moreemedi Alpheus	T1029/1998
			7	Wessels Hendrik Petrus	T2599/2000
			8	Mojanaga Mosakga Isaac	T515/1996
			9	Mahube Farming Trust	T2951/2003
	820	Middelrand	4	Ryst Adriaan Van Der	T964/1996
			6		T964/1996
			9	Tiger Eye Small Holding Cc	T218/1995
			10	W F Van Der Ryst & Seuns Cc	T1516/1989
			11	Ryst Adriaan Van Der	T964/1996
	821	Lange Rand	10	W F Van Der Ryst & Seuns Cc	T1117/2002
	826	Uitenhage	0	Burtleigh Farms Pty Ltd	T1040/2000
			2		T1040/2000
			3*	Holtzhausen Hendrik Gideon	T1253/1988
			5	Burtleigh Farms Pty Ltd	T1040/2000
			9*	Mahube Farming Trust	T2951/2003
			Por of Por 0 (RE)	Burtleigh Farms Pty Ltd	T1040/2000
	733	Gamabot	2 (Burton)	Holtzhausen Martha Hester Petronella	T1253/1988
			3 (Burtleigh)	Burtleigh Farms Pty Ltd	T1040/2000
	732	Zwartkrans	0 (RE)	Holtzhausen Hendrik Gideon	T380/1981
	731	Championskloof	3 (Moria)	Zervas Atha	T534/1988
			6 (RE)		T1267/1986
			7	Barnard Hendrik Petrus	T253/1990
	725	Kareeboomfontein	0 (RE)	Louw Elne	T1341/1987
			3		
	727	Lockerbie	0 (RE)	Webber Hugh Sidney David	T1766/1979
			1 (Niemandslus)	Sedutla Trust	T2469/1999
			4 (Lockten)		
			2 (Klein Plaas)	Haasbroek Maria Magdalena	T293/1979
			3 (Uitspan)	Rensburg Anna Amelia Mathilda Van	T1485/1975
			5 (Eenheid)		
			6	Haasbroek Johan Daniel Klinck	T1510/1973
			7	Webber Hugh Sidney David	T1859/1989
			8 (Spekenham)	Esterhuizen Phillip	T53/1989
			10	Bornman Jacobus Johannes	T756/1981
			12	Gentle Floris Willem Jacobus Steenkamp	T1580/1999
	835	Blaauboschkuil	5 (Dekka)	Jacobs Frederick Daniel	T2920/1994
			10 (Goedgemeen)		
			8 (Goedgenoeg)	Oberholzer Theresa	T477/2001
			9 (Turf Vlakte)	Oberholzer Pieter Zacharias	
			1 (Lot A)	Smithers Kevin Gregory	T579/1992
			3 (Lot C)		
			0 (RE)	Oberholzer Gerhardus Mathys	T653/1987
726	Sweet Home	3 (Sweet Home)	Jager Lourens De	T1221/1975	
		2 (Moria)		T1318/1977	
		4	Strotop Trust	T2752/2000	
Pampierstad North	315	Farm 315	Chief Mothibi	T550/1950	
	316	Farm 316			
	4	Farm 4			

\* 5% of all diamond sales from the property is payable to the surface rights holder

\* ZAR300/ha per annum gratuity is payable to the surface rights owner on any property which has been investigated or exploited

### 31.1.1 Legal Aspects and Tenure

The Harts River Project consists of five PRs issued in names of four companies namely; Blue Dust, Upward Spiral, Huntrex 49 and Soloprop, as indicated in Figure 96. The status of the PR applications is shown in Table 120.

Applications for the Brussels Project Area were applied for through Blue Dust 23 (Pty) Ltd (Blue Dust), which is owned by Ostiprop, which was acquired by PDF in July 2006. Three of the four licences, which comprise the Brussels Project Area, have expired and applications for renewal of the licences were sent to the DME in 2007. There are no foreseeable problems in obtaining the renewals for the Brussels Project Area.

**Table 120 : Legal Rights Pertaining to the Harts River Project**

PROJECT AREA	FARM NAME	PTN NO.	PERMIT NO.	LICENSE HOLDER	AREA (ha)	EXPIRY DATE	EMP APPROVED	REHAB MONIES PAID (ZAR)
Brussels	Versters Dwaal 818 HN	RE,	NW30/5/1/1/2/57 PR	Blue Dust	3,241	Jul 06	Approved	140,000
	Zamenkomst 819 HN	RE 1	NW30/5/1/1/2/99 2 PR		8,073	Jun 07	Approved	20,000
	Versters Dwaal 818 HN	1,3,4						
	Zamenkomst 819 HN	4,5,7-9						
	Middelarend 820 HN	4,6, 9-11						
	Lange Rand 821 HN	10						
	Uitenhage 826 HN	RE,2,3,5						
	Gamabot 733 HN	2,3						
	Zwartkrans 732 HN	RE	NW30/5/1/1/2/11 87 PR	Upward Spiral	6,873	Jan 08	Approved	20,000
	Championskloof 731 HN	RE3,RE6, 7	NW30/5/1/1/2/11 88 PR	Huntrex 46 (Pty) Ltd	8,487	Mar 09	Approved	25,000
	Lockerbie 727 HN	3,5,6,12,R E,7,1,4,2,8 ,10						
	Kareeboomfontein 725 HN	RE,3						
	Blaauboschkuil 835 HN	5,10,RE,1, 3,9,8						
Sweet Home 726 HN	2,3,9							
Pampierstad	Farm 315	RE	Nw 30/5/1/1/2/193 PR	Soloprop	8,037	May 09	Approved	20,000
	Farm 316						Approved	
	Farm 4							
<b>TOTALS</b>					<b>34,711</b>			<b>225,000</b>

Tabacks reviewed the legal status of the Brussels Project Area licences and found the following:-

- the licences are valid, binding and enforceable;
- there are no impediments to prospecting and mining activities relating to the prospecting right;
- the holders of the prospecting rights are in compliance with their obligations under the prospecting rights; and
- PDF has paid all applicable prospecting fees.

The Pampierstad Project Area licences have been executed as of 16 May 2007, however, Tabacks have not had sight of the prospecting work programme nor the environmental plan approved in the respect of area. In order for the approval of a license, the works programme and environmental plan must be approved, therefore the execution of the license suggests that these documents have been approved.

**OWNERSHIP OF HARTS RIVER PROJECT**

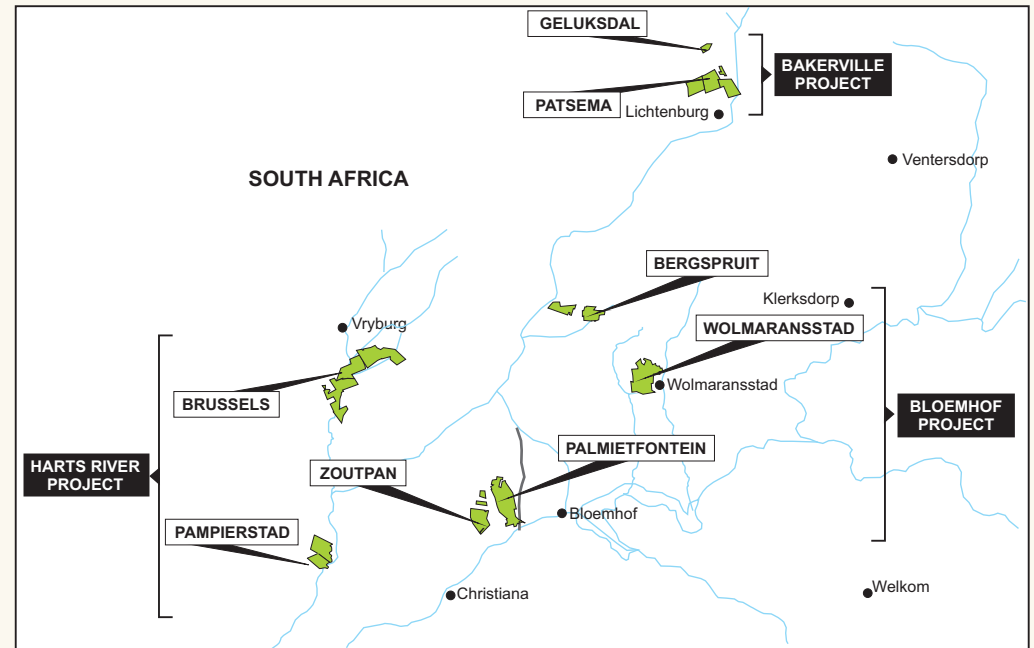
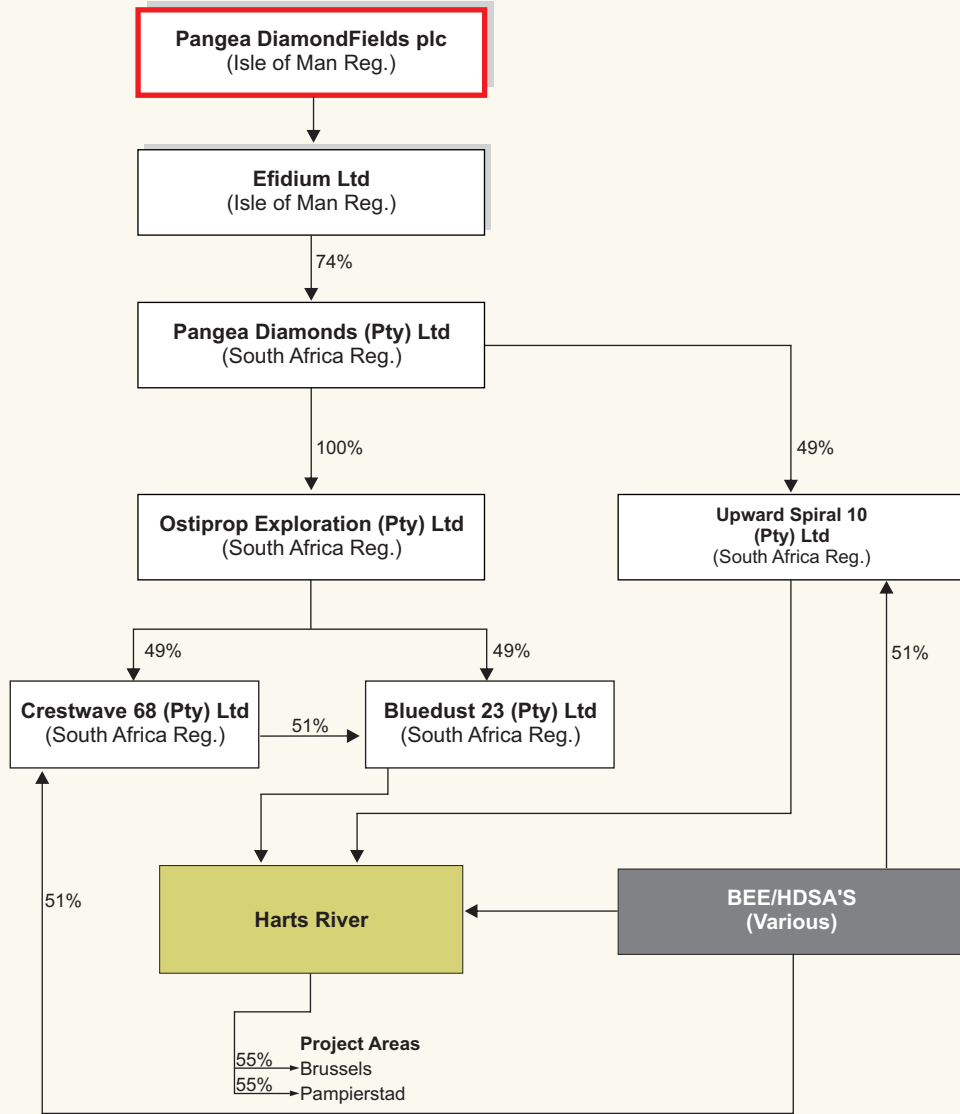

This diagram and the information herein is copyrighted. It may not be reproduced or transmitted in any form or by any means without prior written permission from Venmyn Rand (Pty) Ltd. Trading as Venmyn.

Source: Pangea  
PangeaDFieldsTSX'07Fig96.cdr

Messrs Bekker & Strauss are jointly entitled to subscribe for up to a 5.0% interest in a portion of the Brussels Project Area by funding such project from the Bankable Feasibility stage, failing which they shall be entitled to a 2.5% freecarried interest in such project. Bekker & Strauss are further jointly entitled to a Finders Fee of 2.5% of the value of diamonds produced by the Brussels and Brussels South project.

Viska Delwerye (Viska), a small scale alluvial diamond mining company, was commissioned by PDF to carry out the bulk sampling trenching exercise on the farm of Zamenomst 819 in the Brussels Project Area.

Badenhorst Diamante BK (Badenhorst), also a small scale alluvial diamond mining company was commissioned by PDF to conduct bulk sampling on Gamabot 733, in the Brussels Project Area. The agreement stipulates that Badenhorst is to use two 16ft pans to treat both the upper calcrete and Rooikoppie gravels and receives the proceeds of the sales of the diamonds. Badenhorst is to supply all results obtained from the bulk test mining to PDF. PDF receive a 15% royalty on sales of all diamonds.

### **31.1.2 Royalties, Fees and Taxes**

The Royalties Bill is expected to be instituted in 2009 and in a report published in October 2006; a royalty of 5% was suggested for unpolished diamonds. The South African company tax rate is 30%. VAT of 14% is payable on all local services and purchases.

A royalty of 5% of all diamond sales is payable to the following surface rights holders; SJ Breytenbach, WCJ Breytenbach, Veldberg Boerdery, Samekoms Boerdery, HG Holtzhauzen and Mahube Farming Trust (Table 119). An amount of ZAR300/ha per annum is also payable on any property which has been subject to investigation or exploitation.

### **31.1.3 Impact of the Project on the Environment**

An EMP for prospecting with respect to the Harts River Project has been approved by the DME. An amount of ZAR225,000 has been paid by PDF into an exploration rehabilitation trust fund, as required by the DME, for the rehabilitation of the two project areas, as indicated in Table 120. PDF will ensure that the impact of exploration on the environment is kept to a minimum.

## **31.2 Accessibility, Climate, Local Resources, Infrastructure and Physiography**

### **31.2.1 Locality, Population and Access**

The Harts River Project is located between Vryburg and Warrenton towns in the Northern Cape Province of South Africa (Figure 95). The Northern Cape Province has an estimated population of 823,000 which accounts for approximately 2.3% of South Africa's population.

The access the Harts River Project is via well maintained tarred and farm roads. The Brussels and Pampierstad Project Areas are accessed via the main R49 tarred road, which runs between the two towns Vryburg and Warrenton. A railway line is located adjacent to the main road to access the project areas. Airstrips are located in both Vryburg and Taung.

### **31.2.2 Infrastructure and Local Resources**

The general infrastructure is well established for the Harts River Project and is shown in Figure 96. Water is sourced from a major water pipeline via the Harts Valley Irrigation Scheme which passes through the western portion of the Brussels Project Area. This water is a suitable source for larger scale mining. Water is also obtained from boreholes by the farmers in the area and a cased water borehole has been located in the vicinity of the exploration areas.

Eskom power grids are well developed in the Harts River Project and a powerline is present adjacent to the bulk test mining operation at Brussels Project Area.

The Harts River Project employs 12 people, who are sourced from the local villages. The camp facilities include a caravan, water supply and chemical toilet. Vryburg and Warrenton are in close proximity to the project areas, thus only simple facilities are required on site.

### 31.2.3 Climate and Vegetation

The climate at the Harts River Project has temperatures ranging from a winter minimum of 3°C to a summer maximum of 40°C. The average annual rainfall in the area ranges from 250mm in the south to 450mm in the north.

The vegetation found within the Harts River Project is comprised of fairly dense bushveld which is predominantly composed of shrubs and often small trees. Mixed grasslands are also found in the area of the project.

### 31.2.4 Physiography

The perennial Harts River runs through the Harts River Project valley, surrounded by relatively flat plains. Away from the valley the topography forms a flat topped plateau with an elevation ranging between 1,200m amsl and 1,250m amsl. The drainages feeding the Harts River are small and ephemeral, but were of much greater significance in the past.

## 31.3 History

There is no known historical ownership of the properties held by PDF in the Harts River Project. When PDF applied for the licences in these areas, they were the property of the state.

### 31.3.1 Historical Exploration, Sampling and Production Records

There is evidence of occasional artisanal diggings in the northern regions of the Brussels Project Area within the Rooikoppie gravels. However, there is no information available on this production.

There is no record or evidence of any exploration having previously been done on any of the farms comprising the Harts River Project.

### 31.3.2 Historical Diamond Resource Estimate

No historical diamond resource and diamond reserve estimates were available for the Harts River Project.

## 31.4 Geological Setting

### 31.4.1 Regional Geological Setting

The regional geology of the area is composed of underlying rocks of the Ventersdorp Supergroup, which comprises of mostly volcanics and minor sediments, with a broad region of basement granite and a narrow strip of Kraaipan greenstones trending in a north-south direction through the central regions of the area. The Harts River Project area is bound in the west by the Griqualand West Sequence, dolomite and minor sediments. Small areas include the Karoo Supergroup in the form of Dwyka tillite and shale which are found in the northwestern and eastern portions of the project area. One or another of these rock types forms basement to the alluvial deposits throughout the area.

### 31.4.2 Local and Property Geology

The Brussels Project Area is situated at the upper end of the Dry Harts River valley and the Pampierstad Project Area in the Harts River valley. The Harts River Project is bordered on the east by high ground formed by outcrops of Ventersdorp lavas. The higher ground to the west is underlain by the Griqualand West dolomite sequence. The broad, open Dry Harts valley narrows towards the north and abuts against the Griqualand West dolomites at its northern end. Some remnants of Dwyka tillite are scattered to the north and northeast, along the margins of the higher ground. The Brussels Project Area spans the entire upper portion of the Dry Harts valley. The valley is underlain by calcrete and soil covered calcrete, indicating that this is a very old palaeo-river system.

Large areas of large-boulder Rooikoppie gravel are developed on top of thick calcrete to the north of the Project. Rooikoppie gravels are sheet deposits with a characteristic red colour. These gravels are generally sporadic and thinly developed in this area and have a low tonnage potential. The local geology of the Brussels Area is illustrated in Figure 97.

**GEOLOGY OF THE BRUSSELS AREA**

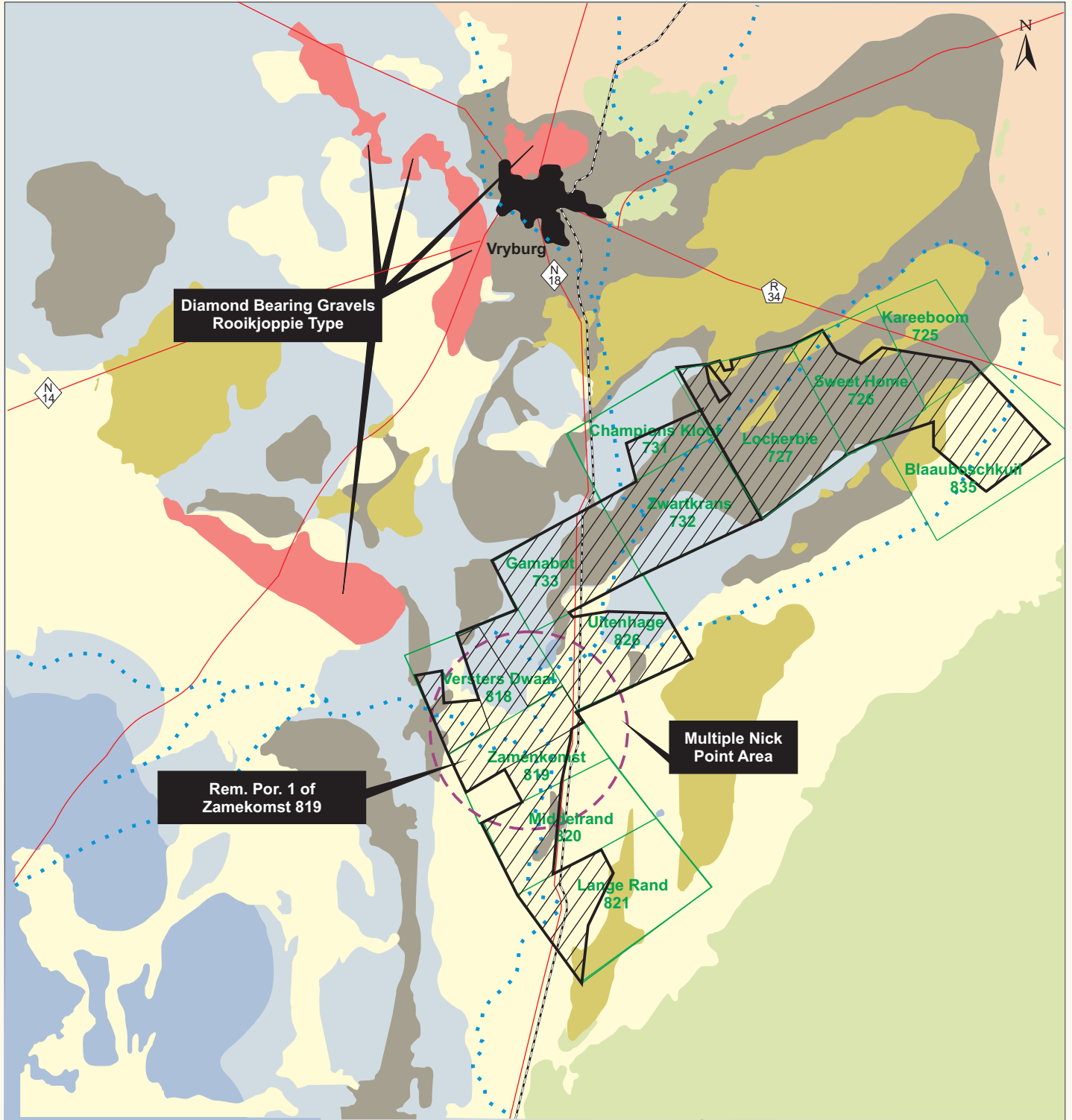

PangeaDFieldsTSX'07Fig97.cdr

**LEGEND:**

**SCALE:** 2.5 0 2.5 5 km

- Farm Boundary
- Main Drainage
- Diamond Bearing Gravels
- National Route
- Arterial Route
- Road
- Prospecting Right
- Railway
- Project Area
- Kalahari Sands
- Dolomite
- Dolomite with Shale
- Quartzite, sandstone, shale
- Shale
- Basaltic Lava

This diagram and the information therein are copyrighted. It may not be reproduced or transmitted in any form or by any means without prior written permission from Venmyn Rand (Pty) Ltd. Trading as Venmyn.

### 31.5 Deposit Type

The Harts River Project comprises secondary diamond deposits, occurring alongside the Dry Harts River. The deposit can be described as a palaeo-channel deposit and the model for the project is shown in Figure 98. The alluvial gravels and upper calcrete deposits are shown in Figure 99.

### 31.6 Mineralization

The gravel composition in the Brussels Project Area consists of large boulders of Ventersdorp lavas and dolomite with smaller boulders of quartzite and black chert. Finer interstitial material, ranging in size from pebble to coarse river sand is primarily composed of lava, dolomite, black chert, agate, vein quartz and occasional banded iron formation (BIF).

The larger boulders sometimes exhibit ice-facetting, indicating Dwyka derivation. It is thought that proximal (Dwyka) and more distal (diamond-bearing) derivation leads to the bimodality of the package.

The lower unit has a yellow-brown calcretised matrix, and is clearly much older than the overlying unit. The weakly calcretised gravel is generally very coarse grained, poorly sorted, and appears to be bimodal in clast size distribution, comprising large boulders of Ventersdorp lava and dolomite, with smaller boulders of quartzite, black chert and occasional angular clasts of shale. The matrix of the gravel ranges in size from pebbles to coarse sand, and is composed of lava, dolomite, quartzite, vein quartz, agate and BIF.

The floor of the gravels is extremely uneven and varies between Ventersdorp lavas, Dwyka shales, tillite and occasional dolerite. The uneven surface of the gravel floor shows potential for trapsites in the form of potholes which could have increased diamond grades. The upper layer of gravels in the deposit has also been proven to be the richest layer in both the channels and the river potholes and is the main focus of PDF.

The source of the diamonds is currently unknown.

A stratigraphic column for the Brussels and Pampierstad Project Areas is shown in Figure 99.

## 32 HARTS RIVER PROJECT – BRUSSELS PROJECT AREA

### 32.1 Exploration

The exploration programme within the Brussels Project Area commenced in November 2005 and was aimed at locating old palaeo-channels of the Dry Harts River, preferably with a long strike length and a preserved large catchment area. These targets were generally situated areas where younger present day drainage activity is minimal (or preferably absent) and are normally covered with a calcrete layer.

The exploration method utilised for the Harts River Project involved systematic phases of drilling and sampling to delineate and quantify the deposit. The exploration programme involved the following:-

- percussion drilling to delineate the lateral extent of the palaeo-gravel channels and upper calcrete gravels as well as to determine their vertical extent;
- exploration pits to determine the grade; and
- bulk sampling to obtain a sufficiently large parcel of diamonds to determine the economic prospects of the project.

### 32.2 Percussion Drilling

Percussion drilling commenced in 2005 and was utilised in order to identify the extent, both laterally and vertically, of the deep channel gravels and the upper calcrete gravels.

#### 32.2.1 Sampling Method and Approach

The initial phase of exploration entailed percussion drilling on a 100m grid. This was carried out to locate the deep channel gravels and the upper calcrete gravels.

**LEGEND:**

- Youngest soil and clay channel fill covering gravel
- Intermediate slightly calcretised soil and clay channel fill covering gravel
- Oldest calcrete channel fill covering gravel
- Unconsolidated youngest fine to medium gravel
- Intermediate slightly calcretised medium to coarse gravel
- Oldest Calcretised coarse gravel (Target Gravel)
- Basement to gravel (Ventersdorp, Griqualand West and Dwyka Tillite)

**GEOLOGICAL MODEL FOR THE HARTS RIVER PROJECT**

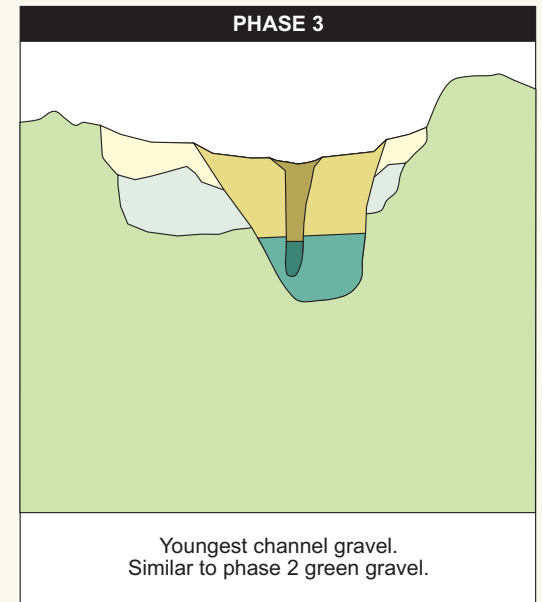
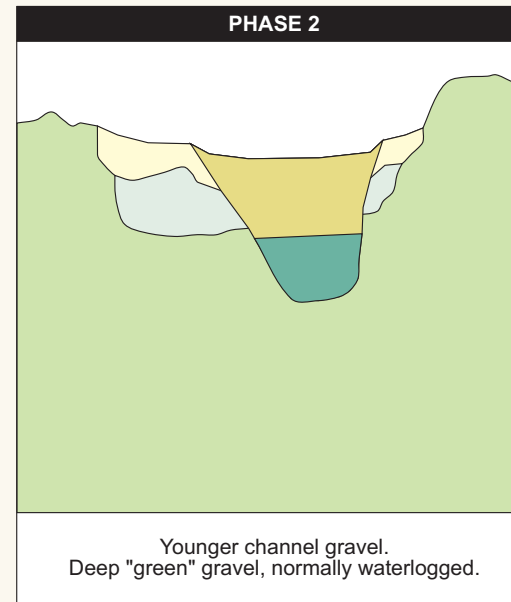
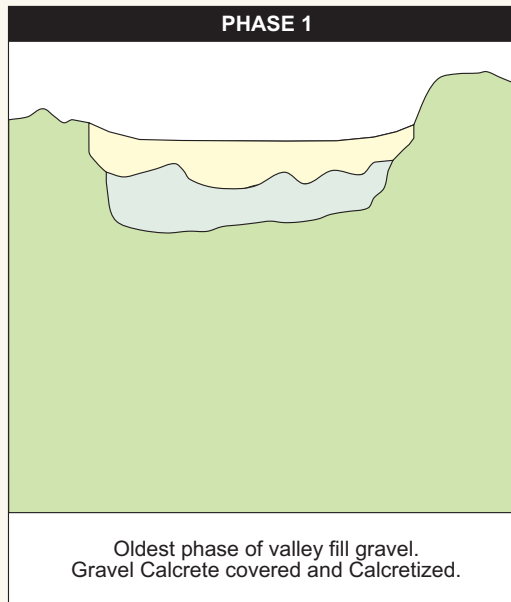
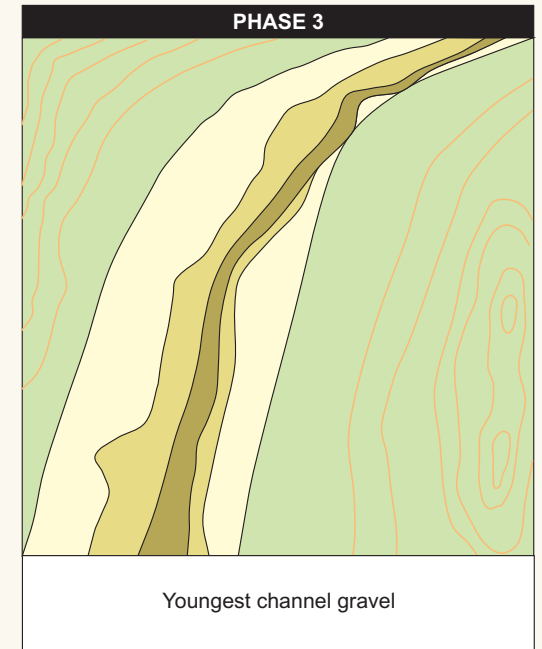
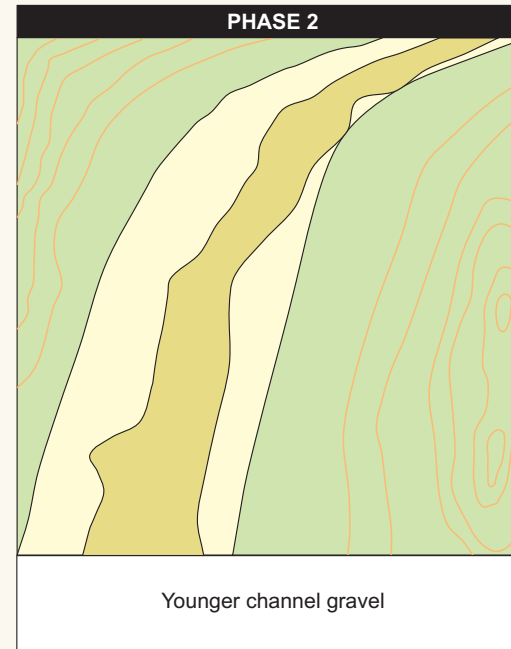
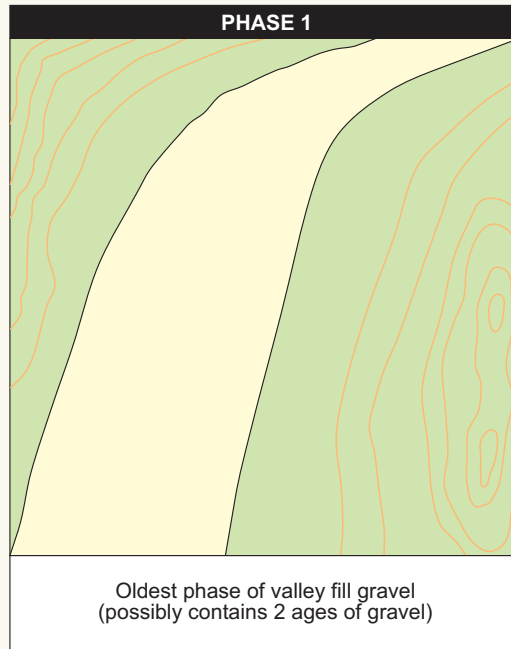

PangeaDFieldsTSX'07Fig98.cdr

Source: Pangea

This diagram and the information therein are copyrighted. It may not be reproduced or transmitted in any form or by any means without prior written permission from Venmyn Rand (Pty) Ltd. Trading as Venmyn.



**DEEP CHANNEL GRAVELS AND SHALLOW CALCRETE GRAVELS OF THE BRUSSELS PROJECT AREA**

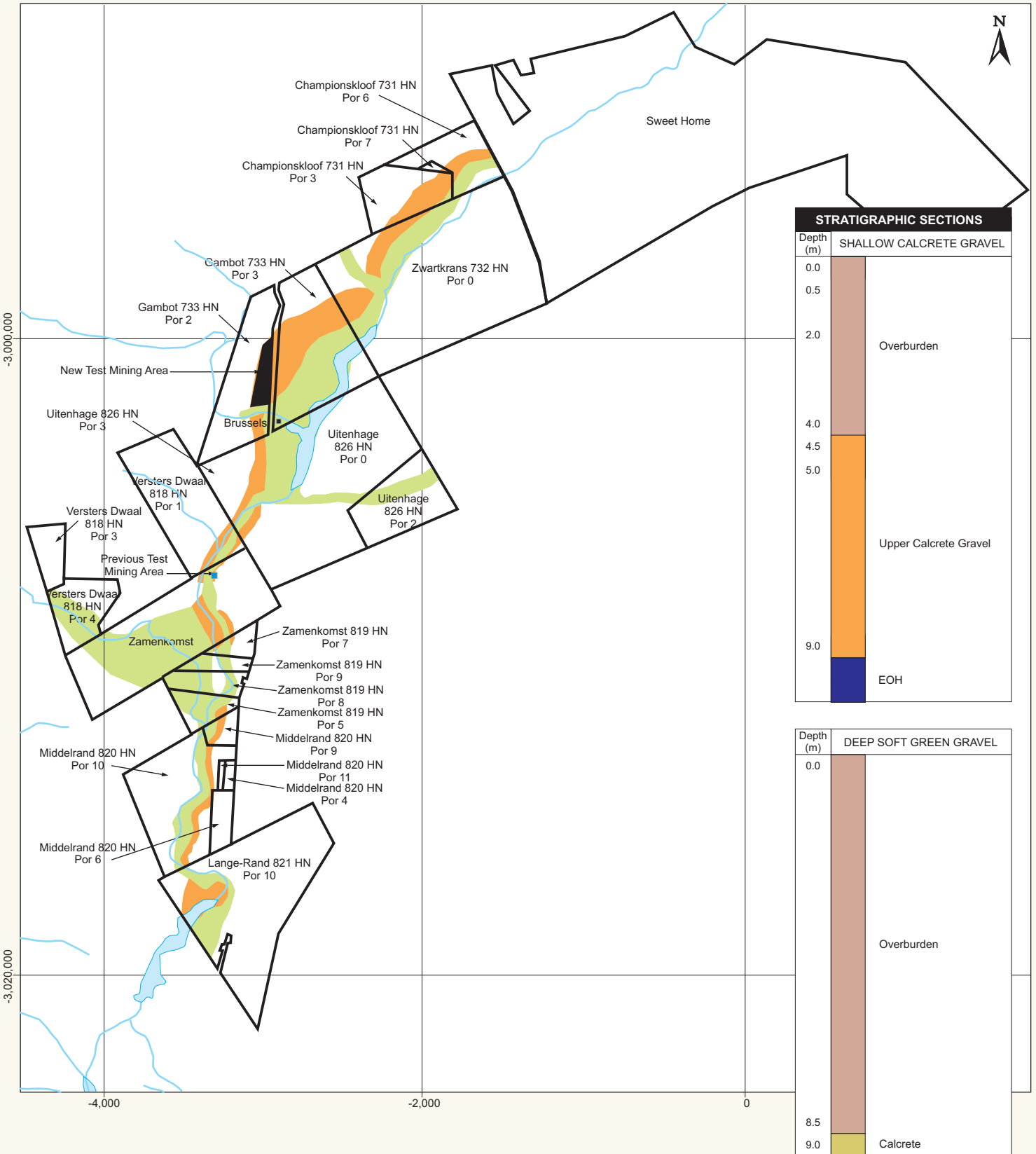

Source: Pangea

**LEGEND:**

- Upper Calcrete Gravel
- Deep Channel Gravel

**SCALE:**



This diagram and the information therein are copyrighted. It may not be reproduced or transmitted in any form or by any means without prior written permission from Venmyn Rand (Pty) Ltd. Trading as Venmyn.

The percussion drill used for the Harts River and Bloemhof Projects, used 16.5cm thick tungsten rods. The cuttings which are blown up the rod were collected at surface. The maximum depth reached by the percussion drill was 21m. The samples were collected in 0.5m intervals and laid in small heaps on the ground where the on-site geologist logged the borehole number, heap characteristics and the depth of each heap. The boreholes were numbered sequentially beginning at 1, using a prefix of Z which indicates the farm Zamenkomst 819.

The geology and lithological characteristics were described on hand written logsheets. In some cases the heaps were photographed. The collar elevations of the drill holes were surveyed by the on site geologist using a handheld GPS.

A total of 283 percussion drill holes was drilled on the Brussels Project Area, where 222 holes were positioned on RE of Ptn 1 of Zamenkomst 819 HN, 13 were positioned on Ptn 7 of Zamenkomst 819 and 48 on Gamabot 733 and Uitenhage 826.

The current percussion drilling is shown in Figure 100 and Figure 101. Drill holes varied in depth from 3m to 21m and the diameter of the holes were 16.5cm. All holes intersected the bedrock.

The samples were logged by hand on site by the geologist on logsheets and later digitally captured. These logs were then sent to senior geologists from PDF.

### 32.2.2 Sample Preparation, Analyses and Security

No samples from the percussion drilling were stored.

### 32.2.3 Data Verification

The database of results was checked by PDF at their head office in South Africa, whereby the data is verified by checking random samples in the database. Senior geologists from PDF also conduct spot checks onsite, where random checks are conducted on the logging. The checks compared well with the original logging.

Venmyn has not verified the database in detail but has witnessed the rigorous process of verification which PDF's headoffice geologist undertakes. The Qualified Person is satisfied that this process of verification will minimise error in data entry and identify any inconsistencies in the actual sample data and the database entries.

### 32.2.4 Results

The deep channel gravels and the upper calcrete gravels were delineated for the Brussels Project Area (Figure 100).

The percussion drilling results were used to contour the thickness and overburden of the gravels and are shown in Figure 102. The summary statistics for the modelling is shown in Table 121.

The thicknesses were modelled in Surfer® by gridding the data using an inverse distance squared method of estimation. All data points were used in the estimation, since no search radius was used. No search radius was used in order to obtain overall accurate thicknesses values for the Brussels Project Area. Modelling was completed for the deep channel gravels on Zamenkomst 819 and for the upper calcrete gravels on Zamenkomst 819, Gamabot 733 and Uitenhage 826 together.

**Table 121 : Summary Statistics for the Brussels Modelling**

PROJECT AREA	BLOCK	GRAVEL TYPE	NO. DATA POINTS	GRAVEL THICKNESS (m)			OVERBURDEN THICKNESS (m)		
				MIN	MAX	AVE	MIN	MAX	AVE
Brussels	Zamenkomst – Gamabot	Upper Calcrete	141	0.77	6.84	3.14	1.59	7.82	4.65
	Zamenkomst	Deep Channel	160	0.38	8.37	2.92	0.93	11.53	6.89
		<b>TOTAL</b>	<b>301</b>						

**LOCATION OF PERCUSSION DRILLING ON ZAMENKOMST 819, BRUSSELS PROJECT AREA**

**LEGEND:**

- No Gravel
- Shallow Calcrete Gravel
- Deep Channel Gravel
- Mined Out Area
- Gravel Block
- Percussion Drillhole with Gravel
- Percussion Drillhole with no Gravel
- Old Pit with Gravel

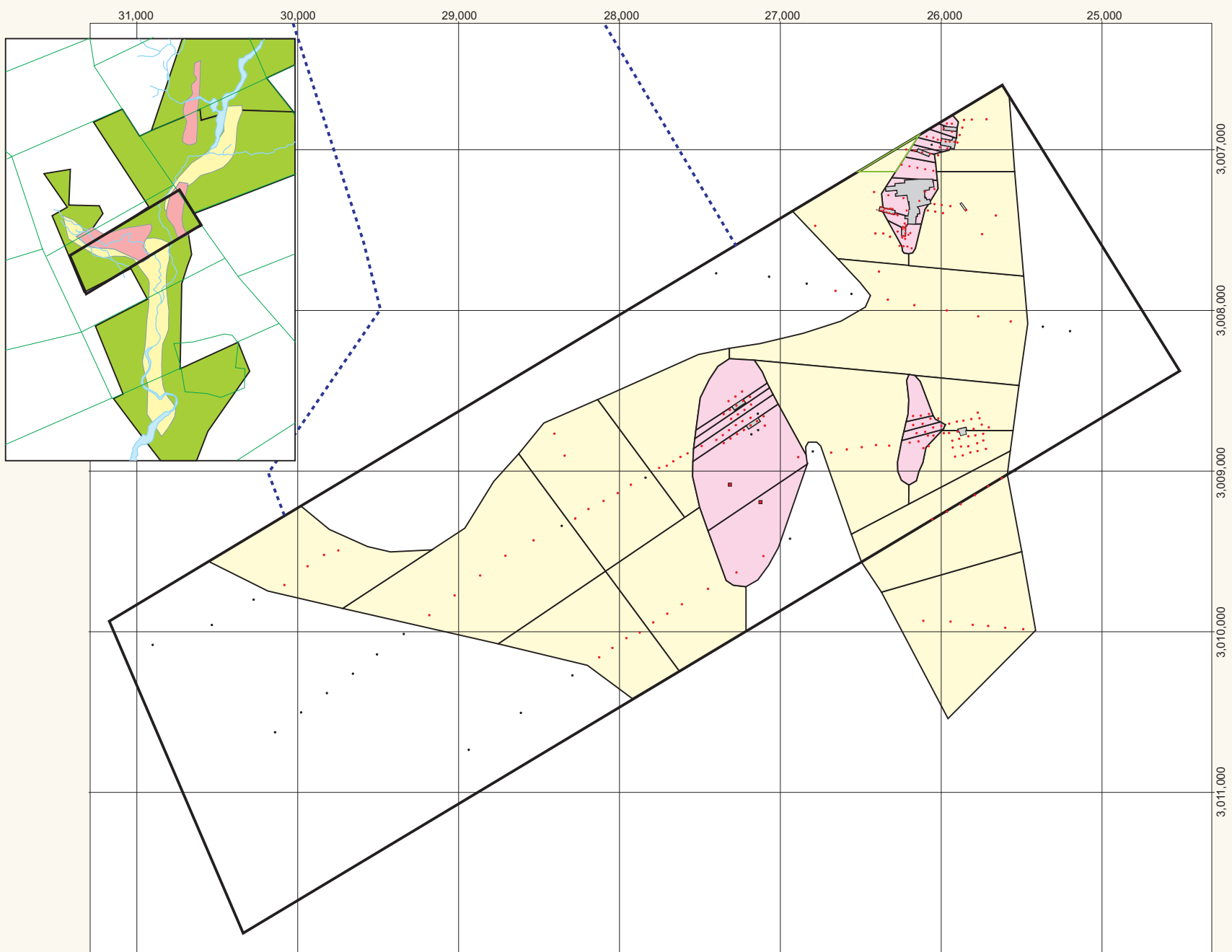

PangeaDFieldsTSX'07Fig100.cdr

Source: Pangea

**SCALE:**



This diagram and the information therein are copyrighted. It may not be reproduced or transmitted in any form or by any means without prior written permission from Venmyn Rand (Pty) Ltd. Trading as Venmyn.

**LEGEND:**

- Interpreted outline of Shallow Calcrete Gravel
- Interpreted outline of Deep Channel Gravel
- Interpreted outline of Young Channel Gravel
- Percussion Drillhole

**LOCATION OF PERCUSSION DRILLING ON GAMABOT 733 AND UITENHAGE 826, BRUSSELS PROJECT AREA**

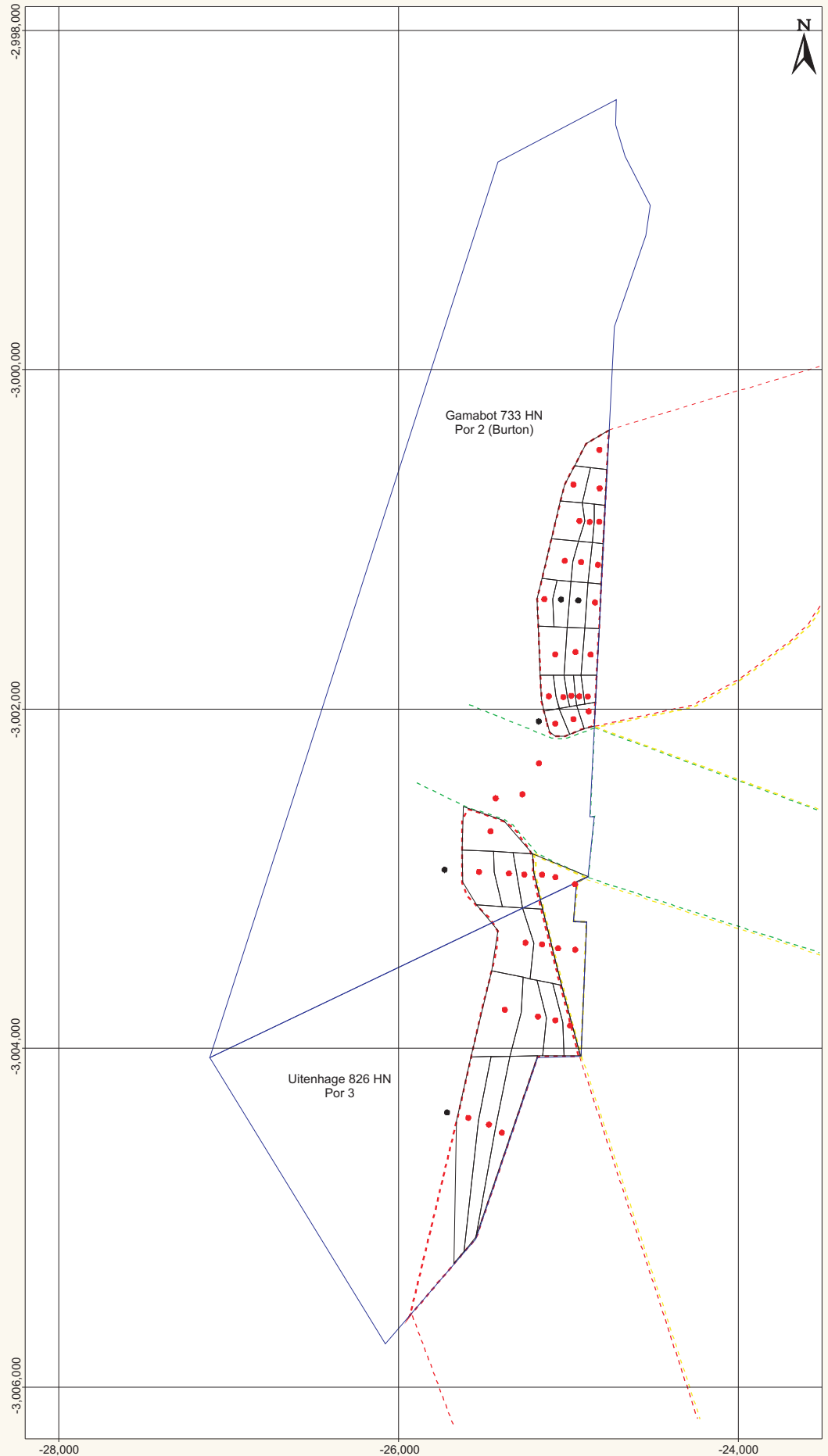

Source: Pangea

This diagram and the information therein are copyrighted. It may not be reproduced or transmitted in any form or by any means without prior written permission from Venmyn Rand (Pty) Ltd. Trading as Venmyn.

**CONTOUR PLOTS OF GRAVEL AND OVERBURDEN THICKNESSES FOR THE SHALLOW CLACRETE GRAVELS ON ZAMENKOMST 819, GAMABOT 733 AND UITENHAGE 826**

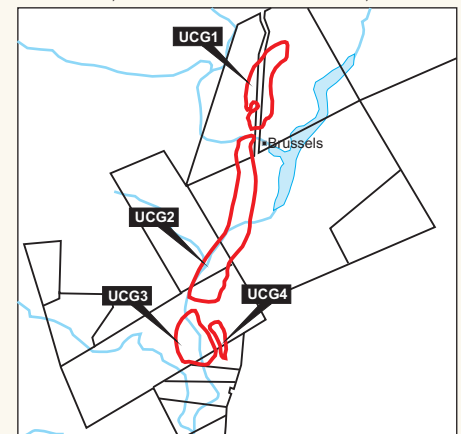
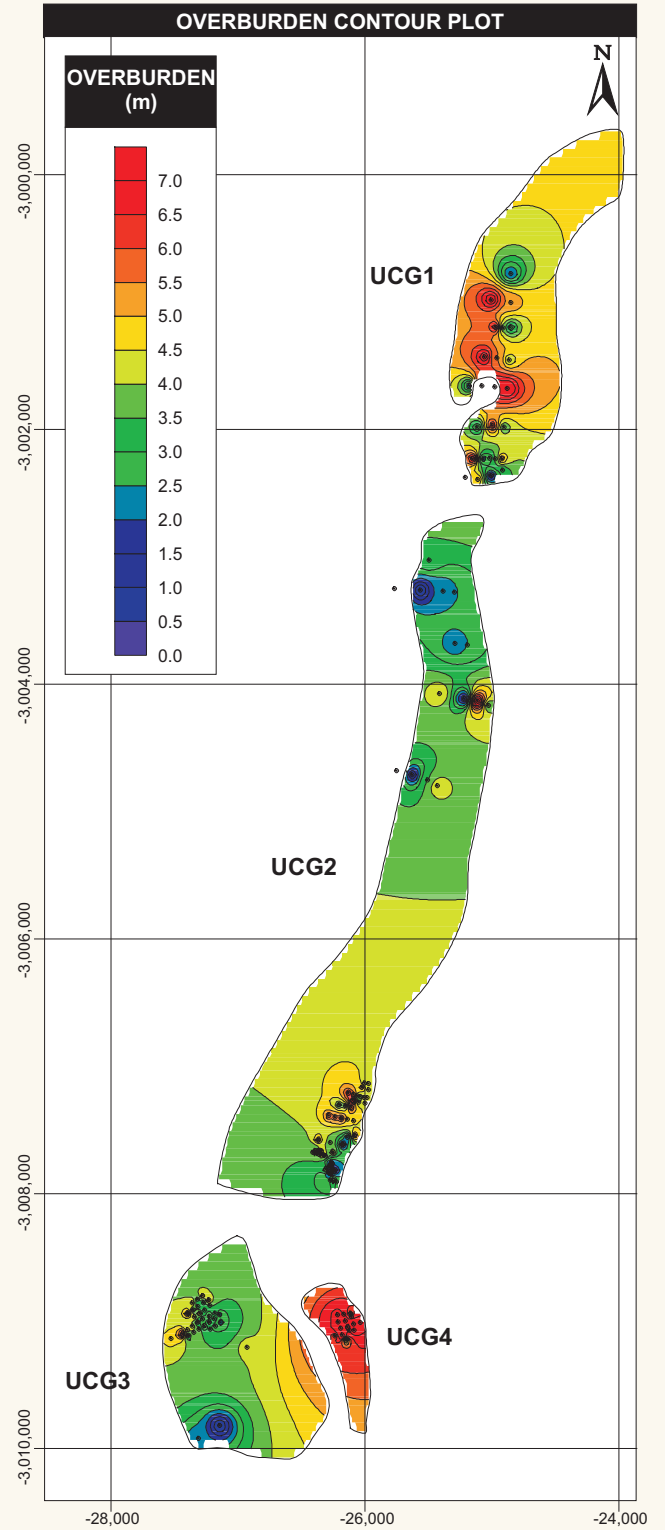
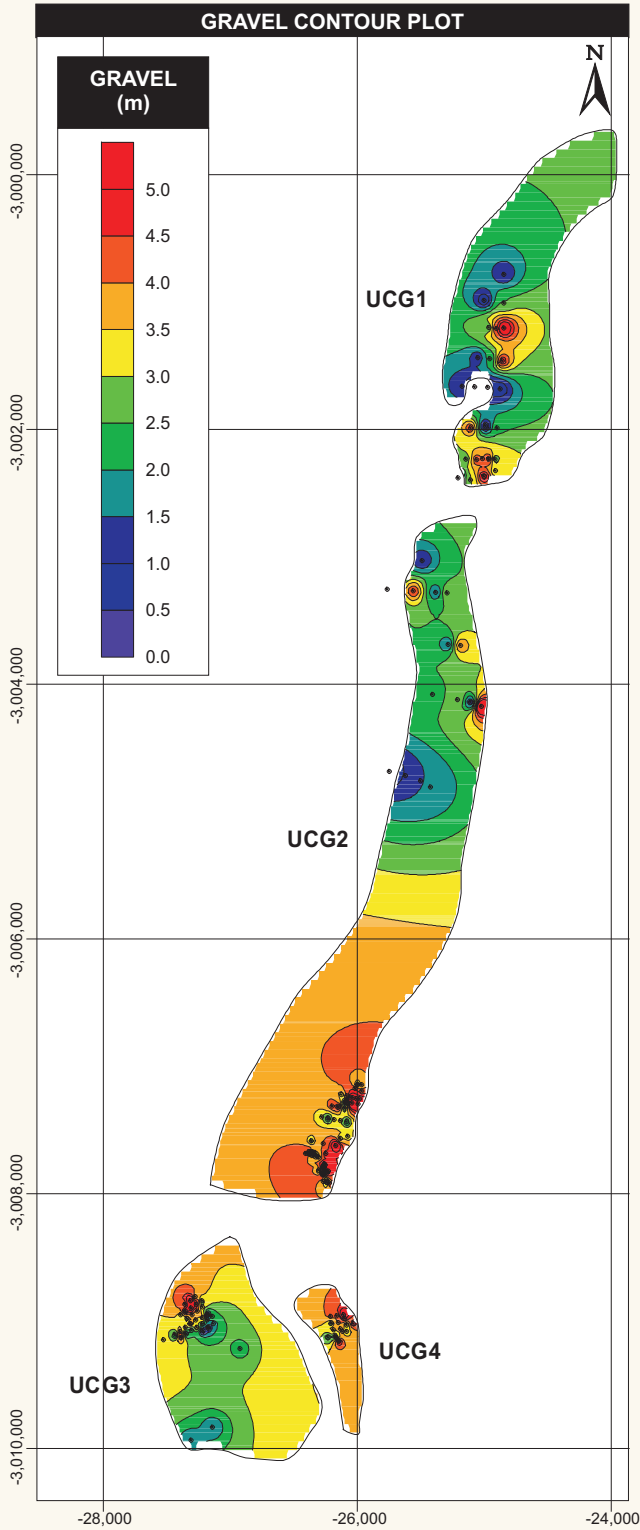

PangeaDFieldsTSX'07Fig102.cdr

Source: Pangea

This diagram and the information therein are copyrighted. It may not be reproduced or transmitted in any form or by any means without prior written permission from Venmyn Rand (Pty) Ltd. Trading as Venmyn.

The deep channel gravel package on Zamenkomst 819 (Figure 103) varies from 0.5m and 9.5m, with an average thickness of 2.5m across the area. The thickest gravels are located in the far southeast. The overburden plots show that the thickest in the west and in the same area as the thickest gravels in the southeast, with an average thickness of 9m across the region.

The modelling of the upper calcrete gravels on Zamenkomst 819 and Gamabot 733 show a relatively constant thickening towards the south, with the northern blocks ranging from 1m to 3.5m and the southern blocks ranging from 3.5m to 4m. The overburden for this area, shows thicker overburden in the extreme northern and southern blocks ranging from 3m to 6.5m, whereas the central blocks range from 2m to 4m.

### **32.3 Viska Bulk Sampling**

In October 2005 bulk sampling commenced in order to determine the grade for Zamenkomst 819.

#### **32.3.1 Sampling Method and Approach**

Bulk sampling commenced with the excavation of 26 trenches on the farm Zamenkomst 819 (Figure 104). The trenches were 60m x 20m x 6m in size and sited according to the percussion drilling in areas where gravels were delineated. The trenches were drilled and blasted to loosen the calcrete gravels and then excavated using a 40t excavator. The trenches were excavated to a depth of approximately 6m, when the solid footwall was reached. Volumes for each pit were calculated inside the pit by subtracting the measured stripping depth of the top and the bottom of the gravel and multiplying this value by the trench length and width. The trenches were numbered sequentially and named using the prefix A, which represents the Viska samples. The entire trench was processed as a bulk sample.

The results were supplied by Viska to PDF.

The positions of the trenches were surveyed by PDF using a GPS. A PDF geologist was stationed on site to monitor the bulk sampling programme.

#### **32.3.2 Sample Preparation, Analyses and Security**

The samples were transported directly to plant and treated through the Viska pan plant discussed in Section 32.7.

The method of sample preparation is adequate. The method of processing using a pan plant and final recovery through a through a double Flowsort® and over a grease belt is good. The final hand sorting is open to security risks; however, the Qualified Person has a high degree of confidence in the results, since the results would only indicate an under-estimation of the grade.

#### **32.3.3 Data Verification**

The database of results was verified by PDF using the method described in Section 32.2.3.

Venmyn has not verified the database in detail but has witnessed the rigorous process of verification which PDF's headoffice geologist undertakes. This being the case, the Qualified Person is satisfied that this process of verification will minimise error in data entry and identify any inconsistencies in the actual sample data and the database entries.

#### **32.3.4 Results**

The results of the 26 exploration trenches are detailed in Table 122. The exploration pitting produced a total of 942 stones with a weight of 951.66 carats. The average stone size was 1.01cts, with ten large stones being recovered namely; 10.28cts, 10.48cts, 10.6cts, 11.36cts, 12.13cts, 16.54cts, 16.65cts, 19.73cts, 24.29cts and 60.21cts.

**CONTOUR PLOTS OF GRAVEL AND OVERBURDEN THICKNESSES FOR THE DEEP CHANNEL GRAVELS ON ZAMENKOMST 819**

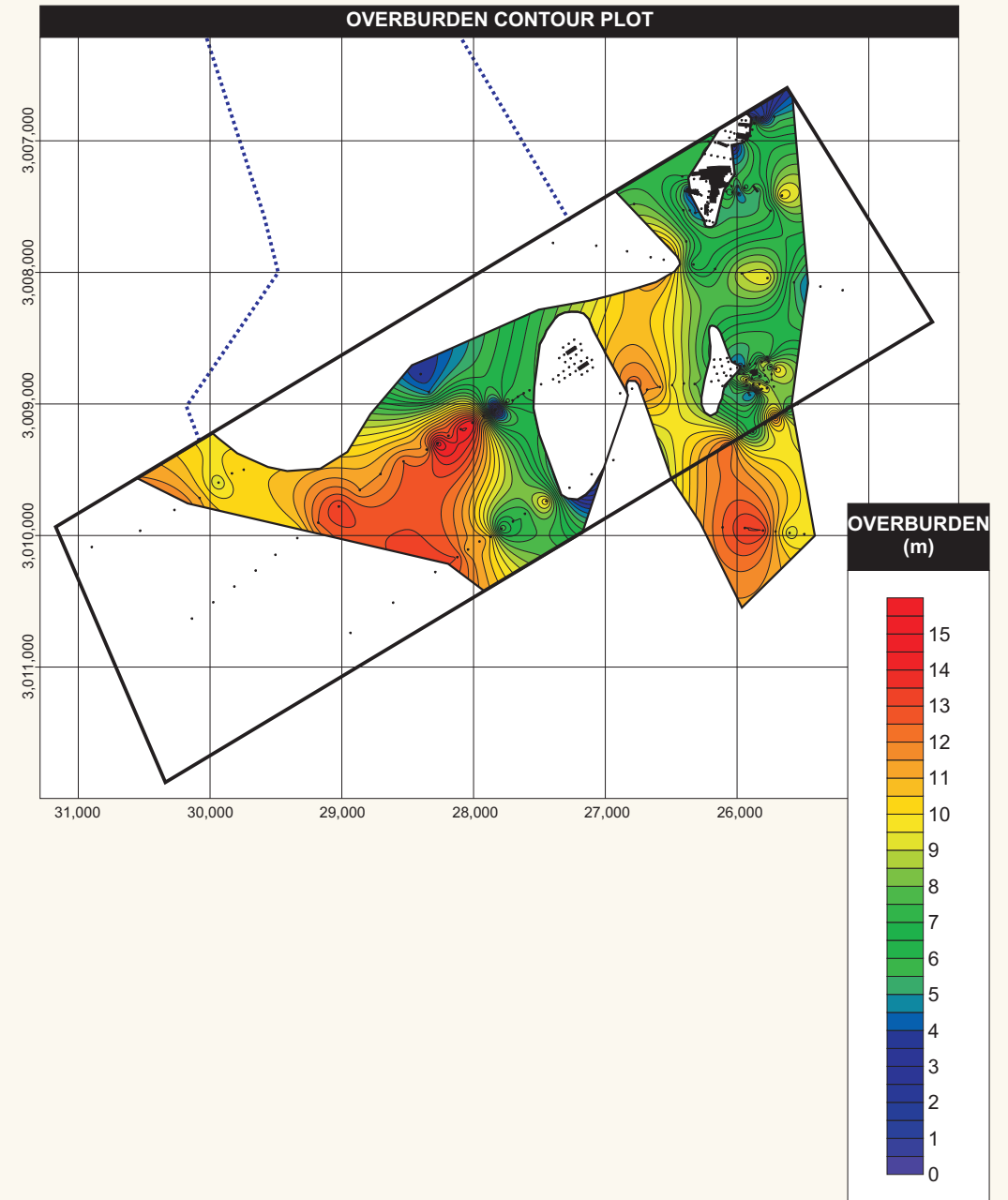
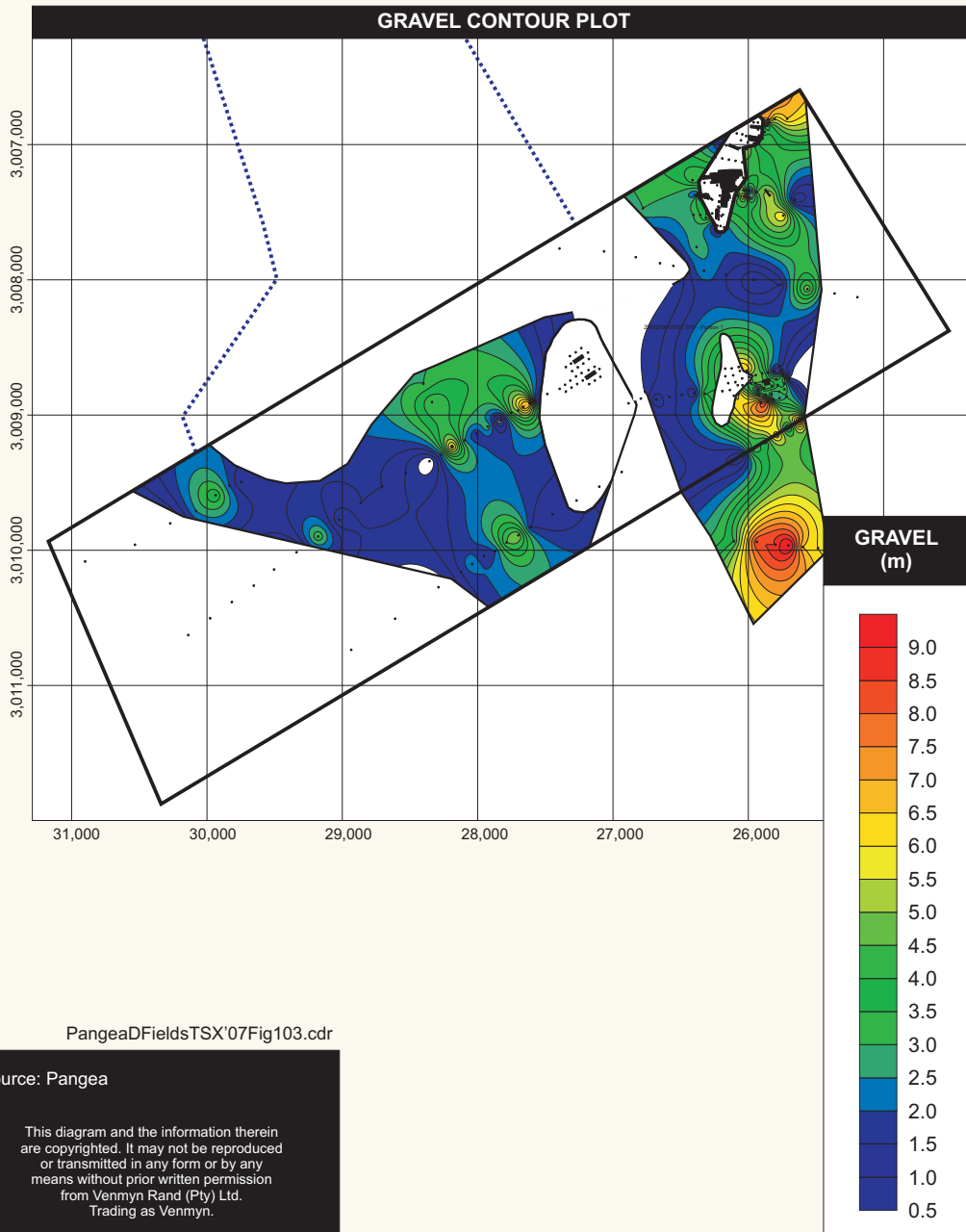

PangeaDFieldsTSX'07Fig103.cdr

Source: Pangea

This diagram and the information therein are copyrighted. It may not be reproduced or transmitted in any form or by any means without prior written permission from Venmyn Rand (Pty) Ltd. Trading as Venmyn.

**LOCATION OF BULK SAMPLE AT THE BRUSSELS PROJECT AREA**

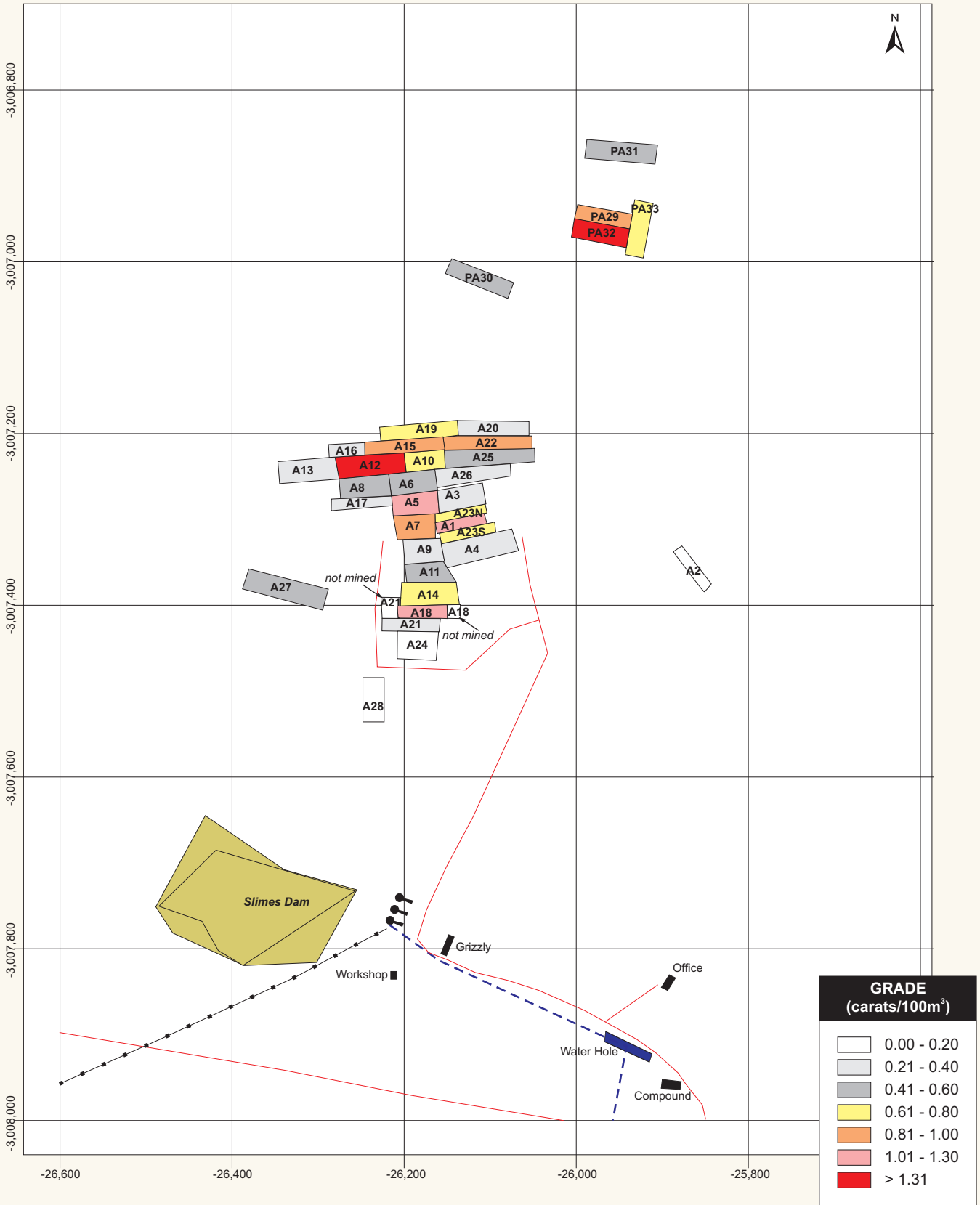

Source: Pangea

This diagram and the information therein are copyrighted. It may not be reproduced or transmitted in any form or by any means without prior written permission from Venmyn Rand (Pty) Ltd. Trading as Venmyn.

**SCALE:**



**LEGEND:**

- Road
- - - Power Line
- - - Water Pipeline
- Structures



**Table 122 : Viska Bulk Sampling Results for the Brussels Project Area**

SAMPLE NO.	GRAVEL TYPE	O/B THICK (m)	GRAVEL THICK (m)	GRAVEL VOLUME (m <sup>3</sup> )	CARATS	NO. STONES	GRADE (ct/100m <sup>3</sup> )	STONE SIZE (ct/stone)	BOTTOM SCREEN SIZE (mm)
A1	Coarse Calcrete	2.50	6.19	3,319.91	35.45	22.00	1.07	1.61	2.0
A2	Green Gravel	5.48	5.30	3,223.39	4.95	7.00	0.15	0.71	2.0
A3	Coarse Calcrete	3.06	6.05	9,241.83	21.68	23.00	0.23	0.94	2.0
A4	Coarse Calcrete	2.91	8.28	12,794.64	43.88	45.00	0.34	0.98	2.0
A5	Coarse Calcrete	3.20	5.84	6,621.38	68.28	43.00	1.03	1.59	2.0
A6	Coarse Calcrete	3.20	5.35	6,225.66	27.64	36.00	0.44	0.77	2.0
A7	Coarse Calcrete	3.80	4.13	5,275.83	46.13	36.00	0.87	1.28	2.0
A8	Coarse Calcrete	4.16	4.19	4,553.25	19.12	17.00	0.42	1.12	2.0
A9	Coarse Calcrete	3.24	6.11	6,074.74	13.36	22.00	0.22	0.61	2.0
A10	Coarse Calcrete	3.40	6.07	5,771.08	41.48	34.00	0.72	1.22	2.0
A11	Coarse Calcrete	2.78	6.26	8,367.31	46.36	47.00	0.55	0.99	2.0
A12	Coarse Calcrete	4.10	4.15	7,534.99	107.64	47.00	1.43	2.29	2.0
A13	Coarse Calcrete	3.60	5.35	6,774.95	20.46	30.00	0.30	0.68	2.0
A14	Coarse Calcrete	3.40	5.72	10,215.65	62.40	46.00	0.61	1.36	2.0
A15	Coarse Calcrete	4.93	2.85	4,260.57	39.17	35.00	0.92	1.12	2.0
A16	Coarse Calcrete	4.50	3.78	2,688.61	7.96	10.00	0.30	0.80	2.0
A17	Coarse Calcrete	3.50	4.12	4,089.65	9.95	21.00	0.24	0.47	2.0
A18	Coarse Calcrete	3.80	5.24	4,760.72	58.65	58.00	1.23	1.01	2.0
A19	Coarse Calcrete	4.20	4.93	7,645.62	50.63	66.00	0.66	0.77	2.0
A20	Coarse Calcrete	4.30	4.84	7,034.89	23.30	34.00	0.33	0.69	2.0
A21	Coarse Calcrete	4.10	4.77	4,709.43	18.52	27.00	0.39	0.69	2.0
A22	Coarse Calcrete	4.85	3.98	7,526.33	66.38	76.00	0.88	0.87	2.0
A23 Top	Coarse Calcrete	2.91	1.30	3,058.56	7.15	3.00	0.23	2.38	2.0
A23 Bottom	Green Gravel	4.58	4.24	4,978.44	34.61	43.00	0.70	0.80	2.0
A24	Coarse Calcrete	4.20	5.18	7,595.66	14.34	31.00	0.19	0.46	2.0
A25	Coarse Calcrete	5.22	3.58	8,359.16	44.49	56.00	0.53	0.79	2.0
A26	Coarse Calcrete	5.22	3.58	5,047.83	17.68	27.00	0.35	0.65	2.0
<b>TOTAL/AVE</b>		<b>3.82</b>	<b>5.15</b>	<b>167,750.08</b>	<b>951.66</b>	<b>942.00</b>	<b>0.57</b>	<b>1.01</b>	<b>2.0</b>

A total of 1130.13cts was recovered for the Viska and PDF bulk sampling combined on Zamenkomst 819, including the deep channel and calcrete gravels in the Brussels Project Area by January 2008.

The size distribution of the diamonds is shown in Figure 105. The normal distribution, typically exhibited by diamond deposits, is not illustrated in the graph. This would suggest that insufficient diamonds have been extracted to obtain a typical distribution. As a result the reliability of the grade and associated diamond value estimates would have a low confidence.

A SFD has been plotted for all diamonds recovered as shown in Figure 106. The typical sigmoidal diamond distribution curve is not evident, which again alludes to the fact that the size of the sample is too small and that the confidence in the results will be low. There may also be an insufficient representation of the smaller stones, which may be cemented in the calcrete layer and discarded as oversize. The SFD does show, however, that a larger proportion of the stones are greater than 8cts in size which should ensure a high average diamond price.

**Figure 105 : Brussels Project Area Size Distribution Chart**

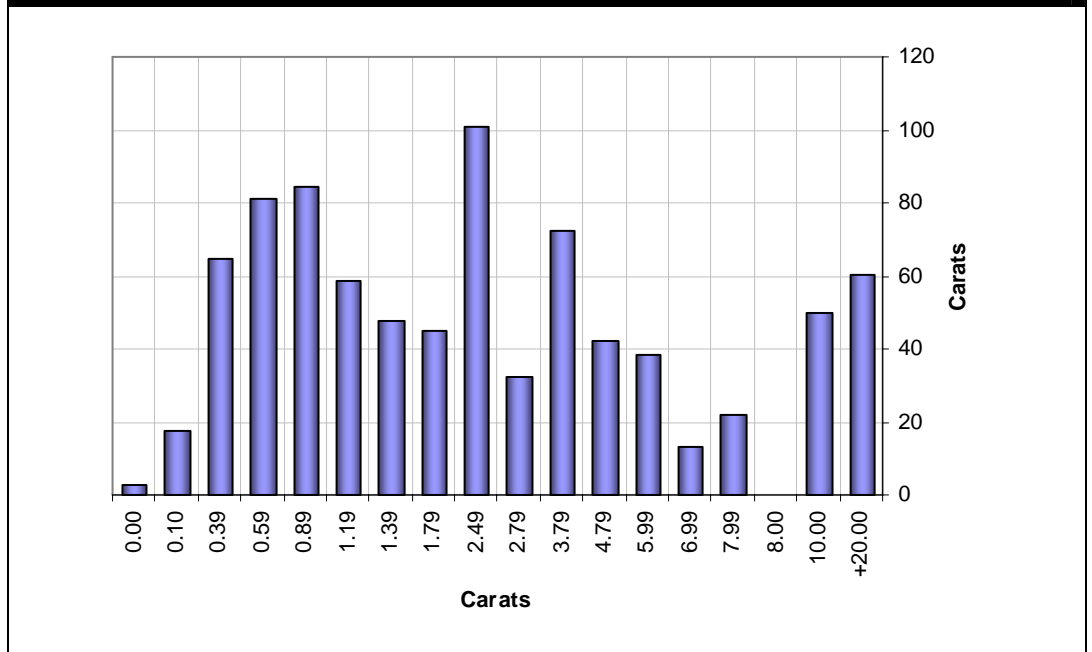

**Figure 106 : Brussels Project Area Cumulative SFD**

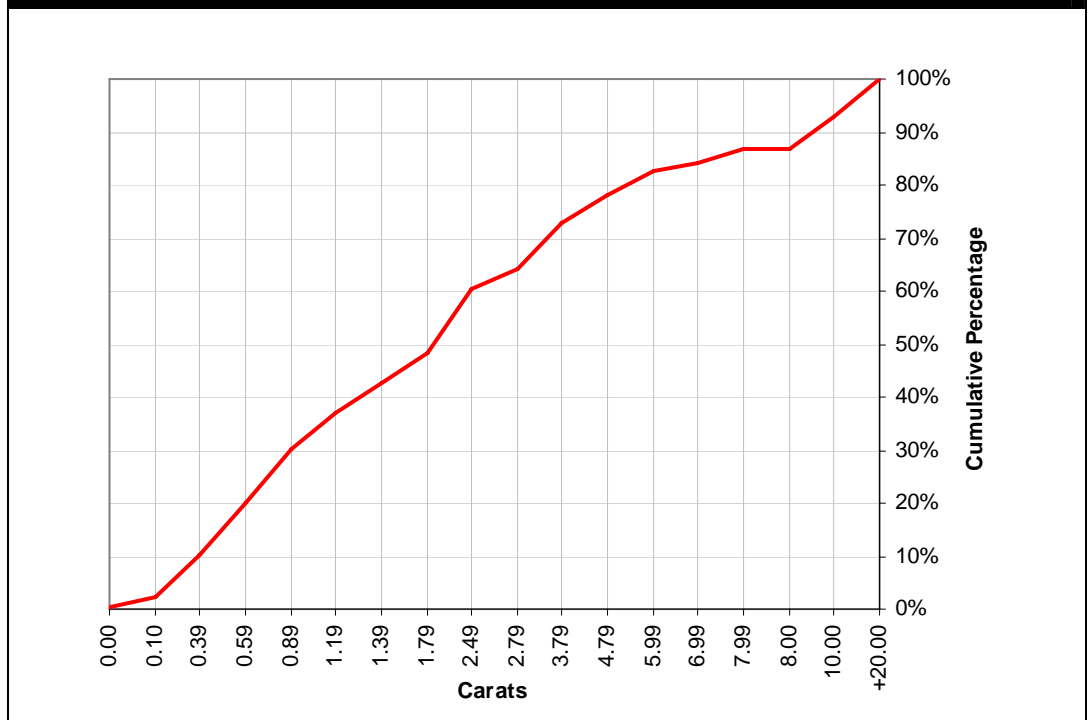

**32.4 PDF Bulk Sampling**

Bulk sampling commenced in November 2006 as a continuation of the Viska bulk sampling.

**32.4.1 Sampling Method and Approach**

PDF continued the bulk sampling of Viska, excavating a further 7 trenches on the farm Zamenkomst 819 (Figure 104). The sampling procedures and methodology used for the PDF bulk samples is the same as for Viska, which is detailed in Section 32.3.1.

The trenches were numbered sequentially and named using the prefix PA, PB and PC, which represents the Pangea samples. The entire trench was processed as a bulk sample.

The positions of the trenches were surveyed by PDF using a GPS. A PDF geologist was stationed on site to monitor the bulk sampling programme.

#### 32.4.2 Sample Preparation, Analyses and Security

The samples were transported directly to plant and treated through the Viska pan plant which PDF hired for three months to process their samples, as discussed in Section 32.7.

As mentioned, the method of sample preparation is adequate. The method of processing using a pan plant and final recovery through a double Flowsort® and over a grease belt is good. The final hand sorting is open to security risks; however, the Qualified Person has a high degree of confidence in the results, since the results would only indicate an underestimation of the grade.

#### 32.4.3 Data Verification

The database of results was verified by PDF using the method described in Section 32.2.3.

Venmyn has not verified the database in detail but has witnessed the rigorous process of verification which PDF's headoffice geologist undertakes. This being the case, the Qualified Person is satisfied that this process of verification will minimise error in data entry and identify any inconsistencies in the actual sample data and the database entries

#### 32.4.4 Results

The results of the 7 exploration trenches are detailed in Table 122. The exploration pitting produced a total of 197 stones with a weight of 146.65 carats. The average stone size was 0.76cts.

**Table 123 : PDF Bulk Sampling Results for the Brussels Project Area**

SAMPLE NO.	GRAVEL TYPE	O/B THICK (m)	GRAVEL THICK (m)	GRAVEL VOLUME (m <sup>3</sup> )	CARATS	NO. STONES	GRADE (ct/100m <sup>3</sup> )	STONE SIZE (ct/stone)	BOTTOM SCREEN SIZE (mm)
PA27	Coarse Calcrete	4.26	3.55	6,038.55	30.54	31.00	0.51	0.99	2.0
PA28 Top	Sandy Calcrete	1.79	2.78	3,218.99	1.65	6.00	0.05	0.28	2.0
PA29 Top	Coarse Calcrete	4.35	1.89	2,000.01	18.29	22.00	0.91	0.83	2.0
PA29 Bottom	Medium Calcrete	6.23	3.98	4,077.14	18.95	26.00	0.46	0.73	2.0
PA30 Top	Coarse Calcrete	4.45	1.59	2,628.51	5.95	13.00	0.23	0.46	2.0
PA30 Bottom	Medium Calcrete	6.04	1.16	1,836.92	10.34	8.00	0.56	1.29	2.0
PA31 Top	Coarse Calcrete	4.51	3.08	4,747.65	22.15	36.00	0.47	0.62	2.0
PA31 Bottom	Medium Calcrete	7.59	1.37	2,061.24	3.29	8.00	0.16	0.41	2.0
PA32 Top	Coarse Calcrete	4.20	0.93	434.78	7.20	7.00	1.66	1.03	2.0
PA32 Bottom	Medium Calcrete	5.01	4.37	3,566.48	11.76	20.00	0.33	0.59	2.0
PA33 Top	Coarse Calcrete	3.38	1.87	2,632.00	19.53	20.00	0.74	0.98	2.0
PC1 Top	Medium Calcrete	3.08	3.35	6,013.04	4.98	12.00	0.08	0.42	2.0
PC1 Bottom	Medium Calcrete	6.43	2.68	4,903.46	18.99	23.00	0.39	0.83	2.0
PC2	Medium Calcrete	2.04	3.78	6,148.61	4.59	13.00	0.07	0.35	2.0
PB2	Medium Calcrete	10.50	1.50	561.00	0.26	1.00	0.05	0.26	2.0
<b>TOTAL/AVE</b>		<b>4.37</b>	<b>3.00</b>	<b>50,868.38</b>	<b>178.47</b>	<b>246.00</b>	<b>0.35</b>	<b>0.73</b>	<b>2.0</b>

A combined size frequency distribution was plotted for Viska and PDF's recovered carats, which is detailed in Section 32.3.4.

## 32.5 Badenhorst Bulk Sampling

Bulk sampling commenced by Badenhorst in November 2007 on Gamabot 733 and was also utilised for grade determination.

### 32.5.1 Sampling Method and Approach

The second phase of the bulk sampling included the excavation of a further 2 trenches on Gamabot 733. They were typically 80m x 25m x 6m in size. The naming of the trenches continued used a prefix of B which indicates the Badenhorst samples. The entire trench was processed as a bulk sample.

The pits were excavated using a 40t excavator and they were excavated to a depth of approximately 8.5m, when the solid footwall was reached. Volumes for each trench were calculated inside the trench by subtracting the measured stripping depth of the top and the bottom of the gravel and multiplying this value by the pit length and width.

The positions of the trenches were surveyed by PDF using a GPS. A PDF geologist was stationed on site to monitor the bulk sampling programme.

### 32.5.2 Sample Preparation, Analyses and Security

All samples were transported directly to the plant by a loader and treated through the Badenhorst pan plant discussed in detail in Section 32.7.

The method of sample preparation is adequate. The method of processing using a pan plant and final recovery through a single Flowsort® is good. The Qualified Person has a high degree of confidence in the results.

### 32.5.3 Data Verification

The database of results was verified by PDF using the method described in Section 32.2.3.

Venmyn has not verified the database in detail but has witnessed the rigorous process of verification which PDF's headoffice geologist undertakes. This being the case, the Qualified Person is satisfied that this process of verification will minimise error in data entry and identify any inconsistencies in the actual sample data and the database entries

### 32.5.4 Results

The results of the 2 trenches on Gamabot are summarised in Table 124. The pitting produced a total of 14 stones with a weight of 11cts. The average stone size was 0.79cts.

**Table 124 : Badenhorst Gamabot 733 Bulk Sampling Results for the Brussels Project Area**

SAMPLE NO.	GRAVEL TYPE	O/B THICK (m)	GRAVEL THICK (m)	GRAVEL VOLUME (m <sup>3</sup> )	CTS	NO. STONES	GRADE (ct/100m <sup>3</sup> )	STONE SIZE (ct/stone)	BOTTOM SCREEN SIZE (mm)
CBA1	Coarse Calcrete Gravel	2.00	2.33	243.28	3.90	9.00	0.31	0.43	2.0
CBA2	Coarse Calcrete Gravel	1.40	1.94	754.34	7.10	5.00	0.94	1.42	2.0
<b>TOTAL/AVE</b>		<b>3.40</b>	<b>4.27</b>	<b>1,997.62</b>	<b>11.00</b>	<b>14.00</b>	<b>0.55</b>	<b>0.79</b>	<b>2.0</b>

## 32.6 Adjacent Properties

No information relating to adjacent properties is publicly available.

## 32.7 Mineral Processing and Metallurgical Testing

The samples processed from the bulk sampling are considered to be representative of the deposit for both the Vika and the Bdenhorst Processing Plants.

### 32.7.1 Viska Processing Plant

#### 32.7.1.1 Pan Plant

Samples from the initial 26 exploration trenches, excavated by Viska and the additional 7 trenches excavated by PDF were processed through three 16ft pans and the concentrate sent to a double Flowsort® for final processing. The pan plant was operated by Viska. The simplified plant flowsheet is shown Figure 107.

The feed is passed through a 40mm vibrating grizzly. The fines (-2mm) are pumped the slimes dam and the oversize (+32mm) is returned to the pits. The remaining +2mm-32mm is passed through the three 16ft pans. The pans are tapped with an auger every two hours into 5t sputniks. The sputniks are transported by truck to the front of the recovery plant, situated in Schweizer Reineke. The concentrate contained in the sputnik is sent through a 20tph DMS, before being conveyed for final recovery.

The pan plant is designed to treat 330tph ROM (in situ gravel) feed at a rotational speed of approximately 6rpm. The puddle is made naturally from the fines material associated with the diamond bearing gravels. The density is controlled by the amount of water allowed into the pan.

In order to test the efficiency of the plant two to six testers were placed into the pan and, or into the pit on a weekly basis, for recovery on a grease table set up behind the flowsort. A 95% recovery was obtained.

#### 32.7.1.2 Final Recovery Plant

The concentrate from the DMS was conveyed to a double Flowsort® and grease table via a closed tube conveyor, before final processing by hand sorting. The concentrate was sized as follows:-

- +2mm – 6mm;
- +6mm – 8mm;
- +8mm – 12mm; and
- +12mm – 32mm.

#### 32.7.1.3 Security

No comment can be made on the security as the plant has been dismantled and removed from the project area.

### 32.7.2 Badenhorst Processing Plant

#### 32.7.2.1 Pan Plant

Samples from the second phase of trenching of the bulk sample programme were processed through one 10ft pan and the concentrate sent to a single Flowsort® for final recovery. The pan plant was commissioned by Badenhorst. The simplified plant flowsheet is shown Figure 108.

The feed is passed through a 40mm vibrating grizzly and a scrubber. The fines (-2mm) are pumped the slimes dam and the oversize (+32mm) is returned to the pits. The remaining +2mm-32mm is passed through the one 10ft pan. The pan is tapped with an auger every two hours into 1.5t sputniks. The sputniks are transported by truck to the front of the recovery plant, situated near Bloemhof, a distance of 180km away.

**SCHEMATIC FLOWSHEET FOR THE VISKE PAN PLANT AT THE BRUSSELS PROJECT AREA**

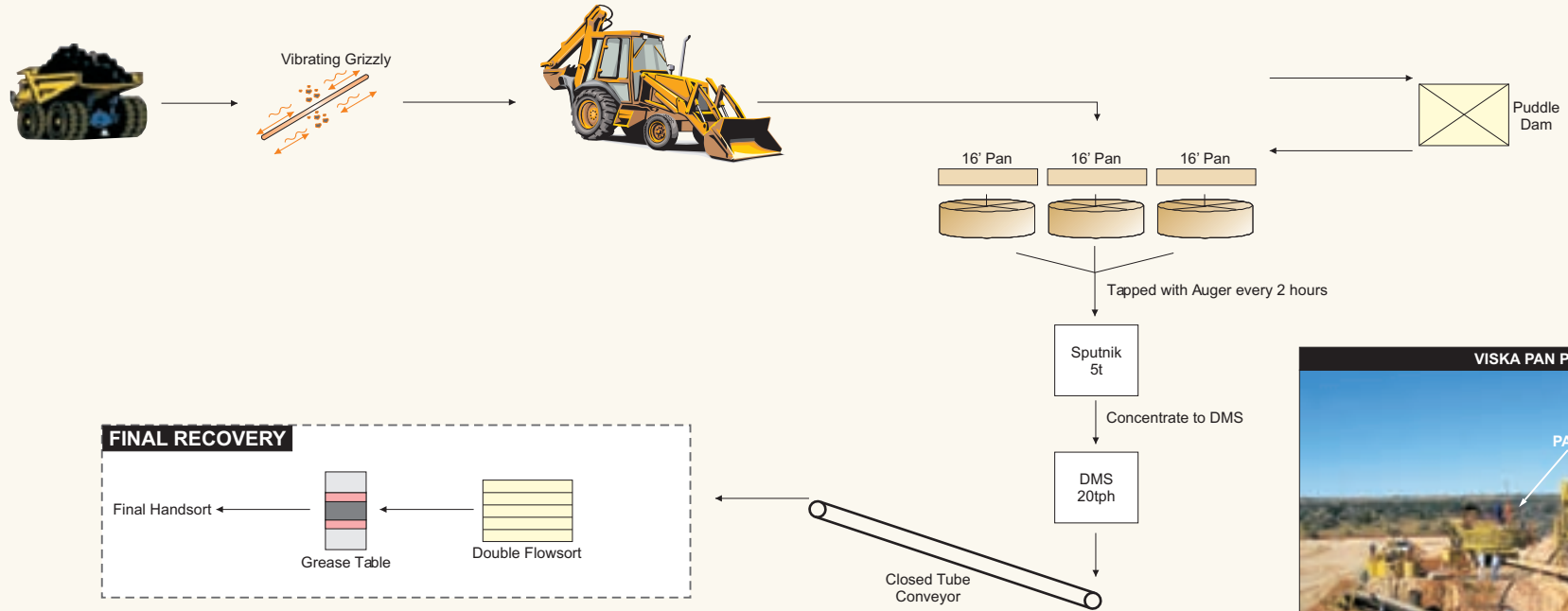

Source: Venmyn

This diagram and the information herein is copyrighted. It may not be reproduced or transmitted in any form or by any means without prior written permission from Venmyn Rand (Pty) Ltd. Trading as Venmyn.

**SCHEMATIC FLOWSHEET FOR THE BADENHORST PAN PLANT AT THE BRUSSELS PROJECT AREA**

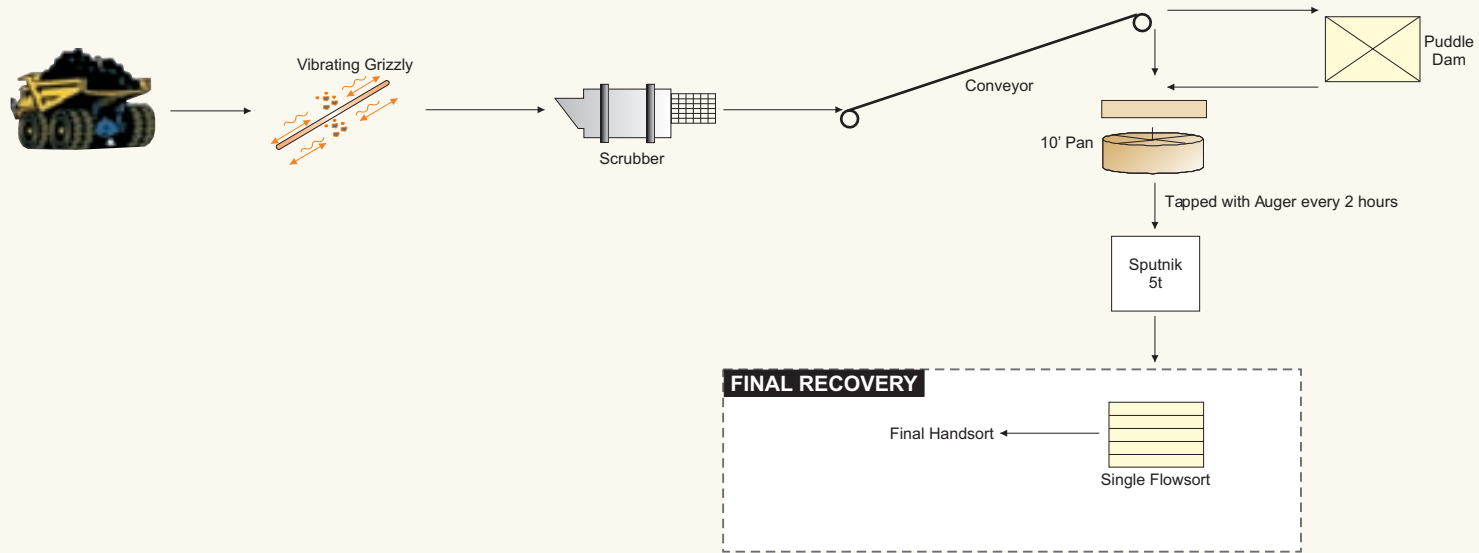

Source: Venmyn

This diagram and the information herein is copyrighted. It may not be reproduced or transmitted in any form or by any means without prior written permission from Venmyn Rand (Pty) Ltd. Trading as Venmyn.

PangeaDFieldsTSX'07Fig108.cdr

The pan plant is designed to treat 40tph ROM (in situ gravel) feed at a rotational speed of approximately 8.5rpm. The puddle is made automatically from the fines material. The density is controlled by the amount of water allowed into the pan. Density is not measured on a regular basis. This will however change in the near future.

Currently there is no grease table set up at this plant, therefore no testers have been placed into the pan. In due course, PDF will have obtained fluorescing testers which will be used on a regular basis.

The bottom screensize cut-off is 2mm.

To date, only 5,436t has been processed through the plant, yielding 17 diamonds.

It was noted by Venmyn on their visit to the plant that a high proportion of the cemented calcrete gravel is removed by the grizzly as oversize. This is a possible reason why larger stones are recovered, since the smaller stones may still be locked up in the cemented calcrete gravels.

The current pan plant will be replaced with a double 16ft unit, if initial tests are satisfactory.

### 32.7.2.2 Final Recovery Plant

The concentrate contained in the sputnik is passed directly into a single size Flowsort®. The concentrate is sized as follows:-

- +2mm – 6mm;
- +6mm – 8mm;
- +8mm – 12mm; and
- +12mm – 32mm.

Hand sorting is carried out on the largest size fraction.

Venmyn are of the opinion that a more optimal screen sizing would be the following:-

- +2mm – 4mm;
- +4mm – 8mm;
- +8mm – 16mm; and
- +16mm – 32mm.

### 32.7.2.3 Security

The security level surround the pan plant is currently reasonable. The area is, however, not fenced off. The existing security facilities consist of the following:-

- at the current pan plant, the concentrate is passed straight into the flowsort from the sputnik;
- a security firm has been contracted on site and Mr Manna van Hysteen (who has several years experience in security of local diggers and companies) has been appointed head of security;
- a PDF staff member is present when the diamonds are sorted and sent to the tender house for storage; and
- the diamond are sealed and transported to Schweizer Reneike tender house, under armed guard.



## 32.8 Diamond Resource and Diamond Reserves Estimate

### 32.8.1 Previous Mineral Resource Statement

The historical Diamond Resource estimate was completed by PDF in 2006. The Resources were classified according to SAMREC rules of reporting as Inferred as a result of the limited extent of the drilling and bulk sampling.

The Inferred Diamond Resources were classified for the RE of Ptn 1 of Zamenkomst 819 of the Brussels Project Area and are shown in Table 125.

**Table 125 : Harts River Diamond Resource Statement (2006)**

MINE / PROJECT	PROJECT AREA	RESOURCE CLASSIFICATION	GRAVEL VOLUME (m <sup>3</sup> )	GRADE (ct/100m <sup>3</sup> )	CARATS	DIAMOND VALUE (US\$/ct)
Harts River	Brussels	Inferred	16,230,435	0.6	90,383	1,555

The previous diamond resource statement has been updated with the latest sampling results.

### 32.8.2 Volume

The volume of the resources was estimated from the percussion holes database of gravel thickness using Surfer®. Geological interpretation of the channel characteristics were also utilised where necessary. Modelling was carried out using the inverse distance squared method of estimation using all datapoints within the limit of the channel, i.e. having gravel. Volumes were limited to areas which had sufficient drill holes.

The volumes were modelled for the upper calcrete gravels in Surfer® using the extended trapezoidal rule. The resultant volumes are summarised in Table 126.

**Table 126 : Volume Estimation for Hart River Project**

PROJECT	PROJECT AREA	BLOCK	GRAVEL TYPE	GRAVEL VOLUME (m <sup>3</sup> )
Harts River	Brussels	ZUCG1	Upper Calcrete	4,715,569
		ZUCG2		12,425,623
		ZUCG3		4,693,723
		ZUCG4		1,141,993
	TOTAL/AVE			<b>22,976,908</b>

### 32.8.3 Density

No density measurements are required as all resources are quoted in volumes.

### 32.8.4 Grade

The grade has been calculated for deep channel gravels and upper calcrete using the weighted average of the bulk samples occurring within the resource blocks defined in the volume modelling. A summary of the grades is shown in Table 127.

**Table 127 : Grade Results for the Harts River Project**

PROJECT	PROJECT AREA	BLOCK	GRAVEL TYPE	BULK SAMPLES INCLUDED IN GRADE CALC	WTD AVE REC GRADE (ct/100m <sup>3</sup> )	CARATS
Harts River	Brussels	ZUCG1	Upper Calcrete	CBA1, CBA2	0.55	25,936
		ZUCG2		CBA1, CBA2	0.55	68,341
		ZUCG3		A1 to A24	0.55	25,815
		ZUCG4		A1 to A24	0.55	6,281
	TOTAL/AVE				<b>0.55</b>	<b>126,373</b>

**32.8.5 Diamond Value**

To date, seven parcels, with a total of 1,094.22cts have been sold for the Zamenkomst 819 of the Brussels Project Area whilst a total of 1,130.13cts has been produced from the Brussels Project Area.

The parcel sizes and average diamond prices obtained are shown in Figure 109. The diamond prices varied from a minimum of US\$387/ct to a maximum of US\$1942/ct.

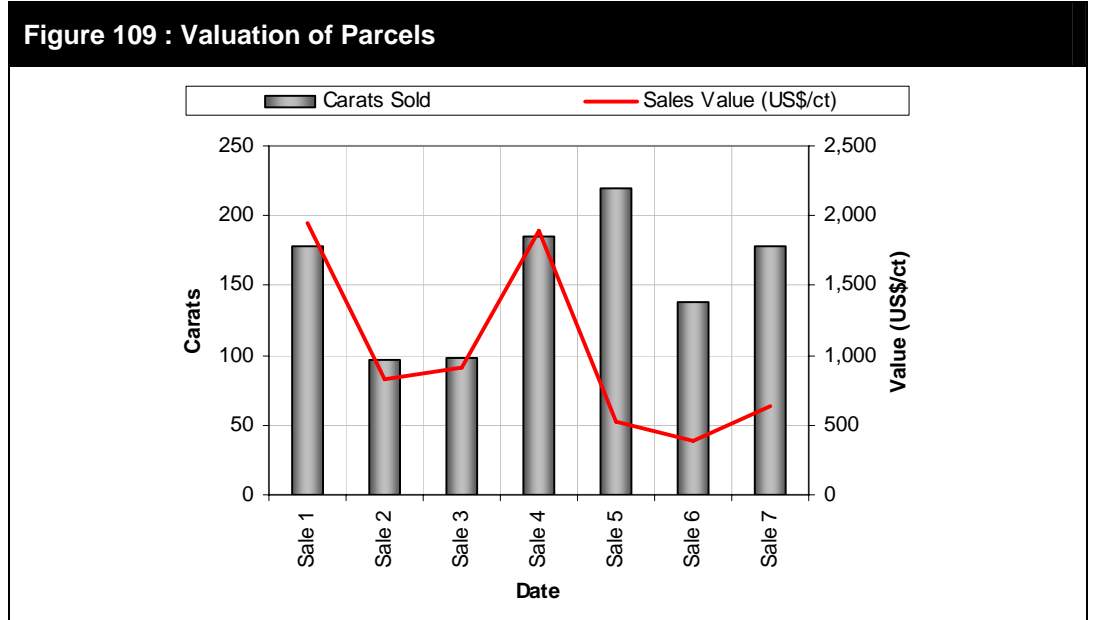

The average diamond price obtained for the Brussels Project area is US\$1,050/ct (Table 128). A total of 30% of these diamonds are less than 1ct in size, 48% occur in the size range of between 1ct and 5cts and 22% are greater than 5ct in size.

**Table 128 : Average Diamond Values Used for Harts River Project**

SALES	SALES DATE	TOTAL VALUE (US\$)	CARATS	VALUE (US\$/ct)
Sale 1	Mar-07	346,312	178	1,942
Sale 2	Apr-07	79,827	96	830
Sale 3	Apr-07	88,748	98	908
Sale 4	May-07	352,270	186	1,899
Sale 5	Jul-07	114,620	220	521
Sale 6	Jul-07	53,376	138	387
Sale 7	Feb-08	113,575	178	636
<b>TOTAL / AVE</b>		<b>1,148,728</b>	<b>1,094</b>	<b>1,050</b>

**32.8.6 Current Resource Statement**

The Diamond Resource statement for the Harts River Project, dated 1<sup>st</sup> March 2008, was prepared by Mr. Pierre Bekker. This was independently verified by Ms Catherine Telfer of Venmyn. The statement for the Harts River Project is shown in Table 129.

All resources are classified as Inferred (Figure 110) due to the low confidence associated with the grade and the lack of a sufficiently large parcel sold in today’s market. The logic used in the classification is tabulated in Appendix 6.

**Table 129 : Resource Statement for the Harts River Project – 1<sup>st</sup> March 2008**

PROJECT	PROJECT AREA	RESOURCE CLASSIFICATION	GRAVEL VOLUME (m <sup>3</sup> )	REC GRADE (ct/100m <sup>3</sup> )	CARATS	DIAMOND VALUE (US\$/ct)	BOTTOM SCREEN SIZE (mm)
Hart River	Brussels	Inferred	22,977,000	0.55	126,374	1,050	2.0
		<b>TOTAL/AVE</b>	<b>22,977,000</b>	<b>0.55</b>	<b>126,374</b>	<b>1,050</b>	<b>2.0</b>

**LOCATION OF DIAMOND RESOURCES FOR THE BRUSSELS PROJECT AREA**

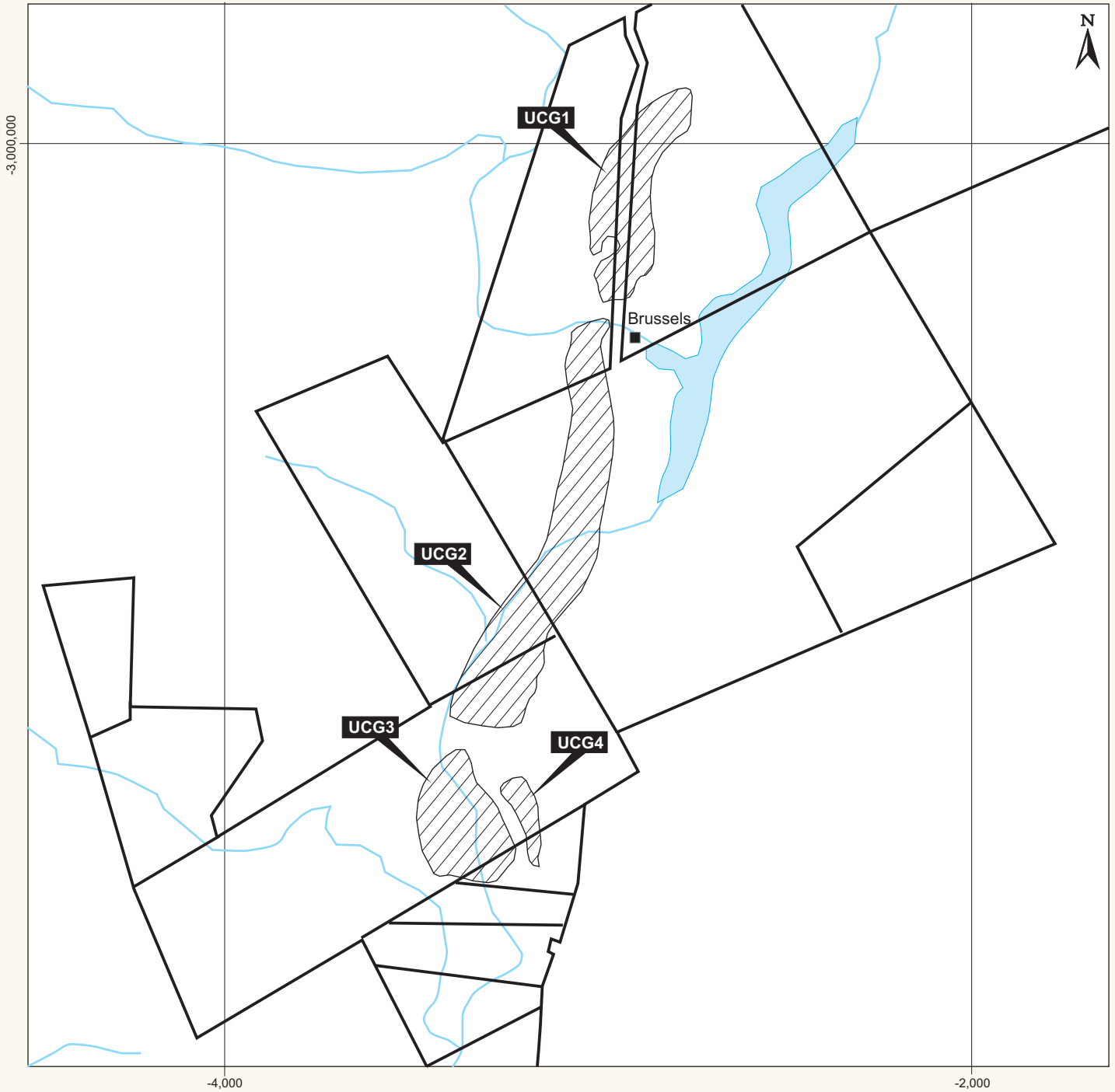

PROJECT	PROJECT AREA	RESOURCE CLASSIFICATION	GRAVEL VOLUME (m <sup>3</sup> )	GRADE (ct/100m <sup>3</sup> )	CARATS	DIAMOND VALUE (US\$/ct)	BOTTOM SCREEN SIZE CUTOFF (mm)
Hart River	Brussels	Inferred	22,977,000	0.55	126,374	1,050	2
		<b>TOTAL/AVE</b>	<b>22,977,000</b>	<b>0.55</b>	<b>126,374</b>	<b>1,050</b>	<b>2</b>

Source: Pangea

**LEGEND:**

 Upper Calcrete Resource Blocks

**SCALE:**



This diagram and the information therein are copyrighted. It may not be reproduced or transmitted in any form or by any means without prior written permission from Venmyn Rand (Pty) Ltd. Trading as Venmyn.

There are no known items relating to the environment, permits, legal, title, taxation, socio-economic, marketing, and political or any other issue that would have a material effect on the resources identified in the current Diamond Resource statement.

### 32.9 Other Relevant Data and Information

There is no other relevant data or information which should be presented to ensure that this report is not misleading in anyway.

### 32.10 Interpretation and Conclusions

Exploration in the Brussels Project Area has identified two gravel types, namely; the deep channel gravels and the upper calcrete gravels. These two gravel types have been defined through percussion drilling. The results from the percussion drilling were used to contour the gravel and overburden thicknesses and the stripping depth of both of gravels. The gravel thickness contours have provided resource volumes for the gravels.

The upper calcrete gravels and overburden show similar thickness plots, optimal for mining, whereas the deep channel gravels have high stripping ratios, in most parts greater than 6m. The Gamabot and Uitenhage gravels are relatively constant, whereas the overburden thickness is thinner towards the south, thus suggesting optimal mining in the south.

A diamond price of US\$1050/ct was determined for the Brussels Project Area, from 1,094.22cts sold for the project area. Within the total resource of the upper calcrete gravels PDF believe that there they have identified a potentially higher grade (1.0cts/100m<sup>3</sup>) and higher average diamond value (US\$1555/ct) zone. Future bulk sampling is focussed on delineating this higher grade and value zone.

The exploration results have enabled the Inferred Diamond Resource to be updated for the Brussels Project Area.

The results obtained from the exploration programme and the modelling completed for the area have been checked and verified by Venmyn. Venmyn are of the opinion that the exploration results are sufficient to define an Inferred Resource for the Brussels Project Area.

### 32.11 Recommendations

Recommendations are based on the approval of the renewal of the PR's for the Brussels Project Area. The recommended work programme for the South African projects, including the Harts River Project is tabulated in Table 122. Venmyn has assisted PDF in the compilation of the work programme and budget in respect of the Harts River Project and recommends that the company undertake the programme as stated therein. The expected revenues to be derived from the sale of diamonds extracted during exploration pitting, bulk sampling and pilot mining are shown in Table 123.

## 33 HARTS RIVER PROJECT – PAMPIERSTAD PROJECT AREA

### 33.1 Exploration

Exploration commenced at the Pampierstad Project Area in April 2007. The exploration programme, as outlined in Section 32.1 for the Brussels Project Area, was also utilised at the Pampierstad Project Area. To date, PDF have conducted percussion drilling and will commence with a bulk sampling programme on the Pampierstad Project Area in March 2008.

### 33.2 Percussion Drilling

Percussion drilling commenced in May 2007 in order to identify the vertical and lateral extent of the deep channel gravels and the Rooikoppie gravels.

#### 33.2.1 Sampling Method and Approach

The percussion drilling methodology and approach is the same as that followed in the Brussels Project area and is detailed in Section 32.2.1. A total of 101 boreholes has been drilled.

A detailed description for the drill rig at Pampierstad is provided in Section 32.2.1.

The boreholes were named with the prefix HN, which indicates all Pampierstad holes and were numbered sequentially beginning at 1. The collar elevations were surveyed using a handheld GPS by the on site geologist.

### 33.2.2 Sample Preparation, Analyses and Security

The sample preparation is discussed in Section 32.2.2.

### 33.2.3 Data Verification

The database of results has been checked by PDF using the method discussed in Section 32.2.3.

Venmyn has not verified the database in detail but has witnessed the rigorous process of verification which PDF's headoffice geologist undertakes. This being the case, the Qualified Person is satisfied that this process of verification will minimise error in data entry and identify any inconsistencies in the actual sample data and the database entries.

### 33.2.4 Results

The location of the percussion borehole in relation to the extent of the gravels on the Pampierstad Project Area is shown in Figure 111 and Figure 112.

Modelling of gravel thickness and overburden thickness were completed in Surfer®, using the method described in Section 32.2.4. Both the rooikoppie and deep channel gravels were modelled for the Pampierstad Project Area.

The gravel and overburden thicknesses were modelled in Surfer® using the inverse distance squared method of estimation. The deep channel and rooikoppie gravels were modelled separately and the contour plots are presented in Figure 113. Summary statistics for the Pampierstad Project Area are shown in Table 130.

**Table 130 : Summary Statistics for the Pampierstad Project Area**

PROJECT AREA	BLOCK	NO. DATA POINTS	GRAVEL THICKNESS (m)			OVERBURDEN THICKNESS (m)		
			MIN	MAX	AVE	MIN	MAX	AVE
Pampierstad	Rooikoppie Gravels	38	0.57	1.91	1.04	0.86	2.82	1.63
	Deep Channel Gravels	46	1.37	4.09	2.44	6.39	10.23	7.67
	<b>TOTAL</b>	<b>84</b>						

The gravel contour plots for the Rooikoppie gravels show an increase of in thickness towards the south, varying between 0.5m and 3m thick. The overburden also remains constant over the area with an average thickness of 2m. The stripping ratios are ideal for mining.

The deep channel gravel plots show a constant thickness across the area, varying from 0.5m to 4m. The overburden is on average 6m to 7m thick, and remains constant over the area.

### 33.3 Exploration Pitting

No exploration pitting has been carried out on the Pampierstad Project Area.

### 33.4 Bulk Sampling

No bulk sampling has been carried out on the Pampierstad Project Area.

### 33.5 Adjacent Properties

There is no publicly available information for the properties adjacent to the Pampierstad Project Area.

**LOCATION OF EXPLORATION AT THE PAMPIERSTAD PROJECT AREA INDICATING THE DEEP CHANNEL GRAVELS**

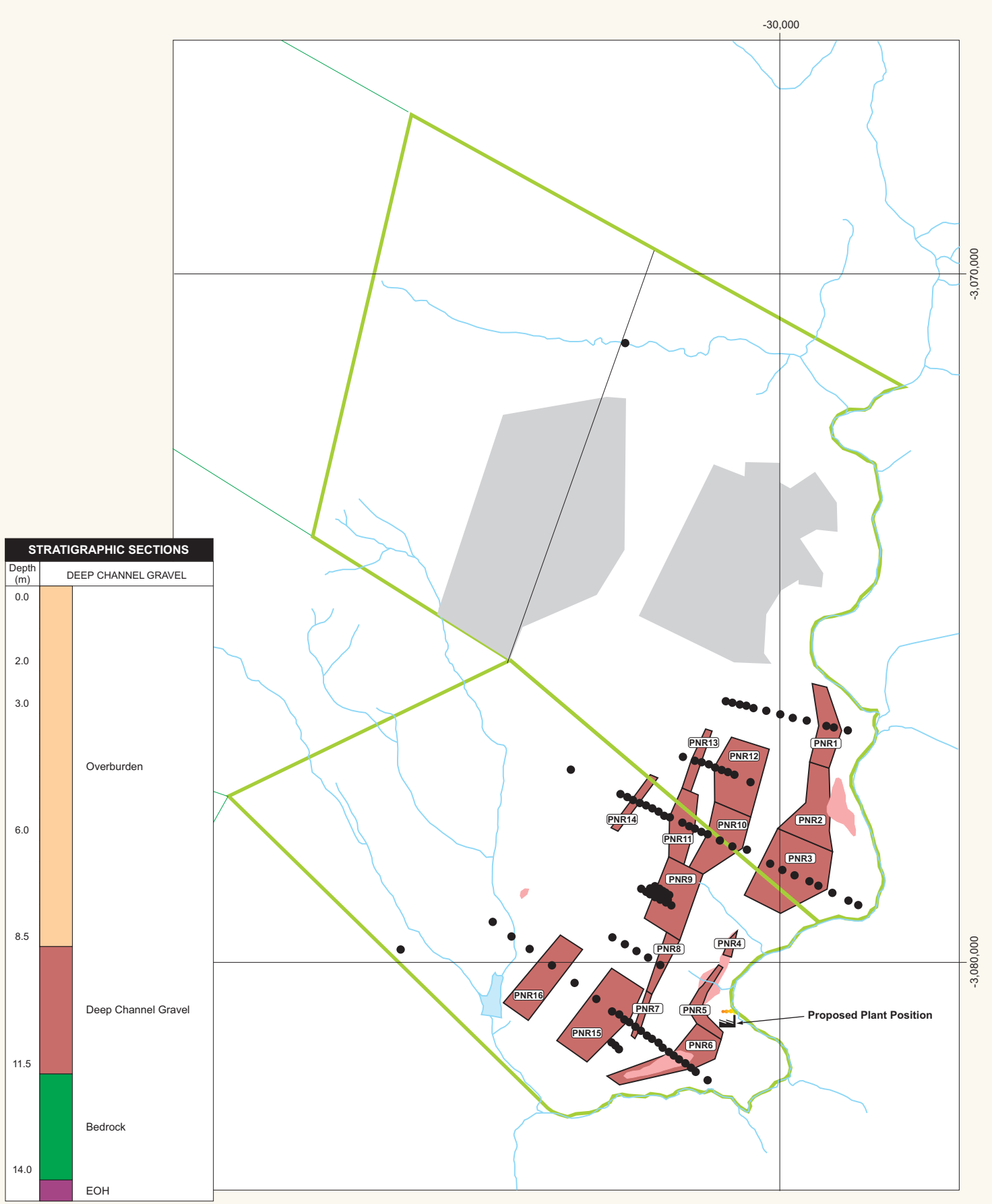

PangeaDFieldsTSX'07Fig111.cdr

Source: Pangea

**LEGEND:**

- RC Drillhole
- River
- Built-up Area
- Project Area
- Rooikoppie-type Gravel outcrop
- Deep Channel Gravel with block number

This diagram and the information therein are copyrighted. It may not be reproduced or transmitted in any form or by any means without prior written permission from Venmyn Rand (Pty) Ltd. Trading as Venmyn.

**LOCATION OF EXPLORATION AT THE PAMPIERSTAD PROJECT AREA INDICATING THE ROOIKOPPIE GRAVELS**

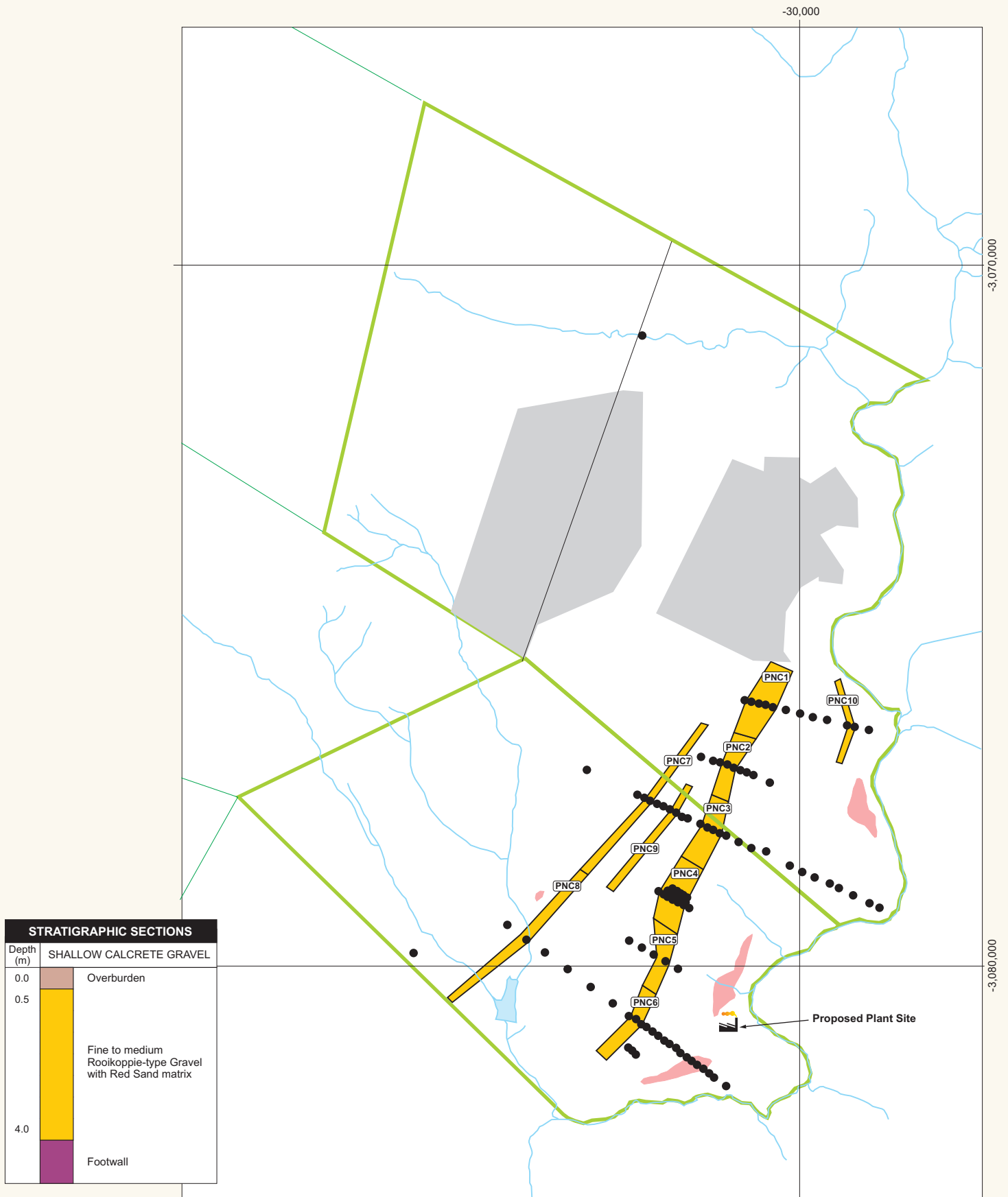

STRATIGRAPHIC SECTIONS	
Depth (m)	SHALLOW CALCRETE GRAVEL
0.0	Overburden
0.5	Fine to medium Rooikoppie-type Gravel with Red Sand matrix
4.0	
	Footwall

PangeaDiamondFieldsTSX'07Fig112.cdr

Source: Pangea

**LEGEND:**

- RC Drillhole
- River
- Built-up Area
- Project Area
- Rooikoppie-type Gravel outcrop
- Rooikoppie Channel Gravel with block number

This diagram and the information therein are copyrighted. It may not be reproduced or transmitted in any form or by any means without prior written permission from Venmyn Rand (Pty) Ltd. Trading as Venmyn.

### **33.6 Mineral Processing and Metallurgical Testing**

No mineral processing has occurred within the Pampierstad Project Area.

### **33.7 Diamond Resource and Diamond Reserves Estimate**

No Diamond Resource estimate was completed for the Pampierstad Project Area.

### **33.8 Other Relevant Data and Information**

There is no other relevant data or information which should be presented to ensure that this report is not misleading in anyway.

### **33.9 Interpretation and Conclusions**

Exploration in the Pampierstad Project Area identified two gravel types, namely; the deep channel gravels and the Rooikoppie gravels. These two gravel types have been defined through percussion drilling.

The gravel thickness and overburden for Pampierstad Project Area were modelled in Surfer®. The contour modelling indicated that the rooikoppie gravels have a suitable stripping ratio for mining, with the gravels and overburden fairly constant across the area. The deep channel gravels have a similar constant thickness across the project; however, the overburden thickness is between 6m and 7m.

The exploration results have been verified and the methods independently checked by Venmyn.

### **33.10 Recommendations**

The recommended work programme for the South African projects, including the Harts River Project is tabulated in Table 122. The expected revenues to be derived from the sale of diamonds extracted during exploration pitting, bulk sampling and pilot mining are shown in Table 123.



**CONTOUR PLOTS OF GRAVEL AND OVERBURDEN THICKNESSES FOR THE PAMPIERSTAD PROJECT AREA**

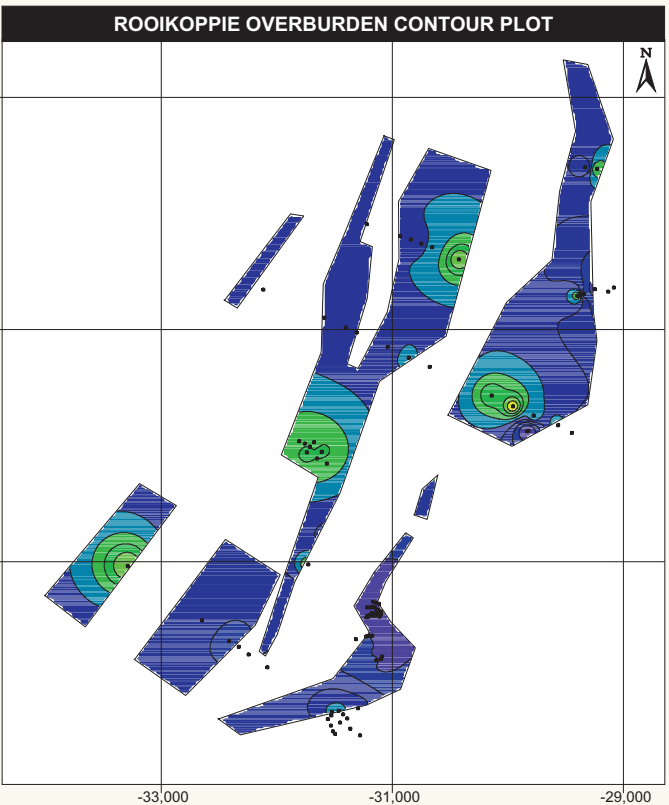
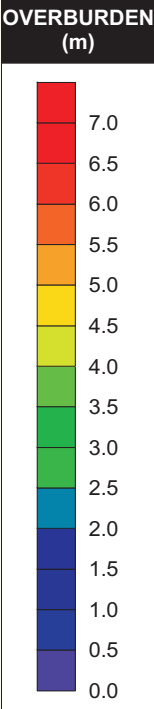
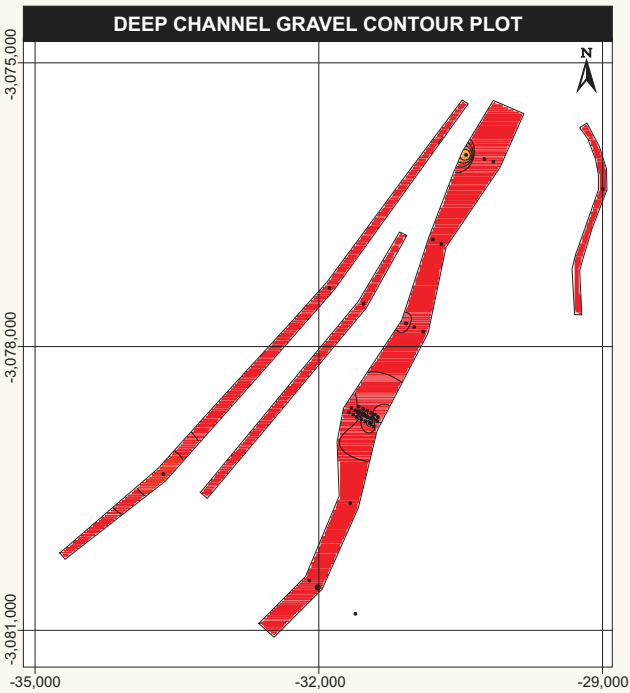
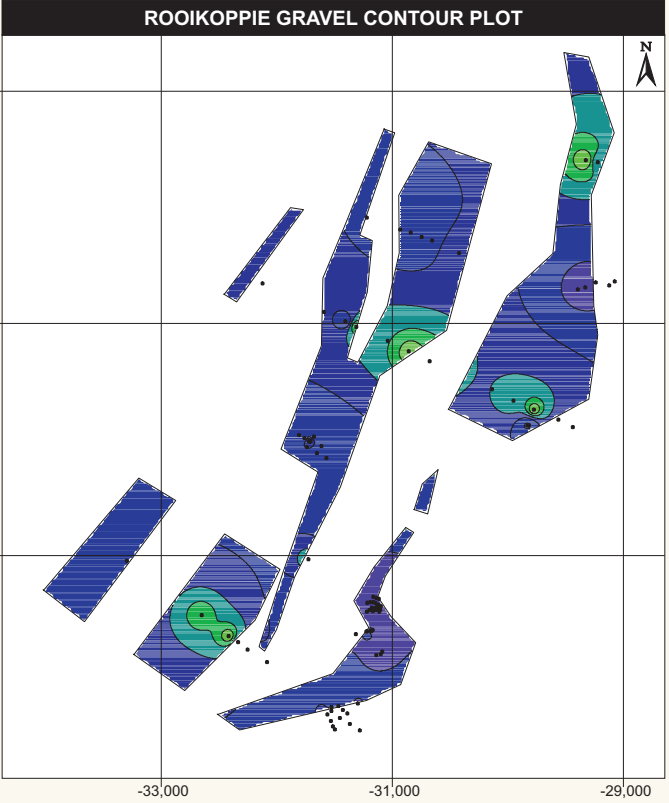
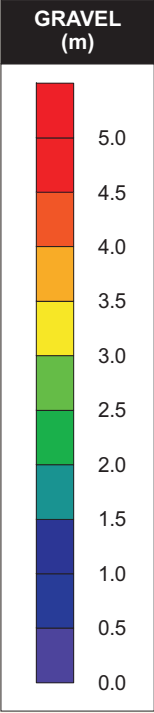
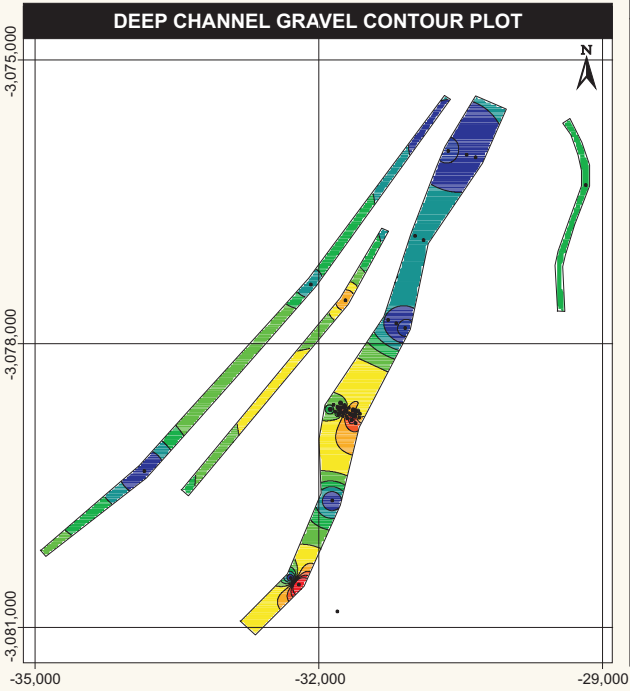
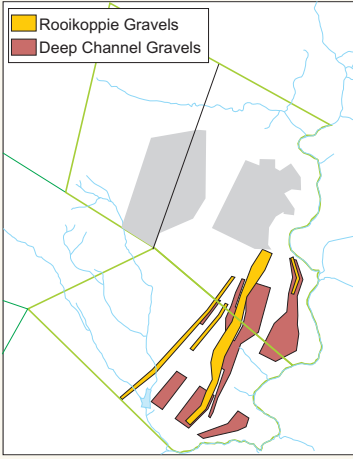

Source: Pangea  
 This diagram and the information therein are copyrighted. It may not be reproduced or transmitted in any form or by any means without prior written permission from Venmyn Rand (Pty) Ltd. Trading as Venmyn.

### 34 BLOEMHOF PROJECT

The Bloemhof Project comprises four project areas situated in the North West Province of South Africa between the towns of Delareyville Bloemhof, and Christiana (Figure 114 and Figure 115). These project areas are listed below:-

- Bergspruit;
- Wolmaransstad;
- Palmietfontein; and
- Zoutpan Project Areas.

The Bloemhof Project is located to the east of the Harts River Project and exhibits the similar geological rock types as the Harts River Project, and is underlain by the Ventersdorp Supergroup.

#### 34.1 Property Description and Location

The four project areas which make up the Bloemhof Project are located in the North West Province. The project is located approximately 6km from the town of Delareyville, 40km from Wolmaransstad and just west of the town of Bloemhof.

The Bergspruit Project Area comprises seven farms (Figure 114) or portions thereof, including Hartsrivierdiamant 363 IO, Goedgevonden 366 IO, Brodricks Valley 386 IO, Bossieslaagte 369 IO, Simonsvallei 382 IO, Vlakpan 381 IO and Oshoek 367 IO. The Bergspruit Project Area is 9,001ha in extent.

The Wolmaransstad Project Area lies just west of the town of Wolmaransstad. It comprises six farms (Figure 114) or portions thereof, including Wolmaransstad 184 HO, De Put 180 HO, Tweeloop 160 HO, Weltevreden 161 HO, Uitkyk 156 HO and Boschrand 158 HO. The Wolmaransstad Project Area is 11,286ha in extent.

The Palmietfontein Project Area comprises portions of four farms (Figure 115), including Zendingfontein 294 HO, Sterkfontein 271 HO, Palmietfontein 294 HO and Holfontein 276 HO. The Palmietfontein Project Area is 10,532ha in extent.

The Zoutpan Project Area comprises portions of four farms (Figure 115), including Gezicht 265 HO, Kafferpan 273 HO, Blaauwboschpan 293 HO and Holwater 302 HO. The Zoutpan Project Area is 5,946ha in extent.

The license boundaries, Table 131, have been determined by a professional surveyor, as required by the DME.

The surface rights owners of the Bloemhof Project are summarised in Table 132. PDF has obtained permission from these owners to commence exploration on the relevant farms. No fees are payable to the surface rights holders.

The mineralization of the project is characterised by alluvial deposits.

##### 34.1.1 Legal Aspects and Tenure

The ownership of the Bloemhof Project is illustrated in Figure 116. The applications for PRs on the various farms comprising the Bloemhof Project have been submitted in the name of Upward Spiral.

The Bloemhof Project consists of four PRs. Renewals for three of the four licences have been submitted to the DME in 2007 and are awaiting a response.

The legal aspects and tenure are summarised in Table 133.

**LOCALITY PLAN FOR BERGSPRUIT AND WOLMARANSSTAD PROJECT AREAS**

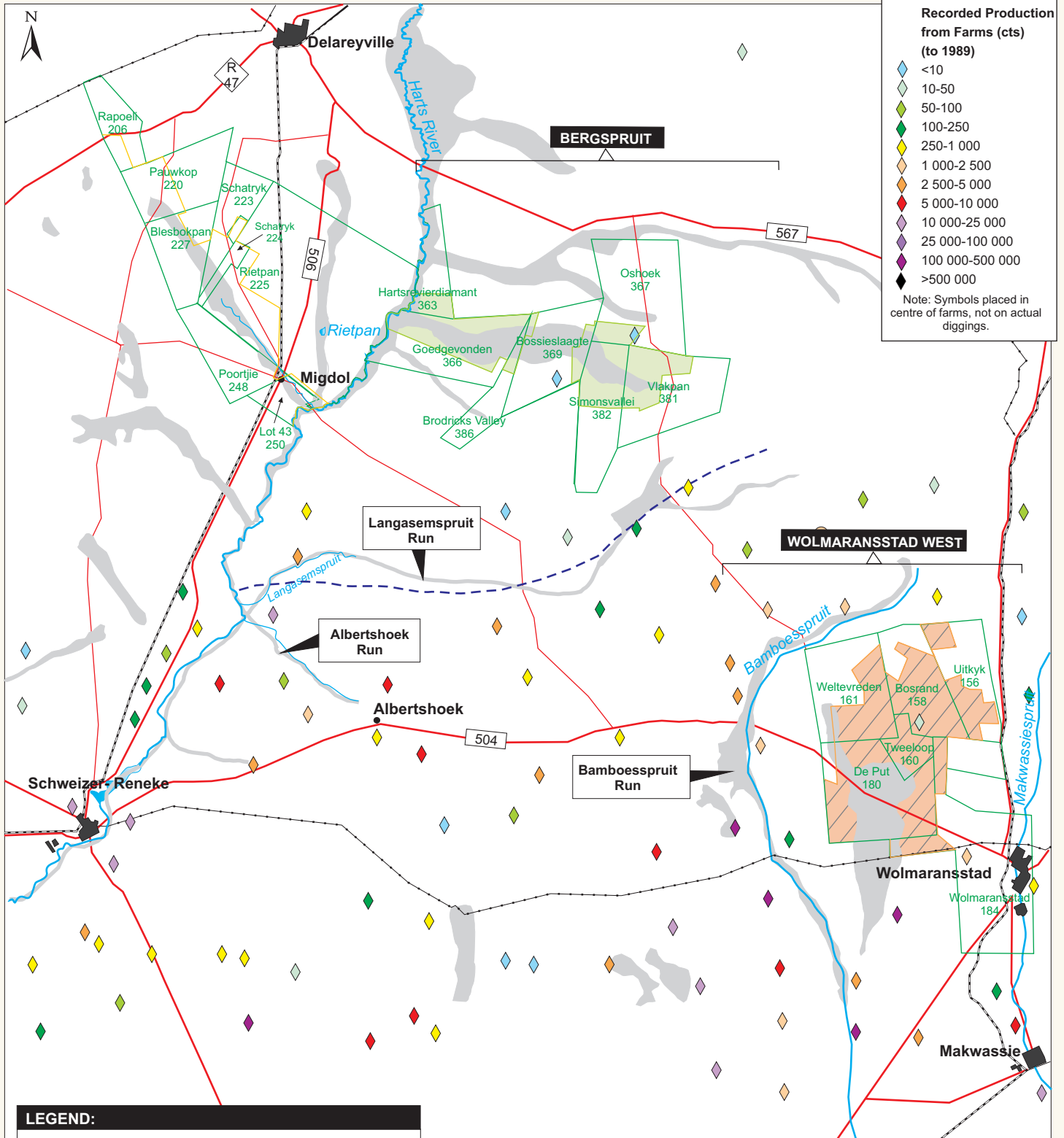

**Recorded Production from Farms (cts) (to 1989)**

- ◆ <10
- ◆ 10-50
- ◆ 50-100
- ◆ 100-250
- ◆ 250-1 000
- ◆ 1 000-2 500
- ◆ 2 500-5 000
- ◆ 5 000-10 000
- ◆ 10 000-25 000
- ◆ 25 000-100 000
- ◆ 100 000-500 000
- ◆ >500 000

Note: Symbols placed in centre of farms, not on actual diggings.

**LEGEND:**

- Main Road
- Other Road
- River
- - - Inferred Major Paleo-Drainage
- Railway
- Farm Boundaries
- Built-up Areas
- Power Line
- Migdol Prospect Area
- Bergspruit Prospect Area
- Wolmaransstad Prospect Area (PR Granted)
- Calcrete/Alluvium

**SCALE:**  
0 5km

Source: 2824 Kimberley

This diagram and the information therein are copyrighted. It may not be reproduced or transmitted in any form or by any means without prior written permission from Venmyn Rand (Pty) Ltd. Trading as Venmyn.

**LOCALITY PLAN FOR ZOUTPAN AND PALMIETFONTEIN PROJECT AREAS**

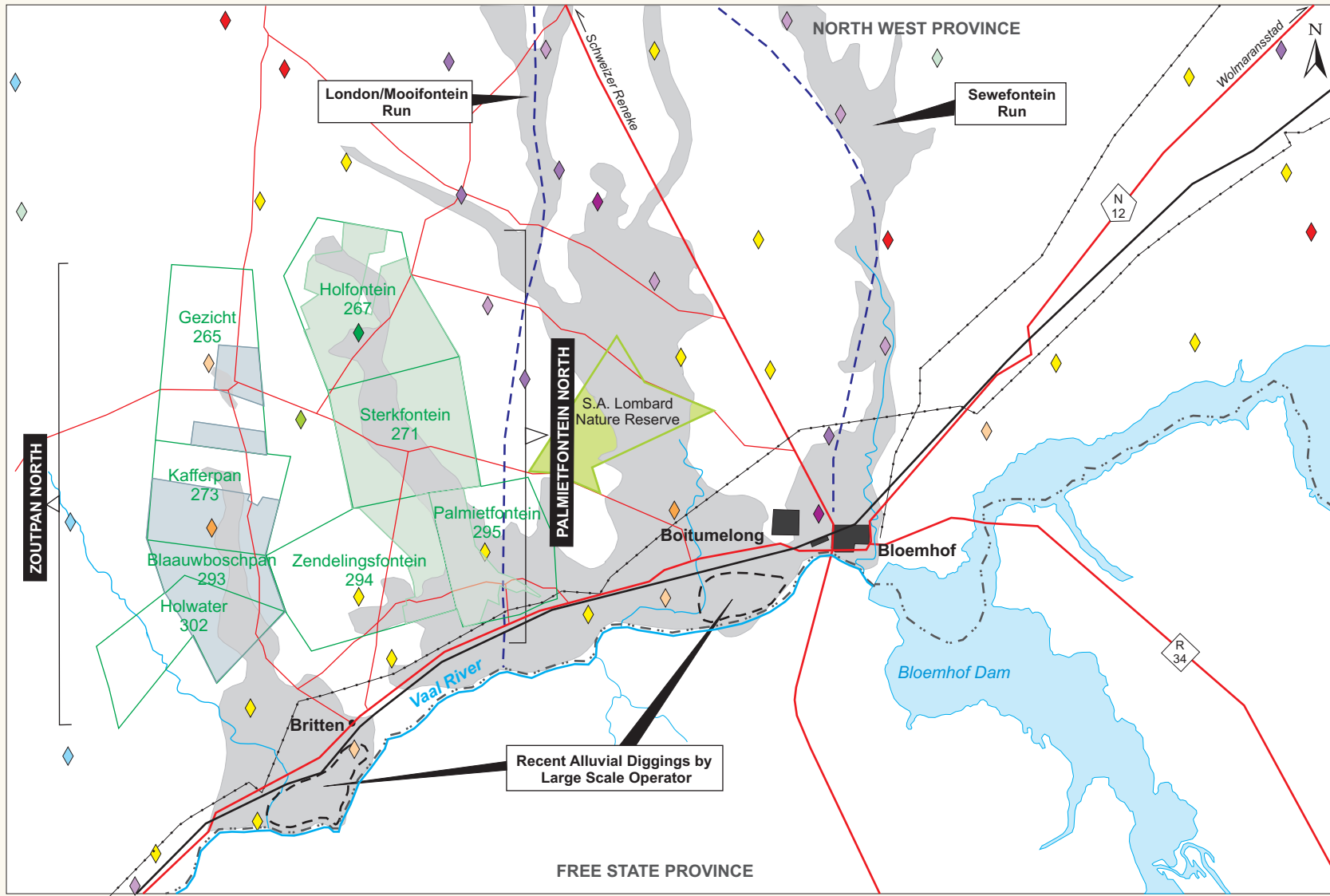

**Recorded Production from Farms (cts) (to 1989)**

- ◆ <10
- ◆ 10-50
- ◆ 50-100
- ◆ 100-250
- ◆ 250-1 000
- ◆ 1 000-2 500
- ◆ 2 500-5 000
- ◆ 5 000-10 000
- ◆ 10 000-25 000
- ◆ 25 000-100 000
- ◆ 100 000-500 000
- ◆ >500 000

Note: Symbols placed in centre of farms, not on actual diggings.

**SCALE:** 2.5 0 2.5 5 km

This diagram and the information therein are copyrighted. It may not be reproduced or transmitted in any form or by any means without prior written permission from Venmyn Rand (Pty) Ltd. Trading as Venmyn.

**LEGEND:**

<span style="color: red;">—</span> Main Road	<span style="background-color: black; color: black;">■</span> Built-up Areas	<span style="background-color: lightgreen; border: 1px solid black;">■</span> Nature Reserve
<span style="color: red; font-weight: bold;">—</span> Other Road	<span style="color: black;">---</span> Power Line	<span style="border: 1px dashed black; display: inline-block; width: 10px; height: 10px;"></span> Mined out areas
<span style="color: blue;">~</span> River	<span style="color: black;">-.-.-</span> Provincial Boundary	<span style="color: blue; font-weight: bold;">---</span> Inferred Major Paleao-Drainage
<span style="color: black;">—+—</span> Railway	<span style="background-color: lightgreen; border: 1px solid black;">■</span> Palmietfontein North (PR Submitted, not granted)	<span style="background-color: grey; border: 1px solid black;">■</span> Calcrete
<span style="color: green; border-bottom: 1px solid green; width: 20px; display: inline-block;"></span> Farm Boundaries	<span style="background-color: lightblue; border: 1px solid black;">■</span> Zoutpan North (PR Submitted, not granted)	

**OWNERSHIP OF THE BLOEMHOF PROJECT**

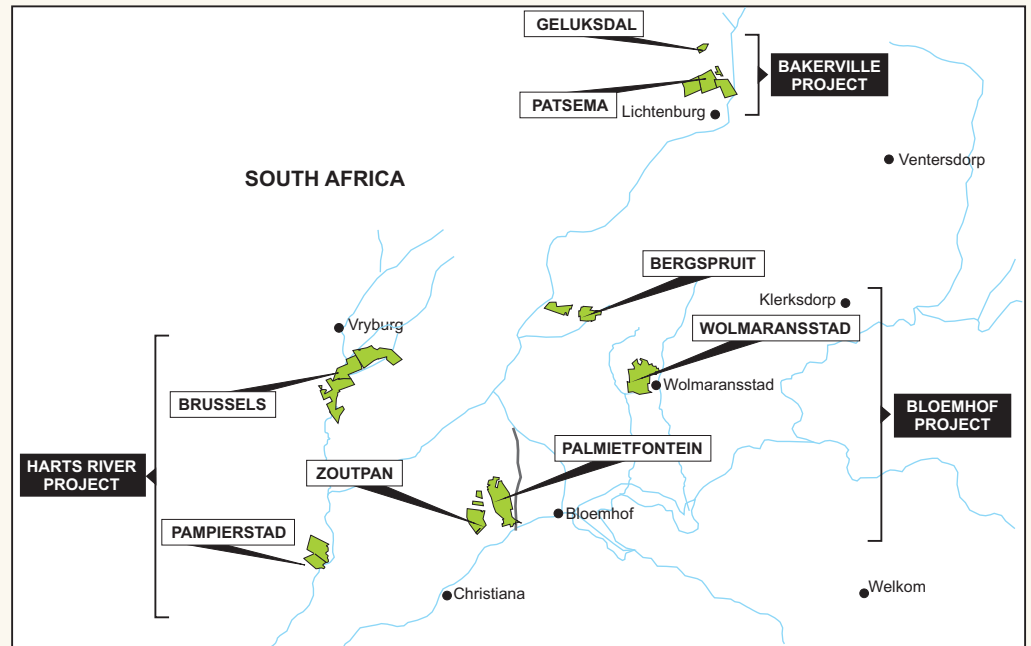
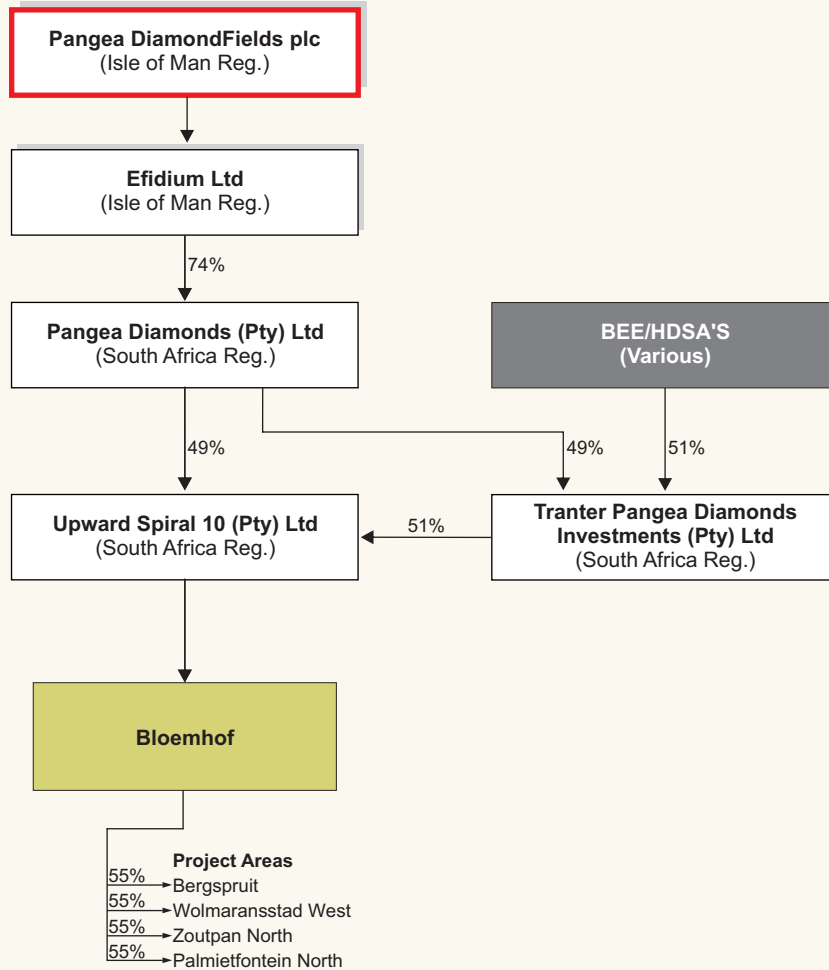

**Table 131 : Bloemhof Project Areas and Boundary Coordinates**

PROJECT NAME	PROJECT AREA	LICENSE TYPE	AREA (km <sup>2</sup> )	AREA (ha)	BOUNDARY COORDINATES LO 25 System (Clarke 1880/Cape) (+X; -Y)
Bloemhof	Bergspruit	PR	90	9,001	(2971733.65; -53661.58); (2970528.31; -54618.73); (2970502.09; -55567.8); (2970484.83; -57109.55); (2972329.08; -57385.13); (2972291.96; -57871.43); (2972223.52; -58590.6); (2971991.79; -60941.68); (2971825.17; -62685.99); (2971684.93; -63246.57); (2973422.43; -62760.49); (2973306.53; -62270.06); (2976094.7; -61487.75); (2975790.58; -60721.19); (2975113.89; -61055.93); (2974849.12; -60541.85); (2975947.12; -60010.21); (2975559.37; -59148.08); (2975226.74; -58351.27); (2974959.14; -57686.55); (2974303.21; -55875.18); (2973583.48; -54084.65); (2972977.05; -52669.52); (2972299.25; -67243.53); (2972617.38; -70751.05); (2973898.26; -69889.06); (2974049.73; -70863.52); (2974083.95; -71078.77); (2974131.36; -71355.82); (2974175.74; -71650.17); (2974228.04; -71976.625); (2974269.78; -72264.28); (2974383.58; -73030.425); (2974434.37; -73345.687); (2974506.43; -74117.99); (2975843.18; -73931.23); (2975965.59; -72855.44); (2976052.16; -72097.87); (2976064.72; -71989.76); (2977974.77; -71780.57); (2978565.85; -70373.2); (2978334.77; -70399.55); (2978399.96; -69067.86); (2978486.06; -69057.06); (2978417.82; -68190.16); (2978294.89; -66679.76); (2978259.51; -66159.92); (2976362.5; -66139.89); (2976602.59; -65632.56); (2974152.81; -65627.09); (2974130.39; -66131.5); (2972589.47; -66572.01); (2972588.95; -67162.75);
	Wolmaransstad West	PR	113	11,286	(2993072.06; -90230.1); (2992899.53; -92098.01); (2994527.77; -92663.56); (2994778.79; -90956.26); (2994436.87; -87335.31); (2996284.91; -87724.56); (2996989.2; -88664.35); (2995425.65; -89307.85); (2994722.18; -88435.19); (2994245.9; -88683.95); (2995039.9; -90693.81); (2995218.88; -91143.09); (2996610.32; -91726.51); (2996933.52; -91862.8); (2996490.85; -93004.03); (2997289.55; -93138.26); (2997560.4; -93655.98); (2997535.94; -94447.45); (2998482.97; -94687.06); (2998370.09; -95365.33); (2999873.7; -95679.37); (2999882.78; -94291.68); (3000983.33; -94556.29); (3000920.6; -93574.5); (3000871.16; -92165.89); (3004784.79; -92021.28); (3004839.41; -91285.62); (3007632.16; -91498.64); (3008448.03; -92668.89); (3009264.89; -88158.21); (3007985.52; -88100.22); (3008385.88; -83996.97); (3005009.7; -83730.02); (3003888.53; -83603.45); (3004213.83; -84513.36); (3001444.99; -84365.6); (2998817.8; -83989.48); (2998664.27; -86351.67); (2997758.7; -86319.85); (2996294.26; -85459.1);
	Zoutpan North	PR	59	5,946	(3049567.78; -28864.35); (3049493.5; -27056.99); (3051777.65; -26885.58); (3052586.49; -29214.86); (3055067.74; -25503.45); (3053722.24; -25670.2); (3054225.71; -29419.2); (3055695.38; -29603.03); (3056854.93; -23538.14); (3057853.1; -30176.78); (3058585.22; -30023.09); (3057534.91; -28050.99); (3057668.69; -23504.41); (3057702.27; -23501.26); (3057733.95; -23500.63); (3059833.35; -29749.43); (3061127.03; -29465.19); (3060454.17; -23391.47); (3062912.91; -30276.2); (3063186.6; -24343.62); (3066019.94; -26171.36); (3063829.17; -30619.98); (3067689.87; -27238.12);
	Palmietfontein North	PR	105	10,532	(3043576.14; -33328.13); (3043767.29; -34607.35); (3043903.2; -35549.08); (3044755.3; -35461.3); (3044909.46; -34668.86); (3047831.98; -34050.25); (3048117.82; -34806.55); (3045560.96; -35304.54); (3045249.49; -36419.86); (3046116.03; -36632.14); (3048637.02; -38180.74); (3050386.39; -39245.55); (3051658.87; -39493.15); (3052885.18; -39727.03); (3054464.26; -40029.19); (3057108.93; -40544.34); (3057252.33; -39692.67); (3058701.48; -39981.07); (3060303.57; -40288.62); (3061658.75; -41501.78); (3061914.6; -42202.07); (3061955.87; -42182.36); (3062008.72; -42256.14); (3061967.41; -42279.6); (3062412.58; -42939.23); (3062934.67; -43785.61); (3062974.47; -43666.14); (3062600.62; -42827.68); (3062729.7; -42459.75); (3062416.66; -41613.16); (3062923.23; -41504.03); (3063340.17; -41585.81); (3063108.86; -40967.9); (3064349.8; -40508.78); (3064527; -39718.54); (3063462.56; -39507.6); (3064380.86; -36691.04); (3063484.46; -36495.65); (3063425.34; -36713.97); (3063152.68; -36618.85); (3063025.4; -37142.18); (3062465.21; -37091.81); (3062120.31; -37067.76); (3061484.62; -36745.55); (3061234.84; -37182.21); (3058352.52; -34196.82); (3058403.6; -33981.17); (3055962.02; -33409.21); (3055357.58; -36070.34); (3054642.07; -36183.56); (3054526.88; -36123.85); (3054365.23; -36390.02); (3053668.55; -36719.48); (3053755.73; -36384.86); (3052515.47; -36149.33); (3053399.25; -32822.39); (3052264.76; -32559.2); (3050136.77; -31659.34); (3048948; -31157.99); (3048856.74; -31474.72); (3047764.12; -31030.23); (3047049.67; -31995.3); (3046759.83; -31239.92); (3046374.75; -31314.05); (3045364.69; -31510.85); (3044991.41; -31759.04); (3044729.12; -33235.04)
<b>TOTAL BLOEMHOF</b>			<b>368</b>	<b>36,765</b>	

Table 132 : Surface Rights Owners for the Bloemhof Project

PROJECT AREA	FARM NO.	FARM NAME	PORTION	SURFACE OWNER	TITLE DEED NO.
Bergspruit	363	Hartsrivier Diamant	1 (RE)	Botes Petrus Paulus	T11601/1977
			4	Badenhorst Balthazer Johannes	T19027/1972
	366	Goedgevonden	1 (RE)	Opkyk Familie Trust	T148220/2004
			2	Beukes Jacob Louis Frederick Jacobus	T72308/1991
			4	Rat 2 Boerdery Cc	T89175/2003
			5	Badenhorst Petrus Paulus	T20705/1998
			7	Rat 2 Boerdery Cc	T89175/2003
			10	Goedepan Landgoed Cc	T112008/2001
	386	Brodricks Valley	1	Mar-Deon Boerdery Cc	T147730/2002
	369	Bossieslaagte	3	Ansie Theunissen Trust	T103923/1998
			7	Nel Coenraad Frederick	T147728/2002
			9	Ansie Theunissen Trust	T3183/2002
	382	Simonsvallei	1 (RE)	Vuuren Jacobus Lukas Marthinus Van	T31984/1990
			10		T103923/1998
			11	Ansie Theunissen Trust	T160082/2004
			12		T103924/1998
	381	Vlakpan	4	Walters Johannes Hendrik	T19519/1992
			5	J C Botha Trust	T119542/1998
			6	Erasmus Frederik Johannes	T35647/1977
			9	Steyn Johan Daniel	T99963/1997
			10	Roux Willem Hendrik Le	T27878/1997
			13	J C Botha Trust	T119542/1998
			15		T119542/1998
16			Walters Johannes Hendrik	T19519/1992	
17				T19519/1992	
18				T19519/1992	
Wolmaransstad	367	Oshoek	9	Ansie Theunissen Trust	T3183/2002
	184	Wolmaransstad	20	Bester Hendrik Balthazer Klopper	T13730/1986
			23	Kuhn Magdalena Margaretha Catharina	T32701/1963
	180	De Put	0 (RE)	Wyk Johannes Jacobus Van	T30178/2003
			1	Botha Veeboerdery Pty Ltd	T62241/1995
			2		T62241/1995
			5	J J Van Wyk Boerdery Cc	T96974/1996
			6	Mietjiesdoorns Boerdery Pty Ltd	T115721/2000
	160	Tweeloop	0	Potgieter Lourens Marthinus	T36894/1984
	161	Weltevreden	0 (RE)	J J Van Wyk Boerdery Trust	T19224/2002
	156	Uitkyk	2 (RE)	Boetman Van Der Merwe Trust	T51604/1995
			4	Claase Jan Hendrik	T17332/1953
			6	Jacobs Andries Louis	T47981/1995
			7	Smit Isak Jacob	T11396/1987
	158	Boschrand	3 (RE)	Wesvaal Delwery Trust	T116404/2002
			5	Bester Louis Petrus Jacobus	T8313/1978
			9	Wesvaal Delwery Trust	T116404/2002
			11	Vuren Gert Pieter Janse Van	T23621/1993
			12	Vuren Matthys Johannes Janse Van	T38899/1993
		13	Willem Bester Trust	T128408/1997	

PROJECT AREA	FARM NO.	FARM NAME	PORTION	SURFACE OWNER	TITLE DEED NO.
Palmietfontein	294	Zendelingsfontein	0 (RE)	Boschkop Varkboerdery Trust	T30049/2002
			2	Nieman Willem Adriaan	T69811/1989
			12	Saunders Hester Sophia	T10050/2006
	295	Palmietfontein	5 (RE)	Wyk Daniel Jacobus Van	T30010/1989
			21 (REt)		T30010/1989
			22	Mienie Christoffel Christiaan	T174834/2003
			23	Wyk Daniel Jacobus Van	T30010/1989
			26 (RE)	Beer Jacobus Wilhelmus De	T82870/2001
			28	Wyk Daniel Jacobus Van	T30010/1989
	271	Sterkfontein	0 (RE)	Toit Henry Du B-E	T57462/2004
			1	Bornman Adriana Brink	T24386/1986
			2	A L & R Trust	T142008/1999
			3 (RE)	Hennig Jacob	T43322/1988
			4	Nieman Willem Adriaan	T69811/1989
			7	Beldiam Trust	T50003/2000
	267	Holfontein	1 (RE)	P G Familie Trust	T140543/1999
			2 (RE)	Mcleod Johannes Cornelius George Benjamin	T14481/1978
			5 (RE Ext)	Bezuidenhout Jeremia Jesaja	T71205/1991
			8	Beldiam Trust	T50003/2000
			9	P G Familie Trust	T104016/2004
12			T10898/2006		
13			T140543/1999		
14			Koen Christa	T43610/1988	
16	A L & R Trust	T142008/1999			
Zoutpan	265	Gezicht	0 (RE)	Surida Trust	T154924/2004
			9	Silver Charm Inv 63 Pty Ltd	T165828/2003
	273	Kafferpan	0 (RE)	Mcleod Johannes Cornelius George Benjamin	T4905/1984
			1	Bloubospan Trust	T124618/2005
			2	Stefan Van Zyl Trust	T22497/1997
			3		T22497/1997
	4	Mcleod Johannes Cornelius George Benjamin	T4905/1984		
	293	Blaauboschpan	0 (RE)	Naude Marina Theron	T21579/1991
			1 (RE)	Strauss Sanette	T21598/1977
			2	Bloubospan Trust	T71740/1991
			3	Naude Marina Theron	T21579/1991
	302	Holwater	1 (Re)	S H Trust	T154398/2002
			3 (Re)	H C Trust	T3840/2005
			6	Mcleod Richard Moffat	T76295/2002



**Table 133 : Legal Rights Pertaining to the Bloemhof Project**

PROJECT AREA	FARM NAME	PTN NO.	PERMIT NO.	LICENCE HOLDER	AREA (ha)	EXPIRY DATE	EMP APPROVED	REHAB MONIES PAID (ZAR)
Bergspruit	Hartsvierdiamant 363 IO	4	NW30/5/1/ 1/2/1040 PR	Upward Spiral	6,601	Jan-08	Approved	20,000
	Goedgevonden 366 IO	Re, 1,2,4,5,7, 10						
	Brodricks Valley 386 IO	1						
	Bossieslaagte 369 IO	Re, 1-3, 7-9						
	Simonsvallei 382 IO	Re, 1, 10-12						
	Vlakpan 381 IO	4-6,9,10, 13,15-18						
	Oshoek 367 IO	9						
Wolmaransstad West	Wolmaransstad 184 HO	20,23	NW30/5/1/ 1/2/971 PR	Upward Spiral	11,286	Jun-08	Approved	20,000
	De Put 180 HO	Re, 1,2,5,6						
	Tweeloop 161 HO	Re						
	Weltevreden 161 HO	Re						
	Uitkyk 156 HO	2,4,6,7						
Boschrand 158 HO	3,5,9, 13, 11							
Palmietfontein North	Zendelingsfontein 294 HO	2, 12	NW30/5/1/ 1/2/972 PR	Upward Spiral	10,532	Jan-09	Approved	20,000
	Palmietfontein 295 HO	5, 21, 22, 23,26,28						
	Sterkfontein 271 HO	Re, 1-7						
	Holfontein 276 HO	1,2,5,8,9,12- 14,16						
Zoutpan North	Gezicht 265 HO	Re, 2,6,7,9	NW30/5/1/ 1/2/973 PR	Upward Spiral	5,946	Jan-08	Approved	20,000
	Kafferpan 273 HO	Re, 1,2,3,4						
	Blaauwboschpan 293 HO	Re,1,2,3						
	Holwater 302 HO	1,3,6						
<b>TOTALS</b>					<b>34,365</b>			<b>80,000</b>

Tabacks reviewed the legal status of the Bloemhof Project licences and found the following:-

- the licences are valid, binding and enforceable;
- there are no impediments to prospecting and mining activities relating to the prospecting right;
- the holders of the prospecting rights are in compliance with their obligations under the prospecting rights; and
- PDF has paid all applicable prospecting fees.

Messrs Bekker & Strauss are jointly entitled to subscribe for up to a 5% interest in the Bloemhof Project by funding such project from the Bankable Feasibility stage, failing which they shall be entitled to a 2.5% free carried interest in the project.

### 34.1.2 Royalties, Fees and Taxes

The Royalties Bill is expected to be instituted in 2009 and in a report published in October 2006; a royalty of 5% was suggested for unpolished diamonds. The South African company tax rate is 30%. VAT of 14% is payable on all local services and purchases.

### 34.1.3 Impact of the Project on the Environment

An EMP for the Bloemhof Project has been approved by the DME. An amount of ZAR80,000 has been paid by PDF into an exploration rehabilitation trust fund, as required by the DME, for the rehabilitation of the four project area, as indicated in Table 133. PDF will ensure that the effect on the environment is minimised.

## 34.2 Accessibility, Climate, Local Resources, Infrastructure and Physiography

### 34.2.1 Locality, Population and Access

The Bloemhof Project is situated between the towns of Delareyville and Bloemhof in the North West Province. The North West Province has a population of approximately 3,7 million which accounts for approximately 8.2% of South Africa's population.

Access (Figure 114) to the Bergspruit and Wolmaransstad West Project Areas is via either the main R47 tarred road running between the towns of Delareyville and Vryburg, or two secondary roads, the 506 and the 507, running from Delareyville to Schweitzer Reneike and Ottosdal respectively.

Access (Figure 115) to the Palmietfontein and Zoutpan is via good secondary roads that branch off the main N12 highway that runs between Johannesburg and Kimberley.

### 34.2.2 Infrastructure and Local Resources

The general infrastructure is well established for the Bloemhof Project and is shown in Figure 114 and Figure 115.

Water is sourced from boreholes on the farms incorporated in the Bloemhof Project. In cases where perennial rivers are located on farms, water can be sourced from these rivers, such that no damage is done on the environment. Water is only required for domestic purposes.

Electricity to the property area is sourced from Eskom power grids.

### 34.2.3 Climate and Vegetation

The climate experienced at the Bloemhof Project is typically warm summers and dry cool winters, with the temperatures ranging from a winter minimum of 3°C to a summer maximum of 40°C. The annual rainfall in the area ranges from 250mm in the south (Bloemhof) and 450mm in the north (Wolmaransstad).

The Bloemhof Project Area consists of wide, open areas of grasslands of the high inland plateau.

### 34.2.4 Physiography

The Bloemhof Project's topography consists of savannah grasslands and is topographically flat. The elevation varies between 1,200m amsl and 1,350m amsl.

## 34.3 History

There have been no known previous owners of the Bloemhof Project.

### 34.3.1 Historical Exploration, Sampling and Production Records

Diamond diggers first located the diamondiferous alluvial gravels of the Vaal River in the vicinity of Christiana and Bloemhof in the mid 1880s, and from there, progressively extended their prospecting activities north and north-eastward. By 1912, the rich diggings on Mooifontein and London, south of Schweitzer Reneike, had been discovered, as had the equally rich deposits to the southwest of Wolmaransstad.

The bulk of the production from the field took place in the 1920s, although digging activities on a smaller scale have been more or less continuous since then. A total production of 2,117,380cts has been recorded from 226 farms in the diamond-field, up to the end of 1989, 12 of the farms having recorded over 50,000cts each.

Table 134 details the production of diamonds up to and including 1987, that took place on the Bloemhof Project properties.

**Table 134 : Historical Alluvial Diamond Production for the Bloemhof Project**

BLOCK NAME	FARM NAME AND NUMBER	PRODUCTION (ct)
Wolmaransstad West	Boschrand 158 HO	22.25
	Wolmaransstad184 HO	1,644.00
Bergspruit	Bossieslaagte 369 IO	<10
	Oshoek 367 IO	3.5
Palmietfontein	Zendelingsfontein 294 HO	665.82
	Holfontein 267 HO	148.7
Zoutpan	Kafferpan273 HO	3,423.46
	Gezicht 365 HO	1,186.45
<b>TOTAL</b>		<b>~ 7,094.18</b>

### 34.3.2 Historical Diamond Resources

No historical Diamond Resource estimates have been undertaken for the Bloemhof Project.

## 34.4 Geological Setting

### 34.4.1 Regional Geological Setting

The regional geology of the Bloemhof Project is the similar to that pertaining to the adjacent Harts River Project and is described in Section 31.4.1. The Bloemhof Project is, however, underlain by the Ventersdorp Supergroup.

### 34.4.2 Local and Property Geology

The Bloemhof Project is broadly underlain by Ventersdorp lavas or Karoo Supergroup shales. The surface on which the gravels are deposited is crudely planar, with a shallow southwesterly dipping slope. The planar surface of the lavas generally exhibits a weathering pattern similar to that of the dolomites, with gullies and potholes eroded into structural trends and intersections, but, in contrast to the dolomite, these surfaces are smoothly rounded. The topographic lows are the trap sites for the alluvial deposits. Section 31.4.2 describes the local geology for the Bloemhof Project and Table 107 outlines the typical types of gravels found in the Bloemhof Project.

## 34.5 Deposit Type

The Bloemhof Project consists of secondary alluvial diamond deposits, within north-south trending valleys, which are interpreted as palaeo-channels.

## 34.6 Mineralization

All gravels in the project areas are composed mostly of smoothed and rounded clastics varying in size from very fine river washed sand to boulders that may exceed a meter in diameter. The Bloemhof Project generally consists of fine to medium gravel material. The source of the diamonds is still unclear, suggestions of the source of the diamonds found in this project include:-

The source of the diamonds is currently unknown.

A stratigraphic for the Zoutpan Project Area is shown in Figure 117.

**LEGEND:**

- Planned Drilling
- Completed Drilling
- Drillhole in poor to reasonable gravel
- Drillhole in no gravel
- ▬ Channel outline
- ▬ Trace of deepest portion of channel
- ▬ Gravel outline interpretation
- ▭ Zoutpan Gravel Blocks

**LOCATION OF EXPLORATION AND STRATIGRAPHIC COLUMN FOR ZOUTPAN PROJECT AREA**

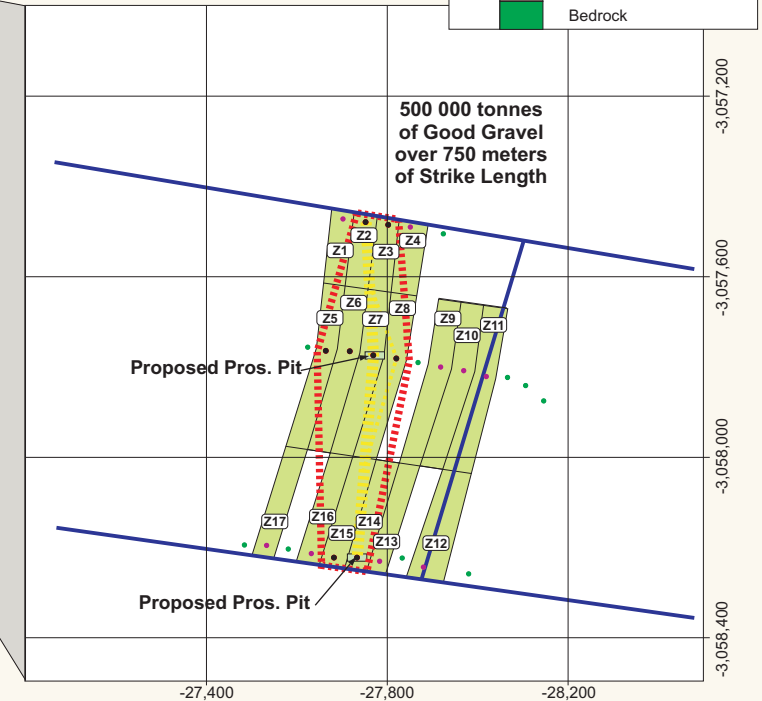
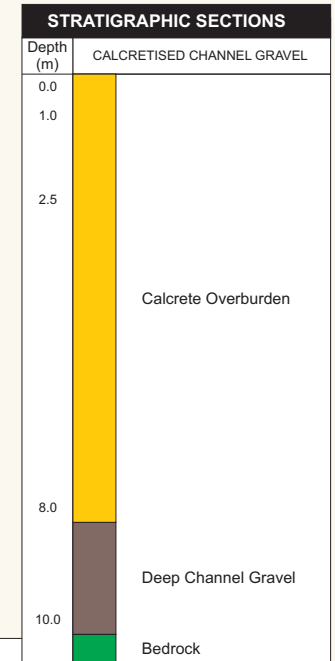
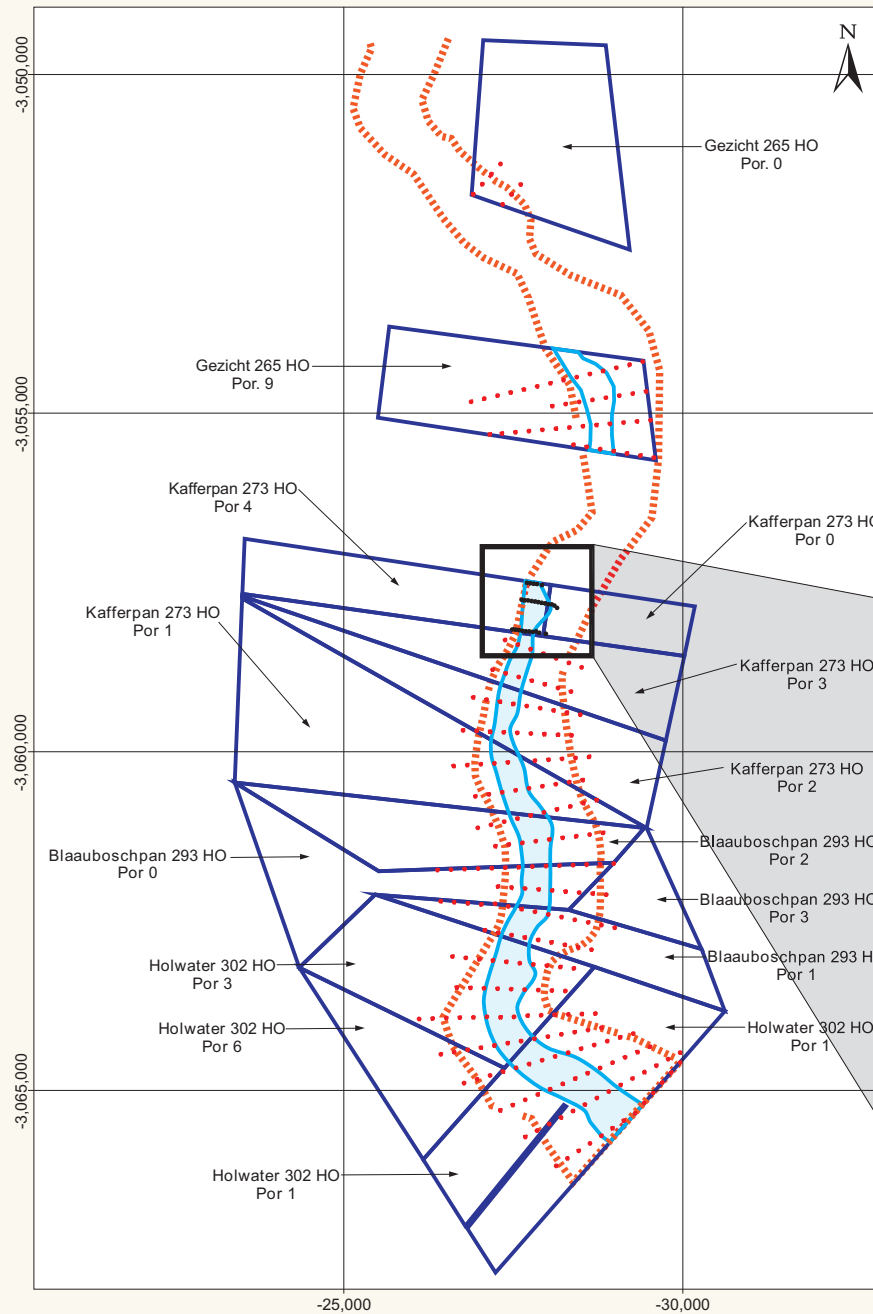

PangeaDFieldsTSX'07Fig117.cdr

Source: Pangea

This diagram and the information therein are copyrighted. It may not be reproduced or transmitted in any form or by any means without prior written permission from Venmyn Rand (Pty) Ltd. Trading as Venmyn.

## 35 BLOEMHOF PROJECT – ZOUTPAN PROJECT AREA

### 35.1 Exploration

Exploration has only been completed on the Zoutpan Project Area. The exploration programme includes percussion drilling with bulk sampling planned for the near future.

### 35.2 Percussion Drilling

Percussion drilling commenced in February 2007 in order to delineate the extent of the gravels and model the thickness and overburden in the project area.

#### 35.2.1 Sampling Method and Approach

The sampling method and approach employed by PDF is described in 32.2.1. A detailed description of the drill rig at Pampierstad is also provided in Section 32.2.1.

A total of 27 percussion drill holes were drilled on the Zoutpan Project Area, Ptn 4 and 0 of Kafferpan 273 HO (Figure 117). The location of the percussion drilling is show in Figure 117. Drill holes varied in depth from 3m to 21m and were drilled into bedrock. The diameter of the holes was 16.5cm. The boreholes were named with the prefix Z, which indicates Zoutpan samples and were numbered sequentially beginning at 1. The collar elevations were surveyed using a handheld GPS by the on site geologist.

#### 35.2.2 Sample Preparation, Analyses and Security

This section is not applicable, since no samples were taken.

#### 35.2.3 Data Verification

All results were entered into an Excel database which was checked and verified by the PDF geologist at head office in South Africa. The data was verified by checking random samples in the database from the logsheets. Senior geologists from PDF also conduct spot checks onsite, again using random checks of the logging of samples both onsite and in the storeroom. The checks compared well to the original logs.

Venmyn has not verified the database in detail but has witnessed the rigorous process of verification which PDF's headoffice geologist undertakes. This being the case, the Qualified Person is satisfied that this process of verification will minimise error in data entry and identify any inconsistencies in the actual sample data and the database entries.

#### 35.2.4 Results

The percussion drilling delineated the vertical and horizontal extent of gravels within the Zoutpan Project Area.

The percussion drilling was used to model gravel thickness and overburden on the Zoutpan Project Area in Surfer®. The thicknesses were modelled in Surfer® by gridding the data using an inverse distance squared method of estimation. All data points were used in the estimation, since no search radius was used. No search radius was used in order to obtain overall accurate thicknesses values for the Bloemhof Project Area. Summary statistics from the modelling are shown in Table 135.

**Table 135 : Summary Statistics for the Zoutpan Project Area Modelling**

PROJECT AREA	BLOCK	NO. DATA POINTS	GRAVEL THICKNESS (m)			OVERBURDEN THICKNESS (m)		
			MIN	MAX	AVE	MIN	MAX	AVE
Zoutpan	All	17	0.11	2.99	1.10	3.02	8.49	6.88
	<b>TOTAL</b>	17						

The modelling results are contoured in Figure 118. The plots indicate that the gravel varies between 0.5m and 3m with a north-south trend of thick gravels. The overburden plots show a similar north-south trend of thicker overburden, varying from 3m to 8.5m thick.

**35.3 Adjacent Properties**

Recorded production until 1989 for the surrounding areas is shown in Figure 115.

**35.4 Mineral Processing and Metallurgical Testing**

No mineral processing has occurred at the Bloemhof Project.

**35.5 Diamond Resource and Diamond Reserves Estimate**

Due to paucity of information no Diamond Resources have been declared.

**35.6 Other Relevant Data and Information**

There is no other relevant data or information which should be presented to ensure that this report is not misleading in anyway.

**35.7 Interpretation and Conclusions**

Only limited exploration has been conducted on the Zoutpan Project Area. Percussion drilling was completed in order to delineate the extent of the gravels and to model gravel thicknesses and overburden in the project area. The modelling identified a thicker gravel on a north-south trend in the Zoutpan Project area, however the overburden is greater than 6m in most parts of the project.

The exploration results to date have been verified and methods independently checked by Venmyn.

**35.8 Recommendations**

The recommended work programme for the South African projects, including the Bloemhof Project is tabulated in Table 122. Venmyn has assisted PDF in the compilation of the work programme and budget in respect of the Bloemhof Project and recommends that the company undertake the programme as stated therein. The expected revenues to be derived from the sale of diamonds extracted during exploration pitting, bulk sampling and pilot mining are shown in Table 123.

**36 BLOEMHOF – PALMIETFONTEIN PROJECT AREA****36.1 Exploration**

No recent exploration has been carried out by PDF on the Palmietfontein Project Area. The company does plan to utilise the exploration methods used for other Bloemhof projects.

**36.2 Adjacent Properties**

Recorded production until 1989 for the surrounding areas is shown in Figure 114.

**36.3 Mineral Processing and Metallurgical Testing**

No mineral processing has occurred at the Bloemhof Project.

**36.4 Diamond Resource and Diamond Reserves Estimate**

Due to paucity of information no Diamond Resources have been declared.

**36.5 Other Relevant Data and Information**

There is no other relevant data or information which should be presented to ensure that this report is not misleading in anyway.

**36.6 Interpretation and Conclusions**

Due to paucity of exploration results no interpretations and conclusions can be made in this point in time.

**36.7 Recommendations**

The recommended work programme for the South African projects, including the Bloemhof Project, is tabulated in Table 122. The expected revenues to be derived from the sale of diamonds extracted during exploration pitting, bulk sampling and pilot mining are shown in Table 123.

**CONTOUR PLOTS OF GRAVEL AND OVERBURDEN THICKNESSES FOR THE ZOUTPAN PROJECT AREA**

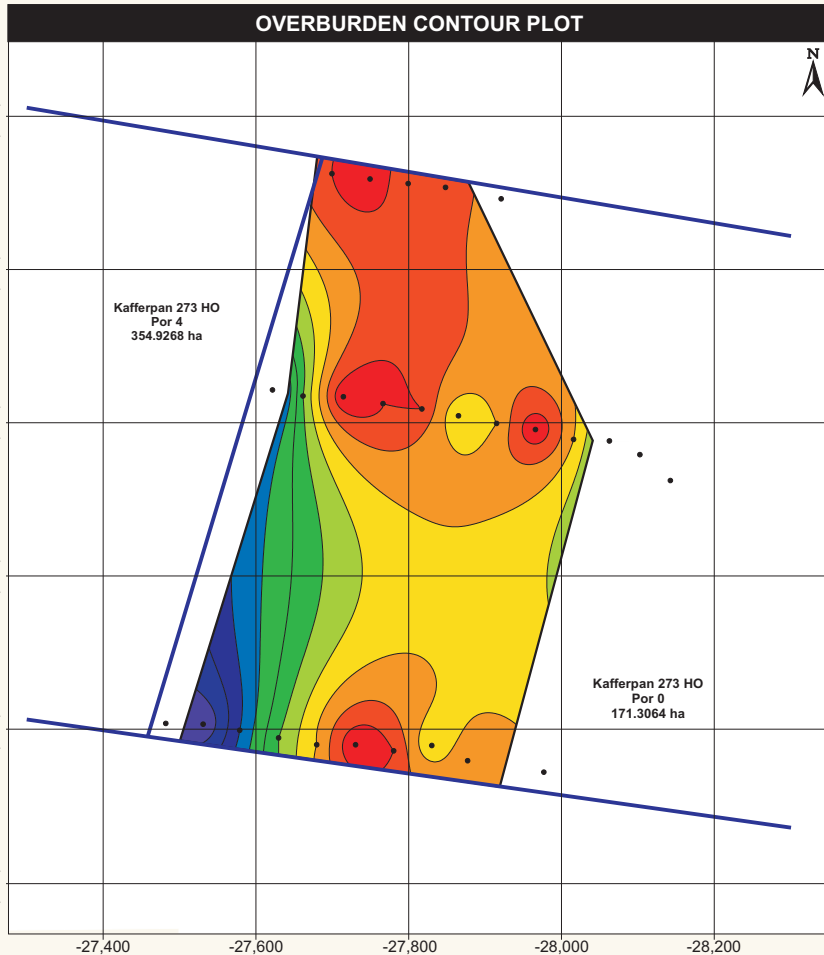
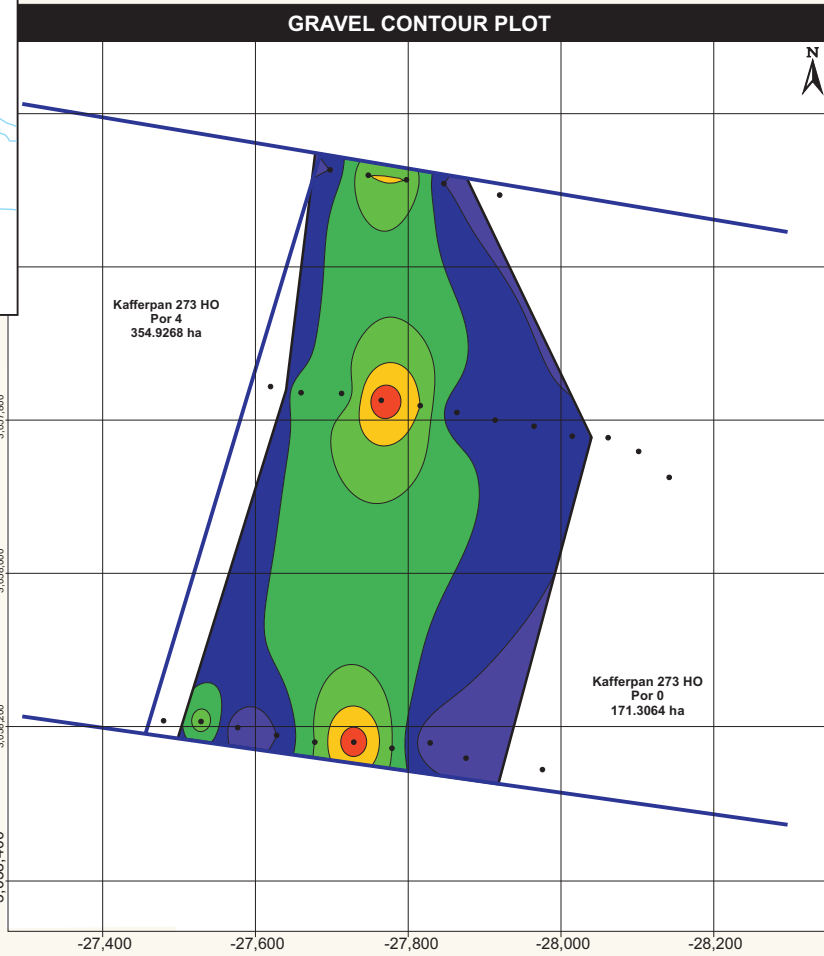
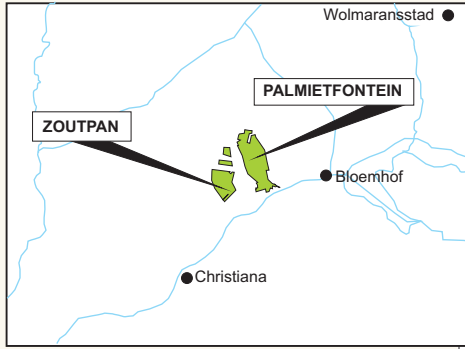

PangeaDFieldsTSX'07Fig118.cdr

Source: Pangea

This diagram and the information therein are copyrighted. It may not be reproduced or transmitted in any form or by any means without prior written permission from Venmyn Rand (Pty) Ltd. Trading as Venmyn.

### **37 BLOEMHOF PROJECT – BERGSPRUIT PROJECT AREA**

#### **37.1 Exploration**

No recent exploration has been carried out by PDF on the Bergspruit Project Area. The company does plan to utilise the exploration methods used for other Bloemhof projects.

#### **37.2 Adjacent Properties**

Recorded production until 1989 for the surrounding areas is shown in Figure 114.

#### **37.3 Mineral Processing and Metallurgical Testing**

No mineral processing has occurred at the Bloemhof Project.

#### **37.4 Diamond Resource and Diamond Reserves Estimate**

Due to paucity of information no Diamond Resources have been declared.

#### **37.5 Other Relevant Data and Information**

There is no other relevant data or information which should be presented to ensure that this report is not misleading in anyway.

#### **37.6 Interpretation and Conclusions**

Due to paucity of exploration results no interpretations and conclusions can be made in this point in time.

#### **37.7 Recommendations**

The recommended work programme for the South African projects, including the Bloemhof Project, is tabulated in Table 122. The expected revenues to be derived from the sale of diamonds extracted during exploration pitting, bulk sampling and pilot mining are shown in Table 123.

### **38 BLOEMHOF PROJECT – WOLMARANSSTAD PROJECT AREA**

#### **38.1 Exploration**

No recent exploration has been carried out by PDF on the Wolmaransstad Project Area. In 200x PDF plan to commence with the exploration methods used for Zoutpan Project Area..

#### **38.2 Adjacent Properties**

Recorded production until 1989 for the surrounding areas is shown in Figure 115.

#### **38.3 Mineral Processing and Metallurgical Testing**

No mineral processing has occurred at the Bloemhof Project.

#### **38.4 Diamond Resource and Diamond Reserves Estimate**

Due to paucity of information no Diamond Resources have been declared.

#### **38.5 Other Relevant Data and Information**

There is no other relevant data or information which should be presented to ensure that this report is not misleading in anyway.

#### **38.6 Interpretation and Conclusions**

Due to paucity of exploration results no interpretations and conclusions can be made in this point in time.

#### **38.7 Recommendations**

The recommended work programme for the South African projects, including the Bloemhof Project, is tabulated in Table 122. The expected revenues to be derived from the sale of diamonds extracted during exploration pitting, bulk sampling and pilot mining are shown in Table 123.



## 39 REFERENCES

AUTHOR	DATE	TITLE	SOURCE
Coastal & Environmental Services	2006	Dimbi Diamond Concession Project Central African Republic, Exploration Phase, Environmental plan.	Coastal & Environmental Services
Coastal & Environmental Services	2006	Pangea Diamond Fields plc, Preliminary Environmental Assessment Report, Dimbi Diamond Concession, Central African Republic.	Coastal & Environmental Services
Du Toit. A.L	1951	The Diamondiferous Gravels of Rustenburg	South African Geological Survey, Memoir 44.
Haumann. J.J and Bloomer. A.G	1997	The Nzako Concession	Pangea DiamondFields Internal Report
Haumann. J.J and Bloomer. A.G	1997	The Bangana Concession	Pangea DiamondFields Internal Report
Janse van Rensburg. J	2007	Efidium DRC Exploration SPRL. Progress Report on PEPM 665, PR 3014, PR 3015 (Leta Project). Tshikapa River Project.	Pangea DiamondFields Internal Report
Janse van Rensburg. J	2007	Report on Concession PR 5744	Pangea DiamondFields Internal Report
Lemmer. C	2008	Independent Study of the Potential Diamond Resources of the Mbia East Portion of the Dimbi Project	Carina Lemmer
Morton. D	2007	Kajama Project	Pangea DiamondFields Internal Report
Morton. D	2007	Katamasole Area Prpject (Yusufu)	Pangea DiamondFields Internal Report
Pangea DiamondFields	2008	Diamond Price Estimates - Supporting Documentation	Pangea DiamondFields Internal Report
Trans Hex	2007	Trans Hex Annual Report	Trans Hex. <a href="http://www.transhex.co.za/">http://www.transhex.co.za/</a>
Venmyn	2006	Competent Persons Report on the Diamond Mining and Exploration Assets of Pangea Diamondfields plc for a listing on the AIM market of the London Stock Exchange.	Venmyn
Verkes. J	2007	Exploration Report Nzako Etoile Diamnd Concession. Phase 1 Reconnaissance.	Pangea DiamondFields Internal Report

**40 DATE AND SIGNATURE PAGE**

The effective date of this report is 31<sup>st</sup> March 2008. The “qualified persons” (within the meaning of NI43-101) responsible for preparing this report are Ms. Catherine A. Telfer

Signed the 31<sup>st</sup> day of March



---

**CATHERINE A. TELFER**  
B.Sc. Hons (Geol.), (DMS) Dip. Bus. Man.  
Pr. Sci. Nat., MGSSA, MAusIAMM  
**DIRECTOR, VENMYN**

## 41 CERTIFICATES OF QUALIFIED PERSONS

### CERTIFICATE OF QUALIFIED PERSON CATHERINE ANNE TELFER

FIRST FLOOR, BLOCK G  
ROCHESTER PLACE  
173 RIVONIA ROAD  
SANDTON 2146  
SOUTH AFRICA

I, Catherine Anne Telfer, do hereby certify that:-

1. I hold a BSc Geology degree as well as a BSc Geology degree with Honours (obtained in 1992) from University of the Witwatersrand, South Africa. I hold a diploma in Business Management from Damelin College (obtained in 1997). I am a director of Venmyn Rand (Pty) Limited.
2. I am a member in good standing of the following PROFESSIONAL ASSOCIATIONS:-

CLASS	PROFESSIONAL SOCIETY	YEAR OF REGISTRATION
Member	The South African Council for Natural Scientific Professionals	2002
Member	Australasian Institute of Mining and Metallurgy	1996
Member	Geological Society of South Africa	1992

3. I have practised my profession continuously since graduation in 1992. My relevant experience for the purpose of the Technical Report is:-

YEAR	CLIENT	COMMODITY	PROJECT DESCRIPTION
2008	Gem Diamonds Ltd	Diamonds	Preparation of Independent Resource Statements for all their operations and exploration projects.
2007	Espiritos dos Santos (ESCOM)	Diamonds	Competent Persons Report on ESCOM's diamond assets in Angola including Luo Mine.
	Gem Diamonds Ltd	Diamonds	High level due diligence and valuation report on Gope Project.
2006	Letseng Diamonds Ltd	Diamonds	CPR for listing of Gem Diamonds.
	JCI, Matodzi & Investec	Diamonds	Update of Competent Persons Report on Letseng Diamonds.
	Carbon Technologies	Diamonds	Plant verification report on the Laser Recovery Unit.
	Carbon Technologies	Diamonds	Prospectivity and geological mapping report on Grasfontein.
	Pangea DiamondFields plc	Diamonds	AIM Listing document for 9 projects in 4 African countries.
	Trans Hex Group	Diamonds	Competent Persons Report on the Middle Orange Operations.
2005	JCI, Matodzi & Investec	Diamonds	Competent Persons Report on Letseng Diamonds.
	Energem	Diamonds	Technical Report on the Koidu Project in National Instrument format for Canadian Stock Exchange.
	Two private and one listed company	Diamonds	Preparation of Report for AIM on 18 projects in five African countries.
	Dwyka Diamonds	Diamonds	Prospectivity Report on Blaauwbosch Mine
	Dwyka Diamonds	Diamonds	Technical due diligence and valuation report on Dancarl Diamonds for the sales bid to De Beers.
	Rosy Blue NV	Diamonds	Field exploration and prospectivity report on property.
2002	SouthernEra Resources	Diamonds	Independent valuation of 22 exploration properties and mining operations located in five African countries.
	Consolidated African Mines	Diamonds	Independent due diligence, valuation report and fair and reasonable opinion for the shareholders and directors of CAM on the proposed acquisition of a 40% interest in Letšeng Investment Holdings from Letšeng Diamonds Ltd.
2001	DeBeers	Diamonds	Costing Research and Database Compilation
1998	Camco	Diamonds	Independent Competent Person's Report and valuation
1994	Namco	Diamonds	Competent Person's Report and valuation

4. I have read the definition of a “qualified person” as set out in National Instrument 43-101 (NI43-101) and certify that by reason of my education, affiliation with a Professional Association (as defined by in NI43-101) and past relevant experience, I fulfil the requirements to be a “qualified person” for the purposes of NI43-101.
5. I am responsible for all items of the Technical Report dated March 2008 and entitled “National Instrument 43-101 Technical Report on the Dimbi and Etoile Projects in Central Africal Republic (CAR), Tshikapa River and Longatshimo River Projects in Democratic Republic of Congo (DRC), Cassanguidi Project in Angola, and Bakerville, Harts River and Bloemhof Projects in South Africa of Pangea Diamondfields plc” (the Technical Report).
6. I have had prior involvement with all the projects, except Etoile, through the preparation of Pangea Diamondfields’ listing document for its primary listing the AIM Market of the London Stock Exchange in 2006.
7. I have personally visited the Cassanguidi, Dimbi, Longitshimo River, Tshikapa River, Bakerville and Harts River Projects between 2006 and 2008. Details of the visits are included in Table 5 of this report.
8. As of the date of this Certificate, to the best of my knowledge, information and belief, the Technical Report contains all scientific and technical information that is required to be disclosed to make the Technical Report not misleading.
9. I am independent of Pangea Diamondfields, as set out in section 1.4 of NI43-101.
10. I have read NI43-101 and Form 43-101F1, and the Technical Report has been prepared in compliance with NI43-101 and Form 43-101F1.
11. I consent to the filing of the Technical Report with any stock exchange and other regulatory authority and any publication by them, including electronic publication in the public company files on their website accessible by the public.

Dated the 31<sup>st</sup> March 2008.



---

**CATHERINE A. TELFER**  
B.Sc. Hons (Geol.), (DMS) Dip. Bus. Man.  
Pr. Sci. Nat., MGSSA, MAusiAMM  
**DIRECTOR, VENMYN RAND (PTY) LIMITED**

**CERTIFICATE OF QUALIFIED PERSON  
ANTHONY GERARD BLOOMER**

**FIRST FLOOR, BLOCK G  
ROCHESTER PLACE  
173 RIVONIA ROAD  
SANDTON 2146  
SOUTH AFRICA**

I, Anthony Gerard Bloomer, do hereby certify that:-

1. I hold a BSc with Honours (obtained in 1963) from University of Leeds, England. I am a Consulting Geologist and an Associate of Venmyn Rand (Pty) Limited.
2. I am a member in good standing of the following PROFESSIONAL ASSOCIATIONS:-

CLASS	PROFESSIONAL SOCIETY	YEAR OF REGISTRATION
Member	Geological Society of South Africa	1972
Member	South African Geophysical Association	1977
Member	Society of Exploration Geochemists	1979 - 1996
Member	Natural Scientist Institute of South Africa	2002

3. I have practiced my profession continuously since 1965. My relevant experience for the purpose of the Technical Report is:-

YEAR	CLIENT	COMMODITY	PROJECT DESCRIPTION
2007	Venmyn (Namakwa Diamonds)	Diamonds	Evaluation of alluvial diamond properties in the DRC and South Africa.
2007	Venmyn (Espirito Santo [ESCOM])	Diamonds	Competent Persons Report on ESCOM's diamond assets in Angola including Luo Mine.
2006	Venmyn (Corvus)	Diamonds	Evaluation, testing and redesign assistance of laser-based diamond recovery unit
2006	Venmyn (Pangea)	Diamonds	Evaluation of alluvial diamond properties in the C.A.R., Angola and South Africa
2006	Venmyn (Trans Hex)	Diamonds	Evaluation of alluvial diamond properties on the Middle Orange River
2005	Venmyn (Corvus)	Diamonds	Prospectivity assessment of alluvial diamond properties in the Lichtenburg Diamond Fields
2005	Venmyn (Energem)		Evaluation of alluvial diamond properties in Angola
2005	Venmyn (Pangea)	Diamonds	Evaluation and exploration planning of alluvial diamond properties in Angola
2005	Venmyn (Letseng Diamonds)	Diamonds	Evaluation of the Letseng Kimberlite pipe
2005	Venmyn (Energem)	Diamonds	Re-evaluation of alluvial diamond properties, air photography of the properties, and exploration planning in the CAR.
2005	Venmyn (Koidu)	Diamonds	Evaluation of alluvial diamond and kimberlite diamond properties in Sierra Leone
2005	Venmyn/Kensington Resources)	Diamonds	Independent audit of De Beers GEMDL facility.
2005	Venmyn (Samadi)	Diamonds	Evaluation of kimberlite and alluvial diamond properties in the Northern and North West provinces.
2004	Venmyn (NDC)	Diamonds	Re-evaluation of the Schmidtsdrift alluvial diamond project
2004	Venmyn	Diamonds	Prospecting, mapping and evaluation of the Slangheuwel alluvial and kimberlite diamond property.
2004	Venmyn (Dwyka)	Diamonds	Evaluation of the Dancarl, Blaauwbosch, Newlands, New Elands, Roberts Victor and West End diamond mines
2004	Venmyn	Diamonds	Mapping and prospectivity evaluation of an alluvial diamond/kimberlite property in the Northern Cape
2004	Venmyn (Letseng Diamonds)	Diamonds	Planning a resource drilling programme on the Letseng Satellite kimberlite.
2003	Letseng Diamonds	Diamonds	Examination, sampling and evaluation of the alluvial diamond deposits associated with the Letseng kimberlites, Lesotho.
2003	Venmyn(DiamondWorks)	Diamonds	Update and expansion of the evaluation of the Sierra Leone Properties.
2003	Venmyn/Kensington Resources)	Diamonds	Independent audit of De Beers GEMDL facility.
2002	Venmyn(African Diamonds)	Diamonds	Collation of data for certain marine diamond concessions off the coast of Namibia.

2002	Venmyn(AIG)	Diamonds	Evaluation and verification of data for alluvial and kimberlite diamond projects in the Northern Cape.
2002	Venmyn(DiamondWorks)	Diamonds	Project evaluation and verification of kimberlites in Sierra Leone.
2002	Venmyn )Consolidated African Mines)	Diamonds	Data compilation, interpretation and evaluation of the Letseng Kimberlite pipes, Lesotho.
2001/2	Alcaston Mining	Diamonds	Kimberlite diamond project evaluation in the Free State and Northwest Provinces of South Africa.
1998	Private Investor	Diamonds	Detailed evaluation of alluvial diamond projects in the (then) Western Transvaal.
1997	CAMCO	Diamonds	Data collection and evaluation of the alluvial diamond potential of the Central African Republic. Selection of lease areas. Detailed evaluation of the selected leases
1994-1995	Rio Tinto South Africa Exploration	Diamonds	Establishment, supervision and staff training for grass roots exploration in Zimbabwe and Namibia
19887-1988	Rio Tinto South Africa Exploration	Diamonds	Evaluation programme of offshore diamond projects off the West Coast of South Africa
1981-1983	Rio Tinto South Africa Exploration	Diamonds	Exploration, project development and field investigations for the Mafikeng Diamonds
1971-1972	Rio Tinto South Africa Exploration	Diamonds	Geologist/Surveyor to the Letseng la Terai kimberlite pipe evaluation programme, Lesotho

4. I have read the definition of a “qualified person” as set out in National Instrument 43-101 (NI43-101) and certify that by reason of my education, affiliation with a Professional Association (as defined by in NI43-101) and past relevant experience, I fulfill the requirements to be a “qualified person” for the purposes of NI43-101.
5. I have contributed to Items 8 -16 for the various projects of the Technical Report dated March 2008 and entitled “National Instrument 43-101 Technical Report on the Dimbi and Etoile Projects in Central Africal Republic (CAR), Tshikapa River and Longatshimo River Projects in Democratic Republic of Congo (DRC), Cassanguidi Project in Angola, and Bakerville, Harts River and Bloemhof Projects in South Africa of Pangea Diamondfields plc” (the Technical Report).
6. I have had prior involvement with the Cassanguidi, Bakerville, Harts River and Bloemhof Projects through the preparation of Pangea Diamondfields’ listing document for its primary listing the AIM Market of the London Stock Exchange in 2006.
7. I have had prior involvement with the Etoile Project through research carried out in 1996/7 for CAMCO.
8. I have personally visited the Etoile, Cassanguidi, Bakerville, Harts River and Bloemhof Projects and Harts River Projects between 1996 and 2007. Details of the visits are included in Table 5 of this report.
9. As of the date of this Certificate, to the best of my knowledge, information and belief, the Technical Report contains all scientific and technical information that is required to be disclosed to make the Technical Report not misleading.
10. I am independent of PDF as set out in section 1.4 of NI43-101.
11. I have read NI43-101 and Form 43-101F1, and the Technical Report has been prepared in compliance with NI43-101 and Form 43-101F1.
12. I consent to the filing of the Technical Report with any stock exchange and other regulatory authority and any publication by them, including electronic publication in the public company files on their website accessible by the public.

Dated the 31<sup>st</sup> of March, 2008.



Anthony Gerard Bloomer

### Appendix 1 : Compararive Diamond Size Classification Schemes

GRAIN SIZE RANGES		
GRAIN SIZE	FROM - CTS	TO - CTS
10.8	10.8	
10c	9.8	10.79
9c	8.8	9.79
8c	7.8	8.79
7c	6.8	7.79
6c	5.8	6.79
5c	4.8	5.79
4c	3.8	4.79
3c	2.8	3.79
10grn	2.5	2.79
8grn	1.8	2.49
6grn	1.4	1.79
5grn	1.2	1.39
4grn	0.9	1.19
3grn	0.66	0.89

SIEVE SIZES		
SIEVE	APPROX. CRITICAL SIZE (CTS)	APPROX. AVE. (CTS/STONE)
23	9.2	
21	3.9	5
19	1.9	2.7
17	1.5	1.7
15	1.2	1.3
13	0.7	0.9
12	0.5	0.6
11	0.32	0.4
9	0.17	0.23
7	0.12	0.14
6	0.08	0.1
5	0.05	0.07
3	0.03	0.04
2	0.02	0.02
1	0.01	0.01

## Appendix 2 : Resource Classification Logic for Dimbi Project

SAMREC/CIM STDS REQUIREMENTS	DIMBI PROJECT - MBIA RIVER EAST	DIMBI PROJECT - NGOUBORO RIVER	DIMBI PROJECT - AKONGO RIVER
Reasonable level of confidence with respect to:-	<b>INDICATED DIAMOND RESOURCES</b>		
Tonnage (or volume)	The palaeo-Kotto gravel was modelled in Surfer ® using 132 data points (i.e. auger holes).	The tributary gravel was modelled in Surfer ® using 80 data points (i.e. auger holes).	The tributary gravel was modelled in Surfer ® using 130 data points (i.e. auger holes).
Densities	N/A		N/A
Shape	Evidence from 132 points of reference.	Evidence from 80 points of reference.	Evidence from 130 points of reference.
Physical characteristics	Evidence from 132 points of reference.	Evidence from 80 points of reference.	Evidence from 130 points of reference.
Grade	Measured from 10,114m <sup>3</sup> (mega & bulk sampling pits).	No bulk sampling.	No bulk sampling.
Average diamond value	From sale of 3,018cts in today's market.	No diamonds specifically from tributary gravels.	No diamonds specifically from tributary gravels.
Assumed continuity of geology and/or grade	Evidence from 132 points of reference.	Evidence from 80 points of reference.	Evidence from 130 points of reference.
Sufficiently large parcel	From sale of 3,018cts in today's market.	Use sales value for Palae-Kotto River diamonds.	Use sales value for Palae-Kotto River diamonds.
Low level of confidence with respect to:-	<b>INFERRED DIAMOND RESOURCES</b>		
Tonnage (or volume)			
Grade		Measured from 75m <sup>3</sup> (mega pit).	Measured from 121m <sup>3</sup> (mega pits).
Average diamond value		Use sales value for palaeo-Kotto River diamonds.	Use sales value for Palaeo-Kotto River diamonds.
Assumed but not verified continuity of geology and/or grade			
No sufficiently large parcel		Use sales value for palaeo-Kotto River diamonds.	Use sales value for palaeo-Kotto River diamonds.
<b>CONCLUSION</b>	Indicated	Inferred	Inferred



### Appendix 3 : Resource Classification Logic for Longatshimo River Project

RESOURCE CATEGORY	CIM STDS / SAMREC REQUIREMENTS	KAPOPO	KAMONIA
Indicated	Reasonable level of confidence with respect to:-	<b>INDICATED DIAMOND RESOURCES</b>	
	Tonnage (or volume)	Each gravel type was modelled in Surfer® using 331 points of reference (i.e. prospecting pits, jimbo pits, mega pits and auger holes).	Each gravel type was modelled in Surfer® using 139 points of reference (i.e. prospecting pits, jimbo pits, mega pits and auger holes).
	Densities	N/A	N/A
	Shape	Evidence from 331 points of reference.	Evidence from 139 points of reference.
	Physical characteristics	Evidence from 331 points of reference.	Evidence from 139 points of reference.
	Grade	No bulk sampling.	No bulk sampling.
	Average diamond value		
	Assumed continuity of geology and/or grade	Evidence from 331 points of reference.	Evidence from 139 points of reference.
Sufficiently large parcel	Require minimum of 2,000cts.	Require minimum of 2,000cts.	
Inferred	Low level of confidence with respect to:-	<b>INFERRED DIAMOND RESOURCES</b>	
	Tonnage (or volume)		
	Grade	Measured from 367m <sup>3</sup> sourced from prospecting, jimbo and mega pits.	Measured from 152m <sup>3</sup> sourced from prospecting, jimbo and mega pits.
	Average diamond value	Total of 110cts from Longatshimo River and Tshikapa River Projects combined which was independently valued in Kinshasa. Not sold in today's market.	Total of 110cts from Longatshimo River and Tshikapa River Projects combined which was independently valued in Kinshasa. Not sold in today's market.
	Assumed but not verified continuity of geology and/or grade		
No sufficiently large parcel	Only 110cts from Longatshimo River and Tshikapa River Projects combined.	Only 110cts from Longatshimo River and Tshikapa River Projects combined.	
<b>CONCLUSION</b>		Inferred	Inferred

## Appendix 4 : Resource Classification Logic for Tshikapa River Project

RESOURCE CATEGORY	CIM STDS / SAMREC REQUIREMENTS	NANZAMBI	MVULA MILENGE
Indicated	Reasonable level of confidence with respect to:-	<b>INDICATED DIAMOND RESOURCES</b>	
	Tonnage (or volume)		Each gravel type was modelled in Surfer® using 107 points of reference (i.e. prospecting pits, jimbo pits, mega pits and auger holes).
	Densities	N/A	N/A
	Shape		Evidence from 107 points of reference.
	Physical characteristics		Evidence from 107 points of reference.
	Grade	No bulk sampling.	No bulk sampling.
	Average diamond value		
	Assumed continuity of geology and/or grade		Evidence from 107 points of reference.
Sufficiently large parcel	Require minimum of 2,000cts.	Require minimum of 2,000cts.	
Inferred	Low level of confidence with respect to:-	<b>INFERRED DIAMOND RESOURCES</b>	
	Tonnage (or volume)	Calculated from mapped area multiplied by average gravel thickness.	
	Grade	Measured from 8 prospecting & 1 mega pit.	Measured from 40 mega pits.
	Average diamond value	Total of 110cts from Longatshimo River and Tshikapa River Projects combined which was independently valued in Kinshasa. Not sold in today's market.	Total of 110cts from Longatshimo River and Tshikapa River Projects combined which was independently valued in Kinshasa. Not sold in today's market.
	Assumed but not verified continuity of geology and/or grade	Based upon mapping and limited intersections.	
	No sufficiently large parcel	Only 110cts from Longatshimo River and Tshikapa River Projects combined.	Only 110cts from Longatshimo River and Tshikapa River Projects combined.
<b>CONCLUSION</b>		Inferred	Inferred

## Appendix 5 : Resource Classification Logic for Cassanguidi Project

RESOURCE CATEGORY	CIM STD / SAMREC REQUIREMENTS	CABUAQUECE	CACHOQUE	CALE	CASSANGUIDI SOUTH (CA08 & 09)	CASSANGUIDI SOUTH (CA02, 04a, 04b & 05b)
Indicated	Reasonable level of confidence with respect to:-	<b>INDICATED DIAMOND RESOURCES</b>				
	Tonnage (or volume)	Modelled in Surfer ®.	Modelled in Surfer ®.	Modelled in Surfer ®.	Modelled in Surfer ®.	Areas measured in Digger® and multiplied by average gravel thickness determined from mining trenches and pitting.
	Densities	N/A	N/A	N/A	N/A	N/A
	Shape	Based on gravel in 1,065 pits.	Based on gravel in 305 pits.	Based on gravel in 466 pits.	Block CA08 & 09 based on 39 exploration pits.	Based on mining trenches and pitting.
	Physical characteristics				Block CA08 & 09 based on 39 exploration pits.	Mapped in recently excavated trenches.
	Grade					Based on production results from adjacent mining block.
	Average diamond value	No parcel.				~75,000cts sold in today's market.
	Assumed continuity of geology and/or grade	Continuity of geology and grade confirmed from pits.	Continuity of geology and grade confirmed from pits.	Continuity of geology and grade confirmed from pits.	Continuity of geology confirmed from pits & mining.	Continuity of geology and grade confirmed from 93 mining trenches/cuts.
	Sufficiently large parcel	No parcel.				~75,000cts sold in today's market.
Inferred	Low level of confidence with respect to:-	<b>INFERRED DIAMOND RESOURCES</b>				
	Tonnage (or volume)					
	Grade	Based on modelled grade in 1,065 pits. No bulk sample.	Based on modelled grade in 305 pits. No bulk sample.	Based on modelled grade in 466 pits. No bulk sample.	Based on one bulk sample pit per block.	
	Average diamond value	No parcel. Use ~75,000ct sold for Cassanguidi South Project Area in today's market.				
	Assumed but not verified continuity of geology and/or grade					
	No sufficiently large parcel	No parcel. Use ~75,000ct sold for Cassanguidi South Project Area in today's market.				
<b>CONCLUSION</b>		Inferred	Inferred	Inferred	Inferred	Indicated

### Appendix 6 : Resource Classification Logic for the South African Project

RESOURCE CATEGORY	SAMREC/CIM STDS REQUIREMENTS	PATSEMA	BRUSSELS
Indicated	Reasonable level of confidence with respect to:-	<b>INDICATED DIAMOND RESOURCES</b>	<b>INDICATED DIAMOND RESOURCES</b>
	Tonnage (or volume)	Each gravel type was modelled in Surfer using 602 points of reference (i.e. RC drilling, bulk samples, surface samples).	Each gravel type was modelled in Surfer using 316 points of reference (i.e. RC drilling, exploration pit, bulk samples).
	Densities	N/A	N/A
	Shape	Evidence from 602 points of reference.	Evidence from 316 points of reference.
	Physical characteristics	Evidence from 602 points of reference.	Evidence from 316 points of reference.
	Grade	19 bulk samples (LDD holes) were taken to determine the grade for the deposit	One bulk sample with 26 pits was excavated to determine the grade for the deposit.
	Average diamond value	The average Diamond Value was determined as USD310	A diamond Value of USD1050 was obtained
	Assumed continuity of geology and/or grade	Evidence from 602 points of reference.	Evidence from 316 points of reference.
Sufficiently large parcel	Require minimum of 2,000cts.	Require minimum of 2,000cts.	
Inferred	Low level of confidence with respect to:-	<b>INFERRED DIAMOND RESOURCES</b>	<b>INFERRED DIAMOND RESOURCES</b>
	Tonnage (or volume)		
	Grade	Measured from 19 LDD holes and 12 surface samples.	Measured from 316 bulk samples.
	Average diamond value	Total of 23.24cts valued in Johannesburg, SA.	Total of 1094.22cts valued in Johannesburg, SA. Sold in today's market.
	Assumed but not verified continuity of geology and/or grade		
	No sufficiently large parcel	Only 23.24cts were valued by an Independent Valuator	Only 1094.22cts were sold.
<b>CONCLUSION</b>		Inferred	Inferred

## Appendix 7 : Glossary of Terms and Abbreviations

<b>ACT</b>	Attestation de commencement des Travaux de reserche. A document issued by the Department of Mines (CAMI) allowing work to commence only after: the prospecting certificate has been issued, the PAR have been completed and accepted, the financial environmental guarantee has been deposited and the local authorities have been informing of the proposed exploration program.
<b>Alluvial</b>	Diamond deposits which are located in sediments transported by river or marine systems.
<b>Bulk sample</b>	Large sample which is processed through a small-scale plant, not a laboratory.
<b>Carat</b>	Unit of weight for diamonds, 0.2g = 1 carat
<b>Cross section</b>	A diagram or drawing that shows features transected by a vertical plane drawn at right angles to the longer axis of a geologic feature.
<b>Density</b>	Measure of the relative "heaviness" of objects with a constant volume, density = mass/volume
<b>Deposit</b>	Any sort of earth material that has accumulated through the action of wind, water, ice or other agents
<b>Development property</b>	A mineral property that is being prepared for mineral production and for which economic viability has been demonstrated.
<b>Diamond drilling</b>	A drilling method, where the rock is cut with a diamond bit, to extract cores.
<b>Diamondiferous</b>	Containing diamonds.
<b>Dip</b>	The angle that a structural surface, i.e. a bedding or fault plane, makes with the horizontal measured perpendicular to the strike of the structure.
<b>Dolerite</b>	A medium grained igneous rock which is emplaced within the earth's crust in the form of dykes and sills, and has the same mineralogy as basalt.
<b>Dyke</b>	Intrusive igneous rock vertically or subvertically emplaced.
<b>Estimation</b>	The quantitative judgement of a variable.
<b>Exploration</b>	Prospecting, sampling, mapping, diamond drilling and other work involved in the search for mineralization.
<b>Exploration property</b>	A Mineral Asset which is being actively explored for Mineral deposits or petroleum fields, but for which economic viability has not been demonstrated
<b>Facies</b>	An assemblage or association of mineral, rock, or fossil features reflecting the environment and conditions of origin of the rock.
<b>Fault</b>	A fracture in earth materials, along which the opposite sides have been displaced parallel to then plane of the movement
<b>Garnet</b>	A silicate mineral. The magnesium-rich variety, pyrope, is commonly found in kimberlites.
<b>Grade</b>	The relative quantity or percentage of diamonds within the rock mass. Measured as carats per hundred tonnes in this report.
<b>Ilmenite</b>	An oxide mineral commonly found in kimberlites.
<b>In situ</b>	In its original place, most often used to refer to the location of the mineral resources.
<b>Kelyphitic rim</b>	A rim of one mineral around another in an igneous rock resulting from reaction of the enclosed mineral with other constituents of the rock.
<b>Kimberlite</b>	An ultrabasic rock defined as a porphyritic alkalic peridotite containing phenocrysts of olivine and phlogopite. Occurs as dykes or as characteristically carrot-shaped pipes.
<b>License, Permit, Lease or other similar entitlement</b>	Any form of license, permit, lease or other entitlement granted by the relevant Government department in accordance with its mining legislation that confers on the holder certain rights to explore for and/or extract minerals that might be contained in the land, or ownership title that may prove ownership of the minerals
<b>Lithologies</b>	The description of the characteristics of rocks, as seen in hand-specimens and outcrops on the basis of colour, grain size and composition.
<b>Mining property</b>	A mineral asset which is in production.
<b>Matrix</b>	Fine grained rock which supports larger clasts or pebbles.
<b>Mineable</b>	That portion of a resource for which extraction is technically and economically feasible.
<b>Mineral asset(s)</b>	any right to explore and / or mine which has been granted ("property"), or entity holding such property or the securities of such an entity, including but not limited to all corporeal and incorporeal property, mineral rights, mining titles, mining leases, intellectual property, personal property (including plant equipment and infrastructure), mining and exploration tenures and titles or any other right held or acquired in connection with the finding and removing of minerals and petroleum located in, on or near the earth's crust. Mineral Assets can be classified as Dormant Properties, Exploration Properties, Development Properties, Mining Properties or Defunct Properties.
<b>Mineral Reserve</b>	The economically mineable material derived from a Measured and/or Indicated Mineral Resource. It is inclusive of diluting materials and allows for losses that may occur when the material is mined. Appropriate assessments, which may include feasibility studies, have been carried out, including consideration of and modification by, realistically assumed mining, metallurgical, economic, marketing, legal, environmental, social and governmental factors. These assessments demonstrate at the time of reporting that extraction is reasonably justified. Mineral Reserves are sub-divided in order of increasing confidence into Probable Mineral Reserves and Proved Mineral Reserve.

<b>Mineral Resource</b>	A concentration of material of economic interest in or on Earth's crust in such form, quality and quantity that there are reasonable and realistic prospects for eventual economic extraction. The location, quantity, grade, continuity and other geological characteristics of a Mineral Resource are known, estimated from specific geological evidence and knowledge, or interpreted from a well constrained and portrayed geological model. Mineral Resources are subdivided, in order of increasing confidence in respect of geoscientific evidence, into Inferred, Indicated and Measured categories. A deposit is a concentration of material of possible economic interest in, on or near the Earth's crust. Portions of a deposit that do not have reasonable and realistic prospects for eventual economic extraction must not be included in a Mineral resource.
<b>Mineralisation</b>	The presence of a target mineral in a mass of host rock.
<b>Mining property</b>	A Mineral Asset which is in production.
<b>National Instrument 43-101</b>	Canadian National Instrument on the reporting of exploration, mineral resources and mineral reserves.
<b>Overburden</b>	The alluvium and rock that must be removed in order to expose an ore deposit.
<b>Palaeochannel</b>	An old river bed formed at a time when the geology and climate of an area was different, with generally higher rainfall. Subsequent changes have seen the river bed, which would be mostly sand and gravels, buried by further sediment cover.
<b>PAR</b>	Plan d'attenuation et de rehabilitation. Environmental assessment studies required to be completed after receiving the license certificates and before any work starts. Once completed and accepted by Department of Environment, a financial guarantee is to be lodged for the completion of the ACT.
<b>Pitting</b>	One meter diameter pits dug by hand in order to identify geological structures and provide grade estimates.
<b>Plate tectonics</b>	A synthesis of geological and geophysical observations in which the Earth's lithosphere is thought to be divided into seven large rigid plates, and several smaller ones, that are moving relative to each other.
<b>Primary deposit</b>	With reference to the deposition, these deposits include kimberlite pipes, dykes, blows, and fissures as well as lamproites. Contrasted with alluvial.
<b>Prospect</b>	A deposit with the potential for economic extraction
<b>Quartzite</b>	A metamorphic rock consisting primarily of quartz grains, formed by the recrystallisation of sandstone by thermal or regional metamorphism or a sandstone composed of quartz grains cemented by silica.
<b>RE</b>	Remaining Extent
<b>Rehabilitation</b>	The process of restoring mined land to a condition approximating to a greater or lesser degree its original state. Reclamation standards are determined by the Russia Federation Department of Mineral and Energy Affairs and address ground and surface water, topsoil, final slope gradients, waste handling and re-vegetation issues.
<b>REMK</b>	Remnant of Kimberlite: This is when a kimberlitic indicator remains attached to a piece of Kimberlite rock. This displays a direct relationship between the indicator mineral and the source, and is of great significance.
<b>RIK</b>	Remnant of interstitial Kelyphite: These are kelyphite infillings found in "veins" within the grain. It develops by infiltration along planes of weakness within the grain making it more susceptible to dis-aggregation during transportation. Therefore, evidence of RIK in garnets is an indication of close proximity to source.
<b>ROK</b>	Remnant of Kelyphite: Kelyphite is a crust surrounding garnet which forms during Kimberlite emplacement as a result of the reaction process due to the instability of garnet. The kelyphite shell only survives short distances of transport, and is therefore also an indication of close proximity to source.
<b>ROS</b>	Remnant of original surface (kimberlitic surface)
<b>Sample</b>	The removal of a small amount of sediment pertaining to the deposit which is used to estimate the grade of the deposit and other geological parameters.
<b>Sampling</b>	Taking parcels of sediment at intervals along river courses focusing on best possible trap sites for analysis (to determine the mineral content).
<b>Sedimentary</b>	Formed by the deposition of solid fragmental or chemical material that originates from weathering of rocks and is transported from a source to a site of deposition.
<b>SKS</b>	Sub-Kelyphitic Surface: These are features found on the surface of the garnet that underlies the kelyphite crust on the garnet. The SKS features mirror the kelyphite structure.
<b>Sonde</b>	A geophysical exploration tool.
<b>Spinel</b>	An oxide mineral used as an indicator mineral in kimberlite exploration.
<b>Tonnage</b>	Quantities where the tonne is an appropriate unit of measure. Typically used to measure reserves of metal-bearing material in-situ or quantities of ore and waste material mined, transported or milled.
<b>Trap site</b>	A confined area within a river system where diamonds accumulate.

<b>UNITS</b>	<b>DESCRIPTION</b>
ACT	Attestation de Commencement des Travaux de recherche
bn	Billion
CAMI	Cadastre Minière (Department of Mines)
CEEC	Centre d'Expertise, d'Evaluation et de Contrôle de Matières Précieuses (Congolese Diamond Board)
cpht	Carats per hundred tonnes
ct	Carats
ct/t	Carats per tonne
EMP	Environmental Management Plan
ha	Hectare
km	Kilometer
m	Metre
Ma	Million years
Mbls	Million barrels
Mcts	Million carats
pa	Per annum
PAR	Plan d'Attenuation et de Rehabilitation (Congolese equivalent of EMP)
PE	Mining License
PR	Prospecting License
QA/QC	Quality Assurance/Quality Control
t	Tonne
tph	Tonnes per hour
USD	United States Dollar

## **Appendix 8 : Classification of Secondary Diamond Deposits**

The primary hosts for diamonds are kimberlites, lamproites and related rocks, the weathering and erosion of which gives rise to secondary deposits. Secondary diamond deposits in general can be divided into a number of distinct classes, dependent on the degree of transport of diamonds and the sedimentary environment in which the deposits are laid down. It is emphasised that the deposits can, and often do, grade into one another, and the older deposits can supply diamonds to the younger ones, during which process either concentration or dilution of grade can occur.

### **ELUVIAL DEPOSITS**

Eluvial diamond deposits are those which are essentially in place, and are derived from in-situ weathering of the primary host, without lateral transport. Solution leaching and aeolian removal (deflation) of the chemically weathered host usually gives rise to concentration of the diamonds, often by high factors. The material is generally unconsolidated or only partly consolidated, except by processes of calcretisation or lateritisation.

### **COLLUVIAL DEPOSITS**

A general term applied to any loose, heterogeneous, and incoherent mass of soil material and/or rock fragments deposited by rain-wash, sheet-wash, or slow continuous down-slope soil creep, usually collecting on or at the base of gentle slopes or hillsides. Also alluvium deposited by surface runoff or sheet erosion. Transport is not fluvial, in the sense that it does not take place in a river system. The material is generally unconsolidated, and comprises material derived from the host rock and the underlying bedrock. Removal of the fine fraction by sheet-wash can lead to a concentration of heavier and coarser fragments in the colluvium, and irregularities in the bed-rock, such as dykes or quartz veins can give rise to low order trap sites.

### **ALLUVIAL DEPOSITS**

Essentially, almost all alluvial deposits are products of a braided stream environment. A braided stream is one which divides into or follows an interlacing or tangled network of several small branching and reuniting shallow channels separated from each other by branch islands or channel bars, resembling in plan the strands of a complex braid. A braided system is the result of a river system subjected to periodic, usually seasonal high-energy flooding, flowing in a wide channel on a flood plain. Other than during floods, such a stream is generally incapable of carrying all of its bed-load, that is, an overloaded and aggrading system.

Diamond mineralization of any significance is restricted to the gravel banks, bars and to a lesser degree to the thinner gravel layers. If the bedrock of the braided system is at all irregular, enrichments of diamond may be found in trap situations such as gullies, cracks, coarse boulder banks, etc. Diamond grades in general are moderate and patchy, but reasonably high tonnages of ore can be developed.

Several forms of deposit can be laid down in the flood plain of a braided river system:-

#### **ALLUVIAL FANS, CHANNEL FANS OR SPLAYS**

This is a small to large alluvial fan or outspread deposit formed where an overloaded stream breaks through a restriction (nick-point) such as a gorge, or through a levee, and deposits its material on the flood plain. Such splays are generally ovoid in plan, with the narrow end just downstream of the nick-point, and can be anything from a few metres to several kilometres in length. The proportion of gravel in the package, average pebble/boulder size, and diamond grade decrease radially with distance from the nick-point. A fan without an obvious nick-point, in the centre of the channel, is often called a Channel Bar.

#### **POINT BARS**

A low, arcuate ridge of sand and gravel developed on the inside of a growing meander by the slow addition of individual accretions accompanying migration of the channel toward the outer bank. Gravel proportion and diamond grade tend to decrease downstream and towards the centre of the channel.

#### **LATERAL BARS**

An elongated gravel ridge developed at the foot of the river bank in a straight stretch of the river, analogous to a point bar in a meander. Again, gravel proportion and diamond grade tend to decrease downstream and towards the centre of the channel.



## CHANNEL DEPOSITS

Channel deposits, in the sense used here, are developed in the same manner as braided stream deposits, but in more confined valleys, where valley-floor widths are restricted, and gradients are steeper. Channel and lateral bars can develop, but with the relatively restricted valley floor, with faster water flow, the proportion of gravel in the package is generally much higher than in a braided stream environment in a wider valley. The high flow rates can lead to relatively high levels of concentration of diamonds due to the winnowing out of the sand and silt fractions.

Particularly where the bedrock is either soft or heterogeneous, the high-energy flow of the river during flood periods leads to the cutting of gullies and potholes, often several metres deep, which provide an ideal trap situation for diamonds. Grades can be very high ( $>100\text{ct/m}^3$  has been recorded), but tonnages are generally low, and such potholes and gullies are difficult to locate, particularly if the river system has silted up, and to mine.

## PLUNGE POOLS

In a river system crossed by rock bars, particularly in situations where the bedrock downstream of the rock bar is much softer than the bar itself, a chute or waterfall can form, and a deep pool is eroded out of the softer rock. The pool traps gravel in times of flooding and acts as a very efficient milling system. The mechanism is analogous to the formation of a pothole, but on a much larger scale, leading to the concentration of diamonds, often to very high levels, with significantly greater tonnages of ore. An added advantage of the plunge-pool situation is that the deposits are usually inaccessible to artisan workers, and have therefore have not been exploited to any extent.

Plunge pools can in fact occur on any scale, and in any system of rapids, the deeper water areas can be considered to be small plunge pools, which again act as very efficient trap sites for diamond. During the dry season, the plunge pools are often exploited by artisan workers, with great success.

## RIFFLE TRAPS, POTHoles AND GULLIES

Riffle traps are formed when the stream flows over an irregular surface, such as heavily jointed bedrock, a series of closely spaced dykes, or a semi-consolidated coarse gravel or boulder bed, this last being referred to as a false bedrock.

Particularly where the bedrock is either soft or heterogeneous, the high energy flow of the river during flood periods leads to the cutting of gullies and potholes, often several metres deep, into the floor of the channel, these providing an ideal trap situation for diamonds. Grades can be very high ( $>100\text{ct/m}^3$  has been quoted for a potholes), but tonnages are generally low, and such potholes and gullies are difficult to locate, particularly if the river system has silted up, and to mine.

Such traps can occur beneath any of the above deposit-types, and are generally the reason for the concentration of diamonds at the base of such deposits, where diamonds or other heavy minerals are trapped in the spaces in the stream floor.

When situated in the present river channel, with active transport of the bed-load taking place, in a more or less continually active stream, with the bed-load in constant motion, gravels in any of these traps may be the only sites of diamond deposition. Such trap deposits are generally of limited tonnage, but can be very high grade, and can often be considered to be a "renewable resource".

## "PERCHED" DEPOSITS AND RIVER TERRACES

All the deposit types found in a braided stream environment are valley-floor fillings, gradually building up with time, and the river is not to any significant degree cutting down into its own bed, but migrating laterally and irregularly within its valley.

Regional uplift or long-term fluctuations in climate can alter the flow regime of the river, uplift or a decrease in mean energy of the system both leading to incision of the stream into a fixed channel. The deposits resulting from either mechanism are the same.

A decrease in mean rainfall, or during the rainy season, will reduce the average energy of the system and reduce the carrying capacity of the stream, and inflow of solids will decrease or cease altogether. The system stabilises under the new flow regime, the river tends to flow in a fixed channel, rather than wandering across the width of the valley, and this channel will tend to cut down into the bedrock with time.

Lowering of the river bed leaves the earlier-formed braided stream deposits high and dry above the then-prevailing river level, giving rise to “perched” splays, fans and channels.

If the rate of lowering of the river level is relatively slow, or the system has stabilised for any length of time, the braided stream deposits tend to be spread out, particularly during flood periods, and to a greater or lesser degree mixed, with preferential removal of the finer fractions only. A wide gravel deposit with a relatively flat upper surface will develop, with any pre-existing traps preserved beneath. Subsequent channel incision and lowering of the river level leaves these river terraces hanging.

Terraces are generally relatively thin (<1-2m) except where they overlie traps, but often extensive, diamond grades are relatively low, but normally still economic, and substantial tonnages of ore may be developed. Should the erosion base change with time, terrace deposits may be left at various elevations above the present river, and reworking of the terraces can lead to reconcentration and enrichment of diamonds in the lower terraces and the present river bed.

### **FLATS**

The term “flat” is frequently used in African francophone countries to describe terrace-like deposits, lying on bedrock, which are inclined towards the present river bed, often with slopes of several degrees. It is usually assumed that these have been formed during the course of migration of the river-bed itself as it cuts down into bedrock. In contrast to the true terrace deposits, which generally have planar tops and bottoms, the flats apparently have planar tops, but the base of the gravel can be quite irregular, with well developed gullies and potholes. Such “flat” deposits are said to be of relatively low grade, but with rich patches, presumably the gullies and potholes. However, ground examination of several “flats” in the CAR indicates that the deposits are more likely to be due to hill-wash, with a minor fluvial reworking. Diamond grades are said to be relatively low, except in bedrock trap-sites, but substantial tonnages of ore may be present.

### **MEANDER FLATS**

Uplift, as noted above, leads to the formation of “perched” deposits. Subsidence, on the other hand, with a concomitant decrease in the overall energy of the fluvial system, generally leads to the burial of high energy gravel deposits under low energy sands and silts, often several metres thick. This can apply to any of the deposit alluvial deposit types discussed above.