



**Regulatory Impact Analysis
for the
Clean Power Plan Final Rule**

[This page intentionally left blank]

Regulatory Impact Analysis for the Clean Power Plan Final Rule

U.S. Environmental Protection Agency
Office of Air and Radiation
Office of Air Quality Planning and Standards
Research Triangle Park, NC 27711

CONTACT INFORMATION

This document has been prepared by staff from the Office of Air Quality Planning and Standards, the Office of Atmospheric Programs, and the Office of Policy of the U.S. Environmental Protection Agency. Questions related to this document should be addressed to Alexander Macpherson, U.S. Environmental Protection Agency, Office of Air Quality Planning and Standards, Research Triangle Park, North Carolina 27711 (email: macpherson.alex@epa.gov).

ACKNOWLEDGEMENTS

Thank you to the many staff who worked on this document from EPA Offices including the Office of Air Quality Planning and Standards, the Office of Atmospheric Programs, and the Office of Policy. Contributions to this report were also made by ICF International and RTI International.

Table of Contents

LIST OF TABLES	x
LIST OF FIGURES	xvii
ACRONYMS	xx
EXECUTIVE SUMMARY	ES-1
ES.1 Background and Context	ES-1
ES.2 Summary of Clean Power Plan Final Rule	ES-1
ES.3 Illustrative Plan Approaches Examined in RIA.....	ES-3
ES.4 Emissions Reductions.....	ES-6
ES.5 Costs	ES-8
ES.6 Monetized Climate Benefits and Health Co-benefits	ES-10
ES.6.1 Estimating Global Climate Benefits	ES-14
ES.6.2 Estimating Air Quality Health Co-Benefits.....	ES-16
ES.6.3 Combined Benefits Estimates.....	ES-19
ES.7 Net Benefits	ES-21
ES.8 Economic Impacts	ES-24
ES.9 Employment Impacts.....	ES-24
ES.10 References.....	ES-25
CHAPTER 1: INTRODUCTION AND BACKGROUND FOR THE CLEAN POWER PLAN	1-1
1.1 Introduction.....	1-1
1.2 Legal, Scientific and Economic Basis for this Rulemaking	1-1
1.2.1 Statutory Requirement.....	1-1
1.2.2 Health and Welfare Impacts from Climate Change.....	1-2
1.2.3 Market Failure	1-3
1.3 Summary of Regulatory Analysis.....	1-4
1.4 Background for the Final Emission Guidelines	1-4
1.4.1 Base Case and Years of Analysis	1-4
1.4.2 Definition of Affected Sources.....	1-5
1.4.3 Regulated Pollutant.....	1-6
1.4.4 Emission Guidelines	1-6
1.4.5 State Plans.....	1-7
1.5 Organization of the Regulatory Impact Analysis.....	1-7
1.6 References.....	1-8
CHAPTER 2: ELECTRIC POWER SECTOR INDUSTRY PROFILE	2-1
2.1 Introduction.....	2-1
2.2 Power Sector Overview	2-1
2.2.1 Generation	2-1
2.2.2 Transmission.....	2-9

2.2.3	Distribution.....	2-10
2.3	Sales, Expenses and Prices	2-11
2.3.1	Electricity Prices.....	2-11
2.3.2	Prices of Fossil Fuels Used for Generating Electricity.....	2-17
2.3.3	Changes in Electricity Intensity of the U.S. Economy Between 2002 to 2012	2-18
2.4	Deregulation and Restructuring	2-19
2.5	Emissions of Greenhouse Gases from Electric Utilities	2-24
2.6	Carbon Dioxide Control Technologies	2-27
2.6.1	Carbon Capture and Storage.....	2-29
2.6.2	Geologic and Geographic Considerations for Geologic Sequestration	2-33
2.6.3	Availability of Geologic Sequestration in Deep Saline Formations.....	2-37
2.6.4	Availability of CO ₂ Storage via Enhanced Oil Recovery (EOR).....	2-37
2.7	State Policies on GHG and Clean Energy Regulation in the Power Sector.....	2-39
2.8	Revenues and Expenses	2-42
2.9	Natural Gas Market.....	2-43
2.10	References.....	2-47

CHAPTER 3: COST, EMISSIONS, ECONOMIC, AND ENERGY IMPACTS..... 3-1

3.1	Introduction.....	3-1
3.2	Overview.....	3-1
3.3	Power Sector Modelling Framework	3-1
3.4	Recent Updates to EPA’s Base Case using IPM (v.5.15).....	3-4
3.5	State Goals in this Final Rule.....	3-5
3.6	Illustrative Plan Approaches Analyzed.....	3-7
3.7	Demand-Side Energy Efficiency	3-12
3.7.1	Demand-Side Energy Efficiency Improvements (Electricity Demand Reductions)	3-12
3.7.2	Demand-Side Energy Efficiency Costs	3-15
3.8	Monitoring, Reporting, and Recordkeeping Costs	3-16
3.9	Projected Power Sector Impacts	3-19
3.9.1	Projected Emissions.....	3-19
3.9.2	Projected Compliance Costs.....	3-21
3.9.3	Projected Compliance Actions for Emissions Reductions	3-23
3.9.4	Projected Generation Mix.....	3-25
3.9.5	Projected Incremental Retirements.....	3-30
3.9.6	Projected Capacity Additions	3-31
3.9.7	Projected Coal Production and Natural Gas Use for the Electric Power Sector	3-33
3.9.8	Projected Fuel Price, Market, and Infrastructure Impacts	3-34
3.9.9	Projected Retail Electricity Prices	3-35
3.9.10	Projected Electricity Bill Impacts.....	3-40
3.11	Limitations of Analysis.....	3-43
3.12	Social Costs.....	3-45
3.13	References.....	3-48

APPENDIX 3A: ANALYSIS OF POTENTIAL UPSTREAM METHANE EMISSIONS CHANGES IN NATURAL GAS SYSTEMS AND COAL MINING	3A-1
3A.1 General Approach.....	3A-2
3A.1.1 Analytical Scope.....	3A-2
3A.1.2 Coal Mining Source Description.....	3A-3
3A.1.3 Natural Gas Systems Source Description.....	3A-4
3A.1.4 Illustrative Plan Approaches Examined.....	3A-6
3A.1.5 Activity Drivers.....	3A-6
3A.2 Results.....	3A-7
3A.3 Uncertainties and Limitations.....	3A-8
3A.4 References.....	3A-9
CHAPTER 4: ESTIMATED CLIMATE BENEFITS AND HUMAN HEALTH CO-BENEFITS	4-1
4.1 Introduction.....	4-1
4.2 Estimated Climate Benefits from CO ₂	4-1
4.2.1 Climate Change Impacts.....	4-2
4.2.2 Social Cost of Carbon.....	4-3
4.3 Estimated Human Health Co-Benefits.....	4-11
4.3.1 Health Impact Assessment for PM _{2.5} and Ozone.....	4-13
4.3.2 Economic Valuation for Health Co-benefits.....	4-18
4.3.3 Benefit-per-ton Estimates for PM _{2.5}	4-20
4.3.4 Benefit-per-ton Estimates for Ozone.....	4-21
4.3.5 Estimated Health Co-Benefits Results.....	4-22
4.3.6 Characterization of Uncertainty in the Estimated Health Co-benefits.....	4-36
4.4 Combined Climate Benefits and Health Co-Benefits Estimates.....	4-42
4.5 Unquantified Co-benefits.....	4-46
4.5.1 HAP Impacts.....	4-48
4.5.2 Additional NO ₂ Health Co-Benefits.....	4-52
4.5.3 Additional SO ₂ Health Co-Benefits.....	4-53
4.5.4 Additional NO ₂ and SO ₂ Welfare Co-Benefits.....	4-54
4.5.5 Ozone Welfare Co-Benefits.....	4-55
4.5.6 Carbon Monoxide Co-Benefits.....	4-55
4.5.7 Visibility Impairment Co-Benefits.....	4-56
4.6 References.....	4-56
APPENDIX 4A: GENERATING REGIONAL BENEFIT-PER-TON ESTIMATES	4A-1
4A.1 Overview of Benefit-per-Ton Estimates.....	4A-1
4A.2 Air Quality Modeling for the Proposed Clean Power Plan.....	4A-2
4A.3 Regional PM _{2.5} Benefit-per-Ton Estimates for EGUs Derived from Air Quality Modeling of the Proposed Clean Power Plan.....	4A-5
4A.4 Regional Ozone Benefit-per-Ton Estimates.....	4A-15
4A.5 References.....	4A-18
CHAPTER 5: ECONOMIC IMPACTS – MARKETS OUTSIDE THE UTILITY POWER SECTOR	5-1

5.1	Introduction.....	5-1
5.2	Methods.....	5-2
5.3	Summary of Secondary Market Impacts of Energy Price Changes.....	5-3
5.3.1	Share of Total Production Costs.....	5-5
5.3.2	Ability to Substitute between Inputs to the Production Process.....	5-5
5.3.3	Availability of Substitute Goods and Services.....	5-5
5.4	Effect of Changes in Input Demand from Electricity Sector.....	5-6
5.5	Conclusions.....	5-6
5.6	References.....	5-7
CHAPTER 6: EMPLOYMENT IMPACT ANALYSIS		6-1
6.1	Introduction.....	6-1
6.2	Economic Theory and Employment	6-2
6.3	Current State of Knowledge Based on the Peer-Reviewed Literature.....	6-6
6.3.1	Regulated Sector.....	6-7
6.3.2	Economy-Wide.....	6-9
6.3.3	Labor Supply Impacts.....	6-11
6.4	Recent Employment Trends.....	6-11
6.4.1	Electric Power Generation.....	6-12
6.4.2	Fossil Fuel Extraction.....	6-13
6.4.3	Clean Energy Employment Trends.....	6-14
6.5	Projected Sectoral Employment Changes due to the Final Emission Guidelines....	6-18
6.5.1	Projected Changes in Employment in Electricity Generation and Fossil Fuel Extraction.....	6-19
6.5.2	Projected Changes in Employment in Demand-Side Energy Efficiency Activities.....	6-25
6.6	Conclusion	6-34
6.7	References.....	6-36
APPENDIX 6A: ESTIMATING SUPPLY SIDE EMPLOYMENT IMPACTS		6A-1
6A.1	General Approach.....	6A-1
6A.2	Employment Changes due to Heat Rate Improvements.....	6A-3
6A.2.1	Employment Changes Due to Building (or Avoiding) New Generation Capacity	6A-5
6A.2.2	Employment Changes due to Coal and Oil/Gas Retirements.....	6A-8
6A.2.3	Employment Changes due to Changes in Fossil Fuel Extraction.....	6A-9
6A.3	References.....	6A-10
CHAPTER 7: STATUTORY AND EXECUTIVE ORDER ANALYSIS		7-1
7.1	Executive Order 12866: Regulatory Planning and Review, and Executive Order 13563: Improving Regulation and Regulatory Review	7-1
7.2	Paperwork Reduction Act (PRA).....	7-6
7.3	Regulatory Flexibility Act (RFA).....	7-7
7.4	Unfunded Mandates Reform Act (UMRA)	7-8

7.5	Executive Order 13132: Federalism	7-9
7.6	Executive Order 13175: Consultation and Coordination with Indian Tribal Governments	7-14
7.7	Executive Order 13045: Protection of Children from Environmental Health Risks and Safety Risks.....	7-16
7.8	Executive Order 13211: Actions Concerning Regulations That Significantly Affect Energy Supply, Distribution, or Use.....	7-17
7.9	National Technology Transfer and Advancement Act (NTTAA)	7-17
7.10	Executive Order 12898: Federal Actions to Address Environmental Justice in Minority Populations and Low-Income Populations	7-18
7.11	Congressional Review Act (CRA).....	7-21
CHAPTER 8: COMPARISON OF BENEFITS AND COSTS		8-1
8.1	Comparison of Benefits and Costs.....	8-1
8.2	Uncertainty Analysis.....	8-5
8.2.1	Uncertainty in Costs and Illustrative Plan Approaches	8-5
8.2.2	Uncertainty Associated with Estimating the Social Cost of Carbon	8-6
8.2.3	Uncertainty Associated with PM _{2.5} and Ozone Health Co-Benefits Assessment.....	8-7
8.3	References	8-9

LIST OF TABLES

Table ES-1.	Emission Performance Rates (Adjusted Output-Weighted-Average Pounds of CO ₂ Per Net MWh from All Affected Fossil Fuel-Fired EGUs)	ES-2
Table ES-2.	Climate and Air Pollutant Emission Reductions for the Rate-Based Illustrative Plan Approach	ES-6
Table ES-3.	Climate and Air Pollutant Emission Reductions for the Mass-Based Illustrative Plan Approach	ES-7
Table ES-4.	Projected CO ₂ Emission Reductions, Relative to 2005	ES-8
Table ES-5.	Compliance Costs for the Illustrative Rate-Based and Mass-Based Plan Approaches	ES-9
Table ES-6.	Quantified and Unquantified Benefits	ES-12
Table ES-7.	Combined Estimates of Climate Benefits and Health Co-Benefits for Rate-Based Approach (billions of 2011\$)	ES-18
Table ES-8.	Combined Estimates of Climate Benefits and Health Co-benefits for Mass-Based Approach (billions of 2011\$)	ES-21
Table ES-9.	Monetized Benefits, Compliance Costs, and Net Benefits Under the Rate-based Illustrative Plan Approach (billions of 2011\$)	ES-22
Table ES-10.	Monetized Benefits, Compliance Costs, and Net Benefits under the Mass-based Illustrative Plan Approach (billions of 2011\$)	ES-23
Table ES-11.	Summary Table of Important Energy Market Impacts (Percent Change from Base Case).....	ES-24
Table 2-1.	Existing Electricity Generating Capacity by Energy Source, 2002 and 2012....	2-3
Table 2-2.	Net Generation in 2002 and 2013 (Trillion kWh = TWh).....	2-5
Table 2-3.	Coal and Natural Gas Generating Units, by Size, Age, Capacity, and Thermal Efficiency (Heat Rate).....	2-7
Table 2-4.	Total U.S. Electric Power Industry Retail Sales in 2012 (billion kWh).....	2-11
Table 2-5.	Domestic Emissions of Greenhouse Gases, by Economic Sector (million tons of CO ₂ equivalent).....	2-25
Table 2-6.	Greenhouse Gas Emissions from the Electricity Sector (Generation, Transmission and Distribution), 2002 and 2012 (million tons of CO ₂ equivalent)	2-26

Table 2-7.	Fossil Fuel Emission Factors in EPA Base Case 5.14 IPM Power Sector Modeling Application	2-27
Table 2-8.	Total CO ₂ Storage Resource (DOE-NETL)	2-35
Table 2-9.	Revenue and Expense Statistics for Major U.S. Investor-Owned Electric Utilities for 2002, 2008 and 2012 (nominal \$millions)	2-42
Table 3-1.	Statewide CO ₂ Emission Performance Goals, Rate-based and Mass-based.....	3-6
Table 3-2.	Demand-Side Energy Efficiency Plan Scenario: Net Cumulative Demand Reductions [Contiguous U.S.] (GWh and as Percent of BAU Sales).....	3-14
Table 3-3.	Annualized Cost of Demand-Side Energy Efficiency Plan Scenario (at discount rates of 3 percent and 7 percent, billions 2011\$)	3-15
Table 3-4.	Years 2020, 2025 and 2030: Summary of State and Industry Annual Respondent Burden and Cost of Reporting and Recordkeeping Requirements (2011\$)	3-18
Table 3-5.	Projected CO ₂ Emission Impacts, Relative to Base Case.....	3-19
Table 3-6.	Projected CO ₂ Emission Impacts, Relative to 2005	3-20
Table 3-7.	Projected Non-CO ₂ Emission Impacts, 2020-2030	3-20
Table 3-8.	Annualized Compliance Costs Including Monitoring, Reporting and Recordkeeping Costs Requirements (billions of 2011\$)	3-22
Table 3-9.	Total Power Sector Generating Costs (IPM) (billions 2011\$)	3-23
Table 3-10.	Projected Capacity Factor of Existing Coal Steam and Natural Gas Combined Cycle Capacity	3-25
Table 3-11.	Generation Mix (thousand GWh)	3-27
Table 3-12.	Total Generation Capacity by 2020-2030 (GW)	3-31
Table 3-13.	Projected Capacity Additions, Gas (GW).....	3-32
Table 3-14.	Projected Capacity Additions, Renewable (GW)	3-33
Table 3-15.	Coal Production for the Electric Power Sector, 2025	3-33
Table 3-16.	Power Sector Gas Use	3-34
Table 3-17.	Projected Average Minemouth and Delivered Coal Prices (2011\$/MMBtu) ..	3-35

Table 3-18.	Projected Average Henry Hub (spot) and Delivered Natural Gas Prices (2011\$/MMBtu).....	3-35
Table 3-19.	2020 Projected Contiguous U.S. and Regional Retail Electricity Prices (cents/kWh).....	3-37
Table 3-20.	2025 Projected Contiguous U.S. and Regional Retail Electricity Prices (cents/kWh).....	3-38
Table 3-21.	2030 Projected Contiguous U.S. and Regional Retail Electricity Prices (cents/kWh).....	3-39
Table 3-22.	Projected Changes in Average Electricity Bills.....	3-40
Table 3A-1.	Base Year Upstream Methane-Related Emissions in the U.S. GHG Inventory	3A-6
Table 3A-2.	Projected Coal Production Impacts	3A-7
Table 3A-3.	Projected Natural Gas Production Impacts.....	3A-7
Table 3A-4.	Potential Upstream Emissions Changes	3A-8
Table 4-1.	Climate Effects	4-2
Table 4-2.	Social Cost of CO ₂ , 2015-2050 (in 2011\$ per short ton)	4-8
Table 4-3.	Estimated Global Climate Benefits of CO ₂ Reductions for the Final Emission Guidelines in 2020 (billions of 2011\$)	4-9
Table 4-4.	Estimated Global Climate Benefits of CO ₂ Reductions for the Final Emission Guidelines in 2025 (billions of 2011\$)	4-9
Table 4-5.	Estimated Global Climate Benefits of CO ₂ Reductions for the Final Emission Guidelines in 2030 (billions of 2011\$)	4-9
Table 4-6.	Human Health Effects of Ambient PM _{2.5} and Ozone.....	4-14
Table 4-7.	Summary of Regional PM _{2.5} Benefit-per-Ton Estimates Based on Air Quality Modeling from Proposed Clean Power Plan in 2020 (2011\$).....	4-23
Table 4-8.	Summary of Regional PM _{2.5} Benefit-per-Ton Estimates Based on Air Quality Modeling from Proposed Clean Power Plan in 2025 (2011\$).....	4-23
Table 4-9.	Summary of Regional PM _{2.5} Benefit-per-Ton Estimates Based on Air Quality Modeling from Proposed Clean Power Plan in 2030 (2011\$).....	4-24
Table 4-10.	Emission Reductions of Criteria Pollutants for the Final Emission Guidelines Rate-based Illustrative Plan Approach in 2020 (thousands of short tons).....	4-24

Table 4-11.	Emission Reductions of Criteria Pollutants for the Final Emission Guidelines Rate-based Illustrative Plan Approach in 2025 (thousands of short tons).....	4-24
Table 4-12.	Emission Reductions of Criteria Pollutants for the Final Emission Guidelines Rate-based Illustrative Plan Approach in 2030 (thousands of short tons).....	4-25
Table 4-13.	Emission Reductions of Criteria Pollutants for the Final Emission Guidelines Mass-based Illustrative Plan Approach in 2020 (thousands of short tons).....	4-25
Table 4-14.	Emission Reductions of Criteria Pollutants for the Final Emission Guidelines Mass-based Illustrative Plan Approach in 2025 (thousands of short tons).....	4-25
Table 4-15.	Emission Reductions of Criteria Pollutants for the Final Emission Guidelines Mass-based Illustrative Plan Approach in 2030 (thousands of short tons).....	4-25
Table 4-16.	Summary of Estimated Monetized Health Co-Benefits for the Final Emission Guidelines Rate-based Illustrative Plan Approach in 2020 (billions of 2011\$)	4-26
Table 4-17.	Summary of Estimated Monetized Health Co-Benefits for the Final Emission Guidelines Rate-based Illustrative Plan Approach in 2025 (billions of 2011\$)	4-26
Table 4-18.	Summary of Estimated Monetized Health Co-Benefits for the Final Emission Guidelines Rate-based Illustrative Plan Approach in 2030 (billions of 2011\$)	4-27
Table 4-19.	Summary of Estimated Monetized Health Co-Benefits for the Final Emission Guidelines Mass-based Illustrative Plan Approach in 2020 (billions of 2011\$)	4-27
Table 4-20.	Summary of Estimated Monetized Health Co-Benefits for the Final Emission Guidelines Mass-based Illustrative Plan Approach in 2025 (billions of 2011\$)	4-28
Table 4-21.	Summary of Estimated Monetized Health Co-Benefits for the Final Emission Guidelines Mass-based Illustrative Plan Approach in 2030 (billions of 2011\$)	4-28
Table 4-22.	Summary of Avoided Health Incidences from PM _{2.5} -Related and Ozone-Related Co-benefits for the Final Emission Guidelines Rate-based Illustrative Plan Approach in 2020.....	4-29
Table 4-23.	Summary of Avoided Health Incidences from PM _{2.5} -Related and Ozone-Related Co-benefits for Final Emission Guidelines Rate-based Illustrative Plan Approach in 2025.....	4-30

Table 4-24.	Summary of Avoided Health Incidences from PM _{2.5} -Related and Ozone-Related Co-Benefits for Final Emission Guidelines Rate-based Illustrative Plan Approach in 2030.....	4-31
Table 4-25.	Summary of Avoided Health Incidences from PM _{2.5} -Related and Ozone-Related Co-benefits for the Final Emission Guidelines Mass-based Illustrative Plan Approach in 2020.....	4-32
Table 4-26.	Summary of Avoided Health Incidences from PM _{2.5} -Related and Ozone-Related Co-benefits for Final Emission Guidelines Mass-based Illustrative Plan Approach in 2025.....	4-33
Table 4-27.	Summary of Avoided Health Incidences from PM _{2.5} -Related and Ozone-Related Co-Benefits for Final Emission Guidelines Mass-based Illustrative Plan Approach in 2030.....	4-34
Table 4-28.	Population Exposure in the Clean Power Plan Proposal Option 1 State Scenario Modeling (used to generate the benefit-per-ton estimates) Above and Below Various Concentrations Benchmarks in the Underlying Epidemiology Studies	4-41
Table 4-29.	Combined Climate Benefits and Health Co-Benefits for Final Emission Guidelines in 2020 (billions of 2011\$).....	4-44
Table 4-30.	Combined Climate Benefits and Health Co-Benefits for Final Emission Guidelines in 2025 (billions of 2011\$).....	4-44
Table 4-31.	Combined Climate Benefits and Health Co-Benefits for Final Emission Guidelines in 2030 (billions of 2011\$).....	4-45
Table 4-32.	Unquantified Health and Welfare Co-benefits Categories	4-47
Table 4A-1.	State Total Annual EGU Emissions for NO _x for the 2011 Base Year, 2025 Base Case, and 2025 Clean Power Plan Proposal (Option 1 State) (in thousands of tons)	4A-3
Table 4A-2.	State Total Annual EGU Emissions for SO ₂ for the 2011 Base Year, 2025 Base Case, and 2025 Clean Power Plan Proposal (Option 1 State) (in thousands of tons)	4A-4
Table 4A-3.	Summary of Regional PM _{2.5} Benefit-per-Ton Estimates Based on Air Quality Modeling from Proposed Clean Power Plan in 2020 (2011\$).....	4A-10
Table 4A-4.	Summary of Regional PM _{2.5} Benefit-per-Ton Estimates Based on Air Quality Modeling from Proposed Clean Power Plan in 2025 (2011\$).....	4A-10
Table 4A-5.	Summary of Regional PM _{2.5} Benefit-per-Ton Estimates Based on Air Quality Modeling from Proposed Clean Power Plan in 2030 (2011\$).....	4A-11

Table 4A-6.	Summary of Regional PM _{2.5} Incidence-per-Ton Estimates Based on Air Quality Modeling from Proposed Clean Power Plan in 2020.....	4A-12
Table 4A-7.	Summary of Regional PM _{2.5} Incidence-per-Ton Estimates Based on Air Quality Modeling from Proposed Clean Power Plan in 2025.....	4A-13
Table 4A-8.	Summary of Regional PM _{2.5} Incidence-per-Ton Estimates Based on Air Quality Modeling from Proposed Clean Power Plan in 2030.....	4A-14
Table 4A-9.	Summary of Regional Ozone Benefit-per-Ton Estimates Based on Air Quality Modeling from Proposed Clean Power Plan in 2020 (2011\$).....	4A-16
Table 4A-10.	Summary of Regional Ozone Benefit-per-Ton Estimates Based on Air Quality Modeling from Proposed Clean Power Plan in 2025 (2011\$).....	4A-16
Table 4A-11.	Summary of Regional Ozone Benefit-per-Ton Estimates Based on Air Quality Modeling from Proposed Clean Power Plan in 2030 (2011\$).....	4A-16
Table 4A-12.	Summary of Regional Ozone Incidence-per-Ton Estimates Based on Air Quality Modeling from Proposed Clean Power Plan in 2020.....	4A-17
Table 4A-13.	Summary of Regional Ozone Incidence-per-Ton Estimates Based on Air Quality Modeling from Proposed Clean Power Plan in 2025.....	4A-17
Table 4A-14.	Summary of Regional Ozone Incidence-per-Ton Estimates Based on Air Quality Modeling from Proposed Clean Power Plan in 2030.....	4A-17
Table 5-1.	Estimated Percentage Changes in Average Energy Prices by Energy Type for the Final Emission Guidelines, Rate-based and Mass-based Illustrative Plan Approaches	5-4
Table 6-1.	U. S. Green Goods and Services (GGS) Employment (annual average).....	6-16
Table 6-2.	Renewable Electricity Generation-Related Employment	6-17
Table 6-3.	Energy and Resources Efficiency-Related Employment.....	6-18
Table 6-4.	Engineering-Based ^a Changes in Labor Utilization, Rate-based Scenario (Number of Job-Years ^b of Employment in a Single Year)	6-24
Table 6-5.	Engineering-Based ^a Changes in Labor Utilization, Mass-Based Illustrative Plan Approach (Number of Job-Years of Employment in a Single Year)	6-25
Table 6-6.	Estimated Demand-Side Energy Efficiency Employment Impacts: Target 1 percent Growth in Energy Efficiency	6-31
Table 6A-1.	Labor Productivity Growth Rate due to Heat Rate Improvement	6A-5
Table 6A-2.	Capital Charge Rate and Duration Assumptions	6A-6

Table 6A-3.	Expenditure Breakdown due to New Generating Capacity.....	6A-6
Table 6A-4.	Labor Productivity due to New Generating Capacity.....	6A-7
Table 6A-5.	Average FOM Costs for Existing Coal and Oil and Gas Steam Capacity (\$/kW, 2011\$).....	6A-8
Table 6A-6.	Labor Productivity due to Fossil Fuel Extraction.....	6A-9
Table 7-1.	Monetized Benefits, Compliance Costs, and Net Benefits Under the Rate- based Illustrative Plan Approach (billions of 2011\$) ^a	7-4
Table 7-2.	Monetized Benefits, Compliance Costs, and Net Benefits under the Mass- based Illustrative Plan Approach (billions of 2011\$) ^a	7-5

LIST OF FIGURES

Figure 2-1.	New Build and Retired Capacity (MW) by Fuel Type, 2002-2012	2-4
Figure 2-2.	Cumulative Distribution in 2010 of Coal and Natural Gas Electricity Capacity and Generation, by Age	2-8
Figure 2-3.	Fossil Fuel-Fired Electricity Generating Facilities, by Size	2-9
Figure 2-4.	Average Retail Electricity Price by State (cents/kWh), 2011.....	2-13
Figure 2-5.	Nominal National Average Electricity Prices for Three Major End-Use Categories	2-14
Figure 2-6.	Relative Increases in Nominal National Average Electricity Prices for Major End-Use Categories, With Inflation Indices	2-15
Figure 2-7.	Real National Average Electricity Prices (2011\$) for Three Major End-Use Categories	2-16
Figure 2-8.	Relative Change in Real National Average Electricity Prices (2011\$) for Three Major End-Use Categories	2-17
Figure 2-9.	Relative Real Prices of Fossil Fuels for Electricity Generation; Change in National Average Real Price per MBtu Delivered to EGU	2-17
Figure 2-10.	Relative Growth of Electricity Generation, Population and Real GDP Since 2002	2-18
Figure 2-11.	Relative Change of Real GDP, Population and Electricity Generation Intensity Since 2002.....	2-19
Figure 2-12.	Status of State Electricity Industry Restructuring Activities.....	2-21
Figures 2-13 and 2-14.	Capacity and Generation Mix by Ownership Type, 2002 & 2012	2-23
Figures 2-15 and 2-16.	Generation Capacity Built and Retired between 2002 and 2012 by Ownership Type	2-24
Figure 2-17.	Domestic Emissions of Greenhouse Gases from Major Sectors, 2002 and 2013 (million tons of CO ₂ equivalent).....	2-25
Figure 2-18.	Marketable products from Syngas Generation	2-29
Figure 2-19.	Post-Combustion CO ₂ Capture for a Pulverized Coal Power Plant	2-30
Figure 2-20.	Pre-Combustion CO ₂ Capture for an IGCC Power Plant	2-31

Figure 2-21.	Geologic Sequestration in the Continental United States.....	2-34
Figure 2-22.	Relative Change Nominal and Real (2011\$) Prices of Natural Gas Delivered to the Power Sector (\$/MMBtu)	2-44
Figure 2-23.	Relative Change in Real (2011\$) Prices of Fossil Fuels Delivered to the Power Sector (\$/MMBtu)	2-45
Figure 3-1.	Illustrative Regions for Demand-Side Energy Efficiency/Renewable Energy Procurement Used in this Analysis.....	3-9
Figure 3-2	Generation Mix (thousand GWh).....	3-28
Figure 3-3.	Nationwide Generation: Historical (1990-2014) and Base Case Projections (2020, 2025, 2030).....	3-29
Figure 3-4.	Nationwide Generation: Historical (1990-2014) and Rate-Based Illustrative Plan Approach Projections (2020, 2025, 2030).....	3-29
Figure 3-5.	Nationwide Generation: Historical (1990-2014) and Mass-Based Illustrative Plan Approach Projections (2020, 2025, 2030).....	3-30
Figure 3-6.	Electricity Market Module Regions.....	3-40
Figure 4-1.	Monetized Health Co-benefits of Rate-based and Mass-based Illustrative Plan Approaches for the Final Emission Guidelines in 2025	3-35
Figure 4-2.	Breakdown of Monetized Health Co-benefits by Precursor Pollutant at a 3% Discount Rate for Rate-based and Mass-based Illustrative Plan Approaches for the Final Emission Guidelines in 2025	3-36
Figure 4-3.	Percentage of Adult Population (age 30+) by Annual Mean PM _{2.5} Exposure in the Option 1 State Scenario Clean Power Plan Proposal Modeling (used to generate the benefit-per-ton estimates).....	3-41
Figure 4-4.	Cumulative Distribution of Adult Population (age 30+) by Annual Mean PM _{2.5} Exposure in the Option 1 State Scenario Clean Power Plan Proposal Modeling (used to generate the benefit-per-ton estimates)	3-42
Figure 4-5.	Breakdown of Combined Monetized Climate and Health Co-benefits of Final Emission Guidelines in 2025 for Rate-based and Mass-based Illustrative Plan Approaches and Pollutants (3% discount rate)	3-46
Figure 4A-1.	Regional Breakdown	4A-7
Figure 6.1.	Electric Power Industry Employment.....	6-12
Figure 6.2.	Coal Production Employment.....	6-13

Figure 6.3. Oil and Gas Production Employment 6-14

Figure 6.4. Demand-Side Energy Efficiency Employment: Jobs per One Million Dollars
(2011\$) 6-32

ACRONYMS

ACS	American Cancer Society
AEO	Annual Energy Outlook
AQ	Air quality
ASM	Annual Survey of Manufactures
ATSDR	Agency for Toxic Substances and Disease Registry
BACT	Best Available Control Technology
BenMAP	Benefits Mapping and Analysis Program
BPT	Benefit-per-Ton
BSER	Best System of Emissions Reduction
Btu	British Thermal Units
C	Celsius
CAA	Clean Air Act
CAIR	Clean Air Interstate Rule
CCR	Coal Combustion Residuals
CCS	Carbon Capture and Sequestration or Carbon Capture and Storage
CCSP	Climate Change Science Program
CFR	Code of Federal Regulations
CH ₄	Methane
CO	Carbon Monoxide
CO ₂	Carbon Dioxide
CRF	Capital Recovery Factor
CSAPR	Cross State Air Pollution Rule
CT	Combustion Turbines
CUA	Climate Uncertainty Adder
DICE	Dynamic Integrated Climate and Economy Model
DOE	U.S. Department of Energy
EAB	Environmental Appeals Board
EC	Elemental carbon
ECS	Energy Cost Share
EG	Emissions guidelines
EGR	Enhanced Gas Recovery
EGU	Electric Generating Unit
EIA	U.S. Energy Information Administration
EMM	Electricity Market Module
EO	Executive Order
EOR	Enhanced Oil Recovery
EPA	U.S. Environmental Protection Agency
ER	Enhanced Recovery
FERC	Federal Energy Regulatory Commission
FGD	Flue Gas Desulfurization
FOAK	First of a Kind
FOM	Fixed Operating and Maintenance
FR	Federal Register
FRCC	Florida Reliability Coordinating Council
FUND	Framework for Uncertainty, Negotiation, and Distribution Model v
GDP	Gross Domestic Product
GHG	Greenhouse Gas

GS	Geologic Sequestration
Gt	Gigaton
H ₂ S	Hydrogen Sulfide
HAP	Hazardous air pollutant
HCl	Hydrogen chloride
HFC	Hydrofluorocarbons
HIA	Health impact assessment
IARC	International Agency for Research on Cancer
IAM	Integrated Assessment Model
ICR	Information Collection Request
IGCC	Integrated Gasification Combined Cycle
IOU	Investor Owned Utility
IPCC	Intergovernmental Panel on Climate Change
IPM	Integrated Planning Model
IRIS	Integrated Risk Information System
IRP	Integrated Resource Plan
ISA	Integrated Science Assessment
kWh	Kilowatt-hour
lbs	Pounds
LCOE	Levelized Cost of Electricity
LML	Lowest measured level
LNB	Low NO _x Burners
MATS	Mercury and Air Toxics Standards
MEA	Monoethanolamine
MECSA	Manufacturing Energy Consumption Survey
MeHg	Methylmercury
MGD	Millions of Gallons per Day
mg/L	Milligrams per Liter
MMBtu	Million British Thermal Units
MW	Megawatt
MWh	Megawatt-hour
N ₂ O	Nitrous Oxide
NAAQS	National Ambient Air Quality Standards
NAICS	North American Industry Classification System
NaOH	Sodium Hydroxide
NATCARB	National Carbon Sequestration Database and Geographic Information System
NEEDS	National Electric Energy Data System
NEMS	National Energy Modeling System
NERC	North American Electric Reliability Corporation
NETL	National Energy Technology Laboratory
NGCC	Natural Gas Combined Cycle
NMMAAPS	National Morbidity, Mortality Air Pollution Study
NOAK	Next of a Kind or Nth of a Kind
NO _x	Nitrogen Oxide
NRC	National Research Council
NSPS	New Source Performance Standard
NSR	New Source Review
NTTAA	National Technology Transfer and Advancement Act
OC	Organic carbon

OFA	Overfire Air
OMB	Office of Management and Budget
PAGE	Policy Analysis of the Greenhouse Gas Effect Model
PFC	Perfluorocarbons
PM _{2.5}	Fine Particulate Matter
ppm	Parts per Million
PRA	Paperwork Reduction Act
PSD	Prevention of Significant Deterioration
RCSP	Regional Carbon Sequestration Partnerships
RADS	Relative Airways Dysfunction Syndrome
RES	Renewable Electricity Standards
RFA	Regulatory Flexibility Act
RGGI	Regional Greenhouse Gas Initiative
RIA	Regulatory Impact Analysis
RPS	Renewable Portfolio Standards
SAB-CASAC	Science Advisory Board Clean Air Scientific Advisory Committee
SAB-HES	Science Advisory Board Health Effects Subcommittee of the Advisory Council on Clean Air Compliance
SAB-EEAC	Science Advisory Board Environmental Economics Advisory Committee
SBA	Small Business Administration
SBREFA	Small Business Regulatory Enforcement Fairness Act
SCC	Social Cost of Carbon
SCPC	Super Critical Pulverized Coal
SCR	Selective Catalytic Reduction
SF ₆	Sulfur Hexafluoride
SIP	State Implementation Plan
SO ₂	Sulfur Dioxide
Tcf	Trillion Cubic Feet
TDS	Total Dissolved Solids
TSD	Technical Support Document
TSM	Transportation Storage and Monitoring
UMRA	Unfunded Mandates Reform Act
U.S.C.	U.S. Code
USGCRP	U.S. Global Change Research Program
USGS	U.S. Geological Survey
USG SCC	U.S. Government's Social Cost of Carbon
U.S. NRC	U.S. Nuclear Regulatory Commission
VCS	Voluntary Consensus Standards
VOC	Volatile Organic Compounds
VOM	Variable Operating and Maintenance
VSL	Value of a statistical life
WTP	Willingness to pay

EXECUTIVE SUMMARY

This Regulatory Impact Analysis (RIA) discusses potential benefits, costs, and economic impacts of the Final Carbon Pollution Emission Guidelines for Existing Stationary Sources: Electric Utility Generating Units (herein referred to as “final emission guidelines” or the “Clean Power Plan Final Rule”).

ES.1 Background and Context

The emission of greenhouse gases (GHGs) threatens Americans' health and welfare by leading to long-lasting changes in our climate. Carbon dioxide (CO₂) is the primary greenhouse gas pollutant, accounting for roughly three-quarters of global greenhouse gas emissions in 2010 and 82 percent of U.S. greenhouse gas emissions in 2013. Fossil fuel-fired electric generating units (EGUs) are by far the largest emitters of GHGs, primarily in the form of CO₂, among stationary sources in the U.S.

In this action, the Environmental Protection Agency (EPA) is establishing final emission guidelines for states to follow in developing plans to reduce greenhouse gas emissions from existing fossil fuel-fired EGUs. Specifically, the EPA is establishing: 1) CO₂ emission performance rates representing the best system of emission reduction (BSER) for two subcategories of existing fossil fuel-fired EGUs – fossil fuel-fired electric utility steam generating units and stationary combustion turbines, 2) state-specific CO₂ goals reflecting the CO₂ emission performance rates, and 3) guidelines for the development, submittal and implementation of state plans that establish emission standards or other measures to implement the CO₂ emission performance rates, which may be accomplished by meeting the state goals. This final rule will continue progress already underway in the U.S. to reduce CO₂ emissions from the utility power sector.

ES.2 Summary of Clean Power Plan Final Rule

Under CAA section 111(d), states must establish standards of performance that reflect the degree of emission limitation achievable through the application of the “best system of emission reduction” (BSER) that, taking into account the cost of achieving such reduction and any non-air quality health and environmental impacts and energy requirements, the Administrator determines has been adequately demonstrated. The EPA has determined that the BSER is the combination of

emission rate improvements and limitations on overall emissions at affected EGUs that can be accomplished through any combination of one or more measures from the following three sets of measures or building blocks:

1. Improving heat rate at affected coal-fired steam EGUs.
2. Substituting increased generation from lower-emitting existing natural gas combined cycle units for reduced generation from higher-emitting affected steam generating units.
3. Substituting increased generation from new zero-emitting generating capacity for reduced generation from affected fossil fuel-fired generating units.

Specifically, the EPA is establishing CO₂ emission performance rates for two subcategories of existing fossil fuel-fired EGUs, fossil fuel-fired electric steam generating units and stationary combustion turbines. The rates are intended to represent CO₂ emission rates achievable by 2030 after a 2022-2029 interim period on an output-weighted-average basis collectively by all affected EGUs. The interim and final emission performance rates are presented in the following table:

Table ES-1. Emission Performance Rates (Adjusted Output-Weighted-Average Pounds of CO₂ Per Net MWh from All Affected Fossil Fuel-Fired EGUs)

Subcategory	Interim Rate	Final Rate
Fossil Fuel-Fired Electric Steam Generating Units	1,534	1,305
Stationary Combustion Turbines	832	771

Also, states with one or more affected EGUs will be required to develop and implement plans that set emission standards for affected EGU. These emission standards may incorporate the subcategory-specific CO₂ emission performance rates set by the EPA or, in the alternative, may be set at levels that ensure that the state’s affected EGUs, individually, in aggregate, or in combination with other measures undertaken by the state achieve the equivalent of the interim and final CO₂ emission performance rates between 2022 and 2029 and by 2030, respectively.

EPA derived statewide rate-based CO₂ emissions performance goals as a weighted average of the uniform rate goals with weights based on baseline generation for the two types of units (fossil steam and stationary combustion turbine) in the state. This blended rate reflects the

collective emission rate a state may expect to achieve when its baseline fleet of likely affected EGUs continues to operate at baseline levels while meeting its subcategory-specific emission performance rates reflecting the BSER.

The Clean Power Plan Final Rule also establishes an 8-year interim compliance period that begins in 2022 with a glide path for meeting interim CO₂ emission performance rates separated into three steps: 2022-2024, 2025-2027, and 2028-2029. This results in interim and final statewide goal values unique to each state's historical blend of fossil steam and NGCC generation. Chapter 3 presents finalized state rate-based CO₂ emissions performance goals.

The EPA is also establishing mass-based statewide CO₂ emission performance goals for each state, which are also presented in Chapter 3. For more detail on the methodology that translates CO₂ emission performance rates to mass-based CO₂ performance goals, please refer to the preamble of the Clean Power Plan Final Rule and the U.S. EPA's CO₂ Emission Performance Rate and Goal Computation Technical Support Document for Final Rule, which is available in the docket.¹

Given the flexibilities afforded states in complying with the emission guidelines, the benefits, cost and economic impacts reported in this RIA are not definitive estimates. Rather, the impact estimates are instead illustrative of approaches that states may take.

ES.3 Illustrative Plan Approaches Examined in RIA

In the final emission guidelines, the EPA has translated the source category-specific CO₂ emission performance rates into state-level rate-based and mass-based CO₂ goals in order to maximize the range of choices that states will have in developing their plans. Because of the range of choices available to states and the lack of *a priori* knowledge about the specific choices states will make in response to the final goals, this RIA presents two scenarios designed to achieve these goals, which we term the “rate-based” illustrative plan approach and the “mass-based” illustrative plan approach.

In this final rule, states may use trading or other multi-unit compliance approaches and technologies or strategies that are not explicitly mentioned in any of the three building blocks as

¹ U.S. EPA. 2015. Technical Support Document (TSD) the Final Carbon Pollution Emission Guidelines for Existing Stationary Sources: Electric Utility Generating Units. CO₂ Emission Performance Rate and Goal Computation.

part of their overall plans, as long as they achieve the required emission reductions from affected fossil fuel-fired EGUs. In addition, the final rule provides additional options to allow individual EGUs to use creditable out-of-state reductions to achieve required CO₂ reductions, without the need for up-front interstate agreements.

The modelled implementation plan approaches reflect states and affected EGUs pursuing building block strategies such as heat rate improvements, shifting generation to less CO₂ – intensive generation, and increased deployment of renewable energy, which are more completely described in Chapter 3. However, the modelled strategies are not limited to the technologies and measures included in the BSER. While the final rule no longer includes demand-side energy efficiency potential as part of BSER, the rule does allow such potential to be used for compliance. These scenarios include a representation of demand-side energy efficiency compliance potential because energy efficiency is a highly cost-effective means for reducing CO₂ from the power sector, and it is reasonable to assume that a regulatory requirement to reduce CO₂ emissions will motivate parties to pursue all highly cost-effective means for making emission reductions accordingly, regardless of what particular emission reduction measures were assumed in determining the level of that regulatory requirement. In the rate-based approach, energy efficiency activities are modeled as being used by EGUs as a low-cost method of demonstrating compliance with their rate-based emissions standards. In the mass-based approach, energy efficiency activities are assumed to be adopted by states to lower demand, which in turn reduces the cost of achieving the mass limitations.

Alternative compliance approaches other than those modelled are also possible, which may have different levels and distributions of emissions and electricity generation as well as costs. While IPM finds a least cost way to achieve the state goals implemented through the rate-based or mass-based emissions constraints imposed in the illustrative plan approaches, individual states or multi-state regional groups may develop alternate approaches to achieve their state goals.

It is very important to note that the differences between the analytical results for the rate-based and mass-based illustrative plan approaches presented in this RIA may not be indicative of likely differences between the approaches if implemented by states and affected EGUs in response to the final guidelines. Rather, the two sets of analyses are intended to illustrate two

contrasting, stylized implementation approaches to accomplish the emission performance rates finalized in the Clean Power Plan Final Rule. In other words, if one approach performs differently than the other on a given metric during a given time period, this does not imply this will apply in all instances.

To present a complete picture of costs and benefits of the final emission guidelines, this RIA presents results for the analysis years 2020, 2025, and 2030. While 2020 is before the first year of the interim compliance period (2022), the EPA expects states and affected EGUs to perform voluntary activities that will facilitate compliance with interim and final goals. These pre-compliance period activities might include investments in renewable energy or demand-side energy efficiency projects, for example, that produce emissions reductions in the compliance period. Activities might also include preparatory investments in transmission capacity or monitoring, reporting, and recordkeeping systems. As a result, there are likely to be benefits and costs in 2020, so these are reported in the illustrative analysis of this RIA. Meanwhile, cost and benefits are estimated in this RIA for 2025, which is intended to represent a central period of the interim compliance time-frame as states and tribes are on glide paths toward fully meeting the final CO₂ emission performance goals. Lastly, the RIA presents costs and benefits for 2030, when the emission performance goals are fully achieved.

ES.4 Emissions Reductions

Table ES-2 shows the emission reductions associated with the modelled rate-based illustrative plan approach.

Table ES-2. Climate and Air Pollutant Emission Reductions for the Rate-Based Illustrative Plan Approach¹

	CO ₂ (million short tons)	SO ₂ (thousand short tons)	Annual NO _x (thousand short tons)
2020 Rate-Based Approach			
Base Case	2,155	1,311	1,333
Final Guidelines	2,085	1,297	1,282
Emissions Change	-69	-14	-50
2025 Rate-Based Approach			
Base Case	2,165	1,275	1,302
Final Guidelines	1,933	1,097	1,138
Emissions Change	-232	-178	-165
2030 Rate-Based Approach			
Base Case	2,227	1,314	1,293
Final Guidelines	1,812	996	1,011
Emission Change	-415	-318	-282

Source: Integrated Planning Model, 2015. Emissions change may not sum due to rounding.

¹ CO₂ emission reductions are used to estimate the climate benefits of the guidelines. SO₂, and NO_x reductions are relevant for estimating air quality health co-benefits of the final guidelines. The final guidelines are also expected to achieve reductions in directly emitted PM_{2.5}, which we were not able to estimate for this RIA.

In 2020, the EPA estimates that CO₂ emissions will be reduced by 69 million short tons under the rate-based scenario compared to base case levels. In 2025, the EPA estimates that CO₂ emissions will be reduced by 232 million short tons under the rate-based approach compared to base case levels. CO₂ emission reductions increase to 415 million short tons annually in 2030 when compared to the base case emissions. Table ES-2 also shows emission reductions for criteria air pollutants (in short tons).²

² The final guidelines are also expected to achieve reductions in directly emitted PM_{2.5}, which we were not able to estimate for this RIA. However, the SO₂ and NO_x reductions account for the large majority of the anticipated health co-benefits. Based on analyses for the proposed rule which included benefits from reductions in directly emitted PM_{2.5}, those benefits accounted for less than 10 percent of total monetized health co-benefits.

Table ES-3 shows the emission reductions associated with the modeled mass-based illustrative plan approach.

Table ES-3. Climate and Air Pollutant Emission Reductions for the Mass-Based Illustrative Plan Approach¹

	CO ₂ (million short tons)	SO ₂ (thousand short tons)	Annual NO _x (thousand short tons)
2020 Mass-Based Approach			
Base Case	2,155	1,311	1,333
Final Guidelines	2,073	1,257	1,272
Emissions Change	-82	-54	-60
2025 Mass-Based Approach			
Base Case	2,165	1,275	1,302
Final Guidelines	1,901	1,090	1,100
Emissions Change	-264	-185	-203
2030 Mass-Based Approach			
Base Case	2,227	1,314	1,293
Final Guidelines	1,814	1,034	1,015
Emission Change	-413	-280	-278

Source: Integrated Planning Model, 2015. Emissions change may not sum due to rounding.

¹CO₂ emission reductions are used to estimate the climate benefits of the guidelines. SO₂, and NO_x reductions are relevant for estimating air quality health co-benefits of the final guidelines. The final guidelines are also expected to achieve reductions in directly emitted PM_{2.5}, which we were not able to estimate for this RIA.

In 2020, the EPA estimates that CO₂ emissions will be reduced by 82 million short tons under the mass-based approach compared to base case levels. In 2025, the EPA estimates that CO₂ emissions will be reduced by 264 million short tons under the mass-based approach compared to base case levels. CO₂ emission reductions increase to 413 million short tons annually in 2030 when compared to the base case emissions. Table ES-3 also shows emission reductions for criteria air pollutants (in short tons).

Table ES-4 presents CO₂ emission reductions relative to 2005.

Table ES-4. Projected CO₂ Emission Reductions, Relative to 2005

	CO ₂ Emissions (million short tons)	CO ₂ Emissions: Change from 2005 (million short tons)			CO ₂ Emissions Reductions: Percent Change from 2005		
		2005	2020	2025	2030	2020	2025
Base Case	2,683	-528	-518	-456	-20%	-19%	-17%
Rate-based	-	-598	-750	-871	-22%	-28%	-32%
Mass-based	-	-610	-782	-869	-23%	-29%	-32%

Source: Integrated Planning Model, 2015.

In 2020, the EPA estimates that CO₂ emissions will be reduced by 598 million short tons (22 percent) under the rate-based approach compared to 2005 levels. In 2025, the EPA estimates that CO₂ emissions will be reduced by 750 million short tons (28 percent) under the rate-based approach compared to 2005 levels. Under the rate-based approach, CO₂ emission reductions increase to 871 million short tons (32 percent) in 2030 when compared to 2005 levels.

Under the mass-based approach in 2020, the EPA estimates that CO₂ emissions will be reduced by 610 million short tons (23 percent) under the rate-based approach compared to 2005 levels. In 2025, the EPA estimates that CO₂ emissions will be reduced by 782 million short tons (29 percent) under the mass-based approach compared to 2005 levels. Under the mass-based approach, CO₂ emission reductions increase to 869 million short tons (32 percent) in 2030 when compared to 2005 levels.

ES.5 Costs

The compliance cost estimates for this final action are represented in this analysis as the change in electric power generation costs between the base case and illustrative plan approach policy cases, including the cost of demand-side energy efficiency measures and costs associated with monitoring, reporting, and recordkeeping requirements (MR&R). In the rate-based approach, energy efficiency activities are modeled as being used by EGUs as a low-cost method of demonstrating compliance with their rate-based emissions standards. In the mass-based approach, energy efficiency activities are assumed to be adopted by states to lower demand, which in turn reduces the cost of achieving the mass limitations. The level of energy efficiency measures is determined outside of IPM and is assumed to be the same in the two illustrative plan approaches. The compliance assumptions, and therefore the projected “compliance costs” set

forth in this analysis, are illustrative in nature and do not represent the full suite of compliance flexibilities states may ultimately pursue.

The annual incremental cost is the projected additional cost of complying with the final rule in the year analyzed and includes the net change in the annualized cost of capital investment in new generating sources and heat rate improvements at coal-fired steam generating units, the change in the ongoing costs of operating pollution controls, shifts between or amongst various fuels, demand-side energy efficiency measures, and other actions associated with compliance. The total compliance cost estimates presented here include the costs associated with monitoring, reporting, and recordkeeping.³ The costs for both illustrative plan approaches are reflected in Table ES-5 below and discussed more extensively in Chapter 3 of this RIA. All dollar estimates are in 2011 dollars.

The EPA estimates the annual incremental compliance cost for the rate-based approach for final emission guidelines to be \$2.5 billion in 2020, \$1.0 billion in 2025 and \$8.4 billion in 2030, including the costs associated with monitoring, reporting, and recordkeeping.⁴ The EPA estimates the annual incremental compliance cost for the mass-based approach for final emission guidelines to be \$1.4 billion in 2020, \$3.0 billion in 2025 and \$5.1 billion in 2030, including the costs associated with monitoring, reporting, and recordkeeping.

Table ES-5. Compliance Costs for the Illustrative Rate-Based and Mass-Based Plan Approaches

	Incremental Cost from Base Case (billions of 2011\$)	
	Rate-based Approach	Mass-based Approach
2020	\$2.5	\$1.4
2025	\$1.0	\$3.0
2030	\$8.4	\$5.1

Source: Integrated Planning Model, 2015, with post-processing to account for exogenous demand-side management energy efficiency costs and monitoring, reporting, and recordkeeping costs. See Chapter 3 of this RIA for more details.

³ These costs are estimated outside of the IPM modelling framework as IPM only models the contiguous U.S. and does not incorporate monitoring, reporting, and recordkeeping requirements specific to the Clean Power Plan Final Rules.

⁴ The MR&R costs estimates are \$67 million in 2020, \$16 million in 2025 and \$16 million in 2030 and are assumed to be the same for both rate-based and mass-based illustrative plan approaches. Note the MR&R costs in 2020 are related to facilities setting up net energy output monitoring and upgrading data acquisition systems.

The costs reported in Table ES-5 represent the estimated incremental electric utility generating costs changes from the base case plus the estimates of demand-side energy efficiency program costs (which are paid by electric utilities), demand-side energy efficiency participant costs (which are paid by electric utility consumers), and MR&R costs. For example, in 2030, under the rate-based approach, the incremental electric utility generating costs decline by about \$18.0 billion from the base case. MR&R requirements in 2030 are estimated at \$16.0 million, and demand-side energy efficiency costs in 2030 are estimated to be \$26.3 billion, split equally between program and participants using a 3 percent discount rate (see Chapter 3 of this RIA for more details on these estimates). These cost estimates sum to the \$8.4 billion shown in Table ES-3 and represent the total costs of the rate-based illustrative plan approach in 2030. The same approach applies in each year of analysis for the rate-based and the mass-based illustrative plan approaches.

The compliance costs reported in Table ES-5 are not social costs. These costs represent the estimated expenditures incurred by EGUs and states to comply with the BSER goals for the Clean Power Plan Final Rule. These compliance cost estimates are compared to estimates of social benefits to derive net benefits of the final emission guidelines, which are presented later in this Executive Summary. For a more extensive discussion of social costs and benefits, see Chapter 3 and Chapter 4, respectively, of this RIA.

ES.6 Monetized Climate Benefits and Health Co-benefits

Implementing the final emission guidelines is expected to reduce emissions of CO₂ and have ancillary emission reductions (i.e., co-benefits) of SO₂, NO₂, and directly emitted PM_{2.5}, which would lead to lower ambient concentrations of PM_{2.5} and ozone. The climate benefits estimates have been calculated using the estimated values of marginal climate impacts presented in the *Technical Support Document: Technical Update of the Social Cost of Carbon for Regulatory Impact Analysis under Executive Order 12866 (May 2013, Revised July 2015)*, henceforth denoted as the current SC-CO₂ TSD.⁵ Also, the range of combined benefits reflects

⁵ Technical Support Document: Technical Update of the Social Cost of Carbon for Regulatory Impact Analysis Under Executive Order 12866, Interagency Working Group on Social Cost of Carbon, with participation by Council of Economic Advisers, Council on Environmental Quality, Department of Agriculture, Department of Commerce, Department of Energy, Department of Transportation, Domestic Policy Council, Environmental Protection Agency, National Economic Council, Office of Management and Budget, Office of Science and Technology Policy, and

different concentration-response functions for the air quality health co-benefits, but it does not capture the full range of uncertainty inherent in the health co-benefits estimates. Furthermore, we were unable to quantify or monetize all of the climate benefits and health and environmental co-benefits associated with the final emission guidelines, including reducing exposure to SO₂, NO_x, and hazardous air pollutants (e.g., mercury), as well as ecosystem effects and visibility improvement. The omission of these endpoints from the monetized results should not imply that the impacts are small or unimportant. Table ES-6 provides the list of the quantified and unquantified health and environmental benefits in this analysis.

Department of Treasury (May 2013, Revised July 2015). Available at: <https://www.whitehouse.gov/sites/default/files/omb/inforeg/scc-tsd-final-july-2015.pdf> Accessed 7/11/2015.

Table ES-6. Quantified and Unquantified Benefits

Benefits Category	Specific Effect	Effect Has Been Quantified	Effect Has Been Monetized	More Information
Improved Environment				
Reduced climate effects	Global climate impacts from CO ₂	— ¹	✓	SC-CO ₂ TSD
	Climate impacts from ozone and black carbon (directly emitted PM)	—	—	Ozone ISA, PM ISA ²
	Other climate impacts (e.g., other GHGs such as methane, aerosols, other impacts)	—	—	IPCC ²
Improved Human Health (co-benefits)				
Reduced incidence of premature mortality from exposure to PM _{2.5}	Adult premature mortality based on cohort study estimates and expert elicitation estimates (age >25 or age >30)	✓	✓	PM ISA
	Infant mortality (age <1)	✓	✓	PM ISA
Reduced incidence of morbidity from exposure to PM _{2.5}	Non-fatal heart attacks (age > 18)	✓	✓	PM ISA
	Hospital admissions—respiratory (all ages)	✓	✓	PM ISA
	Hospital admissions—cardiovascular (age >20)	✓	✓	PM ISA
	Emergency room visits for asthma (all ages)	✓	✓	PM ISA
	Acute bronchitis (age 8-12)	✓	✓	PM ISA
	Lower respiratory symptoms (age 7-14)	✓	✓	PM ISA
	Upper respiratory symptoms (asthmatics age 9-11)	✓	✓	PM ISA
	Asthma exacerbation (asthmatics age 6-18)	✓	✓	PM ISA
	Lost work days (age 18-65)	✓	✓	PM ISA
	Minor restricted-activity days (age 18-65)	✓	✓	PM ISA
	Chronic Bronchitis (age >26)	—	—	PM ISA ²
	Emergency room visits for cardiovascular effects (all ages)	—	—	PM ISA ²
	Strokes and cerebrovascular disease (age 50-79)	—	—	PM ISA ²
	Other cardiovascular effects (e.g., other ages)	—	—	PM ISA ³
	Other respiratory effects (e.g., pulmonary function, non-asthma ER visits, non-bronchitis chronic diseases, other ages and populations)	—	—	PM ISA ³
	Reproductive and developmental effects (e.g., low birth weight, pre-term births, etc)	—	—	PM ISA ^{3,4}
Cancer, mutagenicity, and genotoxicity effects	—	—	PM ISA ^{3,4}	
Reduced incidence of mortality from exposure to ozone	Premature mortality based on short-term study estimates (all ages)	✓	✓	Ozone ISA
	Premature mortality based on long-term study estimates (age 30–99)	—	—	Ozone ISA ²
Reduced incidence of morbidity from exposure to ozone	Hospital admissions—respiratory causes (age > 65)	✓	✓	Ozone ISA
	Hospital admissions—respiratory causes (age <2)	✓	✓	Ozone ISA
	Emergency department visits for asthma (all ages)	✓	✓	Ozone ISA
	Minor restricted-activity days (age 18–65)	✓	✓	Ozone ISA
	School absence days (age 5–17)	✓	✓	Ozone ISA
	Decreased outdoor worker productivity (age 18–65)	—	—	Ozone ISA ²
	Other respiratory effects (e.g., premature aging of lungs)	—	—	Ozone ISA ³
	Cardiovascular and nervous system effects	—	—	Ozone ISA ³
Reproductive and developmental effects	—	—	Ozone ISA ^{3,4}	

Table ES-6. Continued

Reduced incidence of morbidity from exposure to NO ₂	Asthma hospital admissions (all ages)	—	—	NO ₂ ISA ²
	Chronic lung disease hospital admissions (age > 65)	—	—	NO ₂ ISA ²
	Respiratory emergency department visits (all ages)	—	—	NO ₂ ISA ²
	Asthma exacerbation (asthmatics age 4–18)	—	—	NO ₂ ISA ²
	Acute respiratory symptoms (age 7–14)	—	—	NO ₂ ISA ²
	Premature mortality	—	—	NO ₂ ISA ^{2,3,4}
	Other respiratory effects (e.g., airway hyperresponsiveness and inflammation, lung function, other ages and populations)	—	—	NO ₂ ISA ^{3,4}
Reduced incidence of morbidity from exposure to SO ₂	Respiratory hospital admissions (age > 65)	—	—	SO ₂ ISA ²
	Asthma emergency department visits (all ages)	—	—	SO ₂ ISA ²
	Asthma exacerbation (asthmatics age 4–12)	—	—	SO ₂ ISA ²
	Acute respiratory symptoms (age 7–14)	—	—	SO ₂ ISA ²
	Premature mortality	—	—	SO ₂ ISA ^{2,3,4}
Other respiratory effects (e.g., airway hyperresponsiveness and inflammation, lung function, other ages and populations)	—	—	SO ₂ ISA ^{2,3}	
Reduced incidence of morbidity from exposure to methylmercury	Neurologic effects—IQ loss	—	—	IRIS; NRC, 2000 ²
	Other neurologic effects (e.g., developmental delays, memory, behavior)	—	—	IRIS; NRC, 2000 ³
	Cardiovascular effects	—	—	IRIS; NRC, 2000 ^{3,4}
	Genotoxic, immunologic, and other toxic effects	—	—	IRIS; NRC, 2000 ^{3,4}
Improved Environment (co-benefits)				
Reduced visibility impairment	Visibility in Class 1 areas	—	—	PM ISA ²
	Visibility in residential areas	—	—	PM ISA ²
Reduced effects on materials	Household soiling	—	—	PM ISA ^{2,3}
	Materials damage (e.g., corrosion, increased wear)	—	—	PM ISA ³
Reduced PM deposition (metals and organics)	Effects on Individual organisms and ecosystems	—	—	PM ISA ³
Reduced vegetation and ecosystem effects from exposure to ozone	Visible foliar injury on vegetation	—	—	Ozone ISA ²
	Reduced vegetation growth and reproduction	—	—	Ozone ISA ²
	Yield and quality of commercial forest products and crops	—	—	Ozone ISA ²
	Damage to urban ornamental plants	—	—	Ozone ISA ³
	Carbon sequestration in terrestrial ecosystems	—	—	Ozone ISA ²
	Recreational demand associated with forest aesthetics	—	—	Ozone ISA ³
	Other non-use effects			Ozone ISA ³
	Ecosystem functions (e.g., water cycling, biogeochemical cycles, net primary productivity, leaf-gas exchange, community composition)	—	—	Ozone ISA ³
Reduced effects from acid deposition	Recreational fishing	—	—	NO _x SO _x ISA ²
	Tree mortality and decline	—	—	NO _x SO _x ISA ³
	Commercial fishing and forestry effects	—	—	NO _x SO _x ISA ³
	Recreational demand in terrestrial and aquatic ecosystems	—	—	NO _x SO _x ISA ³
	Other non-use effects			NO _x SO _x ISA ³
Ecosystem functions (e.g., biogeochemical cycles)	—	—	NO _x SO _x ISA ³	

Table ES-6. Continued

Reduced effects from nutrient enrichment	Species composition and biodiversity in terrestrial and estuarine ecosystems	—	—	NO _x SO _x ISA ³
	Coastal eutrophication	—	—	NO _x SO _x ISA ³
	Recreational demand in terrestrial and estuarine ecosystems	—	—	NO _x SO _x ISA ³
	Other non-use effects			NO _x SO _x ISA ³
Reduced vegetation effects from exposure to SO ₂ and NO _x	Ecosystem functions (e.g., biogeochemical cycles, fire regulation)	—	—	NO _x SO _x ISA ³
	Injury to vegetation from SO ₂ exposure	—	—	NO _x SO _x ISA ³
Reduced ecosystem effects from exposure to methylmercury	Injury to vegetation from NO _x exposure	—	—	NO _x SO _x ISA ³
	Effects on fish, birds, and mammals (e.g., reproductive effects)	—	—	Mercury Study RTC ³
	Commercial, subsistence and recreational fishing	—	—	Mercury Study RTC ²

¹ The global climate and related impacts of CO₂ emissions changes, such as sea level rise, are estimated within each integrated assessment model as part of the calculation of the SC-CO₂. The resulting monetized damages, which are relevant for conducting the benefit-cost analysis, are used in this RIA to estimate the welfare effects of quantified changes in CO₂ emissions.

² We assess these co-benefits qualitatively due to data and resource limitations for this analysis.

³ We assess these co-benefits qualitatively because we do not have sufficient confidence in available data or methods.

⁴ We assess these co-benefits qualitatively because current evidence is only suggestive of causality or there are other significant concerns over the strength of the association.

ES.6.1 Estimating Global Climate Benefits

We estimate the global social benefits of CO₂ emission reductions expected from this rulemaking using the SC-CO₂ estimates presented in the current SC-CO₂ TSD. We refer to these estimates, which were developed by the U.S. government, as “SC-CO₂ estimates” for the remainder of this document. The SC-CO₂ is a metric that estimates the monetary value of impacts associated with marginal changes in CO₂ emissions in a given year. It includes a wide range of anticipated climate impacts, such as net changes in agricultural productivity and human health, property damage from increased flood risk, and changes in energy system costs, such as reduced costs for heating and increased costs for air conditioning. It is typically used to assess the avoided damages as a result of regulatory actions (i.e., benefits of rulemakings that lead to an incremental reduction in cumulative global CO₂ emissions).

The SC-CO₂ estimates used in this analysis have been developed over many years, using the best science available, and with input from the public. The EPA and other federal agencies

have considered the extensive public comments on ways to improve SC-CO₂ estimation received via the notice and comment period that was part of numerous rulemakings. In addition, OMB's Office of Information and Regulatory Affairs recently issued a response to the public comments it sought through a separate comment period on the approach used to develop the SC-CO₂ estimates.⁶

An interagency working group (IWG) that included the EPA and other executive branch entities used three integrated assessment models (IAMs) to develop SC-CO₂ estimates and recommended four global values for use in regulatory analyses. The SC-CO₂ estimates represent global measures because of the distinctive nature of the climate change problem. Emissions of greenhouse gases contribute to damages around the world, even when they are released in the United States, and the world's economies are now highly interconnected. Therefore, the SC-CO₂ estimates incorporate the worldwide damages caused by carbon dioxide emissions in order to reflect the global nature of the problem, and we expect other governments to consider the global consequences of their greenhouse gas emissions when setting their own domestic policies. See RIA Chapter 4 for more discussion.

The IWG first released the estimates in February 2010 and updated them in 2013 using new versions of each IAM. The SC-CO₂ values was estimated using three integrated assessment models (DICE, FUND, and PAGE)⁷, which the IWG harmonized across three key inputs: the probability distribution for equilibrium climate sensitivity; five scenarios for economic, population, and emissions growth; and three constant discount rates. The 2010 SC-CO₂ Technical Support Document (2010 SC-CO₂ TSD) provides a complete discussion of the methodology and the current SC-CO₂ TSD⁸ presents and discusses the updated estimates. The four SC-CO₂ estimates are as follows: \$12, \$40, \$60, and \$120 per short ton of CO₂ emissions in the year 2020 (2011\$), and each estimate increases over time.⁹ These SC-CO₂ estimates are

⁶ See <https://www.whitehouse.gov/sites/default/files/omb/inforeg/scc-response-to-comments-final-july-2015.pdf>

⁷ The full models names are as follows: Dynamic Integrated Climate and Economy (DICE); Climate Framework for Uncertainty, Negotiation, and Distribution (FUND); and Policy Analysis of the Greenhouse Gas Effect (PAGE).

⁸ The IWG published the updated TSD in 2013, then issued two minor corrections to it in July 2015.

⁹ The 2010 and 2013 TSDs present SC-CO₂ in 2007\$ per metric ton. The estimates were adjusted to (1) short tons for using conversion factor 0.90718474 and (2) 2011\$ using GDP Implicit Price Deflator, <http://www.gpo.gov/fdsys/pkg/ECONI-2013-02/pdf/ECONI-2013-02-Pg3.pdf>.

associated with different discount rates. The first three estimates are the model average at 5 percent discount rate, 3 percent, and 2.5 percent, respectively, and the fourth estimate is the 95th percentile at 3 percent.

The 2010 SC-CO₂ TSD noted a number of limitations to the SC-CO₂ analysis, including the incomplete way in which the IAMs capture catastrophic and non-catastrophic impacts, their incomplete treatment of adaptation and technological change, uncertainty in the extrapolation of damages to high temperatures, and assumptions regarding risk aversion. Currently integrated assessment models do not assign value to all of the important physical, ecological, and economic impacts of climate change recognized in the climate change literature because of a lack of precise information on the nature of damages and because the science incorporated into these models understandably lags behind the most recent research. In particular, the IPCC Fourth Assessment Report concluded that “It is very likely that [SC-CO₂ estimates] underestimate the damage costs because they cannot include many non-quantifiable impacts.” Nonetheless, these estimates and the discussion of their limitations represent the best available information about the social benefits of CO₂ emission reductions to inform the benefit-cost analysis.

In addition, after careful evaluation of the full range of comments submitted to OMB’s Office of Information and Regulatory Affairs, the IWG continues to recommend the use of these SC-CO₂ estimates in regulatory impact analysis. With the release of the response to comments, the IWG announced plans to obtain expert independent advice from the National Academies of Sciences, Engineering, and Medicine (Academies) to ensure that the SC-CO₂ estimates continue to reflect the best available scientific and economic information on climate change.¹⁰ The Academies process will be informed by the public comments received and focus on the technical merits and challenges of potential approaches to improving the SC-CO₂ estimates in future updates.

ES 6.2 Estimating Air Quality Health Co-Benefits

The final emission guidelines would reduce emissions of precursor pollutants (e.g., SO₂, NO_x, and directly emitted particles), which in turn would lower ambient concentrations of PM_{2.5}

¹⁰ See <<https://www.whitehouse.gov/blog/2015/07/02/estimating-benefits-carbon-dioxide-emissions-reductions>>.

and ozone. This co-benefits analysis quantifies the monetized benefits associated with the reduced exposure to these two pollutants.¹¹ Unlike the global SC-CO₂ estimates, the air quality health co-benefits are only estimated for the contiguous U.S. The estimates of monetized PM_{2.5} co-benefits include avoided premature deaths (derived from effect coefficients in two cohort studies [Krewski *et al.* 2009 and Lepeule *et al.* 2012] for adults and one for infants [Woodruff *et al.* 1997]), as well as avoided morbidity effects for ten non-fatal endpoints ranging in severity from lower respiratory symptoms to heart attacks (U.S. EPA, 2012). The estimates of monetized ozone co-benefits include avoided premature deaths (derived from the range of effect coefficients represented by two short-term epidemiology studies [Bell *et al.* (2004) and Levy *et al.* (2005)]), as well as avoided morbidity effects for five non-fatal endpoints ranging in severity from school absence days to hospital admissions (U.S. EPA, 2008, 2011).

We use a “benefit-per-ton” approach to estimate the PM_{2.5} and ozone co-benefits in this RIA. Benefit-per-ton approaches apply an average benefit per ton derived from modeling of benefits of specific air quality scenarios to estimates of emissions reductions for scenarios where no air quality modeling is available. The benefit-per-ton approach we use in this RIA relies on estimates of human health responses to exposure to PM and ozone obtained from the peer-reviewed scientific literature. These estimates are used in conjunction with population data, baseline health information, air quality data and economic valuation information to conduct health impact and economic benefits assessments.

Specifically, in this analysis, we multiplied the benefit-per-ton estimates by the corresponding emission reductions that were generated from air quality modeling of the proposed Clean Power Plan. Similar to the co-benefits analysis conducted for the RIA for this rule at proposal, we generated regional benefit-per-ton estimates by aggregating the impacts in BenMAP¹² to the region (i.e., East, West, and California) rather than aggregating to the nation. To calculate the co-benefits for the final emission guidelines, we then multiplied the regional

¹¹ We did not estimate the co-benefits associated with reducing direct exposure to SO₂ and NO_x. For this RIA, we did not estimate changes in emissions of directly emitted particles. As a result, quantified PM_{2.5} related benefits are underestimated by a relatively small amount. In the proposal RIA, the benefits from reductions in directly emitted PM_{2.5} were less than 10 percent of total monetized health co-benefits across all scenarios and years.

¹² BenMAP is a computer program developed by the EPA that calculates the number and economic value of air pollution-related deaths and illnesses. The software incorporates a database that includes many of the concentration-response relationships, population files, and health and economic data needed to quantify these impacts.

benefit-per-ton estimates for the EGU sector by the corresponding emission reductions. All benefit-per-ton estimates reflect the geographic distribution of the modeled emissions, which may not exactly match the emission reductions in this rulemaking, and thus they may not reflect the local variability in population density, meteorology, exposure, baseline health incidence rates, or other local factors for any specific location.

Our estimate of the monetized co-benefits is based on the EPA's interpretation of the best available scientific literature (U.S. EPA, 2009) and methods and supported by the EPA's Science Advisory Board and the NAS (NRC, 2002). Below are key assumptions underlying the estimates for PM_{2.5}-related premature mortality, which accounts for 98 percent of the monetized PM_{2.5} health co-benefits:

1. We assume that all fine particles, regardless of their chemical composition, are equally potent in causing premature mortality. This is an important assumption, because PM_{2.5} varies considerably in composition across sources, but the scientific evidence is not yet sufficient to allow differentiation of effect estimates by particle type. The PM ISA concluded that “many constituents of PM_{2.5} can be linked with multiple health effects, and the evidence is not yet sufficient to allow differentiation of those constituents or sources that are more closely related to specific outcomes” (U.S. EPA, 2009b).
2. We assume that the health impact function for fine particles is log-linear without a threshold in this analysis. Thus, the estimates include health co-benefits from reducing fine particles in areas with varied concentrations of PM_{2.5}, including both areas that do not meet the National Ambient Air Quality Standard for fine particles and those areas that are in attainment, down to the lowest modeled concentrations.
3. We assume that there is a “cessation” lag between the change in PM exposures and the total realization of changes in mortality effects. Specifically, we assume that some of the incidences of premature mortality related to PM_{2.5} exposures occur in a distributed fashion over the 20 years following exposure based on the advice of the SAB-HES (U.S. EPA-SAB, 2004c), which affects the valuation of mortality co-benefits at different discount rates.

Every benefits analysis examining the potential effects of a change in environmental protection requirements is limited, to some extent, by data gaps, model capabilities (such as geographic coverage) and uncertainties in the underlying scientific and economic studies used to configure the benefit and cost models. In addition, given the flexibilities afforded states in complying with the emission guidelines, the co-benefits estimated presented in this RIA are not definitive estimates, but are instead illustrative of approaches that states may take. Despite these uncertainties, we believe this analysis provides a reasonable indication of the expected health co-benefits of the air quality emission reductions for the final emission guidelines under a set of reasonable assumptions. This analysis does not include the type of detailed uncertainty assessment found in the 2012 PM_{2.5} National Ambient Air Quality Standard (NAAQS) RIA (U.S. EPA, 2012) because we lack the necessary air quality input and monitoring data to conduct a complete benefits assessment. In addition, using a benefit-per-ton approach adds another important source of uncertainty to the benefits estimates.

ES 6.3 Combined Benefits Estimates

The EPA has evaluated the range of potential impacts by combining all four SC-CO₂ values with health co-benefits values at the 3 percent and 7 percent discount rates. Different discount rates are applied to SC-CO₂ than to the health co-benefit estimates; because CO₂ emissions are long-lived and subsequent damages occur over many years. Moreover, several discount rates are applied to SC-CO₂ because the literature shows that the estimate of SC-CO₂ is sensitive to assumptions about discount rate and because no consensus exists on the appropriate rate to use in an intergenerational context. The U.S. government centered its attention on the average SC-CO₂ at a 3 percent discount rate but emphasized the importance of considering all four SC-CO₂ estimates. Table ES-7 (rate-based illustrative plan approach) and Table ES-8 (mass-based illustrative plan approach) provide the combined climate benefits and health co-benefits for the Clean Power Plan Final Rule estimated for 2020, 2025, and 2030 for each discount rate combination. All dollar estimates are in 2011 dollars.

Table ES-7. Combined Estimates of Climate Benefits and Health Co-Benefits for Rate-Based Approach (billions of 2011\$)*

SC-CO ₂ Discount Rate and Statistic**	Climate Benefits Only	Climate Benefits plus Health Co-benefits (Discount Rate Applied to Health Co-benefits)	
		3%	7%
In 2020	69	million short tons CO ₂	
5%	\$0.80	\$1.5 to \$2.6	\$1.4 to \$2.5
3%	\$2.8	\$3.5 to \$4.6	\$3.5 to \$4.5
2.5%	\$4.1	\$4.9 to \$6.0	\$4.8 to \$5.9
3% (95 th percentile)	\$8.2	\$8.9 to \$10	\$8.9 to \$9.9
In 2025	232	million short tons CO ₂	
5%	\$3.1	\$11 to \$21	\$9.9 to \$19
3%	\$10	\$18 to \$28	\$17 to \$26
2.5%	\$15	\$23 to \$33	\$22 to \$31
3% (95 th percentile)	\$31	\$38 to \$49	\$38 to \$47
In 2030	415	million short tons CO ₂	
5%	\$6.4	\$21 to \$40	\$19 to \$37
3%	\$20	\$34 to \$54	\$33 to \$51
2.5%	\$29	\$43 to \$63	\$42 to \$60
3% (95 th percentile)	\$61	\$75 to \$95	\$74 to \$92

*All benefit estimates are rounded to two significant figures. Climate benefits are based on reductions in CO₂ emissions. Co-benefits are based on regional benefit-per-ton estimates. Ozone co-benefits occur in analysis year, so they are the same for all discount rates. The health co-benefits reflect the sum of the PM_{2.5} and ozone co-benefits and reflect the range based on adult mortality functions (e.g., from Krewski *et al.* (2009) with Bell *et al.* (2004) to Lepeule *et al.* (2012) with Levy *et al.* (2005)). The monetized health co-benefits do not include reduced health effects from reductions in directly emitted PM_{2.5}, direct exposure to NO_x, SO₂, and HAP; ecosystem effects; or visibility impairment. See Chapter 4 for more information about these estimates and for more information regarding the uncertainty in these estimates.

**Unless otherwise specified, it is the model average.

Table ES-8. Combined Estimates of Climate Benefits and Health Co-benefits for Mass-Based Approach (billions of 2011\$)*

SC-CO ₂ Discount Rate and Statistic**	Climate Benefits Only	Climate Benefits plus Health Co-benefits (Discount Rate Applied to Health Co-benefits)			
		3%		7%	
In 2020	82	million short tons CO ₂			
5%	\$0.94	\$2.9	to	\$5.7	\$2.8 to \$5.3
3%	\$3.3	\$5.3	to	\$8.1	\$5.1 to \$7.7
2.5%	\$4.9	\$6.9	to	\$9.7	\$6.7 to \$9.3
3% (95 th percentile)	\$9.7	\$12	to	\$14	\$11 to \$14
In 2025	264	million short tons CO ₂			
5%	\$3.6	\$11	to	\$21	\$10 to \$19
3%	\$12	\$19	to	\$29	\$18 to \$27
2.5%	\$17	\$24	to	\$35	\$24 to \$33
3% (95 th percentile)	\$35	\$42	to	\$52	\$42 to \$51
In 2030	413	million short tons CO ₂			
5%	\$6.4	\$18	to	\$34	\$17 to \$32
3%	\$20	\$32	to	\$48	\$31 to \$46
2.5%	\$29	\$41	to	\$57	\$40 to \$55
3% (95 th percentile)	\$60	\$72	to	\$89	\$71 to \$86

*All benefit estimates are rounded to two significant figures. Climate benefits are based on reductions in CO₂ emissions. Co-benefits are based on regional benefit-per-ton estimates. Ozone co-benefits occur in analysis year, so they are the same for all discount rates. The health co-benefits reflect the sum of the PM_{2.5} and ozone co-benefits and reflect the range based on adult mortality functions (e.g., from Krewski *et al.* (2009) with Bell *et al.* (2004) to Lepeule *et al.* (2012) with Levy *et al.* (2005)). The monetized health co-benefits do not include reduced health effects from reductions in directly emitted PM_{2.5}, direct exposure to NO_x, SO₂, and HAP; ecosystem effects; or visibility impairment. See Chapter 4 for more information about these estimates and for more information regarding the uncertainty in these estimates.

**Unless otherwise specified, it is the model average.

ES.7 Net Benefits

Table ES-9 and ES-10 provide the estimates of the climate benefits, health co-benefits, compliance costs and net benefits of the final emission guidelines for rate-based and mass-based approaches, respectively. There are additional important benefits that the EPA could not monetize. Due to current data and modeling limitations, our estimates of the benefits from reducing CO₂ emissions do not include important impacts like ocean acidification or potential tipping points in natural or managed ecosystems. Unquantified benefits also include climate benefits from reducing emissions of non-CO₂ greenhouse gases and co-benefits from reducing exposure to SO₂, NO_x, and hazardous air pollutants (e.g., mercury), as well as ecosystem effects and visibility impairment. Upon considering these limitations and uncertainties, it remains clear that the benefits of this final rule are substantial and far outweigh the costs.

Table ES-9. Monetized Benefits, Compliance Costs, and Net Benefits Under the Rate-based Illustrative Plan Approach (billions of 2011\$) ^a

	Rate-Based Approach					
	2020		2025		2030	
Climate Benefits ^b						
5% discount rate	\$0.80		\$3.1		\$6.4	
3% discount rate	\$2.8		\$10		\$20	
2.5% discount rate	\$4.1		\$15		\$29	
95th percentile at 3% discount rate	\$8.2		\$31		\$61	
	<u>Air Quality Co-benefits Discount Rate</u>					
	3%	7%	3%	7%	3%	7%
Air Quality Health Co-benefits ^c	\$0.70 to \$1.8	\$0.64 to \$1.7	\$7.4 to \$18	\$6.7 to \$16	\$14 to \$34	\$13 to \$31
Compliance Costs ^d	\$2.5		\$1.0		\$8.4	
Net Benefits ^e	\$1.0 to \$2.1	\$1.0 to \$2.0	\$17 to \$27	\$16 to \$25	\$26 to \$45	\$25 to \$43
Non-Monetized Benefits	Non-monetized climate benefits					
	Reductions in exposure to ambient NO ₂ and SO ₂					
	Reductions in mercury deposition					
	Ecosystem benefits associated with reductions in emissions of NO _x , SO ₂ , PM, and mercury					
	Visibility impairment					

^a All are rounded to two significant figures, so figures may not sum.

^b The climate benefit estimate in this summary table reflects global impacts from CO₂ emission changes and does not account for changes in non-CO₂ GHG emissions. Also, different discount rates are applied to SC-CO₂ than to the other estimates because CO₂ emissions are long-lived and subsequent damages occur over many years. The benefit estimates in this table are based on the average SC-CO₂ estimated for a 3 percent discount rate, however we emphasize the importance and value of considering the full range of SC-CO₂ values. As shown in the RIA, climate benefits are also estimated using the other three SC-CO₂ estimates (model average at 2.5 percent discount rate, 3 percent, and 5 percent; 95th percentile at 3 percent). The SC-CO₂ estimates are year-specific and increase over time.

^c The air quality health co-benefits reflect reduced exposure to PM_{2.5} and ozone associated with emission reductions of SO₂ and NO_x. The co-benefits do not include the benefits of reductions in directly emitted PM_{2.5}. These additional benefits would increase overall benefits by a few percent based on the analyses conducted for the proposed rule. The range reflects the use of concentration-response functions from different epidemiology studies. The reduction in premature fatalities each year accounts for over 98 percent of total monetized co-benefits from PM_{2.5} and ozone. These models assume that all fine particles, regardless of their chemical composition, are equally potent in causing premature mortality because the scientific evidence is not yet sufficient to allow differentiation of effect estimates by particle type. Estimates in the table are presented for three analytical years with air quality co-benefits calculated using two discount rates. The estimates of co-benefits are annual estimates in each of the analytical years, reflecting discounting of mortality benefits over the cessation lag between changes in PM_{2.5} concentrations and changes in risks of premature death (see RIA Chapter 4 for more details), and discounting of morbidity benefits due to the multiple years of costs associated with some illnesses. The estimates are not the present value of the benefits of the rule over the full compliance period.

^d Total costs are approximated by the illustrative compliance costs estimated using the Integrated Planning Model for the final emission guidelines and a discount rate of approximately 5 percent. This estimate also includes monitoring, recordkeeping, and reporting costs and demand-side energy efficiency program and participant costs.

^e The estimates of net benefits in this summary table are calculated using the global SC-CO₂ at a 3 percent discount rate (model average). The RIA includes combined climate and health estimates based on additional discount rates.

Table ES-10. Monetized Benefits, Compliance Costs, and Net Benefits under the Mass-based Illustrative Plan Approach (billions of 2011\$) ^a

	Mass-Based Approach					
	2020		2025		2030	
Climate Benefits ^b						
5% discount rate	\$0.94		\$3.6		\$6.4	
3% discount rate	\$3.3		\$12		\$20	
2.5% discount rate	\$4.9		\$17		\$29	
95th percentile at 3% discount rate	\$9.7		\$35		\$60	
	<u>Air Quality Co-benefits Discount Rate</u>					
	3%		7%		3%	
Air Quality Health Co-benefits ^c	\$2.0 to \$4.8	\$1.8 to \$4.4	\$7.1 to \$17	\$6.5 to \$16	\$12 to \$28	\$11 to \$26
Compliance Costs ^d	\$1.4		\$3.0		\$5.1	
Net Benefits ^e	\$3.9 to \$6.7	\$3.7 to \$6.3	\$16 to \$26	\$15 to \$24	\$26 to \$43	\$25 to \$40
Non-Monetized Benefits	Non-monetized climate benefits Reductions in exposure to ambient NO ₂ and SO ₂ Reductions in mercury deposition Ecosystem benefits associated with reductions in emissions of NO _x , SO ₂ , PM, and mercury Visibility improvement					

^a All are rounded to two significant figures, so figures may not sum.

^b The climate benefit estimate in this summary table reflects global impacts from CO₂ emission changes and does not account for changes in non-CO₂ GHG emissions. Also, different discount rates are applied to SC-CO₂ than to the other estimates because CO₂ emissions are long-lived and subsequent damages occur over many years. The benefit estimates in this table are based on the average SC-CO₂ estimated for a 3 percent discount rate, however we emphasize the importance and value of considering the full range of SC-CO₂ values. As shown in the RIA, climate benefits are also estimated using the other three SC-CO₂ estimates (model average at 2.5 percent discount rate, 3 percent, and 5 percent; 95th percentile at 3 percent). The SC-CO₂ estimates are year-specific and increase over time.

^c The air quality health co-benefits reflect reduced exposure to PM_{2.5} and ozone associated with emission reductions of, SO₂ and NO_x. The co-benefits do not include the benefits of reductions in directly emitted PM_{2.5}. These additional benefits would increase overall benefits by a few percent based on the analyses conducted for the proposed rule. The range reflects the use of concentration-response functions from different epidemiology studies. The reduction in premature fatalities each year accounts for over 98 percent of total monetized co-benefits from PM_{2.5} and ozone. These models assume that all fine particles, regardless of their chemical composition, are equally potent in causing premature mortality because the scientific evidence is not yet sufficient to allow differentiation of effect estimates by particle type. Estimates in the table are presented for three analytical years with air quality co-benefits calculated using two discount rates. The estimates of co-benefits are annual estimates in each of the analytical years, reflecting discounting of mortality benefits over the cessation lag between changes in PM_{2.5} concentrations and changes in risks of premature death (see RIA Chapter 4 for more details), and discounting of morbidity benefits due to the multiple years of costs associated with some illnesses. The estimates are not the present value of the benefits of the rule over the full compliance period.

^d Total costs are approximated by the illustrative compliance costs estimated using the Integrated Planning Model for the final emission guidelines and a discount rate of approximately 5 percent. This estimate also includes monitoring, recordkeeping, and reporting costs and demand-side energy efficiency program and participant costs.

^e The estimates of net benefits in this summary table are calculated using the global SC-CO₂ at a 3 percent discount rate (model average). The RIA includes combined climate and health estimates based on additional discount rates.

ES.8 Economic Impacts

The final emission guidelines have important energy market implications. Table ES-11 presents a variety of important energy market impacts for 2020, 2025, and 2030 for both the rate-based and mass-based illustrative plan approaches.

Table ES-11. Summary Table of Important Energy Market Impacts (Percent Change from Base Case)

	Rate-Based			Mass-Based		
	2020	2025	2030	2020	2025	2030
Retail electricity prices	3%	1%	1%	3%	2%	0%
Price of coal at minemouth	-1%	-5%	-4%	-1%	-5%	-3%
Coal production for power sector use	-5%	-14%	-25%	-7%	-17%	-24%
Price of natural gas delivered to power sector	5%	-8%	2%	4%	-3%	-2%
Natural gas use for electricity generation	3%	-1%	-1%	5%	0%	-4%

Energy market impacts from the guidelines are discussed more extensively in Chapter 3 of this RIA.

Additionally, changes in supply or demand for electricity, natural gas, and coal can impact markets for goods and services produced by sectors that use these energy inputs in the production process or that supply those sectors. Changes in cost of production may result in changes in price and/or quantity produced by these sectors and these market changes may affect the profitability of firms and the economic welfare of their consumers. The EPA recognizes that these final emission guidelines provide flexibility, and states implementing the guidelines may choose to mitigate impacts to some markets outside the EGU sector. Similarly, demand for new generation or energy efficiency, for example, can result in changes in production and profitability for firms that supply those goods and services.

ES.9 Employment Impacts

Executive Order 13563 directs federal agencies to consider the effect of regulations on job creation and employment. According to the Executive Order, “our regulatory system must protect public health, welfare, safety, and our environment while promoting economic growth, innovation, competitiveness, and job creation. It must be based on the best available science” (Executive Order 13563, 2011). Although standard benefit-cost analyses have not typically included a separate analysis of regulation-induced employment impacts, we typically conduct

employment analyses. During the current economic recovery, employment impacts are of particular concern and questions may arise about their existence and magnitude.

Given the wide range of approaches that may be used to meet the requirements of the Clean Power Plan Final Rule, quantifying the associated employment impacts is difficult. The EPA's illustrative employment analysis includes an estimate of projected employment impacts associated with these guidelines for the utility power sector, coal and natural gas production, and demand-side energy efficiency activities. These projections are derived, in part, from the detailed model of the utility power sector used for this regulatory analysis, and U.S government data on employment and labor productivity.

In the electricity, coal, and natural gas sectors, the EPA estimates that these guidelines could result in a net decrease of approximately 25,000 job-years in 2025 for the final guidelines under the rate-based illustrative plan approach and approximately 26,000 job-years in 2025 under the mass-based approach. For 2030 the estimates of the net decrease in job-years is 30,900 under the rate-based plan, and 33,700 under the mass-based plan. The Agency is also offering an illustrative calculation of potential employment effects due to demand-side energy efficiency programs. Employment impacts from demand-side energy efficiency programs in 2030 could range from approximately 52,000 to 83,000 jobs under the final guidelines. More detail about these analyses can be found in Chapter 6 of this RIA.

ES.10 References

Bell, M.L., A. McDermott, S.L. Zeger, J.M. Sarnet, and F. Dominici. 2004. "Ozone and Short-Term Mortality in 95 U.S. Urban Communities, 1987-2000." *Journal of the American Medical Association*. 292(19):2372-8. Docket ID EPA-HQ-OAR-2009-0472-114577, Technical Support Document: Social Cost of Carbon for Regulatory Impact Analysis Under Executive Order 12866, Interagency Working Group on Social Cost of Carbon, with participation by the Council of Economic Advisers, Council on Environmental Quality, Department of Agriculture, Department of Commerce, Department of Energy, Department of Transportation, Environmental Protection Agency, National Economic Council, Office of Energy and Climate Change, Office of Management and Budget, Office of Science and Technology Policy, and Department of Treasury (February 2010). Available at: <<http://www.whitehouse.gov/sites/default/files/omb/inforeg/for-agencies/Social-Cost-of-Carbon-for-RIA.pdf>>.

Docket ID EPA-HQ-OAR-2013-0602, Technical Support Document: Technical Update of the Social Cost of Carbon for Regulatory Impact Analysis Under Executive Order 12866, Interagency Working Group on Social Cost of Carbon, with Participation by Council of Economic Advisers, Council on Environmental Quality, Department of Agriculture, Department of Commerce, Department of Energy, Department of Transportation, Domestic Policy Council, Environmental Protection Agency, National Economic Council, Office of Management and Budget, Office of Science and Technology Policy, and Department of Treasury (May 2013, Revised July 2015). Also available at: <<https://www.whitehouse.gov/sites/default/files/omb/inforeg/scc-tsd-final-july-2015.pdf>>. Accessed July 15, 2015.

Fann, N., K.R. Baker, and C.M. Fulcher. 2012. "Characterizing the PM_{2.5}-Related Health Benefits of Emission Reductions for 17 Industrial, Area and Mobile Emission Sectors Across the U.S." *Environment International*. 49:41–151.

Krewski D., M. Jerrett, R.T. Burnett, R. Ma, E. Hughes, Y. Shi, et al. 2009. Extended Follow-Up and Spatial Analysis of the American Cancer Society Study Linking Particulate Air Pollution and Mortality. HEI Research Report, 140, Health Effects Institute, Boston, MA.

Interagency Working Group on Social Cost of Carbon, with participation by Council of Economic Advisers, Council on Environmental Quality, Department of Agriculture, Department of Commerce, Department of Energy, Department of Transportation, Environmental Protection Agency, National Economic Council, Office of Management and Budget, Office of Science and Technology Policy, and Department of Treasury. *Response to Comments: Social Cost of Carbon for Regulatory Impact Analysis Under Executive Order 12866*. July 2015. Available at: <<https://www.whitehouse.gov/sites/default/files/omb/inforeg/scc-response-to-comments-final-july-2015.pdf>> Accessed July 15, 2015.

Intergovernmental Panel on Climate Change (IPCC). 2007. *Climate Change 2007: Synthesis Report Contribution of Working Groups I, II and III to the Fourth Assessment Report of the IPCC*. Available at: <http://www.ipcc.ch/publications_and_data/publications_ipcc_fourth_assessment_report_synthesis_report.htm>. Accessed June 6, 2015.

Lepeule, J., F. Laden, D. Dockery, and J. Schwartz. 2012. "Chronic Exposure to Fine Particles and Mortality: An Extended Follow-Up of the Harvard Six Cities Study from 1974 to 2009." *Environmental Health Perspectives*. 120(7):965-70.

- Levy, J.I., S.M. Chemerynski, and J.A. Sarnat. 2005. "Ozone Exposure and Mortality: An Empiric Bayes Metaregression Analysis." *Epidemiology*. 16(4):458-68.
- National Research Council (NRC). 2000. *Toxicological Effects of Methylmercury: Committee on the Toxicological Effects of Methylmercury.* Board on Environmental Studies and Toxicology. National Academies Press. Washington, DC.
- National Research Council (NRC). 2002. *Estimating the Public Health Benefits of Proposed Air Pollution Regulations.* National Academies Press. Washington, DC.
- U.S. Environmental Protection Agency (U.S. EPA). 2008a. *Integrated Science Assessment for Sulfur Oxides—Health Criteria (Final Report).* National Center for Environmental Assessment – RTP Division, Research Triangle Park, NC. September. Available at: <<http://cfpub.epa.gov/ncea/cfm/recordisplay.cfm?deid=198843>>. Accessed June 4, 2015.
- U.S. Environmental Protection Agency (U.S. EPA). 2008b. *Final Ozone NAAQS Regulatory Impact Analysis.* EPA-452/R-08-003. Office of Air Quality Planning and Standards Health and Environmental Impacts Division, Air Benefit and Cost Group Research Triangle Park, NC. March. Available at: <<http://www.epa.gov/ttnecas1/regdata/RIAs/6-ozoneriachapter6.pdf>>. Accessed June 4, 2015.
- U.S. EPA. 2008c. *Integrated Science Assessment for Oxides of Nitrogen: Health Criteria (Final Report).* Research Triangle Park, NC: National Center for Environmental Assessment. July. Available at <<http://cfpub.epa.gov/ncea/cfm/recordisplay.cfm?deid=194645>>.
- U.S. Environmental Protection Agency (U.S. EPA). 2008c. *Integrated Science Assessment for Oxides of Nitrogen - Health Criteria (Final Report).* National Center for Environmental Assessment, Research Triangle Park, NC. July. Available at: <<http://cfpub.epa.gov/ncea/cfm/recordisplay.cfm?deid=194645>>. Accessed June 4, 2015.
- U.S. Environmental Protection Agency (U.S. EPA). 2009b. *Integrated Science Assessment for Particulate Matter (Final Report).* EPA-600-R-08-139F. National Center for Environmental Assessment – RTP Division, Research Triangle Park, NC. December. Available at: <<http://cfpub.epa.gov/ncea/cfm/recordisplay.cfm?deid=216546>>. Accessed June 4, 2015.
- U.S. Environmental Protection Agency (U.S. EPA). 2010d. *Section 3: Re-analysis of the Benefits of Attaining Alternative Ozone Standards to Incorporate Current Methods.* Available at: <http://www.epa.gov/ttnecas1/regdata/RIAs/s3-supplemental_analysis-updated_benefits11-5.09.pdf>. Accessed June 4, 2015.

- U.S. Environmental Protection Agency (U.S. EPA). 2012a. *Regulatory Impact Analysis for the Final Revisions to the National Ambient Air Quality Standards for Particulate Matter*. EPA-452/R-12-003. Office of Air Quality Planning and Standards, Health and Environmental Impacts Division, Research Triangle Park, NC. December. Available at: <<http://www.epa.gov/ttnecas1/regdata/RIAs/finalria.pdf>>. Accessed June 4, 2015.
- U.S. Environmental Protection Agency (U.S. EPA). 2013b. *Integrated Science Assessment of Ozone and Related Photochemical Oxidants (Final Report)*. EPA/600/R-10/076F. National Center for Environmental Assessment – RTP Division, Research Triangle Park. Available at: <<http://cfpub.epa.gov/ncea/isa/recordisplay.cfm?deid=247492#Download>>. Accessed June 4, 2015.
- U.S. EPA. 2015. Technical Support Document (TSD) the Final Carbon Pollution Emission Guidelines for Existing Stationary Sources: Electric Utility Generating Units. CO₂ Emission Performance Rate and Goal Computation.
- Woodruff, T.J., J. Grillo, and K.C. Schoendorf. 1997. “The relationship between selected causes of postneonatal infant mortality and particulate air pollution in the United States.” *Environmental Health Perspectives*. 105(6): 608-612.

CHAPTER 1: INTRODUCTION AND BACKGROUND FOR THE CLEAN POWER PLAN

1.1 Introduction

This document presents estimates of potential benefits, costs, and economic impacts of illustrative approaches states may implement to comply with the Final Carbon Pollution Emission Guidelines for Existing Stationary Sources: Electric Utility Generating Units (herein referred to as “final emission guidelines” or the “Clean Power Plan Final Rule”). This chapter contains background information on these rules and an outline of the chapters in the report.

1.2 Legal, Scientific and Economic Basis for this Rulemaking

1.2.1 Statutory Requirement

Clean Air Act section 111, which Congress enacted as part of the 1970 Clean Air Act Amendments, establishes mechanisms for controlling emissions of air pollutants from stationary sources. This provision requires the EPA to promulgate a list of categories of stationary sources that the Administrator, in his or her judgment, finds “causes, or contributes significantly to, air pollution which may reasonably be anticipated to endanger public health or welfare.”¹³ The EPA has listed more than 60 stationary source categories under this provision.¹⁴ Once the EPA lists a source category, the EPA must, under CAA section 111(b)(1)(B), establish “standards of performance” for emissions of air pollutants from new sources in the source categories.¹⁵ These standards are known as new source performance standards (NSPS), and they are national requirements that apply directly to the sources subject to them.

When the EPA establishes NSPS for new sources in a particular source category, the EPA is also required, under CAA section 111(d)(1), to prescribe regulations for states to submit plans regulating existing sources in that source category for any air pollutant that, in general, is not regulated under the CAA section 109 requirements for the NAAQS or regulated under the CAA section 112 requirements for hazardous air pollutants (HAP). CAA section 111(d)’s mechanism for regulating existing sources differs from the one that CAA section 111(b) provides

¹³ CAA §111(b)(1)(A).

¹⁴ See 40 CFR 60 subparts Cb – OOOO.

¹⁵ CAA §111(b)(1)(B), 111(a)(1).

for new sources because CAA section 111(d) contemplates states submitting plans that establish “standards of performance” for the affected sources and that contain other measures to implement and enforce those standards.

“Standards of performance” are defined under CAA section 111(a)(1) as standards for emissions that reflect the emission limitation achievable from the “best system of emission reduction,” considering costs and other factors, that “the Administrator determines has been adequately demonstrated.” CAA section 111(d)(1) grants states the authority, in applying a standard of performance to a particular source, to take into account the source’s remaining useful life or other factors.

Under CAA section 111(d), a state must submit its plan to the EPA for approval, and the EPA must approve the state plan if it is “satisfactory.”¹⁶ If a state does not submit a plan, or if the EPA does not approve a state’s plan, then the EPA must establish a plan for that state.¹⁷ Once a state receives the EPA’s approval of its plan, the provisions in the plan become federally enforceable against the entity responsible for noncompliance, in the same manner as the provisions of an approved State Implementation Plan (SIP) under the Act.

1.2.2 Health and Welfare Impacts from Climate Change

According to the National Research Council, “Emissions of CO₂ from the burning of fossil fuels have ushered in a new epoch where human activities will largely determine the evolution of Earth’s climate. Because CO₂ in the atmosphere is long lived, it can effectively lock Earth and future generations into a range of impacts, some of which could become very severe. Therefore, emission reduction choices made today matter in determining impacts experienced not just over the next few decades, but in the coming centuries and millennia.”¹⁸

In 2009, based on a large body of robust and compelling scientific evidence, the EPA Administrator issued the Endangerment Finding under CAA section 202(a)(1).¹⁹ In the

¹⁶ CAA section 111(d)(2)(A).

¹⁷ CAA section 111(d)(2)(A).

¹⁸ National Research Council, *Climate Stabilization Targets*, p.3.

¹⁹ “Endangerment and Cause or Contribute Findings for Greenhouse Gases Under Section 202(a) of the Clean Air Act,” 74 Fed. Reg. 66,496 (Dec. 15, 2009) (“Endangerment Finding”).

Endangerment Finding, the Administrator found that the current, elevated concentrations of GHGs in the atmosphere—already at levels unprecedented in human history—may reasonably be anticipated to endanger public health and welfare of current and future generations in the United States.

Since the administrative record concerning the Endangerment Finding closed following the EPA’s 2010 Reconsideration Denial, the climate has continued to change, with new records being set for a number of climate indicators such as global average surface temperatures, Arctic sea ice retreat, CO₂ concentrations, and sea level rise. Additionally, a number of major scientific assessments have been released that improve understanding of the climate system and strengthen the case that GHGs endanger public health and welfare both for current and future generations. These assessments are from the Intergovernmental Panel on Climate Change (IPCC), the U.S. Global Change Research Program (USGCRP), and the National Research Council (NRC). These and other assessments are discussed in more detail in the preamble and in Chapter 4 of this Regulatory Impact Assessment (RIA).

1.2.3 Market Failure

Many regulations are promulgated to correct market failures, which otherwise lead to a suboptimal allocation of resources within the free market. Air quality and pollution control regulations address “negative externalities” whereby the market does not internalize the full opportunity cost of production borne by society as public goods such as air quality are unpriced.

GHG emissions impose costs on society, such as negative health and welfare impacts, that are not reflected in the market price of the goods produced through the polluting process. For this regulatory action the good produced is electricity. If a fossil fuel-fired electricity producer pollutes the atmosphere when it generates electricity, this cost will be borne not by the polluting firm but by society as a whole, thus imposing a negative externality. The equilibrium market price of electricity may fail to incorporate the full opportunity cost to society of generating electricity. All else equal, given this externality, the composition of EGUs used to generate electricity in a free market will not be socially optimal, and the quantity of electricity generated may not be at the socially optimal level. Fossil fuel-fired EGUs may produce more electricity than would occur if they had to account for the cost associated with this negative externality. Consequently, absent a regulation on emissions, the composition of the fleet of

EGUs used to generate electricity may not be socially optimal, and the marginal social cost of the last unit of electricity produced may exceed its marginal social benefit. This regulation will work towards addressing this market failure by causing affected EGUs to begin to internalize the negative externality associated with CO₂ emissions.

1.3 Summary of Regulatory Analysis

In accordance with Executive Order 12866, Executive Order 13563, OMB Circular A-4, and the EPA’s “Guidelines for Preparing Economic Analyses,” the EPA prepared this RIA for this “significant regulatory action.” This action is an economically significant regulatory action because it is expected to have an annual effect on the economy of \$100 million or more or adversely affect in a material way the economy, a sector of the economy, productivity, competition, jobs, the environment, public health or safety, or state, local, or tribal governments or communities.²⁰

This RIA addresses the potential costs, emission reductions, and benefits of the final emission guidelines that are the focus of this action. Additionally, this RIA includes information about potential impacts on electricity markets, employment, and markets outside the electricity sector.

In evaluating the impacts of the final guidelines, we analyzed a number of uncertainties. For example, the analysis includes an evaluation of two illustrative plan approaches that states and affected EGUs may take to accomplish state emission performance goals, a rate-based and a mass-based approach. The RIA also examines key uncertainties in the estimated benefits of reducing carbon dioxide and other air pollutants. For a further discussion of key evaluations of uncertainty in the regulatory analyses for this rulemaking, see Chapter 8 of this RIA.

1.4 Background for the Final Emission Guidelines

1.4.1 Base Case and Years of Analysis

The rule analyzed in this RIA finalizes emission guidelines for states to limit CO₂ emissions from certain existing EGUs. The base case for this analysis, which uses the Integrated

²⁰ The analysis in this RIA and the RIA that accompanied the proposal together constitute the economic assessment required by CAA section 317. In the EPA’s judgment, the assessment is as extensive as practicable taking into account the EPA’s time, resources, and other duties and authorities.

Planning Model (IPM), includes state rules that have been finalized and/or approved by a state's legislature or environmental agencies, as well as final federal rules. The IPM Base Case v.5.15 includes the Cross-State Air Pollution Rule (CSAPR), the Mercury and Air Toxics Rule (MATS), the proposed Carbon Pollution Standards for New Power Plants, the Cooling Water Intakes (316(b)) Rule, the Combustion Residuals from Electric Utilities (CCR), and other state and Federal regulations to the extent that they contain measures, permits, or other air-related limitations or requirements. Additional legally binding and enforceable commitments for GHG reductions considered in the base case are discussed in the documentation for IPM.²¹

Costs and benefits are presented for illustrative plan approaches for the analysis years of 2020, 2025, and 2030. These years were selected because they represent initial build up, interim, and full implementation years for the two illustrative approaches analyzed. Analyses of energy, economic, and employment impacts are presented for illustrative plan approaches in 2020, 2025, and 2030. All dollar estimates are presented in 2011 dollars.

1.4.2 Definition of Affected Sources

For the emission guidelines, an affected EGU is any fossil fuel-fired electric utility steam generating unit or stationary combustion turbine that was in operation or had commenced construction as of January 8, 2014,²² and that meets the following criteria, which differ depending on the type of unit. To be an affected source, such a unit, if it is a steam generating unit or integrated gasification combined cycle (IGCC), must serve a generator capable of selling greater than 25 MW to a utility power distribution system and have a base load rating greater than 260 GJ/h (250 MMBtu/h) heat input of fossil fuel (either alone or in combination with any other fuel). If such a unit is a stationary combustion turbine, the unit must meet the definition of a combined cycle or combined heat and power combustion turbine, serve a generator capable of selling greater than 25 MW to a utility power distribution system, and have a base load rating of greater than 260 GJ/h (250 MMBtu/h). Certain EGUs are exempt from inclusion in a state plan. For specifics on these criteria see section IV of the preamble.

²¹ Detailed documentation for IPM v.5.15 is available at: <http://www.epa.gov/powersectormodeling>

²² Under Section 111(a) of the CAA, determination of affected sources is based on the date that the EPA proposes action on such sources. January 8, 2014 is the date the proposed GHG standards of performance for new fossil fuel-fired EGUs were published in the *Federal Register* (79 FR 1430).

When considering and understanding applicability, the following definitions may be helpful. Simple cycle combustion turbine means any stationary combustion turbine which does not recover heat from the combustion turbine engine exhaust gases for purposes other than enhancing the performance of the stationary combustion turbine itself. Combined cycle combustion turbine means any stationary combustion turbine which recovers heat from the combustion turbine engine exhaust gases to generate steam that is used to create additional electric power output in a steam turbine. Combined heat and power (CHP) combustion turbine means any stationary combustion turbine which recovers heat from the combustion turbine engine exhaust gases to heat water or another medium, generate steam for useful purposes other than exclusively for additional electric generation, or directly uses the heat in the exhaust gases for a useful purpose.

1.4.3 Regulated Pollutant

The purpose of this CAA section 111(d) rule is to address CO₂ emissions from fossil fuel-fired power plants in the U.S. because they are the largest domestic stationary source of emissions of carbon dioxide (CO₂), the most prevalent of the greenhouse gases (GHG), which are air pollutants that the EPA has determined endangers public health and welfare through their contribution to climate change. This rule establishes for the first time federal emission guidelines for existing power plants that will lead to significant reductions in CO₂ emissions.

1.4.4 Emission Guidelines

In this action, the Environmental Protection Agency (EPA) is establishing final emission guidelines for states to follow in developing plans to reduce greenhouse gas emissions from existing fossil fuel-fired EGUs. Specifically, the EPA is establishing: 1) CO₂ emission performance rates representing the best system of emission reduction (BSER) for two subcategories of existing fossil fuel-fired EGUs – fossil fuel-fired electric utility steam generating units and stationary combustion turbines, 2) state-specific CO₂ goals reflecting the CO₂ emission performance rates, and 3) guidelines for the development, submittal and implementation of state plans that establish emission standards or other measures to implement the CO₂ emission performance rates, which may be accomplished by meeting the state goals

1.4.5 State Plans

After the EPA establishes the emission guidelines that set forth the BSER, each state²³ shall then develop, adopt and submit a state plan under CAA section 111(d) that establishes standards of performance for the affected EGUs in its jurisdiction in order to implement the BSER. The final guidelines include three approaches that states may adopt for purposes of implementing the BSER, any one of which a state may use in its plan. These are: 1) establishing standards of performance that apply the subcategory specific CO₂ emission performance rates to their affected EGUs, 2) adopting a combination of standards and/or other measures that achieve state-specific rate-based goals that represent the weighted aggregate of the CO₂ emission performance rates applied to the affected EGUs in each state, and 3) adopting a program to meet mass-based CO₂ emission goals that represent the equivalent of the rate-based goal for each state. These alternatives, as well as the other options we are finalizing, ensure that both states and affected EGUs enjoy the maximum flexibility and latitude in meeting the requirements of the emission guidelines and that the BSER is fully implemented by each state.

1.5 Organization of the Regulatory Impact Analysis

This report presents the EPA's analysis of the potential benefits, costs, and other economic effects of the final emission guidelines to fulfill the requirements of an RIA. This RIA includes the following chapters:

- Chapter 2, Electric Power Sector Industry Profile
- Chapter 3, Cost, Emissions, Economic, and Energy Impacts
- Chapter 4, Estimated Climate Benefits and Health Co-benefits
- Chapter 5, Economic Impacts – Markets Outside the Electricity Sector
- Chapter 6, Employment Impact Analysis
- Chapter 7, Statutory and Executive Order Analyses
- Chapter 8, Comparison of Benefits and Costs

²³ In this section, the term "state" encompasses the 48 contiguous states and the District of Columbia, and any Indian tribe that has been approved by the EPA pursuant to 40 CFR 49.9 as eligible to develop and implement a CAA section 111(d) plan.

1.6 References

- 40 CFR Chapter I [EPA–HQ–OAR–2009–0171; FRL–9091–8] RIN 2060–ZA14, “Endangerment and Cause or Contribute Findings for Greenhouse Gases under Section 202(a) of the Clean Air Act,” Federal Register / Vol. 74, No. 239 / Tuesday, December 15, 2009 / Rules and Regulations.
- 75 FR 49556. August 13, 2010. “EPA’s Denial of the Petitions to Reconsider the Endangerment and Cause or Contribute Findings for Greenhouse Gases Under Section 202(a) of the Clean Air Act.”
- Melillo, J.M., T.C. Richmond, and G.W. Yohe, Eds., 2014: *Climate Change Impacts in the United States: The Third National Climate Assessment*. U.S. Global Change Research Program. Available at <<http://nca2014.globalchange.gov>>. Accessed June 4, 2015.
- National Research Council. *Climate Stabilization Targets: Emissions, Concentrations, and Impacts over Decades to Millennia*. Washington, DC: The National Academies Press, 2011.
- U.S. Environmental Protection Agency. *EPA’s Power Sector Modeling Platform v.5.14*. March 25, 2015. Available online at <<http://www.epa.gov/powersectormodeling/psmodel514.html>>. Accessed June 4, 2015.

CHAPTER 2: ELECTRIC POWER SECTOR INDUSTRY PROFILE

2.1 Introduction

This chapter discusses important aspects of the power sector that relate to the Final Carbon Pollution Emission Guidelines for Existing Stationary Sources: Electric Utility Generating Units, including the types of power-sector sources affected by the regulation, and provides background on the power sector and EGUs. In addition, this chapter provides some historical background on trends in the past decade in the power sector, as well as about existing EPA regulation of the power sector.

In the past decade there have been significant structural changes in the both the mix of generating capacity and in the share of electricity generation supplied by different types of generation. These changes are the result of multiple factors in the power sector, including normal replacements of older generating units with new units, changes in the electricity intensity of the US economy, growth and regional changes in the US population, technological improvements in electricity generation from both existing and new units, changes in the prices and availability of different fuels, and substantial growth in electricity generation by renewable and unconventional methods. Many of these trends will continue to contribute to the evolution of the power sector. The evolving economics of the power sector, in particular the increased natural gas supply and subsequent relatively low natural gas prices, have resulted in more gas being utilized as base load energy in addition to supplying electricity during peak load. This chapter presents data on the evolution of the power sector from 2002 through 2012. Projections of new capacity and the impact of this rule on these new sources are discussed in more detail in Chapter 4 of this RIA.

2.2 Power Sector Overview

The production and delivery of electricity to customers consists of three distinct segments: generation, transmission, and distribution.

2.2.1 Generation

Electricity generation is the first process in the delivery of electricity to consumers. There are two important aspects of electricity generation; capacity and net generation. Generating Capacity refers to the maximum amount of production from an EGU in a typical hour, typically

measured in megawatts (MW) or gigawatts (1 GW = 1000 MW). Electricity Generation refers to the amount of electricity actually produced by EGUs, measured in kilowatt-hours (kWh) or gigawatt-hours (GWh = 1 million kWh). Net generation is the amount of electricity that is available to the grid from the EGU (i.e., excluding the amount of electricity generated but used within the generating station for operations). In addition to producing electricity for sale to the grid, generators perform other services important to reliable electricity supply, such as providing backup generating capacity in the event of unexpected changes in demand or unexpected changes in the availability of other generators. Other important services provided by generators include facilitating the regulation of the voltage of supplied generation.

Individual EGUs are not used to generate electricity 100 percent of the time. Individual EGUs are periodically not needed to meet the regular daily and seasonal fluctuations of electricity demand. Furthermore, EGUs relying on renewable resources such as wind, sunlight and surface water to generate electricity are routinely constrained by the availability of adequate wind, sunlight or water at different times of the day and season. Units are also unavailable during routine and unanticipated outages for maintenance. These factors result in the mix of generating capacity types available (e.g., the share of capacity of each type of EGU) being substantially different than the mix of the share of total electricity produced by each type of EGU in a given season or year.

Most of the existing capacity generates electricity by creating heat to create high pressure steam that is released to rotate turbines which, in turn, create electricity. Natural gas combined cycle (NGCC) units have two generating components operating from a single source of heat. The first cycle is a gas-fired turbine, which generates electricity directly from the heat of burning natural gas. The second cycle reuses the waste heat from the first cycle to generate steam, which is then used to generate electricity from a steam turbine. Other EGUs generate electricity by using water or wind to rotate turbines, and a variety of other methods including direct photovoltaic generation also make up a small, but growing, share of the overall electricity supply. The generating capacity includes fossil-fuel-fired units, nuclear units, and hydroelectric and other renewable sources (see Table 2-1). Table 2-1 also shows the comparison between the generating capacity in 2002 and 2012.

In 2012 the power sector consisted of over 19,000 generating units with a total capacity²⁴ of 1,168 GW, an increase of 188 GW (or 19 percent) from the capacity in 2002 (980 GW). The 188 GW increase consisted primarily of natural gas fired EGUs (134 GW) and wind generators (55 GW), with substantially smaller net increases and decreases in other types of generating units.

Table 2-1. Existing Electricity Generating Capacity by Energy Source, 2002 and 2012

Energy Source	2002		2012		Change Between '02 and '12		
	Generator Nameplate Capacity (MW)	% Total Capacity	Generator Nameplate Capacity (MW)	% Total Capacity	% Increase	Nameplate Capacity Change (MW)	% of Total Capacity Increase
Coal	338,199	35%	336,341	29%	-1%	-1,858	-1%
Natural Gas ¹	352,128	36%	485,957	42%	38%	133,829	71%
Nuclear	104,933	11%	107,938	9%	3%	3,005	2%
Hydro	96,344	10%	99,099	8%	3%	2,755	1%
Petroleum	66,219	7%	53,789	5%	-19%	-12,430	-7%
Wind	4,531	0.5%	59,629	5.1%	1216%	55,098	29%
Other Renewable	14,208	1.5%	20,986	1.8%	47.7%	6,778	3.6%
Misc	3,023	0.3%	4,257	0.4%	40.8%	1,234	0.7%
Total	979,585	100%	1,167,995	100%	19%	188,410	100%

Note: This table presents generation capacity. Actual net generation is presented in Table 2-2.
Source: U.S. EIA. Downloaded from EIA Electricity Data Browser, Electric Power Plants Generating Capacity By energy source, by producer, by state back to 2000 (annual data from EIA Form 860). Available online at: <<http://www.eia.gov/electricity/data.cfm#gencapacity>> Accessed 12/19/2014

¹ Natural Gas information in this chapter (unless otherwise stated) reflects data for all generating units using natural gas as the primary fossil heat source. This includes Combined Cycle Combustion Turbine (31 percent of 2012 natural gas-fired capacity), Gas Turbine (30 percent), Combined Cycle Steam (19 percent), Steam Turbine (17 percent), and miscellaneous (< 1 percent).

²⁴ As with all data presented in this section, this includes generating capacity not only at EGUs primarily operated to supply electricity to the grid, but also generating capacity at commercial and industrial facilities that produce both electricity used onsite as well as dispatched to the grid. Unless otherwise indicated, capacity data presented in this RIA is installed nameplate capacity (also known as nominal capacity), defined by EIA as “The maximum rated output of a generator, prime mover, or other electric power production equipment under specific conditions designated by the manufacturer.” Nameplate capacity is consistently reported to regulatory authorities with a common definition, where alternate measures of capacity (e.g., net summer capacity and net winter capacity) can use a variety of definitions and specified conditions.

The 19 percent increase in generating capacity is the net impact of newly built generating units, retirements of generating units, and a variety of increases and decreases to the nameplate capacity of individual existing units due to changes in operating equipment, changes in emission controls, etc. During the period 2002 to 2012, a total of 315,752 MW of new generating capacity was built and brought online, and 64,763 MW existing units were retired. The net effect of the re-rating of existing units reduced the total capacity by 62,579 MW. The overall net change in capacity was 188,410 MW, as shown in Table 2-1.

The newly built generating capacity was primarily natural gas (226,605 MW), which was partially offset by gas retirements (29,859 MW). Wind capacity was the second largest type of new builds (55,583 MW), augmented by 2,807 MW of solar.²⁵ The overall mix of newly built and retired capacity, along with the net effect, is shown on Figure 2-1.

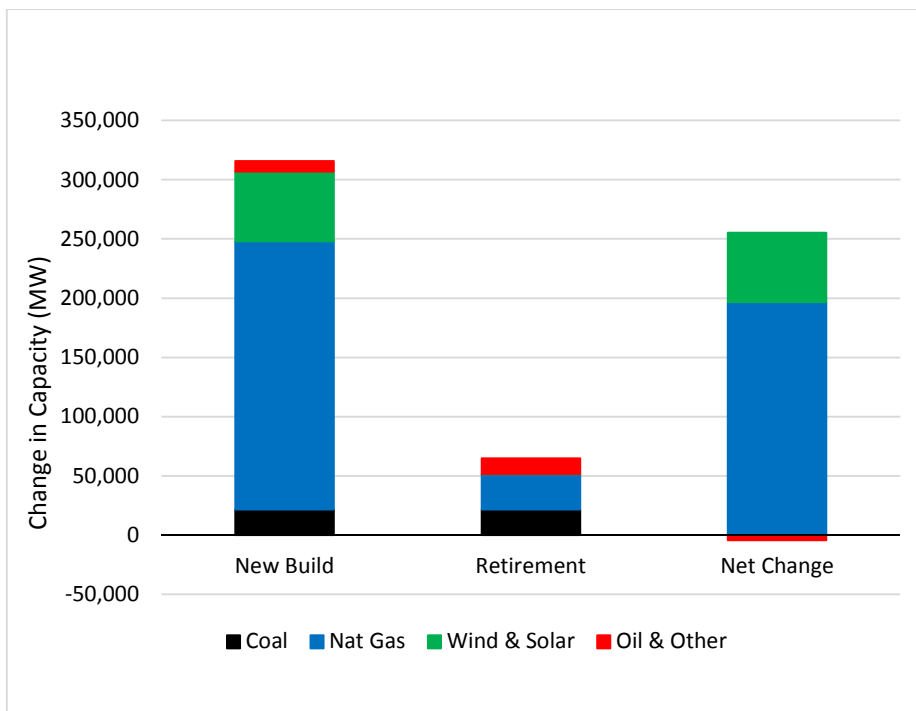

Figure 2-1. New Build and Retired Capacity (MW) by Fuel Type, 2002-2012

Source: EIA Form 860

Not displayed: wind and solar retirements = 87 MW, net change in coal capacity = -56 MW

²⁵ Partially offset by 87 MW retired older wind or solar capacity.

In 2012, electric generating sources produced a net 4,058 trillion kWh to meet electricity demand, a 5 percent increase from 2002 (3,858 trillion kWh). As presented in Table 2-2, almost 70 percent of electricity in 2012 was produced through the combustion of fossil fuels, primarily coal and natural gas, with coal accounting for the largest single share. Although the share of the total generation from fossil fuels in 2012 (67 percent) was only modestly smaller than the total fossil share in 2002 (71 percent), the mix of fossil fuel generation changed substantially during that period. Coal generation declined by 18 percent and petroleum generation by 72 percent, while natural gas generation increased by 60 percent. This reflects both the increase in natural gas capacity during that period as well as an increase in the utilization of new and existing gas EGUs during that period. Wind generation also grew from a very small portion of the overall total in 2002 to 4.1 percent of the 2012 total.

Table 2-2. Net Generation in 2002 and 2013 (Trillion kWh = TWh)

	2002		2013		Change Between '02 and '13	
	Net Generation (TWh)	Fuel Source Share	Net Generation (TWh)	Fuel Source Share	Net Generation Change (TWh)	% Change in Net Generation
Coal	1,933.1	50%	1,514.0	37%	-419.1	-21.7%
Natural Gas	702.5	18%	1,237.8	31%	535.3	76.2%
Nuclear	780.1	20%	769.3	19%	-10.7	-1.4%
Hydro	255.6	7%	271.3	7%	15.7	6.1%
Petroleum	94.6	2.5%	23.2	0.6%	-71.4	-75.5%
Wind	10.4	0.3%	140.8	3.5%	130.5	1260.0%
Other Renewable	68.8	1.8%	77.5	1.9%	8.8	12.7%
Misc	13.5	0.4%	12.4	0.3%	-1.2	-8.7%
Total	3,858	100%	4,046	100%	188	5%

Source: U.S. EIA Monthly Energy Review, December 2014. Table 7.2a Electricity Net Generation: Total (All Sectors). Available online at: <<http://www.eia.gov/totalenergy/data/monthly/>>. Accessed 12/19/2014

Coal-fired and nuclear generating units have historically supplied “base load” electricity, the portion of electricity loads which are continually present, and typically operate throughout all hours of the year. The coal units meet the part of demand that is relatively constant. Although much of the coal fleet operates as base load, there can be notable differences across various facilities (see Table 2-3). For example, coal-fired units less than 100 megawatts (MW) in size

compose 37 percent of the total number of coal-fired units, but only 6 percent of total coal-fired capacity. Gas-fired generation is better able to vary output and is the primary option used to meet the variable portion of the electricity load and has historically supplied “peak” and “intermediate” power, when there is increased demand for electricity (for example, when businesses operate throughout the day or when people return home from work and run appliances and heating/air-conditioning), versus late at night or very early in the morning, when demand for electricity is reduced.

Table 2-3 also shows comparable data for the capacity and age distribution of natural gas units. Compared with the fleet of coal EGUs, the natural gas fleet of EGUs is generally smaller and newer. While 55 percent of the coal EGU fleet is over 500 MW per unit, 77 percent of the gas fleet is between 50 and 500 MW per unit. Many of the largest gas units are gas-fired steam-generating EGUs.

Table 2-3. Coal and Natural Gas Generating Units, by Size, Age, Capacity, and Thermal Efficiency (Heat Rate)

Unit Size Grouping (MW)	No. Units	% of All Units	Avg. Age	Avg. Net Summer Capacity (MW)	Total Net Summer Capacity (MW)	% Total Capacity	Avg. Heat Rate (Btu/kWh)
COAL							
0 – 24	223	18%	40.7	11.4	2,538	1%	11,733
25 – 49	108	9%	44.2	36.7	3,963	1%	11,990
50 – 99	157	12%	49.0	74.1	11,627	4%	11,883
100 - 149	128	10%	50.6	122.7	15,710	5%	10,971
150 - 249	181	14%	48.7	190.4	34,454	11%	10,620
250 - 499	205	16%	38.4	356.2	73,030	23%	10,502
500 - 749	187	15%	35.4	604.6	113,056	36%	10,231
750 - 999	57	5%	31.4	823.9	46,963	15%	9,942
1000 - 1500	11	1%	35.7	1259.1	13,850	4%	9,732
Total Coal	1257	100%	42.6	250.7	315,191	100%	11,013
NATURAL GAS							
0 – 24	1992	37%	37.6	7.0	13,863	3%	13,531
25 – 49	410	8%	21.8	125.0	51,247	12%	9,690
50 – 99	962	18%	15.6	174.2	167,536	39%	8,489
100 - 149	802	15%	23.4	39.9	31,982	8%	11,765
150 - 249	167	3%	28.7	342.4	57,179	13%	9,311
250 - 499	982	18%	24.6	71.1	69,788	16%	12,083
500 - 749	37	1%	40.0	588.8	21,785	5%	11,569
750 - 1000	14	0.3%	35.9	820.9	11,492	3%	10,478
Total Gas	5366	100%	27.7	79.2	424,872	100%	11,652

Source: National Electric Energy Data System (NEEDS) v.5.14

Note: The average heat rate reported is the mean of the heat rate of the units in each size category (as opposed to a generation-weighted or capacity-weighted average heat rate.) A lower heat rate indicates a higher level of fuel efficiency. Table is limited to coal-steam units in operation in 2013 or earlier, and excludes those units in NEEDS with planned retirements in 2014 or 2015.

In terms of the age of the generating units, 50 percent of the total coal generating capacity has been in service for more than 38 years, while 50 percent of the natural gas capacity has been in service less than 15 years. Figure 2-2 presents the cumulative age distributions of the coal and gas fleets, highlighting the pronounced differences in the ages of the fleets of these two types of fossil-fuel generating capacity. Figure 2-2 also includes the distribution of generation.

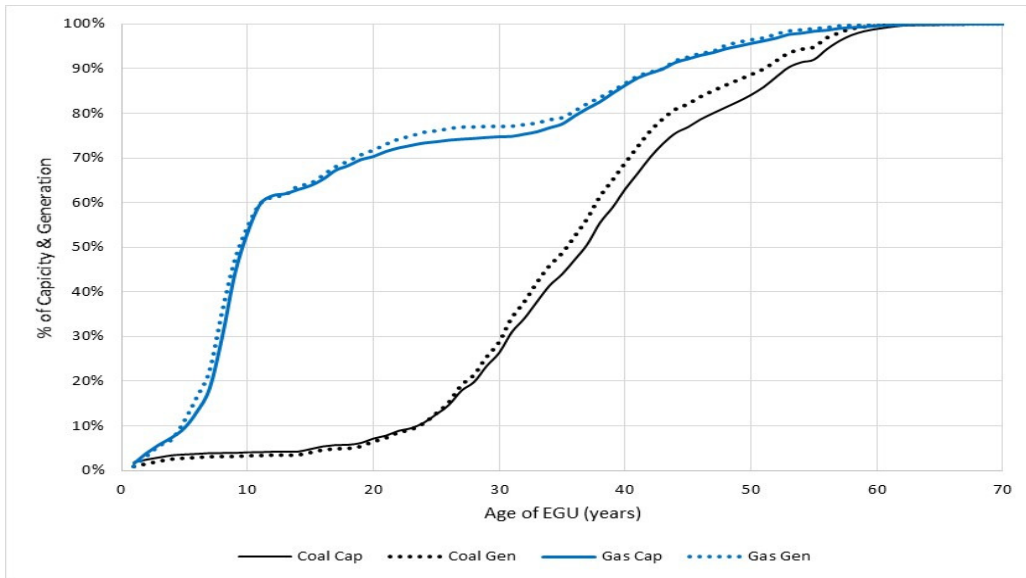

Figure 2-2. Cumulative Distribution in 2010 of Coal and Natural Gas Electricity Capacity and Generation, by Age

Source: National Electric Energy Data System (NEEDS) v.5.13

Not displayed: coal units (376 MW total, 1 percent of total) and gas units (62 MW, < .01 percent of total) over 70 years old for clarity. Figure is limited to coal-steam units in NEEDS v5.13 in operation in 2013 or earlier (excludes ~2,100 MW of coal-fired IGCC and fossil waste capacity), and excludes those units in NEEDS with planned retirements in 2014 or 2015.

The locations of existing fossil units in EPA’s National Electric Energy Data System (NEEDS) v.5.13 are shown in Figure 2-3.

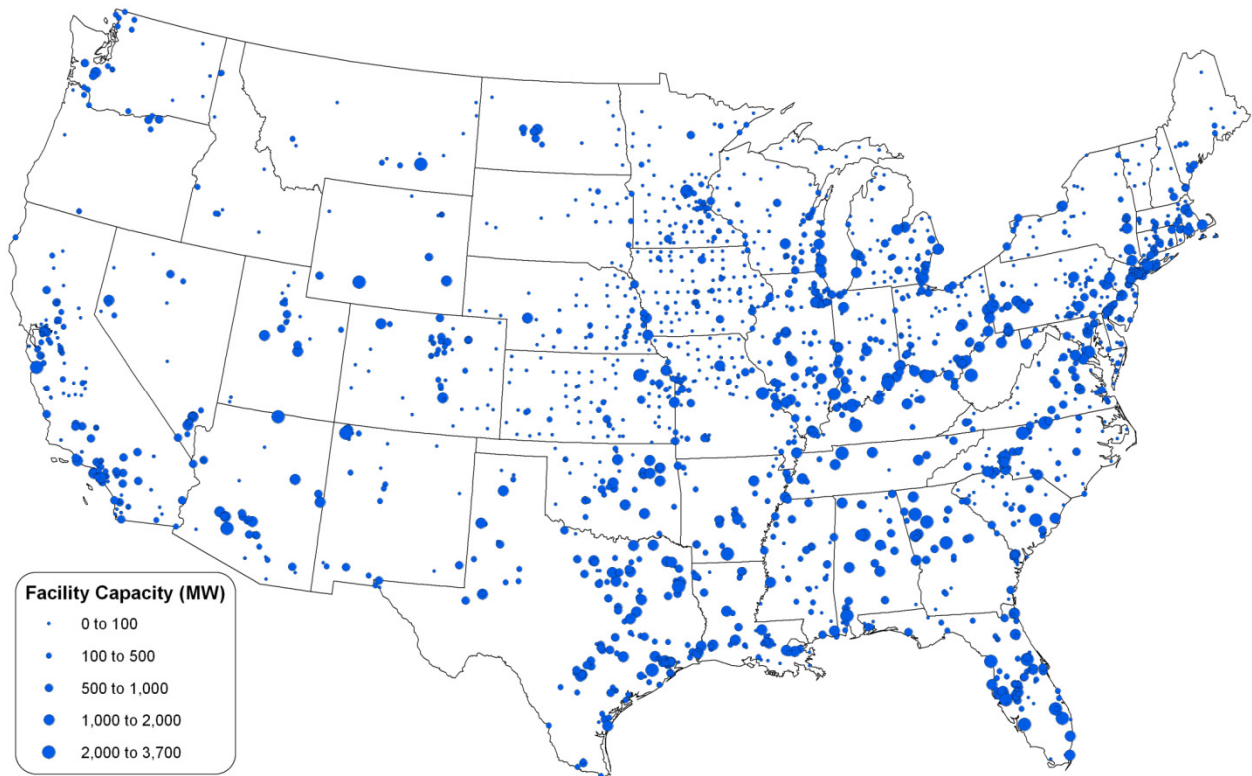

Figure 2-3. Fossil Fuel-Fired Electricity Generating Facilities, by Size

Source: National Electric Energy Data System (NEEDS) v.5.13

Note: This map displays fossil capacity at facilities in the NEEDS v.5.13 IPM frame. NEEDS v.5.13 reflects generating capacity expected to be on-line at the end of 2015. This includes planned new builds already under construction and planned retirements. In areas with a dense concentration of facilities, some facilities may be obscured.

2.2.2 Transmission

Transmission is the term used to describe the bulk transfer of electricity over a network of high voltage lines, from electric generators to substations where power is stepped down for local distribution. In the U.S. and Canada, there are three separate interconnected networks of high voltage transmission lines,²⁶ each operating synchronously. Within each of these transmission

²⁶ These three network interconnections are the Western Interconnection, comprising the western parts of both the US and Canada (approximately the area to the west of the Rocky Mountains), the Eastern Interconnection, comprising the eastern parts of both the US and Canada (except those part of eastern Canada that are in the Quebec Interconnection), and the Texas Interconnection (which encompasses the portion of the Texas electricity system commonly known as the Electric Reliability Council of Texas (ERCOT)). See map of all NERC interconnections at http://www.nerc.com/AboutNERC/keyplayers/Documents/NERC_Interconnections_Color_072512.jpg

networks, there are multiple areas where the operation of power plants is monitored and controlled by regional organizations to ensure that electricity generation and load are kept in balance. In some areas, the operation of the transmission system is under the control of a single regional operator²⁷; in others, individual utilities²⁸ coordinate the operations of their generation, transmission, and distribution systems to balance the system across their respective service territories.

2.2.3 Distribution

Distribution of electricity involves networks of lower voltage lines and substations that take the higher voltage power from the transmission system and step it down to lower voltage levels to match the needs of customers. The transmission and distribution system is the classic example of a natural monopoly, in part because it is not practical to have more than one set of lines running from the electricity generating sources to substations or from substations to residences and businesses.

Over the last few decades, several jurisdictions in the United States began restructuring the power industry to separate transmission and distribution from generation, ownership, and operation. Historically, the transmission system had been developed by vertically integrated utilities, establishing much of the existing transmission infrastructure. However, as parts of the country have restructured the industry, transmission infrastructure has also been developed by transmission utilities, electric cooperatives, and merchant transmission companies, among others. Distribution, also historically developed by vertically integrated utilities, is now often managed by a number of utilities that purchase and sell electricity, but do not generate it. As discussed below, electricity restructuring has focused primarily on efforts to reorganize the industry to encourage competition in the generation segment of the industry, including ensuring open access of generation to the transmission and distribution services needed to deliver power to consumers. In many states, such efforts have also included separating generation assets from transmission

²⁷ E.g., PMJ Interconnection, LLC, Western Area Power Administration (which comprises 4 sub-regions).

²⁸ E.g., Los Angeles Department of Power and Water, Florida Power and Light.

and distribution assets to form distinct economic entities. Transmission and distribution remain price-regulated throughout the country based on the cost of service.

2.3 Sales, Expenses and Prices

These electric generating sources provide electricity for commercial, industrial and residential ultimate customers. Each of the three major ultimate categories consume roughly a quarter to a third of the total electricity produced²⁹ (see Table 2-4). Some of these uses are highly variable, such as heating and air conditioning in residential and commercial buildings, while others are relatively constant, such as industrial processes that operate 24 hours a day. The distribution between the end use categories changed very little between 2002 and 2012.

Table 2-4. Total U.S. Electric Power Industry Retail Sales in 2012 (billion kWh)

		2002		2012	
		Sales/Direct Use (Billion kWh)	Share of Total End Use	Sales/Direct Use (Billion kWh)	Share of Total End Use
Sales	Residential	1,265	35%	1,375	35.9%
	Commercial	1,104	30%	1,327	34.6%
	Industrial	990	27%	986	25.7%
	Transportation	NA		7	0.2%
	Other	106	3%	NA	
Total		3,465	95%	3,695	96%
Direct Use		166	5%	138	4%
Total End Use		3,632	100%	3,832	100%

Source: Table 2.2, EIA Electric Power Annual, 2013

Notes: Retail sales are not equal to net generation (Table 2-2) because net generation includes net exported electricity and loss of electricity that occurs through transmission and distribution.

Direct Use represents commercial and industrial facility use of onsite net electricity generation; and electricity sales or transfers to adjacent or co-located facilities for which revenue information is not available.

2.3.1 Electricity Prices

Electricity prices vary substantially across the United States, differing both between the ultimate customer categories and also by state and region of the country. Electricity prices are typically highest for residential and commercial customers because of the relatively high costs of

²⁹ Transportation (primarily urban and regional electrical trains) is a fourth ultimate customer category which accounts less than one percent of electricity consumption.

distributing electricity to individual homes and commercial establishments. The high prices for residential and commercial customers are the result both of the necessary extensive distribution network reaching to virtually every part of the country and every building, and also the fact that generating stations are increasingly located relatively far from population centers (which increases transmission costs). Industrial customers generally pay the lowest average prices, reflecting both their proximity to generating stations and the fact that industrial customers receive electricity at higher voltages (which makes transmission more efficient and less expensive). Industrial customers frequently pay variable prices for electricity, varying by the season and time of day, while residential and commercial prices historically have been less variable. Overall industrial customer prices are usually considerably closer to the wholesale marginal cost of generating electricity than residential and commercial prices.

On a state-by-state basis, all retail electricity prices vary considerably. In 2011 the national average retail electricity price (all sectors) was 9.90 cents/KWh, with a range from 6.44 cents (Idaho) to 31.59 (Hawaii). The Northeast, California and Alaska have average retail prices that can be as much as double those of other states (see Figure 2-4), and Hawaii has the most expensive retail price of electricity in the country.

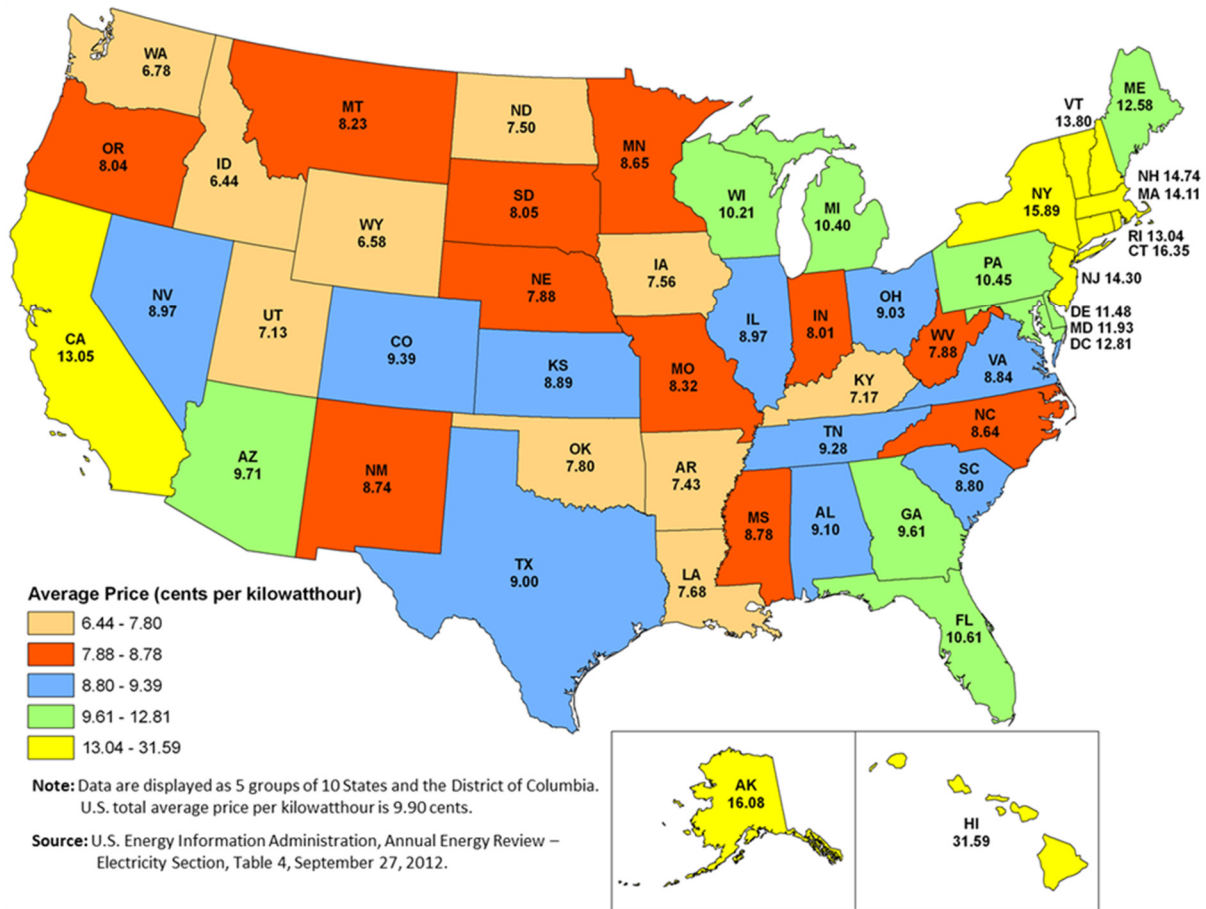

Figure 2-4. Average Retail Electricity Price by State (cents/kWh), 2011

Average national overall retail electricity prices increased between 2002 and 2012 by 36.7 percent in nominal (current year \$) terms. The amount of increase differed for the three major end use categories (residential, commercial and industrial). National average residential prices increased the most (40.8 percent), and commercial prices increased the least (27.9 percent). The nominal year prices for 2002 through 2012 are shown in Figure 2-5.

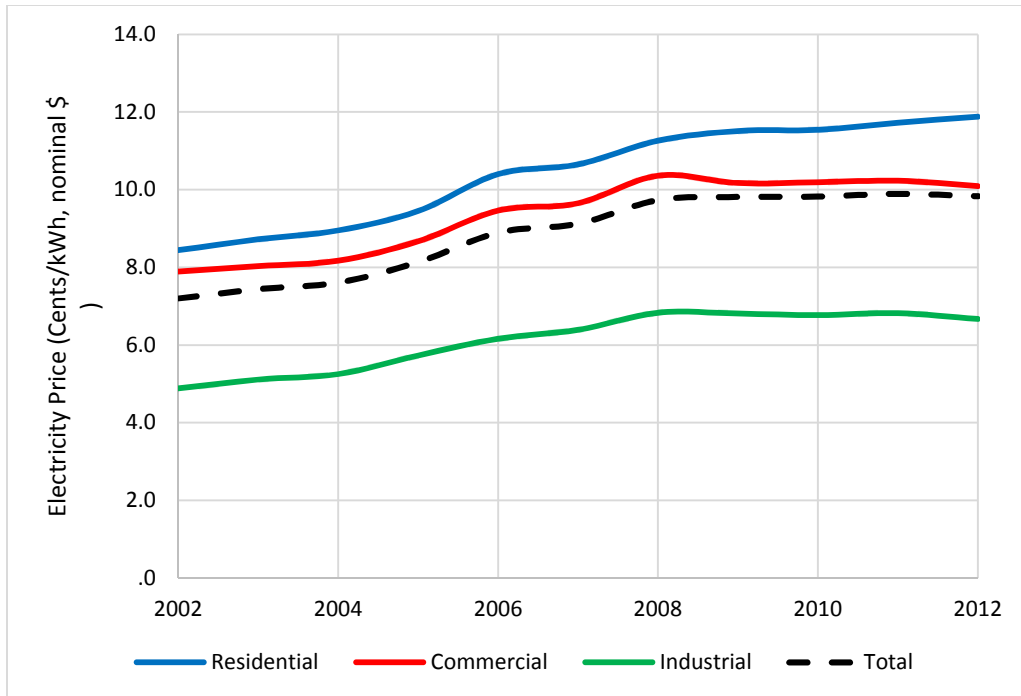

Figure 2-5. Nominal National Average Electricity Prices for Three Major End-Use Categories

Source: EIA AEO 2012, Table 2.4

Electricity prices for all three end-use categories increased more than overall inflation through this period, measured by either the GDP implicit price deflator (23.5 percent) or the consumer price index (CPI-U, which increased by 27.7 percent)³⁰. Most of these electricity price increases occurred between 2002 and 2008; since 2008 nominal electricity prices have been relatively stable while overall inflation continued to increase. The increase in nominal electricity prices for the major end use categories, as well as increases in the GDP price and CPI-U indices for comparison, are shown in Figure 2-6.

³⁰ Source: Federal Reserve Economic Data, FRB St. Louis. Available online at: <http://research.stlouisfed.org/fred2/>.

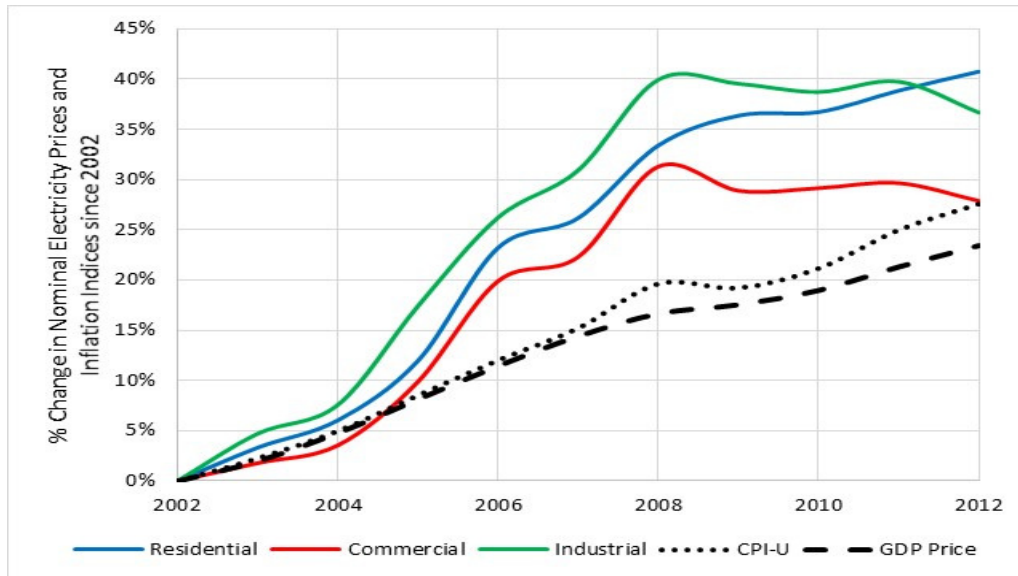

Figure 2-6. Relative Increases in Nominal National Average Electricity Prices for Major End-Use Categories, With Inflation Indices

The real (inflation-adjusted) change in average national electricity prices can be calculated using the GDP implicit price deflator. Figure 2-7 shows real³¹ (2011\$) electricity prices for the three major customer categories from 1960 to 2012, and Figure 2-8 shows the relative change in real electricity prices relative to the prices in 1960. As can be seen in the figures, the price for industrial customers has always been lower than for either residential or commercial customers, but the industrial price has been more volatile. While the industrial real price of electricity in 2012 was relatively unchanged from 1960, residential and commercial real prices are 23 percent and 28 percent lower respectively than in 1960.

³¹ All prices in this section are estimated as real 2011 prices adjusted using the GDP implicit price deflator unless otherwise indicated.

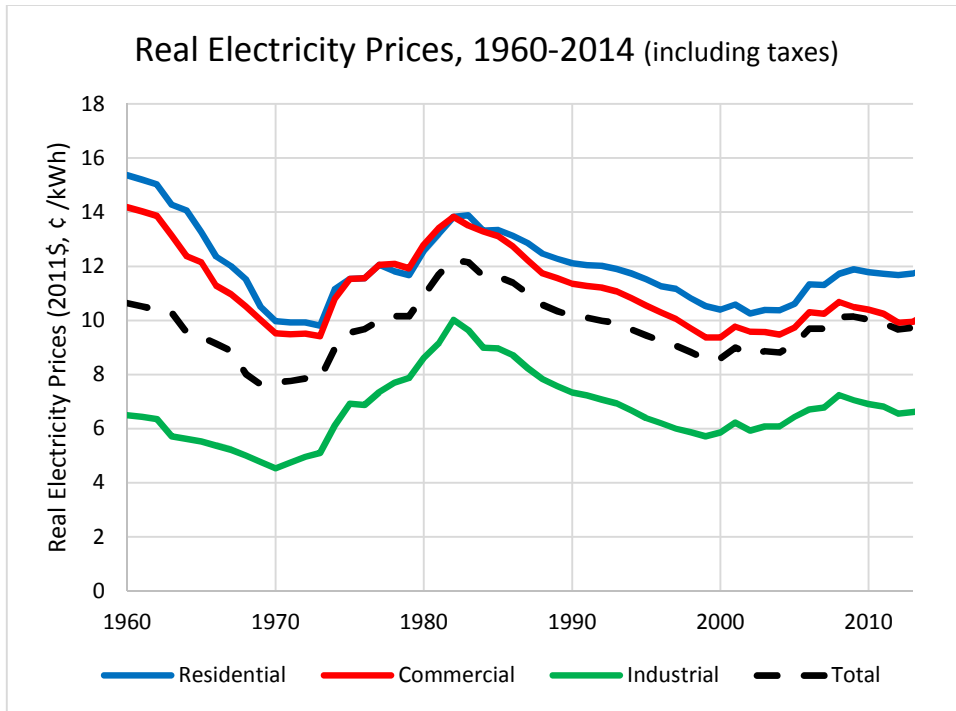

Figure 2-7. Real National Average Electricity Prices (2011\$) for Three Major End-Use Categories

Source: EIA Monthly Energy Review, April 2015, Table 9.8

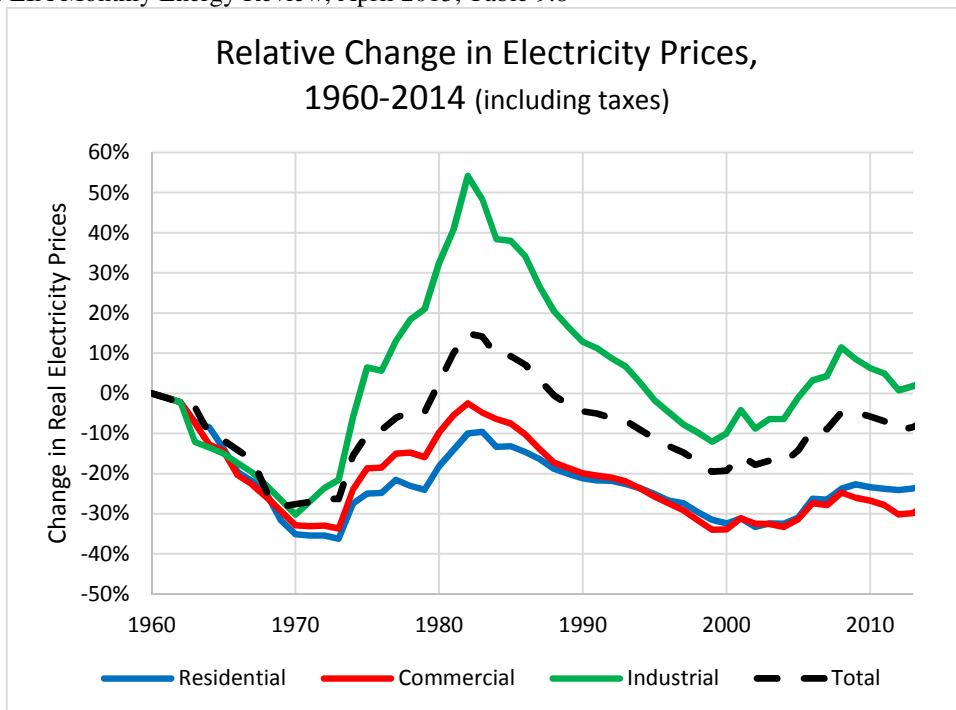

Figure 2-8. Relative Change in Real National Average Electricity Prices (2011\$) for Three Major End-Use Categories

Source: EIA Monthly Energy Review, April 2015, Table 9.8

2.3.2 Prices of Fossil Fuels Used for Generating Electricity

Another important factor in the changes in electricity prices are the changes in fuel prices for the three major fossil fuels used in electricity generation; coal, natural gas and oil. Relative to real prices in 2002, the national average real price (in 2011\$) of coal delivered to EGUs in 2012 had increased by 54 percent, while the real price of natural gas decreased by 22 percent. The real price of oil increased by 203 percent, but with oil declining as an EGU fuel (in 2012 oil generated only 1 percent of electricity) the doubling of oil prices had little overall impact in the electricity market. The combined real delivered price of all fossil fuels in 2012 increased by 23 percent over 2002 prices. Figure 2-9 shows the relative changes in real price of all 3 fossil fuels between 2002 and 2012.

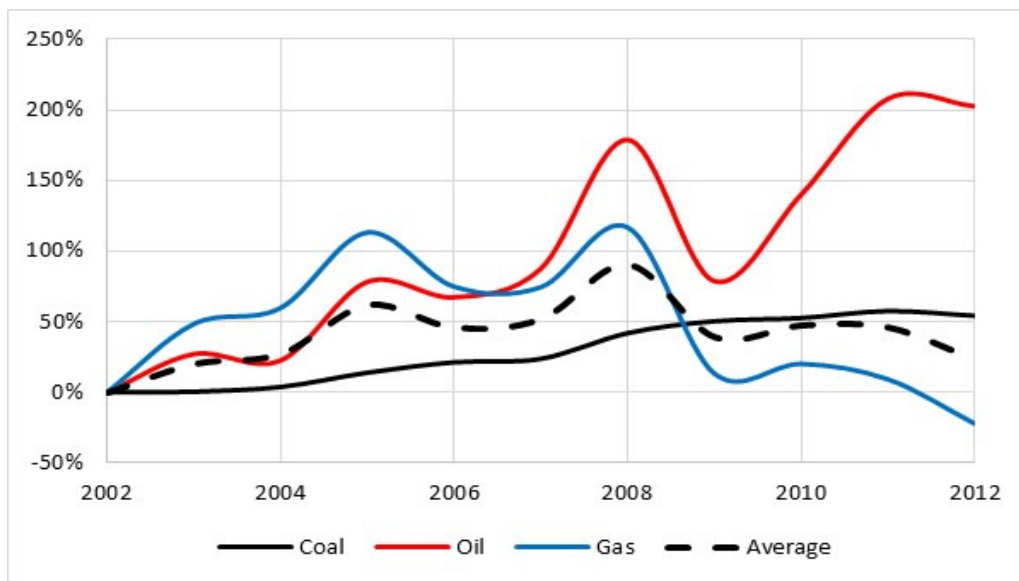

Figure 2-9. Relative Real Prices of Fossil Fuels for Electricity Generation; Change in National Average Real Price per MBtu Delivered to EGU

Source: EIA AEO 2012, Table 9.9

2.3.3 Changes in Electricity Intensity of the U.S. Economy Between 2002 to 2012

An important aspect of the changes in electricity generation (i.e., electricity demand) between 2002 and 2012 is that while total net generation increased by 4.9 percent over that period, the demand growth for generation has been low, and in fact was lower than both the population growth (9.2 percent) and real GDP growth (19.8 percent). Figure 2-10 shows the growth of electricity generation, population and real GDP during this period.

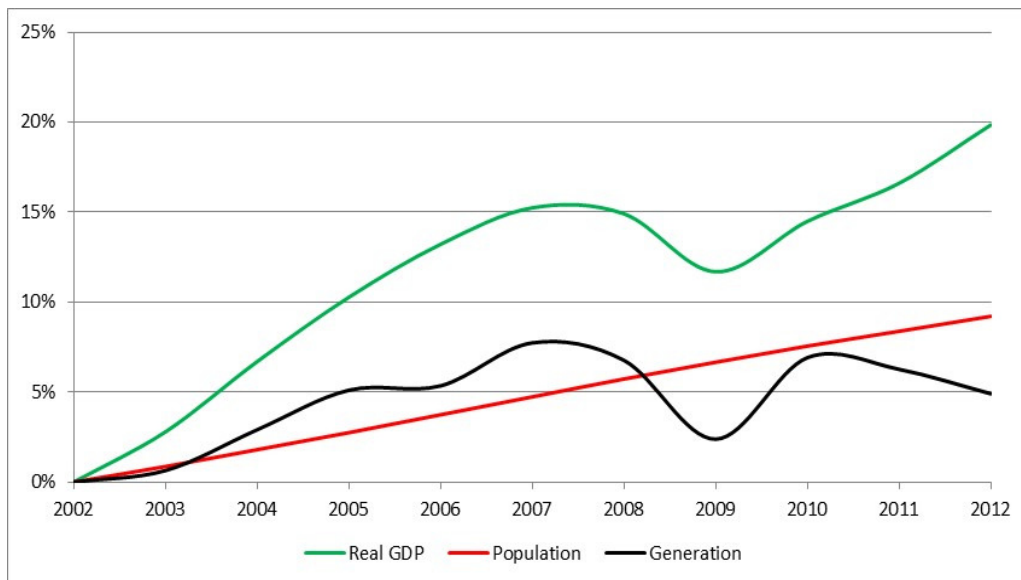

Figure 2-10. Relative Growth of Electricity Generation, Population and Real GDP Since 2002

Sources: U.S. EIA Monthly Energy Review, December 2014. Table 7.2a Electricity Net Generation: Total (All Sectors). U.S. Census.

Because demand for electricity generation grew more slowly than both the population and GDP, the relative electric intensity of the U.S. economy improved (i.e., less electricity used per person and per real dollar of output) during 2002 to 2012. On a per capita basis, real GDP per capita grew by 10.9 percent, increasing from \$44,900 (in 2011\$) per person in 2002 to \$49,800/person in 2012. At the same time electricity generation per capita decreased by 3.9 percent, declining from 13.4 MWh/person in 2002 to 12.8 MWh/person in 2012. The combined effect of these two changes improved the overall electricity efficiency of the U.S. market economy. Electricity generation per dollar of real GDP decreased 12.5 percent, declining from 299 MWh per \$1 million of GDP to 261 MWh/\$1 million GDP. These relative changes are shown in Figure 2-11. Figures 2-10 and 2-11 clearly show the effects of the 2007 – 2009

recession on both GDP and electricity generation, as well as the effects of the subsequent economic recovery.

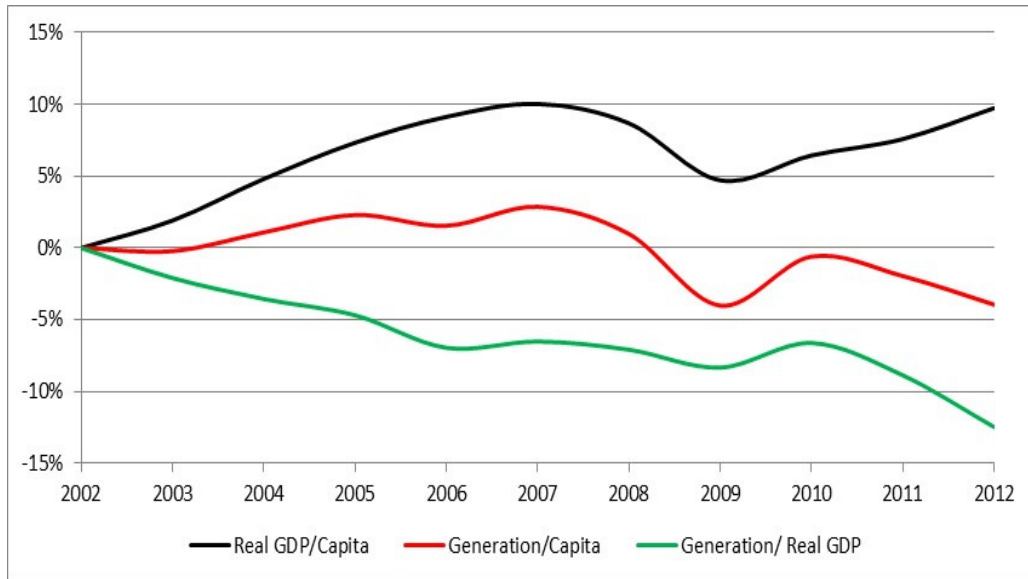

Figure 2-11. Relative Change of Real GDP, Population and Electricity Generation Intensity Since 2002

Sources: U.S. EIA Monthly Energy Review, December 2014. Table 7.2a Electricity Net Generation: Total (All Sectors). U.S. Census

2.4 Deregulation and Restructuring

The process of restructuring and deregulation of wholesale and retail electric markets has changed the structure of the electric power industry. In addition to reorganizing asset management between companies, restructuring sought a functional unbundling of the generation, transmission, distribution, and ancillary services the power sector has historically provided, with the aim of enhancing competition in the generation segment of the industry.

Beginning in the 1970s, government policy shifted against traditional regulatory approaches and in favor of deregulation for many important industries, including transportation (notably commercial airlines), communications, and energy, which were all thought to be natural monopolies (prior to 1970) that warranted governmental control of pricing. However, deregulation efforts in the power sector were most active during the 1990s. Some of the primary drivers for deregulation of electric power included the desire for more efficient investment

choices, the economic incentive to provide least-cost electric rates through market competition, reduced costs of combustion turbine technology that opened the door for more companies to sell power with smaller investments, and complexity of monitoring utilities' cost of service and establishing cost-based rates for various customer classes. Deregulation and market restructuring in the power sector involved the divestiture of generation from utilities, the formation of organized wholesale spot energy markets with economic mechanisms for the rationing of scarce transmission resources during periods of peak demand, the introduction of retail choice programs, and the establishment of new forms of market oversight and coordination.

The pace of restructuring in the electric power industry slowed significantly in response to market volatility in California and financial turmoil associated with bankruptcy filings of key energy companies. By the end of 2001, restructuring had either been delayed or suspended in eight states that previously enacted legislation or issued regulatory orders for its implementation (shown as "Suspended" in Figure 2-12). Eighteen other states that had seriously explored the possibility of deregulation in 2000 reported no legislative or regulatory activity in 2001 (EIA, 2003) ("Not Active" in Figure 2-12). Currently, there are 15 states plus the District of Columbia where price deregulation of generation (restructuring) has occurred ("Active" in Figure 2-12). Power sector restructuring is more or less at a standstill; by 2010 there were no active proposals under review by the Federal Energy Regulatory Commission (FERC) for actions aimed at wider restructuring, and no additional states have begun retail deregulation activity since that time.

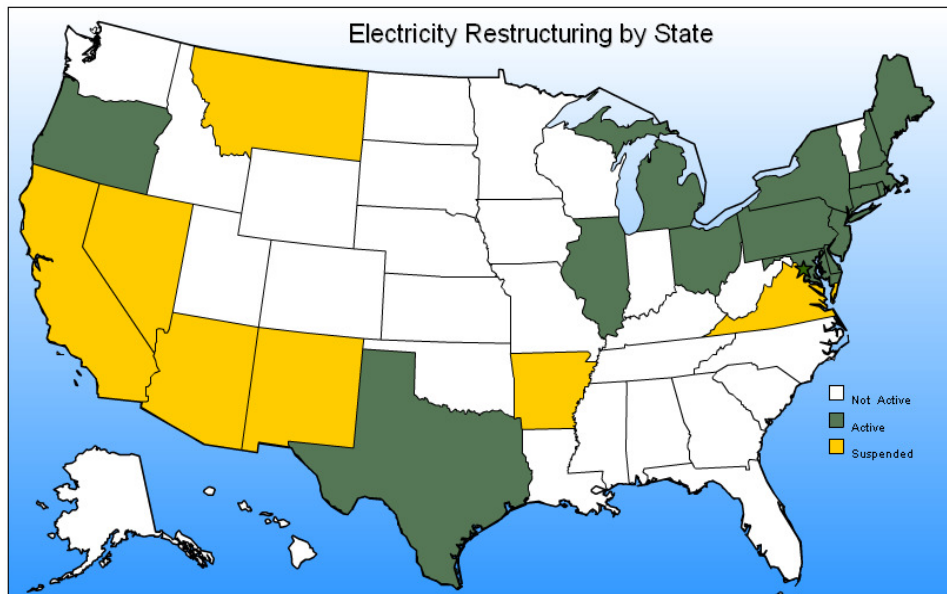

Figure 2-12. Status of State Electricity Industry Restructuring Activities

Source: EIA 2010. "Status of Electricity Restructuring by State." Available online at:
 <http://www.eia.gov/cneaf/electricity/page/restructuring/restructure_elect.html>.

One major effect of the restructuring and deregulation of the power sector was a significant change in type of ownership of electricity generating units in the states that deregulated prices. Throughout most of the 20th century electricity was supplied by vertically integrated regulated utilities. The traditional integrated utilities generation, transmission and distribution in their designated areas, and prices were set by cost of service regulations set by state government agencies (e.g., Public Utility Commissions). Deregulation and restructuring resulted in unbundling of the vertical integration structure. Transmission and distribution continued to operate as monopolies with cost of service regulation, while generation shifted to a mix of ownership affiliates of traditional utility ownership and some generation owned and operated by competitive companies known as Independent Power Producers (IPP). The resulting generating sector differed by state or region, as the power sector adapted to the restructuring and deregulation requirements in each state.

By 2002 the major impacts of adapting to changes brought about by deregulation and restructuring during the 1990s were largely in place. The resulting ownership mix of generating capacity (MW) in 2002 was 62 percent of the generating capacity owned by traditional utilities,

35 percent owned by IPPs³², and 3 percent owned by commercial and industrial producers. The mix of electricity generated (MWh) was more heavily weighted towards the utilities, with a distribution in 2002 of 66 percent, 30 percent and 4 percent for utilities, IPPs and commercial/industrial, respectively.

Since 2002 IPPs have expanded faster than traditional utilities, substantially increasing their share by 2012 of both capacity (58 percent utility, 39 percent IPPs, and 3 percent commercial/industrial) and generation (58 percent, 38 percent and 4 percent).

The mix of capacity and generation for each of the ownership types is shown in Figures 2-13 (capacity) and 2-14 (generation). The capacity and generation data for commercial and industrial owners are not shown on these figures due to the small magnitude of those ownership types. Figures 2-13 and 2-14 present the mixes in 2002 and 2012. A portion of the shift of capacity and generation is due to sales and transfers of generation assets from traditional utilities to IPPs, rather than strictly the result of newly built units.

³² IPP data presented in this section include both combined and non-combined heat and power plants.

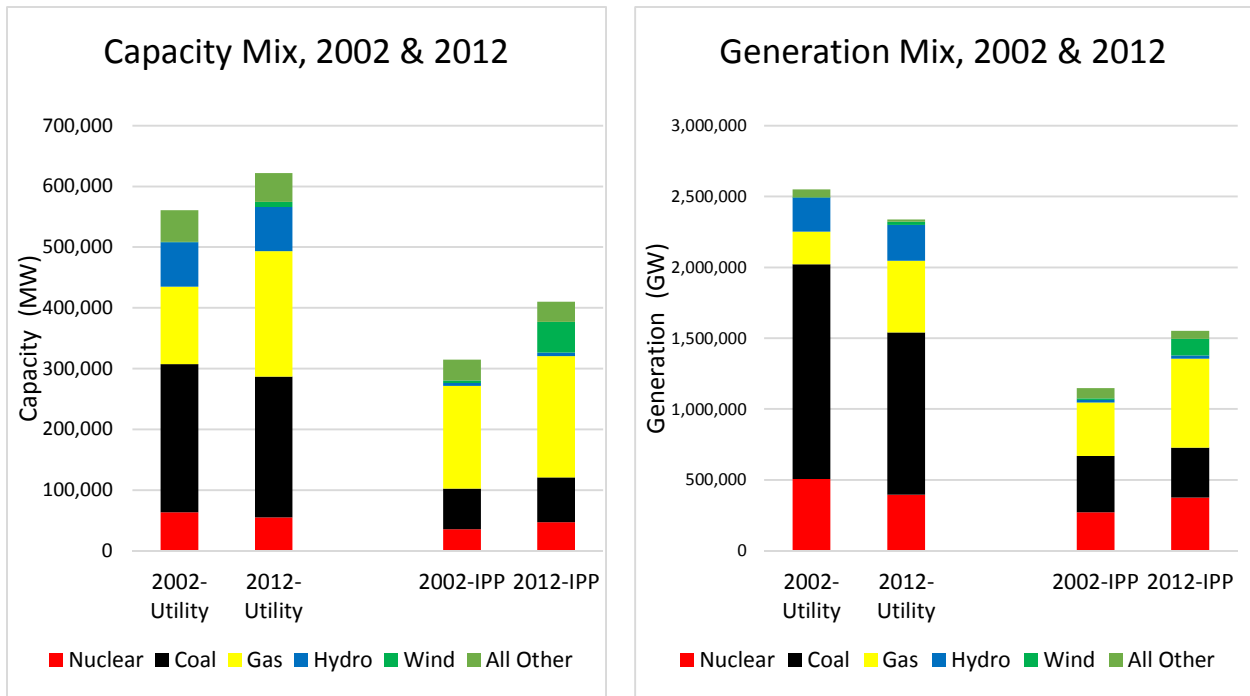

Figures 2-13 and 2-14. Capacity and Generation Mix by Ownership Type, 2002 & 2012

The mix of capacity by fuel types that have been built and retired between 2002 and 2012 also varies significantly by type of ownership. Figure 2-15 presents the new capacity built during that period, showing that IPPs built the majority of both new wind and solar generating capacity, as well as somewhat more natural gas capacity than the traditional utilities built. Figure 2-16 presents comparable data for the retired capacity, showing that utilities retired more coal and “other” capacity (mostly oil-fired) than IPPs retired, while the IPPs retired more natural gas capacity than the utilities retired. The retired gas capacity was primary (60 percent) steam and combustion turbines.

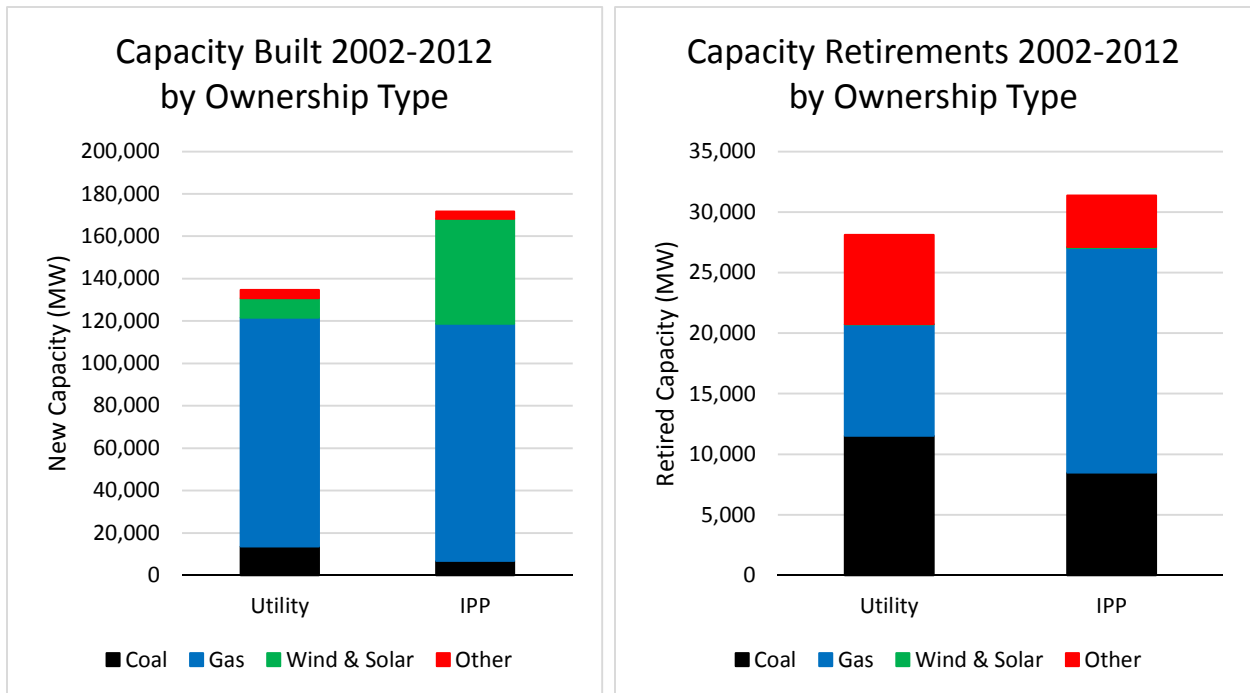

Figures 2-15 and 2-16. Generation Capacity Built and Retired between 2002 and 2012 by Ownership Type

2.5 Emissions of Greenhouse Gases from Electric Utilities

The burning of fossil fuels, which generates about 69 percent of our electricity nationwide, results in emissions of greenhouse gases. The power sector is a major contributor of CO₂ in particular, but also contributes to emissions of sulfur hexafluoride (SF₆), CH₄, and N₂O. In 2012, the electricity generation accounted for 38 percent of national CO₂ emissions. Including both generation and transmission (a source of SF₆), the power sector accounted for 31 percent of total nationwide greenhouse gas emissions, measured in CO₂ equivalent. Table 2-5 and Figure 2-17 show the GHG emissions³³ from the power sector relative to other major economic sectors. Table 2-6 shows the contributions of CO₂ and other GHGs from the power sector and other major emitting economic sectors.

³³ CO₂ equivalent data in this section are calculated with the IPCC SAR (Second Assessment Report) GWP potential factors.

Table 2-5. Domestic Emissions of Greenhouse Gases, by Economic Sector (million tons of CO₂ equivalent)

Sector/Source	2002		2013		Change Between '02 and '13		
	GHG Emissions	% Total GHG Emissions	GHG Emissions	% Total GHG Emissions	Change in Emissions	% Change in Emissions	% of Total Change in Emissions
Electric Power Industry	2,550	33%	2,289	31%	-260	-10%	64%
Transportation	2,158	28%	1,991	27%	-167	-8%	41%
Industry	1,564	20%	1,535	21%	-29	-2%	7%
Agriculture	618	8%	647	9%	29	5%	-7%
Commercial	402	5%	442	6%	40	10%	-10%
Residential	412	5%	413	6%	1	0%	0%
US Territories	58	<1%	38	<1%	-19	-33%	5%
Total GHG Emissions	7,762	100%	7,356	100%	-406	-5%	100%
Sinks and Reductions	-976		-972		4	0%	
Net GHG Emissions	6,786		6,384		-402	-6%	

Source: EPA, 2014 “Inventory of U.S. Greenhouse Gas Emissions and Sinks: 1990-2012”, Table 2-12. Includes CO₂, CH₄, N₂O and SF₆ emissions.

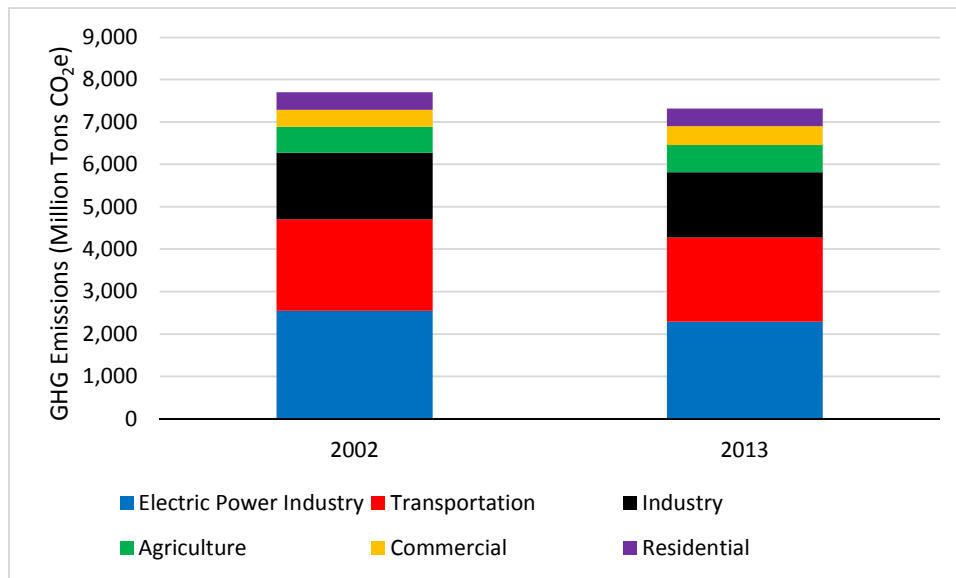

Figure 2-17. Domestic Emissions of Greenhouse Gases from Major Sectors, 2002 and 2013 (million tons of CO₂ equivalent)

Source: EPA, 2015 “Inventory of U.S. Greenhouse Gas Emissions and Sinks: 1990-2013”, Table 2-12.

Not Shown: CO₂e emissions from US Territories

The amount of CO₂ emitted during the combustion of fossil fuels varies according to the carbon content and heating value of the fuel used. The CO₂ emission factors used in IPM v5.14 (same as used in v5.13) are shown in Table 2-7. Coal has higher carbon content than oil or natural gas, and thus releases more CO₂ during combustion. Coal emits around 1.7 times as much carbon per unit of energy when burned as natural gas (EPA 2013).

Table 2-6. Greenhouse Gas Emissions from the Electricity Sector (Generation, Transmission and Distribution), 2002 and 2012 (million tons of CO₂ equivalent)

Gas/Fuel Type or Source		2002		2013		Change Between '02 and '13	
		GHG Emissions	% of Total GHG Emissions from Power Sector	GHG Emissions	% of Total GHG Emissions from Power Sector	Change in GHG Emissions	% Change in Emissions
CO ₂	Fossil Fuel Combustion	2,521	98.9%	2,262	98.8%	-259	-10%
	Coal	2,083	81.7%	1,736	75.8%	-347	-17%
	Natural Gas	337	13.22%	487	21.28%	150	45%
	Petroleum	84.7	3.32%	24.7	1.08%	-60.0	-71%
	Geothermal	0.4	0.02%	0.4	0.02%	0.0	0%
	Incineration of Waste	13.0	0.51%	11.1	0.49%	-1.9	-14%
	Other Process Uses of Carbonates	2.9	0.11%	2.4	0.11%	-0.4	-15%
CH ₄	Stationary Combustion*	0.4	0.02%	0.4	0.02%	0.0	0%
	Incineration of Waste	+		+			
N ₂ O	Stationary Combustion*	13.7	0.54%	21.4	0.93%	7.7	56%
	Stationary Combustion*	13.2	0.52%	21.1	0.92%	7.8	59%
	Incineration of Waste	0.4	0.02%	0.3	0.01%	-0.1	-25%
SF ₆	Electrical	14.7	0.57%	5.6	0.25%	-9.0	-62%
	Transmission and Distribution	14.7	0.57%	5.6	0.25%	-9.0	-62%
Total GHG Emissions		2,550		2,289		-260	

Source: EPA, 2015 "Inventory of U.S. Greenhouse Gas Emissions and Sinks: 1990-2015", Table 2-11

* Includes only stationary combustion emissions related to the generation of electricity.

** SF₆ is not covered by this rule, which specifically regulates GHG emissions from combustion.

+ Does not exceed 0.05 Tg CO₂ Eq. or 0.05 percent.

Table 2-7. Fossil Fuel Emission Factors in EPA Base Case 5.14 IPM Power Sector Modeling Application

Fuel Type	Carbon Dioxide (lb/MMBtu)
Coal	
Bituminous	202.8 – 209.6
Subbituminous	209.2 – 215.8
Lignite	212.6 – 219.
Natural Gas	117.1
Fuel Oil	
Distillate	161.4
Residual	161.4 – 173.9
Biomass	195
Waste Fuels	
Waste Coal	204.7
Petroleum Coke	225.1
Fossil Waste	321.1
Non-Fossil Waste	0
Tires	189.5
Municipal Solid Waste	91.9

Source: Documentation for IPM Base Case v.5.13, Table 11-5. The emission factors used in Base Case 5.14 are identical to the emission factors in IPM Base Case 5.13.

Note: CO₂ emissions presented here for biomass account for combustion only and do not reflect lifecycle emissions from initial photosynthesis (carbon sink) or harvesting activities and transportation (carbon source).

2.6 Carbon Dioxide Control Technologies

In the power sector, current approaches available for significantly reducing the CO₂ emissions of new fossil fuel combustion sources to meet a 1,400 lb CO₂/MWh emission rate include the use of: (1) highly efficiency coal-fired designs (e.g., modern supercritical or ultra-supercritical steam units) with up to 40 percent natural gas co-firing, (2), integrated coal gasification combined cycle (IGCC) with < 10 percent CCS or co-firing with up to 10 percent natural gas, (3) natural gas combined cycle (NGCC) combustion turbine/steam-turbine units, and/or (4) conventional coal-fired generation with carbon capture and storage (CCS). While CCS is not included in the BSER framework, it is an emerging technology with both new build and retrofit commercial-scale EGUs coming into operation in 2014 and 2015 in the United States and Canada. All of these units with CCS have received substantial subsidies to further develop and demonstrate the feasibility of CCS at a commercial scale, and the costs of these new units with

CCS are not indicative of anticipated future costs of new or retrofit CCS units. CCS is briefly discussed in this section as existing (but still emerging) technology that may become economically viable in the future.

Investment decisions for the optimal choice in a particular situation of the type of new generating capacity capable of meeting the 1,400 lb CO₂/MWh standard of performance depend in part on the intended primary use of new generating capacity. Daily peak electricity demands, involving operation for relatively few hours per year, are often most economically met by simple-cycle combustion turbines (CT). Stationary CTs used for power generation can be installed quickly, at relatively low capital cost. They can be remotely started and loaded quickly, and can follow rapid demand changes. Full-load efficiencies of large current technology CTs are typically 30-33 percent but can be as high as 40 percent or more (high heating value basis), as compared to efficiencies of 50 percent or more for new combined-cycle units that recover and use the exhaust heat otherwise wasted from a CT. A simple-cycle CT's lower efficiency causes it to burn much more fuel to produce a MWh of electricity than a combined-cycle unit. Thus, when burning natural gas its CO₂ emission rate per MWh could be 40-60 percent higher than a more efficient NGCC unit.

Base load electricity demand can be met with NGCC generation, coal and other fossil-fired steam generation, and IGCC technology, as well as generation from sources that do not emit CO₂, such as nuclear and hydro. IGCC employs the use of a gasifier to transform fossil fuels into synthesis gas ("syngas") and heat. The syngas is used to fuel a combined cycle generator, and the heat from the syngas conversion can produce steam for the steam turbine portion of the combined cycle generator. Electricity can be generated through this IGCC process somewhat more efficiently than through conventional boiler-steam generators. Additionally, with gasification, some of the syngas can be converted into other marketable products such as fertilizers and chemical feedstocks for Fisher-Tropsch processes to manufacture liquid hydrocarbons (e.g., fuels and lubricants), and CO₂ can be captured for use in EOR. Figure 2-18 shows the array of products (including electricity) and by-products that can be produced in a syngas process (NETL).

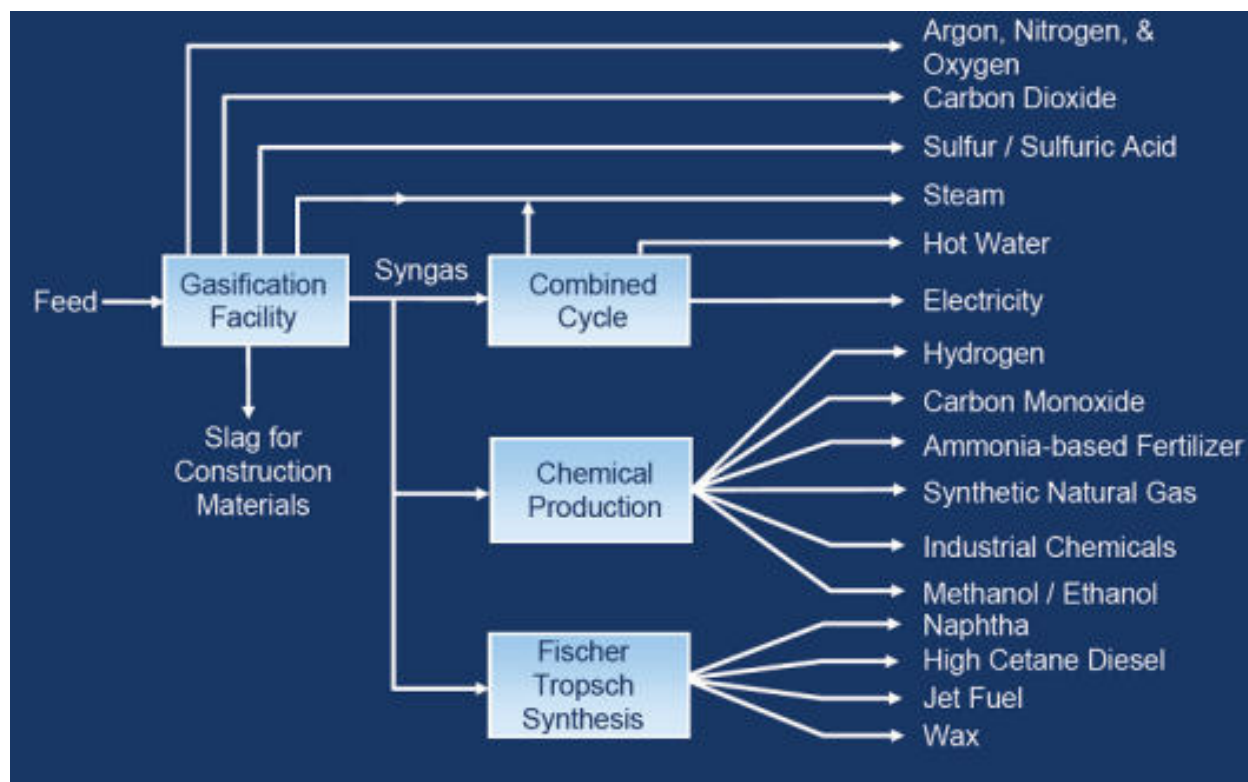

Figure 2-18. Marketable products from Syngas Generation

Source: National Energy Technology Lab. Gasifipedia. Available online at:

<http://www.netl.doe.gov/research/coal/energy-systems/gasification/gasifipedia/co-generation>

2.6.1 Carbon Capture and Storage

CCS can be achieved through either pre-combustion or post-combustion capture of CO₂ from a gas stream associated with the fuel combusted. Furthermore, CCS can be designed and operated for full capture of the CO₂ in the gas stream (i.e., above 90 percent) or for partial capture (below 90 percent). Post-combustion capture processes remove CO₂ from the exhaust gas of a combustion system – such as a utility boiler. It is referred to as “post-combustion capture” because the CO₂ is the product of the combustion of the primary fuel and the capture takes place after the combustion of that fuel. This process is described in more detail in the preamble. (See preamble section V.D.) This process is illustrated for a pulverized coal power plant in Figure 2-19. For post-combustion, a station's net generating output will be lower due to the energy needs of the capture process.

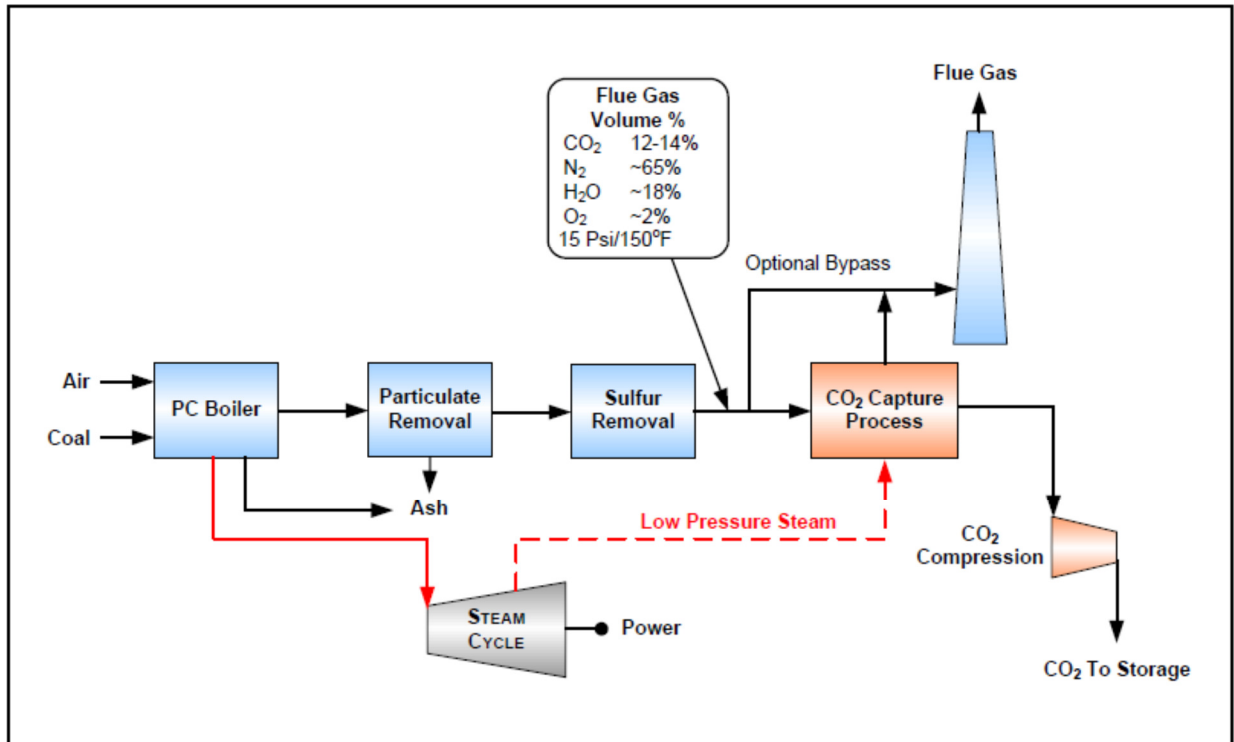

Figure 2-19. Post-Combustion CO₂ Capture for a Pulverized Coal Power Plant

Source: Interagency Task Force on Carbon Capture and Storage 2010

Pre-combustion capture is mainly applicable to IGCC facilities, where the fuel is converted into gaseous components (“syngas”) under heat and pressure and some percentage of the carbon contained in the syngas is captured before combustion.³⁴ For pre-combustion technology, a significant amount of energy is needed to gasify the fuel(s). This process is illustrated in Figure 2-20. Application of post-combustion CCS with IGCC can be designed to use no water-gas shift, or single- or two-stage shift processes, to obtain varying percentages of CO₂ removal – from a “partial capture” percentage to 90 percent “full capture.” Pre-combustion CCS typically has a lesser impact on net energy output than does post-combustion CCS. For more detail on CCS technology, see the “Report of the Interagency Task Force on Carbon Capture and Storage” (2010).³⁵

³⁴ Note that pre-combustion CCS is not considered the best system of emission reduction for this standard. This information is provided for background purposes.

³⁵ For more information on the cost and performance of CCS, see http://www.netl.doe.gov/energy-analyses/baseline_studies.html.

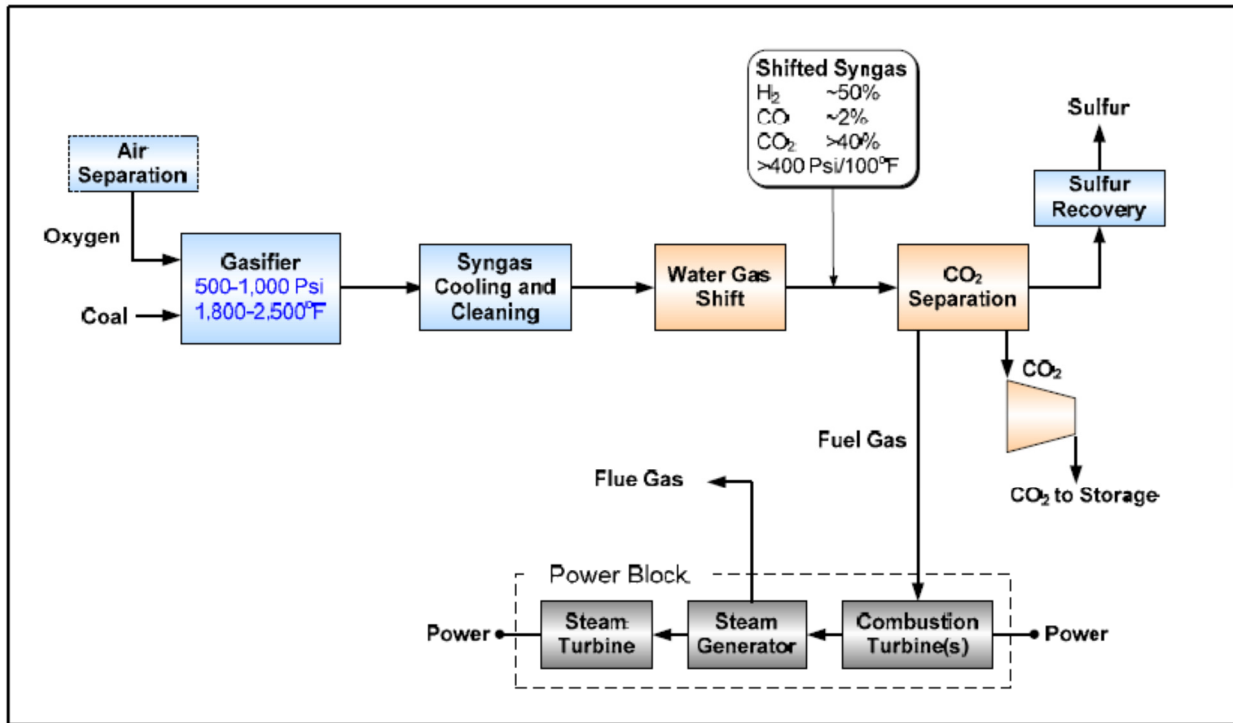

Figure 2-20. Pre-Combustion CO₂ Capture for an IGCC Power Plant

Source: Interagency Task Force on Carbon Capture and Storage 2010

Carbon capture technology has been successfully applied since 1930 on several smaller scale industrial facilities and more recently in a number of demonstration phase projects worldwide for power sector applications. In October 2014 the first commercial-scale coal-fired capture and storage project for electricity generation began operation at the Boundary Dam Power Station in Saskatchewan, Canada. The Boundary Dam Station is owned by the Province of Saskatchewan, and operated by SaskPower, a provincially owned corporation that is the primary electric utility in the Province. The commercial-scale demonstration project retrofit Unit 3 (a 130 MW, coal fired built in 1970, and rebuilt in 2013) at a total cost of approximately \$1.5 billion (Canadian, or about \$1.2 billion US), including a partial subsidy of \$240 million (Canadian) by the Canadian federal government. The carbon capture system is a post-combustion process designed to capture 90 percent of the CO₂ emitted by Unit #3. Retrofitting the carbon capture system reduced the capacity of the unit to 110 MW. The majority of the captured CO₂ is used for an EOR project in southern Saskatchewan. The portion of the CO₂ is being stored in a nearby research and monitoring geological storage facility, where the captured CO₂ will be injected 3.4 kilometers underground into a sandstone formation located below the

major coal field supplying lignite to Unit # 3. The remaining captured CO₂ will be injected into deep saline formations.

In the United States, there are two commercial-scale CCS facilities nearing completion:

1. the Kemper County Carbon Dioxide Capture and Storage Project in Mississippi, and
2. The W.A. Parish Petra Nova CCA Project near Houston, Texas.

Construction began on the Kemper project in 2010, and the startup is currently scheduled for May, 2016. The Kemper project is constructing a new 524 MW lignite unit as well as a 58 MW natural gas unit. Mississippi Power (a division of Southern Power) is building and will operate the Kemper County project. The control system is designed to capture 65 percent of the CO₂ generated by the plant, and is projected to capture 3.5 million tons of CO₂ per year. The resulting CO₂ emission rate is expected to be about 800 pounds per MWh produced. The current total cost estimate is \$5.6 billion, a substantial increase from the original \$2.4 billion estimate.³⁶ The construction has received a \$270 million grant from the US Department of Energy, and \$133 million in investment tax credits from the Internal Revenue Service. The captured CO₂ will be transported via a 60 mile pipeline and used for EOR projects in mature Mississippi oil fields.³⁷

The only other commercial-scale electricity power sector CCS project currently under construction in the United States is the W.A. Parish Petra Nova CCS Project near Houston, Texas. The Parish Petra project is a 50/50 partnership between NRG Energy (an integrated electricity company generating and supplying electricity to 1.6 million customers in Texas) and the Nippon Oil and Gas Exploration Company. The Parish project will retrofit a post-combustion CCS system on a portion of the flue gas from the existing 610 MW coal fired Unit # 8. The CCS system will treat a 240 MW slipstream of the flue gas, and is designed to capture 90 percent of the CO₂ in the treated flue gas. The capacity rating of Unit # 8 will not be reduced due to the

³⁶ The Mississippi Public Utilities Staff authorized an independent monitor to conduct a review of the project. The findings of the review are provided in a summary report Available online at: http://www.psc.state.ms.us/InsiteConnect/InSiteView.aspx?model=INSITE_CONNECT&queue=CTS_ARCHIVEQ&docid=328417

³⁷ Carbon Capture and Sequestration Technologies Program at MIT. Accessed 1/23/2015. <https://sequestration.mit.edu/tools/projects/kemper.html>

CCS project because an 85 MW custom-built natural gas fired combustion turbine co-generation unit is being built on-site to provide both electricity and steam to the CCS unit. The total cost of the CCS project is estimated to be \$1 billion (including a \$167 million grant from the US Department of Energy), and the project is expected to extract 1.4 – 1.6 million tons of CO₂ per year. The construction contract was awarded in July, 2014, and operation is expected to begin in early 2016. The CO₂ will be piped 85 miles to a reservoir for EOR in the West Ranch Oil Field.³⁸

2.6.2 Geologic and Geographic Considerations for Geologic Sequestration

Geologic sequestration (GS) (i.e., long-term containment of a CO₂ stream in subsurface geologic formations) is technically feasible and available throughout most of the United States. GS is feasible in different types of geologic formations including deep saline formations (formations with high salinity formation fluids) or in oil and gas formations, such as where injected CO₂ increases oil production efficiency through a process referred to as enhanced oil recovery (EOR). CO₂ may also be used for other types of enhanced recovery, such as for natural gas production. Reservoirs, such as unmineable coal seams, also offer the potential for geologic storage. The geographic availability of deep saline formations, EOR, and un-mineable coal seams is shown in Figure 2-21. Estimates of CO₂ storage resources by state compiled by the DOE's National Carbon Sequestration Database and Geographic Information System (NATCARB) and published in DOE's 2012a Carbon Utilization and Storage Atlas (discussed below) are provided in Table 2-8.

³⁸ US DOE (2010) "Recovery Act: W.A. Parish Post-Combustion CO₂ Capture and Sequestration Project". <http://www.netl.doe.gov/research/proj?k=FE0003311> Accessed 1/23/2015

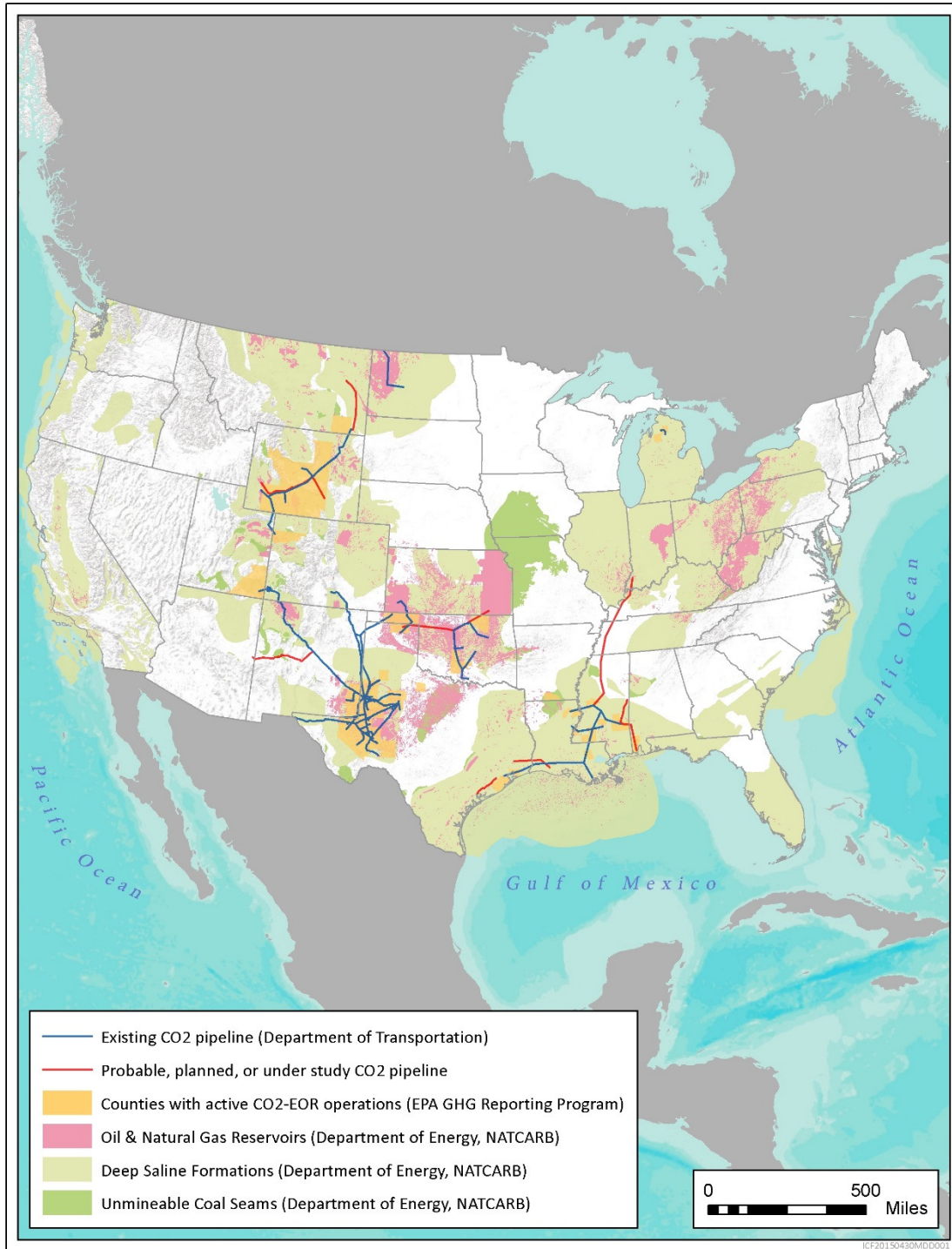

Figure 2-21. Geologic Sequestration in the Continental United States

Sources: EPA Greenhouse Gas Reporting Program; Department of Energy, NATCARB; Department of Transportation, National Pipeline Management System.

Table 2-8. Total CO₂ Storage Resource (DOE-NETL)³⁹

State	Million Tons*	
	Low Estimate	High Estimate
ALABAMA	135,022	765,422
ALASKA	9,524	21,771
ARIZONA	143	1,290
ARKANSAS	6,812	70,184
CALIFORNIA	37,357	463,665
COLORADO	41,458	393,734
CONNECTICUT	not assessed by DOE-NETL	not assessed by DOE-NETL
DELAWARE	44	44
DISTRICT OF COLUMBIA	not assessed by DOE-NETL	not assessed by DOE-NETL
FLORIDA	113,251	611,793
GEORGIA	160,210	175,322
HAWAII	not assessed by DOE-NETL	not assessed by DOE-NETL
IDAHO	44	430
ILLINOIS	11,045	128,772
INDIANA	35,296	75,189
IOWA	11	55
KANSAS	11,993	95,173
KENTUCKY	3,219	8,433
LOUISIANA	186,842	2,319,238
MAINE	not assessed by DOE-NETL	not assessed by DOE-NETL
MARYLAND	2,050	2,127
MASSACHUSETTS	not assessed by DOE-NETL	not assessed by DOE-NETL

(Continued on next page)

³⁹ The United States 2012 Carbon Utilization and Storage Atlas, Fourth Edition, U.S Department of Energy, Office of Fossil Energy, National Energy Technology Laboratory (NETL).

Table 2-8. Total CO₂ Storage Resource, continued

State	Million Tons*	
	Low Estimate	High Estimate
MICHIGAN	20,999	52,040
MINNESOTA	not assessed by DOE-NETL	not assessed by DOE-NETL
MISSISSIPPI	159,846	1,306,270
MISSOURI	11	187
MONTANA	93,233	1,006,100
NEBRASKA	26,202	124,826
NEVADA	not assessed by DOE-NETL	not assessed by DOE-NETL
NEW HAMPSHIRE	not assessed by DOE-NETL	not assessed by DOE-NETL
NEW JERSEY	-	-
NEW MEXICO	47,135	395,828
NEW YORK	5,115	5,115
NORTH CAROLINA	1,477	20,271
NORTH DAKOTA	73,954	162,569
Offshore Federal Only	539,956	7,098,976
OHIO	14,837	14,837
OKLAHOMA	62,777	269,570
OREGON	7,507	103,286
PENNSYLVANIA	24,361	24,361
RHODE ISLAND	not assessed by DOE-NETL	not assessed by DOE-NETL
SOUTH CAROLINA	33,180	37,677
SOUTH DAKOTA	9,656	26,489
TENNESSEE	474	4,255
TEXAS	489,205	4,772,925
UTAH	28,076	265,558
VERMONT	not assessed by DOE-NETL	not assessed by DOE-NETL
VIRGINIA	485	3,208
WASHINGTON	40,367	547,550
WEST VIRGINIA	18,353	18,353
WISCONSIN	0	0
WYOMING	80,127	754,917
U.S. Total	2,531,653	22,147,811

* States with a “zero” value represent estimates of minimal CO₂ storage resource. States that have not yet been assessed by the RCSPs have been identified.

2.6.3 Availability of Geologic Sequestration in Deep Saline Formations

DOE and the United States Geological Survey (USGS) have independently conducted preliminary analyses of the availability and potential CO₂ sequestration capacity of deep saline formations in the United States. DOE estimates are compiled by the DOE's National Carbon Sequestration Database and Geographic Information System (NATCARB) using volumetric models and published in a Carbon Utilization and Storage Atlas.⁴⁰ DOE estimates that areas of the United States with appropriate geology have a sequestration potential of at least 2,244 billion tons of CO₂ in deep saline formations. According to DOE and at least 39 states have geologic characteristics that are amenable to deep saline GS in either onshore or offshore locations. In 2013, the USGS completed its evaluation of the technically accessible GS resources for CO₂ in U.S. onshore areas and state waters using probabilistic assessment.⁴¹ The USGS estimates a mean of 3,307 billion tons of subsurface CO₂ sequestration potential, including saline and oil and gas reservoirs, across the basins studied in the United States. As shown in Figure 2-21, there are 39 states for which onshore and offshore deep saline formation storage capacity has been identified.⁴²

2.6.4 Availability of CO₂ Storage via Enhanced Oil Recovery (EOR)

Although the regulatory impact analysis for this rule relies on GS in deep saline formations, the EPA also recognizes the potential for securely sequestering CO₂ via EOR. EOR has been successfully used at numerous production fields throughout the United States to increase oil recovery. The oil industry in the United States has over 40 years of experience with EOR. An oil industry study in 2014 identified more than 125 EOR projects in 98 fields in the United States.⁴³ More than half of the projects evaluated in the study have been in operation for

⁴⁰ The United States 2012 Carbon Utilization and Storage Atlas, Fourth Edition, U.S. Department of Energy, Office of Fossil Energy, National Energy Technology Laboratory (NETL).

⁴¹ U.S. Geological Survey Geologic Carbon Dioxide Storage Resources Assessment Team, 2013, National assessment of geologic carbon dioxide storage resources—Results: U.S. Geological Survey Circular 1386, p. 41, <http://pubs.usgs.gov/circ/1386/>.

⁴² Alaska is not shown in the figure; it has deep saline formation storage capacity, geology amenable to EOR operations, and potential GS capacity in unmineable coal.

⁴³ Koottungal, Leena, 2014, 2014 Worldwide EOR Survey, Oil & Gas Journal, Volume 112, Issue 4, April 7, 2014 (corrected tables appear in Volume 112, Issue 5, May 5, 2014).

more than 10 years, and many have been in operation for more than 30 years. This experience provides a strong foundation for demonstrating successful CO₂ injection and monitoring technologies, which are needed for safe and secure GS that can be used for deployment of CCS across geographically diverse areas.

Currently, 12 states have active EOR operations and most have developed an extensive CO₂ infrastructure, including pipelines, to support the continued operation and growth of EOR. An additional 18 states are within 100 kilometers (62 miles) of current EOR operations (see Figure 2-21).⁴⁴ The vast majority of EOR is conducted in oil reservoirs in the Permian Basin, which extends through southwest Texas and southeast New Mexico. States where EOR is utilized include Alabama, Colorado, Louisiana, Michigan, Mississippi, New Mexico, Oklahoma, Texas, Utah, and Wyoming.

At the project level, the volume of CO₂ already injected for EOR and the duration of operations are of similar magnitude to the duration and volume of CO₂ expected to be captured from fossil fuel-fired EGUs. The volume of CO₂ used in EOR operations can be large (e.g., 55 million tons of CO₂ were stored in the SACROC unit in the Permian Basin over 35 years), and operations at a single oil field may last for decades, injecting into multiple parts of the field.⁴⁵ According to data reported to the EPA's Greenhouse Gas Reporting Program (GHGRP), approximately 66 million tons of CO₂ were supplied to EOR in the United States in 2013.⁴⁶ Approximately 70 percent of this total CO₂ supplied was produced from natural (geologic) CO₂ sources, and approximately 30 percent was captured from anthropogenic sources.⁴⁷

A DOE-sponsored study has analyzed the geographic availability of applying EOR in 11 major oil producing regions of the United States and found that there is an opportunity to

⁴⁴ The distance of 100 kilometers reflects the assumptions in the DOE-NETL cost estimates.

⁴⁵ Han, Weon S., McPherson, B J., Lichtner, P C., and Wang, F P. "Evaluation of CO₂ trapping mechanisms at the SACROC northern platform, Permian basin, Texas, site of 35 years of CO₂ injection." *American Journal of Science* 310. (2010): 282-324.

⁴⁶ Greenhouse Gas Reporting Program, data reported as of August 18, 2013.

⁴⁷ Greenhouse Gas Reporting Program, data reported as of August 18, 2013.

significantly increase the application of EOR to areas outside of current operations.⁴⁸ DOE-sponsored geologic and engineering analyses show that expanding EOR operations into areas additional to the capacity already identified and applying new methods and techniques over the next 20 years could utilize 20 billion tons of anthropogenic CO₂ and increase total oil production by 67 billion barrels. The availability of anthropogenic CO₂ in areas outside of current sources could drive new EOR projects by making more CO₂ locally available.

2.7 State Policies on GHG and Clean Energy Regulation in the Power Sector

Several states have also established emission performance standards or other measures to limit emissions of GHGs from new EGUs that are comparable to or more stringent than this rulemaking.

In 2003, then-Governor George Pataki sent a letter to his counterparts in the Northeast and Mid-Atlantic inviting them to participate in the development of a regional cap-and-trade program addressing power plant CO₂ emissions. This program, known as the Regional Greenhouse Gas Initiative (RGGI), began in 2009 and sets a regional CO₂ cap for participating states. The currently participating states include: Connecticut, Delaware, Maine, Maryland, Massachusetts, New Hampshire, New York, Rhode Island, and Vermont. The cap covers CO₂ emissions from all fossil-fired EGUs greater than 25 MW in participating states, and limits total emissions to 91 million short tons in 2014. The 2014 emissions cap is a 51 percent reduction below the initial cap in 2009 to 2011 of 188 million tons. This emissions budget is reduced 2.5 percent annually from 2015 to 2020. RGGI CO₂ allowances are sold in a quarterly auction. RGGI conducted their 27th quarterly allowance auction in March, 2015 the market clearing price was \$5.41 per ton of CO₂ for current allowances, which was a record high price (the February '15 price of \$5.21 was the previous record). A total of allowances for 15.3 million tons were sold in the March '15 auction, well below the record of 38.7 million tons sold in June '13 for \$3.21.

⁴⁸ "Improving Domestic Energy Security and Lowering CO₂ Emissions with "Next Generation" CO₂-Enhanced Oil Recovery", Advanced Resources International, Inc. (ARI), 2011. Available online at: <http://www.netl.doe.gov/research/energy-analysis/publications/details?pub=df02ffba-6b4b-4721-a7b4-04a505a19185>.

In September 2006, California Governor Schwarzenegger signed into law Senate Bill 1368. The law limits long-term investments in baseload generation by the state's utilities to power plants that meet an emissions performance standard jointly established by the California Energy Commission and the California Public Utilities Commission. The Energy Commission has designed regulations that establish a standard for new and existing baseload generation owned by, or under long-term contract to publicly owned utilities, of 1,100 lb CO₂/MWh-net.

In 2006 Governor Schwarzenegger also signed into law Assembly Bill 32, the Global Warming Solutions Act of 2006. This act includes a multi-sector GHG cap-and-trade program which covers approximately 85 percent of the state GHG emissions. EGUs are included in phase I of the program, which began in 2013. Phase II begins in 2020 and includes upstream sources. The cap is based on a 2 percent reduction from total 2012 expected emissions, and declines 2 percent annually through 2014, then 3 percent each year until 2020. The AB32 cap and trade program began functioning in 2011, and functioning market is now operating on the NYMEX futures commodity market. The final 2014 market price for 2014 carbon allowances was \$13.65/ton of carbon. On April 17, 2015 the 2015 allowance futures price was \$13.94/ton, and the spot price was \$13.73/ton.

In May 2007, Washington Governor Gregoire signed Substitute Senate Bill 6001, “Baseload Electric Generation Performance” which established statewide GHG emissions reduction goals, and imposed an emission standard that applies to any baseload electric generation that commenced operation after June 1, 2008 and is located in Washington, whether or not that generation serves load located within the state. Baseload generation facilities must initially comply with an emission limit of 1,100 lb CO₂/MWh-net. In 2013 the State of Washington revised⁴⁹ the emission limit to 970 lb CO₂/MWh-net based on a survey of available NGCC generation units commercially available in the United States.

In 1997 Oregon required a new baseload gas fired power plants to meet a CO₂ emission standard that was 17 percent below the most efficient NGCC unit operating in the United States.

⁴⁹ Washington Department of Commerce, 2013. “Greenhouse Gas Emission Performance Standard for Baseload Electric Generation”. Available online at: <http://www.commerce.wa.gov/Documents/Concise-Expl-Stmt-WSR-13-06-074.pdf>.

In 2000 Oregon established that the effective 17 percent below most efficient was 675 lb CO₂/MWh-net. In July 2009, Oregon Governor Kulongoski signed Senate Bill 101, which mandated that facilities generating baseload electricity, whether gas- or coal-fired, must have emissions equal to or less than 1,100 lb CO₂/MWh-net regardless of fuel type, and prohibited utilities from entering into long-term purchase agreements for baseload electricity with out-of-state facilities that do not meet that standard. Natural gas- and petroleum distillate-fired facilities that are primarily used to serve peak demand or to integrate energy from renewable resources are specifically exempted from the performance standard.

In August 2011, New York Governor Cuomo signed the Power NY Act of 2011. Implementing regulations established CO₂ emission standards for new and modified electric generators greater than 25 MW. The standards vary based on the type of facility: base load facilities must meet a CO₂ standard of 925 lb/MWh-net or 120 lb/MMBtu, and peaking facilities must meet a CO₂ standard of 1,450 lbs/MWh-net or 160 lbs/MMBtu.

Several other states have enacted CO₂ regulations affecting EGUs that do not set emission limits, but set other regulatory requirements limiting CO₂ emissions from EGUs. For example, Montana enacted a law in 2007 requiring the Public Service Commission to limit approvals of new equity interests in or leases of a facility used to generate coal-based electricity to facilities that capture and sequester at least half of their CO₂ emissions. Minnesota enacted the Next Generation Energy Act in 2007 requiring increases in power sector greenhouse gas emissions from any new large coal energy facilities built in Minnesota or the import of electricity from such a facility located out of state to be offset by equivalent emission reductions. New Mexico enacted legislation in 2007 authorizing tax credits and cost recovery incentives for qualifying coal-fired facilities. To qualify, plants must capture and store emissions so that they emit less than 1,100 lbs CO₂/MWh, among other requirements.

Additionally, most states have implemented Renewable Portfolio Standards (RPS), or Renewable Electricity Standards (RES). These programs are designed to increase the renewable share of a state's total electricity generation. Currently 29 states, the District of Columbia, and Guam have enforceable RPS or other mandatory renewable capacity policies, and eight states,

Puerto Rico, and Guam have voluntary goals.⁵⁰ These programs vary widely in structure, enforcement, and scope.

2.8 Revenues and Expenses

Due to lower retail electricity sales, total utility operating revenues declined in 2012 to \$271 billion from a peak of almost \$300 billion in 2008. Despite revenues not returning to 2008 levels in 2012, operating expenses were appreciably lower and as a result, net income also rose in comparison to 2008 (see Table 2-9). Recent economic events have put downward pressure on electricity demand, thus dampening electricity prices and consumption (utility revenues), but have also reduced the price and cost of fossil fuels and other expenses. In 2012 electricity generation was 1.28 percent below the generation in 2011, and has declined in 4 of the past 5 years.

Table 2-9 shows that investor-owned utilities (IOUs) earned income of about 13.0 percent compared to total revenues in 2012. The 2012 return on revenue was the third highest year for the period 2002 to 2012 (average: 11.9 percent range: 10.6 percent to 13.32 percent).

Table 2-9. Revenue and Expense Statistics for Major U.S. Investor-Owned Electric Utilities for 2002, 2008 and 2012 (nominal \$millions)

	2002	2008	2012
Utility Operating Revenues	219,609	298,962	270,912
Electric Utility	200,360	266,124	249,166
Other Utility	19,250	32,838	21,745
Utility Operating Expenses	189,062	267,263	235,694
Electric Utility	171,604	236,572	220,722
Operation	116,660	175,887	152,379
Production	90,715	140,974	111,714
Cost of Fuel	24,149	47,337	38,998
Purchased Power	58,810	84,724	54,570
Other	7,776	8,937	18,146
Transmission	3,560	6,950	7,183
Distribution	3,117	3,997	4,181
Customer Accounts	4,168	5,286	5,086
Customer Service	1,820	3,567	5,640

⁵⁰ EIA 2012a

Sales	264	225	221
Admin. and General	13,018	14,718	18,353
Maintenance	10,861	14,192	15,489
Depreciation	16,199	19,049	23,677
Taxes and Other	26,716	26,202	29,177
Other Utility	17,457	30,692	14,972
Net Utility Operating Income	30,548	31,699	35,218

Source: Table 8.3, EIA Electric Power Annual, 2012

Note: This data does not include information for public utilities, nor for Independent Power Producers (IPPs).

2.9 Natural Gas Market

The natural gas market in the United States has historically experienced significant price volatility from year to year, between seasons within a year, can undergo major price swings during short-lived weather events (such as cold snaps leading to short-run spikes in heating demand), and has seen a dramatic shift since 2008 due to increased production from shale formations . Over the last decade, the annual average nominal price of gas delivered to the power sector peaked in 2008 at \$9.02/MMBtu and has since fallen dramatically to a low of \$3.42/MMBtu in 2012. During that time, the daily price⁵¹ of natural gas reached as high as \$18.48/MMBtu and as low as \$2.03. Adjusting for inflation using the GDP implicit price deflator, in \$2011 the annual average price of natural gas delivered to the power sector peaked at \$9.38/MMBtu in 2008 and has fallen dramatically to a low of \$3.36 in 2012. The annual natural gas prices in both nominal and real (2011\$) terms are in Figure 2-22. A comparison of the trends in the real price of natural gas with the real prices of delivered coal and oil are shown in Figure 2-23. Figure 2-23 shows that while the real price of coal and oil increased from 2002 to 2012 (+54 percent and +203 percent respectively), the real price of natural gas declined by 22 percent in the same period. Most of the decline in real natural gas prices occurred between 2008 (the peak price year) and 2012, during which real gas prices declined by 64 percent while coal and oil

⁵¹ Henry Hub daily prices. Henry Hub is a major gas distribution hub in Louisiana; Henry Hub prices are generally seen as the primary metric for national gas prices for all end uses. The price of natural gas delivered to electricity generation differs substantially in different regions of the country, and can be higher or lower than the Henry Hub national benchmark price.

prices both increased by 9 percent. The sharp decline in natural gas prices from 2008 to 2012 was primarily caused by the rapid increase in natural gas production from shale formations.

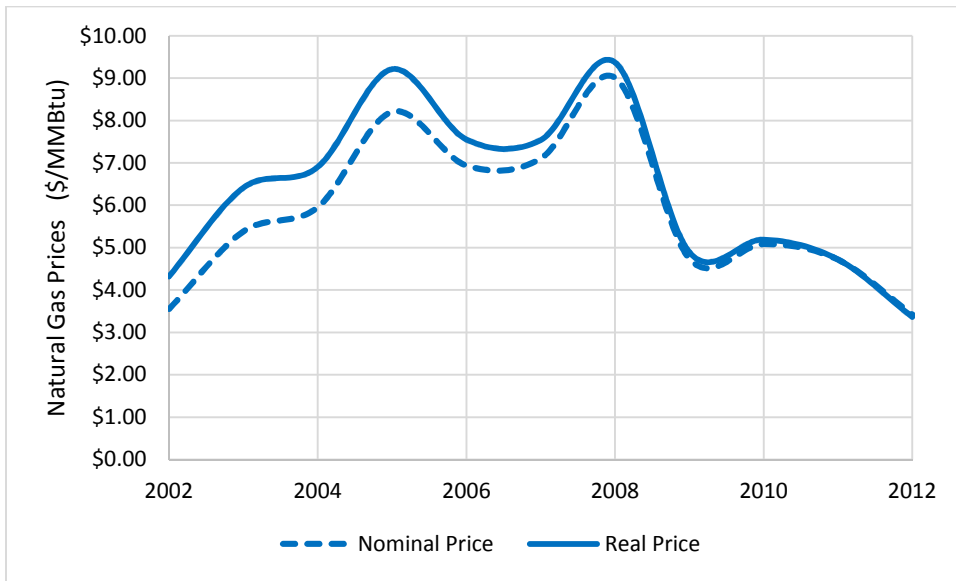

Figure 2-22. Relative Change Nominal and Real (2011\$) Prices of Natural Gas Delivered to the Power Sector (\$/MMBtu)

Source: <http://www.eia.gov/totalenergy/data/monthly/#prices>. Downloaded 2/15/2015.

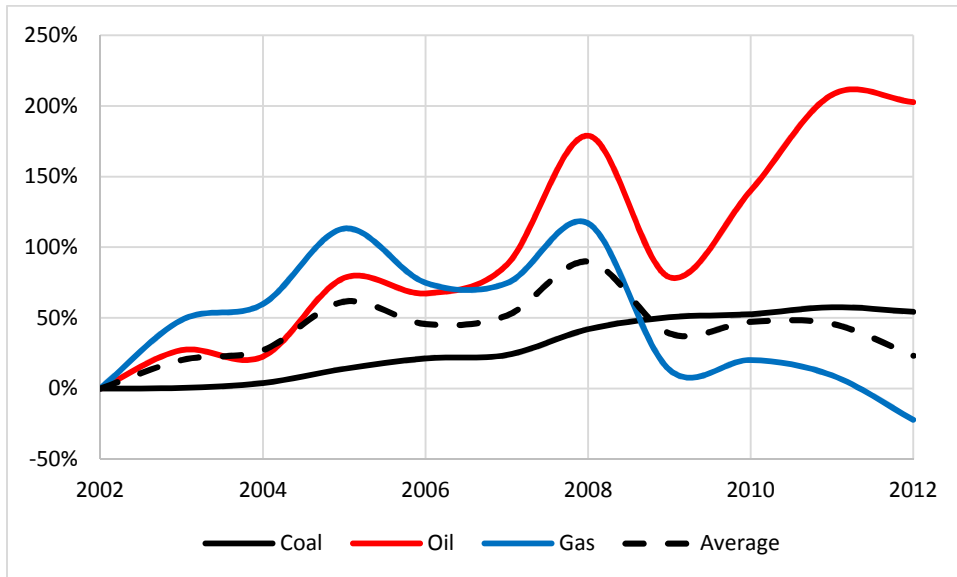

Figure 2-23. Relative Change in Real (2011\$) Prices of Fossil Fuels Delivered to the Power Sector (\$/MMBtu)

Source: <http://www.eia.gov/totalenergy/data/monthly/#prices>. Downloaded 2/15/2015.

Current and projected natural gas prices are considerably lower than the prices observed over the past decade, largely due to advances in hydraulic fracturing and horizontal drilling techniques that have opened up new shale gas resources and substantially increased the supply of economically recoverable natural gas. According to AEO 2012 (EIA 2012):

Shale gas refers to natural gas that is trapped within shale formations. Shales are fine-grained sedimentary rocks that can be rich sources of petroleum and natural gas. Over the past decade, the combination of horizontal drilling and hydraulic fracturing has allowed access to large volumes of shale gas that were previously uneconomical to produce. The production of natural gas from shale formations has rejuvenated the natural gas industry in the United States.

The U.S. Energy Information Administration's Annual Energy Outlook 2014 estimates that the United States possessed 2,266 trillion cubic feet (Tcf) of technically recoverable dry natural gas resources as of January 1, 2012. Proven reserves make up 15 percent of the technically

recoverable total estimate, with the remaining 85 percent from unproven reserves. Natural gas from proven and unproven shale resources accounts for 611 Tcf of this resource estimate.

Many shale formations, especially the Marcellus⁵², are so large that only small portions of the entire formations have been intensively production-tested. Furthermore, estimates from the Marcellus and other emerging fields with few wells already drilled are likely to shift significantly over time as new geological and production information becomes available. Consequently, there is some uncertainty in the estimate of technically recoverable resources, and it is regularly updated as more information is gained through drilling and production.

At the 2012 rate of U.S. consumption (about 25.6 Tcf per year), 2,266 Tcf of natural gas is enough to supply nearly 90 years of use. The AEO 2014 estimate of the shale gas resource base is modestly higher than the AEO 2012 estimate (2,214 Tcf) of shale gas production, driven by lower drilling costs and continued drilling in shale plays with high concentrations of natural gas liquids and crude oil, which have a higher value in energy equivalent terms than dry natural gas.⁵³

EIA's projections of natural gas conditions did not change substantially in AEO 2014 from either the AEO 2012 or 2013, and EIA continues to forecast abundant reserves consistent with the above findings. Recent historical data reported to EIA is also consistent with these trends, with 2014 being the highest year on record⁵⁴ for domestic natural gas production.⁵⁵

⁵² The Marcellus formation, underlying most of Pennsylvania and West Virginia, along with portions of New York and Ohio, in 2014 produced 36% of the U.S. total natural gas extracted from shale formations.

⁵³ For more information, see: http://www.eia.gov/forecasts/archive/aeo11/IF_all.cfm#prospectshale;
http://www.eia.gov/energy_in_brief/about_shale_gas.cfm

⁵⁴ The total dry gas production in 2012 from the lower 48 states, including both onshore and offshore production, was 23.97 Tcf, a 1.5% increase from 2013 and a 7.9% total increase from 2011

⁵⁵ <http://www.eia.gov/oiaf/aeo/tablebrowser/#release=AEO2014&subject=8-AEO2014&table=72-AEO2014®ion=0-0&cases=ref2014-d102413a>

2.10 References

- Advanced Resources International. 2011. *Improving Domestic Energy Security and Lowering CO₂ Emissions with “Next Generation” CO₂-Enhanced Oil Recovery (CO₂-EOR)*. Available online at: <http://www.netl.doe.gov/research/energy-analysis/publications/details?pub=df02ffba-6b4b-4721-a7b4-04a505a19185>. Accessed June 9, 2015.
- Clean Energy States Alliance (CESA). *The State of State Renewable Portfolio Standards*. June 2013. Available online at <http://www.cesa.org/assets/2013-Files/RPS/State-of-State-RPSs-Report-Final-June-2013.pdf>
- Han, Weon S., McPherson, B J., Lichtner, P C., and Wang, F P. 2010. Evaluation of CO₂ trapping mechanisms at the SACROC northern platform, Permian basin, Texas, site of 35 years of CO₂ injection. *American Journal of Science* 310: 282-324.
- Independent Monitor’s Prudency Evaluation Report for the Kemper County IGCC Project. April 15, 2014. Available online at: http://www.psc.state.ms.us/InsiteConnect/InSiteView.aspx?model=INSITE_CONNECT&queue=CTS_ARCHIVEQ&docid=328417.
- Interagency Task Force on Carbon Capture and Storage. *Report of the Interagency Task Force on Carbon Capture and Storage*. August 2010. Available online at: <http://www.epa.gov/climatechange/downloads/CCS-Task-Force-Report-2010.pdf>. Accessed June 9, 2015.
- Intergovernmental Panel on Climate Change. 2001. *Climate Change 2001: The Scientific Basis*. Available online at: http://www.grida.no/publications/other/ipcc_tar/?src=/climate/ipcc_tar/wg1/218.htm. Accessed June 9, 2015.
- International Energy Agency (IEA). 2013. *Tracking Clean Energy Progress 2013*. Input to the Clean Energy Ministerial. Available online at: <http://www.iea.org/etp/tracking/>. Accessed June 9, 2015.
- Koottungal, Leena. 2014. *2014 Worldwide EOR Survey*, Oil & Gas Journal, Volume 112, Issue 4, April 7, 2014 (corrected tables appear in Volume 112, Issue 5, May 5, 2014).
- National Energy Technology Laboratory (NETL). 2008. *Reducing CO₂ Emissions by Improving the Efficiency of Existing Coal-fired Power Plant Fleet*. Available online at <http://www.netl.doe.gov/energy-analyses/pubs/CFPP%20Efficiency-FINAL.pdf>. Accessed June 9, 2015.

- National Energy Technology Laboratory (NETL). 2012. *The United States 2012 Carbon Utilization and Storage Atlas, Fourth Edition*. Available online at: http://www.netl.doe.gov/technologies/carbon_seq/refshelf/atlasIV/. Accessed June 9, 2015.
- National Energy Technology Laboratory (NETL). 2013. *Energy Analyses: Cost and Performance Baselines for Fossil Energy Plants*. Available online at: http://www.netl.doe.gov/energy-analyses/baseline_studies.html. Accessed June 9, 2015.
- Pacific Northwest National Laboratory (PNNL). 2009. *An Assessment of the Commercial Availability of Carbon Dioxide Capture and Storage Technologies as of June 2009*. Available online at: http://www.pnl.gov/science/pdf/PNNL-18520_Status_of_CCS_062009.pdf. Accessed June 9, 2015.
- U.S. Energy Information Administration (U.S. EIA). 2000. *Carbon Dioxide Emissions from the Generation of Electric Power in the United States*. Available online at: <ftp://ftp.eia.doe.gov/environment/co2emiss00.pdf>. Accessed June 9, 2015.
- U.S. Energy Information Administration (U.S. EIA). 2003. *Electric Power Annual 2003*. Available online at: <http://www.eia.gov/electricity/annual/archive/03482003.pdf>. Accessed June 9, 2015.
- U.S. Energy Information Administration (U.S. EIA). 2009. *Electric Power Annual 2009*. Available online at: <http://www.eia.gov/electricity/annual/archive/03482009.pdf>. Accessed June 9, 2015.
- U.S. Energy Information Administration (U.S. EIA). 2013. *Electric Power Annual 2013*. Available online at: <http://www.eia.gov/electricity/annual/>. Accessed June 9, 2015.
- U.S. Energy Information Administration (U.S. EIA). 2010a. "Status of Electricity Restructuring by State." Available online at: http://www.eia.gov/cneaf/electricity/page/restructuring/restructure_elect.html. Accessed June 9, 2015.
- U.S. Energy Information Administration (U.S. EIA). 2010b. *AEO 2010 Retrospective Review*. Available online at: <http://www.eia.gov/forecasts/aeo/retrospective/>. Accessed June 9, 2015.
- U.S. Energy Information Administration (U.S. EIA). 2010c. *Annual Energy Outlook 2010*. Available online at: <http://www.eia.gov/oiaf/archive/aeo10/index.html>. Accessed June 9, 2015.
- U.S. Energy Information Administration (U.S. EIA). 2010d. *Annual Energy Review 2010*. Available online at: <http://www.eia.gov/totalenergy/data/annual/pdf/aer.pdf>. Accessed June 9, 2015.

- U.S. Energy Information Administration (U.S. EIA). 2011. *Annual Energy Outlook 2011*. Available online at: <http://www.eia.gov/forecasts/archive/aeo11/>. Accessed June 9, 2015.
- U.S. Energy Information Administration (U.S. EIA). 2012. *Annual Energy Outlook 2012 (Early Release)*. Available online at: <http://www.eia.gov/forecasts/aeo/>. Accessed June 9, 2015.
- U.S. Energy Information Administration (U.S. EIA). *Today in Energy: Most states have Renewable Portfolio Standards*. 2012a. Available online at: <http://www.eia.gov/todayinenergy/detail.cfm?id=4850>. Accessed June 9, 2015.
- U.S. Energy Information Administration (U.S. EIA). 2013. *Annual Energy Outlook 2013*. Available online at: <http://www.eia.gov/forecasts/aeo/>. Accessed June 9, 2015.
- U.S. Energy Information Administration (U.S. EIA). 2015. *Monthly Energy Review, April 2015*. Available online at: <http://www.eia.gov/totalenergy/data/monthly/>. Accessed June 9, 2015.
- U.S. Environmental Protection Agency (U.S. EPA). 2013. *Inventory of U.S. Greenhouse Gas Emissions and Sinks: 1990–2011*. Available online at: <http://www.epa.gov/climatechange/Downloads/ghgemissions/US-GHG-Inventory-2013-Main-Text.pdf>. Accessed June 9, 2015.
- U.S. Geological Survey (USGS) Carbon Dioxide Storage Resources Assessment Team. 2013. *National assessment of geologic carbon dioxide storage resources – Results: U.S. Geological Survey Circular 1386*. Available online at: <http://pubs.usgs.gov/circ/1386/>. Accessed June 9, 2015

CHAPTER 3: COST, EMISSIONS, ECONOMIC, AND ENERGY IMPACTS

3.1 Introduction

This chapter reports the compliance cost, emissions, economic, and energy impact analysis performed for the Clean Power Plan Final Rule. EPA used the Integrated Planning Model (IPM), developed by ICF International, to conduct most of the analysis discussed in this Chapter. IPM is a dynamic linear programming model that can be used to examine air pollution control policies for CO₂, SO₂, NO_x, Hg, HCl, and other air pollutants throughout the contiguous United States for the entire power system. The IPM electricity demand projections are based on projections from the Energy Information Administration (EIA), adjusted for demand-side energy efficiency measures that can be reasonably anticipated to occur under the Clean Power Plan.

3.2 Overview

This chapter of the RIA presents illustrative analyses of the final rule by making assumptions about the possible approaches that States might pursue as they develop their state plans. Over the last decade, EPA has conducted extensive analyses of regulatory actions affecting the power sector. These efforts support the Agency's understanding of key variables that influence the effects of a policy and provide the framework for how the Agency estimates the costs and benefits associated with its actions.

3.3 Power Sector Modelling Framework

The Integrated Planning Model (IPM), developed by ICF Consulting, is a state-of-the-art, peer-reviewed, dynamic linear programming model that can be used to project power sector behavior under future business-as-usual conditions and examine prospective air pollution control policies throughout the contiguous United States for the entire electric power system. EPA used IPM to project likely future electricity market conditions with and without the Clean Power Plan Final Rule. Additional demand side energy efficiency measures that may be adopted in response to the regulation, and the resulting changes to future demand projections, are also accounted for in the analyses. The level of demand side energy efficiency-driven reductions in electricity demand, and their associated costs, are reported in section 3.7.

IPM is a multi-regional, dynamic, deterministic linear programming model of the contiguous U.S. electric power sector. It provides forecasts of least cost capacity expansion,

electricity dispatch, and emission control strategies while meeting energy demand and environmental, transmission, dispatch, and reliability constraints. EPA has used IPM for over two decades to better understand power sector behavior under future business-as-usual conditions and to evaluate the economic and emission impacts of prospective environmental policies. The model is designed to reflect electricity markets as accurately as possible. EPA uses the best available information from utilities, industry experts, gas and coal market experts, financial institutions, and government statistics as the basis for the detailed power sector modeling in IPM. The model documentation provides additional information on the assumptions discussed here as well as all other model assumptions and inputs.⁵⁶

The model incorporates a detailed representation of the fossil-fuel supply system that is used to forecast equilibrium fuel prices. The model includes an endogenous representation of the North American natural gas supply system through a natural gas module that reflects a partial supply/demand equilibrium of the North American gas market accounting for varying levels of potential power sector and non-power sector gas demand and corresponding gas production and price levels.⁵⁷ This module consists of 118 supply, demand, and storage nodes and 15 liquefied natural gas re-gasification facility locations that are tied together by a series of linkages (i.e., pipelines) that represent the North American natural gas transmission and distribution network.

IPM also endogenously models the partial equilibrium of coal supply and EGU coal demand levels throughout the contiguous U.S., taking into account assumed non-power sector demand and imports/exports. IPM reflects 36 coal supply regions, 14 coal grades, and the coal transport network, which consists of over four thousand linkages representing rail, barge, and truck and conveyer linkages. The coal supply curves in IPM were developed during a thorough bottom-up, mine-by-mine approach that depicts the coal choices and associated supply costs that power plants would face if selecting that coal over the modeling time horizon. The IPM

⁵⁶ Detailed information and documentation of EPA's Base Case using IPM (v5.15), including all the underlying assumptions, data sources, and architecture parameters can be found on EPA's website at: <http://www.epa.gov/powersectormodeling>

⁵⁷ See Chapter 10 of EPA's Base Case using IPM (v5.154) documentation, available at: <http://www.epa.gov/powersectormodeling>

documentation outlines the methods and data used to quantify the economically recoverable coal reserves, characterize their cost, and build the 36 coal regions' supply curves.⁵⁸

The costs presented in this RIA include both the IPM-projected annualized estimates of private compliance costs as well as the estimated costs incurred by utilities and ratepayers to achieve demand-side energy efficiency improvements. The IPM-projected annualized estimates of private compliance costs provided in this analysis are meant to show the increase in production (generating) costs to the power sector in response to the final rule.

To estimate these annualized costs, EPA uses a conventional and widely accepted approach that applies a capital recovery factor (CRF) multiplier to capital investments and adds that to the annual incremental operating expenses. The CRF is derived from estimates of the cost of capital (private discount rate), the amount of insurance coverage required, local property taxes, and the life of capital.⁵⁹ It is important to note that there is no single CRF factor applied in the model; rather, the CRF varies across technologies in the model in order to better simulate power sector decisionmaking.

While the CRF is used to annualize costs within IPM, a discount rate is used to estimate the net present value of the intertemporal flow of the annualized capital and operating costs. The optimization model then identifies power sector investment decisions that minimize the net present value of all costs over the full planning horizon while satisfying a wide range of demand, capacity, reliability, emissions, and other constraints. As explained in Chapter 8 of the IPM documentation, the discount rate is derived as a weighted average cost of capital that is a function of capital structure, post-tax cost of debt, and post-tax cost of equity. While the detailed formulation of this rate is presented in the IPM documentation, the rate estimated and used in the current analysis is 4.77 percent. It is important to note that this discount rate is selected for the purposes of best simulating power sector behavior, and not for the purposes of discounting social costs or benefits.

⁵⁸ See Chapter 9 of EPA's Base Case using IPM (v5.15) documentation, available at: <http://www.epa.gov/powersectormodeling>

⁵⁹ See Chapter 8 of EPA's Base Case using IPM (v5.15) documentation, available at: <http://www.epa.gov/powersectormodeling>.

EPA has used IPM extensively over the past two decades to analyze options for reducing power sector emissions. Previously, the model has been used to forecast the costs, emission changes, and power sector impacts for the Clean Air Interstate Rule, Cross-State Air Pollution Rule (CSAPR), the Mercury and Air Toxics Standards (MATS), and the proposed Carbon Pollution Standards for New Power Plants. Recently IPM has also been used to estimate the air pollution reductions and power sector impacts of water and waste regulations affecting EGUs, including Cooling Water Intakes (316(b)) Rule, Disposal of Coal Combustion Residuals from Electric Utilities (CCR) and Steam Electric Effluent Limitation Guidelines (ELG).

The model and EPA's input assumptions undergo periodic formal peer review. The rulemaking process also provides opportunity for expert review and comment by a variety of stakeholders, including owners and operators of capacity in the electricity sector that is represented by the model, public interest groups, and other developers of U.S. electricity sector models. The feedback that the Agency receives provides a highly-detailed review of key input assumptions, model representation, and modeling results. IPM has received extensive review by energy and environmental modeling experts in a variety of contexts. For example, in the late 1990s, the Science Advisory Board reviewed IPM as part of the CAA Amendments Section 812 prospective studies that are periodically conducted. The model has also undergone considerable interagency scrutiny when it was used to conduct over a dozen legislative analyses (performed at Congressional request) over the past decade. The Agency has also used the model in a number of comparative modeling exercises sponsored by Stanford University's Energy Modeling Forum over the past 15 years. IPM has also been employed by states (e.g., for RGGI, the Western Regional Air Partnership, Ozone Transport Assessment Group), other Federal and state agencies, environmental groups, and industry.

3.4 Recent Updates to EPA's Base Case using IPM (v.5.15)

The "Base Case" for this analysis is a business-as-usual scenario that would be expected under market and regulatory conditions in the absence of this rule. As such, the IPM base case represents the baseline for this RIA. EPA frequently updates the IPM base case to reflect the latest available electricity demand forecasts as well as expected costs and availability of new and existing generating resources, fuels, emissions control technologies, and regulatory requirements.

EPA's IPM modeling platform used to analyze this final rule (v.5.15) incorporates updates to the version of the model used to analyze the impacts of the proposed rule (v.5.13). These updates are primarily routine calibrations with the Energy Information Agency's (EIA) Annual Energy Outlook (AEO), including updating the electric demand forecast consistent with the AEO 2015 and an update to natural gas supply. Additional updates, based on the most up-to-date information and/or public comments received by the EPA, include unit-level specifications (e.g., pollution control configurations), planned power plant construction and closures, and updated cost and performance for onshore wind and utility-scale solar technologies. This IPM modeling platform incorporates federal and most state laws and regulations whose provisions were either in effect or enacted and clearly delineated in March 2015. This update also includes two non-air federal rules affecting EGUs: Cooling Water Intakes (316(b)) Rule and Combustion Residuals from Electric Utilities (CCR). Additionally, all new capacity projected by the model is compliant with Clean Air Act 111(b) standards, including the final standards of performance for GHG emissions from new sources. For a detailed account of all updates made to the v.5.15 modeling platform, see the Incremental Documentation for EPA Base Case v.5.15 Using IPM.⁶⁰

EPA also updated the National Electric Energy Data System (NEEDS). This database contains the unit-level data that is used to construct the "model" plants that represent existing and committed units in EPA modeling applications of IPM. NEEDS includes detailed information on each individual EGU, including geographic, operating, air emissions, and other data on every generating units in the contiguous U.S.⁶¹

3.5 State Goals in this Final Rule

In this final rule, the EPA is establishing CO₂ emission performance rates for two categories of existing fossil fuel-fired EGUs, fossil fuel-fired electric utility steam generating units and stationary combustion turbines. The EPA has translated the source category-specific CO₂ emission performance rates into state-level rate-based and mass-based CO₂ goals in order to expand the range of choices that states have in developing their plans. Due to the range of choices available to states, and the lack of *a priori* knowledge about the specific choices states

⁶⁰ Available at: <http://www.epa.gov/powersectormodeling/>

⁶¹ The NEEDS database can be found on the EPA's website for the Base Case using IPM (v5.15), <<http://www.epa.gov/powersectormodeling> >.

will make in response to the final goals, this RIA presents two scenarios designed to achieve these goals, which we term the “rate-based” illustrative plan approach and the “mass-based” illustrative plan approach. Table 3-1 presents the rate-based and mass-based state goals.

Table 3-1. Statewide CO₂ Emission Performance Goals, Rate-based and Mass-based

State	Rate-Based (Adjusted Output-Weighted-Average Pounds of CO ₂ Per Net MWh From All Affected Fossil Fuel-Fired EGUs)		Mass-Based (Adjusted Output-Weighted-Average Short Tons of CO ₂ From All Affected Fossil Fuel-Fired EGUs)	
	Interim Goal	Final Goal	Interim Goal	Final Goal
Alabama	1,157	1,018	62,210,288	56,880,474
Arkansas	1,304	1,130	33,683,258	30,322,632
Arizona	1,173	1,031	33,061,997	30,170,750
California	907	828	51,027,075	48,410,120
Colorado	1,362	1,174	33,387,883	29,900,397
Connecticut	852	786	7,237,865	6,941,523
Delaware	1,023	916	5,062,869	4,711,825
Florida	1,026	919	112,984,729	105,094,704
Lands of the Fort Mojave Tribe	832	771	611,103	588,519
Georgia	1,198	1,049	50,926,084	46,346,846
Iowa	1,505	1,283	28,254,411	25,018,136
Idaho	832	771	1,550,142	1,492,856
Illinois	1,456	1,245	74,800,876	66,477,157
Indiana	1,451	1,242	85,617,065	76,113,835
Kansas	1,519	1,293	24,859,333	21,990,826
Kentucky	1,509	1,286	71,312,802	63,126,121
Louisiana	1,293	1,121	39,310,314	35,427,023
Massachusetts	902	824	12,747,677	12,104,747
Maryland	1,510	1,287	16,209,396	14,347,628
Maine	842	779	2,158,184	2,073,942
Michigan	1,355	1,169	53,057,150	47,544,064
Minnesota	1,414	1,213	25,433,592	22,678,368
Missouri	1,490	1,272	62,569,433	55,462,884
Mississippi	1,061	945	27,338,313	25,304,337
Montana	1,534	1,305	12,791,330	11,303,107
Lands of the Navajo Nation	1,534	1,305	24,557,793	21,700,587
North Carolina	1,311	1,136	56,986,025	51,266,234
North Dakota	1,534	1,305	23,632,821	20,883,232
Nebraska	1,522	1,296	20,661,516	18,272,739
New Hampshire	947	858	4,243,492	3,997,579
New Jersey	885	812	17,426,381	16,599,745
New Mexico	1,325	1,146	13,815,561	12,412,602

State	Rate-Based (Adjusted Output-Weighted-Average Pounds of CO ₂ Per Net MWh From All Affected Fossil Fuel-Fired EGUs)		Mass-Based (Adjusted Output-Weighted-Average Short Tons of CO ₂ From All Affected Fossil Fuel-Fired EGUs)	
	Interim Goal	Final Goal	Interim Goal	Final Goal
Nevada	942	855	14,344,092	13,523,584
New York	1,025	918	33,595,329	31,257,429
Ohio	1,383	1,190	82,526,513	73,769,806
Oklahoma	1,223	1,068	44,610,332	40,488,199
Oregon	964	871	8,643,164	8,118,654
Pennsylvania	1,258	1,095	99,330,827	89,822,308
Rhode Island	832	771	3,657,385	3,522,225
South Carolina	1,338	1,156	28,969,623	25,998,968
South Dakota	1,352	1,167	3,948,950	3,539,481
Tennessee	1,411	1,211	31,784,860	28,348,396
Texas	1,188	1,042	208,090,841	189,588,842
Lands of the Uintah and Ouray Reservation	1,534	1,305	2,561,445	2,263,431
Utah	1,368	1,179	26,566,380	23,778,193
Virginia	1,047	934	29,580,072	27,433,111
Washington	1,111	983	11,679,707	10,739,172
Wisconsin	1,364	1,176	31,258,356	27,986,988
West Virginia	1,534	1,305	58,083,089	51,325,342
Wyoming	1,526	1,299	35,780,052	31,634,412

3.6 Illustrative Plan Approaches Analyzed

To estimate the costs, benefits, and economic and energy market impacts of implementing the CPP guidelines, the EPA modeled two illustrative plan approaches, each at the state level, based on a rate-based approach and a mass-based approach. The rate-based plan approach requires affected sources in each state to achieve a single average emissions rate in each period as represented by the statewide goals. The mass-based plan approach requires affected sources in each state to limit their aggregate emissions not to exceed the mass goal for that state. The two plan types in these illustrative analyses represent two types of plans that are available to the states.

In each of these scenarios, affected EGUs include:

- Existing fossil steam boilers with nameplate capacity greater than 25 MW
- Existing NGCC units with nameplate capacity greater than 25 MW

In the rate-based scenario, generation (or avoided generation) from these additional sources represented in the model is counted toward meeting state goals:

- All renewable capacity (hydro, solar PV, wind, geothermal) that comes online after 2012
- Under-construction nuclear⁶²
- Demand-side energy efficiency in addition to levels implicit in base case electricity demand.

In the rate-based illustrative plan approach analyzed in this RIA, the affected EGUs within each state are required to achieve an average emissions rate that is less than or equal to the state goals for each state. In order to meet the goal for each state, the affected sources in this scenario have the ability to do one or both of the following:

- 1) generate in amounts within that state such that the average emissions rate is achieved, and/or
- 2) include in the average emissions rate calculation new renewable generation or demand-side energy efficiency located outside of the state but within each of the illustrative Interconnection-based regions shown in Figure 3-1 below.⁶³

⁶² Includes three nuclear facilities at which construction has already commenced: Watts Barr (TN), Vogtle (GA), and Summer (SC)

⁶³ In this illustrative scenario, energy efficiency/renewable energy procurement is limited to within one of the three illustrative regions. Since the interconnections do not always follow state borders, certain states that fall into more than one region were grouped in regions where there was a majority of geographic territory (area) or generation. Depending on the elements of their respective state's plan, sources in states that have adopted certain rate-based plans may be able to procure energy efficiency/renewable energy from states outside of these illustrative regions. See the preamble for discussion.

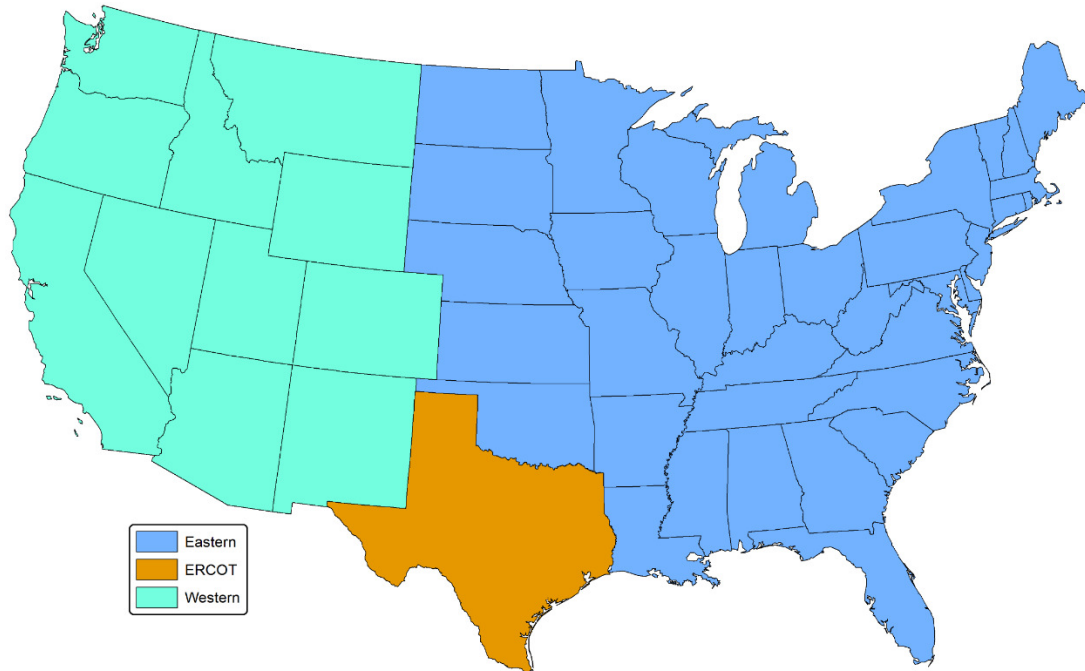

Figure 3-1. Illustrative Regions for Demand-Side Energy Efficiency/Renewable Energy Procurement Used in this Analysis

This rate-based implementation plan approach enables some sources to emit at emission rates higher than their applicable state goal, as long as there is either corresponding generation coming from affected sources in that state that emit at a lower rate and/or generation (or avoided generation) from energy efficiency/renewable energy (which is procured from within the illustrative regions, including within the source’s state). In this illustrative analysis affected EGUs may not procure emission reductions from (e.g., by averaging their emissions with) affected EGUs located in other states (which may also have different emission performance standards) in order to demonstrate compliance. Furthermore in this rate-based scenario, specific generation (or avoided generation) from energy efficiency/renewable energy procurement may only be used once for compliance toward a state goal; in other words, while emitting sources in all states may avail themselves of qualifying energy efficiency/renewable energy across the illustrative region, no particular energy efficiency/renewable energy MWh can be claimed by more than one emitter as part of reaching a state goal.

Each illustrative plan approach assumes identical levels of demand-side energy efficiency megawatt-hour (MWh) demand reductions and associated costs, which are specified exogenously and consistent with the energy efficiency plan scenario performance levels

described in section 3.7. Details of the implementation of the demand reduction are reported in the following section.

The mass-based scenario presented in this chapter includes a 5 percent set-aside of allowances that would be allocated to recognize deployment of new renewable capacity, which is represented by lowering the capital cost of new renewable capacity in a compliance period by the estimated value of the allowances in the set-aside in that period. The value of the set-aside is estimated in each model run year (i.e., simulated year in IPM) as the total allowances in the set-asides of each state in the contiguous U.S. multiplied by the projected average allowance price over the contiguous U.S. for that year. This total value is then assumed to apply evenly to all new renewable capacity.

Each of the two illustrative plan approaches assumes that sources within each state comply with the applicable state goals without exchanging a compliance instrument (ERC or allowance) with sources in any other state. However, in the rate-based scenario, sources are allowed to procure renewable energy or demand-side energy efficiency beyond their own state in order to adjust their effective emission rate, which is consistent with the conditions for rate-based implementation in any state that are described in section VIII of the preamble.⁶⁴ For example, while the final rule enables states to achieve their mass goals with the flexibility of interstate trading, this RIA presents analysis is an illustrative plan approach that assumes that each state achieves its goal independently. Cooperation between the states that allows for trading across states would provide EGUs with additional low cost abatement opportunities and would therefore lower the overall cost of compliance across the affected states. While the illustrative plan approaches assume particular plan types that may limit compliance options available to affected EGUs, the equilibrium effects on generation, emissions, etc., in a particular state that are forecast in these analyses depend on the behavior of generators in neighboring states in response to the regulation.

The full array of estimates for the benefits, costs, and economic impacts of this action are presented for both the illustrative rate-based and mass-based plan approaches. These illustrative plan approaches are designed to reflect, to the extent possible, the scope and nature of the CPP

⁶⁴ In this modeling scenario, sources were only able to procure such RE and EE within the same interconnection-based region, while the rule does not impose a regional limitation to such claims in rate-based compliance.

guidelines. However, there is considerable uncertainty with regard to the regulatory form and precise measures that states will adopt to meet the requirements, since there are considerable flexibilities afforded to the states in developing state plans. Nonetheless, the analysis of the benefits, costs, and relevant impacts of the rule attempts to encapsulate some of those flexibilities in order to inform states and stakeholders of the potential overall impacts of the CPP.

It is also important to note that the analysis does not specify any particular CO₂ reduction measure to occur, with the exception of the level of demand-side energy efficiency assumed to be adopted in response to the CPP. In other words, aside from investments in energy efficiency, the analysis allows the power system the flexibility to respond to average emissions rate or mass constraints on affected sources in the illustrative scenarios to achieve the goals in the most cost-effective manner determined by IPM, as specified below. Additionally, there are other zero-emitting alternatives to replacing fossil generation beyond the renewable generation technologies that are part of building block 3 and the energy efficiency measures that were analyzed in these scenarios. For instance, while costs would be different, the impact of distributed zero-emitting generation such as residential and commercial solar would displace fossil generation in the same way that demand side energy efficiency would.

While IPM produces a cost-minimizing solution to achieve the state goals imposed in the illustrative scenarios, there may be yet lower-cost approaches that the states may adopt to achieve their state goals inasmuch as states and sources take advantage of emission reduction opportunities in practice, and flexibilities afforded under the final rule, that are not represented in this analysis and would yield different cost and emissions outcomes.

As previously noted, the power sector modeling and analysis presented in this chapter is intended to be illustrative in nature, and reflects the EPA's best assessment of likely impacts of the CPP under a range of approaches that states may adopt. The modeling is designed to reflect the rule's requirements, including the timing, applicability to sources, and flexibilities across the power system as accurately as possible to represent the nature and scope of the CPP. The analysis is a reasonable expectation of the incremental effects of the rule, and is consistent with past EPA analyses of power sector regulatory requirements. The EPA has separately analyzed and considered the cost of implementing the emission reduction measures in BSER, which do

not rely on energy efficiency measures. For this analysis, see section V.A.4.d. of the preamble to this final rule.

For the CPP, the analysis and projections for the year 2025 reflect the impacts across the power system of complying with the interim goals, and the analysis and projections for 2030 reflect the impacts of complying with the final goals. In addition to the 2025 and 2030 projections, modeling results and projections are also shown for 2020. There is no regulatory requirement reflected in the 2020 run-year in IPM, consistent with the final rule. These years reflect the basic run-year structure in IPM, as configured by EPA.

Although the analysis of the CPP does not include estimates of the costs and benefits of the CPP across each year of the rule in a year-by-year manner, the EPA has reflected the structure of the rule, including the interim and the final state goals of the CPP, in a manner that is consistent with the regulatory requirements. This is also consistent with past practice, including analysis of the Clean Air Interstate Rule, the Cross State Air Pollution Rule, the NO_x SIP Call, the Acid Rain Program, National Ambient Air Quality Standards, and state rules. These past regulatory and legislative efforts included modeling and analysis in a similar manner, where select analytic years reflected projections of policy impacts for rules that include multi-year compliance periods.

3.7 Demand-Side Energy Efficiency

3.7.1 Demand-Side Energy Efficiency Improvements (Electricity Demand Reductions)⁶⁵

While the final rule no longer includes demand-side energy efficiency potential as part of BSER, the rule does allow such potential to be used for compliance. These scenarios include a representation of demand-side energy efficiency compliance potential because energy efficiency is a highly cost-effective means for reducing CO₂ from the power sector, and it is reasonable to assume that a regulatory requirement to reduce CO₂ emissions will motivate parties to pursue all highly cost-effective means for making emission reductions accordingly, regardless of what particular emission reduction measures were assumed in determining the level of that regulatory requirement. The EPA has included in our illustrative plan scenarios (both rate- and mass-based)

⁶⁵ For a more detailed discussion of the demand-side energy efficiency demand reductions and their associated costs, refer to U.S. EPA. 2015. Technical Support Document (TSD) the Final Carbon Pollution Emission Guidelines for Existing Stationary Sources: Electric Utility Generating Units. Demand-Side Energy Efficiency.

a level of demand reduction that could be achieved, and the associated costs incurred, through implementation of demand-side energy efficiency measures. This “demand-side energy efficiency plan scenario” represents a level of performance that has already been demonstrated or is required by policies (e.g., energy efficiency resource standards) of leading energy efficiency implementing states, and is consistent with a demonstrated or required annual pace of performance improvement over time. The resulting levels of demand reduction are consistent with recent studies of achievable demand reduction potential conducted throughout the U.S. For these reasons, the demand-side energy efficiency plan scenario represents a reasonable assumption about the level of demand-side energy efficiency investments that may be encouraged in response to the final CPP.

For the illustrative demand-side energy efficiency plan scenario, electricity demand reductions for each state for each year are developed by ramping up from a historical basis⁶⁶ to a target annual incremental demand reduction rate of 1.0 percent of electricity demand over a period of years starting in 2020, and maintaining that rate throughout the modeling horizon.⁶⁷ Nineteen leading states either have achieved, or have established requirements that will lead them to achieve, this rate of incremental electricity demand reduction on an annual basis. Based on historic performance and existing state requirements, for each state the pace of improvement from the state’s historical incremental demand reduction rate is set at 0.2 percent per year, beginning in 2020, until the target rate of 1.0 percent is achieved. States already at or above the 1.0 percent target rate are assumed to achieve a 1.0 percent rate beginning in 2020 and sustain that rate thereafter.⁶⁸ The incremental demand reduction rate for each state, for each year, is used to derive cumulative annual electricity demand reductions based upon information about the average life of energy efficiency measures and the distribution of measure lives across energy

⁶⁶ The historical basis of the percentage of reduced electricity consumption differs for each state and is drawn from the data reported in Energy Information Administration (EIA) Form 861, 2013, available at <http://www.eia.gov/electricity/data/eia861/>.

⁶⁷ The incremental demand reduction percentage is applied to the previous year’s electricity demand for the state.

⁶⁸ This assumption may result in underestimating electricity demand reductions in these states in the illustrative plan scenarios.

efficiency programs.⁶⁹ The cumulative annual electricity demand reduction derived using this methodology is used to adjust base case electricity demand levels in the illustrative plan approach modeling.

To reflect the implementation of the illustrative energy efficiency plan scenario in modeling, the IPM base case electricity demand was adjusted exogenously to reflect the estimated future-year demand reductions calculated as described above. State-level demand reductions were scaled up to account for transmission losses and applied to base case generation demand in each model year to derive adjusted demand for each state, reflecting the energy efficiency plan scenario energy reductions. The demand adjustments were applied proportionally across all segments (peak and non-peak) of the load duration curve.⁷⁰ To reflect the adjusted state-level demand within IPM model regions that cross state borders, energy reductions from a bisected state were distributed between the applicable IPM model regions using a distribution approach based on reported sales in 2013 as a proxy for the distribution of energy efficiency investment opportunities.

Table 3-2 summarizes the results of the illustrative demand-side energy efficiency plan scenario at the national level.

Table 3-2. Demand-Side Energy Efficiency Plan Scenario: Net Cumulative Demand Reductions [Contiguous U.S.] (GWh and as Percent of BAU Sales)

	2020	2025	2030
Net Cumulative Demand Reduction (GWh)	23,150	194,126	327,092
Net Cumulative Demand Reduction as Percent of BAU Sales	0.59%	4.81%	7.83%

Source: U.S. EPA. 2015. Technical Support Document (TSD) for the Final Carbon Pollution Emission Guidelines for Existing Stationary Sources: Electric Utility Generating Units. Demand-Side Energy Efficiency.

⁶⁹ The average life of demand-side energy efficiency measures used is 10.2 years. This average is represented using a four-tier distribution of measure lives ranging from 6.5 to 21.2 years. This approach is based on 2015 analysis by Lawrence Berkeley National Laboratory and is discussed in detail in section 8.2.6 of the Demand-Side Energy Efficiency TSD.

⁷⁰ Details and reasoning for this assumption are included in U.S. EPA. 2015. Technical Support Document (TSD) for the Final Carbon Pollution Emission Guidelines for Existing Stationary Sources: Electric Utility Generating Units. Demand-Side Energy Efficiency.

3.7.2 Demand-Side Energy Efficiency Costs⁷¹

Total costs of achieving the demand-side energy efficiency plan scenario for each year were calculated exogenous to the power sector modeling. The power system cost impacts resulting from the illustrative plan approach analyses were captured within IPM and include the effects of reduced demand levels driven by the energy efficiency scenario discussed above. The integration of the exogenously calculated demand-side energy efficiency scenario costs with the power system cost impacts of the illustrative plan approaches are discussed in section 3.9.2. In addition to the demand reduction results, the demand-side energy efficiency costs were based upon an estimate of the total first-year cost of saved energy (i.e., reduced demand), the average life of the demand-side energy efficiency measures, the distribution of those measure lives, and cost factors as greater levels of demand reductions are achieved. The total first-year cost of saved energy accounts for both the costs of the demand-side energy efficiency programs, known as the program costs, and the additional cost to electricity consumers participating in the program (e.g., purchasing a more energy efficient technology), known as the participant costs.

To calculate total annualized demand-side energy efficiency costs, first-year costs for each year for each state were levelized (at 3 percent and 7 percent discount rates) over the estimated distribution of measure lives and the results summed for each year for each state. For example, the 2025 estimate of annualized energy efficiency cost includes levelized value of first-year costs for energy efficiency investments made in 2020 through 2025. The annualized costs rise in each analysis year as additional first-year costs are incurred. The annualized cost results are summarized below in Table 3-3. The total levelized cost of saved energy was calculated based upon the same inputs and using a 3 percent discount rate resulted in national average values of 9.2 cents per kWh in 2020, 8.6 cents per kWh in 2025, and 8.1 cents per kWh in 2030.

Table 3-3. Annualized Cost of Demand-Side Energy Efficiency Plan Scenario (at discount rates of 3 percent and 7 percent, billions 2011\$)

Discount Rate	2020	2025	2030
at 3 percent	2.1	16.7	26.3
at 7 percent	2.6	20.6	32.5

Source: U.S. EPA. 2015. Technical Support Document (TSD) the Final Carbon Pollution Emission Guidelines for Existing Stationary Sources: Electric Utility Generating Units. Demand-Side Energy Efficiency.

⁷¹ For a more detailed discussion of the demand-side energy efficiency cost analysis, refer to the Demand-Side Energy Efficiency TSD.

The funding for demand-side energy efficiency programs (to cover program costs) is typically collected through a standard per kWh surcharge to the ratepayer; the regional retail price impacts analyzed from this RIA's illustrative plan approaches assumes the recovery of these program costs through the following procedure.⁷² For each state, the first-year energy efficiency program costs are calculated for each year. These costs were distributed between the applicable IPM regions using an approach based on reported sales in 2012 as a proxy for the distribution of energy efficiency investment opportunities. These regionalized energy efficiency program costs were then incorporated into the regional retail price calculation as discussed in section 3.9.9.⁷³ The U.S. EPA's Demand-Side Energy Efficiency Technical Support Document (U.S. EPA 2015) provides complete details on the calculations of annualized costs and first-year costs as well as comprehensive results (by state, by year) for the illustrative demand-side energy efficiency plan scenario.

3.8 Monitoring, Reporting, and Recordkeeping Costs

EPA projected monitoring, reporting and recordkeeping costs for both state entities and affected EGUs for the compliance years 2020, 2025, and 2030. In calculating the costs for state entities, EPA estimated personnel costs to oversee compliance, and review and report annually to EPA on program progress relative to meeting the state's reduction goal. To calculate the national costs, EPA estimated that 47 states and 1,028 facilities would be affected.

The EPA estimated that the majority of the cost to EGUs would be in calculating net energy output, which is needed whether the state plan utilizes a rate-based or a mass-based limit. Since the majority of EGUs do have some energy usage meters or other equipment available to them, EPA believes a new system for calculating net energy output is not needed. Under the final guidelines, states are required to use monitoring and reporting requirements for their affected EGUs to ensure that the sources are meeting the appropriate CO₂ emission performance rates or emission goals.

⁷² The full retail price analysis method is discussed in section 3.7.9 of this chapter.

⁷³ The effect on equilibrium supply and demand of electricity due to changing retail rates to fund energy efficiency programs is not captured in the IPM modeling.

The EPA has made it a priority to streamline reporting and monitoring requirements. In this rule, the EPA is making implementation as efficient as possible for both the states and the affected EGUs by allowing state plans to utilize the current monitoring and recordkeeping requirements and pathways that have already been well established in other EPA rulemakings. For example, under the Acid Rain Program's continuous emissions monitoring, 40 CFR Part 75, the EPA has established requirements for the majority of the EGUs that would be affected by a 111(d) state plan to monitor CO₂ emissions and report that data using the Emissions Collection and Monitoring Plan System (ECMPS). Additionally since the CO₂ hourly data is already reported to the EPA's ECMPS there is no additional burden associated with the reporting of that data. Since the ECMPS pathway is already in place, the EPA will allow for states to utilize the ECMPS system to facilitate the data reporting of the additional net energy output data required under the emission guidelines. However, because the Acid Rain Program does not require net energy output to be reported, there is some additional burden (Shown in Table 3-4) in updating an affected EGUs monitoring system to be able to report the associated net energy output of an affected EGU.

The EPA estimates that it would take three working months for a technician to retrofit any existing energy meters to meet the requirements set in the state plan. Additionally EPA believes that 50 hours will be needed for each EGU operator to read the rule and understand how the facility will comply with the rule, based on an average reading rate of 100 words per minute and a projected rule word count of 300,000 words.⁷⁴ Also, after all modifications are made at a facility to measure net energy output, each EGU's Data Acquisition System (DAS) would need to be upgraded to supply the rate-based emissions value to either the state or EPA's Emissions Collection and Monitoring Plan System (ECMPS). Note the costs to develop net energy output monitoring and to upgrade each facility's DAS system are one-time costs incurred in 2020. Recordkeeping and reporting costs substantially decrease for the period 2021-2030. The projected costs for 2020, 2025, and 2030 are summarized below.

⁷⁴ According to one source, the average person can proofread at about 200 words per minute on paper and 180 words per minute on a monitor. (Source: Ziefle, M. 1988. "Effects of Display Resolution on Visual Performance." *Human Factors* 40(4):554-68). Due to the highly technical nature of the rule requirements in subpart UUUU, a more conservative estimate of 100 words per minute was used to determine the burden estimate for reading and understanding rule requirements.

In calculating the cost for states to comply, EPA estimates that each state will rely on the equivalent of two full time staff to oversee program implementation, assess progress, develop possible contingency measures, perform state plan revisions and host the subsequent public meetings if revisions are indeed needed, download data from the ECMPS for their annual reporting and develop their annual EPA report. The burden estimate was based on an analysis of similar tasks performed under the Regional Haze Program, whereby states were required to develop their list of eligible sources, draft implementation plans, revise initial drafts, identify baseline controls, identify data gaps, identify initial strategies, conduct various reviews, and manage their programs. A total estimate of 78,000 hours of labor performed by seven states over a three-year period resulted in 3,714 hours per year, per entity. Due to the nature of this final rule whereby we believe the air office and the energy office will both be involved in performing the above-mentioned tasks, we rounded up to the equivalent of two full time staff, which totaled 4,160 hours per year.⁷⁵ Table 3-4 shows estimates of the annual state and industry respondent burden and costs of reporting and recordkeeping for 2020, 2025 and 2030.

Table 3-4. Years 2020, 2025 and 2030: Summary of State and Industry Annual Respondent Burden and Cost of Reporting and Recordkeeping Requirements (2011\$)

Nationwide Totals	Total Annual Labor Burden (Hours)	Total Annual Labor Costs	Total Annualized Capital Costs	Total Annual O&M Costs	Total Annualized Costs	Total Annual Respondent Costs
State						
Year 2020	195,520	13,838,429	0	34,545	34,545	13,872,974
Year 2025	208,320	14,744,381	0	23,500	23,500	14,767,881
Year 2030	208,320	14,744,381	0	23,500	23,500	14,767,881
Industry						
Year 2020	581,848	49,959,446	0	1,532,000	1,532,500	51,491,446
Year 2025	0	0	0	0	0	0
Year 2030	0	0	0	0	0	0
Total						
Year 2020	777,368	63,797,875	0	1,566,545	1,566,545	65,364,420
Year 2025	208,320	14,744,381	0	23,500	23,500	14,767,881
Year 2030	208,320	14,744,381	0	23,500	23,500	14,767,881

⁷⁵ Renewal of the ICR for the Regional Haze Rule, Section 6(a) Tables 1 through 4 based on 7 states' burden. EPA-HQ-OAR-2003-0162-0001.

3.9 Projected Power Sector Impacts

The following sections present projected impacts from the two illustrative scenarios described above. The tables present impacts from 2020 (prior to the initial compliance year), 2025 (representative of the interim compliance period), and 2030 (representative of the final compliance period). The narrative focuses on results during the initial and final compliance periods.

3.9.1 Projected Emissions

Under the rate-based approach, EPA projects annual CO₂ reductions of 3 percent below the base case in 2020, 11 percent below the base case in 2025, and 19 percent below base case projections in 2030 (reaching 28 percent to 32 percent below 2005 emissions⁷⁶ in 2025 and 2030, respectively). For the mass-based approach, EPA projects annual CO₂ reductions of 4 percent below the base case in 2020, 12 percent below the base case in 2025 and 19 percent below base case projections in 2030 (reaching 29 percent to 32 percent below 2005 emissions⁷⁷ in 2025 and 2030, respectively).⁷⁸

Table 3-5. Projected CO₂ Emission Impacts, Relative to Base Case

	CO ₂ Emissions (million short tons)			CO ₂ Emissions: Change from Base Case (million short tons)			CO ₂ Emissions: Percent Change from Base Case		
	2020	2025	2030	2020	2025	2030	2020	2025	2030
Base Case	2,155	2,165	2,227						
Rate-based	2,085	1,933	1,812	-69	-232	-415	-3%	-11%	-19%
Mass-based	2,073	1,901	1,814	-81	-265	-413	-4%	-12%	-19%

Source: Integrated Planning Model run by EPA, 2015

⁷⁶ For purposes of these calculations, EPA has used historical CO₂ emissions from eGRID for 2005, which reports EGU emissions as 2,683 million short tons in the contiguous U.S.

⁷⁷ For purposes of these calculations, EPA has used historical CO₂ emissions from eGRID for 2005, which reports EGU emissions as 2,683 million short tons in the contiguous U.S.

⁷⁸ EPA also analyzed a mass-based scenario without any set-asides using IPM, which produced a 2030 emission reduction estimate of 31 percent, relative to 2005 levels (approximately a 1 percent erosion of emission reductions due to leakage to new sources of emissions, relative to both the mass-based scenario that includes the RE set-aside, and the rate-based scenario. This equates to approximately 24 million short tons of CO₂). The scenario can be found in the docket for the final rule, and is called “Mass-based without set-aside.”

Table 3-6. Projected CO₂ Emission Impacts, Relative to 2005

	CO ₂ Emissions (million short tons)	CO ₂ Emissions: Change from 2005 (million short tons)			CO ₂ Emissions: Percent Change from 2005		
		2005	2020	2025	2030	2020	2025
Base Case	2,683	-528	-518	-456	-20%	-19%	-17%
Rate-based	-	-598	-750	-871	-22%	-28%	-32%
Mass-based	-	-610	-782	-869	-23%	-29%	-32%

Source: Integrated Planning Model run by EPA, 2015

Under the rate-based illustrative plan approach, EPA projects a 14 percent reduction of SO₂, 13 percent reduction of NO_x, and a 11 percent reduction of mercury in 2025, and a 24 percent reduction of SO₂, 22 percent reduction of NO_x, and a 17 percent reduction of mercury in 2030. Under the mass-based illustrative plan approach, EPA projects a 15 percent reduction of SO₂, 16 percent reduction of NO_x, and a 12 percent reduction of mercury in 2025, and a 24 percent reduction of SO₂, 22 percent reduction of NO_x, and a 16 percent reduction of mercury in 2030. The projected non-CO₂ reductions are summarized below in Table 3-7.

Table 3-7. Projected Non-CO₂ Emission Impacts, 2020-2030

	Base Case	Rate-based	Mass-based	Rate-based	Mass-based
2020					
SO ₂ (thousand short tons)	1,311	1,297	1,257	-1.0%	-4.1%
NO _x (thousand short tons)	1,333	1,282	1,272	-3.8%	-4.5%
Hg (short tons)	6.6	6.4	6.4	-2.8%	-3.3%
2025					
SO ₂ (thousand short tons)	1,275	1,097	1,090	-14.0%	-14.5%
NO _x (thousand short tons)	1,302	1,138	1,100	-12.6%	-15.6%
Hg (short tons)	6.6	5.9	5.8	-10.8%	-12.2%
2030					
SO ₂ (thousand short tons)	1,314	996	1,034	-24.2%	-21.3%
NO _x (thousand short tons)	1,293	1,011	1,015	-21.8%	-21.5%
Hg (short tons)	6.8	5.6	5.8	-17.2%	-15.6%

Source: Integrated Planning Model run by EPA, 2015. For this RIA, we did not estimate changes in emissions of directly emitted particles (PM_{2.5}).

While the EPA has not quantified the climate impacts of non-CO₂ emissions changes or CO₂ emissions changes outside the electricity sector for the final emissions guidelines, the Agency has analyzed the potential changes in upstream methane emissions from the natural gas and coal production sectors that may result from the illustrative approaches examined in this

RIA. The EPA assessed whether the net change in upstream methane emissions from natural gas and coal production is likely to be positive or negative. The EPA also assessed the potential magnitude of changes relative to CO₂ emissions reductions anticipated at power plants. This assessment included CO₂ emissions from the flaring of methane, but did not evaluate potential changes in other combustion-related CO₂ emissions, such as emissions associated with drilling, mining, processing, and transportation in the natural gas and coal production sectors. This analysis found that the net upstream methane emissions from natural gas systems and coal mines and CO₂ emissions from flaring of methane will likely decrease under the final emissions guidelines. Furthermore, the changes in upstream methane emissions are small relative to the changes in direct CO₂ emissions from power plants. The projections include voluntary and regulatory activities to reduce emissions from coal mining and natural gas and oil systems, including the 2012 Oil and Natural Gas NSPS. In addition, the EPA plans to issue a proposed rule later this summer that would build on its 2012 Oil and Gas NSPS. When these standards are finalized and implemented, they would further reduce projected emissions from natural gas and oil systems. The technical details supporting this analysis can be found in the Appendix to this chapter.

3.9.2 Projected Compliance Costs

The power industry's "compliance costs" are represented in this analysis as the change in electric power generation costs between the base case and illustrative CPP scenarios, including the cost of demand-side energy efficiency programs and measures and monitoring, reporting, and recordkeeping (MR&R) costs. The system costs reflect the least cost power system outcome in which the sector employs all the flexibilities assumed in the modeling, as discussed above, and pursues the most cost-effective emission reduction opportunities in order to meet the rate- and mass-based goals, as represented in the illustrative plan scenarios. In simple terms, these costs are an estimate of the increased power industry expenditures required to meet demand projections while complying with state goals, including the total demand-side energy efficiency costs.⁷⁹ The compliance costs for the final emissions guidelines for EGUs in the contiguous U.S.

⁷⁹ The compliance costs also capture the effect of changes in equilibrium fuel prices on the expenditures of the electricity sector to serve demand.

states is forecast using IPM. The cost of demand-side energy efficiency programs assumed in the IPM analysis are reported in section 3.7.2.

EPA projects that the annual compliance cost of the rate-based illustrative plan scenario are \$2.4 billion in 2020, \$1.1 billion in 2025, and \$8.5 billion in 2030 (Table 3-8). The annual compliance cost of the mass-based illustrative plan approach are estimated to be \$1.4 billion in 2020, \$3.0 billion in 2025, and \$5.1 billion in 2030. The different patterns of incremental cost in each of these scenarios over 2020-2030 are consistent with the differences in the projected pattern of gas use and price in these scenarios. consistent with the differences in the projected pattern of gas use and price in these scenarios. The annual compliance cost is the projected additional cost of complying with the rule in the year analyzed and reflects the net difference in the sum of the annualized cost of capital investment in new generating sources and heat rate improvements at coal steam facilities,⁸⁰ the change in the ongoing costs of operating pollution controls, the change in expenditures on various fuels (inclusive of changes in the price of these fuels), demand-side energy efficiency measures, and other actions associated with compliance. Relative to the base case, we expect a decrease in the total cost to generate sufficient supply for demand, which, together with the costs of demand-side energy efficiency measures, we project will result in net cost estimates of \$8.4 billion in 2030 for the rate-based scenario and \$5.1 billion for the mass-based scenario.

Table 3-8. Annualized Compliance Costs Including Monitoring, Reporting and Recordkeeping Costs Requirements (billions of 2011\$)

	2020	2025	2030
Rate-based	\$2.5	\$1.0	\$8.4
Mass-based	\$1.4	\$3.0	\$5.1

Source: Integrated Planning Model run by EPA, 2015, with post-processing to account for exogenous demand-side energy efficiency costs and monitoring, reporting, and recordkeeping costs.

In order to contextualize EPA’s projection of the additional costs in 2030 across the two illustrative plan approaches evaluated in this RIA, it is useful to compare these incremental cost estimates to total projected power sector expenditures. The power sector is expected in the base case to expend over \$201 billion in 2030 to generate, transmit, and distribute electricity to end-use consumers. In 2014, according to EIA, the power sector generated \$389 billion in revenue

⁸⁰ See Chapter 2 of the GHG Mitigation Measures TSD and EPA’s Base Case using IPM (v5.15) documentation, available at: <http://www.epa.gov/powersectormodeling>

from retail sales of electricity. For context, the projected costs of compliance with the final rule amount to a 4 percent increase in the cost of meeting electricity demand, while securing public health and welfare benefits that are several times greater (as described in Chapters 4 and 8).

The following example uses projected results for the year 2030 to illustrate how different components of estimated expenditures are combined to form the full compliance costs presented in Table 3-8. In Table 3-9, we present the IPM modeling results for the two illustrative plan scenarios in 2030 (as well as 2020 and 2025). The results show that annualized expenditures required to supply enough electricity to meet demand decline by \$18 billion (rate) and \$21 billion (mass) from the base case in 2030. This incremental decline is a net outcome of two simultaneous effects that move in opposite directions. First, imposing the CO₂ constraints represented by each illustrative plan scenario on electric generators would, other things equal, result in an incremental increase in expenditures to supply any given level of electricity. However, once electricity demand is reduced to reflect demand-side energy efficiency improvements, there is a substantial reduction in the expenditures needed to supply a correspondingly lower amount of electricity demand.

Table 3-9. Total Power Sector Generating Costs (IPM) (billions 2011\$)

	2020	2025	2030
Base Case	\$166.5	\$178.3	\$201.3
Rate-based	\$166.8	\$162.6	\$183.3
Mass-based	\$165.7	\$164.6	\$180.1

Source: Integrated Planning Model run by EPA, 2015

In order to reflect the full compliance cost attributable to the CPP scenarios, it is necessary to include the annualized expenditures needed to secure the demand-side energy efficiency improvements. As described in section 3.7.2, EPA has estimated these energy efficiency-related expenditures to be \$26.3 billion in 2030 (using a 3 percent discount rate). The energy efficiency-related expenditures include costs incurred by parties administering energy efficiency programs and costs incurred by participants in those programs. As a result, this analysis finds the cost of the rate-based and mass-based illustrative plan approaches in 2030 to be \$8.4 billion and \$5.1 billion, respectively.

3.9.3 Projected Compliance Actions for Emissions Reductions

Heat Rate Improvements (HRI): EPA analysis assumes that the existing coal steam electric generating fleet has, on average, the ability to improve operating efficiency (i.e., reduce the

average net heat rate, or the Btu of fuel energy needed to produce one kWh of net electricity output). All else held constant, an HRI allows the EGU to generate the same amount of electricity using less fuel. The decrease in required fossil fuel results in a lower output-based CO₂ emissions rate (lbs/MWh), as well as a lower variable cost of electricity generation. In the modeling conducted for these illustrative plan approaches, coal boilers have the choice to improve heat rates by 4.3 percent in the eastern illustrative compliance region, 2.1 percent in the western illustrative compliance region, and 2.3 percent in Texas, all at a capital cost of \$100 per kW.⁸¹ The option for heat rate improvement is only made available in the illustrative plan approaches during the compliance period, in response to the final rule.

The majority of existing coal boilers are projected to adopt the aforementioned heat rate improvements. Of the 183 GW of coal projected to operate in 2030, EPA projects that 99 GW of existing coal steam capacity (greater than 25 MW) will improve operating efficiency (i.e., reduce the average net heat rate) under the rate-based approach by 2030. Under the mass-based approach, EPA projects that 88 GW of the 174 GW of coal projected to operate in 2030 will improve operating efficiency by 2030.

Generation Shifting: Another approach for reducing the average emission rate from existing units is to shift some generation from more CO₂-intensive generation to less CO₂-intensive generation. Compared to the base case, existing coal steam capacity is, on average, projected to operate at a lower capacity factor for both illustrative plan approaches. Under the illustrative rate-based plan approach, the average 2030 capacity factor is 69 percent, and under the mass-based approach, the average capacity factor for existing coal steam is 75 percent. Existing natural gas combined cycle units, which are less carbon-intensive than coal steam capacity on an output basis, operate at noticeably higher capacity factor under both illustrative plan approaches, on average. The utilization of existing natural gas combined cycle capacity is lower than the BSER level of 75 percent⁸² on an annual average basis in these illustrative plan approaches, reflecting the fact that,

⁸¹ The option for heat rate improvement is only made available in the illustrative plan scenarios, and is not available in the base case. For an explanation of the regional differences in average ability to improve heat rates, see GHG Mitigation Measures TSD.

⁸² See preamble section V.D.

in practice, the most cost-effective CO₂ reduction strategies to meet each state’s goal may not require that each building block be achieved in entirety. See Table 3-10.

Table 3-10. Projected Capacity Factor of Existing Coal Steam and Natural Gas Combined Cycle Capacity

	Existing Coal Steam			Existing Natural Gas Combined Cycle		
	2020	2025	2030	2020	2025	2030
Base Case	77%	76%	79%	54%	56%	51%
Rate-based	78%	75%	69%	56%	60%	61%
Mass-based	78%	75%	75%	56%	58%	54%

Source: Integrated Planning Model run by EPA, 2015

Demand-Side Energy Efficiency: Another approach for reducing emissions from affected EGUs is to consider reductions in demand attributable to demand-side energy efficiency measures as discussed in section 3.7. In the illustrative plan approaches presented in this RIA, each state is credited for total demand-side energy efficiency implemented in, or procured by, that state, consistent in aggregate with the state-by-state demand reductions that are represented by the demand-side energy efficiency scenario discussed in section 3.7.1.

Deployment of Cleaner Generating Technologies: Another key opportunity to reduce emissions from existing sources is to build more lower- or zero-emitting generating resources, in particular renewable energy. These sources of electricity, including wind and solar, can displace higher emitting existing sources, may be procured for compliance with the state goals in the rate-based illustrative scenario, and are further incentivized as a generation option in the mass-based illustrative scenario as they are not subject to the mass-based constraint and may receive the renewable set-aside. Increased deployment results in CO₂ reductions in both rate-based and mass-based approaches. See sections below discussing projected impacts on generation mix and capacity.

3.9.4 Projected Generation Mix

Table 3-11 and Figure 3-2 show the generation mix in the base case and under the two illustrative plan approaches. In both scenarios, total generation declines relative to the base case as a result of the reduction in total demand attributable to the demand-side energy efficiency applied in the illustrative scenarios, by 5 percent in 2025 and 8 percent in 2030.

Under the rate-based scenario, coal-fired generation is projected to decline 12 percent in 2025, and natural-gas-fired generation from existing combined cycle capacity is projected to increase 5 percent relative to the base case. The coal-fired fleet in 2030 generates 23 percent less than in the base case, while natural-gas-fired generation from existing combined cycles increases 18 percent relative to the base case. Gas-fired generation from new combined cycle capacity decreases in 2025 and 2030, consistent with the decrease in new capacity (see section 3.9.6). Relative to the base case, generation from non-hydro renewables decreases 1 percent in 2025 and increases 9 percent in 2030.

Similarly, under the mass-based scenario, coal-fired generation is projected to decline 15 percent in 2025, and natural-gas-fired generation from existing combined cycle capacity is projected to increase 2 percent relative to the base case. The coal-fired fleet in 2030 generates 22 percent less than in the base case, while natural-gas-fired generation from existing combined cycles increases 5 percent relative to the base case. Gas-fired generation from new combined cycle capacity decreases 8 percent and 36 percent relative to the base case in 2025 and 2030, respectively. Relative to the base case, generation from non-hydro renewables decreases 3 percent in 2025 and increases 8 percent in 2030.

The results presented in these illustrative compliance scenarios suggest that existing nuclear generation could be slightly more competitive under a mass-based implementation than under a rate-based implementation, because the former tends to create more wholesale price support for those generators. These scenarios do not include potential approaches that states can take to incentivize zero-carbon baseload power.

Table 3-11. Generation Mix (thousand GWh)

	Base Case	Rate-based	Mass-based	Rate-based	Mass-based
2020					
Coal	1,462	1,391	1,374	-5%	-6%
NG Combined Cycle (existing)	1,111	1,126	1,132	1%	2%
NG Combined Cycle (new)	33	53	69	61%	111%
Combustion Turbine	15	20	17	39%	14%
Oil/Gas Steam	51	51	50	0%	-1%
Non-Hydro Renewables	393	399	385	2%	-2%
Hydro	310	311	310	0%	0%
Nuclear	798	792	804	-1%	1%
Other	18	18	18	0%	0%
Total	4,190	4,160	4,159	-1%	-1%
2025					
Coal	1,428	1,256	1,217	-12%	-15%
NG Combined Cycle (existing)	1,152	1,206	1,179	5%	2%
NG Combined Cycle (new)	113	53	104	-53%	-8%
Combustion Turbine	23	30	34	31%	46%
Oil/Gas Steam	39	21	19	-46%	-52%
Non-Hydro Renewables	417	414	404	-1%	-3%
Hydro	340	340	340	0%	0%
Nuclear	799	791	804	-1%	1%
Other	17	17	18	0%	0%
Total	4,328	4,128	4,118	-5%	-5%
2030					
Coal	1,466	1,131	1,144	-23%	-22%
NG Combined Cycle (existing)	1,042	1,230	1,090	18%	5%
NG Combined Cycle (new)	324	100	207	-69%	-36%
Combustion Turbine	22	27	32	21%	46%
Oil/Gas Steam	22	11	11	-52%	-53%
Non-Hydro Renewables	450	488	485	9%	8%
Hydro	340	341	340	0%	0%
Nuclear	783	777	785	-1%	0%
Other	17	17	17	0%	0%
Total	4,467	4,122	4,110	-8%	-8%

Note: "Other" mostly includes generation from MSW and fuel cells. Source: Integrated Planning Model run by EPA, 2015

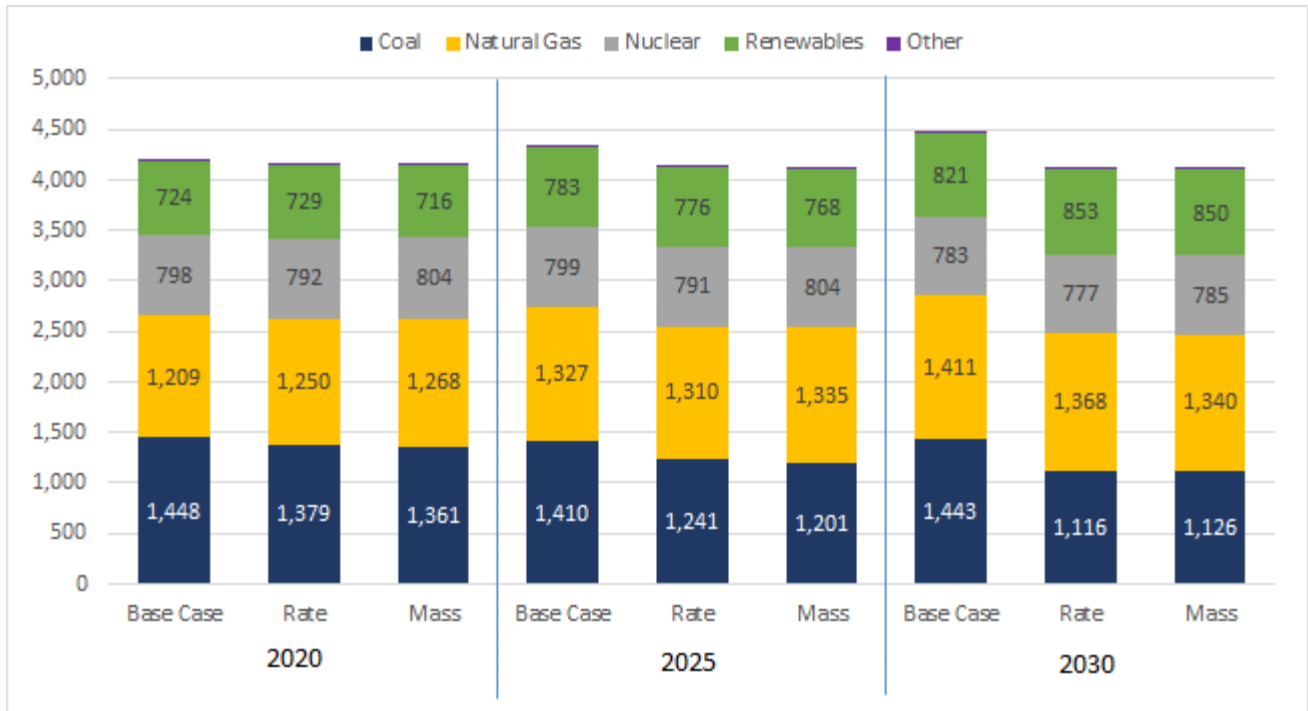

Figure 3-2 Generation Mix (thousand GWh)

Source: Integrated Planning Model run by EPA, 2015

Under both the rate-based and mass-based approaches, the projected rate of change in coal-fired generation is consistent with recent historical declines in coal-fired generation. Additionally, under both of these approaches, the trends for all other types will remain consistent with what their trends would be in the absence of this rule. Specifically, natural-gas fired generation and renewables would be expected to increase without this rule, and both are expected to increase under this rule, with renewables increasing at a somewhat greater rate than in the absence of this rule; and nuclear, oil-fired, and other types of generation are expected to be little impacted by this rule generation mix is consistent with recent declines in coal-fired generation and increases in gas-fired generation. See Figures 3-3, 3-4, and 3-5.

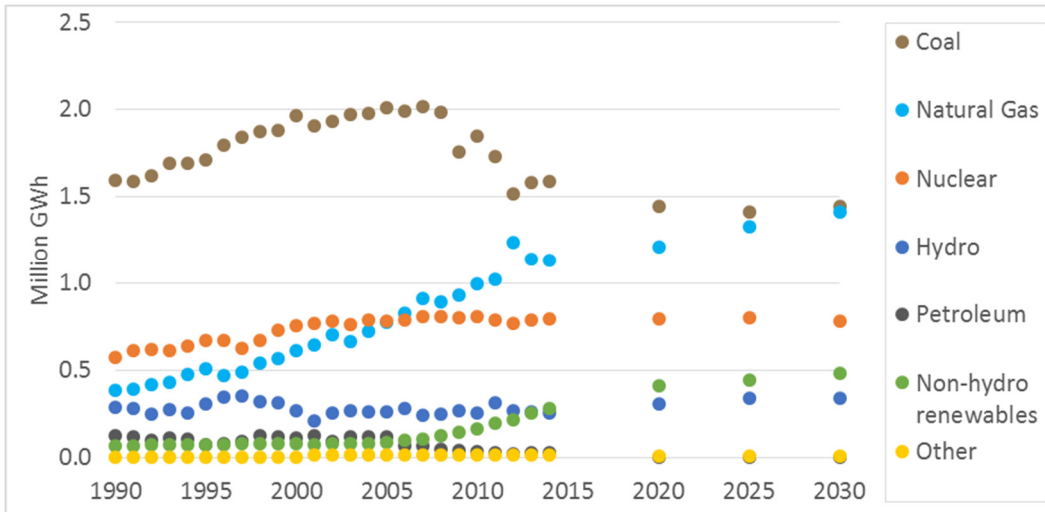

Figure 3-3. Nationwide Generation: Historical (1990-2014) and Base Case Projections (2020, 2025, 2030)

Sources: Historic data (i.e., 1990-2014): U.S. Energy Information Administration, June 2015 Monthly Energy Review, Table 7.2a Electricity Net Generation: Total (All Sectors), Available at <http://www.eia.gov/totalenergy/data/monthly/>. Projected data (i.e., 2020, 2025, 2030): Integrated Planning Model, 2015. Notes: Historic and projected data include generation from the power, industrial, and commercial sectors. Historic data from U.S. EIA reflects all cogeneration, while projections from the Integrated Planning Model reflect net cogeneration.

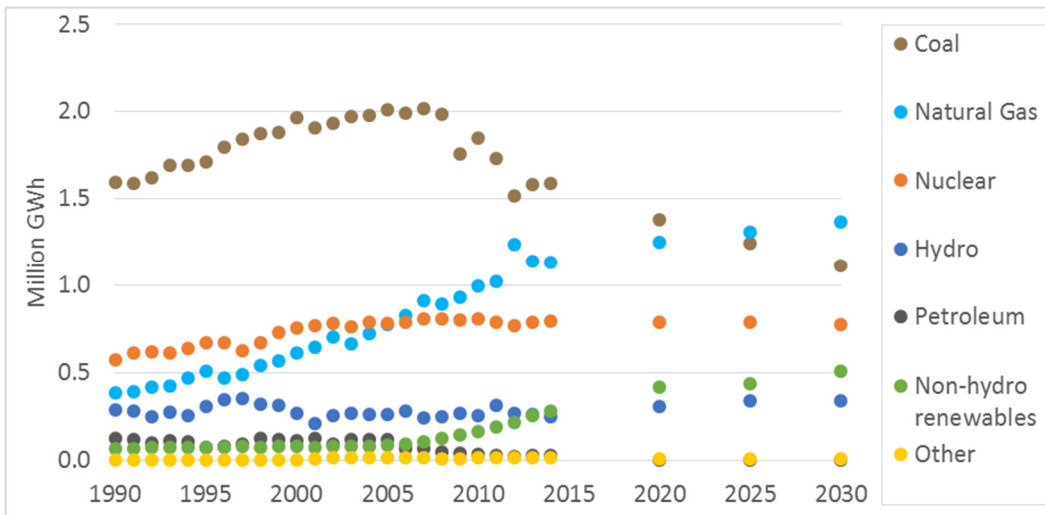

Figure 3-4. Nationwide Generation: Historical (1990-2014) and Rate-Based Illustrative Plan Approach Projections (2020, 2025, 2030)

Sources: Historic data (i.e., 1990-2014): U.S. Energy Information Administration, June 2015 Monthly Energy Review, Table 7.2a Electricity Net Generation: Total (All Sectors), Available at <http://www.eia.gov/totalenergy/data/monthly/>. Projected data (i.e., 2020, 2025, 2030): Integrated Planning Model, 2015. Notes: Historic and projected data include generation from the power, industrial, and commercial sectors. Historic data from U.S. EIA reflects all cogeneration, while projections from the Integrated Planning Model reflect net cogeneration.

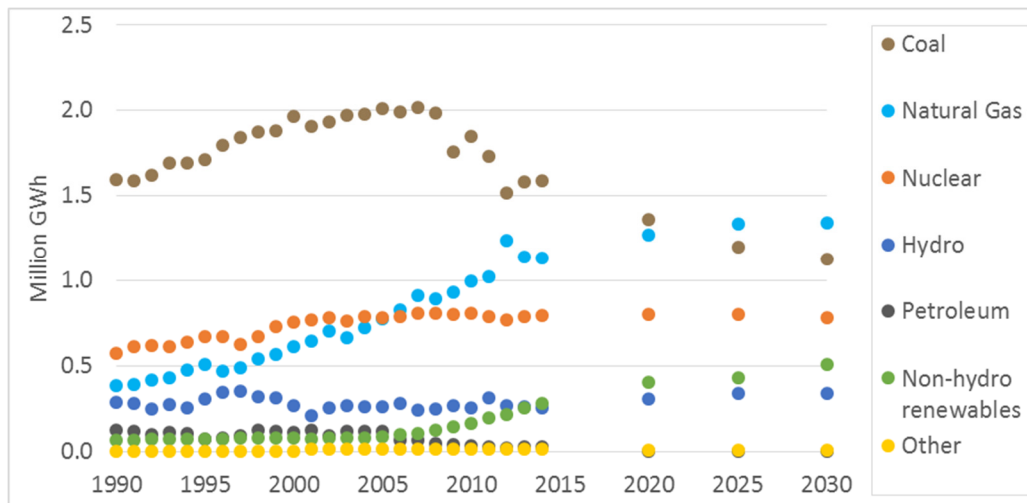

Figure 3-5. Nationwide Generation: Historical (1990-2014) and Mass-Based Illustrative Plan Approach Projections (2020, 2025, 2030)

Sources: Historic data (i.e., 1990-2014): U.S. Energy Information Administration, June 2015 Monthly Energy Review, Table 7.2a Electricity Net Generation: Total (All Sectors), Available at <<http://www.eia.gov/totalenergy/data/monthly/>>. Projected data (i.e., 2020, 2025, 2030): Integrated Planning Model, 2015. Notes: Historic and projected data include generation from the power, industrial, and commercial sectors. Historic data from U.S. EIA reflects all cogeneration, while projections from the Integrated Planning Model reflect net cogeneration.

3.9.5 Projected Incremental Retirements

Relative to the base case, about 23 GW of additional coal-fired capacity is projected to be uneconomic to maintain by 2025 under the rate-based illustrative scenario, increasing to 27 GW in 2030 (about 11-13 percent respectively of all coal-fired capacity projected to be in service in the base case). Under the mass-based scenario, about 29 GW of additional coal-fired capacity is projected to be uneconomic to maintain by 2025, increasing to 38 GW by 2030 (about 14-19 percent respectively of all coal-fired capacity projected to be in service in the base case).

Capacity changes from the base case are shown in Table 3-12.⁸³

⁸³ EPA examined the implications of the illustrative plan scenarios for concerns about regional resource adequacy and the potential for concerns about reliability. This examination can be found in U.S. EPA. 2015. Technical Support Document (TSD) the Final Carbon Pollution Emission Guidelines for Existing Stationary Sources: Electric Utility Generating Units. Resource Adequacy and Reliability Analysis.

Table 3-12. Total Generation Capacity by 2020-2030 (GW)

	Base Case	Rate-based	Mass-based	Rate-based	Mass-based
2020					
Coal	208	195	193	-6%	-7%
NG Combined Cycle (existing)	233	231	232	-1%	0%
NG Combined Cycle (new)	4	7	9	62%	113%
Combustion Turbine	141	137	137	-3%	-3%
Oil/Gas Steam	88	81	80	-8%	-9%
Non-Hydro Renewables	130	132	128	1%	-2%
Hydro	106	106	106	0%	0%
Nuclear	100	100	101	-1%	1%
Other	5	5	5	0%	0%
Total	1,016	994	992	-2%	-2%
2025					
Coal	208	187	181	-10%	-13%
NG Combined Cycle (existing)	233	231	232	-1%	0%
NG Combined Cycle (new)	15	7	14	-52%	-9%
Combustion Turbine	143	138	137	-4%	-4%
Oil/Gas Steam	82	71	69	-14%	-16%
Non-Hydro Renewables	139	137	134	-1%	-3%
Hydro	112	112	112	0%	0%
Nuclear	100	99	101	-1%	1%
Other	5	5	5	0%	0%
Total	1,037	988	985	-5%	-5%
2030					
Coal	207	183	174	-11%	-16%
NG Combined Cycle (existing)	233	231	232	-1%	0%
NG Combined Cycle (new)	44	14	27	-68%	-38%
Combustion Turbine	147	138	136	-6%	-7%
Oil/Gas Steam	82	70	67	-15%	-18%
Non-Hydro Renewables	154	174	171	13%	11%
Hydro	112	112	112	0%	0%
Nuclear	99	98	99	-1%	0%
Other	5	5	5	0%	0%
Total	1,082	1,025	1,024	-5%	-5%

Source: Integrated Planning Model run by EPA, 2015

3.9.6 Projected Capacity Additions

Due largely to the electricity demand reduction attributable to the demand-side energy efficiency improvements applied in the illustrative scenarios, the EPA projects less new natural

gas combined cycle capacity built under the rate-based scenario than is built in the base case over the period covered by the rule. While this new NGCC capacity cannot be directly counted towards the average emissions rate used for compliance in the rate-based approach, it can displace some generation from covered sources and thus indirectly lower the average emissions rate from covered sources. Conversely, the EPA projects an overall increase in new renewable capacity. New non-hydro renewables are able to contribute their generation to the average emissions rate in each state or region.

Under the rate-based illustrative scenario, new natural gas combined cycle capacity is projected to decrease by 8 GW in 2025 and 30 GW in 2030 (52 percent and 68 percent decrease relative to the base case). New renewable capacity is projected to decrease by about 2 GW (3 percent decrease) below the base case in 2025, and increase by 20 GW (27 percent increase) by 2030.

Under the mass-based illustrative scenario, new natural gas combined cycle capacity is projected to decrease by 1 GW in 2025 and decrease by 17 GW in 2030 (a 9 percent and 38 percent decrease relative to the base case). New renewable capacity is projected to decrease 4 GW (7 percent) relative to the base case in 2025, and increase 18 GW (24 percent increase) by 2030.

Table 3-13. Projected Capacity Additions, Gas (GW)

	Cumulative Capacity Additions: Gas Combined Cycle			Incremental Cumulative Capacity Additions: Gas Combined Cycle		
	2020	2025	2030	2020	2025	2030
Base Case	4.4	14.9	44.0			
Rate-based	7.1	7.1	13.9	2.7	-7.8	-30.1
Mass-based	9.3	13.6	27.2	4.9	-1.3	-16.8

Source: Integrated Planning Model run by EPA, 2015

Table 3-14. Projected Capacity Additions, Renewable (GW)

	Cumulative Capacity Additions: Renewables			Incremental Cumulative Capacity Additions: Renewables		
	2020	2025	2030	2020	2025	2030
Base Case	39.1	59.1	74.1			
Rate-based	40.5	57.4	94.4	1.4	-1.8	20.2
Mass-based	36.7	54.9	91.9	-2.4	-4.2	17.8

Source: Integrated Planning Model run by EPA, 2015

3.9.7 Projected Coal Production and Natural Gas Use for the Electric Power Sector

Coal production is projected to decrease in 2025 and beyond in the illustrative scenarios due to (1) improved heat rates (generating efficiency) at existing coal units, (2) electricity demand reduction attributable to demand-side energy efficiency improvements, and (3) a shift in generation from coal to less-carbon intensive generation. As shown in Table 3-15, the largest decrease in coal production is projected to occur in the western region.

Table 3-15. Coal Production for the Electric Power Sector, 2025

	Coal Production (million short tons)			Percent Change from Base Case	
	Base Case	Rate-based	Mass-based	Rate-based	Mass-based
Appalachia	92	71	69	-23%	-25%
Interior	250	242	236	-3%	-6%
West	379	306	293	-19%	-23%
Waste Coal	6	6	6	0%	0%
Imports	1	1	1	-37%	-14%
Total	729	626	606	-14%	-17%

Source: Integrated Planning Model run by EPA, 2015

Power sector natural gas use is projected to decrease by about 1 percent in 2025 and 2030 under the rate-based illustrative plan scenario. In the mass-based scenario, power sector natural gas use is projected to decrease by 4.5 percent in 2030. These trends are consistent with the change in generation mix described above in Section 3.9.4.

Table 3-16. Power Sector Gas Use

	Power Sector Gas Use (TCF)			Percent Change in Power Sector Gas Use		
	2020	2025	2030	2020	2025	2030
Base Case	8.62	9.38	9.72			
Rate-based	8.91	9.28	9.59	3.4%	-1.0%	-1.3%
Mass-based	9.02	9.39	9.28	4.6%	0.2%	-4.5%

Source: Integrated Planning Model run by EPA, 2015

3.9.8 Projected Fuel Price, Market, and Infrastructure Impacts

The impacts of the two illustrative plan scenarios on coal and natural gas prices before shipment are shown below in Table 3-17 and Table 3-18 and are attributable to the changes in overall power sector demand for each fuel due to the final guidelines. Coal demand decreases by 2030, resulting in a decrease in the price of coal delivered to the electric power sector. In 2030, gas demand and price decrease below the base case projections, due to the cumulative impact of demand-side energy efficiency improvements and the consequent reduced overall electricity demand.

IPM modeling of natural gas prices uses both short- and long-term price signals to balance supply and demand for the fuel across the modeled time horizon. As such, it should be understood that the pattern of IPM natural gas price projections over time is not a forecast of natural gas prices incurred by end-use consumers at any particular point in time. The natural gas market in the United States has historically experienced some degree of price volatility from year to year, between seasons within a year, and during short-lived weather events (such as cold snaps leading to short-run spikes in heating demand). These short-term price signals are fundamental for allowing the market to successfully align immediate supply and demand needs. However, end-use consumers are typically shielded from experiencing these rapid fluctuations in natural gas prices by retail rate regulation and by hedging through longer-term fuel supply contracts by the power sector. IPM assumes these longer-term price arrangements take place “outside of the model” and on top of the “real-time” shorter-term price variation necessary to align supply and demand. Therefore, the model’s natural gas price projections should not be mistaken for traditionally experienced consumer price impacts related to natural gas, but a reflection of expected average price changes over the period represented by the modeling horizon.

There are very small changes to natural gas pipeline infrastructure needs over time, in response to the illustrative plan scenarios. These changes, compared to historical deployment of

new infrastructure, are very modest. In both the rate-based and mass-based scenarios, pipeline capacity construction through 2020 is projected to increase by less than two percent beyond base case projections. By 2030, however, the total cumulative pipeline capacity construction built is projected to decrease compared to the base case, consistent with the projected decrease in total demand and natural gas use. The projected increase in pipeline capacity in the near term is largely the result of building pipeline capacity a few years earlier than projected in the base case.

Table 3-17. Projected Average Minemouth and Delivered Coal Prices (2011\$/MMBtu)

	Minemouth			Delivered - Electric Power Sector		
	2020	2025	2030	2020	2025	2030
Base Case	1.55	1.67	1.79	2.38	2.50	2.68
Rate-based	1.54	1.58	1.73	2.34	2.35	2.46
Mass-based	1.54	1.59	1.73	2.35	2.40	2.55
Rate-based	-0.8%	-5.0%	-3.8%	-1.7%	-6.2%	-8.0%
Mass-based	-0.7%	-4.7%	-3.2%	-1.6%	-4.3%	-4.6%

Source: Integrated Planning Model run by EPA, 2015

Table 3-18. Projected Average Henry Hub (spot) and Delivered Natural Gas Prices (2011\$/MMBtu)

	Henry Hub			Delivered - Electric Power Sector		
	2020	2025	2030	2020	2025	2030
Base Case	5.20	5.12	6.01	5.25	5.17	5.98
Rate-based	5.48	4.73	6.21	5.53	4.77	6.13
Mass-based	5.40	4.97	5.92	5.45	5.00	5.86
Rate-based	5.4%	-7.5%	3.3%	5.3%	-7.7%	2.5%
Mass-based	3.9%	-3.0%	-1.4%	3.8%	-3.2%	-2.1%

Source: Integrated Planning Model run by EPA, 2015

3.9.9 Projected Retail Electricity Prices

EPA's analysis of the illustrative rate-based plan scenario shows an increase in the national average (contiguous U.S.) retail electricity price of less than one percent in both 2025 and 2030, compared to the modeled base case price estimate in those years. Under the illustrative mass-based plan scenario, EPA projects an increase in the national average (contiguous U.S.) retail electricity price of 2 percent in 2025 and 0.01 percent in 2030.

Retail electricity prices embody generation, transmission, distribution, taxes, and demand-side energy efficiency costs. IPM modeling projects changes in regional wholesale power prices and capacity payments related to imposition of the represented CPP scenarios that

are combined with EIA regional transmission and distribution costs to calculate changes to regional retail prices using the Retail Price Model (RPM).⁸⁴ As described in Section 3.7.2, the funding for demand-side energy efficiency (to cover program costs) is typically collected through a standard per kWh surcharge to the ratepayer and the regional retail price impacts presented here assume that these costs are recovered by utilities in retail rates. This is an approximation, since not every utility will pass through the entirety of demand-side energy efficiency costs. For example, a distribution only utility may generate reductions from demand-side energy efficiency, sell the associated reduction in generation to affected EGUs (which in turn use them to demonstrate compliance), and then account for this revenue in rate determination. Furthermore, this analysis assumes that ratepayers in the state producing zero-emitting generation (or avoided generation) bear the costs of such production. However, in practice, if such generation is claimed by an affected source in another state, part of the cost of that generation may ultimately be borne by ratepayers in the claiming state rather than the state in which that zero-emitting generation was located. There are many factors influencing the estimated retail electricity price impacts, namely projected changes in generation mix, fuel prices, and development of new generating capacity. These projected changes vary regionally under each illustrative plan scenario in response to the goals under the two scenarios. The projected changes also vary depending upon retail electricity market structure (e.g., cost-of-service vs. competitive). In the mass-based approach, treatment of allowance allocations will also have an impact on retail electricity prices. In competitive regions, this RIA assumes that allowances are freely allocated to generators who then keep 100% of the freely allocated allowance value without passing this value through to ratepayers in the form of lower retail electricity prices. To the extent that implementing authorities choose to require this allowance value to be passed through to ratepayers (such as by allocating allowances to load-serving entities who could be subject to such a requirement), retail prices would be lower than those shown here.

⁸⁴ See documentation available at: <http://www.epa.gov/powersectormodeling/>

Table 3-19. 2020 Projected Contiguous U.S. and Regional Retail Electricity Prices (cents/kWh)

	2020 Projected Retail Price (cents/kWh)			Percent Change from Base Case	
	Base Case	Rate-based	Mass-based	Rate-based	Mass-based
ERCT	9.7	9.9	9.9	2.5%	2.1%
FRCC	10.5	10.7	10.7	2.0%	1.6%
MROE	9.9	10.3	10.3	4.2%	3.8%
MROW	8.7	9.0	9.0	2.8%	2.3%
NEWE	13.3	14.0	14.0	5.1%	5.5%
NYCW	17.4	18.3	18.3	5.0%	5.3%
NYLI	14.4	15.1	15.1	4.6%	5.1%
NYUP	12.4	13.1	13.1	5.4%	5.3%
RFCE	11.1	11.8	11.8	6.1%	6.1%
RFCM	10.4	10.9	10.9	4.3%	4.3%
RFCW	9.4	9.8	9.8	5.1%	4.8%
SRDA	8.6	8.8	8.7	2.1%	1.7%
SRGW	8.6	9.0	9.0	4.1%	4.8%
SRSE	10.0	10.1	10.1	0.9%	0.5%
SRCE	8.0	8.1	8.1	1.1%	0.8%
SRVC	9.8	9.9	9.9	1.5%	1.2%
SPNO	9.9	9.9	9.9	-0.8%	-0.9%
SPSO	7.9	8.1	8.1	3.2%	2.4%
AZNM	10.9	11.2	11.2	2.1%	2.1%
CAMX	14.3	14.8	14.7	3.3%	3.0%
NWPP	6.9	7.1	7.1	3.2%	2.9%
RMPA	8.7	9.0	8.9	3.1%	2.9%
Contiguous U.S.	10.0	10.3	10.3	3.2%	3.0%

Note: regions pictured on Figure 3-6.

Table 3-20. 2025 Projected Contiguous U.S. and Regional Retail Electricity Prices (cents/kWh)

	2025 Projected Retail Price (cents/kWh)			Percent Change from Base Case	
	Base Case	Rate-based	Mass-based	Rate-based	Mass-based
ERCT	10.7	11.1	10.9	3.8%	1.5%
FRCC	10.2	10.2	10.3	-0.2%	1.0%
MROE	9.7	10.0	10.0	2.4%	2.6%
MROW	8.7	9.0	9.0	2.5%	3.1%
NEWE	12.6	12.4	12.7	-1.3%	0.5%
NYCW	17.0	16.9	16.9	-0.5%	-0.5%
NYLI	14.0	13.7	13.7	-2.2%	-1.7%
NYUP	11.8	11.7	11.7	-0.8%	-1.3%
RFCE	10.3	10.2	10.5	-0.2%	2.1%
RFCM	10.4	10.4	10.6	0.5%	1.9%
RFCW	9.8	9.7	10.1	-1.4%	2.4%
SRDA	8.6	8.6	8.7	0.0%	1.4%
SRGW	9.1	9.0	9.3	-0.9%	2.5%
SRSE	9.6	9.7	9.8	1.4%	2.1%
SRCE	7.8	8.0	8.0	2.6%	3.0%
SRVC	9.3	9.5	9.6	1.7%	2.4%
SPNO	9.8	10.0	10.2	2.9%	4.3%
SPSO	8.1	8.3	8.4	2.7%	4.4%
AZNM	10.7	10.9	10.9	2.2%	1.8%
CAMX	13.2	13.3	13.5	0.8%	2.4%
NWPP	6.8	6.9	7.0	2.1%	2.7%
RMPA	8.6	8.7	8.9	2.0%	4.3%
Contiguous U.S.	9.9	9.9	10.1	0.9%	2.0%

Note: regions pictured on Figure 3-6.

Table 3-21. 2030 Projected Contiguous U.S. and Regional Retail Electricity Prices (cents/kWh)

	2030 Projected Retail Price (cents/kWh)			Percent Change from Base Case	
	Base Case	Rate-based	Mass-based	Rate-based	Mass-based
ERCT	11.6	11.4	11.3	-1.4%	-2.5%
FRCC	10.3	10.8	10.5	4.6%	2.3%
MROE	9.7	10.3	10.3	5.9%	6.3%
MROW	8.9	9.1	9.1	2.7%	2.8%
NEWE	14.3	13.6	13.4	-5.4%	-6.9%
NYCW	19.2	18.2	18.0	-5.2%	-6.4%
NYLI	16.3	14.8	14.6	-9.0%	-10.1%
NYUP	13.6	12.7	12.5	-7.0%	-8.4%
RFCE	11.3	10.7	10.6	-5.6%	-6.5%
RFCM	10.5	10.8	10.7	3.4%	1.7%
RFCW	10.4	10.5	10.5	1.2%	0.7%
SRDA	9.0	9.3	9.2	3.5%	1.9%
SRGW	9.7	9.6	9.7	-0.6%	0.4%
SRSE	9.8	10.2	10.0	3.9%	2.1%
SRCE	7.8	8.1	8.0	4.3%	3.3%
SRVC	9.3	9.6	9.5	3.2%	2.0%
SPNO	9.5	9.8	10.1	2.7%	5.8%
SPSO	8.7	9.0	8.9	3.9%	2.0%
AZNM	10.9	11.2	11.1	2.3%	2.0%
CAMX	13.5	13.6	13.7	1.1%	1.4%
NWPP	6.9	7.0	7.1	2.2%	2.6%
RMPA	8.9	9.0	9.3	0.7%	3.5%
Contiguous U.S.	10.3	10.4	10.3	0.8%	0.01%

Note: regions pictured on Figure 3-6.

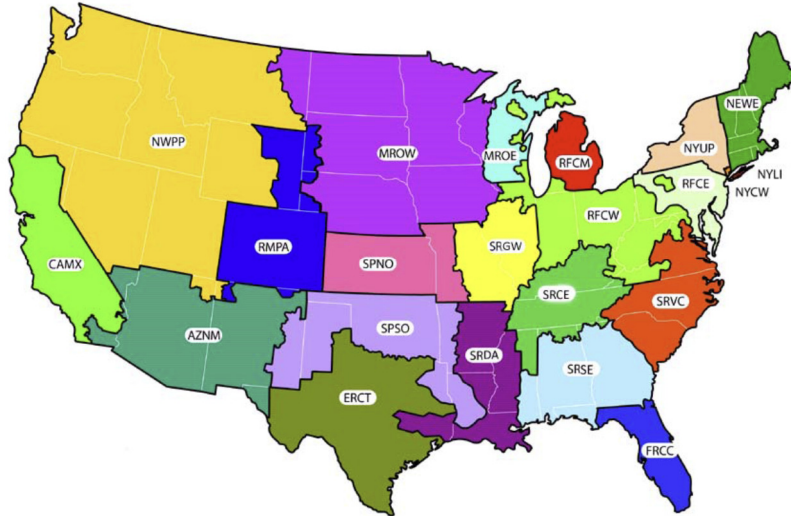

Figure 3-6. Electricity Market Module Regions

Source: EIA (http://www.eia.gov/forecasts/aeo/pdf/nerc_map.pdf)

3.9.10 Projected Electricity Bill Impacts

The electricity price changes addressed in section 3.9.9 combine with the significant reductions in electricity demand applied in the illustrative approaches to affect average electricity bills. The estimated changes to average bills are summarized in Table 3-22, and are subject to the same caveats described in section 3.9.9. Under the illustrative rate-based plan scenario, EPA estimates an average monthly bill increase of 2.7 percent in 2020 and an average bill decrease of 3.8 percent in 2025 and 7 percent in 2030. Under the mass-based scenario, EPA estimates an average bill increase of 2.4 percent in 2020 and an average bill decrease of 2.7 percent in 2025 and 7.7 percent in 2030. These reduced electricity bills reflect the combined effects of changes in both average retail rates (driven by compliance approaches taken to achieve the state goals) and lower electricity demand (driven by demand-side energy efficiency).

Table 3-22. Projected Changes in Average Electricity Bills

	2020	2025	2030
Rate-based	2.7%	-3.8%	-7.0%
Mass-based	2.4%	-2.7%	-7.7%

3.10 Adoption of a Mix of State Plan Approaches

The impact of the EGs on the marginal cost of generating electricity may differ for affected EGUs if a state adopts a rate-based or a mass-based plan. Analysts have observed, in the

context of the proposed EG, that the different production incentives for rate and mass-based plans may encourage greater generation by the affected EGUs in the rate-based state. This is because the rate-based approach may yield lower marginal costs of electricity generation than the mass-based approach for some otherwise similar EGUs. In a rate-based program, affected EGUs may emit more if they generate more, whereas in a mass-based approach, if an affected EGU generates more it must incur the full cost of increasing its emissions. Some analysts have suggested that this implies that if a state with a rate-based plan shares an electricity market with another state that adopted a mass-based plan, then total CO₂ emissions may be higher than if both states adopted the same form of implementation (e.g. Burtraw et al., 2015; Bushnell et al., 2014). In each case, both states would still be able to demonstrate that their affected EGUs are in compliance, such that the state is achieving its state goal (or the uniform rates).

While these analyses identify how emissions and costs may be influenced by the variation in the types of plans that states adopt, they have not raised concerns about the ability of the electricity system to provide reliable and affordable electricity when EGUs face different regulatory incentives. The EPA believes that differences in state plans, along with differences in incentives from those plans, will not detrimentally affect the operation of electricity markets because EGUs in the same market are often subject to different regulatory incentives. For example, the time-differentiated pattern of renewable portfolio standard (RPS) adoption, their varying stringency and form, and the operation of their associated renewable energy credit (REC) markets, across the U.S. demonstrates how interconnected electricity markets are able to function successfully, even with differential regulatory incentives across states. RPS are adopted at the state level and are required of load-serving entities (LSEs). In some states, LSEs and the owners of most of the fossil generation are one and the same. In other states, LSEs own no generation (either fossil or renewable), and in some states and markets, one LSE may own generation, while another may not. Furthermore, RPS requirements for LSEs serving load in multiple states will influence the behavior of all EGUs operating the electricity market. Even with this non-uniform regulatory environment, electricity has been delivered affordably and reliably while at the same time, the use of renewable energy has increased dramatically.

In the context of preexisting programs, evidence suggests that the effect of differential regulatory structures on emissions is relatively modest. For example, Schennach (2000) finds that in the early years of the Title IV cap and trade program, the increase in SO₂ emissions of

Phase II units, which historically were subject to emission rate performance standards, offset the decrease in SO₂ emissions by Phase I units in by about 5%. The EPA's prospective analysis of the benefits and costs of the Cross-State Air Pollution Rule, which used IPM, forecast only a small increase in SO₂ emissions from plants that were not subject to the rule (U.S.EPA 2011). The Regional Greenhouse Gas Initiative (RGGI) produces an annual report monitoring the trends in on CO₂ emissions from electricity generation in the region and imports from outside of the region. To date, RGGI's monitoring effort has not identified any significant change in CO₂ emissions or the CO₂ emission rate from non-RGGI electric generation serving load in the RGGI region (e.g., RGGI 2014). The effect on the relative costs of production across similar sources affected by different regulatory approaches will, in part, depend on the relative stringency of the different regulatory approaches, and the emission rate of the EGUs that represent the marginal source of electricity supply in the long-run.

In practice, determining the direction and magnitude of the effect of variation in state plan type on sector wide emissions, relative to the two illustrative plan scenarios evaluated in this RIA, would be difficult. At the outset there is a lack of information as to what design features states might adopt in their plans and in turn what patterns of spatial and plan variation would be most appropriate to consider. Determining the change in sectoral costs and emissions for the situation in which subsets of states adopt different types of plans would require many additional assumptions regarding which states adopt which plan types and the specific features of those plans. The effect on the relative costs of generation across states will be sensitive to these analytical choices, and therefore so will the estimated results regarding the direction and magnitude of state plan variation on aggregate sectoral costs and emissions.

The mere existence of variation among the design of state plans would not be sufficient to conclude that there will be a notable change in emissions relative to a case with less variation. The ultimate impact of the variation will depend upon the specific plan approaches, such as the way mass-based states allocate allowances, the state's goals, as well as the states' existing generating fleets, the transmission grid, spatial variation in future electricity demand, and the degree of ERC and allowance trading available within the system, amongst other variables.

There are other features of the requirements of state plans in this final rulemaking that would influence the scope of emissions changes that may result from states adopting a mix of

mass and rate-based plans. For example, this final rulemaking also requires that states adopting mass-based plans include a method for addressing leakage to new fossil-fired generation. These approaches are described in the preamble for this final rule. If states adopt programs to address leakage within their state, those programs may lead to reduced generation by EGUs in neighboring rate-based states (relative to the scenario where those plans were not in place). For example, as shown in Burtraw et al. (2015) and Demailly and Quirion (2006), as well as other related studies, output-based allocation to sources covered by a mass requirement would lead to reduced production by sources subject to rate-based (or no) regulation.

3.11 Limitations of Analysis

EPA's modeling is based on expert judgment of various input assumptions for variables whose outcomes are in fact uncertain. As a general matter, the Agency reviews the best available information from engineering studies of air pollution controls, the ability to improve operating efficiency, and new capacity construction costs to support a reasonable modeling framework for analyzing the cost, emission changes, and other impacts of regulatory actions.

The costs presented in this RIA include both the IPM-projected annualized estimates of private compliance costs as well as the estimated costs incurred by utilities and program participants to achieve demand-side energy efficiency improvements. The demand-side energy efficiency costs are developed based on a review of energy efficiency data and studies, and expert judgment. The EPA recognizes that significant variation exists in these analyses reflecting data and methodological limitations. The method used for estimating the demand-side energy efficiency costs is discussed in more detail in the Demand-Side Energy Efficiency Technical Support Document (TSD). The evaluation, measurement and verification (EM&V) of demand-side energy efficiency is addressed in the section VIII, State Plans, of the preamble for the final rule.

The base case electricity demand in IPM v.5.15 is calibrated to reference case demand in AEO 2015. AEO 2015 demand may reflect, to some extent, a continuation of the impacts of state demand-side energy efficiency policies but does not explicitly represent the most significant existing state policies in this area (e.g., energy efficiency resource standards). To some degree, the implicit representation of state policies in the EPA's base case alters the impacts assessment,

but the direction and magnitude of change is not known with certainty. This issue is discussed in the Demand-Side Energy Efficiency TSD.

Cost estimates for the final emission guidelines are based on rigorous power sector modeling using ICF's Integrated Planning Model.⁸⁵ IPM assumes "perfect foresight" of market conditions over the time horizon modeled; to the extent that utilities and/or energy regulators misjudge future conditions affecting the economics of pollution control, costs may be understated as well.

One important element of the final CPP is the flexibility afforded to states as they develop requirements for their existing emitting sources. Each state has discretion on how to best achieve the standards of performance and/or state goals. As such, states can apply requirements to sources that achieve greater reductions than required during the interim period, and use those earlier reductions in the final period (i.e., banking of reductions).

In the analysis and modeling for the RIA, such flexibilities were not explicitly modeled in the compliance scenarios. Doing so would require additional assumptions about the specific opportunities states may choose to adopt in their plans, including the form of the standard that states apply, the manner in which it is applied, and the economic signal that such a mechanism provides to sources over time, such that sources would have an incentive to make greater reductions earlier. As previously stated, the analysis in the RIA is intended to be illustrative to inform the broad impacts of the rule across the power sector, and not intended to forecast the specific approaches that individual states might choose, and how sources might prefer to achieve the emission reductions to reflect each state plan in response to particular policy signals or requirements. Not representing banking of earlier reductions into the final period captures this uncertainty that there is inadequate and incomplete information at this time regarding state plans in the analytic approach.

The analysis does not fully reflect the potential under the final rule for recognition of pre-compliance emission reduction measures. Under the final rule, states implementing a rate-based plan can recognize eligible emission reduction measures, including RE and demand-side energy

⁸⁵ Full documentation for IPM can be found at <<http://www.epa.gov/powersectormodeling>>.

efficiency, implemented after 2012 for the emission reductions those measures provide during the interim and final performance periods (see preamble Sec. VIII.K.1). In the analysis, this treatment is appropriately applied in the compliance period to generation from renewable capacity built after 2012. However, demand-side EE is limited to recognition of impacts occurring in the compliance period that result from investments in demand-side EE that are assumed to begin after 2019 (as represented in the illustrative demand-side EE plan scenario). Additionally, under the final rule, states will have the opportunity to recognize certain RE and demand-side EE measures implemented after the effective date of the rule for the emission reductions they provide in 2020-2021 through the Clean Energy Incentive Program (see preamble Sec. VIII.B.2). By committing to recognize these actions in 2020-2021, states will have access to a capped pool of additional rate-based ERCs and mass-based allowances, based on their plan type. The Clean Energy Incentive Program is not reflected in this analysis.

The illustrative mass-based implementation scenario presented in this chapter includes an RE set-aside, which is only one component of a potential approach to address leakage to new sources. Please see section VIII of the preamble for a description of how states must show that they are addressing leakage under mass-based implementation.

3.12 Social Costs

As discussed in the EPA Guidelines for Preparing Economic Analyses, social costs are the total economic burden of a regulatory action. This burden is the sum of all opportunity costs incurred due to the regulatory action, where an opportunity cost is the value lost to society of any goods and services that will not be produced and consumed as a result of reallocating some resources towards pollution mitigation. Estimates of social costs may be compared to the social benefits expected as a result of a regulation to assess its net impact on society. The social costs of a regulatory action will not necessarily be equivalent to the expenditures associated with compliance. Nonetheless, here we use compliance costs as a proxy for social costs. This section provides a qualitative discussion of the relationship between social costs and compliance cost estimates presented in this chapter.

The cost estimates for the illustrative plan scenarios presented in this chapter are the sum of expenditures on demand-side energy efficiency and the change in expenditures required by the electricity sector to comply with the final emission guidelines. These two components are

estimated separately. The expenditures required to achieve the assumed demand reductions through demand-side energy efficiency programs are estimated using historical data, analysis, and expert judgment. The change in the expenditures required by the electricity sector to meet demand and maintain compliance are estimated by IPM and reflect both the reduction in electricity production costs due to the reduction in demand caused by the demand-side energy efficiency measures and the increase in electricity production costs required to achieve the additional emission reductions necessary to comply with the state goals.

As described in section 3.7.1, the illustrative plan approaches assume that, in achieving their goals, demand-side energy efficiency measures are adopted which lead to demand reductions in each year represented by the illustrative energy efficiency plan scenario. The estimated expenditures required to achieve those demand reductions through demand-side energy efficiency are presented in this chapter and detailed in the Demand-Side Energy Efficiency TSD. The social cost of achieving these energy savings comes in the form of increased expenditures on technologies and/or services that are required to lower electricity consumption beyond the business as usual. Under the assumption of complete and well-functioning markets, the expenditures required to reduce electricity consumption on the margin will represent society's opportunity cost of the resources required to produce the energy savings.

Due to the flexibility held by states in implementing their compliance with the final standards these energy efficiency expenditures may be borne by end-users through direct participant expenditures or electricity rate increases, or by producers through reductions in their profits. While the allocation of these expenditures between consumers and producers is important for understanding the distributional impact of potential compliance strategies, it does not necessarily affect the opportunity cost required for the production of the energy savings from a social perspective. However, specific design elements of demand-side energy efficiency measures included to address distributional outcomes may have an effect on the economic efficiency of the programs and therefore the social cost.

Another reason the expenditures associated with demand-side energy efficiency may differ from social costs is due to differences in the services provided by more energy efficient technologies and services adopted under the program relative to the baseline. For example, if under the program end-users adopted more energy efficient products which were associated with

quality or service attributes deemed less desirable, then there would be an additional welfare loss that should be accounted for in social costs but is not necessarily captured in the measure of expenditures. However, there is an analogous possibility that in some cases the quality of services, outside of the energy savings, provided by the more energy efficient products and practices are deemed more desirable by some end-users. For example, weatherization of buildings to reduced electricity demand associated with cooling will likely have a significant impact on natural gas use associated with heating. In either case, these real welfare impacts are not fully captured by end-use energy efficiency expenditure estimates.

The fact that such quality and service differences may exist in reality but may not be reflected in the price difference between more and less energy efficient products is one potential hypothesis for the energy paradox. The energy paradox is the observation that end-users do not always purchase products that are more energy efficient when the additional cost is less than the reduction in the net present value of expected electricity expenditures achieved by those products.⁸⁶ Such circumstances are present in the analysis presented in this chapter, whereby in some regions the base case and illustrative approaches suggest that cost of reducing demand through energy efficiency programs is less than the retail electricity price. In addition to heterogeneity in product services and consumer preferences, there are other explanations for the energy paradox, falling both within and outside the neoclassical rational expectations paradigm that is used in benefit/cost analysis. The Demand-Side Energy Efficiency TSD discusses the energy paradox and provides additional hypothesis for why consumers may not make energy efficiency investments that ostensibly seem to be in their own interest. The TSD discussion also provides details on how the presence of additional market failures can lead to levels of energy efficiency investment that may be too low from society's perspective even if that is not the case for the end-user. In such cases there is the potential for properly designed energy efficiency programs to address the source of under-investment, such as principal-agent problems where there is a disconnect between those making the purchase decision regarding energy efficient investments and energy use and those that would receive the benefits associated with reduced energy use through lower electricity bills.

⁸⁶ An analogous situation is present when some EGUs have assumed to have the ability to make heat rate improvements at a capital cost that is less than the anticipated fuel expenditure savings.

The other component of compliance cost reported in this chapter is the change in resource cost (i.e., expenditures) required by the electricity sector to fulfill the remaining demand while making additional CO₂ emissions reductions necessary to comply with the state goals. Included in the estimate of these compliance costs, estimated using IPM, are the cost reductions associated with the reduction in required electricity generation due to the demand reductions from demand-side energy efficiency measures and improvements in heat rate. By shifting the demand curve for electricity, demand-side energy efficiency reduces the production cost in the sector. The resource cost estimates from IPM therefore account for the increased cost of providing electricity, including changes in fuel prices associated with changes in their demand, while EGUs comply with their regulatory obligations (net of the reduction in their production costs due to lower demand resulting from demand-side energy efficiency measures).

3.13 References

- Burtraw, Dallas, Karen Palmer, Sophie Pan, and Anthony Paul. 2015. A Proximate Mirror: Greenhouse Gas Rules and Strategic Behavior under the U.S. Clean Air Act. Resources for the Future Discussion Paper 15-02. March 2015.
- Bushnell, James B., Stephen P. Holland, Jonathan E. Hughes, Christopher R. Knittel. 2015. Strategic Policy Choice in State-Level Regulation: The EPA's Clean Power Plan. National Bureau of Economic Research Working Paper No. w21259. June, 2015.
- Demailly, Damien, and Philippe Quirion. 2006 "CO₂ abatement, competitiveness and leakage in the European cement industry under the EU ETS: grandfathering versus output-based allocation." *Climate Policy* 6.1: 93-113.
- Regional Greenhouse Gas Initiative (RGGI). 2014. CO₂ Emissions from Electricity Generation and Imports in the Regional Greenhouse Gas Initiative: 2012 Monitoring Report. August 11, 2014. Accessed July 22, 2015:
http://www.rggi.org/docs/Documents/Elec_monitoring_report_2012_15_08_11.pdf
- U.S. EPA. 2010. EPA Guidelines for Preparing Economic Analyses Available at:
<<http://yosemite.epa.gov/ee/epa/eed.nsf/webpages/guidelines.htm>>. Accessed 7/11/2015.
- U.S. EPA. 2015. Technical Support Document (TSD) the Final Carbon Pollution Emission Guidelines for Existing Stationary Sources: Electric Utility Generating Units. Demand-Side Energy Efficiency.

U.S. EPA. 2015. Technical Support Document (TSD) the Final Carbon Pollution Emission Guidelines for Existing Stationary Sources: Electric Utility Generating Units. Resource Adequacy and Reliability Analysis.

APPENDIX 3A: ANALYSIS OF POTENTIAL UPSTREAM METHANE EMISSIONS CHANGES IN NATURAL GAS SYSTEMS AND COAL MINING

The purpose of this appendix is to describe the methodology for estimating upstream methane emissions related to natural gas systems and coal mining sectors that may result from the illustrative plan approaches examined in the Regulatory Impact Analysis (RIA). The US Environmental Protection Agency (EPA) assessed whether the net change in upstream methane emissions from natural gas and coal production is likely to be positive or negative and also assessed the potential magnitude of these upstream changes relative to CO₂ emissions reductions anticipated at power plants from the illustrative plan approaches examined in the RIA. In addition to estimating changes in upstream methane emissions, this assessment included estimating CO₂ from the flaring of methane, but did not examine other potential changes in other upstream greenhouse gas emissions changes from natural gas systems and coal mining sectors.

The methodologies used to project upstream emissions were previously developed for the purpose of the 2014 U.S. Climate Action Report, and were subject to peer review and public review as part of the publication of that report. In section 3A.1, the overall approach is described in brief. In section 3A.2, results are presented. Section 3A.3 discusses uncertainties and limitations of the analysis. Finally, section 3A.4 contains a bibliography of cited resources. In the RIA for the Clean Power Plan proposal (in then section 3A.3), we presented the detailed methodologies for how methane and flaring-related CO₂ projections were estimated for coal mining and natural gas systems. We rely on the same methods in this RIA, so we refer the interested reader to the proposal RIA⁸⁷ for the detailed methodological discussion. The calculations have been updated to reflect input data from the most recent U.S. GHG Inventory, published in April 2015.

⁸⁷ Clean Power Plan proposal RIA can be found at < <http://www2.epa.gov/sites/production/files/2014-06/documents/20140602ria-clean-power-plan.pdf>>.

3A.1 General Approach

3A.1.1 Analytical Scope

Upstream methane and flaring-related CO₂ emissions associated with coal mining and natural gas systems were estimated for 2025 through 2030 using methodologies developed for the 2014 U.S. Climate Action Report (U.S. Department of State 2014). The base year for the projections is 2013, as reported in the 2015 U.S. GHG Inventory (EPA 2015a). The projection methodologies use activity driver data outputs such as coal and natural gas production from the base case and policy scenarios generated by the Integrated Planning Model (IPM), which was used in the RIA to model illustrative plan approaches. The projection methodologies use similar activity data and emissions factors as are used in the U.S. Greenhouse Gas (GHG) Inventory.

The projection methodologies estimate reductions associated with both voluntary and regulatory programs affecting upstream methane-related emissions. In the case of the voluntary programs, the rate of reductions is based on the historical average decrease from these programs over recent years. In the case of regulatory reductions, the reductions are based on the reduction rates estimated in the RIAs of relevant regulations. The projections include emissions reductions projected to result from the 2012 Oil and Natural Gas New Source Performance Standards. The methodologies to estimate upstream emissions were subject to expert peer review and public review in the context of the 2014 U.S. Climate Action Report. For more information on the review, or for the detailed methodologies used for non-CO₂ source projections in that report, including methane-related emissions from coal production and natural gas systems, see “Methodologies for U.S. Greenhouse Gas Emissions Projections: Non-CO₂ and Non-Energy CO₂ Sources” (EPA, 2013). Uncertainties and limitations are discussed, including a side case which incorporates additional geographic information for estimating methane from coal mining.

The term “upstream emissions” in this document refers to vented, fugitive and flared emissions associated with fuel production, processing, transmission, storage, and distribution of fuels prior to fuel combustion in electricity plants. For this analysis, the EPA focused on upstream methane from the natural gas systems and coal mining sectors. In addition, the analysis included CO₂ resulting from flaring in natural gas production. This analysis does not assess other upstream GHG emissions changes, such as CO₂ emissions from the combustion of fuel used in

natural gas and coal production activities or other non-combustion CO₂ emissions from natural gas systems, such as vented CO₂ and CO₂ emitted from acid-gas removal processes.

Also, the EPA assessed potential upstream methane emissions from natural gas systems and coal mining sectors within the domestic U.S., but did not examine emissions from potential changes in upstream emissions generated by changes in natural gas and coal production, processing, and transportation activities outside of the US.⁸⁸ Last, the EPA did not assess potential changes in other upstream non-GHG emissions, such as nitrogen oxides, volatile organic compounds, and particulate matter. Table 3A-1 presents estimates of the upstream emissions discussed in this analyses for 2013, based on the 2015 U.S. GHG Inventory.

EPA defined the boundaries of this assessment in order to provide targeted insights into the potential net change in methane emissions from natural gas systems and coal production activities specifically. CO₂ emissions from flared methane are included because regulatory and voluntary programs influence the rate of methane flaring over time and the CO₂ remaining after flaring is a methane-related GHG. Because of the multiple strategies adopted in the illustrative plan approaches, a more comprehensive assessment of upstream GHG emissions would require examination of the broader power sector and related input markets and their potential changes in response to the rule. This analysis would be complex and likely subject to data limitations and substantial uncertainties. Rather, EPA chose to limit the scope of this upstream analysis to evaluate the potential for changes in GHG emissions that may be of significant scale relative to the impacts of the rule and for which EPA had previously-reviewed projection techniques, which are presented in detail below.

3A.1.2 Coal Mining Source Description

Within coal mining, this analysis covers fugitive methane emissions from coal mining (including pre-mining drainage) and post-mining activities (i.e., coal handling), including both underground and surface mining. Emissions from abandoned mines are not included. Energy-

⁸⁸ While the analysis does not estimate methane emissions changes outside of the United States, activity factors include imports and exports of natural gas to help estimate domestic methane emissions related to trade of natural gas, such as emissions from LNG terminals in the US or from pipelines transporting imported natural gas within the US (or transporting natural gas within the US while en route for export).

related CO₂ emissions, such as emissions from mining equipment and vehicles transporting coal are not included. Methane, which is contained within coal seams and the surrounding rock strata, is released into the atmosphere when mining operations reduce the pressure above and/or surrounding the coal bed. The quantity of methane emitted from these operations is a function of two primary factors: coal rank and coal depth. Coal rank is a measure of the carbon content of the coal, with higher coal ranks corresponding to higher carbon content and generally higher methane content. Pressure increases with depth and prevents methane from migrating to the surface; as a result, underground mining operations typically emit more methane than surface mining. In addition to emissions from underground and surface mines, post-mining processing of coal and abandoned mines also release methane. Post-mining emissions refer to methane retained in the coal that is released during processing, storage, and transport of the coal.

3A.1.3 Natural Gas Systems Source Description

Within natural gas systems, this analysis covers vented and fugitive methane emissions from the production, processing, transmission and storage, and distribution segments of the natural gas system. It also includes CO₂ from flaring of natural gas. Not included are vented and fugitive CO₂ emissions from natural gas systems, such as vented CO₂ emissions removed during natural gas processing, or energy-related CO₂ such as emissions from stationary or mobile combustion. The U.S. natural gas system encompasses hundreds of thousands of wells, hundreds of processing facilities, and over a million miles of transmission and distribution pipelines. Methane and non-combustion⁸⁹ CO₂ emissions from natural gas systems are generally process-related, with normal operations, routine maintenance, and system upsets being the primary contributors. There are four primary stages of the natural gas system which are briefly described below.

Production: In this initial stage, wells are used to withdraw raw gas from underground formations. Emissions arise from the wells themselves, gathering pipelines, and well-site gas treatment facilities (e.g., dehydrators, separators). Major emissions source categories within the production stage include pneumatic devices, gas wells with liquids unloading, and gas well

⁸⁹ In this document, consistent with IPCC accounting terminology, the term “combustion emissions” refers to the emissions associated with the combustion of fuel for useful heat and work, while “non-combustion emissions” refers to emissions resulting from other activities, including flaring and CO₂ removed from raw natural gas.

completions and re-completions (i.e., workovers) with hydraulic fracturing (EPA 2013). Flaring emissions account for the majority of the non-combustion CO₂ emissions within the production stage.

Processing: In this stage, natural gas liquids and various other constituents from the raw gas are removed, resulting in “pipeline-quality” gas, which is then injected into the transmission system. Fugitive methane emissions from compressors, including compressor seals, are the primary emissions source from this stage. In the U.S. GHG Inventory, the majority of non-combustion CO₂ emissions in the processing stage come from acid gas removal units, which are designed to remove CO₂ from natural gas.

Transmission and Storage: Natural gas transmission involves high-pressure, large-diameter pipelines that transport gas long distances from field production and processing areas to distribution systems or large-volume customers such as power plants or chemical plants. Compressor station facilities, which contain large reciprocating and turbine compressors, are used to move the gas throughout the U.S. transmission system. Fugitive methane emissions from these compressor stations and from metering and regulating stations account for the majority of the emissions from this stage. Pneumatic devices and non-combusted engine exhaust are also sources of methane emissions from transmission facilities. Natural gas is also injected and stored in underground formations, or liquefied and stored in above-ground tanks, during periods of lower demand (e.g., summer), and withdrawn, processed, and distributed during periods of higher demand (e.g., winter). Compressors and dehydrators are the primary contributors to emissions from these storage facilities. Emissions from LNG import terminals are included within the transportation and storage stage.

Distribution: Distribution pipelines take the high-pressure gas from the transmission system at “city gate” stations, reduce the pressure, and then distribute the gas through primarily underground mains and service lines to individual end users.

Table 3A-1. Base Year Upstream Methane-Related Emissions in the U.S. GHG Inventory

Emissions Source	2013 Emissions (million short tons CO₂ Eq.)
Methane from Coal Mining	71.2
Underground Mining and Post-Mining	58.2
Surface Mining and Post-Mining	13.0
Methane from Natural Gas Systems	173.5
Production	51.8
Processing	25.0
Transmission and Storage	60.0
Distribution	36.7
CO₂ from flaring of natural gas	17.1

Source: 2015 U.S. GHG Inventory (EPA, 2015). A Global Warming Potential of 25 was used to convert methane emissions to CO₂ Eq.

In Table 3A-1, CO₂-equivalent methane emissions are presented using the Fourth Assessment Report Global Warming Potential (GWP) of 25.

3A.1.4 Illustrative Plan Approaches Examined

States will ultimately determine optimal approaches to comply with the goals established in this regulatory action. The RIA depicts illustrative plan approaches for the final emissions guidelines, reflecting a rate-based illustrative plan or mass-based illustrative plan approach.

3A.1.5 Activity Drivers

IPM-based activity driver projections from base case and illustrative plan approaches underlie the estimates of upstream methane emissions. These activity drivers include domestic coal and natural gas production, imports and exports, and natural gas consumption. Table 3A-2 and Table 3A-3 summarize the IPM-based coal and natural gas production activity driver results from the baseline and illustrative scenario for the final guidelines.⁹⁰

Under the final guidelines, both the rate-based and mass-based illustrative plan approaches result in reduced coal production and little change in natural gas production. We estimate that the illustrative plan approaches will result in reductions in coal production of 5 to 6 percent in 2020, 12 to 15 percent in 2025 and 21 to 22 percent in 2030, relative to base case coal production.

⁹⁰ Uncertainties related to activity drivers are discussed in the uncertainties and limitations section.

Natural gas production in the illustrative plan approaches change by 1 percent or less in each of the years of analysis relative to production in the base case.

Table 3A-2. Projected Coal Production Impacts

	Coal Production (million short tons)			Coal Production Change from Base Case (million short tons)			Coal Production Percent Change from Base Case		
	2020	2025	2030	2020	2025	2030	2020	2025	2030
Base Case	832.4	828.7	860.1						
Rate-based	791.5	725.7	674.4	-41.0	-103.0	-186.0	-5%	-12%	-22%
Mass-based	779.9	705.6	678.9	-52.0	-123.0	-181.0	-6%	-15%	-21%

Table 3A-3. Projected Natural Gas Production Impacts

	Dry Gas Production (trillion cubic feet)			Dry Gas Production Change from Base Case (trillion cubic feet)			Dry Gas Production Percent Change from Base Case		
	2020	2025	2030	2020	2025	2030	2020	2025	2030
Base Case	28.9	30.8	33.0						
Rate-based	29.1	30.7	32.9	+0.2	-0.1	-0.1	+1%	0%	0%
Mass-based	29.2	30.8	32.6	+0.3	+0.0	-0.4	+1%	0%	-1%

3A.2 Results

The analytical results (Table 3A-4) for the final guidelines indicates decreases in methane emissions from coal mining of 8 to 9 million short tons CO₂ Eq. in 2025, and about 14 million short tons CO₂ Eq. in 2030. Methane from natural gas systems decreases relative to the base case by 0 to 1 million short tons CO₂ Eq. in 2025 and 1 to 2 million short tons CO₂ Eq. in 2030. CO₂ from flaring in natural gas production does not show significant change relative to the base case.

Based on the actions modelled in the illustrative plan approaches, upstream methane emissions and CO₂ emissions are predicted to decline (see Table 3A-4). The final guidelines are predicted to result in a net emissions reduction of 8 to 9 million short tons CO₂ Eq. in 2025 and a net emissions reduction of 15 to 16 million short tons CO₂ Eq. in 2030. These net emissions changes represent the sum of changes in methane from coal mining, methane from natural gas systems, and CO₂ from flaring in natural gas production. The projections include voluntary and

regulatory activities to reduce emissions from coal mining and natural gas and oil systems, including the 2012 Oil and Natural Gas NSPS. In addition, the EPA plans to issue a proposed rule later this summer that would build on its 2012 Oil and Gas NSPS. When these standards are finalized and implemented, they would further reduce projected emissions from natural gas and oil systems.

Table 3A-4. Potential Upstream Emissions Changes

	Emissions (million short tons CO ₂ Eq.)		
	2020	2025	2030
Rate-based			
Methane from Coal Mining	-3.0	-7.5	-14.0
Methane from Natural Gas Systems	+1.1	-0.8	-0.6
CO ₂ from NG flaring	+0.2	-0.1	-0.1
Total Methane + CO₂	-1.7	-8.4	-14.8
Mass-based			
Methane from Coal Mining	-3.8	-9.0	-13.7
Methane from Natural Gas Systems	+1.5	-0.1	-2.2
CO ₂ from NG flaring	+0.2	+0.0	-0.3
Total Methane + CO₂	-2.2	-9.0	-16.1

Note: A Global Warming Potential of 25 was used to convert methane emissions to CO₂ Eq.

3A.3 Uncertainties and Limitations

Projections of upstream methane emissions and CO₂ emitted from flaring of methane are subject to a range of uncertainties and limitations. These uncertainties and limitations include estimating the effect of the plan approach on activity drivers, uncertainty in base year emissions, and uncertainties in changes in emissions factors over relatively long periods of time. For example, EPA's application of IPM relies on EIA projections for coal imports and exports. Consequently, coal imports and exports are not able to fully respond within the IPM framework to significant fluctuations in power sector coal demand. To the extent international markets may be expected to offset reduced domestic coal demand, changes in U.S. upstream emissions as a result of the policy scenarios would be smaller than what is presented here.

Discussion of uncertainty in historical estimates of emissions from coal mining and natural gas systems can be found in the 2015 U.S. GHG Inventory. Projected changes in activity drivers and emissions factors are based on a combination of policy, macroeconomic, energy market, and technology factors which are uncertain in both baseline and illustrative plan approaches.

Relatively higher or lower economic growth, or changes in the relative prices or availability of various technologies could result in alternative estimates in the net change in upstream methane emissions and related CO₂ emissions.

3A.4 References

- IPCC. 2006. *2006 IPCC Guidelines for National Greenhouse Gas Inventories*. Available at <<http://www.ipcc-nggip.iges.or.jp/public/2006gl/>>. Accessed June 4, 2015.
- U. S. Department of State. 2014. *2014 U.S. Climate Action Report to the UNFCCC*. Available at <<http://www.state.gov/e/oes/rls/rpts/car6/index.htm>>. Accessed June 4, 2015.
- U. S. Environmental Protection Agency (U.S. EPA). 1993. *Anthropogenic Methane Emissions in the United States, Estimates for 1990: Report to Congress*. EPA-430-R-93-003.
- U. S. Environmental Protection Agency (U.S. EPA). 2011. *Oil and Natural Gas Sector: Standards of Performance for Crude Oil and Natural Gas Production, Transmission, and Distribution: Background Technical Support Document for the Proposed Standards*. Available at <<http://epa.gov/airquality/oilandgas/pdfs/20110728tsd.pdf>>. Accessed June 4, 2015.
- U. S. Environmental Protection Agency (U.S. EPA). 2012a. *Oil and Natural Gas Sector: New Source Performance Standards and National Emission Standards for Hazardous Air Pollutants Reviews*. 40 CFR Parts 60 and 63 [EPA-HQ-OAR-2010-0505; FRL-9665-1], RIN 2060-AP76. Available at <<http://www.gpo.gov/fdsys/pkg/FR-2012-08-16/pdf/2012-16806.pdf>>. Accessed June 4, 2015.
- U. S. Environmental Protection Agency (U.S. EPA). 2012b. *Oil and Natural Gas Sector: Standards of Performance for Crude Oil and Natural Gas Production, Transmission, and Distribution: Background Supplemental Technical Support Document for the Final New Source Performance Standards*. Available at <<http://epa.gov/airquality/oilandgas/pdfs/20120418tsd.pdf>>. Accessed June 4, 2015.
- U. S. Environmental Protection Agency (U.S. EPA). 2015. *Inventory of U.S. Greenhouse Gas Emissions and Sinks: 1990–2013*. EPA-430-R-15-004. Available at <<http://www.epa.gov/climatechange/ghgemissions/usinventoryreport.html>>. Accessed June 4, 2015.
- U. S. Environmental Protection Agency (U.S. EPA). 2013. *Methodologies for U.S. Greenhouse Gas Emissions Projections: Non-CO₂ and Non-Energy CO₂ Sources*. Available at <<http://www.state.gov/documents/organization/219472.pdf>> Accessed June 4, 2015.

CHAPTER 4: ESTIMATED CLIMATE BENEFITS AND HUMAN HEALTH CO-BENEFITS

4.1 Introduction

Implementing the Final Carbon Pollution Emission Guidelines for Existing Stationary Sources: Electric Utility Generating Units (hereafter referred to as the “final emission guidelines” or “Clean Power Plan Final Rule”) is expected to reduce emissions of carbon dioxide (CO₂) and have ancillary human health benefits (i.e., co-benefits) associated with lower ambient concentrations of criteria air pollutants. This chapter describes the methods used to estimate the monetized climate benefits and the monetized air quality health co-benefits associated with reducing exposure to ambient fine particulate matter (PM_{2.5}) and ozone by reducing emissions of precursor pollutants (i.e., sulfur dioxide (SO₂), nitrogen dioxide (NO₂), and directly emitted PM_{2.5}). Data, resource, and methodological limitations prevent the EPA from monetizing the benefits from several important co-benefit categories, including reducing direct exposure to SO₂, NO₂, and hazardous air pollutants (HAP), as well as ecosystem effects and visibility impairment. We qualitatively discuss these unquantified benefits in this chapter.

This chapter provides estimates of the monetized climate benefits and air quality health co-benefits associated with emission reductions for the illustrative rate-based and mass-based illustrative plan approaches across several analysis years and discount rates. The estimated benefits associated with these emission reductions are beyond those achieved by previous EPA rulemakings, including the Mercury and Air Toxics Standards (MATS).

4.2 Estimated Climate Benefits from CO₂

The primary goal of the final emission guidelines is to reduce emissions of CO₂. In this section, we provide a brief overview of the 2009 Endangerment Finding and climate science assessments released since then. We also provide information regarding the economic valuation of CO₂ using the Social Cost of Carbon (SC-CO₂), a metric that estimates the monetary value of impacts associated with marginal changes in CO₂ emissions in a given year. Table 4-1 summarizes the quantified and unquantified climate benefits in this analysis.

Table 4-1. Climate Effects

Benefits Category	Specific Effect	Effect Has Been Quantified	Effect Has Been Monetized	More Information
Improved Environment				
Reduced climate effects	Global climate impacts from CO ₂	— ¹	✓	SCC TSD
	Climate impacts from ozone and black carbon (directly emitted PM)	—	—	Ozone ISA, PM ISA ²
	Other climate impacts (e.g., other GHGs such as methane, aerosols, other impacts)	—	—	IPCC ²

¹ The global climate and related impacts of CO₂ emissions changes, such as sea level rise, are estimated within each integrated assessment model as part of the calculation of the SC-CO₂. The resulting monetized damages, which are relevant for conducting the benefit-cost analysis, are used in this RIA to estimate the welfare effects of quantified changes in CO₂ emissions.

² We assess these co-benefits qualitatively because we do not have sufficient confidence in available data or methods.

4.2.1 Climate Change Impacts

Through the implementation of CAA regulations, the EPA addresses the negative externalities caused by air pollution. In 2009, the EPA Administrator found that elevated concentrations of greenhouse gases in the atmosphere may reasonably be anticipated both to endanger public health and to endanger public welfare. It is these adverse impacts that make it necessary for the EPA to regulate GHGs from EGU sources. The preamble summarizes the public health and public welfare impacts that were detailed in the 2009 Endangerment Finding. For health, these include the increased likelihood of heat waves, negative impacts on air quality, more intense hurricanes, more frequent and intense storms and heavy precipitation, and impacts on infectious and waterborne diseases. For welfare, these include reduced water supplies in some regions, increased water pollution, increased occurrences of floods and droughts, rising sea levels and damage to coastal infrastructure, increased peak electricity demand, changes in ecosystems, and impacts on indigenous communities.

The preamble also summarizes new scientific assessments and recent climatic observations. Major scientific assessments released since the 2009 Endangerment Finding have improved scientific understanding of the climate, and provide even more evidence that GHG emissions endanger public health and welfare for current and future generations. The National Climate Assessment (NCA3), in particular, assessed the impacts of climate change on human health in the United States, finding that, Americans will be impacted by “increased extreme

weather events, wildfire, decreased air quality, threats to mental health, and illnesses transmitted by food, water, and disease-carriers such as mosquitoes and ticks.” These assessments also detail the risks to vulnerable groups such as children, the elderly and low income households.

Furthermore, the assessments present an improved understanding of the impacts of climate change on public welfare, higher projections of future sea level rise than had been previously estimated, a better understanding of how the warmth in the next century may reach levels that would be unprecedented relative to the preceding millions of years of history, and new assessments of the impacts of climate change on permafrost and ocean acidification. The impacts of GHG emissions will be realized worldwide, independent upon their location of origin, and impacts outside of the United States will produce consequences relevant to the United States.

4.2.2 *Social Cost of Carbon*

We estimate the global social benefits of CO₂ emission reductions expected from the final emission guidelines using the SC-CO₂ estimates presented in the *Technical Support Document: Technical Update of the Social Cost of Carbon for Regulatory Impact Analysis Under Executive Order 12866 (May 2013, Revised July 2015)* (“current TSD”).⁹¹ We refer to these estimates, which were developed by the U.S. government, as “SC-CO₂ estimates.” The SC-CO₂ is a metric that estimates the monetary value of impacts associated with marginal changes in CO₂ emissions in a given year. It includes a wide range of anticipated climate impacts, such as net changes in agricultural productivity and human health, property damage from increased flood risk, and changes in energy system costs, such as reduced costs for heating and increased costs for air conditioning. It is typically used to assess the avoided damages as a result of regulatory actions (i.e., benefits of rulemakings that lead to an incremental reduction in cumulative global CO₂ emissions).

⁹¹ Docket ID EPA-HQ-OAR-2013-0495, Technical Support Document: *Technical Update of the Social Cost of Carbon for Regulatory Impact Analysis Under Executive Order 12866*, Interagency Working Group on Social Cost of Carbon, with participation by Council of Economic Advisers, Council on Environmental Quality, Department of Agriculture, Department of Commerce, Department of Energy, Department of Transportation, Environmental Protection Agency, National Economic Council, Office of Energy and Climate Change, Office of Management and Budget, Office of Science and Technology Policy, and Department of Treasury (May 2013, Revised July 2015). Available at: <<https://www.whitehouse.gov/sites/default/files/omb/inforeg/scc-tsd-final-july-2015.pdf>> Accessed 7/11/2015.

The SC-CO₂ estimates used in this analysis were developed over many years, using the best science available, and with input from the public. Specifically, an interagency working group (IWG) that included the EPA and other executive branch agencies and offices used three integrated assessment models (IAMs) to develop the SC-CO₂ estimates and recommended four global values for use in regulatory analyses. The SC-CO₂ estimates were first released in February 2010 and updated in 2013 using new versions of each IAM. As discussed further below, the IWG published two minor corrections to the SC-CO₂ estimates in July 2015.

The SC-CO₂ estimates were developed using an ensemble of the three most widely cited integrated assessment models in the economics literature with the ability to estimate the SC-CO₂. A key objective of the IWG was to draw from the insights of the three models while respecting the different approaches to linking GHG emissions and monetized damages taken by modelers in the published literature. After conducting an extensive literature review, the interagency group selected three sets of input parameters (climate sensitivity, socioeconomic and emissions trajectories, and discount rates) to use consistently in each model. All other model features were left unchanged, relying on the model developers' best estimates and judgments, as informed by the literature. Specifically, a common probability distribution for the equilibrium climate sensitivity parameter, which informs the strength of climate's response to atmospheric GHG concentrations, was used across all three models. In addition, a common range of scenarios for the socioeconomic parameters and emissions forecasts were used in all three models. Finally, the marginal damage estimates from the three models were estimated using a consistent range of discount rates, 2.5, 3.0, and 5.0 percent. See the 2010 TSD for a complete discussion of the methods used to develop the estimates and the key uncertainties, and the current TSD for the latest estimates.⁹²

The SC-CO₂ estimates represent global measures because of the distinctive nature of the climate change, which is highly unusual in at least three respects. First, emissions of most GHGs contribute to damages around the world independent of the country in which they are emitted. The SC-CO₂ must therefore incorporate the full (global) damages caused by GHG emissions to address the global nature of the problem. Second, the U.S. operates in a global and highly

⁹² See <https://www.whitehouse.gov/omb/oira/social-cost-of-carbon> for both TSDs.

interconnected economy, such that impacts on the other side of the world can affect our economy. This means that the true costs of climate change to the U.S. are larger than the direct impacts that simply occur within the U.S. Third, climate change represents a classic public goods problem because each country's reductions benefit everyone else and no country can be excluded from enjoying the benefits of other countries' reductions, even if it provides no reductions itself. In this situation, the only way to achieve an economically efficient level of emissions reductions is for countries to cooperate in providing mutually beneficial reductions beyond the level that would be justified only by their own domestic benefits. In reference to the public good nature of mitigation and its role in foreign relations, thirteen prominent academics noted that these "are compelling reasons to focus on a global SCC" in a recent article on the SCC (Pizer et al., 2014). In addition, as noted in OMB's Response to Comments on the SCC, there is no bright line between domestic and global damages. Adverse impacts on other countries can have spillover effects on the United States, particularly in the areas of national security, international trade, public health and humanitarian concerns.⁹³

The 2010 TSD noted a number of limitations to the SC-CO₂ analysis, including the incomplete way in which the integrated assessment models capture catastrophic and non-catastrophic impacts, their incomplete treatment of adaptation and technological change, uncertainty in the extrapolation of damages to high temperatures, and assumptions regarding risk aversion. Currently integrated assessment models do not assign value to all of the important physical, ecological, and economic impacts of climate change recognized in the climate change literature due to a lack of precise information on the nature of damages and because the science incorporated into these models understandably lags behind the most recent research.⁹⁴ The limited amount of research linking climate impacts to economic damages makes the modeling exercise even more difficult. These individual limitations do not all work in the same direction in terms of their influence on the SC-CO₂ estimates, though taken together they suggest that the

⁹³ See Endangerment and Cause or Contribute Findings for Greenhouse Gases Under Section 202(a) of the Clean Air Act, 74 Fed. Reg. 66,496, 66,535 (Dec. 15, 2009) and National Research Council 2013a.

⁹⁴ Climate change impacts and SCC modeling is an area of active research. For example, see: (1) Howard, Peter, "Omitted Damages: What's Missing from the Social Cost of Carbon." March 13, 2014, http://costofcarbon.org/files/Omitted_Damages_Whats_Missing_From_the_Social_Cost_of_Carbon.pdf; and (2) Electric Power Research Institute, "Understanding the Social Cost of carbon: A Technical Assessment," October 2014, www.epri.com.

SC-CO₂ estimates are likely conservative. In particular, the IPCC Fourth Assessment Report (2007), which was the most current IPCC assessment available at the time of the IWG's 2009-2010 review, concluded that "It is very likely that [SC-CO₂ estimates] underestimate the damage costs because they cannot include many non-quantifiable impacts." Since then, the peer-reviewed literature has continued to support this conclusion. For example, the IPCC Fifth Assessment report observed that SC-CO₂ estimates continue to omit various impacts that would likely increase damages. The 95th percentile estimate was included in the recommended range for regulatory impact analysis to address these concerns.

The EPA and other agencies have continued to consider feedback on the SC-CO₂ estimates from stakeholders through a range of channels, including public comments on this rulemaking and others that use the SC-CO₂ in supporting analyses and through regular interactions with stakeholders and research analysts implementing the SC-CO₂ methodology used by the interagency working group. The SC-CO₂ comments received on this rulemaking covered a wide range of topics including the technical details of the modeling conducted to develop the SC-CO₂ estimates, the aggregation and presentation of the SC-CO₂ estimates, and the process by which the SC-CO₂ estimates were derived. Many but not all commenters were supportive of the SC-CO₂ and its application to this rulemaking. Commenters also provided constructive recommendations for potential opportunities to improve the SC-CO₂ estimates in future updates. The EPA Response to Comments document provides a summary and response to the SC-CO₂ comments submitted to this rulemaking.

Many of the comments EPA received were similar to those that OMB's Office of Information and Regulatory Affairs received in response to a separate request for public comment on the approach used to develop the estimates. After careful evaluation of the full range of comments submitted to OMB's Office of Information and Regulatory Affairs, the IWG continues to recommend the use of these SC-CO₂ estimates in regulatory impact analysis. With the release of the response to comments⁹⁵, the IWG announced plans to obtain expert independent advice from the National Academies of Sciences, Engineering, and Medicine

⁹⁵ See <https://www.whitehouse.gov/sites/default/files/omb/inforeg/scc-response-to-comments-final-july-2015.pdf>

(Academies) to ensure that the SC-CO₂ estimates continue to reflect the best available scientific and economic information on climate change.⁹⁶ The Academies' process will be informed by the public comments received and focus on the technical merits and challenges of potential approaches to improving the SC-CO₂ estimates in future updates.

Concurrent with OMB's publication of the response to comments on SC-CO₂ and announcement of the Academies process, OMB posted a revised TSD that includes two minor technical corrections to the current estimates. One technical correction addressed an inadvertent omission of climate change damages in the last year of analysis (2300) in one model and the second addressed a minor indexing error in another model. On average the revised SC-CO₂ estimates are one dollar less than the mean SC-CO₂ estimates reported in the November 2013 revision to the May 2013 TSD. The change in the estimates associated with the 95th percentile estimates when using a 3% discount rate is slightly larger, as those estimates are heavily influenced by the results from the model that was affected by the indexing error.

The four SC-CO₂ estimates are as follows: \$12, \$40, \$60, and \$120 per short ton of CO₂ emissions in the year 2020 (2011\$).⁹⁷ The first three values are based on the average SC-CO₂ from the three IAMs, at discount rates of 5, 3, and 2.5 percent, respectively. SC-CO₂ estimates for several discount rates are included because the literature shows that the SC-CO₂ is quite sensitive to assumptions about the discount rate, and because no consensus exists on the appropriate rate to use in an intergenerational context (where costs and benefits are incurred by different generations). The fourth value is the 95th percentile of the SC-CO₂ from all three models at a 3 percent discount rate. It is included to represent higher-than-expected impacts from temperature change further out in the tails of the SC-CO₂ distribution (representing less likely, but potentially catastrophic, outcomes).

⁹⁶ See <https://www.whitehouse.gov/blog/2015/07/02/estimating-benefits-carbon-dioxide-emissions-reductions>.

⁹⁷ The current version of the TSD is available at: <https://www.whitehouse.gov/sites/default/files/omb/inforeg/scc-tds-final-july-2015.pdf>. The 2010 and 2013 TSDs present SC-CO₂ in 2007\$ per metric ton. The unrounded estimates from the current TSD were adjusted to (1) 2011\$ using GDP Implicit Price Deflator (1.061374), http://www.bea.gov/iTable/index_nipa.cfm and (2) short tons using the conversion factor of 0.90718474 metric tons in a short ton. The estimates presented in the RIA were rounded to two significant digits.

Table 4-2 presents the global SC-CO₂ estimates in short tons for the years 2015 to 2050.⁹⁸ In order to calculate the dollar value for emission reductions, the SC-CO₂ estimate for each emissions year would be applied to changes in CO₂ emissions for that year, and then discounted back to the analysis year using the same discount rate used to estimate the SC-CO₂.⁹⁹ The SC-CO₂ increases over time because future emissions are expected to produce larger incremental damages as physical and economic systems become more stressed in response to greater climate change. Note that the interagency group estimated the growth rate of the SC-CO₂ directly using the three integrated assessment models rather than assuming a constant annual growth rate. This helps to ensure that the estimates are internally consistent with other modeling assumptions. Tables 4-3 through 4-5 report the incremental climate benefits estimated in three analysis years (2020, 2025, and 2030) for the rate-based and mass-based illustrative plan approaches.

Table 4-2. Social Cost of CO₂, 2015-2050 (in 2011\$ per short ton)*

Year	Discount Rate and Statistic			
	5% Average	3% Average	2.5% Average	3% (95th percentile)
2015	\$11	\$35	\$54	\$100
2020	\$12	\$40	\$60	\$120
2025	\$13	\$44	\$65	\$130
2030	\$15	\$48	\$70	\$150
2035	\$17	\$53	\$75	\$160
2040	\$20	\$58	\$81	\$180
2045	\$22	\$62	\$86	\$190
2050	\$25	\$66	\$91	\$200

* These SC-CO₂ values are stated in \$/short ton and rounded to two significant figures. The SC-CO₂ values have been converted from \$/metric ton to \$/short ton using the conversion factor 0.90718474 metric tons in a short ton for consistency with this rulemaking. This calculation does not change the underlying methodology nor does it change the meaning of the SC-CO₂ estimates. For both metric and short tons denominated SC-CO₂ estimates, the estimates vary depending on the year of CO₂ emissions and are defined in real terms, i.e., adjusted for inflation using the GDP implicit price deflator.

⁹⁸ For consistency with this rulemaking, the SC-CO₂ values have been converted from \$/metric ton to \$/short ton and applied to the CO₂ reductions (short tons) to estimate climate benefits. Specifically, the \$/metric ton estimates were multiplied by the conversion factor 0.90718474 metric tons in a short ton to yield \$/short ton. This calculation does not change the underlying methodology, the meaning of the SC-CO₂ estimates, or the final benefits estimates.

⁹⁹ This analysis considered the climate impacts of only CO₂ emission change. As discussed below, the climate impacts of other pollutants were not calculated for the proposed guidelines. While CO₂ is the dominant GHG emitted by the sector, we recognize the representative facilities within these comparisons may also have different emission rates for other climate forcings that will serve a minor role in determining the overall social cost of generation.

Table 4-3. Estimated Global Climate Benefits of CO₂ Reductions for the Final Emission Guidelines in 2020 (billions of 2011\$)*

Discount rate and statistic	Rate-Based	Mass-Based
Million short tons of CO ₂ reduced	69	82
5% (average)	\$0.80	\$0.94
3% (average)	\$2.8	\$3.3
2.5% (average)	\$4.1	\$4.9
3% (95 th percentile)	\$8.2	\$9.7

* The SC-CO₂ values are dollar-year and emissions-year specific. SC-CO₂ values represent only a partial accounting of climate impacts.

Table 4-4. Estimated Global Climate Benefits of CO₂ Reductions for the Final Emission Guidelines in 2025 (billions of 2011\$)*

Discount rate and statistic	Rate-Based	Mass-Based
Million short tons of CO ₂ reduced	232	264
5% (average)	\$3.1	\$3.6
3% (average)	\$10	\$12
2.5% (average)	\$15	\$17
3% (95 th percentile)	\$31	\$35

* The SC-CO₂ values are dollar-year and emissions-year specific. SC-CO₂ values represent only a partial accounting of climate impacts.

Table 4-5. Estimated Global Climate Benefits of CO₂ Reductions for the Final Emission Guidelines in 2030 (billions of 2011\$)*

Discount rate and statistic	Rate-Based	Mass-Based
Million short tons of CO ₂ reduced	415	413
5% (average)	\$6.4	\$6.4
3% (average)	\$20	\$20
2.5% (average)	\$29	\$29
3% (95 th percentile)	\$61	\$60

* The SC-CO₂ values are dollar-year and emissions-year specific. SC-CO₂ values represent only a partial accounting of climate impacts.

It is important to note that the climate benefits presented above are associated with changes in CO₂ emissions only. Implementing these final emission guidelines, however, will have an impact on the emissions of other pollutants that would affect the climate. Both predicting reductions in emissions and estimating the climate impacts of these other pollutants, however, is complex. The climate impacts of these other pollutants have not been calculated for the final emission guidelines.¹⁰⁰

¹⁰⁰ The SC-CO₂ estimates used in this analysis are designed to assess the climate benefits associated with changes in CO₂ emissions only.

The other emissions potentially reduced as a result of the final emission guidelines include other greenhouse gases (such as methane), aerosols and aerosol precursors such as black carbon, organic carbon, sulfur dioxide and nitrogen oxides, and ozone precursors such as nitrogen oxides and volatile organic carbon compounds. Changes in emissions of these pollutants (both increases and decreases) could directly result from changes in electricity generation, upstream fossil fuel extraction and transport, and/or downstream secondary market impacts. Reductions in black carbon or ozone precursors are projected to lead to further cooling, but reductions in the other aerosol species and precursors are projected to lead to warming. Therefore, changes in non-CO₂ pollutants could potentially augment or offset the climate benefits calculated here. These pollutants can act in different ways and on different timescales than carbon dioxide. For example, aerosols reflect (and in the case of black carbon, absorb) incoming radiation, whereas greenhouse gases absorb outgoing infrared radiation. In addition, these aerosols are thought to affect climate indirectly by altering properties of clouds. Black carbon can also deposit on snow and ice, darkening these surfaces and accelerating melting. In terms of lifetime, while carbon dioxide emissions can increase concentrations in the atmosphere for hundreds or thousands of years, many of these other pollutants are short lived and remain in the atmosphere for short periods of time ranging from days to weeks and can therefore exhibit large spatial and temporal variability.

While the EPA has not quantified the climate impacts of these other pollutants for the final emission guidelines, the Agency has analyzed the potential changes in upstream methane emissions from the natural gas and coal production sectors that may result from the illustrative plan approaches examined in this RIA in the appendix to Chapter 3. The EPA assessed whether the net change in upstream methane emissions from natural gas and coal production is likely to be positive or negative and also assessed the potential magnitude of changes relative to CO₂ emissions reductions anticipated at power plants. This assessment included CO₂ emissions from the flaring of methane, but did not evaluate potential changes in other combustion-related CO₂ emissions, such as emissions associated with drilling, mining, processing, and transportation in the natural gas and coal production sectors. This analysis found that the net upstream CH₄ emissions from natural gas systems and coal mines and CO₂ emissions from flaring of methane will likely decrease under the final emission guidelines. Furthermore, the analysis suggests that

the changes in upstream methane emissions are small relative to the changes in direct emissions from power plants.

4.3 Estimated Human Health Co-Benefits

In addition to reducing emissions of CO₂, implementing these final emission guidelines is expected to reduce emissions of SO₂ and NO_x, which are precursors to formation of ambient PM_{2.5}, as well as directly emitted fine particles.¹⁰¹ Therefore, reducing these emissions would also reduce human exposure to ambient PM_{2.5} and the incidence of PM_{2.5}-related health effects. In addition, in the presence of sunlight, NO_x and VOCs can undergo a chemical reaction in the atmosphere to form ozone. Depending on localized concentrations of volatile organic compounds (VOCs), reducing NO_x emissions would also reduce human exposure to ozone and the incidence of ozone-related health effects. Although we do not have sufficient data to quantify these impacts in this analysis, reducing emissions of SO₂ and NO_x would also reduce ambient exposure to SO₂ and NO₂ and their associated health effects, respectively. In this section, we provide an overview of the monetized PM_{2.5} and ozone-related co-benefits estimated for the final emission guidelines. A full description of the underlying data, studies, and assumptions is provided in the PM NAAQS RIA (U.S. EPA, 2012a) and Ozone NAAQS RIA (U.S. EPA, 2008b, 2010d). The estimated co-benefits associated with these emission reductions are beyond those achieved by previous EPA rulemakings, including MATS.

There are several important considerations in assessing the air quality-related health co-benefits for a climate-focused rulemaking. First, these estimated health co-benefits do not account for any climate-related air quality changes (e.g., increased ambient ozone associated with higher temperatures) but rather changes in precursor emissions affected by this rulemaking. Excluding climate-related air quality changes may underestimate ozone-related health co-benefits. It is unclear how PM_{2.5}-related health co-benefits would be impacted by excluding

¹⁰¹ In the RIA for the proposed rule, we estimated the health co-benefits associated with emission reductions of two categories of directly emitted particles: elemental carbon plus organic carbon (EC+OC) and crustal. Crustal emissions are composed of compounds associated with minerals and metals from the earth's surface, including carbonates, silicates, iron, phosphates, copper, and zinc. Often, crustal material represents particles not classified as one of the other species (e.g., organic carbon, elemental carbon, nitrate, sulfate, chloride, etc.). For this RIA, we did not estimate changes in emissions of directly emitted particles. As a result, quantified PM_{2.5} related benefits are underestimated by a relatively small amount. In the proposal RIA, the benefits from reductions in directly emitted PM_{2.5} were less than 10 percent of total monetized health co-benefits across all scenarios and years.

climate-related air quality changes since the science is unclear as to how climate change may affect PM_{2.5} exposure. Second, the estimated health co-benefits also do not consider temperature modification of PM_{2.5} and ozone risks (Roberts 2004; Ren 2006a, 2006b, 2008a, 2008b). Third, the estimated climate benefits reported in this RIA reflect global benefits, while the estimated health co-benefits are calculated for the contiguous U.S. only. Excluding temperature modification of air pollution risks and international air quality-related health benefits likely leads to underestimation of quantified health co-benefits (Anenberg et al, 2009, Jhun et al, 2014). Fourth, as noted earlier, we do not estimate the climate benefits associated with reductions in PM and O₃ precursors.

Implementing the final emission guidelines may lead to reductions in ambient PM_{2.5} concentrations below the National Ambient Air Quality Standards (NAAQS) for PM and ozone in some areas and assist other areas with attaining these NAAQS. Because the NAAQS RIAs (U.S. EPA, 2012a, 2008b, 2010d) also calculated PM and ozone benefits, there are important differences worth noting in the design and analytical objectives of each RIA. The NAAQS RIAs illustrate the potential costs and benefits of attaining a revised air quality standard nationwide based on an array of emission reduction strategies for different sources reflecting the application of known and unknown controls, incremental to implementation of existing regulations and controls needed to attain the current standards. In short, NAAQS RIAs hypothesize, but do not predict, the reduction strategies that States may choose to enact when implementing a revised NAAQS. The setting of a NAAQS does not directly result in costs or benefits, and as such, the EPA's NAAQS RIAs are merely illustrative and the estimated costs and benefits are not intended to be added to the costs and benefits of other regulations that result in specific costs of control and emission reductions. Some of the emissions reductions estimated to result from implementation of the final emission guidelines may achieve some of the air quality improvements that resulted from the hypothesized attainment strategies presented in the illustrative NAAQS RIAs. The emissions reductions from implementing the final emission guidelines will decrease the remaining amount of emissions reductions needed in non-attainment areas and reduce the costs and benefits attributable to meeting the NAAQS.

Similar to NAAQS RIAs, the emission reduction scenarios estimated for the final emission guidelines are also illustrative. In contrast to NAAQS RIAs, all of the emission reductions for the

illustrative plan approaches would occur in one well-characterized sector (i.e., the EGU sector). In general, the EPA is more confident in the magnitude and location of the emission reductions for rules which require specific emission reductions in a specific sector, for example, the recent Mercury and Air Toxics Standards. As such, emission reductions achieved under these types of promulgated rules will ultimately be reflected in the baseline of future NAAQS analyses, which would reduce the incremental costs and benefits associated with attaining revised future NAAQS. The EPA does not re-issue illustrative RIAs outside of the rulemaking process that retroactively update the baseline to account for implementation rules promulgated after an RIA was completed. For more information on the relationship between illustrative analyses, such as for the NAAQS and this final emission guidelines, and implementation rules, please see section 1.3 of the PM NAAQS RIA (U.S. EPA, 2012a).

4.3.1 *Health Impact Assessment for PM_{2.5} and Ozone*

The *Integrated Science Assessment for Particulate Matter* (PM ISA) (U.S. EPA, 2009b) identified the human health effects associated with ambient PM_{2.5} exposure, which include premature mortality and a variety of morbidity effects associated with acute and chronic exposures. Similarly, the *Integrated Science Assessment for Ozone and Related Photochemical Oxidants* (Ozone ISA) (U.S. EPA, 2013b) identified the human health effects associated with ambient ozone exposure, which include premature mortality and a variety of morbidity effects associated with acute and chronic exposures. Table 4-6 identifies the quantified and unquantified co-benefit categories captured in the EPA's health co-benefits estimates for reduced exposure to ambient PM_{2.5} and ozone. Although the table below does not list unquantified health effects such as those associated with exposure to SO₂, NO₂, and mercury nor welfare effects such as acidification and nutrient enrichment, these effects are described in detail in Chapters 5 and 6 of the PM NAAQS RIA (U.S. EPA, 2012a) and summarized later in this chapter. It is important to emphasize that the list of unquantified benefit categories is not exhaustive, nor is quantification of each effect complete.

Table 4-6. Human Health Effects of Ambient PM_{2.5} and Ozone

Category	Specific Effect	Effect Has Been Quantified	Effect Has Been Monetized	More Information	
Improved Human Health					
Reduced incidence of premature mortality from exposure to PM _{2.5}	Adult premature mortality based on cohort study estimates and expert elicitation estimates (age >25 or age >30)	✓	✓	PM ISA	
	Infant mortality (age <1)	✓	✓	PM ISA	
	Non-fatal heart attacks (age > 18)	✓	✓	PM ISA	
	Hospital admissions—respiratory (all ages)	✓	✓	PM ISA	
	Hospital admissions—cardiovascular (age >20)	✓	✓	PM ISA	
	Emergency room visits for asthma (all ages)	✓	✓	PM ISA	
	Acute bronchitis (age 8-12)	✓	✓	PM ISA	
	Lower respiratory symptoms (age 7-14)	✓	✓	PM ISA	
	Upper respiratory symptoms (asthmatics age 9-11)	✓	✓	PM ISA	
	Asthma exacerbation (asthmatics age 6-18)	✓	✓	PM ISA	
	Reduced incidence of morbidity from exposure to PM _{2.5}	Lost work days (age 18-65)	✓	✓	PM ISA
		Minor restricted-activity days (age 18-65)	✓	✓	PM ISA
		Chronic Bronchitis (age >26)	—	—	PM ISA ¹
		Emergency room visits for cardiovascular effects (all ages)	—	—	PM ISA ¹
Strokes and cerebrovascular disease (age 50-79)		—	—	PM ISA ¹	
Other cardiovascular effects (e.g., other ages)		—	—	PM ISA ²	
Other respiratory effects (e.g., pulmonary function, non-asthma ER visits, non-bronchitis chronic diseases, other ages and populations)		—	—	PM ISA ²	
Reproductive and developmental effects (e.g., low birth weight, pre-term births, etc.)		—	—	PM ISA ^{2,3}	
Reduced incidence of mortality from exposure to ozone	Premature mortality based on short-term study estimates (all ages)	✓	✓	Ozone ISA	
	Premature mortality based on long-term study estimates (age 30–99)	—	—	Ozone ISA ¹	
	Hospital admissions—respiratory causes (age > 65)	✓	✓	Ozone ISA	
Reduced incidence of morbidity from exposure to ozone	Hospital admissions—respiratory causes (age <2)	✓	✓	Ozone ISA	
	Emergency department visits for asthma (all ages)	✓	✓	Ozone ISA	
	Minor restricted-activity days (age 18–65)	✓	✓	Ozone ISA	
	School absence days (age 5–17)	✓	✓	Ozone ISA	
	Decreased outdoor worker productivity (age 18–65)	—	—	Ozone ISA ¹	
	Other respiratory effects (e.g., premature aging of lungs)	—	—	Ozone ISA ²	
	Cardiovascular and nervous system effects	—	—	Ozone ISA ²	
Reproductive and developmental effects	—	—	Ozone ISA ^{2,3}		

¹ We assess these co-benefits qualitatively due to data and resource limitations for this analysis, but we have quantified them in sensitivity analyses for other analyses.

² We assess these co-benefits qualitatively because we do not have sufficient confidence in available data or methods.

³ We assess these co-benefits qualitatively because current evidence is only suggestive of causality or there are other significant concerns over the strength of the association.

We follow a “damage-function” approach in calculating benefits, which estimates changes in individual health endpoints (specific effects that can be associated with changes in air quality) and assigns values to those changes assuming independence of the values for those individual endpoints. Because the EPA rarely has the time or resources to perform new research to measure directly, either health outcomes or their values for regulatory analyses, our estimates are based on the best available methods of benefits transfer, which is the science and art of adapting primary research from similar contexts to estimate benefits for the environmental quality change under analysis. In addition to transferring information from other contexts to the context of this regulation, we also use a “benefit-per-ton” approach to estimate the PM_{2.5} and ozone co-benefits in this RIA. Benefit-per-ton approaches apply an average benefit per ton derived from modeling of benefits of specific air quality scenarios to estimates of emissions reductions for scenarios where no air quality modeling is available. Thus, to develop estimates of benefits for this RIA, we are transferring both the underlying health and economic information from previous studies and information on air quality responses to emissions reductions from previous air quality modeling. This section describes the underlying basis for the health and economic valuation estimates that inform the benefit-per-ton estimates, and the subsequent section provides an overview of the benefit-per-ton estimates,¹⁰² which are described in detail in the appendix to this chapter.

The benefit-per-ton approach we use in this RIA relies on estimates of human health responses to exposure to PM and ozone obtained from the peer-reviewed scientific literature. These estimates are used in conjunction with population data, baseline health information, air quality data and economic valuation information to conduct health impact and economic benefits assessments. These assessments form the key inputs to calculating benefit-per-ton estimates. The next sections provide an overview of the health impact assessment (HIA) methodology and additional details on several key elements.

The HIA quantifies the changes in the incidence of adverse health impacts resulting from changes in human exposure to PM_{2.5} and ozone. We use the environmental Benefits Mapping and

¹⁰² We have updated the benefit-per-ton estimates since the proposal RIA. In this RIA, we apply benefit-per-ton estimates that were derived from air quality modeling of the proposed Clean Power Plan (Option 1 State).

Analysis Program – Community Edition (BenMAP-CE) (version 1.1) to systematize health impact analyses by applying a database of key input parameters, including population projections, health impact functions, and valuation functions (Abt Associates, 2012). For this assessment, the HIA is limited to those health effects that are directly linked to ambient PM_{2.5} and ozone concentrations. There may be other indirect health impacts associated with reducing emissions, such as occupational health exposures. Epidemiological studies generally provide estimates of the relative risks of a particular health effect for a given increment of air pollution (often per 10 µg/m³ for PM_{2.5} or ppb for ozone). These relative risks can be used to develop risk coefficients that relate a unit reduction in PM_{2.5} to changes in the incidence of a health effect. We refer the reader to the PM NAAQS RIA (U.S. EPA, 2012a) and Ozone NAAQS RIA (U.S. EPA, 2008b, 2010d) for more information regarding the epidemiology studies and risk coefficients applied in this analysis, and we briefly elaborate on adult premature mortality below. The size of the mortality effect estimates from epidemiological studies, the serious nature of the effect itself, and the high monetary value ascribed to reducing risks of premature death make mortality risk reduction the most significant health endpoint quantified in this analysis.

4.3.1.1 Mortality Concentration-Response Functions for PM_{2.5}

Considering a substantial body of published scientific literature and reflecting thousands of epidemiology, toxicology, and clinical studies, the PM ISA documents the association between elevated PM_{2.5} concentrations and adverse health effects, including increased premature mortality (U.S. EPA, 2009b). The PM ISA, which was twice reviewed by the Clean Air Scientific Advisory Committee of the EPA’s Science Advisory Board (SAB-CASAC) (U.S. EPA-SAB, 2009b, 2009c), concluded that there is a causal relationship between mortality and both long-term and short-term exposure to PM_{2.5} based on the entire body of scientific evidence. The PM ISA also concluded that the scientific literature supports the use of a no-threshold log-linear model to portray the PM-mortality concentration-response relationship while recognizing potential uncertainty about the exact shape of the concentration-response function. In addition to adult mortality discussed in more detail below, we use effect coefficients from Woodruff *et al.* (1997) to estimate PM-related infant mortality.

For adult PM-related mortality, we use the effect coefficients from the most recent epidemiology studies examining two large population cohorts: the American Cancer Society

cohort (Krewski *et al.*, 2009) and the Harvard Six Cities cohort (Lepeule *et al.*, 2012). The PM ISA (U.S. EPA, 2009b) concluded that the ACS and Six Cities cohorts produce the strongest evidence of the association between long-term PM_{2.5} exposure and premature mortality with support from a number of additional cohort studies. The SAB's Health Effects Subcommittee (SAB-HES) also supported using these two cohorts for analyses of the benefits of PM reductions (U.S. EPA-SAB, 2010a). As both the ACS and Six Cities cohort studies have inherent strengths and weaknesses, we present PM_{2.5} co-benefits estimates based on benefits-per-ton derived using relative risk estimates from both these cohorts.

As a characterization of uncertainty regarding the adult PM_{2.5}-mortality relationship, the EPA graphically presents the PM_{2.5} co-benefits based on benefits-per-ton estimated using C-R functions derived from EPA's expert elicitation study (Roman *et al.*, 2008; IEc, 2006). The primary goal of the 2006 study was to elicit from a sample of health experts probabilistic distributions describing uncertainty in estimates of the reduction in mortality among the adult U.S. population resulting from reductions in ambient annual average PM_{2.5} concentrations. In that study, twelve experts provided independent opinions regarding the PM_{2.5}-mortality concentration-response function. Because the experts relied upon the ACS and Six Cities cohort studies to inform their concentration-response functions, the benefits estimates based on the expert responses generally fall between benefits estimates based on these studies (see Figure 4-1). We do not combine the expert results in order to preserve the breadth and diversity of opinion on the expert panel. This presentation of the expert-derived results is generally consistent with SAB advice (U.S. EPA-SAB, 2008), which recommended that the EPA emphasize that “scientific differences existed only with respect to the magnitude of the effect of PM_{2.5} on mortality, not whether such an effect existed” and that the expert elicitation “supports the conclusion that the benefits of PM_{2.5} control are very likely to be substantial”. Although it is possible that newer scientific literature could revise the experts' quantitative responses if elicited again, we believe that these general conclusions are unlikely to change.

4.3.1.2 Mortality Concentration-Response Functions for Ozone

In 2008, the National Academies of Science (NRC, 2008) issued a series of recommendations to the EPA regarding the quantification and valuation of ozone-related short-term mortality. Chief among these was that “...short-term exposure to ambient ozone is likely to

contribute to premature deaths” and the committee recommended that “ozone-related mortality be included in future estimates of the health benefits of reducing ozone exposures...” The NAS also recommended that “...the greatest emphasis be placed on the multicity and NMMAPS [*National Morbidity, Mortality, and Air Pollution Study*] studies without exclusion of the meta-analyses” (NRC, 2008). In view of the findings of the National Academies panel, we estimate the co-benefits of avoiding short-term ozone mortality using the Bell *et al.* (2004) NMMAPS analysis, the Schwartz (2005) multi-city study, the Huang *et al.* (2005) multi-city study as well as effect estimates from the three meta-analyses (Bell *et al.* (2005), Levy *et al.* (2005), and Ito *et al.* (2005)). These studies are consistent with the studies used in the Ozone NAAQS RIA (U.S. EPA, 2008b, 2010d).¹⁰³ For simplicity, we report the ozone mortality estimates in this RIA as a range reflecting application of dollar-per-ton estimates based on Bell *et al.* (2004) and Levy *et al.* (2005) to represent the lowest and the highest co-benefits estimates based on these six ozone mortality studies. In addition, we graphically present in Figure 4-1 the estimated co-benefits based on dollar-per-ton estimates derived from all six studies mentioned above as a characterization of uncertainty regarding the ozone -mortality relationship.

4.3.2 *Economic Valuation for Health Co-benefits*

After quantifying the change in adverse health impacts, we estimate the economic value of these avoided impacts. Reductions in ambient concentrations of air pollution generally lower the risk of future adverse health effects by a small amount for a large population. Therefore, the appropriate economic measure is willingness to pay (WTP) for changes in risk of a health effect. For some health effects, such as hospital admissions, WTP estimates are generally not available, so we use the cost of treating or mitigating the effect. These cost-of-illness (COI) estimates generally (although not necessarily in every case) understate the true value of reductions in risk of a health effect. They tend to reflect the direct expenditures related to treatment but not the value of avoided pain and suffering from the health effect. The unit values applied in this

¹⁰³ Since the EPA received NAS advice, the Agency published the Ozone ISA (U.S. EPA, 2013b) and the second draft Ozone Health Risk and Exposure Assessment (U.S. EPA, 2014a). Therefore, the ozone mortality studies applied in this analysis, while current at the time of the previous Ozone NAAQS RIAs, do not reflect the most updated literature available. The selection of ozone mortality studies used to estimate benefits in RIAs will be revisited in the forthcoming RIA accompanying the on-going review of the Ozone NAAQS.

analysis are provided in Table 5-9 of the PM NAAQS RIA for each health endpoint (U.S. EPA, 2012a).

Avoided premature deaths account for 98 percent of monetized PM-related co-benefits and over 90 percent of monetized ozone-related co-benefits. The economics literature concerning the appropriate method for valuing reductions in premature mortality risk is still developing. The adoption of a value for the projected reduction in the risk of premature mortality is the subject of continuing discussion within the economics and public policy analysis community. Following the advice of the SAB's Environmental Economics Advisory Committee (SAB-EEAC), the EPA currently uses the value of statistical life (VSL) approach in calculating estimates of mortality benefits, because we believe this calculation provides the most reasonable single estimate of an individual's willingness to trade off money for reductions in mortality risk (U.S. EPA-SAB, 2000). The VSL approach is a summary measure for the value of small changes in mortality risk experienced by a large number of people.

The EPA continues work to update its guidance on valuing mortality risk reductions, and the Agency consulted several times with the SAB-EEAC on this issue. Until updated guidance is available, the Agency determined that a single, peer-reviewed estimate applied consistently, best reflects the SAB-EEAC advice it has received. Therefore, the EPA has decided to apply the VSL that was vetted and endorsed by the SAB in the *Guidelines for Preparing Economic Analyses* (U.S. EPA, 2014)¹⁰⁴ while the Agency continues its efforts to update its guidance on this issue. This approach calculates a mean value across VSL estimates derived from 26 labor market and contingent valuation studies published between 1974 and 1991. The mean VSL across these studies is \$6.3 million (2000\$).¹⁰⁵ We then adjust this VSL to account for the currency year and to account for income growth from 1990 to the analysis year. Specifically, the VSLs applied in

¹⁰⁴ In the updated *Guidelines for Preparing Economic Analyses* (U.S. EPA, 2010e), the EPA retained the VSL endorsed by the SAB with the understanding that further updates to the mortality risk valuation guidance would be forthcoming.

¹⁰⁵ In 1990\$, this base VSL is \$4.8 million.

this analysis in 2011\$ after adjusting for income growth are \$9.9 million for 2020 and \$10.1 million for 2025 and 2030.¹⁰⁶

The Agency is committed to using scientifically sound, appropriately reviewed evidence in valuing mortality risk reductions and has made significant progress in responding to the SAB-EEAC's specific recommendations. In the process, the Agency has identified a number of important issues to be considered in updating its mortality risk valuation estimates. These are detailed in a white paper, "Valuing Mortality Risk Reductions in Environmental Policy" (U.S. EPA, 2010c), which recently underwent review by the SAB-EEAC. A meeting with the SAB on this paper was held on March 14, 2011 and formal recommendations were transmitted on July 29, 2011 (U.S. EPA-SAB, 2011). The EPA is taking SAB's recommendations under advisement.

In valuing PM_{2.5}-related premature mortality, we discount the value of premature mortality occurring in future years using rates of 3 percent and 7 percent (OMB, 2003). We assume that there is a "cessation" lag between changes in PM exposures and the total realization of changes in health effects. Although the structure of the lag is uncertain, the EPA follows the advice of the SAB-HES to assume a segmented lag structure characterized by 30 percent of mortality reductions in the first year, 50 percent over years 2 to 5, and 20 percent over the years 6 to 20 after the reduction in PM_{2.5} (U.S. EPA-SAB, 2004c). Changes in the cessation lag assumptions do not change the total number of estimated deaths but rather the timing of those deaths. Because short-term ozone-related premature mortality occurs within the analysis year, the estimated ozone-related co-benefits are identical for all discount rates.

4.3.3 *Benefit-per-ton Estimates for PM_{2.5}*

We used a "benefit-per-ton" approach to estimate the PM_{2.5} co-benefits in this RIA. The EPA has applied this approach in several previous RIAs (e.g., U.S. EPA, 2011b, 2011c, 2012b, 2014a). These benefit-per-ton estimates provide the total monetized human health co-benefits (the sum of premature mortality and premature morbidity), of reducing one ton of PM_{2.5} (or PM_{2.5} precursor such as NO_x or SO₂) from a specified source. Specifically, in this analysis, we

¹⁰⁶ Income growth projections are only currently available in BenMAP through 2024, so both the 2025 and 2030 estimates use income growth only through 2024 and are therefore likely underestimates.

multiplied the benefit-per-ton estimates by the corresponding emission reductions that were generated from air quality modeling of the proposed Clean Power Plan.

The method used to calculate the regional benefit-per-ton estimates is similar to the average EGU sector estimates used for the proposal (U.S. EPA, 2013a), but relies on air quality modeling of the proposed Clean Power Plan. Similar to the proposal, we generated regional benefit-per-ton estimates by aggregating the impacts in BenMAP to the region (i.e., East, West, and California) rather than aggregating to the nation. The appendix to this chapter provides additional detail regarding these calculations.

As noted below in the characterization of uncertainty, all benefit-per-ton estimates have inherent limitations. Specifically, all benefit-per-ton estimates reflect the geographic distribution of the modeled proposal, which may not match the emission reductions anticipated by the final emission guidelines, and they may not reflect local variability in population density, meteorology, exposure, baseline health incidence rates, or other local factors for any specific location. The regional benefit-per-ton estimates, although less subject to these types of uncertainties than national estimates, still should be interpreted with caution. Even though we assume that all fine particles have equivalent health effects, the benefit-per-ton estimates vary between precursors depending on the location and magnitude of their impact on PM_{2.5} levels, which drive population exposure.

4.3.4 Benefit-per-ton Estimates for Ozone

Similar to PM_{2.5}, we used a “benefit-per-ton” approach in this RIA to estimate the ozone co-benefits, which represent the total monetized human health co-benefits (the sum of premature mortality and premature morbidity) of reducing one ton of NO_x (an ozone precursor). Also consistent with the PM_{2.5} estimates, we generated regional benefit-per-ton estimates for ozone based on air quality modeling for the proposed Clean Power Plan. In contrast to the PM_{2.5} estimates, the ozone estimates are not based on changes to annual emissions. Instead, the regional estimates (i.e., East, West, and California) correspond to NO_x emissions from U.S. EGUs during the ozone-season (May to September). Because we estimate ozone health impacts from May to September only, this approach underestimates ozone co-benefits in areas with a longer ozone season such as southern California and Texas. These estimates assume that EGU-

attributable ozone formation at the regional-level is due to NO_x alone. Because EGUs emit little VOC relative to NO_x emissions, it is unlikely that VOCs emitted by EGUs would contribute substantially to regional ozone formation. As noted above, all benefit-per-ton estimates have inherent limitations and should be interpreted with caution. We provide more detailed information regarding the generation of these estimates in the appendix to this chapter.

4.3.5 *Estimated Health Co-Benefits Results*

Tables 4-7 through 4-9 provide the regional benefit-per-ton estimates for three analysis years: 2020, 2025, and 2030. Tables 4-10 through 4-12 and 4-13 through 4-15 provide the emission reductions estimated to occur in each analysis year for the rate-based and mass-based illustrative plan approaches, respectively, by region (i.e., East, West, and California).¹⁰⁷ Tables 4-16 through 4-18 and 4-19 through 4-21 summarize the national monetized PM and ozone-related health co-benefits estimated to occur in each analysis year for the illustrative rate-based and mass-based plan approaches, respectively, by precursor pollutant using discount rates of 3 percent and 7 percent. Tables 4-22 through 4-24 and 4-25 through 4-27 provide national summaries of the reductions in estimated health incidences associated with the illustrative rate-based and mass-based plan approaches, respectively, in each analysis year.¹⁰⁸ Figure 4-1 provides a visual representation of the range of estimated PM_{2.5} and ozone-related co-benefits using benefit-per-ton estimates based on concentration-response functions from different studies and expert opinion for the illustrative rate-based and mass-based plan approaches evaluated in 2025 as an illustrative analysis year. Figure 4-2 provides a breakdown of the monetized health co-benefits for the rate-based and mass-based plan approaches evaluated in 2025 as an illustrative analysis year by precursor pollutant.

¹⁰⁷ See Chapter 3 of this RIA for more information regarding the expected emission reductions used to calculate the health co-benefits in this chapter. Chapter 3 also provides more information regarding the illustrative plan approach.

¹⁰⁸ Incidence estimates were generated using the same “per ton” approach as used to generate the dollar benefit per ton values. See Appendix 4-A for details.

Table 4-7. Summary of Regional PM_{2.5} Benefit-per-Ton Estimates Based on Air Quality Modeling from Proposed Clean Power Plan in 2020 (2011\$)*

Pollutant	Discount Rate	Regional		
		East	West	California
SO ₂	3%	\$33,000 to \$75,000	\$6,200 to \$14,000	\$95,000 to \$210,000
	7%	\$30,000 to \$68,000	\$5,600 to \$13,000	\$85,000 to \$190,000
Directly emitted PM _{2.5} (EC+OC)	3%	\$140,000 to \$320,000	\$27,000 to \$60,000	\$370,000 to \$830,000
	7%	\$130,000 to \$290,000	\$24,000 to \$54,000	\$330,000 to \$740,000
Directly emitted PM _{2.5} (crustal)	3%	\$23,000 to \$52,000	\$11,000 to \$25,000	\$73,000 to \$160,000
	7%	\$21,000 to \$47,000	\$9,900 to \$22,000	\$66,000 to \$150,000
NO _x (as PM _{2.5})	3%	\$3,100 to \$7,000	\$0,670 to \$1,500	\$22,000 to \$49,000
	7%	\$2,800 to \$6,300	\$0,610 to \$1,400	\$19,000 to \$44,000
NO _x (as Ozone)	N/A	\$6,500 to \$28,000	\$2,000 to \$8,900	\$14,000 to \$59,000

* The range of estimates reflects the range of epidemiology studies for avoided premature mortality for PM_{2.5} and ozone. All estimates are rounded to two significant figures. The monetized co-benefits do not include reduced health effects from direct exposure to NO₂, SO₂, ecosystem effects, or visibility impairment. All fine particles are assumed to have equivalent health effects, but the benefit-per-ton estimates vary depending on the location and magnitude of their impact on PM_{2.5} concentrations, which drive population exposure. The monetized co-benefits incorporate the conversion from precursor emissions to ambient fine particles and ozone. Benefit-per-ton estimates for ozone are based on ozone season NO_x emissions. Ozone co-benefits occur in analysis year, so they are the same for all discount rates. Confidence intervals are unavailable for this analysis because of the benefit-per-ton methodology. In general, the 95th percentile confidence interval for monetized PM_{2.5} benefits ranges from approximately -90 percent to +180 percent of the central estimates based on Krewski *et al.* (2009) and Lepeule *et al.* (2012).

Table 4-8. Summary of Regional PM_{2.5} Benefit-per-Ton Estimates Based on Air Quality Modeling from Proposed Clean Power Plan in 2025 (2011\$)*

Pollutant	Discount Rate	Regional		
		East	West	California
SO ₂	3%	\$37,000 to \$83,000	\$7,100 to \$16,000	\$110,000 to \$240,000
	7%	\$33,000 to \$75,000	\$6,400 to \$14,000	\$97,000 to \$220,000
Directly emitted PM _{2.5} (EC+OC)	3%	\$160,000 to \$360,000	\$30,000 to \$68,000	\$410,000 to \$930,000
	7%	\$140,000 to \$320,000	\$27,000 to \$61,000	\$370,000 to \$830,000
Directly emitted PM _{2.5} (crustal)	3%	\$25,000 to \$58,000	\$12,000 to \$28,000	\$82,000 to \$180,000
	7%	\$23,000 to \$52,000	\$11,000 to \$25,000	\$74,000 to \$170,000
NO _x (as PM _{2.5})	3%	\$3,300 to \$7,500	\$0,750 to \$1,700	\$24,000 to \$54,000
	7%	\$3,000 to \$6,800	\$0,670 to \$1,500	\$22,000 to \$49,000
NO _x (as Ozone)	N/A	\$7,100 to \$30,000	\$2,300 to \$10,000	\$15,000 to \$66,000

* The range of estimates reflects the range of epidemiology studies for avoided premature mortality for PM_{2.5} and ozone. All estimates are rounded to two significant figures. The monetized co-benefits do not include reduced health effects from direct exposure to NO₂, SO₂, ecosystem effects, or visibility impairment. All fine particles are assumed to have equivalent health effects, but the benefit-per-ton estimates vary depending on the location and magnitude of their impact on PM_{2.5} concentrations, which drive population exposure. The monetized co-benefits incorporate the conversion from precursor emissions to ambient fine particles and ozone. Benefit-per-ton estimates for ozone are based on ozone season NO_x emissions. Ozone co-benefits occur in analysis year, so they are the same for all discount rates. Confidence intervals are unavailable for this analysis because of the benefit-per-ton methodology. In general, the 95th percentile confidence interval for monetized PM_{2.5} benefits ranges from approximately -90 percent to +180 percent of the central estimates based on Krewski *et al.* (2009) and Lepeule *et al.* (2012).

Table 4-9. Summary of Regional PM_{2.5} Benefit-per-Ton Estimates Based on Air Quality Modeling from Proposed Clean Power Plan in 2030 (2011\$)*

Pollutant	Discount Rate	Regional		
		East	West	California
SO ₂	3%	\$40,000 to \$89,000	\$7,800 to \$18,000	\$120,000 to \$270,000
	7%	\$36,000 to \$81,000	\$7,100 to \$16,000	\$110,000 to \$240,000
Directly emitted PM _{2.5} (EC+OC)	3%	\$170,000 to \$380,000	\$33,000 to \$75,000	\$450,000 to \$1,000,000
	7%	\$150,000 to \$340,000	\$30,000 to \$68,000	\$410,000 to \$920,000
Directly emitted PM _{2.5} (crustal)	3%	\$28,000 to \$62,000	\$14,000 to \$31,000	\$90,000 to \$200,000
	7%	\$25,000 to \$56,000	\$13,000 to \$28,000	\$81,000 to \$180,000
NO _x (as PM _{2.5})	3%	\$3,500 to \$8,000	\$0,820 to \$1,900	\$26,000 to \$60,000
	7%	\$3,200 to \$7,200	\$0,740 to \$1,700	\$24,000 to \$54,000
NO _x (as Ozone)	N/A	\$7,600 to \$33,000	\$2,600 to \$11,000	\$17,000 to \$73,000

* The range of estimates reflects the range of epidemiology studies for avoided premature mortality for PM_{2.5} and ozone. All estimates are rounded to two significant figures. The monetized co-benefits do not include reduced health effects from direct exposure to NO₂, SO₂, ecosystem effects, or visibility impairment. All fine particles are assumed to have equivalent health effects, but the benefit-per-ton estimates vary depending on the location and magnitude of their impact on PM_{2.5} concentrations, which drive population exposure. The monetized co-benefits incorporate the conversion from precursor emissions to ambient fine particles and ozone. Benefit-per-ton estimates for ozone are based on ozone season NO_x emissions. Ozone co-benefits occur in analysis year, so they are the same for all discount rates. Confidence intervals are unavailable for this analysis because of the benefit-per-ton methodology. In general, the 95th percentile confidence interval for monetized PM_{2.5} benefits ranges from approximately -90 percent to +180 percent of the central estimates based on Krewski *et al.* (2009) and Lepeule *et al.* (2012).

Table 4-10. Emission Reductions of Criteria Pollutants for the Final Emission Guidelines Rate-based Illustrative Plan Approach in 2020 (thousands of short tons)*

Region	SO ₂	All-year NO _x	Ozone-Season NO _x
East	13	50	19
West	1	1	0
California	0	0	0
National Total	14	50	19

*All emissions shown in the table are rounded, so regional emission reductions may appear to not sum to national total. The final emissions guidelines are also expected to result in reductions in directly emitted PM_{2.5}, which we were not able to estimate for this RIA.

Table 4-11. Emission Reductions of Criteria Pollutants for the Final Emission Guidelines Rate-based Illustrative Plan Approach in 2025 (thousands of short tons)*

Region	SO ₂	All-year NO _x	Ozone-Season NO _x
East	171	155	67
West	7	8	3
California	1	2	0
National Total	178	165	70

*All emissions shown in the table are rounded, so regional emission reductions may appear to not sum to national total. The final emissions guidelines are also expected to result in reductions in directly emitted PM_{2.5}, which we were not able to estimate for this RIA.

Table 4-12. Emission Reductions of Criteria Pollutants for the Final Emission Guidelines Rate-based Illustrative Plan Approach in 2030 (thousands of short tons)*

Region	SO ₂	All-year NOx	Ozone-Season NOx
East	306	263	109
West	11	15	9
California	1	4	0
National Total	318	282	118

*All emissions shown in the table are rounded, so regional emission reductions may appear to not sum to national total. The final emissions guidelines are also expected to result in reductions in directly emitted PM_{2.5}, which we were not able to estimate for this RIA.

Table 4-13. Emission Reductions of Criteria Pollutants for the Final Emission Guidelines Mass-based Illustrative Plan Approach in 2020 (thousands of short tons)*

Region	SO ₂	All-year NOx	Ozone-Season NOx
East	49	57	22
West	4	4	1
California	0	0	0
National Total	54	60	23

*All emissions shown in the table are rounded, so regional emission reductions may appear to not sum to national total. The final emissions guidelines are also expected to result in reductions in directly emitted PM_{2.5}, which we were not able to estimate for this RIA.

Table 4-14. Emission Reductions of Criteria Pollutants for the Final Emission Guidelines Mass-based Illustrative Plan Approach in 2025 (thousands of short tons)*

Region	SO ₂	All-year NOx	Ozone-Season NOx
East	156	169	74
West	29	34	14
California	0	0	0
National Total	185	203	88

*All emissions shown in the table are rounded, so regional emission reductions may appear to not sum to national total. The final emissions guidelines are also expected to result in reductions in directly emitted PM_{2.5}, which we were not able to estimate for this RIA.

Table 4-15. Emission Reductions of Criteria Pollutants for the Final Emission Guidelines Mass-based Illustrative Plan Approach in 2030 (thousands of short tons)*

Region	SO ₂	All-year NOx	Ozone-Season NOx
East	243	229	99
West	36	48	21
California	1	1	1
National Total	280	279	121

*All emissions shown in the table are rounded, so regional emission reductions may appear to not sum to national total. The final emissions guidelines are also expected to result in reductions in directly emitted PM_{2.5}, which we were not able to estimate for this RIA.

Table 4-16. Summary of Estimated Monetized Health Co-Benefits for the Final Emission Guidelines Rate-based Illustrative Plan Approach in 2020 (billions of 2011\$) *

Pollutant	3% Discount Rate	7% Discount Rate
SO ₂	\$0.44 to \$0.99	\$0.39 to \$0.89
NO _x (as PM _{2.5})	\$0.14 to \$0.33	\$0.13 to \$0.30
NO _x (as Ozone)	\$0.12 to \$0.52	\$0.12 to \$0.52
Total	\$0.70 to \$1.8	\$0.64 to \$1.7

* All estimates are rounded to two significant figures so numbers may not sum down columns. The estimated monetized co-benefits do not include climate benefits or reduced health effects from direct exposure to NO₂, SO₂, ecosystem effects, or visibility impairment. All fine particles are assumed to have equivalent health effects, but the benefit-per-ton estimates vary depending on the location and magnitude of their impact on PM_{2.5} levels, which drive population exposure. The monetized co-benefits incorporate the conversion from precursor emissions to ambient fine particles and ozone. Co-benefits for PM_{2.5} precursors are based on regional benefit-per-ton estimates. Co-benefits for ozone are based on ozone season NO_x emissions. Ozone co-benefits occur in analysis year, so they are the same for all discount rates. Confidence intervals are unavailable for this analysis because of the benefit-per-ton methodology. In general, the 95th percentile confidence interval for monetized PM_{2.5} benefits ranges from approximately -90 percent to +180 percent of the central estimates based on Krewski *et al.* (2009) and Lepeule *et al.* (2012). For this RIA, we did not estimate changes in emissions of directly emitted particles. As a result, quantified PM_{2.5} related benefits are underestimated by a relatively small amount. In the proposal RIA, the benefits from reductions in directly emitted PM_{2.5} were less than 10 percent of total monetized health co-benefits across all scenarios and years.

Table 4-17. Summary of Estimated Monetized Health Co-Benefits for the Final Emission Guidelines Rate-based Illustrative Plan Approach in 2025 (billions of 2011\$) *

Pollutant	3% Discount Rate	7% Discount Rate
SO ₂	\$6.4 to \$14	\$5.7 to \$13
NO _x (as PM _{2.5})	\$0.56 to \$1.3	\$0.50 to \$1.1
NO _x (as Ozone)	\$0.49 to \$2.1	\$0.49 to \$2.1
Total	\$7.4 to \$18	\$6.7 to \$16

* All estimates are rounded to two significant figures so numbers may not sum down columns. The estimated monetized co-benefits do not include climate benefits or reduced health effects from direct exposure to NO₂, SO₂, ecosystem effects, or visibility impairment. All fine particles are assumed to have equivalent health effects, but the benefit-per-ton estimates vary depending on the location and magnitude of their impact on PM_{2.5} levels, which drive population exposure. The monetized co-benefits incorporate the conversion from precursor emissions to ambient fine particles and ozone. Co-benefits for PM_{2.5} precursors are based on regional benefit-per-ton estimates. Co-benefits for ozone are based on ozone season NO_x emissions. Ozone co-benefits occur in analysis year, so they are the same for all discount rates. Confidence intervals are unavailable for this analysis because of the benefit-per-ton methodology. In general, the 95th percentile confidence interval for monetized PM_{2.5} benefits ranges from approximately -90 percent to +180 percent of the central estimates based on Krewski *et al.* (2009) and Lepeule *et al.* (2012). For this RIA, we did not estimate changes in emissions of directly emitted particles. As a result, quantified PM_{2.5} related benefits are underestimated by a relatively small amount. In the proposal RIA, the benefits from reductions in directly emitted PM_{2.5} were less than 10 percent of total monetized health co-benefits across all scenarios and years.

Table 4-18. Summary of Estimated Monetized Health Co-Benefits for the Final Emission Guidelines Rate-based Illustrative Plan Approach in 2030 (billions of 2011\$) *

Pollutant	3% Discount Rate	7% Discount Rate
SO ₂	\$12 to \$28	\$11 to \$25
NO _x (as PM _{2.5})	\$1.0 to \$2.3	\$0.93 to \$2.1
NO _x (as Ozone)	\$0.86 to \$3.7	\$0.86 to \$3.7
Total	\$14 to \$34	\$13 to \$31

* All estimates are rounded to two significant figures so numbers may not sum down columns. The estimated monetized co-benefits do not include climate benefits or reduced health effects from direct exposure to NO₂, SO₂, ecosystem effects, or visibility impairment. All fine particles are assumed to have equivalent health effects, but the benefit-per-ton estimates vary depending on the location and magnitude of their impact on PM_{2.5} levels, which drive population exposure. The monetized co-benefits incorporate the conversion from precursor emissions to ambient fine particles and ozone. Co-benefits for PM_{2.5} precursors are based on regional benefit-per-ton estimates. Co-benefits for ozone are based on ozone season NO_x emissions. Ozone co-benefits occur in analysis year, so they are the same for all discount rates. Confidence intervals are unavailable for this analysis because of the benefit-per-ton methodology. In general, the 95th percentile confidence interval for monetized PM_{2.5} benefits ranges from approximately -90 percent to +180 percent of the central estimates based on Krewski *et al.* (2009) and Lepeule *et al.* (2012). For this RIA, we did not estimate changes in emissions of directly emitted particles. As a result, quantified PM_{2.5} related benefits are underestimated by a relatively small amount. In the proposal RIA, the benefits from reductions in directly emitted PM_{2.5} were less than 10 percent of total monetized health co-benefits across all scenarios and years.

Table 4-19. Summary of Estimated Monetized Health Co-Benefits for the Final Emission Guidelines Mass-based Illustrative Plan Approach in 2020 (billions of 2011\$) *

Pollutant	3% Discount Rate	7% Discount Rate
SO ₂	\$1.7 to \$3.8	\$1.5 to \$3.4
NO _x (as PM _{2.5})	\$0.17 to \$0.39	\$0.16 to \$0.36
NO _x (as Ozone)	\$0.14 to \$0.61	\$0.14 to \$0.61
Total	\$2.0 to \$4.8	\$1.8 to \$4.4

* All estimates are rounded to two significant figures so numbers may not sum down columns. The estimated monetized co-benefits do not include climate benefits or reduced health effects from direct exposure to NO₂, SO₂, ecosystem effects, or visibility impairment. All fine particles are assumed to have equivalent health effects, but the benefit-per-ton estimates vary depending on the location and magnitude of their impact on PM_{2.5} levels, which drive population exposure. The monetized co-benefits incorporate the conversion from precursor emissions to ambient fine particles and ozone. Co-benefits for PM_{2.5} precursors are based on regional benefit-per-ton estimates. Co-benefits for ozone are based on ozone season NO_x emissions. Ozone co-benefits occur in analysis year, so they are the same for all discount rates. Confidence intervals are unavailable for this analysis because of the benefit-per-ton methodology. In general, the 95th percentile confidence interval for monetized PM_{2.5} benefits ranges from approximately -90 percent to +180 percent of the central estimates based on Krewski *et al.* (2009) and Lepeule *et al.* (2012). For this RIA, we did not estimate changes in emissions of directly emitted particles. As a result, quantified PM_{2.5} related benefits are underestimated by a relatively small amount. In the proposal RIA, the benefits from reductions in directly emitted PM_{2.5} were less than 10 percent of total monetized health co-benefits across all scenarios and years.

Table 4-20. Summary of Estimated Monetized Health Co-Benefits for the Final Emission Guidelines Mass-based Illustrative Plan Approach in 2025 (billions of 2011\$) *

Pollutant	3% Discount Rate	7% Discount Rate
SO ₂	\$6.0 to \$13	\$5.4 to \$12
NO _x (as PM _{2.5})	\$0.58 to \$1.3	\$0.52 to \$1.2
NO _x (as Ozone)	\$0.56 to \$2.4	\$0.56 to \$2.4
Total	\$7.1 to \$17	\$6.5 to \$16

* All estimates are rounded to two significant figures so numbers may not sum down columns. The estimated monetized co-benefits do not include climate benefits or reduced health effects from direct exposure to NO₂, SO₂, ecosystem effects, or visibility impairment. All fine particles are assumed to have equivalent health effects, but the benefit-per-ton estimates vary depending on the location and magnitude of their impact on PM_{2.5} levels, which drive population exposure. The monetized co-benefits incorporate the conversion from precursor emissions to ambient fine particles and ozone. Co-benefits for PM_{2.5} precursors are based on regional benefit-per-ton estimates. Co-benefits for ozone are based on ozone season NO_x emissions. Ozone co-benefits occur in analysis year, so they are the same for all discount rates. Confidence intervals are unavailable for this analysis because of the benefit-per-ton methodology. In general, the 95th percentile confidence interval for monetized PM_{2.5} benefits ranges from approximately -90 percent to +180 percent of the central estimates based on Krewski *et al.* (2009) and Lepeule *et al.* (2012). For this RIA, we did not estimate changes in emissions of directly emitted particles. As a result, quantified PM_{2.5} related benefits are underestimated by a relatively small amount. In the proposal RIA, the benefits from reductions in directly emitted PM_{2.5} were less than 10 percent of total monetized health co-benefits across all scenarios and years.

Table 4-21. Summary of Estimated Monetized Health Co-Benefits for the Final Emission Guidelines Mass-based Illustrative Plan Approach in 2030 (billions of 2011\$) *

Pollutant	3% Discount Rate	7% Discount Rate
SO ₂	\$10 to \$23	\$9.0 to \$20
NO _x (as PM _{2.5})	\$0.87 to \$2.0	\$0.79 to \$1.8
NO _x (as Ozone)	\$0.82 to \$3.5	\$0.82 to \$3.5
Total	\$12 to \$28	\$11 to \$26

* All estimates are rounded to two significant figures so numbers may not sum down columns. The estimated monetized co-benefits do not include climate benefits or reduced health effects from direct exposure to NO₂, SO₂, ecosystem effects, or visibility impairment. All fine particles are assumed to have equivalent health effects, but the benefit-per-ton estimates vary depending on the location and magnitude of their impact on PM_{2.5} levels, which drive population exposure. The monetized co-benefits incorporate the conversion from precursor emissions to ambient fine particles and ozone. Co-benefits for PM_{2.5} precursors are based on regional benefit-per-ton estimates. Co-benefits for ozone are based on ozone season NO_x emissions. Ozone co-benefits occur in analysis year, so they are the same for all discount rates. Confidence intervals are unavailable for this analysis because of the benefit-per-ton methodology. In general, the 95th percentile confidence interval for monetized PM_{2.5} benefits ranges from approximately -90 percent to +180 percent of the central estimates based on Krewski *et al.* (2009) and Lepeule *et al.* (2012). For this RIA, we did not estimate changes in emissions of directly emitted particles. As a result, quantified PM_{2.5} related benefits are underestimated by a relatively small amount. In the proposal RIA, the benefits from reductions in directly emitted PM_{2.5} were less than 10 percent of total monetized health co-benefits across all scenarios and years.

Table 4-22. Summary of Avoided Health Incidences from PM_{2.5}-Related and Ozone-Related Co-benefits for the Final Emission Guidelines Rate-based Illustrative Plan Approach in 2020*

PM_{2.5}-related Health Effects	
Avoided Premature Mortality	
Krewski <i>et al.</i> (2009) (adult)	64
Lepeule <i>et al.</i> (2012) (adult)	140
Woodruff <i>et al.</i> (1997) (infant)	0
Avoided Morbidity	
Emergency department visits for asthma (all ages)	34
Acute bronchitis (age 8–12)	94
Lower respiratory symptoms (age 7–14)	1,200
Upper respiratory symptoms (asthmatics age 9–11)	1,700
Minor restricted-activity days (age 18–65)	47,000
Lost work days (age 18–65)	7,900
Asthma exacerbation (age 6–18)	4,200
Hospital admissions—respiratory (all ages)	19
Hospital admissions—cardiovascular (age > 18)	23
<i>Non-Fatal Heart Attacks (age >18)</i>	
Peters <i>et al.</i> (2001)	73
Pooled estimate of 4 studies	8
Ozone-related Health Effects	
Avoided Premature Mortality	
Bell <i>et al.</i> (2004) (all ages)	11
Levy <i>et al.</i> (2005) (all ages)	51
Avoided Morbidity	
Hospital admissions—respiratory causes (ages > 65)	66
Hospital admissions—respiratory causes (ages < 2)	33
Emergency room visits for asthma (all ages)	37
Minor restricted-activity days (ages 18-65)	66,000
School absence days	23,000

* All estimates are rounded to whole numbers with two significant figures. Co-benefits for PM_{2.5} precursors are based on regional incidence-per-ton estimates for all precursors. Co-benefits for ozone are based on ozone season NOx emissions. Confidence intervals are unavailable for this analysis because of the incidence-per-ton methodology. In general, the 95th percentile confidence interval for the health impact function alone ranges from approximately ±30 percent for mortality incidence based on Krewski *et al.* (2009) and ±46 percent based on Lepeule *et al.* (2012).

Table 4-23. Summary of Avoided Health Incidences from PM_{2.5}-Related and Ozone-Related Co-benefits for Final Emission Guidelines Rate-based Illustrative Plan Approach in 2025*

PM_{2.5}-related Health Effects	
Avoided Premature Mortality	
Krewski <i>et al.</i> (2009) (adult)	740
Lepeule <i>et al.</i> (2012) (adult)	1,700
Woodruff <i>et al.</i> (1997) (infant)	2
Avoided Morbidity	
Emergency department visits for asthma (all ages)	380
Acute bronchitis (age 8–12)	1,100
Lower respiratory symptoms (age 7–14)	14,000
Upper respiratory symptoms (asthmatics age 9–11)	20,000
Minor restricted-activity days (age 18–65)	530,000
Lost work days (age 18–65)	89,000
Asthma exacerbation (age 6–18)	48,000
Hospital admissions—respiratory (all ages)	220
Hospital admissions—cardiovascular (age > 18)	270
<i>Non-Fatal Heart Attacks (age >18)</i>	
Peters <i>et al.</i> (2001)	860
Pooled estimate of 4 studies	93
Ozone-related Health Effects	
Avoided Premature Mortality	
Bell <i>et al.</i> (2004) (all ages)	44
Levy <i>et al.</i> (2005) (all ages)	200
Avoided Morbidity	
Hospital admissions—respiratory causes (ages > 65)	280
Hospital admissions—respiratory causes (ages < 2)	130
Emergency room visits for asthma (all ages)	140
Minor restricted-activity days (ages 18-65)	250,000
School absence days	87,000

* All estimates are rounded to whole numbers with two significant figures. Co-benefits for PM_{2.5} precursors are based on regional incidence-per-ton estimates for all precursors. Co-benefits for ozone are based on ozone season NO_x emissions. Confidence intervals are unavailable for this analysis because of the incidence-per-ton methodology. In general, the 95th percentile confidence interval for the health impact function alone ranges from approximately ±30 percent for mortality incidence based on Krewski *et al.* (2009) and ±46 percent based on Lepeule *et al.* (2012).

Table 4-24. Summary of Avoided Health Incidences from PM_{2.5}-Related and Ozone-Related Co-Benefits for Final Emission Guidelines Rate-based Illustrative Plan Approach in 2030*

PM_{2.5}-related Health Effects	
Avoided Premature Mortality	
Krewski <i>et al.</i> (2009) (adult)	1,400
Lepeule <i>et al.</i> (2012) (adult)	3,200
Woodruff <i>et al.</i> (1997) (infant)	3
Avoided Morbidity	
Emergency department visits for asthma (all ages)	540
Acute bronchitis (age 8–12)	2,000
Lower respiratory symptoms (age 7–14)	26,000
Upper respiratory symptoms (asthmatics age 9–11)	37,000
Minor restricted-activity days (age 18–65)	970,000
Lost work days (age 18–65)	160,000
Asthma exacerbation (age 6–18)	90,000
Hospital admissions—respiratory (all ages)	440
Hospital admissions—cardiovascular (age > 18)	530
<i>Non-Fatal Heart Attacks (age >18)</i>	
Peters <i>et al.</i> (2001)	1,700
Pooled estimate of 4 studies	180
Ozone-related Health Effects	
Avoided Premature Mortality	
Bell <i>et al.</i> (2004) (all ages)	73
Levy <i>et al.</i> (2005) (all ages)	330
Avoided Morbidity	
Hospital admissions—respiratory causes (ages > 65)	500
Hospital admissions—respiratory causes (ages < 2)	200
Emergency room visits for asthma (all ages)	220
Minor restricted-activity days (ages 18-65)	400,000
School absence days	140,000

* All estimates are rounded to whole numbers with two significant figures. Co-benefits for PM_{2.5} precursors are based on regional incidence-per-ton estimates for all precursors. Co-benefits for ozone are based on ozone season NOx emissions. Confidence intervals are unavailable for this analysis because of the incidence-per-ton methodology. In general, the 95th percentile confidence interval for the health impact function alone ranges from approximately ±30 percent for mortality incidence based on Krewski *et al.* (2009) and ±46 percent based on Lepeule *et al.* (2012).

Table 4-25. Summary of Avoided Health Incidences from PM_{2.5}-Related and Ozone-Related Co-benefits for the Final Emission Guidelines Mass-based Illustrative Plan Approach in 2020*

PM_{2.5}-related Health Effects	
Avoided Premature Mortality	
Krewski <i>et al.</i> (2009) (adult)	200
Lepeule <i>et al.</i> (2012) (adult)	460
Woodruff <i>et al.</i> (1997) (infant)	0
Avoided Morbidity	
Emergency department visits for asthma (all ages)	110
Acute bronchitis (age 8–12)	300
Lower respiratory symptoms (age 7–14)	3,800
Upper respiratory symptoms (asthmatics age 9–11)	5,500
Minor restricted-activity days (age 18–65)	150,000
Lost work days (age 18–65)	25,000
Asthma exacerbation (age 6–18)	13,000
Hospital admissions—respiratory (all ages)	59
Hospital admissions—cardiovascular (age > 18)	73
<i>Non-Fatal Heart Attacks (age >18)</i>	
Peters <i>et al.</i> (2001)	230
Pooled estimate of 4 studies	25
Ozone-related Health Effects	
Avoided Premature Mortality	
Bell <i>et al.</i> (2004) (all ages)	13
Levy <i>et al.</i> (2005) (all ages)	61
Avoided Morbidity	
Hospital admissions—respiratory causes (ages > 65)	78
Hospital admissions—respiratory causes (ages < 2)	40
Emergency room visits for asthma (all ages)	43
Minor restricted-activity days (ages 18-65)	78,000
School absence days	27,000

* All estimates are rounded to whole numbers with two significant figures. Co-benefits for PM_{2.5} precursors are based on regional incidence-per-ton estimates for all precursors. Co-benefits for ozone are based on ozone season NOx emissions. Confidence intervals are unavailable for this analysis because of the incidence-per-ton methodology. In general, the 95th percentile confidence interval for the health impact function alone ranges from approximately ±30 percent for mortality incidence based on Krewski *et al.* (2009) and ±46 percent based on Lepeule *et al.* (2012).

Table 4-26. Summary of Avoided Health Incidences from PM_{2.5}-Related and Ozone-Related Co-benefits for Final Emission Guidelines Mass-based Illustrative Plan Approach in 2025*

PM_{2.5}-related Health Effects	
Avoided Premature Mortality	
Krewski <i>et al.</i> (2009) (adult)	700
Lepeule <i>et al.</i> (2012) (adult)	1,600
Woodruff <i>et al.</i> (1997) (infant)	2
Avoided Morbidity	
Emergency department visits for asthma (all ages)	350
Acute bronchitis (age 8–12)	1,000
Lower respiratory symptoms (age 7–14)	13,000
Upper respiratory symptoms (asthmatics age 9–11)	19,000
Minor restricted-activity days (age 18–65)	500,000
Lost work days (age 18–65)	84,000
Asthma exacerbation (age 6–18)	46,000
Hospital admissions—respiratory (all ages)	210
Hospital admissions—cardiovascular (age > 18)	260
<i>Non-Fatal Heart Attacks (age >18)</i>	
Peters <i>et al.</i> (2001)	810
Pooled estimate of 4 studies	88
Ozone-related Health Effects	
Avoided Premature Mortality	
Bell <i>et al.</i> (2004) (all ages)	51
Levy <i>et al.</i> (2005) (all ages)	230
Avoided Morbidity	
Hospital admissions—respiratory causes (ages > 65)	320
Hospital admissions—respiratory causes (ages < 2)	150
Emergency room visits for asthma (all ages)	160
Minor restricted-activity days (ages 18-65)	290,000
School absence days	100,000

* All estimates are rounded to whole numbers with two significant figures. Co-benefits for PM_{2.5} precursors are based on regional incidence-per-ton estimates for all precursors. Co-benefits for ozone are based on ozone season NOx emissions. Confidence intervals are unavailable for this analysis because of the incidence-per-ton methodology. In general, the 95th percentile confidence interval for the health impact function alone ranges from approximately ±30 percent for mortality incidence based on Krewski *et al.* (2009) and ±46 percent based on Lepeule *et al.* (2012).

Table 4-27. Summary of Avoided Health Incidences from PM_{2.5}-Related and Ozone-Related Co-Benefits for Final Emission Guidelines Mass-based Illustrative Plan Approach in 2030*

PM_{2.5}-related Health Effects	
Avoided Premature Mortality	
Krewski <i>et al.</i> (2009) (adult)	1,200
Lepeule <i>et al.</i> (2012) (adult)	2,600
Woodruff <i>et al.</i> (1997) (infant)	2
Avoided Morbidity	
Emergency department visits for asthma (all ages)	440
Acute bronchitis (age 8–12)	1,600
Lower respiratory symptoms (age 7–14)	21,000
Upper respiratory symptoms (asthmatics age 9–11)	30,000
Minor restricted-activity days (age 18–65)	790,000
Lost work days (age 18–65)	130,000
Asthma exacerbation (age 6–18)	74,000
Hospital admissions—respiratory (all ages)	360
Hospital admissions—cardiovascular (age > 18)	430
<i>Non-Fatal Heart Attacks (age >18)</i>	
Peters <i>et al.</i> (2001)	1,400
Pooled estimate of 4 studies	150
Ozone-related Health Effects	
Avoided Premature Mortality	
Bell <i>et al.</i> (2004) (all ages)	70
Levy <i>et al.</i> (2005) (all ages)	320
Avoided Morbidity	
Hospital admissions—respiratory causes (ages > 65)	470
Hospital admissions—respiratory causes (ages < 2)	200
Emergency room visits for asthma (all ages)	210
Minor restricted-activity days (ages 18-65)	380,000
School absence days	130,000

* All estimates are rounded to whole numbers with two significant figures. Co-benefits for PM_{2.5} precursors are based on regional incidence-per-ton estimates for all precursors. Co-benefits for ozone are based on ozone season NOx emissions. Confidence intervals are unavailable for this analysis because of the incidence-per-ton methodology. In general, the 95th percentile confidence interval for the health impact function alone ranges from approximately ±30 percent for mortality incidence based on Krewski *et al.* (2009) and ±46 percent based on Lepeule *et al.* (2012).

PM_{2.5}

Ozone

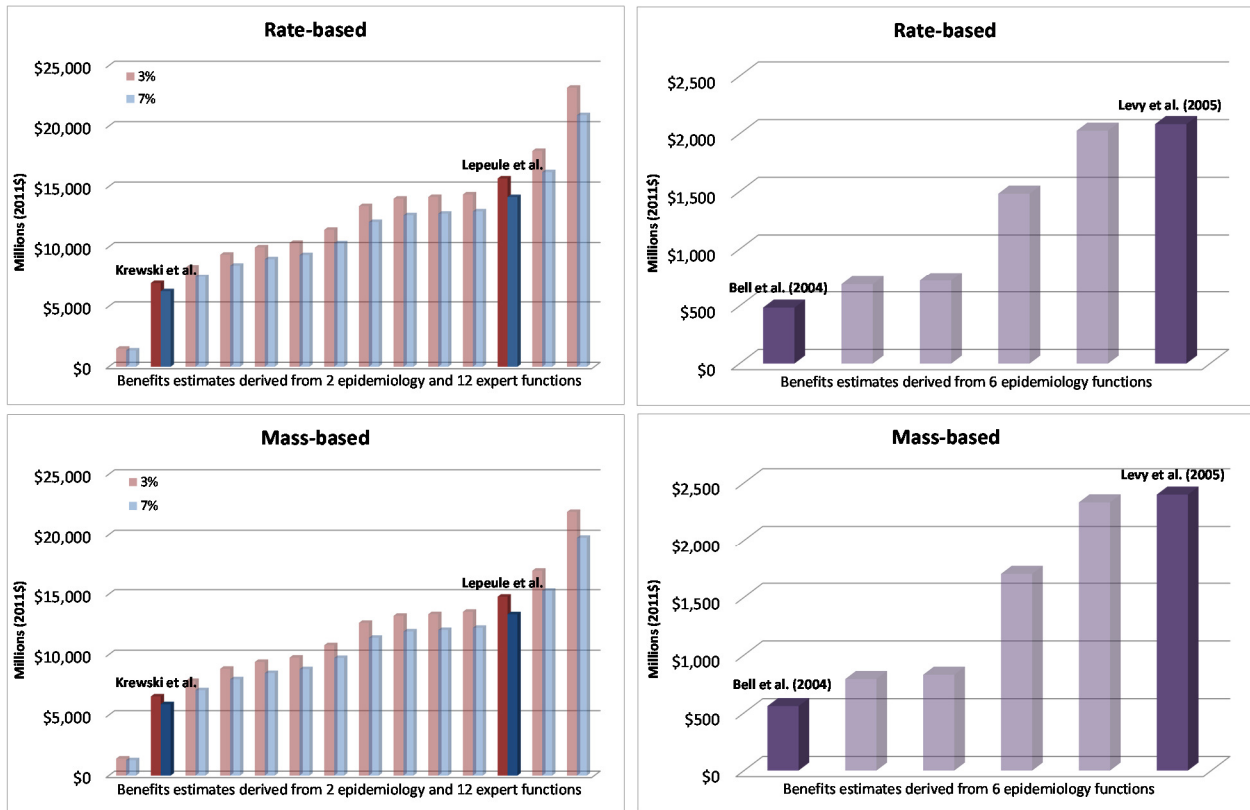

Figure 4-1. Monetized Health Co-benefits of Rate-based and Mass-based Illustrative Plan Approaches for the Final Emission Guidelines in 2025 *

*The PM_{2.5} graphs show the estimated PM_{2.5} co-benefits at discount rates of 3% and 7% using effect coefficients derived from the Krewski *et al.* (2009) study and the Lepeule *et al.* (2012) study, as well as 12 effect coefficients derived from EPA's expert elicitation on PM mortality (Roman *et al.*, 2008). The results shown are not the direct results from the studies or expert elicitation; rather, the estimates are based in part on the concentration-response functions provided in those studies. The ozone graphs show the estimated ozone co-benefits derived from six ozone mortality studies (i.e., Bell *et al.* (2004), Schwartz (2005), Huang *et al.* (2005), Bell *et al.* (2005), Levy *et al.* (2005), and Ito *et al.* (2005)). Ozone co-benefits occur in the analysis year, so they are the same for all discount rates. These estimates do not include benefits from reductions in CO₂. The monetized co-benefits do not include climate benefits from changes in NO₂ and SO₂ or reduced health effects from direct exposure to NO₂, SO₂, ecosystem effects, or visibility impairment. For this RIA, we did not estimate changes in emissions of directly emitted particles. As a result, quantified PM_{2.5} related benefits are underestimated by a relatively small amount. In the proposal RIA, the benefits from reductions in directly emitted PM_{2.5} were less than 10 percent of total monetized health co-benefits across all scenarios and years.

Low Health Co-benefits

High Health Co-benefits

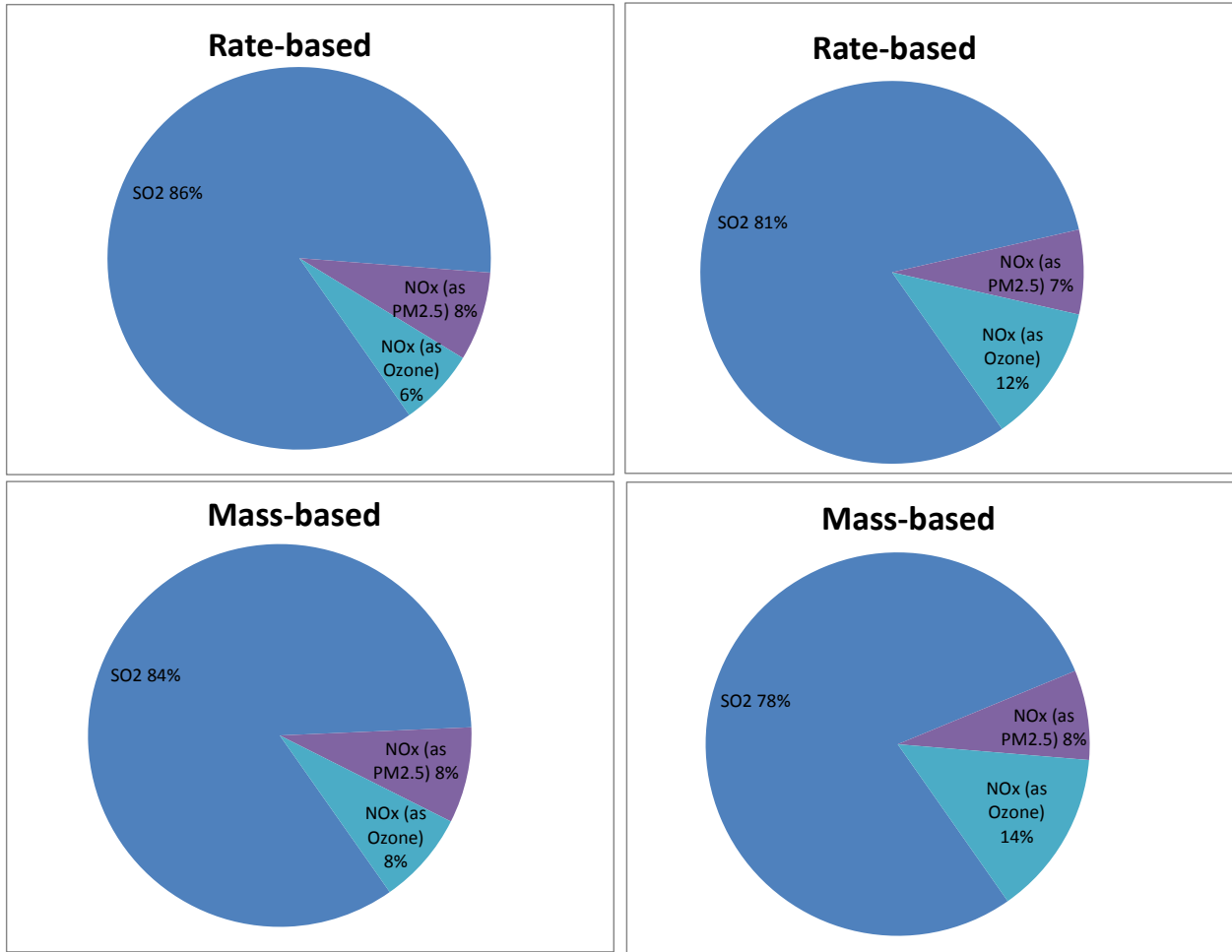

Figure 4-2. Breakdown of Monetized Health Co-benefits by Precursor Pollutant at a 3% Discount Rate for Rate-based and Mass-based Illustrative Plan Approaches for the Final Emission Guidelines in 2025*

* “Low Health Co-benefits” refers to the combined health co-benefits estimated using the Bell *et al.* (2004) mortality study for ozone with the Krewski *et al.* (2009) mortality study for PM_{2.5}. “High Health Co-benefits” refers to the combined health co-benefits estimated using the Levy *et al.* (2005) mortality study for ozone with the Lepeule *et al.* (2012) mortality study for PM_{2.5}. For this RIA, we did not estimate changes in emissions of directly emitted particles. As a result, quantified PM_{2.5} related benefits are underestimated by a relatively small amount. In the proposal RIA, the benefits from reductions in directly emitted PM_{2.5} were less than 10 percent of total monetized health co-benefits across all scenarios and years.

4.3.6 Characterization of Uncertainty in the Estimated Health Co-benefits

In any complex analysis using estimated parameters and inputs from numerous models, there are likely to be many sources of uncertainty. This analysis is no exception. This analysis

includes many data sources as inputs, including emission inventories, air quality data from models (with their associated parameters and inputs), population data, population estimates, health effect estimates from epidemiology studies, economic data for monetizing co-benefits, and assumptions regarding the future state of the world (i.e., regulations, technology, and human behavior). Each of these inputs may be uncertain and would affect the estimate of co-benefits. When the uncertainties from each stage of the analysis are compounded, even small uncertainties can have large effects on the total quantified benefits. In addition, the use of the benefit-per-ton approach adds additional uncertainties beyond those for analyses based directly on air quality modeling. Therefore, the estimates of co-benefits in each analysis year should be viewed as representative of the general magnitude of co-benefits of the illustrative plan approach, rather than the actual co-benefits anticipated from implementing the final emission guidelines.

This RIA does not include the type of detailed uncertainty assessment found in the PM NAAQS RIA (U.S. EPA, 2012a) or the Ozone NAAQS RIA (U.S. EPA, 2008b) because we lack the necessary air quality modeling input and/or monitoring data to run the benefits model. However, the results of the quantitative and qualitative uncertainty analyses presented in the PM NAAQS RIA and Ozone NAAQS RIA can provide some information regarding the uncertainty inherent in the estimated co-benefits results presented in this analysis. For example, sensitivity analyses conducted for the PM NAAQS RIA indicate that alternate cessation lag assumptions could change the estimated PM_{2.5}-related mortality co-benefits discounted at 3 percent by between 10 percent and -27 percent and that alternative income growth adjustments could change the PM_{2.5}-related mortality co-benefits by between 33 percent and -14 percent. Although we generally do not calculate confidence intervals for benefit-per-ton estimates and they can provide an incomplete picture about the overall uncertainty in the benefits estimates, the PM NAAQS RIA provides an indication of the random sampling error in the health impact and economic valuation functions using Monte Carlo methods. In general, the 95th percentile confidence interval for monetized PM_{2.5} benefits ranges from approximately -90 percent to +180 percent of the central estimates based on Krewski *et al.* (2009) and Lepeule *et al.* (2012). The 95th percentile confidence interval for the health impact function alone ranges from approximately ±30 percent for mortality incidence based on Krewski *et al.* (2009) and ±46 percent based on Lepeule *et al.* (2012).

Unlike RIAs for which the EPA conducts scenario-specific air quality modeling, we do not have information on the specific location of the air quality changes associated with the final emission guidelines. As such, it is not feasible to estimate the proportion of co-benefits occurring in different locations, such as designated nonattainment areas. Instead, we applied benefit-per-ton estimates, which reflect specific geographic patterns of emissions reductions and specific air quality and benefits modeling assumptions. For example, these estimates may not reflect local variability in population density, meteorology, exposure, baseline health incidence rates, or other local factors that might lead to an over-estimate or under-estimate of the actual co-benefits of controlling PM and ozone precursors. Use of these benefit-per-ton values to estimate co-benefits may lead to higher or lower benefit estimates than if co-benefits were calculated based on direct air quality modeling. Great care should be taken in applying these estimates to emission reductions occurring in any specific location, as these are all based on a broad emission reduction scenario and therefore represent average benefits-per-ton over the entire region. The benefit-per-ton for emission reductions in specific locations may be very different than the estimates presented here. To the extent that the geographic distribution of the emissions reductions achieved by implementing the final emission guidelines is different than the emissions in the air quality modeling of the proposal, the co-benefits may be underestimated or overestimated.

Our estimate of the total monetized co-benefits is based on the EPA's interpretation of the best available scientific literature and methods and supported by the SAB-HES and the National Academies of Science (NRC, 2002). Below are key assumptions underlying the estimates for PM_{2.5}-related premature mortality, which accounts for 98 percent of the monetized PM_{2.5} health co-benefits.

1. We assume that all fine particles, regardless of their chemical composition, are equally potent in causing premature mortality. This is an important assumption, because PM_{2.5} varies considerably in composition across sources, but the scientific evidence is not yet sufficient to allow differentiation of effect estimates by particle type. The PM ISA concluded that "many constituents of PM_{2.5} can be linked with multiple health effects, and the evidence is not yet sufficient to allow differentiation of those constituents or sources that are more closely related to specific outcomes" (U.S. EPA, 2009b).
2. We assume that the health impact function for fine particles is log-linear without a threshold. Thus, the estimates include health co-benefits from reducing fine particles in areas with varied concentrations of PM_{2.5}, including both areas that do not meet the fine

particle standard and those areas that are in attainment, down to the lowest modeled concentrations.

3. We assume that there is a “cessation” lag between the change in PM exposures and the total realization of changes in mortality effects. Specifically, we assume that some of the incidences of premature mortality related to PM_{2.5} exposures occur in a distributed fashion over the 20 years following exposure based on the advice of the SAB-HES (U.S. EPA-SAB, 2004c), which affects the valuation of mortality co-benefits at different discount rates.

In general, we are more confident in the magnitude of the risks we estimate from simulated PM_{2.5} concentrations that coincide with the bulk of the observed PM concentrations in the epidemiological studies that are used to estimate the benefits. Likewise, we are less confident in the risk we estimate from simulated PM_{2.5} concentrations that fall below the bulk of the observed data in these studies. Concentration benchmark analyses (e.g., lowest measured level [LML], one standard deviation below the mean of the air quality data in the study, etc.) allow readers to determine the portion of population exposed to annual mean PM_{2.5} levels at or above different concentrations, which provides some insight into the level of uncertainty in the estimated PM_{2.5} mortality benefits. In this analysis, we apply two concentration benchmark approaches (LML and one standard deviation below the mean) that have been incorporated into recent RIAs and the EPA’s *Policy Assessment for Particulate Matter* (U.S. EPA, 2011d). There are uncertainties inherent in identifying any particular point at which our confidence in reported associations becomes appreciably less, and the scientific evidence provides no clear dividing line. However, the EPA does not view these concentration benchmarks as a concentration threshold below which we would not quantify health co-benefits of air quality improvements.¹⁰⁹ Rather, the co-benefits estimates reported in this RIA are the best estimates because they reflect the full range of air quality concentrations associated with the emission reduction strategies. The PM ISA concluded that the scientific evidence collectively is sufficient to conclude that the relationship between long-term PM_{2.5} exposures and mortality is causal and that overall the studies support

¹⁰⁹ For a summary of the scientific review statements regarding the lack of a threshold in the PM_{2.5}-mortality relationship, see the TSD entitled *Summary of Expert Opinions on the Existence of a Threshold in the Concentration-Response Function for PM_{2.5}-related Mortality* (U.S. EPA, 2010b).

the use of a no-threshold log-linear model to estimate PM-related long-term mortality (U.S. EPA, 2009b).

For this analysis, policy-specific air quality data is not available, and the plan scenarios are illustrative of what states may choose to do. However, we believe that it is still important to characterize the distribution of exposure to baseline concentrations. As a surrogate measure of mortality impacts, we provide the percentage of the population exposed at each PM_{2.5} concentration in the baseline of the air quality modeling used to calculate the benefit-per-ton estimates for this final RIA using 12 km grid cells across the contiguous U.S. It is important to note that baseline exposure is only one parameter in the health impact function, along with baseline incidence rates population and change in air quality. In other words, the percentage of the population exposed to air pollution below the LML is not the same as the percentage of the population experiencing health impacts as a result of a specific emission reduction policy. The most important aspect, which we are unable to quantify without rule-specific air quality modeling, is the shift in exposure anticipated by implementing the final emission guidelines. Therefore, caution is warranted when interpreting the LML assessment in this RIA because these results are not consistent with results from RIAs that had air quality modeling.

Table 4-28 provides the percentage of the population exposed above and below two concentration benchmarks (i.e., LML and one standard deviation below the mean) in the Clean Power Plan proposal modeling. Figure 4-3 shows a bar chart of the percentage of the population exposed to various air quality levels in the proposal modeling, and Figure 4-4 shows a cumulative distribution function of the same data. Both figures identify the LML for each of the major cohort studies.

Table 4-28. Population Exposure in the Clean Power Plan Proposal Option 1 State Scenario Modeling (used to generate the benefit-per-ton estimates) Above and Below Various Concentrations Benchmarks in the Underlying Epidemiology Studies*

Epidemiology Study	Below 1 Standard Deviation. Below AQ Mean	At or Above 1 Standard Deviation Below AQ Mean	Below LML	At or Above LML
Krewski <i>et al.</i> (2009)	3%	97%	12%	88%
Lepeule <i>et al.</i> (2012)	N/A	N/A	54%	46%

*One standard deviation below the mean is equivalent to the middle of the range between the 10th and 25th percentile. For Krewski, the LML is 5.8 µg/m³ and one standard deviation below the mean is 11.0 µg/m³. For Lepeule *et al.*, the LML is 8 µg/m³ and we do not have the data for one standard deviation below the mean. It is important to emphasize that although we have lower levels of confidence in levels below the LML for each study, the scientific evidence does not support the existence of a level below which health effects from exposure to PM_{2.5} do not occur.

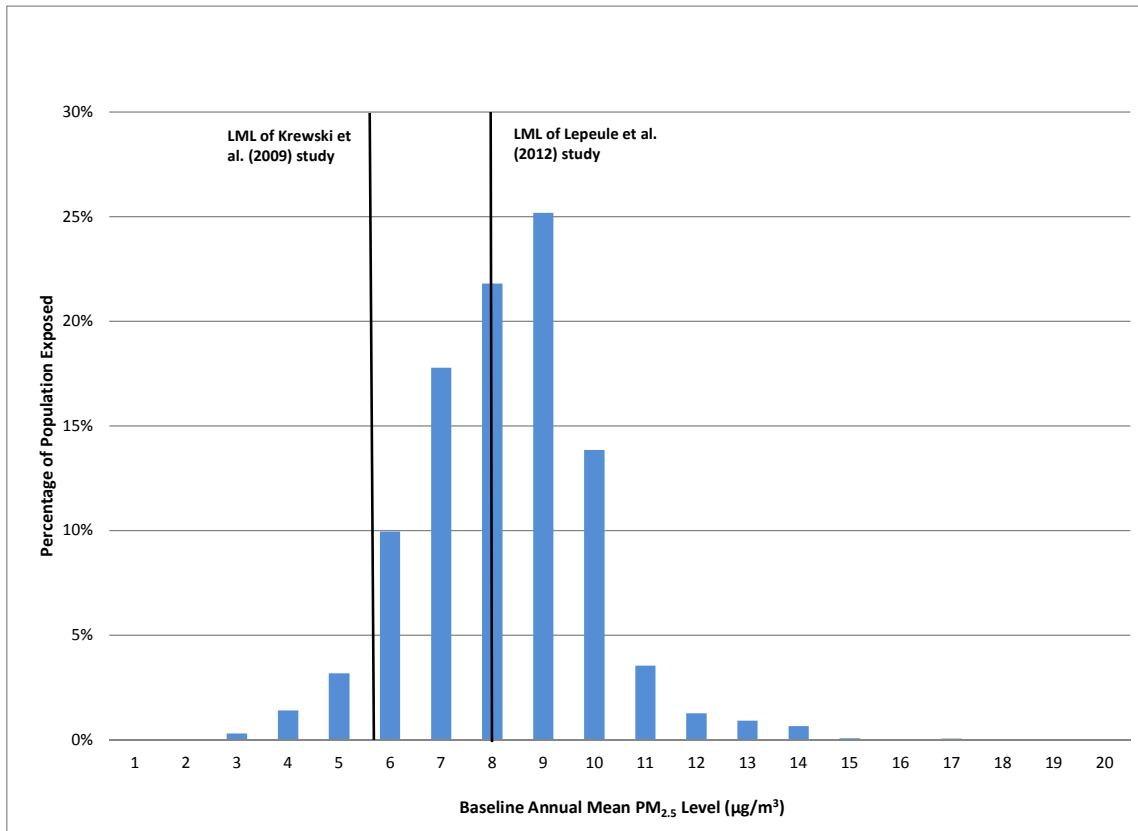

Among the populations exposed to PM_{2.5} in the baseline:

- 88% are exposed to PM_{2.5} levels at or above the LML of the Krewski *et al.* (2009) study
- 46% are exposed to PM_{2.5} levels at or above the LML of the Lepeule *et al.* (2012) study

Figure 4-3. Percentage of Adult Population (age 30+) by Annual Mean PM_{2.5} Exposure in the Option 1 State Scenario Clean Power Plan Proposal Modeling (used to generate the benefit-per-ton estimates)

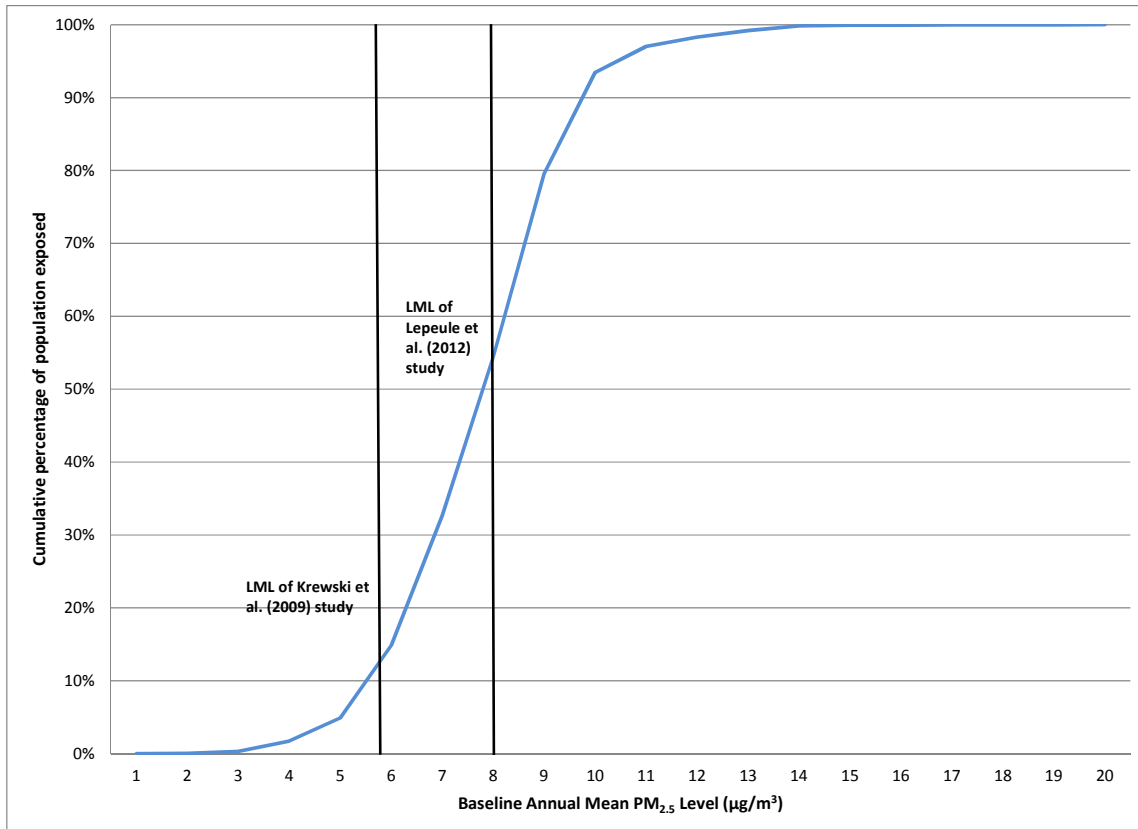

Among the populations exposed to PM_{2.5} in the baseline:
 88% are exposed to PM_{2.5} levels at or above the LML of the Krewski *et al.* (2009) study
 46% are exposed to PM_{2.5} levels at or above the LML of the Lepeule *et al.* (2012) study

Figure 4-4. Cumulative Distribution of Adult Population (age 30+) by Annual Mean PM_{2.5} Exposure in the Option 1 State Scenario Clean Power Plan Proposal Modeling (used to generate the benefit-per-ton estimates)

4.4 Combined Climate Benefits and Health Co-Benefits Estimates

In this analysis, we were able to monetize the estimated benefits associated with the decreased emissions of CO₂ and co-benefits of reduced exposure to PM_{2.5} and ozone, but we were unable to monetize the co-benefits associated with reducing exposure to mercury, carbon monoxide, SO₂, and NO₂, as well as ecosystem effects and visibility impairment. In addition, there are expected to be unquantified health and welfare impacts associated with changes in hydrogen chloride. Specifically, we estimated combinations of climate benefits at discount rates

of 5 percent, 3 percent, 2.5 percent, and 3 percent (95th percentile) (as recommended by the interagency working group), and health co-benefits at discount rates of 3 percent and 7 percent (as recommended by the EPA's *Guidelines for Preparing Economic Analyses* [U.S. EPA, 2014] and OMB's *Circular A-4* [OMB, 2003]).

Different discount rates are applied to SC-CO₂ than to the health co-benefit estimates because CO₂ emissions are long-lived and subsequent damages occur over many years. Moreover, several rates are applied to SC-CO₂ because the literature shows that it is sensitive to assumptions about discount rate and because no consensus exists on the appropriate rate to use in an intergenerational context. The SC-CO₂ interagency group centered its attention on the 3 percent discount rate but emphasized the importance of considering all four SC-CO₂ estimates.¹¹⁰ The EPA has evaluated the range of potential impacts by combining all SC-CO₂ values with health co-benefits values at the 3 percent and 7 percent discount rates. Combining the 3 percent SC-CO₂ values with the 3 percent health benefit values assumes that there is no difference in discount rates between intragenerational and intergenerational impacts.

Tables 4-29 through 4-31 provide the combined climate and health benefits for the illustrative plan approaches evaluated for each analysis year: 2020, 2025, and 2030. Figure 4-5 shows the breakdown of the monetized benefits by pollutant for the illustrative plan approaches evaluated in 2025 as an illustrative analysis year using a 3 percent discount rate for both climate and health benefits.

¹¹⁰ See the 2010 SCC TSD. Docket ID EPA-HQ-OAR-2009-0472-114577 or <http://www.whitehouse.gov/sites/default/files/omb/inforeg/for-agencies/Social-Cost-of-Carbon-for-RIA.pdf> for details.

Table 4-29. Combined Climate Benefits and Health Co-Benefits for Final Emission Guidelines in 2020 (billions of 2011\$)*

SCC Discount Rate	Climate Benefits Only	Climate and Health Benefits (Discount Rate Applied to Health Co-Benefits)	
		3%	7%
Rate-based	69	million short tons CO₂	
5%	\$0.80	\$1.5 to \$2.6	\$1.4 to \$2.5
3%	\$2.8	\$3.5 to \$4.6	\$3.5 to \$4.5
2.5%	\$4.1	\$4.9 to \$6.0	\$4.8 to \$5.9
3% (95 th percentile)	\$8.2	\$8.9 to \$10	\$8.9 to \$9.9
Mass-based	82	million short tons CO₂	
5%	\$0.94	\$2.9 to \$5.7	\$2.8 to \$5.3
3%	\$3.3	\$5.3 to \$8.1	\$5.1 to \$7.7
2.5%	\$4.9	\$6.9 to 9.7	\$6.7 to \$9.3
3% (95 th percentile)	\$9.6	\$12 to \$14	\$11 to \$14

*All estimates are rounded to two significant figures. Climate benefits are based on reductions in CO₂ emissions. Co-benefits are based on regional benefit-per-ton estimates. Co-benefits for ozone are based on ozone season NO_x emissions. Ozone co-benefits occur in analysis year, so they are the same for all discount rates. The health co-benefits reflect the sum of the PM_{2.5} and ozone co-benefits and reflect the range based on adult mortality functions (e.g., from Krewski *et al.* (2009) with Bell *et al.* (2004) to Lepeule *et al.* (2012) with Levy *et al.* (2005)). The monetized health co-benefits do not include reduced health effects from directly emitted PM_{2.5}, direct exposure to NO₂, SO₂, and HAP; ecosystem effects; or visibility impairment.

Table 4-30. Combined Climate Benefits and Health Co-Benefits for Final Emission Guidelines in 2025 (billions of 2011\$)*

SCC Discount Rate	Climate Benefits Only	Climate and Health Benefits (Discount Rate Applied to Health Co-Benefits)	
		3%	7%
Rate-based	232	million short tons CO₂	
5%	\$3.1	\$11 to \$21	\$9.9 to \$19
3%	\$10	\$18 to \$28	\$17 to \$26
2.5%	\$15	\$23 to \$33	\$22 to \$31
3% (95 th percentile)	\$31	\$38 to \$49	\$38 to \$47
Mass-based	264	million short tons CO₂	
5%	\$3.6	\$11 to \$21	\$10 to \$19
3%	\$12	\$19 to \$29	\$18 to \$27
2.5%	\$17	\$24 to \$34	\$24 to \$33
3% (95 th percentile)	\$35	\$42 to \$52	\$42 to \$51

*All estimates are rounded to two significant figures. Climate benefits are based on reductions in CO₂ emissions. Co-benefits are based on regional benefit-per-ton estimates. Co-benefits for ozone are based on ozone season NO_x emissions. Ozone co-benefits occur in analysis year, so they are the same for all discount rates. The health co-benefits reflect the sum of the PM_{2.5} and ozone co-benefits and reflect the range based on adult mortality functions (e.g., from Krewski *et al.* (2009) with Bell *et al.* (2004) to Lepeule *et al.* (2012) with Levy *et al.* (2005)). The monetized health co-benefits do not include reduced health effects from directly emitted PM_{2.5}, direct exposure to NO₂, SO₂, and HAP; ecosystem effects; or visibility impairment.

Table 4-31. Combined Climate Benefits and Health Co-Benefits for Final Emission Guidelines in 2030 (billions of 2011\$)*

SCC Discount Rate	Climate Benefits Only	Climate and Health Benefits (Discount Rate Applied to Health Co-Benefits)	
		3%	7%
Rate-based	415	million short tons CO₂	
5%	\$6.4	\$21 to \$40	\$19 to \$37
3%	\$20	\$34 to \$54	\$33 to \$51
2.5%	\$29	\$43 to \$63	\$42 to \$60
3% (95 th percentile)	\$61	\$75 to \$95	\$74 to \$92
Mass-based	413	million short tons CO₂	
5%	\$6.4	\$18 to \$34	\$17 to \$32
3%	\$20	\$32 to \$48	\$31 to \$46
2.5%	\$29	\$41 to \$57	\$40 to \$55
3% (95 th percentile)	\$60	\$72 to \$89	\$71 to \$86

*All estimates are rounded to two significant figures. Climate benefits are based on reductions in CO₂ emissions. Co-benefits are based on regional benefit-per-ton estimates. Co-benefits for ozone are based on ozone season NO_x emissions. Ozone co-benefits occur in analysis year, so they are the same for all discount rates. The health co-benefits reflect the sum of the PM_{2.5} and ozone co-benefits and reflect the range based on adult mortality functions (e.g., from Krewski *et al.* (2009) with Bell *et al.* (2004) to Lepeule *et al.* (2012) with Levy *et al.* (2005)). The monetized health co-benefits do not include reduced health effects from directly emitted PM_{2.5}, direct exposure to NO₂, SO₂, and HAP; ecosystem effects; or visibility impairment.

Low Health Co-benefits

High Health Co-benefits

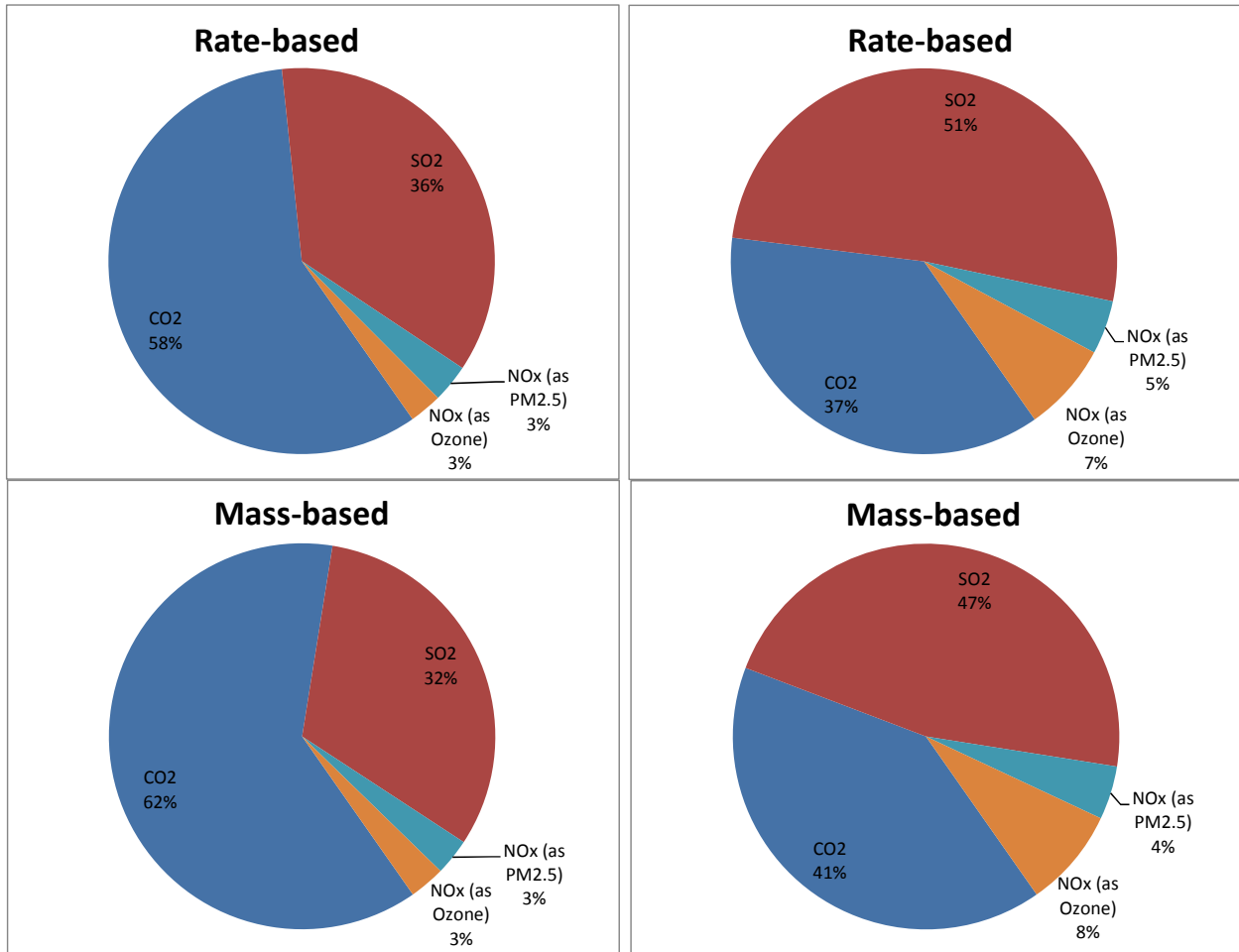

Figure 4-5. Breakdown of Combined Monetized Climate and Health Co-benefits of Final Emission Guidelines in 2025 for Rate-based and Mass-based Illustrative Plan Approaches and Pollutants (3% discount rate)*

* “Low Health Co-benefits” refers to the combined health co-benefits estimated using the Bell *et al.* (2004) mortality study for ozone with the Krewski *et al.* (2009) mortality study for PM_{2.5}. “High Health Co-benefits” refers to the combined health co-benefits estimated using the Levy *et al.* (2005) mortality study for ozone with the Lepeule *et al.* (2012) mortality study for PM_{2.5}. For this RIA, we did not estimate changes in emissions of directly emitted particles. As a result, quantified PM_{2.5} related benefits are underestimated by a relatively small amount. In the proposal RIA, the benefits from reductions in directly emitted PM_{2.5} were less than 8 percent of total monetized benefits across all scenarios and years.

4.5 Unquantified Co-benefits

The monetized co-benefits estimated in this RIA reflect a subset of co-benefits attributable to the health effect reductions associated with ambient fine particles and ozone. Data, time, and

resource limitations prevented the EPA from quantifying the impacts to, or monetizing the co-benefits from several important benefit categories, including co-benefits associated with exposure to several HAP (including mercury), SO₂ and NO₂, as well as ecosystem effects, and visibility impairment due to the absence of air quality modeling data for these pollutants in this analysis. This does not imply that there are no co-benefits associated with changes in emissions of HAP or reductions in exposures to SO₂ and NO₂. In this section, we provide a qualitative description of these benefits, which are listed in Table 4-32.

Table 4-32. Unquantified Health and Welfare Co-benefits Categories

Category	Specific Effect	Effect Has Been Quantified	Effect Has Been Monetized	More Information
Improved Human Health				
Reduced incidence of morbidity from exposure to NO ₂	Asthma hospital admissions (all ages)	—	—	NO ₂ ISA ¹
	Chronic lung disease hospital admissions (age > 65)	—	—	NO ₂ ISA ¹
	Respiratory emergency department visits (all ages)	—	—	NO ₂ ISA ¹
	Asthma exacerbation (asthmatics age 4–18)	—	—	NO ₂ ISA ¹
	Acute respiratory symptoms (age 7–14)	—	—	NO ₂ ISA ¹
	Premature mortality	—	—	NO ₂ ISA ^{1,2,3}
	Other respiratory effects (e.g., airway hyperresponsiveness and inflammation, lung function, other ages and populations)	—	—	NO ₂ ISA ^{2,3}
Reduced incidence of morbidity from exposure to SO ₂	Respiratory hospital admissions (age > 65)	—	—	SO ₂ ISA ¹
	Asthma emergency department visits (all ages)	—	—	SO ₂ ISA ¹
	Asthma exacerbation (asthmatics age 4–12)	—	—	SO ₂ ISA ¹
	Acute respiratory symptoms (age 7–14)	—	—	SO ₂ ISA ¹
	Premature mortality	—	—	SO ₂ ISA ^{1,2,3}
Reduced incidence of morbidity from exposure to CO	Other respiratory effects (e.g., airway hyperresponsiveness and inflammation, lung function, other ages and populations)	—	—	SO ₂ ISA ^{1,2}
	Cardiovascular effects	—	—	CO ISA ^{1,2}
	Respiratory effects	—	—	CO ISA ^{1,2,3}
	Central nervous system effects	—	—	CO ISA ^{1,2,3}
Reduced incidence of morbidity from exposure to methylmercury	Premature mortality	—	—	CO ISA ^{1,2,3}
	Neurologic effects—IQ loss	—	—	IRIS; NRC, 2000 ¹
	Other neurologic effects (e.g., developmental delays, memory, behavior)	—	—	IRIS; NRC, 2000 ²
	Cardiovascular effects	—	—	IRIS; NRC, 2000 ^{2,3}
Improved Environment	Genotoxic, immunologic, and other toxic effects	—	—	IRIS; NRC, 2000 ^{2,3}
	Reduced visibility impairment			
Reduced visibility impairment	Visibility in Class 1 areas	—	—	PM ISA ¹
	Visibility in residential areas	—	—	PM ISA ¹

Category	Specific Effect	Effect Has Been Quantified	Effect Has Been Monetized	More Information
Reduced effects on materials	Household soiling	—	—	PM ISA ^{1,2}
	Materials damage (e.g., corrosion, increased wear)	—	—	PM ISA ²
Reduced effects from PM deposition (metals and organics)	Effects on Individual organisms and ecosystems	—	—	PM ISA ²
Reduced vegetation and ecosystem effects from exposure to ozone	Visible foliar injury on vegetation	—	—	Ozone ISA ¹
	Reduced vegetation growth and reproduction	—	—	Ozone ISA ¹
	Yield and quality of commercial forest products and crops	—	—	Ozone ISA ¹
	Damage to urban ornamental plants	—	—	Ozone ISA ²
	Carbon sequestration in terrestrial ecosystems	—	—	Ozone ISA ¹
	Recreational demand associated with forest aesthetics	—	—	Ozone ISA ²
	Other non-use effects			Ozone ISA ²
	Ecosystem functions (e.g., water cycling, biogeochemical cycles, net primary productivity, leaf-gas exchange, community composition)	—	—	Ozone ISA ²
Reduced effects from acid deposition	Recreational fishing	—	—	NO _x SO _x ISA ¹
	Tree mortality and decline	—	—	NO _x SO _x ISA ²
	Commercial fishing and forestry effects	—	—	NO _x SO _x ISA ²
	Recreational demand in terrestrial and aquatic ecosystems	—	—	NO _x SO _x ISA ²
	Other non-use effects			NO _x SO _x ISA ²
	Ecosystem functions (e.g., biogeochemical cycles)	—	—	NO _x SO _x ISA ²
Reduced effects from nutrient enrichment	Species composition and biodiversity in terrestrial and estuarine ecosystems	—	—	NO _x SO _x ISA ²
	Coastal eutrophication	—	—	NO _x SO _x ISA ²
	Recreational demand in terrestrial and estuarine ecosystems	—	—	NO _x SO _x ISA ²
	Other non-use effects			NO _x SO _x ISA ²
	Ecosystem functions (e.g., biogeochemical cycles, fire regulation)	—	—	NO _x SO _x ISA ²
Reduced vegetation effects from ambient exposure to SO ₂ and NO _x	Injury to vegetation from SO ₂ exposure	—	—	NO _x SO _x ISA ²
	Injury to vegetation from NO _x exposure	—	—	NO _x SO _x ISA ²
Reduced ecosystem effects from exposure to methylmercury	Effects on fish, birds, and mammals (e.g., reproductive effects)	—	—	Mercury Study RTC ²
	Commercial, subsistence and recreational fishing	—	—	Mercury Study RTC ¹

¹ We assess these co-benefits qualitatively due to data and resource limitations for this RIA.

² We assess these co-benefits qualitatively because we do not have sufficient confidence in available data or methods.

³ We assess these co-benefits qualitatively because current evidence is only suggestive of causality or there are other significant concerns over the strength of the association.

4.5.1 HAP Impacts

Due to methodology and resource limitations, we were unable to estimate the impacts associated with changes in emissions of the hazardous air pollutants in this analysis. The EPA's SAB-HES concluded that "the challenges for assessing progress in health improvement as a

result of reductions in emissions of hazardous air pollutants (HAPs) are daunting...due to a lack of exposure-response functions, uncertainties in emissions inventories and background levels, the difficulty of extrapolating risk estimates to low doses and the challenges of tracking health progress for diseases, such as cancer, that have long latency periods” (U.S. EPA-SAB, 2008). In 2009, the EPA convened a workshop to address the inherent complexities, limitations, and uncertainties in current methods to quantify the benefits of reducing HAP. Recommendations from this workshop included identifying research priorities, focusing on susceptible and vulnerable populations, and improving dose-response relationships (Gwinn *et al.*, 2011).

4.5.1.1 Mercury

Mercury in the environment is transformed into a more toxic form, methylmercury (MeHg). Because Hg is a persistent pollutant, MeHg accumulates in the food chain, especially the tissue of fish. When people consume these fish, they consume MeHg. In 2000, the NAS Study was issued which provides a thorough review of the effects of MeHg on human health (NRC, 2000).¹¹¹ Many of the peer-reviewed articles cited in this section are publications originally cited in the Mercury Study.¹¹² In addition, the EPA has conducted literature searches to obtain other related and more recent publications to complement the material summarized by the NRC in 2000.

In its review of the literature, the NAS found neurodevelopmental effects to be the most sensitive and best documented endpoints and appropriate for establishing a reference dose (RfD) (NRC, 2000); in particular NAS supported the use of results from neurobehavioral or neuropsychological tests. The NAS report noted that studies on animals reported sensory effects as well as effects on brain development and memory functions and supported the conclusions based on epidemiology studies. The NAS noted that their recommended endpoints for a RfD are associated with the ability of children to learn and to succeed in school. They concluded the following: “The population at highest risk is the children of women who consumed large amounts of fish and seafood during pregnancy. The committee concludes that the risk to that

¹¹¹ National Research Council (NRC). 2000. *Toxicological Effects of Methylmercury*. Washington, DC: National Academies Press.

¹¹² U.S. Environmental Protection Agency (U.S. EPA). 1997. *Mercury Study Report to Congress*, EPA-HQ-OAR-2009-0234-3054. December. Available on the Internet at <<http://www.epa.gov/hg/report.htm>>.

population is likely to be sufficient to result in an increase in the number of children who have to struggle to keep up in school.”

The NAS summarized data on cardiovascular effects available up to 2000. Based on these and other studies, the NRC concluded that “Although the data base is not as extensive for cardiovascular effects as it is for other end points (i.e., neurologic effects), the cardiovascular system appears to be a target for MeHg toxicity in humans and animals.” The NRC also stated that “additional studies are needed to better characterize the effect of methylmercury exposure on blood pressure and cardiovascular function at various stages of life.”

Additional cardiovascular studies have been published since 2000. The EPA did not develop a quantitative dose-response assessment for cardiovascular effects associated with MeHg exposures, as there is no consensus among scientists on the dose-response functions for these effects. In addition, there is inconsistency among available studies as to the association between MeHg exposure and various cardiovascular system effects. The pharmacokinetics of some of the exposure measures (such as toenail Hg levels) are not well understood. The studies have not yet received the review and scrutiny of the more well-established neurotoxicity data base.

The Mercury Study noted that MeHg is not a potent mutagen but is capable of causing chromosomal damage in a number of experimental systems. The NAS concluded that evidence that human exposure to MeHg caused genetic damage is inconclusive; they note that some earlier studies showing chromosomal damage in lymphocytes may not have controlled sufficiently for potential confounders. One study of adults living in the Tapajós River region in Brazil (Amorim *et al.*, 2000) reported a direct relationship between MeHg concentration in hair and DNA damage in lymphocytes, as well as effects on chromosomes.¹¹³ Long-term MeHg exposures in this population were believed to occur through consumption of fish, suggesting that genotoxic effects

¹¹³ Amorim, M.I.M., D. Mergler, M.O. Bahia, H. Dubeau, D. Miranda, J. Lebel, R.R. Burbano, and M. Lucotte. 2000. Cytogenetic damage related to low levels of methyl mercury contamination in the Brazilian Amazon. *An. Acad. Bras. Ciênc.* 72(4): 497-507.

(largely chromosomal aberrations) may result from dietary and chronic MeHg exposures similar to and above those seen in the Faroes and Seychelles populations.

Although exposure to some forms of Hg can result in a decrease in immune activity or an autoimmune response (ATSDR, 1999), evidence for immunotoxic effects of MeHg is limited (NRC, 2000).¹¹⁴

Based on limited human and animal data, MeHg is classified as a “possible” human carcinogen by the International Agency for Research on Cancer (IARC, 1994)¹¹⁵ and in IRIS (U.S. EPA, 2002).¹¹⁶ The existing evidence supporting the possibility of carcinogenic effects in humans from low-dose chronic exposures is tenuous. Multiple human epidemiological studies have found no significant association between Hg exposure and overall cancer incidence, although a few studies have shown an association between Hg exposure and specific types of cancer incidence (e.g., acute leukemia and liver cancer) (NRC, 2000).

There is also some evidence of reproductive and renal toxicity in humans from MeHg exposure. However, overall, human data regarding reproductive, renal, and hematological toxicity from MeHg are very limited and are based on either studies of the two high-dose poisoning episodes in Iraq and Japan or animal data, rather than epidemiological studies of chronic exposures at the levels of interest in this analysis.

4.5.1.2 Hydrogen Chloride

Hydrogen chloride (HCl) is a corrosive gas that can cause irritation of the mucous membranes of the nose, throat, and respiratory tract. Brief exposure to 35 ppm causes throat

¹¹⁴ Agency for Toxic Substances and Disease Registry (ATSDR). 1999. Toxicological Profile for Mercury. U.S. Department of Health and Human Services, Public Health Service, Atlanta, GA.

¹¹⁵ International Agency for Research on Cancer (IARC). 1994. IARC Monographs on the Evaluation of Carcinogenic Risks to Humans and their Supplements: Beryllium, Cadmium, Mercury, and Exposures in the Glass Manufacturing Industry. Vol. 58. Jalili, H.A., and A.H. Abbasi. 1961. Poisoning by ethyl mercury toluene sulphonanilide. *Br. J. Indust. Med.* 18(Oct.):303-308 (as cited in NRC, 2000).

¹¹⁶ U.S. Environmental Protection Agency (EPA). 2002. Integrated Risk Information System (IRIS) on Methylmercury. National Center for Environmental Assessment. Office of Research and Development. Available at <http://www.epa.gov/iris/subst/0073.htm>.

irritation, and levels of 50 to 100 ppm are barely tolerable for 1 hour.¹¹⁷ Concentrations in typical human exposure environments are much lower than these levels and rarely exceed the reference concentration.¹¹⁸ The greatest impact is on the upper respiratory tract; exposure to high concentrations can rapidly lead to swelling and spasm of the throat and suffocation. Most seriously exposed persons have immediate onset of rapid breathing, blue coloring of the skin, and narrowing of the bronchioles. Exposure to HCl can lead to Reactive Airways Dysfunction Syndrome (RADS), a chemically, or irritant-induced type of asthma. Children may be more vulnerable to corrosive agents than adults because of the relatively smaller diameter of their airways. Children may also be more vulnerable to gas exposure because of increased minute ventilation per kg and failure to evacuate an area promptly when exposed. Hydrogen chloride has not been classified for carcinogenic effects.¹¹⁹

4.5.2 Additional NO₂ Health Co-Benefits

In addition to being a precursor to PM_{2.5} and ozone, NO_x emissions are also linked to a variety of adverse health effects associated with direct exposure. We were unable to estimate the health co-benefits associated with reduced NO₂ exposure in this analysis. Therefore, this analysis only quantified and monetized the PM_{2.5} and ozone co-benefits associated with the reductions in NO₂ emissions.

Following a comprehensive review of health evidence from epidemiologic and laboratory studies, the *Integrated Science Assessment for Oxides of Nitrogen —Health Criteria* (NO_x ISA) (U.S. EPA, 2008c) concluded that there is a likely causal relationship between respiratory health effects and short-term exposure to NO₂. These epidemiologic and experimental studies encompass a number of endpoints including emergency department visits and hospitalizations, respiratory symptoms, airway hyperresponsiveness, airway inflammation, and lung function. The

¹¹⁷ Agency for Toxic Substances and Disease Registry (ATSDR). Medical Management Guidelines for Hydrogen Chloride. Atlanta, GA: U.S. Department of Health and Human Services. Available at <http://www.atsdr.cdc.gov/mmg/mmg.asp?id=758&tid=147#bookmark02>.

¹¹⁸ Table of Prioritized Chronic Dose-Response Values: <http://www2.epa.gov/sites/production/files/2014-05/documents/table1.pdf>

¹¹⁹ U.S. Environmental Protection Agency (U.S. EPA). 1995. "Integrated Risk Information System File of Hydrogen Chloride." Washington, DC: Research and Development, National Center for Environmental Assessment. This material is available at <http://www.epa.gov/iris/subst/0396.htm>.

NO_x ISA also concluded that the relationship between short-term NO₂ exposure and premature mortality was “suggestive but not sufficient to infer a causal relationship,” because it is difficult to attribute the mortality risk effects to NO₂ alone. Although the NO_x ISA stated that studies consistently reported a relationship between NO₂ exposure and mortality, the effect was generally smaller than that for other pollutants such as PM.

4.5.3 *Additional SO₂ Health Co-Benefits*

In addition to being a precursor to PM_{2.5}, SO₂ emissions are also linked to a variety of adverse health effects associated with direct exposure. We were unable to estimate the health co-benefits associated with reduced SO₂ in this analysis because we do not have air quality modeling data available. Therefore, this analysis only quantifies and monetizes the PM_{2.5} co-benefits associated with the reductions in SO₂ emissions.

Following an extensive evaluation of health evidence from epidemiologic and laboratory studies, the *Integrated Science Assessment for Oxides of Sulfur—Health Criteria* (SO₂ ISA) concluded that there is a causal relationship between respiratory health effects and short-term exposure to SO₂ (U.S. EPA, 2008a). The immediate effect of SO₂ on the respiratory system in humans is bronchoconstriction. Asthmatics are more sensitive to the effects of SO₂ likely resulting from preexisting inflammation associated with this disease. A clear concentration-response relationship has been demonstrated in laboratory studies following exposures to SO₂ at concentrations between 20 and 100 ppb, both in terms of increasing severity of effect and percentage of asthmatics adversely affected. Based on our review of this information, we identified three short-term morbidity endpoints that the SO₂ ISA identified as a “causal relationship”: asthma exacerbation, respiratory-related emergency department visits, and respiratory-related hospitalizations. The differing evidence and associated strength of the evidence for these different effects is described in detail in the SO₂ ISA. The SO₂ ISA also concluded that the relationship between short-term SO₂ exposure and premature mortality was “suggestive of a causal relationship” because it is difficult to attribute the mortality risk effects to SO₂ alone. Although the SO₂ ISA stated that studies are generally consistent in reporting a relationship between SO₂ exposure and mortality, there was a lack of robustness of the observed associations to adjustment for other pollutants. We did not quantify these co-benefits due to data constraints.

4.5.4 Additional NO₂ and SO₂ Welfare Co-Benefits

As described in the *Integrated Science Assessment for Oxides of Nitrogen and Sulfur — Ecological Criteria* (NO_x/SO_x ISA) (U.S. EPA, 2008d), SO₂ and NO_x emissions also contribute to a variety of adverse welfare effects, including those associated with acidic deposition, visibility impairment, and nutrient enrichment. Deposition of nitrogen causes acidification, which can cause a loss of biodiversity of fishes, zooplankton, and macro invertebrates in aquatic ecosystems, as well as a decline in sensitive tree species, such as red spruce (*Picea rubens*) and sugar maple (*Acer saccharum*) in terrestrial ecosystems. In the northeastern U.S., the surface waters affected by acidification are a source of food for some recreational and subsistence fishermen and for other consumers and support several cultural services, including aesthetic and educational services and recreational fishing. Biological effects of acidification in terrestrial ecosystems are generally linked to aluminum toxicity, which can cause reduced root growth, restricting the ability of the plant to take up water and nutrients. These direct effects can, in turn, increase the sensitivity of these plants to stresses, such as droughts, cold temperatures, insect pests, and disease leading to increased mortality of canopy trees. Terrestrial acidification affects several important ecological services, including declines in habitat for threatened and endangered species (cultural), declines in forest aesthetics (cultural), declines in forest productivity (provisioning), and increases in forest soil erosion and reductions in water retention (cultural and regulating). (U.S. EPA, 2008d)

Deposition of nitrogen is also associated with aquatic and terrestrial nutrient enrichment. In estuarine waters, excess nutrient enrichment can lead to eutrophication. Eutrophication of estuaries can disrupt an important source of food production, particularly fish and shellfish production, and a variety of cultural ecosystem services, including water-based recreational and aesthetic services. Terrestrial nutrient enrichment is associated with changes in the types and number of species and biodiversity in terrestrial systems. Excessive nitrogen deposition upsets the balance between native and nonnative plants, changing the ability of an area to support biodiversity. When the composition of species changes, then fire frequency and intensity can also change, as nonnative grasses fuel more frequent and more intense wildfires. (U.S. EPA, 2008d)

Reductions in emissions of NO₂ and SO₂ will improve the level of visibility throughout the United States because these gases (and the particles of nitrate and sulfate formed from these gases) impair visibility by scattering and absorbing light (U.S. EPA, 2009). Visibility is also referred to as visual air quality (VAQ), and it directly affects people's enjoyment of a variety of daily activities (U.S. EPA, 2009). Good visibility increases quality of life where individuals live and work, and where they travel for recreational activities, including sites of unique public value, such as the Great Smoky Mountains National Park (U. S. EPA, 2009).

4.5.5 *Ozone Welfare Co-Benefits*

Exposure to ozone has been associated with a wide array of vegetation and ecosystem effects in the published literature (U.S. EPA, 2013b). Sensitivity to ozone is highly variable across species, with over 65 plant species identified as “ozone-sensitive”, many of which occur in state and national parks and forests. These effects include those that damage or impair the intended use of the plant or ecosystem. Such effects can include reduced growth and/or biomass production in sensitive plant species, including forest trees, reduced yield and quality of crops, visible foliar injury, species composition shift, and changes in ecosystems and associated ecosystem services.

4.5.6 *Carbon Monoxide Co-Benefits*

CO in ambient air is formed primarily by the incomplete combustion of carbon-containing fuels and photochemical reactions in the atmosphere. The amount of CO emitted from these reactions, relative to carbon dioxide (CO₂), is sensitive to conditions in the combustion zone, such as fuel oxygen content, burn temperature, or mixing time. Upon inhalation, CO diffuses through the respiratory system to the blood, which can cause hypoxia (reduced oxygen availability). Carbon monoxide can elicit a broad range of effects in multiple tissues and organ systems that depend on concentration and duration of exposure. The *Integrated Science Assessment for Carbon Monoxide* (U.S. EPA, 2010a) concluded that short-term exposure to CO is “likely to have a causal relationship” with cardiovascular morbidity, particularly in individuals with coronary heart disease. Epidemiologic studies associate short-term CO exposure with increased risk of emergency department visits and hospital admissions. Coronary heart disease includes those who have angina pectoris (cardiac chest pain), as well as those who have

experienced a heart attack. Other subpopulations potentially at risk include individuals with diseases such as chronic obstructive pulmonary disease (COPD), anemia, or diabetes, and individuals in very early or late life stages, such as older adults or the developing young. The evidence is suggestive of a causal relationship between short-term exposure to CO and respiratory morbidity and mortality. The evidence is also suggestive of a causal relationship for birth outcomes and developmental effects following long-term exposure to CO, and for central nervous system effects linked to short- and long-term exposure to CO.

4.5.7 Visibility Impairment Co-Benefits

Reducing secondary formation of PM_{2.5} would improve levels visibility in the U.S. because suspended particles and gases degrade visibility by scattering and absorbing light (U.S. EPA, 2009b). Fine particles with significant light-extinction efficiencies include sulfates, nitrates, organic carbon, elemental carbon, and soil (Sisler, 1996). Visibility has direct significance to people's enjoyment of daily activities and their overall sense of wellbeing. Good visibility increases the quality of life where individuals live and work, and where they engage in recreational activities. Particulate sulfate is the dominant source of regional haze in the eastern U.S. and particulate nitrate is an important contributor to light extinction in California and the upper Midwestern U.S., particularly during winter (U.S. EPA, 2009b). Previous analyses (U.S. EPA, 2011a) show that visibility co-benefits can be a significant welfare benefit category. Without air quality modeling, we are unable to estimate visibility related benefits, and we are also unable to determine whether the emission reductions associated with the final emission guidelines would be likely to have a significant impact on visibility in urban areas or Class I areas.

4.6 References

40 CFR Chapter I [EPA-HQ-OAR-2009-0171; FRL-9091-8] RIN 2060-ZA14,
“Endangerment and Cause or Contribute Findings for Greenhouse Gases under Section 202(a) of the Clean Air Act,” Federal Register, Vol. 74, No. 239, Tuesday, December 15, 2009, Rules and Regulations.

Abt Associates, Inc. 2012. "BenMAP User's Manual Appendices," prepared for U.S. Research Triangle Park, NC: U. S. Environmental Protection Agency, Office of Air Quality Planning and Standards. Available at:

<<http://www.epa.gov/air/benmap/models/BenMAPAppendicesOct2012.pdf>>. Accessed June 6, 2015.

Anenberg SC, West IJ, Fiore AM, Jaffe DA, Prather MJ, Bergmann D, Cuvelier K, Dentener FJ, Duncan BN, Gauss M, Hess P, Jonson JE, Lupu A, Mackenzie IA, Marmer E, Park RJ, Sanderson MG, Schultz M, Shindell DT, Szopa S, Vivanco MG, Wild O, Zeng G. 2009. Intercontinental impacts of ozone pollution on human mortality. *Environmental Science and Technology*. 43(17): 6482-7.

Bell, M.L., A. McDermott, S.L. Zeger, J.M. Samet, and F. Dominici. 2004. "Ozone and Short-Term Mortality in 95 U.S. Urban Communities, 1987-2000." *Journal of the American Medical Association*. 292(19):2372-8.

Bell, M.L., F. Dominici, and J.M. Samet. 2005. "A Meta-Analysis of Time-Series Studies of Ozone and Mortality with Comparison to the National Morbidity, Mortality, and Air Pollution Study." *Epidemiology*. 16(4):436-45.

Docket ID EPA-HQ-OAR-2009-0472-114577, Technical Support Document: Social Cost of Carbon for Regulatory Impact Analysis Under Executive Order 12866, Interagency Working Group on Social Cost of Carbon, with participation by the Council of Economic Advisers, Council on Environmental Quality, Department of Agriculture, Department of Commerce, Department of Energy, Department of Transportation, Environmental Protection Agency, National Economic Council, Office of Energy and Climate Change, Office of Management and Budget, Office of Science and Technology Policy, and Department of Treasury (February 2010). Available at: <<http://www.whitehouse.gov/sites/default/files/omb/inforeg/for-agencies/Social-Cost-of-Carbon-for-RIA.pdf>>.

Docket ID EPA-HQ-OAR-2013-0602, Technical Support Document: Technical Update of the Social Cost of Carbon for Regulatory Impact Analysis Under Executive Order 12866, Interagency Working Group on Social Cost of Carbon, with Participation by Council of Economic Advisers, Council on Environmental Quality, Department of Agriculture, Department of Commerce, Department of Energy, Department of Transportation, Domestic Policy Council, Environmental Protection Agency, National Economic Council, Office of Management and Budget, Office of Science and Technology Policy, and Department of Treasury (May 2013, Revised July 2015). Also available at: <<https://www.whitehouse.gov/sites/default/files/omb/inforeg/scc-tsd-final-july-2015.pdf>>. Accessed July 15, 2015.

Gwinn, M.R., J. Craig, D.A. Axelrad, R. Cook, C. Dockins, N. Fann, R. Fegley, D.E. Guinnup, G. Helfand, B. Hubbell, S.L. Mazur, T. Palma, R.L. Smith, J. Vandenberg, and B. Sonawane. 2011. "Meeting report: Estimating the benefits of reducing hazardous air pollutants—summary of 2009 workshop and future considerations." *Environmental Health Perspectives*. 119(1):125-30.

Huang Y., F. Dominici, and M. Bell. 2005. "Bayesian Hierarchical Distributed Lag Models for Summer Ozone Exposure and Cardio-Respiratory Mortality." *Environmetrics*. 16:547-562.

Industrial Economics, Incorporated (IEc). 2006. *Expanded Expert Judgment Assessment of the Concentration-Response Relationship Between PM_{2.5} Exposure and Mortality*. Prepared for: Office of Air Quality Planning and Standards, U.S. Environmental Protection Agency, Research Triangle Park, NC. September. Available at: <http://www.epa.gov/ttn/ecas/regdata/Uncertainty/pm_ee_tsd_expert_interview_summaries.pdf>. Accessed June 6, 2015.

Industrial Economics, Incorporated (IEc). 2009. Section 812 Prospective Study of the Benefits and Costs of the Clean Air Act: Air Toxics Case Study: Health Benefits of Benzene Reductions in Houston, 1990–2020. Final Report, July 14, 2009. Available at: <<http://www.epa.gov/air/sect812/dec09/812CAAABenzeneHoustonFinalReportJuly2009.pdf>>. Accessed June 6, 2015.

Interagency Working Group on Social Cost of Carbon, with participation by Council of Economic Advisers, Council on Environmental Quality, Department of Agriculture, Department of Commerce, Department of Energy, Department of Transportation, Environmental Protection Agency, National Economic Council, Office of Management and Budget, Office of Science and Technology Policy, and Department of Treasury. *Response to Comments: Social Cost of Carbon for Regulatory Impact Analysis Under Executive Order 12866*. July 2015. Available at <https://www.whitehouse.gov/sites/default/files/omb/inforeg/scc-response-to-comments-final-july-2015.pdf>. Accessed July 15, 2015.

Intergovernmental Panel on Climate Change (IPCC). 2007. *Climate Change 2007: Synthesis Report Contribution of Working Groups I, II and III to the Fourth Assessment Report of the IPCC*. Available at: http://www.ipcc.ch/publications_and_data/publications_ipcc_fourth_assessment_report_synthesis_report.htm. Accessed June 6, 2015.

Intergovernmental Panel on Climate Change (IPCC). 2012: *Managing the Risks of Extreme Events and Disasters to Advance Climate Change Adaptation*. A Special Report of Working Groups I and II of the Intergovernmental Panel on Climate Change. Cambridge University Press, Cambridge, UK, and New York, NY, USA.

Intergovernmental Panel on Climate Change (IPCC). 2013. *Climate Change 2013: The Physical Science Basis*. Contribution of Working Group I to the Fifth Assessment Report of the Intergovernmental Panel on Climate Change. Cambridge University Press, Cambridge, United Kingdom and New York, NY, USA.

Intergovernmental Panel on Climate Change (IPCC). 2014a. *Climate Change 2014: Impacts, Adaptation, and Vulnerability*. Contribution of Working Group II to the Fifth Assessment Report of the Intergovernmental Panel on Climate Change. Cambridge University Press, Cambridge, United Kingdom and New York, NY, USA.

Intergovernmental Panel on Climate Change (IPCC). 2014b. *Climate Change 2014: Mitigation of Climate Change*. Contribution of Working Group III to the Fifth Assessment Report of the Intergovernmental Panel on Climate Change. Cambridge University Press, Cambridge, United Kingdom and New York, NY, USA.

Ito, K., S.F. De Leon, and M. Lippmann. 2005. "Associations Between Ozone and Daily Mortality: Analysis and Meta-Analysis." *Epidemiology*. 16(4):446-57.

Jhun I, Fann N, Zanobetti A, Hubbell B. 2014. Effect modification of ozone-related mortality risks by temperature in 97 US cities. *Environment International*. 73:128-34.

- Karl, T., J. Melillo, and T. Peterson, Eds. 2009. *Global Climate Change Impacts in the United States*. Cambridge, United Kingdom: Cambridge University Press.
- Krewski D., M. Jerrett, R.T. Burnett, R. Ma, E. Hughes, Y. Shi, *et al.* 2009. *Extended Follow-Up and Spatial Analysis of the American Cancer Society Study Linking Particulate Air Pollution and Mortality*. HEI Research Report, 140, Health Effects Institute, Boston, MA.
- Lepeule, J., F. Laden, D. Dockery, and J. Schwartz. 2012. "Chronic Exposure to Fine Particles and Mortality: An Extended Follow-Up of the Harvard Six Cities Study from 1974 to 2009." *Environmental Health Perspectives*. 120(7):965-70.
- Levy, J.I., S.M. Chemerynski, and J.A. Sarnat. 2005. "Ozone Exposure and Mortality: An Empiric Bayes Metaregression Analysis." *Epidemiology*. 16(4):458-68.
- Melillo, Jerry M., Terese (T.C.) Richmond, and Gary W. Yohe, Eds. 2014. *Climate Change Impacts in the United States: The Third National Climate Assessment*. U.S. Global Change Research Program. Available at <<http://nca2014.globalchange.gov>>
- National Research Council (NRC). 2000. *Toxicological Effects of Methylmercury: Committee on the Toxicological Effects of Methylmercury*." Board on Environmental Studies and Toxicology. National Academies Press. Washington, DC.
- National Research Council (NRC). 2002. *Estimating the Public Health Benefits of Proposed Air Pollution Regulations*. National Academies Press. Washington, DC.
- National Research Council (NRC). 2008. *Estimating Mortality Risk Reduction and Economic Benefits from Controlling Ozone Air Pollution*. National Academies Press. Washington, DC.
- National Research Council (NRC). 2010. *Ocean Acidification: A National Strategy to Meet the Challenges of a Changing Ocean*. National Academies Press. Washington, DC.
- National Research Council (NRC). 2011a. *Climate Stabilization Targets: Emissions, Concentrations, and Impacts over Decades to Millennia*. National Academies Press, Washington, DC.
- National Research Council (NRC) 2011b. *National Security Implications of Climate Change for U.S. Naval Forces*. National Academies Press. Washington, DC.
- National Research Council (NRC, 2011c). *Understanding Earth's Deep Past: Lessons for Our Climate Future*. National Academies Press. Washington, DC
- National Research Council (NRC). 2012a. *Sea-Level Rise for the Coasts of California, Oregon, and Washington: Past, Present, and Future*. National Academies Press. Washington, DC.

- National Research Council (NRC). 2013a. *Climate and Social Stress: Implications for Security Analysis*. National Academies Press. Washington, DC.
- National Research Council (NRC). 2013b. *Abrupt Impacts of Climate Change: Anticipating Surprises*. National Academies Press. Washington, DC.
- Office of Management and Budget (OMB). 2003. *Circular A-4: Regulatory Analysis*. Washington, DC. Available at: < <http://www.whitehouse.gov/omb/circulars/a004/a-4.html>>.
- Pizer, W., M. Adler, J. Aldy, D. Anthoff, M. Cropper, K. Gillingham, M. Greenstone, B. Murray, R. Newell, R. Richels, A. Rowell, S. Waldhoff, J. Wiener. 2014. "Using and improving the social cost of carbon." *Science*, Vol. 346, No. 6214, 12/05/14, pp 1189-1190.
- Ren, C., G.M. William, L. Morawska, K. Mengensen, and S. Tong. 2008a. "Ozone Modifies Associations between Temperature and Cardiovascular Mortality: Analysis of the NMMAPS Data." *Occupational and Environmental Medicine*. 65:255-260.
- Ren, C., G.M. Williams, K. Mengersen, L. Morawska, and S. Tong. 2008b. "Does Temperature Modify Short-Term Effects of Ozone on Total Mortality in 60 Large Eastern U.S. Communities? An Assessment Using the NMMAPS Data." *Environment International*. 34:451-458.
- Ren, C. and S. Tong. 2006b. "Temperature Modifies the Health Effects of Particulate Matter in Brisbane, Australia." *International Journal of Biometeorology*. 51:87-96.
- Ren, C., G.M. Williams, and S. Tong. 2006a. "Does Particulate Matter Modify the Association between Temperature and Cardiorespiratory Diseases?" *Environmental Health Perspectives*, 114:1690-1696.
- Roberts, S. 2004. "Interactions between Particulate Air Pollution and Temperature in Air Pollution Mortality Time Series Studies." *Environmental Research*. 96:328-337.
- Roman, H., K. D. Walker, T.L. Walsh, L. Conner, H. M. Richmond, B.J. Hubbell, and P.L. Kinney. 2008. "Expert Judgment Assessment of the Mortality Impact of Changes in Ambient Fine Particulate Matter in the U.S." *Environmental Science and Technology*. 42(7):2268-2274.
- Schwartz, J. 2005. "How Sensitive is the Association between Ozone and Daily Deaths to Control for Temperature?" *American Journal of Respiratory and Critical Care Medicine*. 171(6): 627-31.

- Sisler, J.F. 1996. Spatial and Seasonal Patterns and Long-Term Variability of the Composition of the Haze in the United States: An analysis of data from the IMPROVE network. CIRA Report, ISSN 0737-5352-32, Colorado State University.
- U.S. Environmental Protection Agency (U.S. EPA). 1995. *Regulatory Impact Analysis for the Petroleum Refinery NESHAP. Revised Draft for Promulgation*. Office of Air Quality Planning and Standards, Research Triangle Park, N.C. Available on the Internet at <<http://yosemite1.epa.gov/ee/epa/ria.nsf/vwTD/9F39F2C26150BB21852564620063317F>>. Accessed June 6, 2015.
- U.S. Environmental Protection Agency (U.S. EPA). 2008a. *Integrated Science Assessment for Sulfur Oxides—Health Criteria (Final Report)*. National Center for Environmental Assessment – RTP Division, Research Triangle Park, NC. September. Available at: <<http://cfpub.epa.gov/ncea/cfm/recordisplay.cfm?deid=198843>>. Accessed June 4, 2015.
- U.S. Environmental Protection Agency (U.S. EPA). 2008b. *Final Ozone NAAQS Regulatory Impact Analysis*. EPA-452/R-08-003. Office of Air Quality Planning and Standards Health and Environmental Impacts Division, Air Benefit and Cost Group Research Triangle Park, NC. March. Available at: <<http://www.epa.gov/ttnecas1/regdata/RIAs/6-ozoneriachapter6.pdf>>. Accessed June 4, 2015.
- U.S. Environmental Protection Agency (U.S. EPA). 2008c. *Integrated Science Assessment for Oxides of Nitrogen - Health Criteria (Final Report)*. National Center for Environmental Assessment, Research Triangle Park, NC. July. Available at: <<http://cfpub.epa.gov/ncea/cfm/recordisplay.cfm?deid=194645>>. Accessed June 4, 2015.
- U.S. Environmental Protection Agency (U.S. EPA). 2008d. *Integrated Science Assessment for Oxides of Nitrogen and Sulfur—Ecological Criteria National (Final Report)*. National Center for Environmental Assessment – RTP Division, Research Triangle Park, NC. EPA/600/R-08/139. December. Available at: <<http://cfpub.epa.gov/ncea/cfm/recordisplay.cfm?deid=201485>>. Accessed June 4, 2015.
- U.S. Environmental Protection Agency (U.S. EPA). 2009. *Integrated Science Assessment for Particulate Matter (Final Report)*. EPA-600-R-08-139F. National Center for Environmental Assessment – RTP Division, Research Triangle Park, NC. December. Available at: <<http://cfpub.epa.gov/ncea/cfm/recordisplay.cfm?deid=216546>>. Accessed June 4, 2015.
- U.S. Environmental Protection Agency (U.S. EPA). 2010a. *Integrated Science Assessment for Carbon Monoxide*. National Center for Environmental Assessment, Research Triangle Park, NC. EPA/600/R-09/019F. January. Available at: <<http://cfpub.epa.gov/ncea/cfm/recordisplay.cfm?deid=218686>>. Accessed June 4, 2015.

- U.S. Environmental Protection Agency (U.S. EPA). 2010b. Technical Support Document: Summary of Expert Opinions on the Existence of a Threshold in the Concentration-Response Function for PM_{2.5}-related Mortality. Research Triangle Park, NC. June. Available at: <<http://www.epa.gov/ttn/ecas/regdata/Benefits/thresholdstd.pdf>>. Accessed June 4, 2015.
- U.S. Environmental Protection Agency (U.S. EPA). 2010c. *Valuing Mortality Risk Reductions for Environmental Policy: A White Paper: SAB Review Draft*. National Center for Environmental Economics December. Available at: <[http://yosemite.epa.gov/ee/epa/erm.nsf/vwAN/EE-0563-1.pdf/\\$file/EE-0563-1.pdf](http://yosemite.epa.gov/ee/epa/erm.nsf/vwAN/EE-0563-1.pdf/$file/EE-0563-1.pdf)>. Accessed June 4, 2015.
- U.S. Environmental Protection Agency (U.S. EPA). 2010d. *Section 3: Re-analysis of the Benefits of Attaining Alternative Ozone Standards to Incorporate Current Methods*. Available at: <http://www.epa.gov/ttnecas1/regdata/RIAs/s3-supplemental_analysis-updated_benefits11-5.09.pdf>. Accessed June 4, 2015.
- U.S. Environmental Protection Agency (U.S. EPA). 2011a. *The Benefits and Costs of the Clean Air Act from 1990 to 2020*. Office of Air and Radiation, Washington, DC. March. Available at: <http://www.epa.gov/cleanairactbenefits/feb11/fullreport_rev_a.pdf>. Accessed June 4, 2015.
- U.S. Environmental Protection Agency (U.S. EPA). 2011b. *Regulatory Impact Analysis for the Final Mercury and Air Toxics Standards*. EPA-452/R-11-011. December. Available at: <<http://www.epa.gov/ttn/ecas/regdata/RIAs/matsriafinal.pdf>>. Accessed June 4, 2015.
- U.S. Environmental Protection Agency (U.S. EPA). 2011c. Regulatory Impact Analysis: National Emission Standards for Hazardous Air Pollutants for Industrial, Commercial, and Institutional Boilers and Process Heaters. February. Available at: <http://www.epa.gov/ttnecas1/regdata/RIAs/boilersriafinal110221_psg.pdf>. Accessed June 4, 2015.
- U.S. Environmental Protection Agency (U.S. EPA). 2011d. *Policy Assessment for the Review of the Particulate Matter National Ambient Air Quality Standards*. EPA-452/D-11-003. Office of Air Quality Planning and Standards, Health and Environmental Impacts Division. April. Available at: <<http://www.epa.gov/ttn/naaqs/standards/pm/data/20110419pmpafinal.pdf>>. Accessed June 4, 2015.

- U.S. Environmental Protection Agency (U.S. EPA). 2012a. *Regulatory Impact Analysis for the Final Revisions to the National Ambient Air Quality Standards for Particulate Matter*. EPA-452/R-12-003. Office of Air Quality Planning and Standards, Health and Environmental Impacts Division, Research Triangle Park, NC. December. Available at: <<http://www.epa.gov/ttnecas1/regdata/RIAs/finalria.pdf>>. Accessed June 4, 2015.
- U.S. Environmental Protection Agency (U.S. EPA). 2012b. *Regulatory Impact Analysis: Petroleum Refineries New Source Performance Standards Ja*. Office of Air Quality Planning and Standards, Health and Environmental Impacts Division. June. Available at: <http://www.epa.gov/ttnecas1/regdata/RIAs/refineries_nsps_ja_final_ria.pdf>. Accessed June 4, 2015.
- U.S. Environmental Protection Agency (U.S. EPA). 2013a. *Technical Support Document: Estimating the Benefit per Ton of Reducing PM_{2.5} Precursors from 17 Sectors*. Office of Air Quality Planning and Standards, Research Triangle Park, NC. February. Available at: <<http://www2.epa.gov/sites/production/files/2014-10/documents/sourceapportionmentbpttsd.pdf>>. Accessed June 4, 2015.
- U.S. Environmental Protection Agency (U.S. EPA). 2013b. *Integrated Science Assessment of Ozone and Related Photochemical Oxidants (Final Report)*. EPA/600/R-10/076F. National Center for Environmental Assessment – RTP Division, Research Triangle Park. Available at: <<http://cfpub.epa.gov/ncea/isa/recordisplay.cfm?deid=247492#Download>>. Accessed June 4, 2015.
- U.S. Environmental Protection Agency (U.S. EPA). 2014. *Guidelines for Preparing Economic Analyses*. EPA 240-R-10-001. National Center for Environmental Economics, Office of the Administrator. Washington, DC. Available at: <<http://yosemite.epa.gov/EE/epa/eed.nsf/webpages/Guidelines.html>>. Accessed June 6, 2015.
- U.S. Environmental Protection Agency (U.S. EPA). 2014a. *Regulatory Impact Analysis for the Proposed Carbon Pollution Guidelines for Existing Power Plants and Emission Standards for Modified and Reconstructed Power Plants*. EPA-542/R-14-002. Office of Air Quality Planning and Standards, Research Triangle Park, NC. June. Available at <<http://www.epa.gov/ttnecas1/regdata/RIAs/111dproposalRIAFinal0602.pdf>>. Accessed June 4, 2015.

- U.S. Environmental Protection Agency (U.S. EPA). 2014b. *Health Risk and Exposure Assessment for Ozone: Final Report*. Office of Air Quality Planning and Standards, Research Triangle Park, NC. EPA-452/R-14-004a. Available at: <http://www.epa.gov/ttn/naaqs/standards/ozone/data/20140829healthrea.pdf>. Accessed June 4, 2015.
- U.S. Environmental Protection Agency (U.S. EPA). 2014c. *Welfare Risk and Exposure Assessment for Ozone: Final*. EPA-452/R-14-005a. Office of Air Quality Planning and Standards, Research Triangle Park, NC. August. Available at: <http://www.epa.gov/ttn/naaqs/standards/ozone/data/20141021welfarerea.pdf>. Accessed June 4, 2015.
- U.S. Environmental Protection Agency (U.S. EPA). 2014d. Regulatory Impact Analysis of the Proposed Revisions to the National Ambient Air Quality Standards for Ground-Level Ozone. EPA-452/P-14-006. Office of Air Quality Planning and Standards, Research Triangle Park, NC. November. Available at <http://www.epa.gov/ttnecas1/regdata/RIAs/20141125ria.pdf>. Accessed June 4, 2015.
- U.S. Environmental Protection Agency—Science Advisory Board (U.S. EPA-SAB). 2002. Workshop on the Benefits of Reductions in Exposure to Hazardous Air Pollutants: Developing Best Estimates of Dose-Response Functions An SAB Workshop Report of an EPA/SAB Workshop (Final Report). EPA-SAB-EC-WKSHP-02-001. January. Available at: [http://yosemite.epa.gov/sab/sabproduct.nsf/34355712EC011A358525719A005BF6F6/\\$File/ecwkshp02001%2Bappa-g.pdf](http://yosemite.epa.gov/sab/sabproduct.nsf/34355712EC011A358525719A005BF6F6/$File/ecwkshp02001%2Bappa-g.pdf). Accessed June 4, 2015.
- U.S. Environmental Protection Agency—Science Advisory Board (U.S. EPA-SAB). 2008. *Characterizing Uncertainty in Particulate Matter Benefits Using Expert Elicitation*. EPA-COUNCIL-08-002. July. Available at: [http://yosemite.epa.gov/sab/sabproduct.nsf/0/43B91173651AED9E85257487004EA6CB/\\$File/EPA-COUNCIL-08-002-unsigned.pdf](http://yosemite.epa.gov/sab/sabproduct.nsf/0/43B91173651AED9E85257487004EA6CB/$File/EPA-COUNCIL-08-002-unsigned.pdf). Accessed June 4, 2015.
- U.S. Environmental Protection Agency—Science Advisory Board (U.S. EPA-SAB). 2000. *An SAB Report on EPA's White Paper Valuing the Benefits of Fatal Cancer Risk Reduction*. EPA-SAB-EEAC-00-013. July. Available at: [http://yosemite.epa.gov/sab/sabproduct.nsf/41334524148BCCD6852571A700516498/\\$File/eeacf013.pdf](http://yosemite.epa.gov/sab/sabproduct.nsf/41334524148BCCD6852571A700516498/$File/eeacf013.pdf). Accessed June 4, 2015.

- U.S. Environmental Protection Agency—Science Advisory Board (U.S. EPA-SAB). 2004c. *Advisory Council on Clean Air Compliance Analysis Response to Agency Request on Cessation Lag*. EPA-COUNCIL-LTR-05-001. December. Available at: <[http://yosemite.epa.gov/sab/sabproduct.nsf/0/39F44B098DB49F3C85257170005293E0/\\$File/council_ltr_05_001.pdf](http://yosemite.epa.gov/sab/sabproduct.nsf/0/39F44B098DB49F3C85257170005293E0/$File/council_ltr_05_001.pdf)>. Accessed June 4, 2015.
- U.S. Environmental Protection Agency—Science Advisory Board (U.S. EPA-SAB). 2008. *Benefits of Reducing Benzene Emissions in Houston, 1990–2020*. EPA-COUNCIL-08-001. July. Available at: <[http://yosemite.epa.gov/sab/sabproduct.nsf/D4D7EC9DAEDA8A548525748600728A83/\\$File/EPA-COUNCIL-08-001-unsigned.pdf](http://yosemite.epa.gov/sab/sabproduct.nsf/D4D7EC9DAEDA8A548525748600728A83/$File/EPA-COUNCIL-08-001-unsigned.pdf)>. Accessed June 4, 2015.
- U.S. Environmental Protection Agency—Science Advisory Board (U.S. EPA-SAB). 2009b. *Review of EPA’s Integrated Science Assessment for Particulate Matter (First External Review Draft, December 2008)*. EPA-COUNCIL-09-008. May. Available at: <[http://yosemite.epa.gov/sab/SABPRODUCT.NSF/81e39f4c09954fcb85256ead006be86e/73ACCA834AB44A10852575BD0064346B/\\$File/EPA-CASAC-09-008-unsigned.pdf](http://yosemite.epa.gov/sab/SABPRODUCT.NSF/81e39f4c09954fcb85256ead006be86e/73ACCA834AB44A10852575BD0064346B/$File/EPA-CASAC-09-008-unsigned.pdf)>. Accessed June 4, 2015.
- U.S. Environmental Protection Agency—Science Advisory Board (U.S. EPA-SAB). 2009c. *Review of Integrated Science Assessment for Particulate Matter (Second External Review Draft, July 2009)*. EPA-CASAC-10-001. November. Available at: <[http://yosemite.epa.gov/sab/SABPRODUCT.NSF/81e39f4c09954fcb85256ead006be86e/151B1F83B023145585257678006836B9/\\$File/EPA-CASAC-10-001-unsigned.pdf](http://yosemite.epa.gov/sab/SABPRODUCT.NSF/81e39f4c09954fcb85256ead006be86e/151B1F83B023145585257678006836B9/$File/EPA-CASAC-10-001-unsigned.pdf)>. Accessed June 4, 2015.
- U.S. Environmental Protection Agency—Science Advisory Board (U.S. EPA-SAB). 2010a. *Review of EPA’s DRAFT Health Benefits of the Second Section 812 Prospective Study of the Clean Air Act*. EPA-COUNCIL-10-001. June. Available at: <[http://yosemite.epa.gov/sab/sabproduct.nsf/9288428b8eeea4c885257242006935a3/72D4EFA39E48CDB28525774500738776/\\$File/EPA-COUNCIL-10-001-unsigned.pdf](http://yosemite.epa.gov/sab/sabproduct.nsf/9288428b8eeea4c885257242006935a3/72D4EFA39E48CDB28525774500738776/$File/EPA-COUNCIL-10-001-unsigned.pdf)>. Accessed June 4, 2015.
- U.S. Environmental Protection Agency—Science Advisory Board (U.S. EPA-SAB). 2011. *Review of Valuing Mortality Risk Reductions for Environmental Policy: A White Paper (December 10, 2010)*. EPA-SAB-11-011 July. Available at: <[http://yosemite.epa.gov/sab/sabproduct.nsf/298E1F50F844BC23852578DC0059A616/\\$File/EPA-SAB-11-011-unsigned.pdf](http://yosemite.epa.gov/sab/sabproduct.nsf/298E1F50F844BC23852578DC0059A616/$File/EPA-SAB-11-011-unsigned.pdf)>. Accessed June 4, 2015.

Woodruff, T.J., J. Grillo, and K.C. Schoendorf. 1997. "The Relationship between Selected of postneonatal infant mortality and particulate air pollution in the United States." *Environmental Health Perspectives*. 105(6): 608-612.

APPENDIX 4A: GENERATING REGIONAL BENEFIT-PER-TON ESTIMATES

The purpose of this appendix is to provide additional detail regarding the generation of the benefit-per-ton estimates applied in Chapter 4 of this Regulatory Impact Analysis (RIA). Specifically, this appendix describes the methods for generating benefit-per-ton estimates by region for the contiguous U.S. for PM_{2.5} and ozone precursors emitted by the electrical generating unit (EGU) sector in the Final Carbon Pollution Emission Guidelines for Existing Stationary Sources: Electric Utility Generating Units (hereafter referred to as the “final emission guidelines” or “Clean Power Plan Final Rule”).

4A.1 Overview of Benefit-per-Ton Estimates

As described in the *Technical Support Document: Estimating the Benefit per Ton of Reducing PM_{2.5} Precursors from 17 Sectors* (U.S. EPA, 2013), the general procedure for calculating average benefit-per-ton coefficients generally follows three steps. As an example, in order to calculate regional average benefit-per-ton estimates for the key precursor pollutants emitted from EGU sources, we:

1. Use air quality modeling to predict changes in ambient concentrations of primary PM_{2.5}, nitrate, sulfate, and ozone at a 12km² grid resolution across the contiguous U.S. that are attributable to the proposed Clean Power Plan.
2. For each grid cell, estimate the health impacts, and the economic value of these impacts, associated with the attributable ambient concentrations using the environmental Benefits Mapping and Analysis Program – Community Edition (BenMAP-CE v1.1).^{120,121} Aggregate those impacts and economic values to the three regions of East, West, and California.
3. Divide the regional health impacts attributable to each precursor, and the regional monetary value of these impacts, by the amount of associated regional precursor emissions. That is, directly emitted PM_{2.5} benefits are divided by directly emitted PM_{2.5} emissions, sulfate benefits are divided by SO₂ emissions, nitrate benefits are divided by NO_x emissions, and ozone benefits are divided by ozone-season NO_x emissions.

¹²⁰ When estimating these impacts we apply effect coefficients that relate changes in total PM_{2.5} mass to the risk of adverse health outcomes; we do not apply effect coefficients that are differentiated by PM_{2.5} species.

¹²¹ Previous RIAs have used earlier versions of the BenMAP software. BenMAP-CE v1.1 provides results consistent with earlier versions of BenMAP and is available for download at <http://www.epa.gov/air/benmap/>.

4A.2 Air Quality Modeling for the Proposed Clean Power Plan

The EPA ran the Comprehensive Model with Extensions (CAMx) photochemical model (ENVIRON, 2014) to predict ozone and PM_{2.5} concentrations for the following emissions scenarios: a 2011 base year, a 2025 base case, and the 2025 proposed Clean Power Plan (Option 1 State) scenario. Each of the CAMx model simulations was performed for a nationwide modeling domain¹²² using a full year of meteorological conditions for 2011. The modeling for 2011 was used as the anchor point for projecting ozone and annual PM_{2.5} concentration values for the 2025 base case and for the 2025 Clean Power Plan proposal scenario using methodologies consistent with the EPA's air quality modeling guidance (U.S. EPA, 2007). The air quality modeling results for the 2025 base case served as the baseline for gauging the future year impacts on ozone and annual PM_{2.5} of the Clean Power Plan proposal scenario. The 2025 base case reflects emissions reductions between 2011 and 2025 that are expected to result from regional and national rules including the Clean Air Interstate Rule (CAIR), the Mercury and Air Toxics Standards (MATS), mobile source rules up through Tier-3, and various state emissions control programs and consent decrees. The methods for estimating the EGU emissions for the proposal are described in Chapter 3 of the RIA for the Clean Power Plan proposal (U.S. EPA, 2014). State total annual EGU emissions for NO_x and SO₂ for each of the scenarios modeled are provided in Tables 4A-1 and 4A-2, respectively. The data indicate that, overall nationwide, EGU SO₂ and NO_x emissions with proposed Option 1 (state) would be about 28% lower than the 2025 base case.

¹²² The modeling domain (i.e., region modeled) includes all of the lower 48 states plus adjacent portions of Canada and Mexico) at a spatial resolution of 12 km.

Table 4A-1. State Total Annual EGU Emissions for NO_x for the 2011 Base Year, 2025 Base Case, and 2025 Clean Power Plan Proposal (Option 1 State) (in thousands of tons)

State	2011 Base Year	2025 Base Case	2025 Clean Power Plan Proposal (Option 1 State)
Alabama	63	38	19
Arizona	35	17	4
Arkansas	38	43	9
California	6	33	28
Colorado	51	29	21
Connecticut	1	1	1
Delaware	4	1	1
Florida	61	52	15
Georgia	54	33	18
Idaho	-	1	0
Illinois	73	38	32
Indiana	121	97	90
Iowa	40	24	24
Kansas	44	28	27
Kentucky	92	59	74
Louisiana	47	18	14
Maine	2	4	2
Maryland	19	11	11
Massachusetts	5	2	1
Michigan	75	73	51
Minnesota	32	27	13
Mississippi	26	15	3
Missouri	66	61	58
Montana	20	16	15
Nebraska	37	38	35
Nevada	7	5	3
New Hampshire	4	1	0
New Jersey	6	7	2
New Mexico	23	7	6
New York	22	11	7
North Carolina	46	35	23
North Dakota	51	51	48
Ohio	104	63	60
Oklahoma	82	52	26
Oregon	5	3	3
Pennsylvania	149	106	71
Rhode Island	0	0	1
South Carolina	25	13	8
South Dakota	11	13	8
Tennessee	27	16	13
Texas	146	144	64
Tribal Data	65	33	33
Utah	51	49	33
Vermont	0	0	0

State	2011 Base Year	2025 Base Case	2025 Clean Power Plan Proposal (Option 1 State)
Virginia	38	21	12
Washington	7	3	2
West Virginia	58	49	46
Wisconsin	32	19	11
Wyoming	53	50	38
National Total	2,024	1,508	1,084

Table 4A-2. State Total Annual EGU Emissions for SO₂ for the 2011 Base Year, 2025 Base Case, and 2025 Clean Power Plan Proposal (Option 1 State) (in thousands of tons)

State	2011 Base Year	2025 Base Case	2025 Clean Power Plan Proposal (Option 1 State)
Alabama	186	79	45
Arizona	28	18	4
Arkansas	74	30	5
California	1	4	4
Colorado	45	15	10
Connecticut	1	-	-
Delaware	11	1	1
Florida	95	70	7
Georgia	187	37	12
Idaho	-	0	0
Illinois	227	45	48
Indiana	382	126	121
Iowa	100	18	18
Kansas	39	15	15
Kentucky	246	109	119
Louisiana	93	14	11
Maine	1	1	1
Maryland	32	5	9
Massachusetts	23	1	0
Michigan	228	122	95
Minnesota	40	21	12
Mississippi	43	10	3
Missouri	205	80	76
Montana	19	18	17
Nebraska	73	25	24
Nevada	5	1	1
New Hampshire	24	0	0
New Jersey	5	7	1
New Mexico	6	4	4
New York	41	4	2
North Carolina	78	36	33
North Dakota	93	15	14

State	2011 Base Year	2025 Base Case	2025 Clean Power Plan Proposal (Option 1 State)
Ohio	594	105	102
Oklahoma	96	21	6
Oregon	13	1	1
Pennsylvania	338	67	47
Rhode Island	0	-	-
South Carolina	68	19	12
South Dakota	11	11	7
Tennessee	120	38	31
Texas	426	149	48
Tribal Data	18	19	19
Utah	22	14	10
Vermont	0	0	0
Virginia	75	8	4
Washington	1	1	1
West Virginia	103	78	47
Wisconsin	92	17	11
Wyoming	55	23	17
National Total	4,665	1,504	1,077

As indicated above, the air quality modeling was used to project gridded ozone and annual PM_{2.5} concentrations at the 12km² resolution for the 2025 base case and the Clean Power Plan proposal scenario modeled for this analysis. The air quality modeling results were combined with monitored ozone and PM_{2.5} data to create projected spatial fields of annual PM_{2.5} and seasonal mean (May through September) 8-hour daily maximum ozone for the 2025 base case and for the proposal scenario. These spatial fields were then used as inputs to estimate the health co-benefits of the proposed Clean Power Plan as described below.

4A.3 Regional PM_{2.5} Benefit-per-Ton Estimates for EGUs Derived from Air Quality Modeling of the Proposed Clean Power Plan

After estimating the 12km² resolution PM_{2.5} benefits for each of the analysis years applied in this RIA (i.e., 2020, 2025, and 2030), we aggregated the benefits results regionally (i.e., East, West, and California), as shown in Figure 4A-1.¹²³ While a small percentage of benefits from emissions reductions in a particular region may occur in one of the other regions, we selected each region to minimize this percentage. Thus, the benefits per ton in each region

¹²³ This aggregation is identified as the shapefile “Report Regions” in BenMAP’s grid definitions.

will represent well the match between where the emissions reductions and air quality benefits are occurring. Due to the low emissions of SO₂, NO_x, and directly emitted particles from EGUs in California and the high population density, we separated out California in order not to bias the benefit-per-ton estimates for the rest of the Western U.S. In order to calculate the benefit-per-ton estimates, we divided the regional benefits estimates by the corresponding emissions, as shown in Table 4A-1. Lastly, we adjusted the benefit-per-ton estimates for a currency year of 2011\$.¹²⁴

This method provides estimates of the regional average benefit-per-ton for a subset of the major PM_{2.5} precursors emitted from EGU sources. For precursor emissions of NO_x, there is generally a non-linear relationship between emissions and formation of PM_{2.5}. This means that each ton of NO_x reduced would have a different impact on ambient PM_{2.5} depending on the initial level of emissions and potentially on the levels of emissions of other pollutants. In contrast, SO₂ is generally linear in forming PM_{2.5}. For precursors like NO_x which form PM_{2.5} non-linearly, a marginal benefit-per-ton approach would better approximate the specific benefits associated with an emissions reduction scenario for a given set of base case emissions, because it would allow the benefit-per-ton to vary depending on the level of emissions reductions and the baseline emissions levels. However, we do not have sufficient air quality modeling data to calculate marginal benefit-per-ton estimates for the EGU sector. Therefore, using an average benefit-per-ton estimate for NO_x adds uncertainty to the co-benefits estimated in this RIA. Because most of the estimated co-benefits for the proposed guidelines are attributable to reductions in SO₂ emissions, the added uncertainty is likely to be small.

¹²⁴ Currently, BenMAP does not have an inflation adjustment to 2011\$. We ran BenMAP for a currency year of 2010\$ and calculated the benefit-per-ton estimates in 2010\$. We then adjusted the resulting benefit-per-ton estimates to 2011\$ using the Consumer Price Index.



Figure 4A-1. Regional Breakdown

In this RIA, we estimate emission reductions from EGUs using IPM.¹²⁵ IPM outputs provide endogenously projected unit level emissions of SO₂, NO_x, CO₂, Hg, hydrogen chloride (HCl) from EGUs, but carbon monoxide, volatile organic compounds, ammonia and total directly emitted PM_{2.5} and PM₁₀ emissions are post-calculated.¹²⁶ In addition, directly emitted particle emissions calculated from IPM outputs do not include speciation, i.e. they are only the total emissions. In order to conduct air quality modeling, directly emitted PM_{2.5} from EGUs is speciated into components during the emissions modeling process based on emission profiles for EGUs by source classification code. Even though these speciation profiles are not unit-specific, an emission profile based on the source classification code is highly sophisticated and reflects the fuel and the unit configuration. Model-predicted concentrations of nitrate and sulfate include

¹²⁵ See Chapter 3 of this RIA for additional information regarding the Integrated Planning Model (IPM).

¹²⁶ Detailed documentation of this post-processing is available at http://www.epa.gov/powersectormodeling/docs/v513/FlatFile_Methodology.pdf

both the directly emitted nitrate and sulfate from speciated PM_{2.5} and secondarily formed nitrate and sulfate from emissions of NO_x and SO₂, respectively.

In order to estimate the benefits associated with reduced emissions of directly emitted particles without performing air quality modeling, we must determine the fraction of total PM_{2.5} emissions comprised of elemental carbon and organic carbon (EC+OC) and crustal emissions.¹²⁷ Based on the work by Fann, Baker, and Fulcher (2012), the national average EC+OC fraction of emitted PM_{2.5} is 10% with a range of 5% to 63% in different states due to the different proportion of fuels. The national average is similar to the averages for the east and west regions at 10% and 7%, respectively. Only five states had EC+OC fractions greater than 30%. For crustal emissions, the national average fraction of emitted PM_{2.5} from EGUs is 78% with a range of 26% to 83%. The national average is similar to the averages for the east and west regions at 78% and 81%, respectively. Only four states had crustal fractions less than 50%. In calculating the PM_{2.5} co-benefits in this RIA, we estimate the emission reductions of EC+OC and crustal emissions by applying the national average fractions (i.e., 78% crustal and 10% EC+OC) to the emission reductions of all directly emitted particles from EGUs. Because the benefit-per-ton estimates for reducing emissions of EC+OC are larger than the benefit-per-ton estimate for crustal emissions, this assumption underestimates the monetized PM_{2.5} co-benefits in certain states with higher EC+OC fractions, such as California and North Dakota.

Although it is possible to calculate 95th percentile confidence intervals using the approach described in this appendix (e.g., U.S. EPA, 2011b), we generally do not calculate confidence intervals for benefit-per-ton estimates because of the additional unquantified uncertainties that result from the benefit transfer methods, including those related to the transfer of air quality modeling information. Instead, we refer the reader to Chapter 5 of PM NAAQS RIA (U.S. EPA, 2012a) for an indication of the combined random sampling error in the health impact and economic valuation functions using Monte Carlo methods. In general, the 95th percentile confidence interval for the total monetized PM_{2.5} benefits ranges from approximately -90% to +180% of the central estimates based on concentration-response functions from Krewski *et al.* (2009) and Lepeule *et al.* (2012). The 95th percentile confidence interval for the health impact

¹²⁷ Crustal emissions are composed of compounds associated with minerals and metals from the earth's surface, including carbonates, silicates, iron, phosphates, copper, and zinc. Often, crustal material represents particles not classified as one of the other species (e.g., organic carbon, elemental carbon, nitrate, sulfate, chloride, etc.).

function alone ranges from approximately $\pm 30\%$ for mortality incidence based on Krewski *et al.* (2009) and $\pm 46\%$ based on Lepeule *et al.* (2012). These confidence intervals do not reflect other sources of uncertainty inherent within the estimates, such as baseline incidence rates, populations exposed, and transferability of the effect estimate to diverse locations. As a result, the reported confidence intervals and range of estimates give an incomplete picture about the overall uncertainty in the benefits estimates.

Tables 4A-3 through 4A-5 provide the regional benefit-per-ton estimates for the EGU sector at discount rates of 3% and 7% in 2020, 2025, and 2030 respectively. The benefit-per-ton values for 2020 and 2030 are based on applying the air quality modeling from 2025 to population and health information from 2020 and 2030. Estimated benefit-per-ton for these years have additional uncertainty relative to 2025 because of potential differences in atmospheric responses to reductions in PM_{2.5} precursors in those years, however, these uncertainties are likely to be relatively small. Tables 4A-6 through 4A-8 provide the incidence per ton estimates (which follows the same general methodology as for the benefit-per-ton calculations) for the EGU sector in 2020, 2025, and 2030 respectively, for the set of health endpoints used to calculate the benefit-per-ton estimates.

Table 4A-3. Summary of Regional PM_{2.5} Benefit-per-Ton Estimates Based on Air Quality Modeling from Proposed Clean Power Plan in 2020 (2011\$)*

Pollutant	Discount Rate	National	Region		
			East	West	California
SO ₂	3%	\$32,000 to \$71,000	\$33,000 to \$75,000	\$6,200 to \$14,000	\$95,000 to \$210,000
	7%	\$28,000 to \$64,000	\$30,000 to \$68,000	\$5,600 to \$13,000	\$85,000 to \$190,000
Directly emitted PM _{2.5} (EC+OC)	3%	\$140,000 to \$310,000	\$140,000 to \$320,000	\$27,000 to \$60,000	\$370,000 to \$830,000
	7%	\$120,000 to \$270,000	\$130,000 to \$290,000	\$24,000 to \$54,000	\$330,000 to \$740,000
Directly emitted PM _{2.5} (Crustal)	3%	\$22,000 to \$49,000	\$23,000 to \$52,000	\$11,000 to \$25,000	\$73,000 to \$160,000
	7%	\$20,000 to \$44,000	\$21,000 to \$47,000	\$9,900 to \$22,000	\$66,000 to \$150,000
NO _X (as PM _{2.5})	3%	\$3,000 to \$6,800	\$3,100 to \$7,000	\$0,670 to \$1,500	\$22,000 to \$49,000
	7%	\$2,700 to \$5,600	\$2,800 to \$6,300	\$0,610 to \$1,400	\$19,000 to \$44,000

* The range of estimates reflects the range of epidemiology studies for avoided premature mortality for PM_{2.5}. All estimates are rounded to two significant figures. All fine particles are assumed to have equivalent health effects, but the benefit-per-ton estimates vary depending on the location and magnitude of their impact on PM_{2.5} levels, which drive population exposure. The monetized benefits incorporate the conversion from precursor emissions to ambient fine particles. The estimates do not include reduced health effects from direct exposure to ozone, NO₂, SO₂, ecosystem effects, or visibility impairment.

Table 4A-4. Summary of Regional PM_{2.5} Benefit-per-Ton Estimates Based on Air Quality Modeling from Proposed Clean Power Plan in 2025 (2011\$)*

Pollutant	Discount Rate	National	Region		
			East	West	California
SO ₂	3%	\$35,000 to \$78,000	\$37,000 to \$83,000	\$7,100 to \$16,000	\$110,000 to \$240,000
	7%	\$31,000 to \$70,000	\$33,000 to \$75,000	\$6,400 to \$14,000	\$97,000 to \$220,000
Directly emitted PM _{2.5} (EC+OC)	3%	\$150,000 to \$340,000	\$160,000 to \$360,000	\$30,000 to \$68,000	\$410,000 to \$930,000
	7%	\$130,000 to \$290,000	\$140,000 to \$320,000	\$27,000 to \$61,000	\$370,000 to \$830,000
Directly emitted PM _{2.5} (Crustal)	3%	\$24,000 to \$55,000	\$25,000 to \$58,000	\$12,000 to \$28,000	\$82,000 to \$180,000
	7%	\$22,000 to \$49,000	\$23,000 to \$52,000	\$11,000 to \$25,000	\$74,000 to \$170,000
NO _X (as PM _{2.5})	3%	\$3,200 to \$7,300	\$3,300 to \$7,500	\$0,750 to \$1,700	\$24,000 to \$54,000
	7%	\$2,900 to \$6,000	\$3,000 to \$6,800	\$0,670 to \$1,500	\$22,000 to \$49,000

* The range of estimates reflects the range of epidemiology studies for avoided premature mortality for PM_{2.5}. All estimates are rounded to two significant figures. All fine particles are assumed to have equivalent health effects, but the benefit-per-ton estimates vary depending on the location and magnitude of their impact on PM_{2.5} levels, which drive population exposure. The monetized benefits incorporate the conversion from precursor emissions to ambient fine particles. The estimates do not include reduced health effects from direct exposure to ozone, NO₂, SO₂, ecosystem effects, or visibility impairment.

Table 4A-5. Summary of Regional PM_{2.5} Benefit-per-Ton Estimates Based on Air Quality Modeling from Proposed Clean Power Plan in 2030 (2011\$)*

Pollutant	Discount Rate	National	Region		
			East	West	California
SO ₂	3%	\$37,000 to \$85,000	\$40,000 to \$89,000	\$7,800 to \$18,000	\$120,000 to \$270,000
	7%	\$34,000 to \$76,000	\$36,000 to \$81,000	\$7,100 to \$16,000	\$110,000 to \$240,000
Directly emitted PM _{2.5} (EC+OC)	3%	\$160,000 to \$360,000	\$170,000 to \$380,000	\$33,000 to \$75,000	\$450,000 to \$1,000,000
	7%	\$150,000 to \$320,000	\$150,000 to \$340,000	\$30,000 to \$68,000	\$410,000 to \$920,000
Directly emitted PM _{2.5} (Crustal)	3%	\$26,000 to \$59,000	\$28,000 to \$62,000	\$14,000 to \$31,000	\$90,000 to \$200,000
	7%	\$24,000 to \$53,000	\$25,000 to \$56,000	\$13,000 to \$28,000	\$81,000 to \$180,000
NO _X (as PM _{2.5})	3%	\$3,400 to \$7,800	\$3,500 to \$8,000	\$0,820 to \$1,900	\$26,000 to \$60,000
	7%	\$3,100 to \$6,400	\$3,200 to \$7,200	\$0,740 to \$1,700	\$24,000 to \$54,000

* The range of estimates reflects the range of epidemiology studies for avoided premature mortality for PM_{2.5}. All estimates are rounded to two significant figures. All fine particles are assumed to have equivalent health effects, but the benefit-per-ton estimates vary depending on the location and magnitude of their impact on PM_{2.5} levels, which drive population exposure. The monetized benefits incorporate the conversion from precursor emissions to ambient fine particles. The estimates do not include reduced health effects from direct exposure to ozone, NO₂, SO₂, ecosystem effects, or visibility impairment.

Table 4A-6. Summary of Regional PM_{2.5} Incidence-per-Ton Estimates Based on Air Quality Modeling from Proposed Clean Power Plan in 2020*

Health Endpoint	East				West				California			
	SO ₂	NO _X	EC+OC	Crustal	SO ₂	NO _X	EC+OC	Crustal	SO ₂	NO _X	EC+OC	Crustal
Premature Mortality												
Krewski <i>et al.</i> (2009) – adult	0.003700	0.000340	0.016000	0.002500	0.000680	0.000073	0.002900	0.001200	0.010000	0.002400	0.040000	0.008000
Lepeule <i>et al.</i> (2012) – adult	0.008300	0.000770	0.036000	0.005700	0.001500	0.000170	0.006600	0.002700	0.023000	0.005400	0.091000	0.018000
Woodruff <i>et al.</i> (1997) – infants	0.000009	0.000001	0.000037	0.000006	0.000002	0.000000	0.000007	0.000003	0.000023	0.000007	0.000097	0.000019
Morbidity												
Emergency department visits for asthma	0.001900	0.000190	0.007800	0.001300	0.000290	0.000031	0.001200	0.000470	0.005300	0.001400	0.022000	0.004200
Acute bronchitis	0.005400	0.000510	0.023000	0.003700	0.001300	0.000200	0.005200	0.002100	0.019000	0.005000	0.077000	0.015000
Lower respiratory symptoms	0.069000	0.006500	0.300000	0.047000	0.016000	0.002500	0.067000	0.026000	0.240000	0.064000	0.970000	0.190000
Upper respiratory symptoms	0.098000	0.009300	0.420000	0.068000	0.023000	0.003600	0.095000	0.038000	0.340000	0.092000	1.400000	0.270000
Minor restricted-activity days	2.700000	0.250000	11.000000	1.900000	0.580000	0.078000	2.400000	0.920000	9.400000	2.200000	35.000000	6.800000
Lost work days	0.450000	0.043000	1.900000	0.310000	0.098000	0.013000	0.410000	0.160000	1.600000	0.380000	6.000000	1.100000
Asthma exacerbation	0.240000	0.023000	1.000000	0.170000	0.056000	0.008800	0.230000	0.091000	0.840000	0.220000	3.400000	0.650000
Hospital Admissions, Respiratory	0.001100	0.000100	0.004500	0.000720	0.000150	0.000015	0.000640	0.000260	0.002500	0.000580	0.009400	0.001900
Hospital Admissions, Cardiovascular	0.001300	0.000120	0.005600	0.000910	0.000200	0.000019	0.000820	0.000330	0.003000	0.000680	0.011000	0.002200
Non-fatal Heart Attacks (age>18)												
Peters <i>et al.</i> (2001)	0.004100	0.000390	0.018000	0.002800	0.000650	0.000064	0.002800	0.001200	0.011000	0.002400	0.041000	0.007900
Pooled estimate of 4 studies	0.000450	0.000042	0.001900	0.000310	0.000070	0.000007	0.000300	0.000130	0.001100	0.000260	0.004400	0.000850

* All estimates are rounded to two significant figures. All fine particles are assumed to have equivalent health effects, but the incidence-per-ton estimates vary depending on the location and magnitude of their impact on PM_{2.5} levels, which drive population exposure. The incidence benefit-per-ton estimates incorporate the conversion from precursor emissions to ambient fine particles.

Table 4A-7. Summary of Regional PM_{2.5} Incidence-per-Ton Estimates Based on Air Quality Modeling from Proposed Clean Power Plan in 2025*

Health Endpoint	East				West				California			
	SO ₂	NO _X	EC+OC	Crustal	SO ₂	NO _X	EC+OC	Crustal	SO ₂	NO _X	EC+OC	Crustal
Premature Mortality												
Krewski <i>et al.</i> (2009) – adult	0.003900	0.000350	0.017000	0.002700	0.000750	0.000079	0.003200	0.001300	0.011000	0.002600	0.044000	0.008700
Lepeule <i>et al.</i> (2012) – adult	0.008900	0.000800	0.038000	0.006200	0.001700	0.000180	0.007300	0.003000	0.026000	0.005800	0.099000	0.020000
Woodruff <i>et al.</i> (1997) – infants	0.000008	0.000001	0.000035	0.000006	0.000002	0.000000	0.000007	0.000003	0.000022	0.000007	0.000093	0.000018
Morbidity												
Emergency department visits for asthma	0.002000	0.000200	0.006300	0.001300	0.000320	0.000033	0.001000	0.000510	0.005500	0.001500	0.018000	0.004400
Acute bronchitis	0.005700	0.000520	0.024000	0.003900	0.001300	0.000210	0.005600	0.002200	0.020000	0.005300	0.080000	0.015000
Lower respiratory symptoms	0.072000	0.006700	0.310000	0.050000	0.017000	0.002700	0.071000	0.028000	0.250000	0.067000	1.000000	0.200000
Upper respiratory symptoms	0.100000	0.009600	0.440000	0.071000	0.024000	0.003800	0.100000	0.040000	0.360000	0.096000	1.500000	0.280000
Minor restricted-activity days	2.800000	0.250000	12.000000	1.900000	0.610000	0.083000	2.500000	0.970000	9.600000	2.300000	36.000000	6.900000
Lost work days	0.470000	0.043000	2.000000	0.320000	0.100000	0.014000	0.430000	0.160000	1.600000	0.390000	6.100000	1.200000
Asthma exacerbation	0.250000	0.023000	1.100000	0.170000	0.059000	0.009300	0.250000	0.097000	0.880000	0.230000	3.500000	0.680000
Hospital Admissions, Respiratory	0.001200	0.000110	0.005100	0.000810	0.000180	0.000017	0.000740	0.000300	0.002800	0.000650	0.011000	0.002100
Hospital Admissions, Cardiovascular	0.001400	0.000130	0.006200	0.001000	0.000220	0.000022	0.000930	0.000380	0.003300	0.000750	0.012000	0.002400
Non-fatal Heart Attacks (age>18)												
Peters <i>et al.</i> (2001)	0.004600	0.000430	0.020000	0.003100	0.000740	0.000071	0.003200	0.001300	0.012000	0.002700	0.046000	0.008900
Pooled estimate of 4 studies	0.000490	0.000046	0.002100	0.000340	0.000080	0.000008	0.000340	0.000140	0.001300	0.000290	0.004900	0.000950

* All estimates are rounded to two significant figures. All fine particles are assumed to have equivalent health effects, but the incidence-per-ton estimates vary depending on the location and magnitude of their impact on PM_{2.5} levels, which drive population exposure. The incidence benefit-per-ton estimates incorporate the conversion from precursor emissions to ambient fine particles.

Table 4A-8. Summary of Regional PM_{2.5} Incidence-per-Ton Estimates Based on Air Quality Modeling from Proposed Clean Power Plan in 2030*

Health Endpoint	East				West				California			
	SO ₂	NO _X	EC+OC	Crustal	SO ₂	NO _X	EC+OC	Crustal	SO ₂	NO _X	EC+OC	Crustal
Premature Mortality												
Krewski <i>et al.</i> (2009) – adult	0.004200	0.000380	0.018000	0.002900	0.000840	0.000087	0.003600	0.001500	0.013000	0.002800	0.048000	0.009600
Lepeule <i>et al.</i> (2012) – adult	0.009600	0.000850	0.041000	0.006700	0.001900	0.000200	0.008100	0.003400	0.029000	0.006400	0.110000	0.022000
Woodruff <i>et al.</i> (1997) – infants	0.000008	0.000001	0.000033	0.000005	0.000002	0.000000	0.000007	0.000003	0.000021	0.000006	0.000088	0.000017
Morbidity												
Emergency department visits for asthma	0.001600	0.000160	0.006600	0.001100	0.000260	0.000027	0.001100	0.000420	0.004500	0.001200	0.019000	0.003500
Acute bronchitis	0.005900	0.000540	0.025000	0.004100	0.001400	0.000220	0.005900	0.002300	0.021000	0.005400	0.083000	0.016000
Lower respiratory symptoms	0.075000	0.006800	0.320000	0.052000	0.018000	0.002800	0.075000	0.030000	0.260000	0.069000	1.100000	0.200000
Upper respiratory symptoms	0.110000	0.009800	0.460000	0.074000	0.026000	0.004000	0.110000	0.042000	0.370000	0.099000	1.500000	0.290000
Minor restricted-activity days	2.900000	0.260000	12.000000	2.000000	0.650000	0.088000	2.700000	1.000000	9.800000	2.300000	37.000000	7.100000
Lost work days	0.480000	0.043000	2.000000	0.330000	0.110000	0.015000	0.450000	0.170000	1.700000	0.400000	6.300000	1.200000
Asthma exacerbation	0.260000	0.024000	1.100000	0.180000	0.063000	0.009800	0.260000	0.100000	0.920000	0.240000	3.700000	0.710000
Hospital Admissions, Respiratory	0.001300	0.000120	0.005600	0.000900	0.000200	0.000019	0.000830	0.000340	0.003200	0.000740	0.012000	0.002400
Hospital Admissions, Cardiovascular	0.001600	0.000150	0.006800	0.001100	0.000250	0.000024	0.001000	0.000420	0.003800	0.000850	0.014000	0.002700
Non-fatal Heart Attacks (age>18)												
Peters <i>et al.</i> (2001)	0.005000	0.000460	0.021000	0.003500	0.000830	0.000079	0.003600	0.001500	0.014000	0.003100	0.052000	0.010000
Pooled estimate of 4 studies	0.000540	0.000049	0.002300	0.000370	0.000090	0.000009	0.000380	0.000160	0.001500	0.000330	0.005600	0.001100

* All estimates are rounded to two significant figures. All fine particles are assumed to have equivalent health effects, but the incidence-per-ton estimates vary depending on the location and magnitude of their impact on PM_{2.5} levels, which drive population exposure. The incidence benefit-per-ton estimates incorporate the conversion from precursor emissions to ambient fine particles.

4A.4 Regional Ozone Benefit-per-Ton Estimates

The process for generating the regional ozone benefit-per-ton estimates is consistent with the process for PM_{2.5}. Ozone is not directly emitted, and is a non-linear function of NO_x and VOC emissions. For the purpose of estimating benefit-per-ton for this RIA, we assume that all of the ozone impacts from EGUs are attributable to NO_x emissions. VOC emissions, which are also a precursor to ambient ozone formation, are insignificant from the EGU sector relative to both NO_x emissions from EGUs and the total VOC emissions inventory. Therefore, we believe that our assumption that EGU-attributable ozone formation at the regional-level is due to NO_x alone is reasonable.

Similar to PM_{2.5}, this method provides estimates of the regional average benefit-per-ton. Due to the non-linear chemistry between NO_x emissions and ambient ozone, using an average benefit-per-ton estimate for NO_x adds uncertainty to the ozone co-benefits estimated for the proposed guidelines. Because most of the estimated co-benefits for the proposed guidelines are attributable to changes in ambient PM_{2.5}, the added uncertainty is likely to be small.

In the ozone co-benefits estimated in this RIA, we apply the benefit-per-ton estimates calculated using NO_x emissions derived from modeling the Clean Power Plan proposal during the ozone-season only (May to September). As shown in Table 4A-1, ozone-season NO_x emissions from EGUs are slightly less than half of all-year NO_x emissions. Because we estimate ozone health impacts from May to September only, this approach underestimates ozone co-benefits in areas with longer ozone seasons such as southern California and Texas. When the underestimated benefit-per-ton estimate is multiplied by ozone-season only NO_x emission reductions, this results in an underestimate of the monetized ozone co-benefits. For illustrative purposes, Tables 4A-9 through 4A-11 provide the ozone benefit-per-ton estimates using both all-year NO_x emissions and ozone-season only NO_x for 2020, 2025, and 2030, respectively. Tables 4A-12 through 4A-14 provide the ozone season incidence-per-ton estimates for 2020, 2025, and 2030, respectively. Similar to PM_{2.5}, the ozone benefit-per-ton values for 2020 and 2030 are based on applying the air quality modeling from 2025 to population and health information from 2020 and 2030. Estimated benefit-per-ton for these years have additional uncertainty relative to 2025 because of potential differences in atmospheric responses to reductions in ozone precursors

in those years. Uncertainties may be somewhat larger in the case of ozone due to high degree of dependence of ozone responses to baseline meteorology and emissions levels.

Table 4A-9. Summary of Regional Ozone Benefit-per-Ton Estimates Based on Air Quality Modeling from Proposed Clean Power Plan in 2020 (2011\$)*

Ozone precursor Pollutant	National	Regional		
		East	West	California
Ozone season NO _x	\$6,000 to \$26,000	\$6,500 to \$28,000	\$2,000 to \$8,900	\$14,000 to \$59,000

* The range of estimates reflects the range of epidemiology studies for avoided premature mortality for ozone. All estimates are rounded to two significant figures. The monetized benefits incorporate the conversion from NO_x precursor emissions to ambient ozone.

Table 4A-10. Summary of Regional Ozone Benefit-per-Ton Estimates Based on Air Quality Modeling from Proposed Clean Power Plan in 2025 (2011\$)*

Ozone precursor Pollutant	National	Regional		
		East	West	California
Ozone season NO _x	\$6,600 to \$27,000	\$7,100 to \$30,000	\$2,300 to \$10,000	\$15,000 to \$66,000

* The range of estimates reflects the range of epidemiology studies for avoided premature mortality for ozone. All estimates are rounded to two significant figures. The monetized benefits incorporate the conversion from NO_x precursor emissions to ambient ozone.

Table 4A-11. Summary of Regional Ozone Benefit-per-Ton Estimates Based on Air Quality Modeling from Proposed Clean Power Plan in 2030 (2011\$)*

Ozone precursor Pollutant	National	Regional		
		East	West	California
Ozone season NO _x	\$7,100 to \$29,000	\$7,600 to \$33,000	\$2,600 to \$11,000	\$17,000 to \$73,000

* The range of estimates reflects the range of epidemiology studies for avoided premature mortality for ozone. All estimates are rounded to two significant figures. The monetized benefits incorporate the conversion from NO_x precursor emissions to ambient ozone.

Table 4A-12. Summary of Regional Ozone Incidence-per-Ton Estimates Based on Air Quality Modeling from Proposed Clean Power Plan in 2020*

Health Endpoint	East	West	California
Premature Mortality – adult			
Bell <i>et al.</i> (2004)	0.000600	0.000190	0.001300
Levy <i>et al.</i> (2005)	0.002800	0.000880	0.005800
Morbidity			
Hospital Admissions, Respiratory (ages > 65)	0.003500	0.000900	0.006600
Hospital Admissions, Respiratory (ages < 2)	0.001800	0.000780	0.003300
Emergency Room Visits, Respiratory	0.002000	0.000500	0.003900
Acute Respiratory Symptoms	3.500000	1.300000	8.800000
School Loss Days	1.200000	0.490000	3.000000

* All estimates are rounded to two significant figures. The incidence benefit-per-ton estimates incorporate the conversion from NO_x precursor emissions to ambient ozone. These estimates reflect ozone-season NO_x emissions.

Table 4A-13. Summary of Regional Ozone Incidence-per-Ton Estimates Based on Air Quality Modeling from Proposed Clean Power Plan in 2025*

Health Endpoint	East	West	California
Premature Mortality – adult			
Bell <i>et al.</i> (2004)	0.000640	0.000210	0.001400
Levy <i>et al.</i> (2005)	0.002900	0.000970	0.006400
Morbidity			
Hospital Admissions, Respiratory (ages > 65)	0.004100	0.001100	0.007800
Hospital Admissions, Respiratory (ages < 2)	0.001800	0.000820	0.003400
Emergency Room Visits, Respiratory	0.002000	0.000540	0.004100
Acute Respiratory Symptoms	3.600000	1.400000	8.900000
School Loss Days	1.300000	0.520000	3.200000

* All estimates are rounded to two significant figures. The incidence benefit-per-ton estimates incorporate the conversion from NO_x precursor emissions to ambient ozone. These estimates reflect ozone-season NO_x emissions.

Table 4A-14. Summary of Regional Ozone Incidence-per-Ton Estimates Based on Air Quality Modeling from Proposed Clean Power Plan in 2030*

Health Endpoint	East	West	California
Premature Mortality – adult			
Bell <i>et al.</i> (2004)	0.000640	0.000230	0.001800
Levy <i>et al.</i> (2005)	0.002900	0.001100	0.008200
Morbidity			
Hospital Admissions, Respiratory (ages > 65)	0.004400	0.001300	0.011000
Hospital Admissions, Respiratory (ages < 2)	0.001800	0.000860	0.004100
Emergency Room Visits, Respiratory	0.002000	0.000580	0.005000
Acute Respiratory Symptoms	3.500000	1.500000	11.000000
School Loss Days	1.200000	0.550000	3.800000

* All estimates are rounded to two significant figures. The incidence benefit-per-ton estimates incorporate the conversion from NO_x precursor emissions to ambient ozone. These estimates reflect ozone-season NO_x emissions.

4A.5 References

- Abt Associates, Inc. 2010. "User's Guide: Modeled Attainment Test Software." Available at: <http://www.epa.gov/scram001/modelingapps_mats.htm>. Accessed June 6, 2015.
- Abt Associates, Inc. 2012. "BenMAP User's Manual Appendices," prepared for U.S. Research Triangle Park, NC: U. S. Environmental Protection Agency, Office of Air Quality Planning and Standards. Available at: <<http://www.epa.gov/air/benmap/models/BenMAPAppendicesOct2012.pdf>>. Accessed June 6, 2015.
- Bell, M.L., A. McDermott, S.L. Zeger, J.M. Samet, and F. Dominici. 2004. "Ozone and Short-Term Mortality in 95 U.S. Urban Communities, 1987-2000." *Journal of the American Medical Association*. 292(19):2372-8.
- Bell, M.L., F. Dominici, and J.M. Samet. 2005. "A Meta-Analysis of Time-Series Studies of Ozone and Mortality with Comparison to the National Morbidity, Mortality, and Air Pollution Study." *Epidemiology*. 16(4):436-45.
- ENVIRON International Corporation. 2014. User's Guide: Comprehensive Air Quality Model with Extensions, Version 6.1, Novato, CA. April. Available at <<http://www.camx.com>>. Accessed June 6, 2015.
- Fann, N., C.M. Fulcher, and B.J. Hubbell. 2009. "The Influence of Location, Source, and Emission Type in Estimates of the Human Health Benefits of Reducing a Ton of Air Pollution." *Air Quality and Atmospheric Health*. 2:169-176.
- Fann, N., K.R. Baker, and C.M. Fulcher. 2012. "Characterizing the PM_{2.5}-Related Health Benefits of Emission Reductions for 17 Industrial, Area and Mobile Emission Sectors Across the U.S." *Environment International*. 49:41-151.
- Fann, N., K.R. Baker, and C.M. Fulcher. 2013. "The Recent and Future Health Burden of Air Pollution Apportioned Across 23 U.S. Sectors." *Environmental Scientific Technology*. 47(8): 3580-3589.
- Huang Y., F. Dominici, and M. Bell. 2005. "Bayesian Hierarchical Distributed Lag Models for Summer Ozone Exposure and Cardio-Respiratory Mortality." *Environmetrics*. 16:547-562.
- Ito, K., S.F. De Leon, and M. Lippmann. 2005. "Associations between Ozone and Daily Mortality: Analysis and Meta-Analysis." *Epidemiology*. 16(4):446-57.

- Krewski D., M. Jerrett, R.T. Burnett, R. Ma, E. Hughes, Y. Shi, *et al.* 2009. *Extended Follow-Up and Spatial Analysis of the American Cancer Society Study Linking Particulate Air Pollution and Mortality*. HEI Research Report, 140, Health Effects Institute, Boston, MA.
- Lepeule, J., F. Laden, D. Dockery, and J. Schwartz. 2012. "Chronic Exposure to Fine Particles and Mortality: An Extended Follow-Up of the Harvard Six Cities Study from 1974 to 2009." *Environmental Health Perspectives*. 120(7):965-70.
- Levy, J.I., S.M. Chemerynski, and J.A. Sarnat. 2005. "Ozone Exposure and Mortality: An Empiric Bayes Metaregression Analysis." *Epidemiology*. 16(4):458-68.
- Roman, H.A., K. D. Walker, T. L. Walsh, L. Conner, H. M. Richmond, B. J. Hubbell, and P. L. Kinney. 2008. "Expert Judgment Assessment of the Mortality Impact of Changes in Ambient Fine Particulate Matter in the U.S." *Environmental Scientific Technology*. 42(7):2268-2274.
- Schwartz, J. 2005. "How Sensitive is the Association between Ozone and Daily Deaths to Control for Temperature?" *American Journal of Respiratory and Critical Care Medicine*. 171(6): 627-31.
- U.S. Environmental Protection Agency (U.S. EPA). 2007. *Guidance on the Use of Models and Other Analyses for Demonstrating Attainment of Air Quality Goals for Ozone, PM_{2.5}, and Regional Haze*. Office of Air Quality Planning and Standards, Research Triangle Park, NC. Available at <<http://www.epa.gov/ttn/scram/guidance/guide/final-03-pm-rh-guidance.pdf>>. Accessed June 4, 2015.
- U.S. Environmental Protection Agency (U.S. EPA). 2011b *Regulatory Impact Analysis for the Final Mercury and Air Toxics Standards*. Research Triangle Park, NC: Office of Air Quality Planning and Standards, Health and Environmental Impacts Division. (EPA document number EPA-452/R-11-011, December). Available at <<http://www.epa.gov/ttn/ecas/regdata/RIAs/matsriafinal.pdf>>. Accessed June 4, 2015.
- U.S. Environmental Protection Agency (U.S. EPA). 2012a. *Regulatory Impact Analysis for the Final Revisions to the National Ambient Air Quality Standards for Particulate Matter*. EPA-452/R-12-003. Office of Air Quality Planning and Standards, Health and Environmental Impacts Division, Research Triangle Park, NC. December. Available at: <<http://www.epa.gov/ttnecas1/regdata/RIAs/finalria.pdf>>. Accessed June 4, 2015.

U.S. Environmental Protection Agency (U.S. EPA). 2013. *Technical Support Document: Estimating the Benefit per Ton of Reducing PM_{2.5} Precursors from 17 Sectors*. Office of Air Quality Planning and Standards, Research Triangle Park, NC. February. Available at: <<http://www2.epa.gov/sites/production/files/2014-10/documents/sourceapportionmentbpttsd.pdf>>. Accessed June 4, 2015.

U.S. Environmental Protection Agency (U.S. EPA). 2014. *Regulatory Impact Analysis for the Proposed Carbon Pollution Guidelines for Existing Power Plants and Emission Standards for Modified and Reconstructed Power Plants*. EPA-542/R-14-002. Office of Air Quality Planning and Standards, Research Triangle Park, NC. June. Available at <<http://www.epa.gov/ttnecas1/regdata/RIAs/111dproposalRIAFinal0602.pdf>>. Accessed June 4, 2015.

CHAPTER 5: ECONOMIC IMPACTS – MARKETS OUTSIDE THE UTILITY POWER SECTOR

5.1 Introduction

The energy sector impacts presented in Chapter 3 of this RIA include potential changes in the prices for electricity, natural gas, and coal potentially resulting from the Clean Power Plan Final Rule. This chapter addresses the impact of these potential changes on other markets and discusses some of the determinants of the magnitude of these impacts. We refer to these changes as secondary market impacts.

Under the final emission guidelines, states are not required to use any of the measures that the EPA determines constitute BSER, or use those measures to the same degree of stringency that the EPA determines is achievable at reasonable cost. Rather, CAA section 111(d) allows each state to determine the appropriate combination of, and the extent of its reliance on, measures for its state plan, by way of meeting its state-specific goal. Given the flexibilities afforded states in complying with the emission guidelines, the benefits, cost and economic impacts reported in this RIA are illustrative of actions that states may take. The implementation approaches adopted by the states, and the strategies adopted by affected EGUs, will ultimately drive the magnitude and timing of secondary impacts from changes in the price of electricity, and the demand for inputs by the electricity sector, on other markets that use and produce these inputs.

The flexibility afforded to states in their state plans allows them to encourage compliance methods by affected EGUs, which include design elements that may mitigate or promote particular impacts based on their priorities. For example, states in the Regional Greenhouse Gas Initiative use the revenues from allowance auctions to support direct bill assistance for retail consumers, fund investments in clean energy and electricity demand reduction for business consumers, and support employment in the development of clean and renewable energy technologies. In its recent regulations to limit greenhouse gas (GHG) emissions, California's Air Resources Board designated a portion of allowances to be allocated to electric distribution companies in order to mitigate potential electricity rate increases and their associated impacts. Other states may encourage compliance methods by affected EGUs with particularly robust

deployment of renewables, energy efficiency, or natural gas to promote manufacturing demand or employment in those sectors. For example, energy efficiency investments may be targeted towards reducing both electricity consumption and natural gas or heating oil consumption, such as weatherization projects. The state plan approach and the composition of these programs will influence the effects of compliance with the final rulemaking.

To estimate the costs, benefits, and impacts of implementing the CPP guidelines, the EPA modeled two illustrative plan approaches: a rate-based approach and a mass-based approach. Chapter 3 provides a description of the illustrative plan approaches analyzed. This chapter provides a quantitative assessment of the energy price impacts for these illustrative approaches and a qualitative assessment of the factors that will in part determine the timing and magnitude of effects in other markets.

5.2 Methods

One potential quantitative approach to evaluating the secondary market impacts is to use a computable general equilibrium (CGE) model. CGE models are able to provide aggregated representations of the whole economy in equilibrium in the baseline and potentially with regulation in place. As such, CGE model may be able to capture interactions between economic sectors and provide information on changes outside of the directly regulated sector. In support of previous rulemakings, such as the 2008 Final Ozone NAAQS (U.S. EPA 2008) and the 2010 Transport Rule proposal (U.S. EPA 2010), the EPA used the Economic Model for Policy Analysis (EMPAX) CGE model to estimate the secondary market effects based on the cost impacts projected by the Integrated Planning Model (IPM) for the directly regulated sector.

When considering the secondary market impacts of a regulation both the effects of the costs, the benefits of improved air quality, and their interaction may be relevant. Therefore, in the Second Prospective Analysis under Section 812 of the Clean Air Act Amendments the EPA incorporated a set of health benefits arising from air quality improvement into the EMPAX CGE model when studying the economy-wide impacts of the Clean Air Act (U.S. EPA 2011). While the external Council on Clean Air Compliance Analysis (Council) review of this study stated that inclusion of benefits in an economy-wide model “represent[ed] a significant step forward in benefit-cost analysis” (Hammit 2010), the EPA recognizes that serious technical challenges

remain when attempting to evaluate the benefits and costs of potential regulatory actions using economy-wide models.

In light of these challenges, the EPA has established a Science Advisory Board (SAB) panel on economy-wide modeling to consider the technical merits and challenges of using this analytical tool to evaluate costs, benefits, and economic impacts in regulatory development. In addition, EPA is asking the panel to identify potential paths forward for improvements that could address the challenges posed when using economy-wide models to evaluate the effects of regulations. The final panel membership was announced in March 2015 and the first of multiple face-to-face meetings of the SAB panel has been scheduled for October 2015. The EPA will use the recommendations and advice of this panel as an input into its process for improving benefit-cost and economic impact analyses used to inform decision-making at the agency.

The advice from the Science Advisory Board (SAB) panel formed specifically to address the subject of economy-wide modeling was not available in time for this final action. Given the ongoing SAB panel on economy-wide modeling, the uncertain nature of the ultimate energy price impacts due to the state flexibility in choosing a plan and the compliance flexibility for affected EGUs, and the ongoing challenges of accurately representing costs, benefits, energy efficiency improvements in economy-wide modeling, this chapter considers the energy impacts associated with the illustrative plan approaches analyzed and a qualitative assessment of the factors that will, in part, determine the timing and magnitude of effects in other markets.

5.3 Summary of Secondary Market Impacts of Energy Price Changes

Electricity, natural gas, and coal are important inputs to the production of other goods and services. Therefore, changes in the price of these commodities will shift the production costs for sectors that use electricity, natural gas, and coal in the production of other goods and services. Changes in the types and levels of inputs used by producers in response to electricity and fuel price changes may mitigate the production cost changes in these sectors. Such changes in production costs may lead to changes in the quantities and/or prices of the goods or services produced and changes in imports and exports.

The EPA used IPM to estimate electricity, natural gas, and coal price changes based on the illustrative plan approaches modeled for this rule. IPM is a multi-regional, dynamic,

deterministic linear programming model of the U.S. electric power sector described in more detail in Chapter 3. The Retail Price Model (RPM) uses forecast changes in wholesale prices and the cost of demand-side energy efficiency programs to forecast changes in average retail prices. The prices are average prices over consumer classes and regions weighted by the amount used. Table 5-1 shows these estimated price changes. For other results generated by IPM and the RPM, please refer to Chapter 3.

There are many factors influencing the projected natural gas prices. IPM (and its integrated gas resource and supply module) models natural gas reserves appropriate natural gas supplies based on a multitude of factors. Since the model simulates perfect foresight, it anticipates future demand for natural gas and responds accordingly. In addition, IPM (and the natural gas module) are viewing a very long time horizon (through 2050), such that the impacts in certain years may be responsive to other modeling assumptions or drivers. The modeling framework is simultaneously solving for all of these key market and policy parameters (both electric and natural gas), resulting in the impacts shown.

Table 5-1. Estimated Percentage Changes in Average Energy Prices by Energy Type for the Final Emission Guidelines, Rate-based and Mass-based Illustrative Plan Approaches

Rate-based	2020	2025	2030
Electricity Price Change	3.2%	0.9%	0.8%
Delivered Natural Gas Price Change	5.3%	-7.7%	2.5%
Delivered Coal Price Change	-1.7%	-6.2%	-8.0%
Mass-based	2020	2025	2030
Electricity Price Change	3.0%	2.0%	0.0%
Delivered Natural Gas Price Change	3.8%	-3.2%	-2.1%
Delivered Coal Price Change	-1.6%	-4.3%	-4.6%

For years when the price of electricity, natural gas, or coal increased, one would expect decreases in production and increases in market prices in sectors for which these commodities are inputs, *ceteris paribus*. Conversely, for years when prices of these inputs decreased, one would expect increases in production and decreases in market prices within these sectors. Smaller changes in input price changes would lead to smaller impacts within secondary markets. However, a number of factors in addition to the magnitude and sign of the energy price changes,

influence the magnitude of the impact on production and market prices for sectors using electricity, natural gas, or coal as inputs to production. These factors are discussed below.

5.3.1 Share of Total Production Costs

The impact of energy price changes in a particular sector depends, in part, on the share of total production costs attributable to those commodities. For sectors in which the directly affected inputs are only a small portion of production costs, the impact will be smaller than for sectors in which these inputs make up a greater portion of total production costs. Therefore, more energy-intensive sectors would potentially experience greater cost increases when electricity, natural gas, or coal prices increase, but would also experience greater reduced costs when these input prices decrease.¹²⁸

5.3.2 Ability to Substitute between Inputs to the Production Process

The ease with which producers are able to substitute other inputs for electricity, natural gas, or coal, or even amongst those commodities, influences the impact of price changes for these inputs. Those sectors with a greater ability to substitute across energy inputs or to other inputs will be able to, at least partially, offset the increased cost of these inputs resulting in smaller market impacts. Similarly, when prices for electricity, natural gas, or coal decrease, some sectors may choose to use more of these inputs in place of other more costly substitutes.

5.3.3 Availability of Substitute Goods and Services

The ability of producers in sectors experiencing changes in their input prices to pass along the increased costs to their customers in the form of higher prices for their products depends, in part, on the availability of substitutes for the sectors' products. Substitutes may be either other domestic products or foreign imports. If close substitutes exist, the demand for the product will in general be more elastic and the producers will be less able to pass on the added cost through a price increase.

¹²⁸ The net direct effect of this rulemaking on the production costs of a sector that is attributable to a change in the electricity price also depends on the expenditures the sector makes to reduce its demand for electricity under any energy efficiency program that was adopted to achieve a state goal. That said, those expenditures may lead to other reduced expenditures for the sector, such as reduced natural gas use from weatherization projects.

Such substitution can also take place between foreign and domestic goods within the same sector. Changes in the price of electricity, natural gas, and coal can influence the quantities of goods imported or exported from sectors using these inputs. When the cost of domestic production increases due to more expensive inputs, imports may increase as consumers substitute towards relatively less costly foreign-produced goods. If imports increase because of a regulation and those imports come from countries with higher emissions per unit of production, this can result in foreign emission increases that offset some portion of domestic decreases, an effect commonly referred to as “leakage.” Alternatively, if those imports are less emissions-intensive than the sectors that have contracted, emissions may fall even further. The potential for changes in global pollutants such as carbon dioxide (CO₂) and other GHG emissions is noteworthy. Unlike most criteria pollutants and hazardous air pollutants, the impacts of CO₂ emissions are not affected by the location from which those emissions originate. A more complete evaluation of the effect of this regulation on GHG emissions from other countries would account for whether those countries have, or are expected to implement, policies affecting their GHG emissions. This may include the potential that the present regulation could change the likelihood that other countries will adopt policies affecting their GHG emissions.

5.4 Effect of Changes in Input Demand from Electricity Sector

Section 5.2 focuses on the effects of changes in energy prices, and possible responses to those price changes, on sectors outside of the electricity sector. A change in demand for inputs in the electricity sector, as well as changes in demand for energy efficiency services and products, will also influence economic activity in other sectors of the economy. For example, there will be changes in the demand for new generation sources such as natural gas combined cycle units and renewables, and therefore sectors producing these technologies may expand. Therefore, while a sector that produces say, wind turbine blades, may face higher natural gas and electricity prices, production in that sector may ultimately increase due to higher demand from the electricity sector for wind turbines.

5.5 Conclusions

Changes in the price of electricity, natural gas, and coal can affect markets for goods and services produced by sectors that use these energy inputs in the production process. The direction

and magnitude of these impacts are influenced by a number of factors. For example, the more able producers in these sectors are to substitute away from the use of these energy inputs, the smaller the effect of energy prices changes will be on their production cost. Changes in cost of production may lead to changes in price, quantity produced, and profitability of firms within secondary markets. Furthermore, the demand inputs in the electricity sector, as well as changes in the demand for energy efficiency services and products, will also affect secondary markets. If regulation results in changes in domestic markets that lead to an increase in imports, increases in production in countries with more energy-intensive production may lead to changes in CO₂ emissions elsewhere. The presence and adoption of policies affecting GHG emissions in other countries, which may be influenced by the adoption of this final rule, may affect the change in emissions elsewhere.

Modeling choices in IPM influence the forecast changes in electricity, natural gas, and coal prices in this RIA. Actual market conditions, as will the plan approaches that states adopt, will ultimately influence the price changes of these energy inputs and consequent effects on secondary markets.

5.6 References

- Hammitt, J.K. 2010. Review of the Final Integrated Report for the Second Section 812 Prospective Study of the Benefits and Costs of the Clean Air Act. Available at <[http://yosemite.epa.gov/sab/sabproduct.nsf/9288428b8e4c885257242006935a3/1E6218DE3BFF682E852577FB005D46F1/\\$File/EPA-COUNCIL-11-001-unsigned.pdf](http://yosemite.epa.gov/sab/sabproduct.nsf/9288428b8e4c885257242006935a3/1E6218DE3BFF682E852577FB005D46F1/$File/EPA-COUNCIL-11-001-unsigned.pdf)> Accessed June 4, 2015.
- U.S. Environmental Protection Agency (U.S. EPA). 2008. Final Ozone NAAQS Regulatory Impact Analysis. Office of Air Quality Planning and Standards, Research Triangle Park, NC. Available at <http://www.epa.gov/ttn/ecas/regdata/RIAs/452_R_08_003.pdf>. Accessed June 4, 2015.
- U.S. Environmental Protection Agency (U.S. EPA). 2010. Regulatory Impact Analysis for the Proposed Federal Transport Rule. Office of Air Quality Planning and Standards, Research Triangle Park, NC. Available at <http://www.epa.gov/ttnecas1/regdata/RIAs/proposaltrria_final.pdf>. Accessed June 4, 2015.

U.S. Environmental Protection Agency (U.S. EPA). 2011. The Benefits and Costs of the Clean Air Act from 1990 to 2020, Final Report – Rev A. Office of Air and Radiation, Washington, DC. Available at <http://www.epa.gov/cleanairactbenefits/feb11/fullreport_rev_a.pdf>. Accessed June 4, 2015.

CHAPTER 6: EMPLOYMENT IMPACT ANALYSIS

6.1 Introduction

Executive Order 13563 directs federal agencies to consider regulatory impacts on job creation and employment. According to the Executive Order, “our regulatory system must protect public health, welfare, safety, and our environment while promoting economic growth, innovation, competitiveness, and job creation. It must be based on the best available science” (Executive Order 13563, 2011). Although standard benefit-cost analyses have not typically included a separate analysis of regulation-induced employment impacts,¹²⁹ we typically conduct employment analyses for economically significant rules. While the economy continues moving toward full-employment, employment impacts are of particular concern and questions may arise about their existence and magnitude. This chapter discusses and projects potential employment impacts for the utility power, coal and natural gas production, and demand-side energy efficiency sectors which may result from the Final Carbon Pollution Emission Guidelines for Existing Stationary Sources: Electric Utility Generating Units (herein referred to as “final emission guidelines” or the “Clean Power Plan Final Rule”).¹³⁰

Section 6.2 describes the theoretical framework used to analyze regulation-induced employment impacts, discussing how economic theory alone cannot predict whether such impacts are positive or negative. Section 6.3 presents an overview of the peer-reviewed literature relevant to evaluating the effect of environmental regulation on employment. Section 6.4 provides background regarding recent employment trends in the electricity generation, coal and natural gas extraction, renewable energy, and demand-side energy efficiency-related sectors. Section 6.5 presents the EPA’s quantitative projections of potential employment impacts in these sectors. These projections are based in part on a detailed model of the electricity production sector used for this regulatory analysis. Additionally, this section discusses projected employment impacts due to demand-side energy efficiency activities. Section 6.6 offers several conclusions.

¹²⁹ Labor expenses do, however, contribute toward total costs in the EPA’s standard benefit-cost analyses.

¹³⁰ The employment analysis in this RIA is part of EPA’s ongoing effort to “conduct continuing evaluations of potential loss or shifts of employment which may result from the administration or enforcement of [the Act]” pursuant to CAA section 321(a).

6.2 Economic Theory and Employment

Regulatory employment impacts are difficult to disentangle from other economic changes affecting employment decisions over time and across regions and industries. Labor market responses to regulation are complex. They depend on labor demand and supply elasticities and possible labor market imperfections (e.g., wage stickiness, long-term unemployment, etc.). The unit of measurement (e.g., number of jobs, types of job hours worked, and earnings) may affect observability of that response. Net employment impacts are composed of a mix of potential declines and gains in different areas of the economy (e.g., the directly regulated sector, the environmental protection sector, upstream and downstream sectors, etc.) over time. In light of these difficulties, economic theory provides a constructive framework for analysis.

Microeconomic theory describes how firms adjust their use of inputs in response to changes in economic conditions.¹³¹ Labor is one of many inputs to production, along with capital, energy, and materials. In competitive markets, firms choose inputs and outputs to maximize profit as a function of market prices and technological constraints.^{132,133} Berman and Bui (2001) adapt this model to analyze how environmental regulations affect labor demand.¹³⁴ They model environmental regulation as effectively requiring certain factors of production, such as pollution abatement capital, at levels that firms would not otherwise choose. Berman and Bui (2001) model two components that drive changes in firm-level labor demand: output effects and substitution effects.¹³⁵ Regulation affects the profit-maximizing quantity of output by changing the marginal cost of production. If a regulation causes marginal cost to increase, it will place upward pressure on output prices, leading to a decrease in demand, and resulting in a decrease in production. The output effect describes how, holding labor intensity constant, a decrease in production causes a decrease in labor demand. As noted by Berman and Bui, although many

¹³¹ See Layard and Walters (1978), a standard microeconomic theory textbook, for a discussion, in Chapter 9.

¹³² See Hamermesh (1993), Ch. 2, for a derivation of the firm's labor demand function from cost-minimization.

¹³³ In this framework, labor demand is a function of quantity of output and prices (of both outputs and inputs).

¹³⁴ Morgenstern, Pizer, and Shih (2002) develop a similar model.

¹³⁵ The authors also discuss a third component, the impact of regulation on factor prices, but conclude that this effect is unlikely to be important for large competitive factor markets, such as labor and capital. Morgenstern, Pizer and Shih (2002) use a very similar model, but they break the employment effect into three parts: 1) a demand effect; 2) a cost effect; and 3) a factor-shift effect.

assume that regulations must increase marginal cost, it need not be the case. A regulation could induce a firm to upgrade to less polluting and more efficient equipment that lowers the marginal cost of production. In such a case, output could increase after firms comply with the regulation. For example, in the context of the current rule, improving the heat rate of utility boiler increases fuel efficiency, lowering marginal production costs, and thereby potentially increasing the utility boiler's generation. An unregulated profit-maximizing firm may not have chosen to install such an efficiency-improving technology if the return on investment were too low, but once the investment is required it lowers marginal production costs.

The substitution effect describes how, holding output constant, regulation affects the labor-intensity of production. Although increased environmental regulation may increase use of pollution control equipment and energy to operate that equipment, the impact on labor demand is ambiguous. For example, equipment inspection requirements, specialized waste handling, completing required paperwork, or pollution technologies that alter the production process may affect the number of workers necessary to produce a unit of output. Berman and Bui (2001) model the substitution effect as the effect of regulation on pollution control equipment and expenditures required by the regulation and the corresponding change in the labor-intensity of production.

In summary, as output and substitution effects may be positive or negative, economic theory alone cannot predict the direction of the net effect of regulation on labor demand at the level of the regulated firm. Operating within the bounds of standard economic theory, however, empirical estimation of net employment effects on regulated firms is possible when methods and data of sufficient detail and quality are available. The extant literature, however, illustrates difficulties with empirical estimation. For example, there is a paucity of publicly-available data on plant-level employment, thus most studies must rely on confidential plant-level employment data from the U.S. Census Bureau, typically combined with pollution abatement expenditure data, that are too dated to be reliably informative, or other measures of the stringency of regulation. In addition, the most commonly used empirical methods, for example, Greenstone (2002), likely overstate employment impacts because they rely on relative comparisons between more regulated and less regulated counties, which can lead to "double counting" of impacts

when production and employment shift from more regulated towards less regulated areas. Thus these empirical methods cannot be used to estimate net employment effects.¹³⁶

The conceptual framework described thus far focused on regulatory effects on plant-level decisions within a regulated industry. Employment impacts at an individual plant do not necessarily represent impacts for the sector as a whole. The theoretical approach must be modified when applied at the industry level.

At the industry-level, labor demand is more responsive if: (1) the price elasticity of demand for the product is high, (2) other factors of production can be easily substituted for labor, (3) the supply of other factors is highly elastic, or (4) labor costs are a large share of total production costs.¹³⁷ For example, if all firms in an industry are faced with the same regulatory compliance costs and product demand is inelastic, then industry output may not change much, and output of individual firms may change slightly.¹³⁸ In this case, the output effect may be small, while the substitution effect depends on input substitutability. Suppose, for example, that new equipment for heat rate improvements requires labor to install and operate. In this case, the substitution effect may be positive, and with a small output effect, the total effect may be positive. As with potential effects for an individual firm, theory cannot determine the sign or magnitude of industry-level regulatory effects on labor demand. Determining these signs and magnitudes requires additional sector-specific empirical study. For environmental rules, much of the data needed for these empirical studies is not publicly available, would require significant time and resources in order to access confidential U.S. Census data for research, and also would not be necessary for other components of a typical regulatory impact analysis (RIA).

In addition to changes to labor demand in the regulated industry, net employment impacts encompass changes in other related sectors. For example, the final guidelines may increase demand for heat rate improving equipment and services. This increased demand may increase revenue and employment in the firms supporting this technology. At the same time, the regulated

¹³⁶ See Greenstone (2002) p. 1212.

¹³⁷ See Ehrenberg & Smith, p. 108.

¹³⁸ This discussion draws from Berman and Bui (2001), pp. 293.

industry is purchasing the equipment, and these costs may impact labor demand at regulated firms. Therefore, it is important to consider the net effect of compliance actions on employment across multiple sectors or industries.

If the U.S. economy is at full employment, even a large-scale environmental regulation is unlikely to have a noticeable impact on aggregate net employment.¹³⁹ Instead, labor in affected sectors would primarily be reallocated from one productive use to another (e.g., from producing electricity or steel to producing high efficiency equipment), and net national employment effects from environmental regulation would be small and transitory (e.g., as workers move from one job to another).¹⁴⁰ Some workers may retrain or relocate in anticipation of new requirements or require time to search for new jobs, while shortages in some sectors or regions could bid up wages to attract workers. These adjustment costs can lead to local labor disruptions. Although the net change in the national workforce is expected to be small, localized reductions in employment may adversely impact individuals and communities just as localized increases may have positive impacts.

If, on the other hand, the economy is operating at less than full employment, economic theory does not clearly indicate the direction or magnitude of the net impact of environmental regulation on employment; it could cause either a short-run net increase or short-run net decrease (Schmalensee and Stavins, 2011). For example, the Congressional Budget Office considered EPA's Mercury Air Toxics Standards and regulations for industrial boilers and process heaters as potentially leading to short-run net increases in economic growth and employment, driven by capital investments for compliance with the regulations (Congressional Budget Office, 2011). An important research question is how to accommodate unemployment as a structural feature in economic models. This feature may be important in assessing large-scale regulatory impacts on employment (Smith, 2012).

¹³⁹ Full employment is a conceptual target for the economy where everyone who wants to work and is available to do so at prevailing wages is actively employed. The unemployment rate at full employment is not zero.

¹⁴⁰ Arrow *et al.* 1996; see discussion on bottom of p. 8. In practice, distributional impacts on individual workers can be important, as discussed in later paragraphs of this section.

Environmental regulation may also affect labor supply and productivity. In particular, pollution and other environmental risks may impact labor productivity or employees' ability to work.¹⁴¹ While the theoretical framework for analyzing labor supply effects is analogous to that for labor demand, it is more difficult to study empirically. There is a small emerging literature described in the next section that uses detailed labor and environmental data to assess these impacts.

To summarize, economic theory provides a framework for analyzing the impacts of environmental regulation on employment. The net employment effect incorporates expected employment changes (both positive and negative) in the regulated sector and other related sectors. Labor demand impacts for regulated firms, and also for the regulated industry, can be decomposed into output and substitution effects which may be either negative or positive. Estimation of net employment effects for regulated sectors is possible when data of sufficient detail and quality are available. Finally, economic theory suggests that labor supply effects are also possible. In the next section, we discuss the empirical literature.

6.3 Current State of Knowledge Based on the Peer-Reviewed Literature

The labor economics literature contains an extensive body of peer-reviewed empirical work analyzing various aspects of labor demand, relying on the theoretical framework discussed in the preceding section.¹⁴² This work focuses primarily on effects of employment policies such as labor taxes and minimum wages.¹⁴³ In contrast, the peer-reviewed empirical literature specifically estimating employment effects of environmental regulations is growing, but is more limited. In this section, we present an overview of the latter. As discussed in the preceding section on theory, determining the direction of employment effects in regulated industries is challenging because of the complexity of the output and substitution effects. Complying with a new or more stringent regulation may require additional inputs, including labor, and may alter the relative proportions of labor and capital used by regulated firms (and firms in other relevant industries) in their production processes.

¹⁴¹ E.g. Graff Zivin and Neidell (2012).

¹⁴² Again, see Hamermesh (1993) for a detailed treatment.

¹⁴³ See Ehrenberg & Smith (2000), Chapter 4: "Employment Effects: Empirical Estimates" for a concise overview.

Empirical studies, such as Berman and Bui (2001), suggest that net employment impacts due to regulation were not statistically different from zero in the regulated sector. Other research, such as Greenstone (2002), suggests that more highly regulated counties may generate fewer jobs than less regulated ones, but the methodology used likely overstates employment impacts because it relies on relative comparisons between more regulated and less regulated counties, which can lead to “double counting” of impacts when production and employment shift from more regulated towards less regulated areas.¹⁴⁴ Moreover, environmental regulations may affect sectors that support pollution reduction earlier than the regulated industry. Rules are usually announced well in advance of their effective dates and then typically provide a period of time for firms to invest in technologies and process changes to meet the new requirements. When a regulation is promulgated, the initial response of firms is often to order pollution control equipment and services to enable compliance when the regulation becomes effective. Estimates of short-term increases in demand for specialized labor within the environmental protection sector have been prepared for several EPA regulations in the past, including the Mercury and Air Toxics Standards (MATS).¹⁴⁵ Overall, the peer-reviewed literature does not contain evidence that environmental regulation has a large impact on net employment (either negative or positive) in the long run across the whole economy.

6.3.1 Regulated Sector

Several empirical studies, including Berman and Bui (2001) and Ferris, Shadbegian, and Wolverton (2014), suggest that regulation-induced net employment impacts may be zero or slightly positive, but small in the regulated sector. Gray et al (2014) find that pulp mills that had to comply with both the air and water regulations in EPA’s 1998 “Cluster Rule” experienced relatively small, and not always statistically significant, decreases in employment. Other research on regulated sectors suggests that employment growth may be lower in more regulated areas (Greenstone 2002, Walker 2011, 2013). However since these latter studies compare more regulated to less regulated counties this methodological approach likely overstates employment impacts to the extent that regulation causes plants to locate in one area of the country rather than

¹⁴⁴ See Greenstone (2002) p. 1212.

¹⁴⁵ U.S. EPA (2011b).

another, which would lead to “double counting” of the employment impacts. List *et al.* (2003) find some evidence that this type of geographic relocation may be occurring.

A small literature examines impacts of environmental regulations on manufacturing employment. Greenstone (2002) and Walker (2011, 2013) study the impact of air quality regulations on manufacturing employment, estimating the effects in non-attainment areas relative to attainment areas. Kahn and Mansur (2013) study environmental regulatory impacts on geographic distribution of manufacturing employment, controlling for electricity prices and labor regulation (right to work laws). Their methodology identifies employment impacts by focusing on neighboring counties with different air quality regulations. They find limited evidence that environmental regulations may cause employment to be lower within “county-border-pairs.” This result suggests that regulation may cause an effective relocation of labor across a county border, but since one county’s loss is another’s gain, such shifts cannot be transformed into an estimate of a national net effect on employment. Moreover this result is sensitive to model specification choices.

The few studies in peer-reviewed journals evaluating employment impacts of policies that reduce CO₂ emissions in the electric power generation sector are in the European context. In a sample of 419 German firms, 13 percent of which were in the electricity sector, Anger and Oberndorfer (2008) find that the initial allocation of emission permits did not significantly affect employment growth in the first year of the European Union (EU) Emissions Trading Scheme (ETS). Examining European firms from 1996-2007, Commins *et al.* (2011) find that a 1 percent increase in energy taxes is associated with a 0.01 percent decrease in employees in the electricity and gas sector. Chan *et al.* (2013) estimate the impact of the EU ETS on a panel of almost 6,000 firms in 10 European countries from 2005-2009. They find that firms in the power sector that participated in the ETS had 2-3 percent fewer employees relative to those that did not participate, but this effect is not statistically significant.

This literature suggests that the employment impacts of controlling CO₂ emissions in the European power sector were small. The degree to which these studies’ results apply to the U.S. context is unclear. European policies analyzed in these studies effectively put a price on emissions of both existing and new sources either through taxes or tradable permits with an emissions cap. An emission rate-based regulatory approach may not generate similar

employment effects. Moreover, European firms face relative fuel prices and market regulatory structures different from their U.S. counterparts, further complicating attempts to transfer quantitative results from the EU experience to evaluate this rule.

6.3.2 *Economy-Wide*

As noted above it is very difficult to estimate the net national employment impacts of environmental regulation. Given the difficulty with estimating national impacts of regulations, EPA has not generally estimated economy-wide employment impacts of its regulations in its benefit-cost analyses. However, in its continuing effort to advance the evaluation of costs, benefits, and economic impacts associated with environmental regulation, EPA has formed a panel of experts as part of EPA's Science Advisory Board (SAB) to advise EPA on the technical merits and challenges of using economy-wide economic models to evaluate the impacts of its regulations, including the impact on net national employment.¹⁴⁶ Once EPA receives guidance from this panel it will carefully consider this input and then decide if and how to proceed on economy-wide modeling of employment impacts of its regulations.

EPA received several comments regarding the potential net national employment impact of the proposed emission guidelines. Many of these comments referred to analyses that pre-dated the Clean Power Plan proposal, or focused on only one component of the proposal.¹⁴⁷ However, one comment was based on an "economy-wide assessment of the employment impacts associated with the U.S. Environmental Protection Agency's (EPA's) proposed Clean Power Plan" using the Long-term Inter-industry Forecasting Tool (LIFT) model.¹⁴⁸ The LIFT model, which is from the Interindustry Forecasting Project (Inforum) at the University of Maryland, has been used in the peer-reviewed academic literature¹⁴⁹ and has also been used to examine the

¹⁴⁶ For further information see:
<http://yosemite.epa.gov/sab/sabproduct.nsf/0/07E67CF77B54734285257BB0004F87ED?OpenDocument>

¹⁴⁷ See, for example, comments EPA-HQ-OAR-2013-0602-6743 and EPA-HQ-OAR-2013-0602-23140, within Docket ID: EPA-HQ-OAR-2013-0602.

¹⁴⁸ See comment EPA-HQ-OAR-2013-0602-22960, within Docket ID: EPA-HQ-OAR-2013-0602.

¹⁴⁹ See, for example, Almon (1991) and Mccarthy (1991).

economic impacts of other national policies [Meade (2009); Werling (2011)].¹⁵⁰ The commenter noted that “While EPA’s analysis provides a reasonable first approximation of the proposed rule’s employment effects, its focus on direct employment impacts does not capture various indirect employment impacts that may be of interest to policymakers and the public.” [...] “These include the employment impact associated with changes in electricity and other energy prices (both positive and negative, depending on the year), the productivity impacts associated with heat rate improvements at power plants, households and businesses re-directing expenditures to other uses because of increased demand-side energy efficiency, expenditures crowded out by energy efficiency expenditures, and changes in investments for air pollution control devices.”

As mentioned previously, EPA is currently engaged in an SAB process on economy-wide modeling. EPA will not make any determinations on whether modeling the economy-wide impacts of its regulations – including employment impacts - is feasible and, if so, how and when to do this until it receives guidance from the SAB panel. While the purpose of the SAB process is not to peer review any particular economy-wide model, it is worth noting that the use of models such as LIFT may be addressed by one of the charge questions to the SAB: “Are there other economy-wide modeling approaches that EPA could consider in conjunction with CGE models to evaluate the short run implications of an air regulation (e.g., macro-economic, disequilibrium, input/output models)? What are the advantages or disadvantages of these approaches?”¹⁵¹

¹⁵⁰ The commenter provides the following description of the LIFT model: “LIFT is a 97-sector dynamic representation of the U.S. national economy. The model combines an interindustry input / output (I-O) formulation with extensive use of regression analysis to employ a ‘bottom-up’ approach to macroeconomic modeling. That is, the model works like the actual economy, building macroeconomic totals from details of industry activity, rather than distributing predetermined macroeconomic quantities among industries. The commenter also describes LIFT also captures interactions between industries across the economy, enabling the model to gauge how changes in prices, investment, or productivity in one industry cascade across the economy. In the context of the Clean Power Plan, this is an important feature for understanding how the rule’s direct impacts for the electric power sector affect other industries.”

¹⁵¹ See p. 10, [http://yosemite.epa.gov/sab/sabproduct.nsf/0/07E67CF77B54734285257BB0004F87ED/\\$File/Charge+Questions+2-26-15.pdf](http://yosemite.epa.gov/sab/sabproduct.nsf/0/07E67CF77B54734285257BB0004F87ED/$File/Charge+Questions+2-26-15.pdf)

6.3.3 *Labor Supply Impacts*

The empirical literature on environmental regulatory employment impacts focuses primarily on labor demand. However, there is a nascent literature focusing on regulation-induced effects on labor supply.¹⁵² Although this literature is limited by empirical challenges, researchers have found that air quality improvements lead to reductions in lost work days (e.g., Ostro, 1987). Limited evidence suggests worker productivity may also improve when pollution is reduced. Graff Zivin and Neidell (2012) used detailed worker-level productivity data from 2009 and 2010, paired with local ozone air quality monitoring data for one large California farm growing multiple crops, with a piece-rate payment structure. Their quasi-experimental structure identifies an effect of daily variation in monitored ozone levels on productivity. They find “ozone levels well below federal air quality standards have a significant impact on productivity: a 10 parts per billion (ppb) decreases in ozone concentrations increases worker productivity by 5.5 percent.” (Graff Zivin and Neidell, 2012, p. 3654).¹⁵³

This section (section 6.3) has outlined the challenges associated with estimating regulatory effects on both labor demand and supply for specific sectors. These challenges make it difficult to estimate net national employment estimates that would appropriately capture the way in which costs, compliance spending, and environmental benefits propagate through the macro-economy.

6.4 Recent Employment Trends

The U.S. electricity system includes employees that support electric power generation, transmission and distribution; the extraction of fossil fuels; renewable energy generation; and supply-side and demand-side energy efficiency. This section describes recent employment trends in the electricity system.

¹⁵² For a recent review see Graff-Zivin and Neidell (2013).

¹⁵³ The EPA is not quantifying productivity impacts of reduced pollution in this rulemaking using this study. In light of this recent research, however, the EPA is considering how best to incorporate possible productivity effects in the future.

6.4.1 Electric Power Generation

In 2014, the electric power generation, transmission and distribution sector (NAICS 2211) employed about 390,000 workers in the U.S.¹⁵⁴ Installation, maintenance, and repair occupations accounted for the largest share of workers (25 percent).¹⁵⁵ These categories include inspection, testing, repairing and maintaining of electrical equipment and/or installation and repair of cables used in electrical power and distribution systems. Other major occupation categories include office and administrative support (18 percent), production occupations (16 percent), architecture and engineering (10 percent), business and financial operations (7 percent) and management (7 percent). As shown in Figure 6.1, employment in the Electric Power Industry averaged about 420,000 workers 2000 to 2005, declining to an average of about 400,000 workers for the rest of the decade, and then declining to about 390,000 workers in 2014.

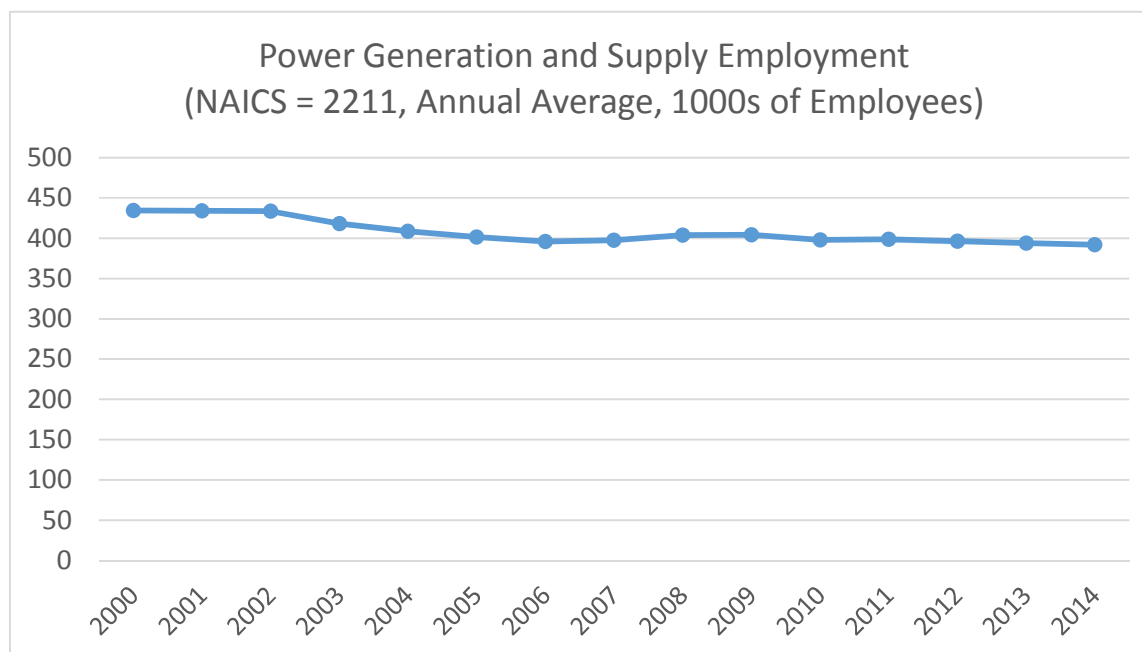

Figure 6.1. Electric Power Industry Employment

¹⁵⁴ U.S. Bureau of Labor Statistics. “Current Employment Survey Seasonally Adjusted Employment for Electric Power Generation, Transmission, and Distribution (national employment).” Series ID: CES4422110001. Available at <<http://www.bls.gov/data/>>. Accessed June 9, 2015.

¹⁵⁵ U.S. Bureau of Labor Statistics, Occupational Employment Statistics, May 2014 National Industry-Specific Occupational Employment and Wage Estimates, Electric Power Generation, Transmission, and Distribution (NAICS 2211). Available at: <http://www.bls.gov/oes/current/naics4_221100.htm>.

6.4.2 Fossil Fuel Extraction

6.4.2.1 Coal Mining

The coal mining sector (NAICS 2121) is primarily engaged in coal mining and coal mine site development, excluding metal ore mining and nonmetallic mineral mining and quarrying. In 2014, BLS reported about 74,000 coal mining employees (Figure 6.2). During the 2000 to 2014, period, coal mining employment peaked in 2011 at about 87,000 employees.

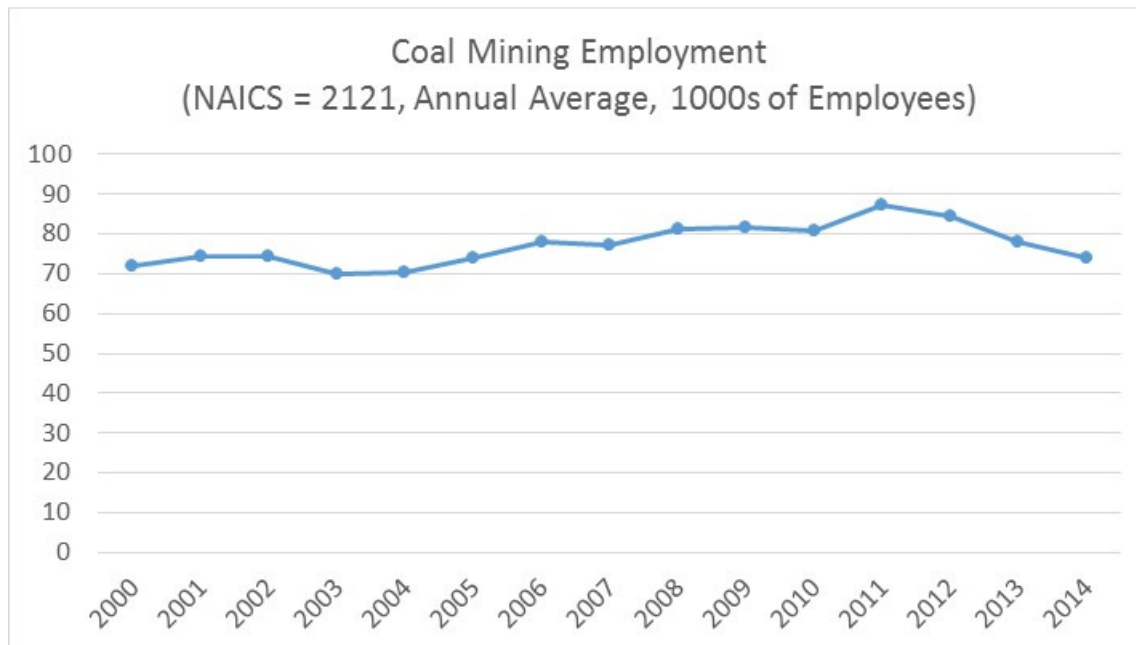

Figure 6.2. Coal Production Employment

6.4.2.2 Oil and Gas Extraction

In 2014, there were close to 200,000 employees in the oil and gas extraction sector (NAICS 211).¹⁵⁶ This sector includes production of crude petroleum, oil from oil shale and oil sands, production of natural gas, sulfur recovery from natural gas, and recovery of hydrocarbon liquids. Activities include the development of gas and oil fields, exploration activities for crude petroleum and natural gas, drilling, completing, and equipping wells, and other production

¹⁵⁶ BLS, Current Employment Statistics. Seasonally adjusted employment for oil and gas extraction (national employment), NAICS 211. Series ID: CES1021100001. Available at <<http://www.bls.gov/data/>>. Accessed June 9, 2015.

activities.¹⁵⁷ In contrast with coal, and looking at Figure 6.3, there has been a sharp increase in employment in this sector over the past decade.

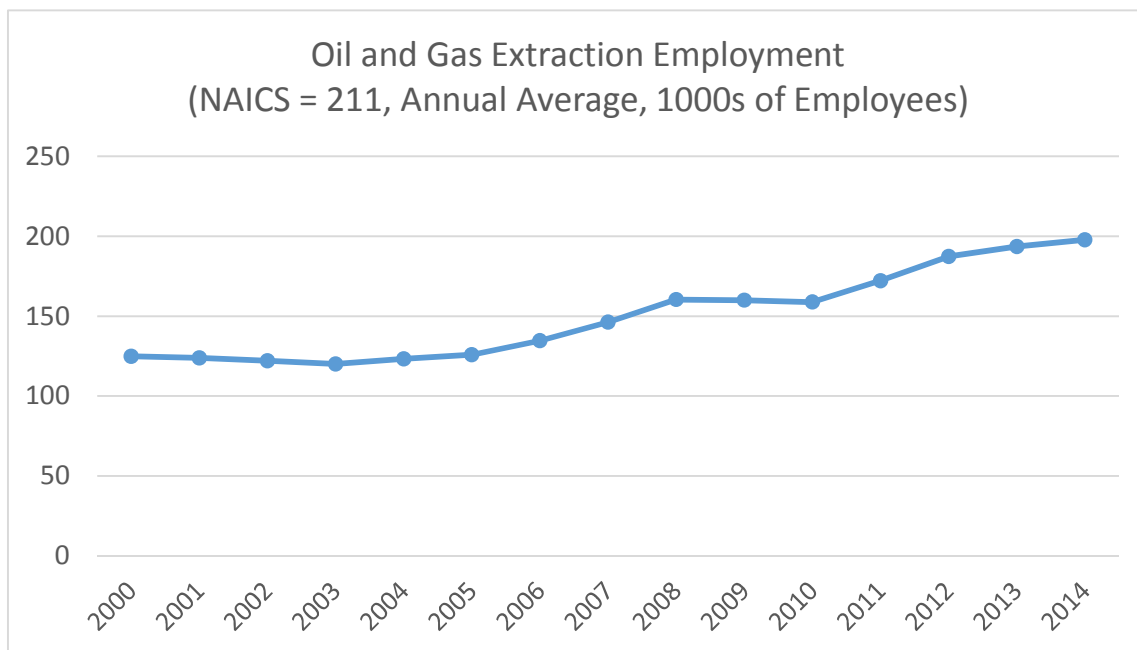

Figure 6.3. Oil and Gas Production Employment

6.4.3 Clean Energy Employment Trends

Clean energy resources, such as energy efficiency and renewable energy, are used to meet energy demand, reduce peak electricity system loads, and reduce reliance on the most carbon-intensive sources of electricity. However, there is not a single clean energy sector in standard national accounts classifications. Renewable generation is not reported to the BLS separately from other electric power generation. Similarly, manufacturers of energy efficient appliances are not reported separately from conventional appliance manufacturers and green building design is not separate from the construction sector. Instead, clean energy technology and services are supported by industries throughout the economy.

Without a specific industrial classification, it is difficult to quantify the exact number of clean energy-related jobs or document the trends. Employees engaged in clean energy can span many job classifications, such as experts required to design and produce a renewable or energy-

¹⁵⁷ U.S. Bureau of Labor Statistics. 2014. Available at: <<http://www.bls.gov/iag/tgs/iag211.htm> Accessed Feb. 19>.

efficient technology, workers that supply inputs and technicians who install service or operate equipment. As such, there are a variety of definitions of clean or green jobs used, some more expansive than others.

6.4.3.1 Defining Clean Energy Jobs

Two U.S. Government sources, the 2010 Department of Commerce (DOC) report, *Measuring the Green Economy* and the 2010 and 2011 BLS *Green Goods and Services* surveys have subdivided industrial classifications into “green” categories. In both cases the approach was to determine which product classifications, rather than industries, were green. They multiplied green production by product revenue and defined an industrial sector as green if it met a threshold of green revenue as a proportion of total revenue.

DOC broadly defined green jobs in 2010 as those “created and supported in businesses that produce green products and services.”¹⁵⁸ They further classified green jobs into a broad and a narrow category. The narrow category includes only products deemed to be green without disagreement, while the broad category is more inclusive definition of green goods and services to over 22,000 product codes in the 2007 Economic Census to estimate their contribution to the U.S. economy. The report found that the number of green jobs in 2007 ranged from 1.8 million to 2.4 million jobs, accounting for between 1.5 and 2 percent of total private sector employment.¹⁵⁹

BLS used an expansive definition of clean or green jobs in 2010 and 2011. It goes beyond direct clean energy-related investments and includes “those in businesses that produce goods and provide services that benefit the environment or conserve natural resources. These goods and services, which are sold to customers, include research and development, installation, and maintenance services for renewable energy and energy efficiency and education and training related to green technologies and practices” but also include recycling and natural resource

¹⁵⁸ U.S. Department of Commerce Economics and Statistics Administration. 2010. “Measuring the Green Economy,” April. Available at: <http://www.esa.doc.gov/sites/default/files/reports/documents/greeneconomyreport_0.pdf>.

¹⁵⁹ U.S. Department of Commerce Economics and Statistics Administration. 2010. “Measuring the Green Economy,” April. Available at: <http://www.esa.doc.gov/sites/default/files/reports/documents/greeneconomyreport_0.pdf>.

conservation, such as forestry management.¹⁶⁰ Based on surveys across the 325 industries it identified as potential producers of green goods and services, BLS counts approximately 2.3 million jobs in the green economy in 2010, rising 7.4 percent to 2.5 million in 2011,¹⁶¹ compared to increases of about one percent across all occupations in the entire economy over the same period.¹⁶² The table below, Table 6-1, presents BLS green job estimates nationally and for the utility sector.

Table 6-1. U. S. Green Goods and Services (GGS) Employment (annual average)

	Total GGS Employment	Utility GGS Employment	Total GGS Growth 2010-11	Utility GGS Growth 2010-11
2010	2,342,562	69,031	NA	NA
2011	2,515,200	71,129	7.4%	3.0%

Source: Bureau of Labor Statistics

6.4.3.2 Renewable Electricity Generation Employment Trends

The DOC report does not separate renewable energy data and the BLS data include only privately owned electricity generating facilities. As such, neither source isolates renewable electricity generation employment. For historical trends in this sector, we therefore, rely on a Brookings Institution study, Muro *et al.* (2011). This study built a national database of “clean economy” jobs from the bottom up, verifying each company individually.¹⁶³ They include a list of categories similar but not identical to that of BLS, including agricultural and natural resources conservation, education and compliance, energy and resource efficiency, greenhouse gas reduction, environmental management and recycling, and renewable energy. This study found about 138,000 jobs in the renewable energy sector in 2010, with an overall average annual growth rate of 3.1 percent from 2003-2010. Table 6-2 details the national results by energy source.

¹⁶⁰ BLS has identified 325 detailed industries (6-digit NAICS) as potential producers of green goods and services. Available at: <<http://www.bls.gov/ggs/ggsoverview.htm>>. (Accessed on 1-14-14, **last modified date:** March 19, 2013.

¹⁶¹ U.S. Department of Labor, U.S. Bureau of Labor Statistics. (n.d.). 2011. “Green Goods and Services 2010-2011.” (Retrieved on January 14, 2014). Available at :< <http://www.bls.gov/ggs/ggsoverview.htm>>.

¹⁶²U.S. Department of Labor, U.S. Bureau of Labor Statistics. 2010. National Occupational Employment and Wage Estimates, United States. Available at: <http://www.bls.gov/oes/2010/may/oes_nat.htm>, May. National Occupational Employment and Wage Estimates, United States http://www.bls.gov/oes/2010/may/oes_nat.htm.

¹⁶³ <http://www.brookings.edu/~media/Series/resources/0713_clean_economy.pdf> p. 15.

Table 6-2. Renewable Electricity Generation-Related Employment

Sector	Jobs, 2010	2003-2010 Average Annual Growth Rate (%)
Biofuels/Biomass	20,680	8.9
Geothermal	2,720	6.7
Hydropower	55,467	-3.6
Renewable Energy Services	1,981	6.3
Solar Photovoltaic	24,152	10.7
Solar Thermal	5,379	18.4
Waste-to-Energy	3,320	3.7
Wave/Ocean Power	371	20.9
Wind	24,294	14.9
Total	138,364	3.1

Source: http://www.brookings.edu/~media/Series/resources/0713_clean_economy.pdf, Appendix A.

More recent industry data, from 2014, indicate higher employment numbers and growth in the solar sector.¹⁶⁴

6.4.3.3 *Employment Trends in Demand-Side Energy Efficiency Activities*

U.S. government data used for calculating the historical trends in the demand-side energy efficiency sector come from the BLS green goods and services surveys. BLS reports an energy efficiency category, finding 1.49 million private sector energy efficiency jobs in 2010 and 1.64 million in 2011.

In addition to the “clean energy” jobs, Muro *et al* (2011) found about 428,000 jobs in the Energy and Resource Efficiency sector in 2010, with an overall average annual growth rate of 2.6 percent from 2003-2010.¹⁶⁵ Table 6-3 details the results by energy sector.

¹⁶⁴ The Solar Foundation, National Solar Jobs Census 2014. < <http://www.thesolarfoundation.org/national-solar-jobs-census-2014/>>

¹⁶⁵ <http://www.brookings.edu/~media/Series/resources/0713_clean_economy.pdf> p. 15.

Table 6-3. Energy and Resources Efficiency-Related Employment

Sector	Jobs, 2010	2003-2010 Average Annual Growth Rate (%)
Appliances	36,608	-3.1
Energy-saving Building Materials	161,896	2.5
Energy-saving Consumer Products	19,210	-2.9
Green Architecture and Construction Services	56,190	6.4
HVAC and Building Control Systems	73,600	3.3
Lighting	14,298	-1.8
Professional Energy Services	49,863	6.9
Smart Grid	15,987	8.6
Total	427,652	2.6

Source: http://www.brookings.edu/~media/Series/resources/0713_clean_economy.pdf, Appendix A

In addition, other research institutes and industry groups have clean economy or clean energy employment databases. While definitions and timeframes vary, all show positive employment trends of 1.9 percent or more growth in clean energy-related jobs annually.

6.5 Projected Sectoral Employment Changes due to the Final Emission Guidelines

Affected EGUs may respond to these final CO₂ emission performance rates by placing new orders for efficiency-related or renewable energy equipment and services to reduce GHG emissions. Implementing the CPP Final Rule will involve changes in the amount of labor needed in different parts of the utility power sector. Installing and operating new equipment or improving heat rate efficiency could increase labor demand in the electricity generating sector itself, as well as associated equipment and services sectors. Specifically, the direct employment effects of supply-side initiatives include increases in labor demand during the implementation phase for manufacturing, installing, and operating higher efficiency and renewable energy electricity generating assets, as well as making heat rate improvements at existing fossil units. Additional supply-side direct employment impacts are the reductions in labor demand for labor that would have been used by less efficient or higher emitting generating assets. Once implemented, increases in operating efficiency and shifting generation to existing or new NGCC units and renewable energy generation will impact the utility power sector's demand for fossil fuels and plans for EGU retirement and new construction.

In addition, EPA expects state plans may also include demand-side energy efficiency policies and programs that typically change energy consumption patterns of business and residential consumers by reducing the quantity of energy required for a given level of production or service. Demand-side initiatives generally aim to increase the use of cost-effective energy

efficiency technologies (e.g., including more efficient appliances and air conditioning systems, more efficient lighting devices, more efficient design of homes and businesses), and advance efficiency improvements in motor systems and other industrial processes. Demand-side initiatives can also directly reduce energy consumption, such as through programs encouraging changing the thermostat during the hours a building is unoccupied or motion-detecting room light switches. Such demand-side energy efficiency initiatives directly affect employment by encouraging firms and consumers to shift to more efficient products and processes than would otherwise be the case. Employment in the sectors that provide these more efficient devices and services would be expected to increase, while employment in the sectors that produce less efficient devices would be expected to contract.

This generation-side employment analysis uses the cost projections from the engineering-based Integrated Planning Model (IPM) to project labor demand impacts of the final emission guidelines on affected EGUs in the electricity power sector and the fuel production sector (coal and natural gas). These projections include effects attributable to heat rate improvements, construction of new EGUs, generation shifts, changes in fuel use, and reductions in electricity generation due to demand-side energy efficiency activities. To project labor requirements for demand-side energy efficiency activities, the analysis uses a different approach that combines data on historic changes in employment and expenditures in the energy efficiency sector with projected changes in expenditures in the sector arising from state implementation of the emission guidelines. We project labor impacts for the rate-based and mass-based illustrative plan approach.

6.5.1 Projected Changes in Employment in Electricity Generation and Fossil Fuel Extraction

The analytical approach used in this analysis is a bottom-up engineering method combining EPA's cost analysis of the emission guidelines with data on labor productivity, engineering estimates of the amount and types of labor needed to manufacture, construct, and operate different types of generating units, and prevailing wage rates for skilled and general labor categories. This approach is different from the economy-wide types of economic analyses discussed in section 6.2. Lacking robust peer-reviewed methods to estimate economy-wide impacts, the engineering-based analysis focuses on the supply-side direct impact on labor demand in industries closely involved with electricity generation. The engineering approach

projects labor changes measured as the change in each analysis year in job-years¹⁶⁶ employed in the utility power sector and directly related sectors (e.g., equipment manufacturing, fuel supply, EGU construction and generating efficiency services). For example, this approach projects the amounts and types of labor required to implement improvements in generating efficiency. The generation efficiency improvements reduce the amount of fossil fuel needed. The efficiency-driven change in fuel use is included in the estimates of the CPP's impact on the overall changes in labor required to extract fossil fuels. Some of the quantified employment impacts in this analysis are one-time impacts, such as changes associated with building new NGCC or renewable generating units. Other labor impacts will continue, such as changes associated with operating and maintaining generating units that will be retired, and labor providing the fuel supplied to newly built, retired and improved EGUs.

This analysis relies on projections and the cost analysis from IPM, which uses industry-specific data and assumptions to estimate costs and energy impacts of the final guidelines (see Chapter 3). The EPA uses IPM to predict coal generating capacity that is likely to undertake improvements in heat rate efficiency (HRI).¹⁶⁷ IPM also predicts the guidelines' impacts on fuel use, retirement of existing units, and construction of new ones.

The methods EPA uses to estimate the labor impacts are based on the analytical methods used in many previous EPA regulatory analyses. The most relevant prior analysis was the Regulatory Impact Analysis for the Mercury and Air Toxics Standards (MATS). While the methods used in this analysis to estimate the recurring labor impacts (e.g., labor associated with operating and maintaining generating units, as well as labor needed to mine coal and natural gas) are the same as we used in MATS (with updated data where available), the methods used to estimate the labor associated with installing new capacity and implementing heat rate improvements were developed for the purpose of the Clean Power Plan RIA.

¹⁶⁶ Job-years are not individual jobs, but rather the amount of work performed by the equivalent of one full-time individual for one year. For example, 20 job-years in 2020 may represent 20 full-time jobs or 40 half-time jobs in that year.

¹⁶⁷ HRI could include a range of activities in the power plant to lower the heat rate required to generate a net electrical output. Assuming all other things being equal, a lower heat rate is more efficient because more electricity is generated from each ton of coal.

The bottom-up engineering-based labor analysis in the MATS RIA primarily was concerned with the labor needs of retrofitting pollution control equipment. A central feature of the supply-side labor analysis for this RIA, however, involves the quantity and timing of the labor needs of building new renewable and NGCC units and retiring coal units. The estimated response of the utility power sector involves changes in the amount and timing of retirements of existing coal and oil/gas units, as well as changes in the amount and timing of building new NGCC units and renewable generating capacity. In addition to the changes in retirements and construction of new units, there are also estimated changes in the utilization of existing generating units, and changes in the gas and coal supply sectors.

For example, as presented in Chapter 3, the IPM analysis of the rate-based illustrative plan approach scenario finds that in 2025 (part way through the 2022-2029 interim plan performance period) less total generating capacity is needed than in the base case. The estimated reduction in capacity by 2025 with the rate-based scenario is 49.4 GW less than the estimated base case capacity (a 4.8 percent net capacity reduction). This 49.4 GW net reduction includes more retirements of coal units (an additional 22.9 GW of coal-fired capacity retired) and oil/gas steam units (an additional 9.3 GW of oil/gas retirement) compared to the base case, as well as a reduction in the amount of new natural gas units needed to be built by 2025 (a decrease of 10.9 GW in new capacity from the amount forecast in the base case) and non-hydro renewables (1.7 GW less renewable capacity built). Fossil fuel utilization will also be impacted. The rate-based scenario finds that in 2025 less coal will be used (102.9 million tons less, a 14.1 percent decrease from the base case) and less gas will also be used (0.1 TCF less, a 1.0 percent decrease).

An important aspect of the labor analysis is that building new units, and all the associated construction-related labor, occurs before the new units become operational. While the financial costs of building the new units are amortized and recouped over the book life of the new equipment, the labor involved with manufacturing equipment and constructing the new units occurs, and is actually paid for, in a concentrated amount of time before the new capacity begins to generate electricity. IPM assumes¹⁶⁸ that new NGCC units take 3 years to build, and both natural gas combustion turbines and wind-powered renewables take 2 years.

¹⁶⁸ Table 4.13, IPM 5.13 Documentation.

Avoiding some of the need for new capacity due to both demand and supply efficiency improvements results in both a significant cost savings to consumers and the power sector, as well as reduced emissions of both CO₂ and non-CO₂ pollutants from fossil fuel-fired generation. The avoided new capacity, however, also has significant labor impacts. A portion of the labor that would have been used to build the new capacity in the base case will not be employed in the power generation sector with the implementation of the GHG guidelines, though it likely will be employed in construction elsewhere. Similarly, less labor involved with operating and providing fuel for new units will be needed with the emissions guidelines than in the base case.

A critical component of the overall labor impacts of implementing the GHG guidelines is the impact of the labor associated with the demand-side energy efficiency activities. The demand-side labor impacts are presented in section 6.5.2. The demand-side energy efficiency activities are increases in labor needs and estimated in units of jobs, while the supply-side employment impacts are estimated as job-years. The IPM labor expenditure projections are distributed across different labor categories (e.g., general construction labor, boilermakers and engineering) using data from engineering analyses of labor's overall share of total expenditures, and apportionment of total labor cost to various labor categories. Hourly labor expenditures (including wages, fringe benefits, and employer-paid costs including taxes, insurance and administrative costs) for each category are used to estimate the labor quantity (measured in full-time job-years) consistent with the compliance scenario projections. Projected labor impacts arising from changes in fuel demand are primarily derived from labor productivity data for coal mining (tons mined per employee hour) and natural gas extraction (MMBtu produced/job-year). Tables 6.4 and 6.5 present projected changes relative to the baseline of four labor categories:

1. manufacturing, engineering and construction for building, designing and implementing heat rate improvements;
2. manufacturing and construction for new generating capacity;
3. operating and maintenance for existing generating capacity; and
4. extraction of coal and natural gas fuel.

All of the employment estimates presented in Tables 6-4 and 6-5 are estimates occurring in a single year. For the construction-related (one-time) labor impacts, including the installation of HRI, Tables 6-4 and 6-5 present the average annual impact occurring in each year of three

different intervals. The three intervals are from 2018 through 2020 (a three year interval), during which there are modest labor impacts from the early changes in the power utility sectors operations, from 2021 through 2025 (five years), and 2026 through 2030 (5 years). The construction-related labor analysis are based on the IPM estimates of the net change in capital investment that occurs during each multi-year interval to fund building new units completed during that interval. The new build labor analysis uses the net change in capital investment to estimate the amount and type of labor needed during the interval to build the new capacity. The analysis assumes that the new build labor within each interval is evenly distributed throughout the interval. Tables 6-4 and 6-5 reflect this assumption by presenting the average labor utilization per year during each of the three intervals.

The HRI-related labor impacts are estimated based on the assumed capital cost of \$100/kw (see section 3.9.3). The labor estimates for operating and maintaining generating units annually are based on IPMs estimates of Fixed Operating and Maintenance (FOM) and Variable Operating and Maintenance (VOM) costs. IPM estimates FOM and VOM for each year individually, so the net changes in O&M-related labor estimates in Tables 6-4 and 6-5 are single year estimates for 2020, 2025 and 2030. These single year O&M labor estimates are not merely the average annual averages labor needs throughout each multi-year interval. There are O&M labor changes occurring in the all years throughout the entire period 2020-2030, but the labor impacts in each labor category change each year. The fuel-related labor estimates are also single-year estimates, and not multi-year averages. The labor analysis of the impacts on the fuel extraction industries uses IPM's estimates of the net changes in the amount of coal and natural gas in 2020, 2025 and 2030, which are inherently estimates of the fuel usage in a single year. As with the O&M labor impacts, the fuels-related labor impacts occur in every year throughout 2020-2030, and the labor impact changes every year.

It should be noted that the supply-side labor impact estimates in Tables 6-4 and 6-5 reflect the supply-side changes that will potentially occur with each illustrative plan scenario. These labor impacts include not only the direct supply-side impacts of the illustrative implementation scenarios of the CPP, but also the changes in total generation activity that result from the demand-side energy efficiency activities expected to be an important component of state compliance strategies. The additional labor impact estimates from demand-side energy efficiency activities are presented below in section 6.5.2.

More details on methodology, assumptions, and data sources used to estimate the supply-side labor impacts discussed in this section can be found in Appendix 6A.

**Table 6-4. Engineering-Based^a Changes in Labor Utilization, Rate-based Scenario
(Number of Job-Years^b of Employment in a Single Year)**

	Construction-related (One-time) Changes*		
	2018-2020	2021-2025	2026-2030
Heat Rate Improvement: Total	0	15,400	2,200
Boilermakers and General Construction	0	11,000	1,600
Engineering and Management	0	2,800	400
Equipment-related	0	1,200	200
Material-related	0	400	0
New Capacity Construction: Total	500	-15,600	400
Renewables	700	-5,000	23,300
Natural Gas	-200	-10,600	-22,900
	Recurring Changes**		
	2020	2025	2030
Operation and Maintenance: Total	-9,100	-17,000	-19,600
Changes in Renewables	600	-100	1,100
Changes in Gas***	300	-1,100	-3,700
Changes in Coal***	-8,000	-13,300	-14,700
Retired Oil and Gas	-2,000	-2,500	-2,300
Fuel Extraction: Total	100	-7,800	-13,900
Coal	-1,300	-7,300	-13,300
Natural Gas	1,400	-500	-600
Supply-Side Employment Impacts - Quantified	-8,500	-25,000	-30,900

^a Job-year estimates are derived from IPM investment and O&M cost estimates, as well as IPM fuel use estimates (tons coals or MMBtu gas).

^b All job-year estimates on this are full-time equivalent (FTE) jobs. Job estimates in the demand-side energy efficiency section (below) include both full-time and part-time jobs.

*Construction-related job-year changes are one-time impacts, occurring during each year of the multi-year period during which construction and HRI installation activities occur. Construction-related figures in table are the average annual job-years in each year between the years in the range. Negative construction job-year estimates occur when additional generating capacity must be built in the base case, but is avoided in the final rule.

**Recurring Changes are job-years associated with annual recurring jobs including operating and maintenance activities and fuel extraction jobs. Newly built generating capacity creates a recurring stream of positive job-years, while retiring generating capacity, as well as avoided new built capacity, create a stream of negative job-years.

***O&M job-year changes include changes from new, retired and avoided capacity, and also changes arising from changes in utilization (i.e., capacity factor changes) of existing EGU capacity that continue to operate but generate a different amount of MWh/year.

Table 6-5. Engineering-Based^a Changes in Labor Utilization, Mass-Based Illustrative Plan Approach (Number of Job-Years of Employment in a Single Year)

	Construction-related (One-time) Changes*		
	2018-2020	2021-2025	2026-2030
Heat Rate Improvement: Total	0	14,900	800
Boilermakers and General Construction	0	10,700	600
Engineering and Management	0	2,700	100
Equipment-related	0	1,200	100
Material-related	0	300	0
New Capacity Construction: Total	-1,700	-11,100	4,700
Renewables	-1,400	-3,500	21,300
Natural Gas	-300	-7,600	-16,600
	Recurring Changes**		
	2020	2025	2030
Operation and Maintenance: Total	-11,700	-21,200	-25,000
Changes in Renewables	-900	-1,000	700
Changes in Gas***	500	-400	-2,300
Changes in Coal***	-9,100	-17,000	-20,800
Retired Oil and Gas	-2,200	-2,800	-2,600
Fuel Extraction: Total	200	-8,600	-14,300
Coal	-1,800	-8,700	-12,200
Natural Gas	2,000	100	-2,100
Supply-Side Employment Impacts - Quantified	-13,100	-26,000	-33,700

^a Job-year estimates are derived from IPM investment and O&M cost estimates, as well as IPM fuel use estimates (tons coals or MMBtu gas).

^b All job-year estimates on this are full-time equivalent (FTE) jobs. Job estimates in the demand-side energy efficiency section (below) include both full-time and part-time jobs.

*Construction-related job-year changes are one-time impacts, occurring during each year of the multi-year period during which construction and HRI installation activities occur. Construction-related figures in table are the average annual job-years in each year between the years in the range. Negative construction job-year estimates occur when additional generating capacity must be built in the base case, but is avoided in the final rule.

**Recurring Changes are job-years associated with annual recurring jobs including operating and maintenance activities and fuel extraction jobs. Newly built generating capacity creates a recurring stream of positive job-years, while retiring generating capacity, as well as avoided new built capacity, create a stream of negative job-years.

***O&M job-year changes include changes from new, retired and avoided capacity, and also changes arising from changes in utilization (i.e., capacity factor changes) of existing EGU capacity that continue to operate but generate a different amount of MWh/year.

6.5.2 Projected Changes in Employment in Demand-Side Energy Efficiency Activities

As described in Chapter 3, EPA anticipates that this rule may stimulate investment in clean energy technologies and services, resulting in considerable increases in energy efficiency.

Many of these investments may support demand-side energy efficiency activities such as: reducing energy required for a given activity by encouraging more efficient technologies (e.g., ENERGY STAR appliances), implementing energy improvements for existing systems (e.g., weatherization of older homes), or encouraging changes in behavior (e.g., reducing air conditioning during periods of high electricity demand). We expect these increases in energy efficiency, specifically, to support a significant number of jobs in related industries. For more information on EPA’s illustrative investment levels in demand-side energy efficiency activities, assumed to be adopted in response to the CPP, please see Section 3.7 “Demand-Side Energy Efficiency” in Chapter 3 of this RIA.

In this section, we project employment impacts in demand-side energy efficiency activities arising from these guidelines using illustrative calculations. The approach uses information from power sector modeling and projected impacts on energy efficiency investments analyzed (see Chapter 3), and U.S. government data on employment and expenditures in energy efficiency.¹⁶⁹ This approach is limited by the fact that we do not know which options states will choose for demand-side energy efficiency activities and by uncertainties associated with methods. These illustrative employment projections are gross; thus they do not include impacts in other sectors of any shift in resources from other sectors to implement the demand-side energy efficiency activities. Nor does this analysis attempt to quantify the positive employment impacts in other sectors arising from changes in consumer expenditures on electricity due to reduced electricity bills. In other words, these projections are not attempts at estimating net national job creation. Also, this approach attempts to calculate the number of employees (full-time and part-time) rather than full-time supply-side job-years estimated in section 6.5.1.

Employment impacts of demand-side energy efficiency programs have not been extensively studied in the peer-reviewed, published economics literature. Instead, most research has focused on consumer response to and amount of energy savings achieved by these programs (e.g., Allcott (2011a, 2011b), Arimura *et al.* (2012)). Results suggest that demand-side energy

¹⁶⁹ Investments in demand-side energy efficiency reduce energy required for a given activity by encouraging more efficient technologies (e.g., ENERGY STAR appliances), implementing energy improvements for existing systems (e.g., weatherization of older homes), or encouraging changes in behavior (e.g., reducing air conditioning during periods of high electricity demand).

efficiency programs reduce energy use and generate small increases in consumer welfare. These policy impacts are due to low investment in energy efficiency as described in “energy paradox” literature (Gillingham, Newell, and Palmer (2009), Gillingham and Palmer (2014)).¹⁷⁰

Two recent articles discuss employment effects of demand-side energy efficiency programs. Aldy (2013) describes clean energy investments funded by the American Recovery and Reinvestment Act of 2009, which “included more than \$90 billion for strategic clean energy investments intended to promote job creation and the deployment of low-carbon technologies” (p. 137), with nearly \$20 billion for energy efficiency investments. The Council of Economic Advisors (CEA) (2011) estimated higher economic activity and employment than would have otherwise occurred without the American Recovery and Reinvestment Act. Using CEA’s methods to quantify job creation for the Recovery Act, Aldy uses the share of stimulus funds for clean energy investments to estimate job-years supported by the Recovery Act. The largest sources of job creation in clean energy are those that received the largest shares of stimulus funds: renewable energy, energy efficiency, and transit. Aldy’s estimates, while informative, are not directly applicable for employment analysis in this rulemaking as there are important differences in expected employment impacts from a historically large fiscal stimulus specifically targeting job creation during a period of exceptionally high unemployment versus environmental regulations taking effect several years from now.

Yi (2013) analyzes clean energy policies and employment for U.S. metropolitan areas in 2006, prior to the Recovery Act, to evaluate impacts on clean energy job growth. Implementing an additional state clean energy policy tool (renewable energy policies, GHG emissions policies, and energy efficiency policies such as energy efficiency resource standards, appliance or equipment energy efficiency standards, tax incentives, and public building energy efficiency standards) is associated with 1 percent more clean energy employment within that MSA. These estimates are not transferable to this rulemaking since states are likely to change intensity as well as number of clean energy programs.

¹⁷⁰ For more information on this efficiency paradox see Chapter 3 and the Technical Support Document (TSD) for the Final Carbon Pollution Emission Guidelines for Existing Stationary Sources: Electric Utility Generating Units. Demand-Side Energy Efficiency

Lacking a peer-reviewed methodology, we use the following approach to illustrate possible effects on labor demand in the energy efficiency sector due to demand-side management strategies. We use U.S. government data and divide energy efficiency employment by expenditures on energy efficiency activities to calculate an estimate of jobs per million dollars. We then multiply this fraction by projected expenditure in energy efficiency activities undertaken in response to these final guidelines.

Data used for calculating employment in energy efficiency sectors comes from the “energy efficiency” industry category of the BLS *Green Goods and Services* survey.¹⁷¹ Using BLS Green Goods and Services (GGS) information on 132 energy efficiency industries, as identified by BLS,¹⁷² we adjusted the list to remove ten industries expected to not be directly affected by the rule, e.g. transportation.¹⁷³ Next we used this detailed list of 122 industries to extract 2011 BLS data on green employment.¹⁷⁴ Employment data at the most-detailed industry level (6-digit NAICS) is available only for a portion of these 122 industries. Therefore we use both the most-detailed industry level (6-digit NAICS) and also a more aggregate level (4-digit NAICS) to estimate a range of energy efficiency employment with the 2011 BLS Green Goods and Services data.¹⁷⁵

¹⁷¹For more details on this survey, see section 6.5.3.1.

¹⁷² See detailed listing available here: http://www.bls.gov/ggs/naics_2012.xlsx. Category 2 is “Energy Efficiency”. More information is available here: <http://www.bls.gov/ggs/ggsfaq.htm#3>.

¹⁷³ The ten industries we removed from the list were: NAICS 483114 Coastal and Great Lakes passenger transport, 483212 Inland water passenger transportation, 485111 Mixed mode transit systems, 485112 Commuter rail systems, 485113 Bus and other motor vehicle transit systems, 485119 Other urban transit systems, 485210 Interurban and rural bus transportation, 485410 School and employee bus transportation, 485999 All other ground passenger transportation, and 926120 Transportation program administration. It is possible that certain energy efficiency services and products produced by the remaining sectors may also be applied in activities that may not be creditable for compliance with rate-based plans in, or may otherwise be directly incentivized by, this final rule. However, there is no reason to categorically exclude the remaining sectors from this analysis.

¹⁷⁴ BLS Green Goods and Services data is available here: <http://download.bls.gov/pub/time.series/gg/gg.data.1.AllData>. A BLS technical note indicates that the scope of the GGS survey changed between 2010 and 2011 (<http://www.bls.gov/news.release/ggqcew.tn.htm>). Some industries and establishments that were not previously included in the 2010 survey were included in 2011. Rather than using the change from 2010 to 2011, here we use only the 2011 data.

¹⁷⁵ At the 6-digit NAICS level, 27 of the 122 energy efficiency industries listed have employment data available. At the 4-digit NAICS level, 46 of the 122 energy efficiency industries listed have employment data available.

BLS does not collect data on energy efficiency expenditures directly, however. Instead, BLS collects data on the share of revenues associated with green goods and services, at the establishment level.¹⁷⁶ We multiply data on total revenues by NAICS by the share of green revenues reported by BLS to obtain a measure of green revenues by industry. The only U.S. Government data source containing this revenue information for all NAICS sectors is the U.S. Economic Census. This Census is conducted at 5-year intervals (the latest available year is 2012), however, making it unsuitable for directly pairing with 2011 data from BLS. Instead, we use U.S. Census Bureau data on total value of shipments by industry, for 2011, from the Annual Survey of Manufacturers.¹⁷⁷ The disadvantage of this data source is that the manufacturing sector makes up only 50 percent of the 132 NAICS codes belonging to the energy efficiency sector as defined by the BLS *Green Goods and Services* surveys, with the remainder in the construction or service sectors. Thus, this analysis implicitly projects that the same number of jobs per dollar are supported in construction and service sectors as in manufacturing. Also, the Annual Survey of Manufacturers contains data for some, but not all, detailed industry codes, e.g. 4-digit and 6-digit NAICS. We pair our BLS GGS data by industry, either by 4-digit or 6-digit NAICS, with data from the Annual Survey of Manufacturers. At the more detailed, 6-digit level, 17 industries have data available for both employment and total value of shipments.¹⁷⁸ At the less detailed, 4-digit level, 15 industries have data available for both employment and total value of shipments.¹⁷⁹ Using this approach we obtain estimates of 2.07 demand-side energy efficiency jobs per million 2011 dollars of expenditure, using the less-detailed industry level (4-digit NAICS), and 3.29 demand-side energy efficiency jobs per million 2011 dollars of expenditure, using the more-detailed industry level (6-digit NAICS).

¹⁷⁶ More information is available here: <http://www.bls.gov/ggs/ggsfaq.htm#5>.

¹⁷⁷ Census data on total value of shipments, by industry, for 2011 is available here: http://factfinder.census.gov/faces/tableservices/jsf/pages/productview.xhtml?pid=ASM_2011_31GS101&prodType=table.

¹⁷⁸ The 17 industries are: NAICS 321219, 321991, 321992, 327993, 327999, 332913, 332996, 333414, 333415, 334513, 334514, 334515, 335110, 335222, 335311, 335312, and 335999.

¹⁷⁹ The 15 industries are: NAICS 314100, 321100, 324100, 326100, 327100, 327300, 327400, 332100, 333300, 334200, 334300, 334400, 335200, 336300, and 337900.

Having calculated estimates of jobs per million dollars of energy efficiency expenditure, we use EPA’s illustrative energy efficiency investment levels of the first-year costs expected for states to attain a target of 1 percent growth in demand-side efficiency improvements (see Chapter 3.7 of this RIA for more information). If some states were to target rates of energy efficiency savings greater than one percent, they may see increased energy efficiency employment impacts, relative to the one percent growth assumed in this analysis. The first year cost of saved energy (i.e., reduced electricity demand) accounts for both the costs to the utilities that are funding the demand-side energy efficiency programs (known as the program costs), and the additional cost to the end-user purchasing a more energy efficient technology (known as the participant costs).¹⁸⁰ Total costs were divided evenly, 50 percent each, between program costs and participant costs. First-year costs are not annualized; they are the projected expenditures on demand-side energy efficiency activities in that year. As shown in the Demand-Side Energy Efficiency Technical Support Document¹⁸¹, first-year costs for achieving a 1 percent growth target¹⁸² in energy efficiency activities are projected to be \$18.1 billion (2011 \$) in 2020. Multiplying this dollar expenditure by the jobs per dollar estimates results in projected employment impacts for demand-side energy efficiency activities ranging from 37,570 to 59,700 jobs in 2020 depending on the jobs per million dollars estimate used: low or high. Employment impacts for demand-side energy efficiency activities range from 52,590 to 83,590 jobs in 2025, and from 52,440 to 83,360 jobs in 2030. These estimates are shown in Table 6-6 below.

¹⁸⁰ See Section 3.6.2, “Demand-Side Energy Efficiency Total Costs”, in this RIA, for more information.

¹⁸¹ U.S. EPA. 2015. Technical Support Document (TSD) the Final Carbon Pollution Emission Guidelines for Existing Stationary Sources: Electric Utility Generating Units. Demand-Side Energy Efficiency.

¹⁸² The illustrative demand-side energy efficiency plan scenario reflects each state ramping up to the 1% incremental savings target from their 2013 level, beginning in 2020. Thus, most states are below 1% in 2020. All states have achieved the 1% target no later than 2025 and the plan scenario has each state remain at that level through 2030.

Table 6-6. Estimated Demand-Side Energy Efficiency Employment Impacts: Target 1 percent Growth in Energy Efficiency

Source	Factor	Employment impact (jobs)*		
		2020	2025	2030
EPA low estimate, using BLS and Census data, and power sector modeling projections	2.07	37,570	52,590	52,440
EPA high estimate, using BLS and Census data, and power sector modeling projections	3.29	59,700	83,590	83,360

*Since these figures represent number of employees (full- or part-time) they should not be added to the full-time equivalent job-years reported in Table 6-4 and Table 6-5. Energy efficiency costs are from 1 percent growth target projections for the continental U.S.. First-year energy efficiency costs are the same for rate-based and mass-based scenarios. See Chapter 3 of this RIA and Demand-Side Energy Efficiency TSD for more information.

Although this approach has the advantage of using a range of estimates, derived from U.S. government data, on energy efficiency employment per million dollars in industry shipments, this approach is limited by its focus on manufacturing sectors and direction of bias (overestimation or underestimation) cannot be determined at this time. As stated earlier, if, rather than a one percent target, some states were to target rates of energy efficiency savings greater than one percent, they may see increased energy efficiency employment impacts, relative to the one percent growth assumed in this analysis. Finally, because states can choose to reduce emissions by means of adopting more and broader demand-side energy efficiency programs, there is uncertainty around the mix of energy efficiency programs and their associated demand-side energy efficiency employment impacts.

Our estimates of 2.07 to 3.29 demand-side energy efficiency jobs per million dollars of 2011 expenditure fit with other estimates in the literature, focused on government data sources, and are on the smaller end of the range.¹⁸³ Figure 6.4 shows the range of estimates, including EPA low (2.07) and EPA high (3.29). The Department of Commerce report estimates overall employment per million dollar values, ranging from 4.65 to 4.85 (Department of Commerce 2010a).¹⁸⁴ The report also contains some case studies, and for those focused on energy efficiency, the Department of Commerce estimates 6.21 jobs per million dollars in green buildings activities

¹⁸³ See Section 6.5.3 for more information on sources in the literature.

¹⁸⁴ Calculated values using data on employment and shipments reported in Department of Commerce (2010a), Table 2, p. 12.

and 7.53 jobs per million dollars for energy efficiency appliances.¹⁸⁵ Lawrence Berkeley National Lab (Goldman *et al.* 2010) reports a wide range of estimates: from 2.5 jobs per million dollars for energy service companies (ESCOs), to 8.9 jobs per million dollars for low income weatherization activities. The Pacific Northwest National Labs report (Anderson *et al.* 2014), in surveying the literature, estimates 11 jobs per million dollars of initial energy efficiency investments.

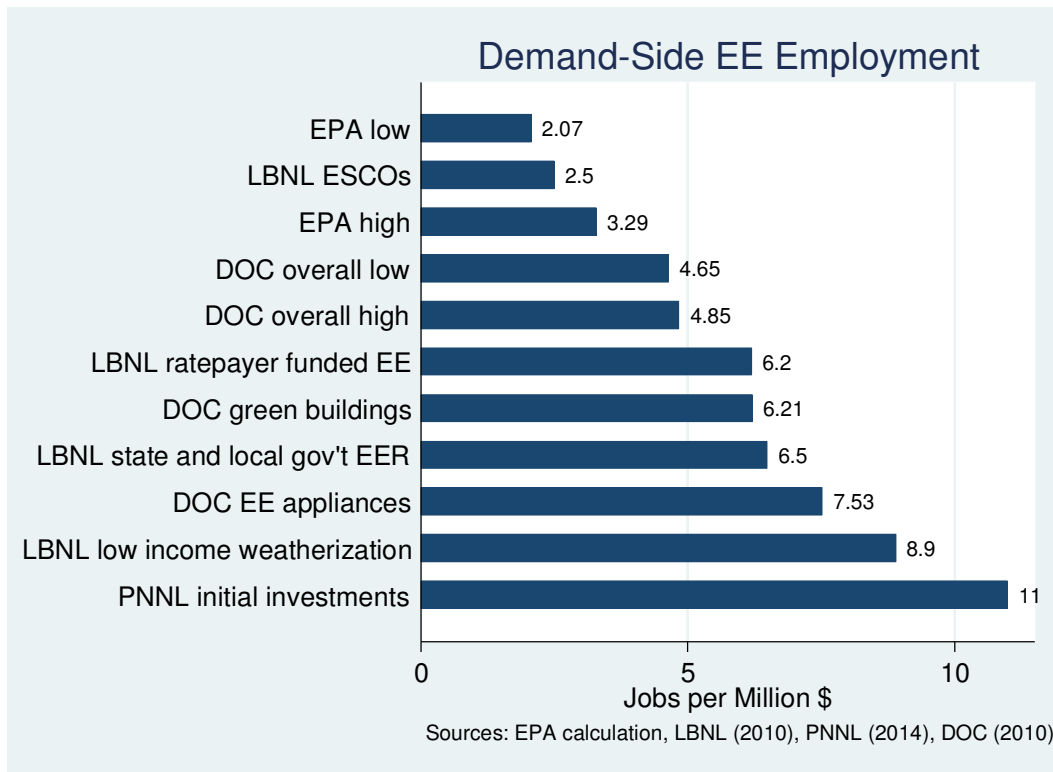

Figure 6.4. Demand-Side Energy Efficiency Employment: Jobs per One Million Dollars (2011\$)

There is more uncertainty involved in this approach than the standard bottom-up engineering analysis used to estimate electricity generation and fuel production employment impacts of this rulemaking. For those, the EPA was able to identify a limited set of activities (e.g., constructing a new NGCC power plant), and study associated labor requirements. Demand-

¹⁸⁵ Calculated values using data on employment and shipments reported in Department of Commerce (2010a), Appendix 2, Table 2B, p. 4. http://www.esa.doc.gov/sites/default/files/appendix2_0.pdf

side energy efficiency improvements, in contrast, encompass a wide array of activities (subsidies for efficient appliances, “smart meters,” etc.). In addition, there is considerable uncertainty regarding which activities a state will choose. Thus, the validity of the jobs per dollar approach used here relies on the assumption that states will use a mix of activities similar to the 2011 composition of energy efficiency sectors identified by BLS. Finally, this approach recognizes that shifts in economic activity towards investments in demand-side energy efficiency are accompanied by potential shifts in employment.

In addition, the EPA does not have access to bottom-up information regarding labor requirements for these activities. Use of a constant job per dollar fraction is at best a crude approximation of these labor requirements. The EPA has identified several other limitations of this approach, outlined below.

Job Reclassification. Job numbers in this chapter represent gross changes in the affected sector. As such they may over-estimate impacts to the extent that jobs created displace workers employed elsewhere in the economy. For demand-side efficiency activities this potential over-statement may be higher than in other sectors. If states encourage consumers to purchase ENERGY STAR appliances, for example, currently employed workers in factories and retail outlets may simply be given a different task. This approach, however, would count these workers as jobs created.

Imports. The job per dollar fraction used in the employment projection is calculated based on jobs per dollar of revenue for domestic firms only. To the extent that spending on demand-side energy efficiency activities goes toward the purchase of imported goods this projection will overstate the U.S. employment impact of those expenditures.

Fixed Coefficient. Implicit in this approach is the assumption that employment impacts can be projected decades into the future on the basis of a single calculation from 2011 data. The labor intensity of demand-side energy efficiency will likely change with technological innovation in the sector. In addition, even absent technological change, labor intensity of expenditures will likely change over time as states alter their portfolio of efficiency activities (e.g., by moving to higher cost activities after exhausting low-cost efficiency activities).

Non-additional Activities. Here we assume that all activities financed by demand-side energy efficiency expenditures are additional to what would have been undertaken in the absence of

these programs. For example, if utilities finance some actions customers would have undertaken in the absence of these programs (e.g., if a customer receives a rebate for an energy efficient appliance that would have been purchased without the rebate), these numbers would overestimate employment impacts of the final emissions guidelines.

6.6 Conclusion

This chapter presents qualitative and quantitative discussions of potential employment impacts of the final guidelines for electricity generation, fuel production, and demand-side energy efficiency sectors. The qualitative discussion identifies challenges associated with estimating net employment effects and discusses anticipated impacts related to the rule. It includes an in-depth discussion of economic theory underlying analysis of employment impacts. The employment impacts for regulated firms can be decomposed into output and substitution effects, both of which may be positive or negative. Consequently, economic theory alone cannot predict the direction or magnitude of a regulation's employment impact. It is possible to combine theory with empirical studies specific to the regulated firms and other relevant sectors if data and methods of sufficient detail and quality are available. Finally, economic theory suggests that environmental regulations may have positive impacts on labor supply and productivity as well.

We examine the peer-reviewed economics literature analyzing various aspects of labor demand, relying on the above theoretical framework. Determining the direction of employment effects in regulated industries is challenging because of the complexity of the output and substitution effects. Complying with a new or more stringent regulation may require additional inputs, including labor, and may alter the relative proportions of labor and capital used by regulated firms (and firms in other relevant industries) in their production processes. The available literature illustrates some of the difficulties for empirical estimation: for example, there is a paucity of publicly data on plant-level employment, thus most studies must rely on confidential plant-level employment data from the U.S. Census Bureau, typically combined with pollution abatement expenditure data, that are too dated to be reliably informative, or other measures of the stringency of regulation. In addition, the most commonly used empirical methods, for example, Greenstone (2002), likely overstate employment impacts because they rely on relative comparisons between more regulated and less regulated counties, which can lead to "double counting" of impacts when production and employment shift from more regulated

towards less regulated areas. Thus these empirical methods cannot be used to estimate net employment effects. . Empirical analysis at the industry level requires estimates of product demand elasticity; production factor substitutability; supply elasticity of production factors; and the share of total costs contributed by wages, by industry, and perhaps even by facility. Econometric studies of environmental rules converge on the finding that employment effects, whether positive or negative, have been small in regulated sectors.

The illustrative quantitative analysis in this chapter projects a subset of potential employment impacts in the electricity generation, fuel production, and demand-side energy efficiency sectors. States have the responsibility and flexibility to implement plans that satisfy final emissions guidelines, while affected EGUs may choose their compliance strategies from requirements imposed by these plans. As such, given the wide range of approaches that may be used, quantifying the associated employment impacts is difficult. EPA's employment analysis includes projected employment impacts associated with these guidelines assuming two illustrative plan approach scenarios for the electric power industry, coal and natural gas production, and demand-side energy efficiency activities. These projections are derived, in part, from a detailed model of the electricity production sector used for this regulatory analysis, and U.S. government data on employment and labor productivity. In the electricity, coal, and natural gas sectors, the EPA estimates that these guidelines could have an employment impact of roughly -8,500 job-years in 2020, -25,000 job-years in 2025, and -30,900 job-years in 2030 for the rate-based scenario. For the mass-based scenario, the EPA estimates that these guidelines could have an employment impact of roughly -13,100 job-years in 2020, -26,000 job-years in 2025, and -33,700 job-years in 2030 (see Tables 6-4 and 6-5).

Employment impacts from demand-side energy efficiency activities are based on historic data on jobs supported per million dollars of expenditure on energy efficiency. Demand-side energy efficiency employment impacts would approximately range from 37,570 to 59,700 jobs in 2020, 52,590 to 83,590 jobs in 2025, and from 52,440 to 83,360 jobs in 2030 for both the rate-based and mass-based approaches and a 1 percent growth target for energy efficiency expenditures (see Table 6-6).

The IPM-generated job-year numbers for the electricity, coal and natural gas sectors should not be added to the demand-side efficiency job impacts, since the former are reported in

full-time equivalent job-years, whereas the latter do not distinguish between full- and part-time employment. Finally, note again that this analysis is based on two an illustrative plan approaches, and CAA section 111(d) allows each state to determine its state plan, by way of meeting its state-specific goal. Given the flexibilities afforded states in implementing plans that satisfy the emission guidelines, and in the compliance options affected EGUs may take, the impacts reported in this chapter are illustrative of actions states may take.

6.7 References

- Aldy, J.E. 2013. "A Preliminary Assessment of the American Recovery and Reinvestment Act's Clean Energy Package." *Review of Environmental Economics and Policy*. 7(1):136-155.
- Allcott, H. 2011a. "Social Norms and Energy Conservation." *Journal of Public Economics*. 95(9-10):1082-1095.
- Allcott, H. 2011b. "Rethinking Real-Time Electricity Pricing," *Resource and Energy Economics*. 33:820-842.
- Almon, C. 1991. "The Inforum Approach to Interindustry Modeling," *Economic Systems Research* 3(1):1-8.
- Anderson, D., O. Livingston, D. Belzer, D., and M. Scott. 2014. "Assessing National Employment Impacts of Investment in Residential and Commercial Sector Energy Efficiency: Review and Example Analysis" [Technical Report]. Pacific Northwest National Laboratory . Available at < http://www.pnnl.gov/main/publications/external/technical_reports/PNNL-23402.pdf >. Accessed June 4, 2015.
- Anger, N. and U. Oberndorfer. 2008. "Firm Performance and Employment in the EU Emissions Trading Scheme: An Empirical Assessment for Germany." *Energy Policy*. (36):12-22.
- Arimura, T. H.; S. Li; R. G. Newell, and K. Palmer. 2012 "Cost-Effectiveness of Electricity Energy Efficiency Programs." *Energy Journal*. 33(2):63-99.
- Arrow, K. J.; M. L. Cropper; G. C. Eads; R. W. Hahn; L. B. Lave; R. G. Noll; Paul R. Portney; M. Russell; R. Schmalensee; V. K. Smith and R. N. Stavins. 1996. "Benefit-Cost Analysis in Environmental, Health, and Safety Regulation: A Statement of Principles." American Enterprise Institute, the Annapolis Center, and Resources for the Future; AEI Press. Available at <[http://www.hks.harvard.edu/fs/rstavins/Papers/Benefit Cost Analysis in Environmental.AEI.1996.pdf](http://www.hks.harvard.edu/fs/rstavins/Papers/Benefit%20Cost%20Analysis%20in%20Environmental.AEI.1996.pdf)>. Accessed June 5, 2015.

- Berman, E. and L. T. M. Bui. 2001. "Environmental Regulation and Labor Demand: Evidence from the South Coast Air Basin." *Journal of Public Economics*. 79(2): 265-295.
- Bezdek, R. H.; R. M. Wendling, and P. Diperna. 2008. "Environmental Protection, the Economy, and Jobs: National and Regional Analyses." *Journal of Environmental Management*. 86(1): 63-79.
- Brown, R.S. and L. R. Christensen. 1981. "Estimating the Elasticities of Substitution in a Model of Partial Static Equilibrium: An Application to U.S. Agriculture 1947 to 1974," in: Berndt, E.R.; B. C. Field. (Eds.), *Modeling and Measuring Natural Resource Substitution*.
- Chan, H. S., S. Li, and F. Zhang. (2013) "Firm Competitiveness and the European Union Emissions Trading Scheme." *Energy Policy*. (63):1056-1064.
- Commins, N., S. Lyons, M. Schiffbauer, and R. S.J. Tol. 2011. "Climate Policy and Corporate Behaviour." *The Energy Journal*. (32):51-68.
- Congressional Budget Office (2011), Statement of Douglas W. Elmendorf, Director, before the Senate Budget Committee, "Policies for Increasing Economic Growth and Employment in 2012 and 2013" (November 15)<http://www.cbo.gov/sites/default/files/11-15-Outlook_Stimulus_Testimony.pdf>
- Council of Economic Advisers. 2011. "The Economic Impact of the American Recovery and Reinvestment Act of 2009." Sixth quarterly report.
- Ehrenberg, R. G. and R. S. Smith. 2000. *Modern Labor Economics: Theory and Public Policy*. Addison Wesley Longman, Inc., Chapter 4.
- Executive Order 13563 (January 21, 2011). "Improving Regulation and Regulatory Review. Section 1. General Principles of Regulation." *Federal Register* 76(14): 3821-3823.
- Ferris, A. E., R. J. Shadbegian, A. Wolverton. 2014. "The Effect of Environmental Regulation on Power Sector Employment: Phase I of the Title IV SO₂ Trading Program." *Journal of the Association of Environmental and Resource Economists*. 1(4): 521-553.
- Gillingham, K.; R. Newell and Karen Palmer. 2009. "Energy Efficiency Economics and Policy." *Annual Review of Resource Economics*. 1(1): 597-619.
- Gillingham, K. and K. Palmer. 2014. "Bridging the Energy Efficiency Gap: Policy Insights from Economic Theory and Empirical Evidence." *Review of Environmental Economics and Policy*. 8(1):18-38.

- Global Insight. 2008. *U.S. Metro Economies: Current and Potential Green Jobs in the U.S. Economy*. U.S. Conference of Mayors. Available at: <<http://www.usmayors.org/pressreleases/uploads/greenjobsreport.pdf>>.
- Goldman, C.; M. C. Fuller; E. Stuart; J. S. Peters; M. McRae and N. Albers, *et al.* 2010. *Energy Efficiency Services Sector: Workforce Size and Expectations for Growth*. Lawrence Berkeley National Laboratory, LBNL-3987E.
- Graff Zivin J. and M. Neidell. 2012. “The Impact of Pollution on Worker Productivity.” *American Economic Review*. 102(7):3652-73.
- Graff Zivin, J. and M. Neidell. 2013. “Environment, Health, and Human Capital.” *Journal of Economic Literature*. 51:(3):689-730.
- Gray, W., R. J. Shadbegian, C. Wang and M. Meral. 2014 “Do EPA Regulations Affect Labor Demand? Evidence from the Pulp and Paper Industry”, *Journal of Environmental Economics and Management*. 68: 188-202.
- Greenstone, M. 2002. “The Impacts of Environmental Regulations on Industrial Activity: Evidence from the 1970 and 1977 Clean Air Act Amendments and the Census of Manufactures.” *Journal of Political Economy*. 110(6): 1175-1219.
- Hamermesh, D. S. 1993. *Labor Demand*. Princeton, NJ: Princeton University Press. Chapter 2.
- Kahn, M.E. and E. T. Mansur. 2013. “Do Local Energy Prices and Regulation Affect the Geographic Concentration of Employment?” *Journal of Public Economics*. 101:105–114.
- Layard, P.R.G. and A. A. Walters. 1978. *Microeconomic Theory*. McGraw-Hill, Inc. Chapter 9.
- List, J. A.; D. L. Millimet; P. G. Fredriksson and W. W. McHone. 2003. “Effects of Environmental Regulations on Manufacturing Plant Births: Evidence from a Propensity Score Matching Estimator.” *The Review of Economics and Statistics*. 85(4): 944-952.
- Marshall, A. 1920. *Principles of Economics*. Library of Economics and Liberty. Available at: <<http://www.econlib.org/library/Marshall/marP.html>> .
- Mccarthy, M.B. 1991. “Lift: Inforum's Model of the U.S. Economy,” *Economic Systems Research* 3(1):15-36.
- Meade, D.S. 2009. “An Analysis of the Economic Impacts of the 2007 Energy Independence and Security Act”, in *Energy Policy and International Competitiveness*, M. Grassini and R. Bardazzi, eds. Firenze University Press, pgs. 3-28.
- Muro, M.; J. Rothwell; D. Saha & Partnership, w. B. 2011. *Sizing the Clean Economy: A National and Regional Green Jobs Assessment*. Brookings Institution, Metropolitan Policy

- Program. Available at
<http://www.brookings.edu/~media/series/resources/0713_clean_economy.pdf>. Accessed June 4, 2015.
- Ostro, B.D. 1987. "Air Pollution and Morbidity Revisited: A Specification Test." *Journal of Environmental Economics Management*. 14:87-98.
- Schmalensee, R. and R. Stavins (2011). "A Guide to Economic and Policy Analysis for the Transport Rule." White Paper. Boston, MA. Exelon Corp.
- Smith, K. 2012. "Reflections: In Search of Crosswalks between Macroeconomics and Environmental Economics." *Review of Environmental Economics and Policy*. 6(2):298-317.
- Southwest Energy Efficiency Project. 2002. "The New Mother Lode: The Potential for More Efficient Electricity Use in the Southwest." Available at:
<<http://www.swenergy.org/publications/nml/>>. Accessed June 4, 2015.
- The Pew Charitable Trust. 2009. "The Clean Energy Economy: Repowering Jobs, Businesses and Investments Across America." Available at: <<http://community-wealth.org/content/clean-energy-economy-repowering-jobs-businesses-and-investments-across-america>>. Accessed June 4, 2015.
- The Solar Foundation in partnership with BW Research and GW Institute. 2014. "The National Solar Jobs Census." Available at: <<http://www.thesolarfoundation.org/national-solar-jobs-census-2014/>>.
- Sommers, D. 2013. "BLS Geen Jobs Overview," *Monthly Labor Review*. U.S. Bureau of Labor Statistics, January, p. 3-16. Available at <<http://www.bls.gov/opub/mlr/2013/01/art1full.pdf>>. Accessed June 4, 2015.
- U.S. Department of Commerce, Economics and Statistics Administration. 2010a. "Measuring the Green Economy." Available at: <<http://www.esa.doc.gov/Reports/measuring-green-economy>>. Accessed June 4, 2015.
- U.S. Department of Commerce, International Trade Administration. 2010b. Environmental Industries Fact Sheet, using 2008 data from Environmental Business International, Inc., April. Available at:
<<http://web.ita.doc.gov/ete/eteinfo.nsf/068f3801d047f26e85256883006ffa54/4878b7e2fc08ac6d85256883006c452c?OpenDocument>>. Accessed June 4, 2015.
- U.S. Department of Labor, Bureau of Labor Statistics. 2012a. Databases, Tables & Calculators by Subject. Available at <<http://data.bls.gov/timeseries/LNS14000000>>. Accessed on April 16, 2012.

- U.S. Department of Labor, Bureau of Labor Statistics (2012b, April 6). “The Employment Situation—March 2012.” News Release. Available at <<http://www.bls.gov/news.release/pdf/empsit.pdf>>. Accessed April 16, 2012.
- U.S. Department of Labor, U.S. Bureau of Labor Statistics, (n.d.). “Employment Projections Program.” and available at: <http://www.bls.gov/emp/ep_table_102.htm>.
- U.S. Department of Labor, U.S. Bureau of Labor Statistics. (n.d.). “Green Goods and Services, 2010-2011.” Available at: <<http://www.bls.gov/ggs/ggsoverview.htm>>. Retrieved January 14, 2014,
- U.S. Energy Information Agency. 2013. “Annual Energy Outlook 2014: Early Release.” Available at: http://www.eia.gov/forecast/aeo/er/early_elecgen.cfm.
- U.S. Environmental Protection Agency (U.S. EPA). 2011a. The Benefits and Costs of the Clean Air Act from 1990 to 2020, Final Report – Rev A. Office of Air and Radiation, Washington, DC. Available at <http://www.epa.gov/cleanairactbenefits/feb11/fullreport_rev_a.pdf>. Accessed June 4, 2015.
- U.S. Environmental Protection Agency (U.S. EPA). 2011b. Regulatory Impact Analysis for the Mercury and Air Toxics Standards (MATS). Office of Air Quality Planning and Standards, Research Triangle Park, NC. Available at <<http://www.epa.gov/ttn/ecas/regdata/RIAs/matsriafinal.pdf>>. Accessed June 4, 2015.
- U.S. EPA. 2015. Technical Support Document (TSD) the Final Carbon Pollution Emission Guidelines for Existing Stationary Sources: Electric Utility Generating Units. GHG Mitigation Measures.
- U.S. International Trade Commission. “Environmental and Related Services.” Publication No. 4389, Investigation No. 332-533, March, 2013. Available at <<http://www.usitc.gov/publications/332/pub4389.pdf>>. Accessed June 4, 2015.
- Walker, W. R. 2011. “Environmental Regulation and Labor Reallocation.” *American Economic Review*. 101(2): 442-47.
- Walker, W. R. 2013. “The Transitional Costs of Sectoral Reallocation: Evidence From the Clean Air Act and the Workforce.” *The Quarterly Journal of Economics* 128 (4): 1787-1835.
- Wei, M., S. Patadia, and D. M. Kammen. 2010. “Putting Renewables And Energy Efficiency to Work: How Many Jobs Can the Clean Energy Industry Generate in the US?” *Energy Policy*, 38(2):919-931.

- Werling, J.F. 2011. "Preliminary Economic Analysis for OSHA's Proposed Crystalline Silica Rule: Industry and Macroeconomic Impacts", Final Report for the Occupational Safety and Health Administration, Available at https://www.osha.gov/silica/Employment_Analysis.pdf. Accessed June 9, 2015.
- Yi, H. 2013. "Clean Energy Policies and Green Jobs: An Evaluation of Green Jobs in U.S. Metropolitan Areas." *Energy Policy*. 56:644-65.

APPENDIX 6A: ESTIMATING SUPPLY SIDE EMPLOYMENT IMPACTS

This appendix presents the methods used to estimate the supply-side employment impacts of the Final Carbon Pollution Emission Guidelines for Existing Stationary Sources: Electric Utility Generating Units (herein referred to as “final emission guidelines” or the “Clean Power Plan Final Rule”). The focus of the employment analysis is limited to the direct changes in the amount of labor needed in the power, fuels and generating equipment sectors directly influenced by the illustrative plan approaches analyzed for the final emission guidelines. It does not include the ripple effects of these impacts on the broader economy (i.e., the “multiplier” effect), nor does it include the wider economy-wide effects of the changes to the energy markets, such as changes in electricity prices.

The methods used to estimate the supply-side employments are based on methods previously developed for the Mercury and Air Toxics Standards (MATS) Regulatory Impact Analysis (RIA). The methods used in this analysis to estimate the recurring labor impacts (e.g., labor associated with operating and maintaining generating units, as well as labor needed to mine coal and natural gas) are the same as was used in MATS (with updated data where available).

The labor analysis in the MATS RIA was primarily concerned with the labor needs of retrofitting pollution control equipment. The analysis for the Clean Power Plan Final Rule, however, involves the quantity and timing of the labor needs of building new renewable and natural gas, as well as making heat rate improvements (HRI) at existing coal fired EGUs. These construction-related compliance activities in the Clean Power Plan Final Rule required developing additional appropriate analytical methods that were not needed for the MATS analysis. The newly developed analytical methods for the construction-related activities are similar in structure and overall approach to the methods used in MATS, but required additional data and engineering information not needed in the MATS RIA.

6A.1 General Approach

The analytical approach used in this analysis is a bottom-up engineering method combining the EPA’s cost analysis of the final emission guidelines with data on labor

productivity, engineering estimates of the amount and types of labor needed to manufacture, construct, and operate different types of generating units, and prevailing wage rates for skilled and general labor categories. The approach involved using utility power sector projections and various energy market implications under the final emission guidelines from modeling conducted with the EPA Base Case version 5.15, using the Integrated Planning Model (IPM)¹⁸⁶, along with data from secondary sources, to estimate the first order employment impacts for 2020, 2025, and 2030.

Throughout the supply-side labor analysis the engineering approach projects labor changes measured as the change in each analysis year in job-years employed in the power generation and directly related sectors (e.g., equipment manufacturing, fuel supply and generating efficiency services). Job-years are not individual jobs, nor are they necessarily permanent nor full time jobs. Job-years are the amount of work performed by one full time equivalent (FTE) employee in one year. For example, 20 job-years in 2020 may represent 20 full-time jobs or 40 half-time jobs in that year, or any combination of full- and part-time workers such that total 20 FTEs.

The estimates of the employment impacts (both positive and negative) are divided into five categories:

- additional employment to make HRI¹⁸⁷ at existing coal fired EGUs;
- additional construction-related employment to manufacture and install additional new generating capacity (renewables, and natural gas combined cycle or combustion turbine units) when needed as part of early compliance actions;
- lost construction-related employment opportunities due to reductions in the total amount of new generating capacity needed to be built in the later years because of reduced overall demand for electricity because of demand-side energy efficiency activities;

¹⁸⁶ Results for this analysis were developed using various outputs from EPA's Base Case v.5.15 using ICF's Integrated Planning Model (IPM). See <http://www.epa.gov/powersectormodeling/> for more information.

¹⁸⁷ Heat rate improvements could include a range of activities in the power plant to lower the heat rate required to generate a net electrical output. Assuming all other things being equal, a lower heat rate is more efficient because less fuel is needed per unit of electric output.

- lost operating and maintenance employment opportunities due to increased retirements of coal and small oil/gas units;
- changes (both positive and negative) in coal mining and natural gas extraction employment due to the aggregate net changes in fuel demands arising from all the activities occurring due to compliance with the final emission guidelines.

Some of the changes are one-time labor effects which are associated with the building (or avoiding building) new generating capacity and installing HRI. This type of employment effects involves project-specific labor that is used for 2 to 4 years to complete a specific construction and installation type of project. There are other labor effects, however, which continue year after year. For example, bringing new generating capacity online creates an ongoing need for labor to operate and maintain the new generating capacity throughout the expected service life of the unit. New generating capacity also creates a need for additional employment to provide the fuel annually to run the new capacity. There are also continuing effects from the lost operations and maintenance (O&M) and fuel sector labor opportunities from decisions to retire existing capacity, as well as similar lost labor opportunities from decisions to reduce a portion of the amount of additional capacity needed in the base case.

6A.2 Employment Changes due to Heat Rate Improvements

The employment changes due to HRI were estimated based on the incremental MW capacity estimated to implement such improvements between 2021 and 2030 as indicated by the IPM analysis presented in Chapter 3. The labor analysis assumes there will be no HRI-related costs jobs associated with operating or maintaining an EGU after HRI improvements are made. As described in Chapter 3 of this RIA, EPA modeled the heat rate improvements exogenously to IPM using the assumption that all “relevant” units can improve their heat rate at a capital cost of \$100/kW. The labor analysis assumes that the cost of implementing the HRI investments at a particular EGU will occur over a four year period. Hence, the labor analysis calculates the per-year cost of implementing the HRI is calculated to be \$25/kW over a four year period, and these HRI cost occur in the 4 years prior to the HRI improvements at an individual EGU being operational.

The HRI costs were then allocated to four categories based on the estimates provided by Andover Technology Partners (ATP), which were adapted from proxy projects involving installation of combustion control retrofits, such as those installed under the Best Available Retrofit Technology (BART) submissions from coal-fired power plants located in Wyoming and Arizona. For more details, refer to the Staudt (2014) report.¹⁸⁸ The data from the BART submissions are used as proxies that are representative of the activities (and their associated costs) EGUs will improve use to implement the HRI.

Information on cost for these proxies were then extrapolated to approximate the labor requirements for four broad categories of labor – boilermakers and general construction, engineering and management support labor, labor required to produce the equipment in upstream sectors, and labor required to supply the materials (assumed to be primarily steel) in upstream sectors. More details about these estimates are provided in the Staudt (2014) report.

Based on the cost allocated to each labor categories, output per worker estimates for respective labor categories, and the assumed growth in labor productivity during the period 2021 through 2030 (with the bulk of HRI occurring between 2021 and 2025), the employment gains for heat rate improvement were estimated for 2025 using the assumptions summarized in Table 6A-1 below. Output per workers in future years were adjusted to account for growth in labor productivity, based on historical evidence of productivity growth rates for the relevant sectors.

189

¹⁸⁸ Staudt, James, Andover Technology Partners, Inc. Estimating Labor Effects of Heat Rate Improvements. Report prepared for the Clean Power Plan Proposed Rule, March 6, 2014.

¹⁸⁹ Total value of shipments or receipts in 20012 and total employees were taken from 2012 Economic Census, Statistics by Industry for Mining and Manufacturing sectors. The average annual growth rate of labor productivity was taken from the Bureau of Labor Statistics. Average growth rate calculated for years 1988-2007, applied to 2012 productivity to determine 2025 estimates of productivity. For the construction sector, BLS productivity growth rate data was unavailable. Because of this, and lack of reliable data on construction sector productivity growth, the output per worker for the construction sector was not forecasted to 2030, and the most recent available value from 2012 was used.

Table 6A-1. Labor Productivity Growth Rate due to Heat Rate Improvement

	Share of the Total Capital Cost	Output/Worker (2025)	Labor Productivity Growth Rate
Boilermaker and Gen. Const.	40%	\$78,500	0%
Management/Engineering	20%	\$156,000	0.8%
Equipment	30%	\$542,000	2.7%
Materials	10%	\$600,000	1.0%

For these output per worker figures, a power sector construction industry (NAICS 237130) was used for general construction and boilermakers, Engineering Services (NAICS 54133) was used for the engineering and management component, Machinery Manufacturing (NAICS 333) was used for the equipment sector, and steel manufacturing (NAICS 3312) was used for materials. Use of machinery manufacturing for equipment and steel for materials was based on an analysis of the types of materials and equipment needed for these projects, and what EPA determined to be the most appropriate industry sectors for those. For more details, refer to the Staudt (2014) report.

6A.2.1 Employment Changes Due to Building (or Avoiding) New Generation Capacity

Employment changes due to new generation units were based on the incremental changes in capacity (MW), capital costs (\$MM), and fixed operations and maintenance (FOM) costs (\$MM) between the policy scenarios and the base case in a given year.

New capacities were aggregated by generation type into the following categories:

- Combined Cycle,
- Combustion Turbine, and
- Renewables (which includes biomass, geothermal, landfill gas, onshore wind, and solar).

For each category, the analysis estimated the impacts due to both the construction and operating labor requirements for corresponding capacity changes. The construction labor was estimated using information on the capital costs, while the operating labor was estimated using the FOM costs.

Because IPM outputs provide annualized capital costs (\$MM), EPA first converted the annualized capital costs to changes in the total capital investment using the corresponding capital

charge rates.¹⁹⁰ These total capital investments were then converted to annual capital investments using assumptions about the estimated duration of the construction phase, in order to estimate the annual impacts on construction phase labor. Duration estimates were based on assumptions for construction lengths used in EPA’s IPM modeling.¹⁹¹ Specific assumptions used for different generating technologies are shown in Table 6A-2 below.

Table 6A-2. Capital Charge Rate and Duration Assumptions

New Investment Technology	Capital Charge Rate	Construction Duration (Years)
Advanced Combined Cycle	10.3%	3
Advanced Combustion Turbine	10.6%	2
Renewables		
Dedicated Biomass	9.5%	3
Wind (Onshore)	10.9%	3
Landfill Gas	10.9%	3
Solar	10.9%	3
Geothermal	10.9%	3

Annual capital costs for each generation type were then broken down into four categories: equipment, material (which is assumed to be primarily steel), installation labor, and support labor in engineering and management. The percentage breakdowns shown in Table 6A-3 were estimated using information provided by Staudt (2014), based primarily on published budgets for new unit assembled in a study for the National Energy Technology Laboratory (NETL). For more details, refer to the Staudt (2014) report. Annual capital costs for each generation type provided by the IPM output were allocated according to this breakdown.

Table 6A-3. Expenditure Breakdown due to New Generating Capacity

	Equipment	Material	Labor	Eng. and Const. Mgt
Renewables	54%	6%	31%	9%
Combined Cycle	65%	10%	18%	7%
Combustion Turbine	65%	10%	18%	7%

The short-term construction labor of the new generation units were based on output (\$ per worker) figures for the respective sectors. The total direct workers per \$1 million of output for the baseline year 20012 were forecasted to the years under analysis using the relevant labor

¹⁹⁰ Capital charge rates obtained from EPA’s resource, EPA #450R13002: Documentation for EPA Base Case v.5.13 using the Integrated Programming Model (IPM).

¹⁹¹ Ibid.

productivity growth rate. Table 6A-4 shows the figures for each of the five productivities: general power plant construction; engineering and management; material use; equipment use; and plant operators. The resulting values were multiplied by the capital costs to get the job impact.

Table 6A-4. Labor Productivity due to New Generating Capacity

	Labor Productivity Growth Rate	Workers per Million \$ (20012)
General Power Plant Construction	0.0%	5.0
Engineering and Management	0.8%	5.24.7
Material Use (Steel)	1.0%	1.9
Equipment Use (Machinery)	2.7%	2.1
Plant Operators	1.7%	9.9

General installation labor, assumed to be mostly related to the general power plant construction phase, was matched with the power industry specific construction sector. Engineering/management was matched to the engineering services sector to determine their respective output per worker. For materials, EPA assumed steel to be the proxy and used the steel manufacturing sector for this productivity. Equipment was assumed to primarily come from machinery manufacturing sector (such as turbines, engines and fans).

The net labor impact for construction labor for a given year was adjusted to account for changes in capacity that has already taken place in the prior IPM run year. Because IPM reports cumulative changes for new generating capacity for any given run year, this adjustment ensured that the short-term construction phase job impacts in any given run year does not reflect the cumulative effects of prior construction changes for the given policy scenario. The estimated amount of the change in construction-related labor in a single IPM run year (e.g., 2025) represents the average labor impact that occurs in all years between that IPM run year and the previous run year (i.e., the labor estimates derived from the 2025 IPM run year are the average annual labor impacts in 2021 through 2025). The construction labor results for 2020 represent the average labor impacts in 2017 through 2020.

The plant operating employment estimates used a simpler methodology as the one described above. The operating employment estimates use the IPM estimated change in FOM costs for the IPM run year. Because the FOM costs are inherently estimates for a single year, the operating employment estimates are for a single year only. While there are obviously operating

employment effects occurring in every year throughout the entire IPM estimation period (2017-2030), the labor analysis only estimates the single year labor impacts in the IPM run years: 2020, 2025 and 2030. The total direct workers for \$1 million and labor productivity growth rate provided for plant operators in Table 6A-4 were used to estimate the employment impact.

6A.2.2 Employment Changes due to Coal and Oil/Gas Retirements

Employment changes due to plant retirements were calculated using the IPM projected changes in retirement capacities for coal and oil/gas units for the relevant year and the estimated changes in total FOM costs due to those retiring units. Thus, the basic assumption in this analysis is that increased retirements (over the base case) will lead to reduced FOM expenditures at those plants which were assumed to lead to direct job losses for plant workers.

In order to estimate the total FOM changes due to retirements, EPA first estimated the average FOM costs (\$/kW) for existing coal-fired and oil/gas-fired units in the base case, as shown in Table 6A-5 below. It was assumed that the average FOM cost of existing units in the base case can be used as a proxy for the lost economic output due to fossil retirements. Thus, changes in the FOM costs for these retiring units were derived by taking the product of the incremental change in capacity and the average FOM costs. These values were converted to lost employment using data from the Economic Census and BLS on the output/worker estimates for the utility sector.¹⁹²

Table 6A-5. Average FOM Costs for Existing Coal and Oil and Gas Steam Capacity (\$/kW, 2011\$)

	2020	2025	2030
Coal	\$70	\$73	\$74
Oil and Gas	\$34	\$33	\$33

Note that the retirement related employment losses are assumed to include losses directly affecting the utility sector, and do not include losses in upstream sectors that supply other inputs to the EGU sector (except fuel related job losses, which are estimated separately and discussed in the next section).

¹⁹² The same specific sources as cited before, however, used workers and total payroll.

6A.2.3 Employment Changes due to Changes in Fossil Fuel Extraction

Two types of employment impacts due to projected fuel use changes were estimated in this section. First, employment losses due to either reductions or shifts in coal demand were estimated using an approach similar to EPA’s coal employment analyses under Title IV of the Clean Air Act Amendments. Using this approach, changes in coal demand (in short tons) for various coal supplying regions were taken from EPA’s base case and illustrative plan scenario model runs for the final EGU GHG NSPS. These changes were converted to job-years using U.S. Energy information Administration (EIA) data on regional coal mining productivity (in short tons per employee hour), using 2012 labor productivity estimates.^{193,194}

Specifically, the incremental changes to coal demand were calculated based on the coal supply regions in IPM -- Appalachia, Interior, and West and Waste Coal (which was estimated using U.S. total productivity). Worker productivity values used for estimating coal related job impacts are shown in Table 6A-6 below.

Table 6A-6. Labor Productivity due to Fossil Fuel Extraction

	Labor Productivity
Coal (Short tons/ employee hour)	
Appalachia	2.32
Interior	4.73
West	17.09
Waste	5.19
Natural Gas (MMBtu/ employee hour)	122.0
Pipeline Construction (Workers per \$Million)	4.2

For natural gas demand, labor productivity per unit of natural gas was unavailable, unlike coal labor productivities used above. Most secondary data sources (such as Census and EIA) provide estimates for the combined oil and gas extraction sector. This section thus used an adjusted labor productivity estimate for the combined oil and gas sector that accounts for the relative contributions of oil and natural gas in the total sector output (in terms of the value of

¹⁹³ EIA Annual Energy Review. 2012.

¹⁹⁴ Unlike the labor productivity estimates for various equipment resources which were forecasted to 2020 using BLS average growth rates, the labor analysis uses the most recent historical productivity estimates for fuel sectors. In general, labor productivity for the fuel sectors (both coal and natural gas) showed a significantly higher degree of variability in recent years than the manufacturing sectors, which would have introduced a high degree of uncertainty in forecasting productivity growth rates for future years.

energy output in MMBtu). This estimate of labor productivity was then used with the incremental natural gas demand for the respective IPM runs to estimate the job-years for the specific year (converting the TCF of gas used projected by IPM into MMBtu using the appropriate conversion factors). In addition, the pipeline construction costs were estimated using endogenously determined gas market model parameters in IPM used by EPA for the MATS rule (using assumptions for EPA's Base Case v4.10). This analysis assumed that the need for additional pipeline would be proportionate to those projected for the MATS rule and were hence extrapolated from those estimates (U.S. EPA, 2011). The job-years associated with the pipeline construction were included in the natural gas employment estimates. Worker productivity values used for estimating natural gas related job impacts are shown in Table 6A-6.

6A.3 References

- Staudt, James. 2014. "Estimating Labor Effects of Heat Rate Improvements. Report prepared for the Clean Power Plan Proposed Rule, March 6, 2014."
- U.S. Energy Information Agency. 2012. "Annual Energy Review 2012: Coal Mining Productivity Data." Available at <http://www.eia.gov/totalenergy/data/monthly/previous.cfm>. Accessed June 4, 2015
- U.S. Environmental Protection Agency (U.S. EPA). 2011. Regulatory Impact Analysis for the Mercury and Air Toxics Standards (MATS). Office of Air Quality Planning and Standards, Research Triangle Park, NC. Available at <http://www.epa.gov/ttn/ecas/regdata/RIAs/matsriafinal.pdf>. Accessed June 4, 2015.

CHAPTER 7: STATUTORY AND EXECUTIVE ORDER ANALYSIS

7.1 Executive Order 12866: Regulatory Planning and Review, and Executive Order 13563: Improving Regulation and Regulatory Review

This final action is an economically significant regulatory action that was submitted to the OMB for review. Any changes made in response to OMB recommendations have been documented in the docket. The EPA prepared an analysis of the potential costs and benefits associated with this action.

Consistent with Executive Order 12866 and Executive Order 13563, the EPA estimated the costs and benefits for illustrative plan approaches of implementing the guidelines. The final rule establishes: 1) state-specific carbon dioxide (CO₂) goals reflecting CO₂ emission performance rates for two source categories of existing fossil fuel-fired EGUs, fossil fuel-fired electric utility steam generating units and stationary combustion turbines, and 2) guidelines for the development, submittal and implementation of state plans that establish emission standards or other measures to implement the CO₂ emission performance rates. Actions taken to comply with the guidelines will also reduce the emissions of directly-emitted PM_{2.5}, SO₂ and NO_x. The benefits associated with these PM_{2.5}, SO₂ and NO_x reductions are referred to as co-benefits, as these reductions are not the primary objective of this rule.

The EPA has used the social cost of carbon estimates presented in the *Technical Support Document: Technical Update of the Social Cost of Carbon for Regulatory Impact Analysis Under Executive Order 12866 (May 2013, Revised July 2015)* (“current TSD”) to analyze CO₂ climate impacts of this rulemaking. We refer to these estimates, which were developed by the U.S. government, as “SC-CO₂ estimates.” The SC-CO₂ is an estimate of the monetary value of impacts associated with a marginal change in CO₂ emissions in a given year. The four SC-CO₂ estimates are associated with different discount rates (model average at 2.5 percent discount rate, 3 percent, and 5 percent; 95th percentile at 3 percent), and each increases over time. In this summary, the EPA provides the estimate of climate benefits associated with the SC-CO₂ value deemed to be central in the current TSD: the model average at 3 percent discount rate.

In the final emission guidelines, the EPA has translated the source category-specific CO₂ emission performance rates into equivalent state-level rate-based and mass-based CO₂ goals in

order to maximize the range of choices that states will have in developing their plans. Because of the range of choices available to states and the lack of *a priori* knowledge about the specific choices states will make in response to the final goals, the Regulatory Impact Analysis (RIA) for this rule analyzed two implementation scenarios designed to achieve these goals, which we term the “rate-based” illustrative plan approach and the “mass-based” illustrative plan approach.

It is very important to note that the differences between the analytical results for the rate-based and mass-based illustrative plan approaches presented in the RIA may not be indicative of likely differences between the approaches if implemented by states and affected EGUs in response to the final guidelines. Rather, the two sets of analyses are intended to illustrate two contrasting, stylized approaches to accomplish the emission performance rates finalized in the Clean Power Plan Final Rule. In other words, if one approach performs better than the other on a given metric during a given time period, this does not imply this will apply in all instances in all time periods in all places.

The EPA estimates that, in 2020, the final guidelines will yield monetized climate benefits (in 2011\$) of approximately \$2.8 billion for the rate-based approach and \$3.3 billion for the mass-based approach (3 percent model average). For the rate-based approach, the air pollution health co-benefits in 2020 are estimated to be \$0.7 billion to \$1.8 billion (2011\$) for a 3 percent discount rate and \$0.64 billion to \$1.7 billion (2011\$) for a 7 percent discount rate. For the mass-based approach, the air pollution health co-benefits in 2020 are estimated to be \$2.0 billion to \$4.8 billion (2011\$) for a 3 percent discount rate and \$1.8 billion to \$4.4 billion (2011\$) for a 7 percent discount rate. The annual, illustrative compliance costs estimated by IPM and inclusive of demand-side energy efficiency program and participant costs and MRR costs in 2020, are approximately \$2.5 billion for the rate-based approach and \$1.4 billion for the mass-based approach (2011\$). The quantified net benefits (the difference between monetized benefits and compliance costs) in 2020 are estimated to range from \$1.0 billion to \$2.1 billion (2011\$) for the rate-based approach and from \$3.9 billion to 6.7 billion (2011\$) for the mass-based approach, using a 3 percent discount rate (model average).

The EPA estimates that, in 2025, the final guidelines will yield monetized climate benefits (in 2011\$) of approximately \$10 billion for the rate-based approach and \$12 billion for the mass-based approach (3 percent model average). For the rate-based approach, the air

pollution health co-benefits in 2025 are estimated to be \$7.4 billion to \$18 billion (2011\$) for a 3 percent discount rate and \$6.7 billion to \$16 billion (2011\$) for a 7 percent discount rate. For the mass-based approach, the air pollution health co-benefits in 2025 are estimated to be \$7.1 billion to \$17 billion (2011\$) for a 3 percent discount rate and \$6.5 billion to \$16 billion (2011\$) for a 7 percent discount rate. The annual, illustrative compliance costs estimated by IPM and inclusive of demand side energy efficiency program and participant costs and MRR costs in 2025, are approximately \$1.0 billion for the rate-based approach and \$3.0 billion for the mass-based approach (2011\$). The quantified net benefits (the difference between monetized benefits and compliance costs) in 2025 are estimated to range from \$17 billion to \$27 billion (2011\$) for the rate-based approach and \$16 billion to \$26 billion (2011\$) for the mass-based approach, using a 3 percent discount rate (model average).

The EPA estimates that, in 2030, the final guidelines will yield monetized climate benefits (in 2011\$) of approximately \$20 billion for the rate-based approach and \$20 billion for the mass-based approach (3 percent model average). For the rate-based approach, the air pollution health co-benefits in 2030 are estimated to be \$14 billion to \$34 billion (2011\$) for a 3 percent discount rate and \$13 billion to \$31 billion (2011\$) for a 7 percent discount rate. For the mass-based approach, the air pollution health co-benefits in 2030 are estimated to be \$12 billion to \$28 billion (2011\$) for a 3 percent discount rate and \$11 billion to \$26 billion (2011\$) for a 7 percent discount rate. The annual, illustrative compliance costs estimated by IPM and inclusive of demand side energy efficiency program and participant costs and MRR costs in 2030, are approximately \$8.4 billion for the rate-based approach and \$5.1 billion for the mass-based approach (2011\$). The quantified net benefits (the difference between monetized benefits and compliance costs) in 2030 are estimated to range from \$26 billion to \$45 billion (2011\$) for the rate-based approach and from \$26 billion to \$43 billion (2011\$) for the mass-based approach, using a 3 percent discount rate (model average).

Table 7-1 and 7-2 provide the estimates of the climate benefits, health co-benefits, compliance costs and net benefits of the final emission guidelines for rate-based and mass-based illustrative plan approaches, respectively.

Table 7-1. Monetized Benefits, Compliance Costs, and Net Benefits Under the Rate-based Illustrative Plan Approach (billions of 2011\$)^a

	Rate-Based Approach					
	2020		2025		2030	
Climate Benefits^b						
5% discount rate	\$0.80		\$3.1		\$6.4	
3% discount rate	\$2.8		\$10		\$20	
2.5% discount rate	\$4.1		\$15		\$29	
95th percentile at 3% discount rate	\$8.2		\$31		\$61	
	<u>Air Quality Co-benefits Discount Rate</u>					
	3%	7%	3%	7%	3%	7%
Air Quality Health Co-benefits^c	\$0.7 to \$1.8	\$0.6 to \$1.7	\$7.4 to \$18	\$6.7 to \$16	\$14 to \$34	\$13 to \$31
Compliance Costs^d	\$2.5		\$1.0		\$8.4	
Net Benefits^e	\$1.0 to \$2.1	\$1.0 to \$2.0	\$17 to \$27	\$16 to \$25	\$26 to \$45	\$25 to \$43
Non-Monetized Benefits	Non-monetized climate benefits Reductions in exposure to ambient NO ₂ and SO ₂ Reductions in mercury deposition Ecosystem benefits associated with reductions in emissions of NO _x , SO ₂ , PM, and mercury Visibility impairment					

^a All are rounded to two significant figures, so figures may not sum.

^b The climate benefit estimate in this summary table reflects global impacts from CO₂ emission changes and does not account for changes in non-CO₂ GHG emissions. Also, different discount rates are applied to SC-CO₂ than to the other estimates because CO₂ emissions are long-lived and subsequent damages occur over many years. The benefit estimates in this table are based on the average SC-CO₂ estimated for a 3 percent discount rate, however we emphasize the importance and value of considering the full range of SC-CO₂ values. As shown in the RIA, climate benefits are also estimated using the other three SC-CO₂ estimates (model average at 2.5 percent discount rate, 3 percent, and 5 percent; 95th percentile at 3 percent). The SC-CO₂ estimates are year-specific and increase over time.

^c The air quality health co-benefits reflect reduced exposure to PM_{2.5} and ozone associated with emission reductions of directly emitted PM_{2.5}, SO₂ and NO_x. The range reflects the use of concentration-response functions from different epidemiology studies. The reduction in premature fatalities each year accounts for over 98 percent of total monetized co-benefits from PM_{2.5} and ozone. These models assume that all fine particles, regardless of their chemical composition, are equally potent in causing premature mortality because the scientific evidence is not yet sufficient to allow differentiation of effect estimates by particle type. Estimates in the table are presented for three analytical years with air quality co-benefits calculated using two discount rates. The estimates of co-benefits are annual estimates in each of the analytical years, reflecting discounting of mortality benefits over the cessation lag between changes in PM_{2.5} concentrations and changes in risks of premature death (see RIA Chapter 4 for more details), and discounting of morbidity benefits due to the multiple years of costs associated with some illnesses. The estimates are not the present value of the benefits of the rule over the full compliance period.

^d Total costs are approximated by the illustrative compliance costs estimated using the Integrated Planning Model for the final emission guidelines and a discount rate of approximately 5 percent. This estimate also includes monitoring, recordkeeping, and reporting costs and demand-side energy efficiency program and participant costs.

^e The estimates of net benefits in this summary table are calculated using the global SC-CO₂ at a 3 percent discount rate (model average). The RIA includes combined climate and health estimates based on additional discount rates.

Table 7-2. Monetized Benefits, Compliance Costs, and Net Benefits under the Mass-based Illustrative Plan Approach (billions of 2011\$)^a

	Mass-Based Approach					
	2020		2025		2030	
Climate Benefits^b						
5% discount rate	\$0.9		\$3.6		\$6.4	
3% discount rate	\$3.3		\$12		\$20	
2.5% discount rate	\$4.9		\$17		\$29	
95th percentile at 3% discount rate	\$9.6		\$35		\$60	
	<u>Air Quality Co-benefits Discount Rate</u>					
	3%	7%	3%	7%	3%	7%
Air Quality Health Co-benefits^c	\$2.0 to \$4.8	\$1.8 to \$4.4	\$7 to \$17	\$7 to \$16	\$12 to \$28	\$11 to \$26
Compliance Costs^d	\$1.4		\$3.0		\$5.1	
Net Benefits^e	\$3.9 to \$6.7	\$3.7 to \$6.3	\$16 to \$26	\$15 to \$24	\$26 to \$43	\$25 to \$40
Non-Monetized Benefits	Non-monetized climate benefits Reductions in exposure to ambient NO ₂ and SO ₂ Reductions in mercury deposition Ecosystem benefits associated with reductions in emissions of NO _x , SO ₂ , PM, and mercury Visibility improvement					

^a All are rounded to two significant figures, so figures may not sum.

^b The climate benefit estimate in this summary table reflects global impacts from CO₂ emission changes and does not account for changes in non-CO₂ GHG emissions. Also, different discount rates are applied to SC-CO₂ than to the other estimates because CO₂ emissions are long-lived and subsequent damages occur over many years. The benefit estimates in this table are based on the average SC-CO₂ estimated for a 3 percent discount rate, however we emphasize the importance and value of considering the full range of SC-CO₂ values. As shown in the RIA, climate benefits are also estimated using the other three SC-CO₂ estimates (model average at 2.5 percent discount rate, 3 percent, and 5 percent; 95th percentile at 3 percent). The SC-CO₂ estimates are year-specific and increase over time.

^c The air quality health co-benefits reflect reduced exposure to PM_{2.5} and ozone associated with emission reductions of directly emitted PM_{2.5}, SO₂ and NO_x. The range reflects the use of concentration-response functions from different epidemiology studies. The reduction in premature fatalities each year accounts for over 98 percent of total monetized co-benefits from PM_{2.5} and ozone. These models assume that all fine particles, regardless of their chemical composition, are equally potent in causing premature mortality because the scientific evidence is not yet sufficient to allow differentiation of effect estimates by particle type. Estimates in the table are presented for three analytical years with air quality co-benefits calculated using two discount rates. The estimates of co-benefits are annual estimates in each of the analytical years, reflecting discounting of mortality benefits over the cessation lag between changes in PM_{2.5} concentrations and changes in risks of premature death (see RIA Chapter 4 for more details), and discounting of morbidity benefits due to the multiple years of costs associated with some illnesses. The estimates are not the present value of the benefits of the rule over the full compliance period.

^d Total costs are approximated by the illustrative compliance costs estimated using the Integrated Planning Model for the final emission guidelines and a discount rate of approximately 5 percent. This estimate also includes monitoring, recordkeeping, and reporting costs and demand-side energy efficiency program and participant costs.

^e The estimates of net benefits in this summary table are calculated using the global SC-CO₂ at a 3 percent discount rate (model average). The RIA includes combined climate and health estimates based on additional discount rates.

There are additional important benefits that the EPA could not monetize. Due to current data and modeling limitations, our estimates of the benefits from reducing CO₂ emissions do not include important impacts like ocean acidification or potential tipping points in natural or managed ecosystems. Unquantified benefits also include climate benefits from reducing emissions of non-CO₂ greenhouse gases (e.g., nitrous oxide and methane) and co-benefits from reducing direct exposure to SO₂, NO_x and hazardous air pollutants (e.g., mercury and hydrogen chloride), as well as from reducing ecosystem effects and visibility impairment. Based upon the foregoing discussion, it remains clear that the benefits of this final action are substantial, and far exceed the costs. Additional details on benefits, costs, and net benefits estimates are provided in this RIA.

7.2 Paperwork Reduction Act (PRA)

The information collection requirements in this rule have been submitted for approval to OMB under the PRA. The Information Collection Request (ICR) document prepared by the EPA has been assigned the EPA ICR number 2503.02. You can find a copy of the ICR in the docket for this rule, and it is briefly summarized here. The information collection requirements are not enforceable until OMB approves them.

This rule does not directly impose specific requirements on EGUs located in states or areas of Indian country. The rule also does not impose specific requirements on tribal governments that have affected EGUs located in their area of Indian country. For areas of Indian country, the rule establishes CO₂ emission performance goals that could be addressed through either tribal or federal plans. A tribe would have the opportunity under the Tribal Authority Rule (TAR), but not the obligation, to apply to the EPA for Treatment as State (TAS) for purposes of a CAA section 111(d) plan and, if approved by the EPA, to establish a CAA section 111(d) plan for its area of Indian country. To date, no tribe has requested or obtained TAS eligibility for purposes of a CAA section 111(d) plan. For areas of Indian country with affected EGUs where a tribe has not applied for TAS and submitted any needed plan, if the EPA determines that a CAA section 111(d) plan is necessary or appropriate, the EPA would have the responsibility to establish the plans. Because tribes are not required to implement section 111(d) plans and because no tribe has yet sought TAS eligibility for this purpose, this action is not anticipated to

impose any information collection burden on tribal governments over the 3-year period covered by this ICR.

This rule does impose specific requirements on state governments with affected EGUs. The information collection requirements are based on the recordkeeping and reporting burden associated with developing, implementing, and enforcing a plan to limit CO₂ emissions from existing sources in the utility power sector. These recordkeeping and reporting requirements are specifically authorized by CAA section 114 (42 U.S.C. 7414). All information submitted to the EPA pursuant to the recordkeeping and reporting requirements for which a claim of confidentiality is made is safeguarded according to agency policies set forth in 40 CFR part 2, subpart B.

The annual burden for this collection of information for the states (averaged over the first 3 years following promulgation) is estimated to be a range of 505,000 to 821,000 hours at a total annual labor cost of \$35.8 to \$58.1 million. The lower bound estimate reflects the assumption that some states already have energy efficiency and renewable energy programs in place. The higher bound estimate reflects the overly-conservative assumption that no states have energy efficiency and renewable energy programs in place.

The total annual burden for the federal government associated with the state collection of information (averaged over the first 3 years following promulgation) is estimated to be 54,000 hours at a total annual labor cost of \$3.00 million. Burden is defined at 5 CFR 1320.3(b).

An agency may not conduct or sponsor, and a person is not required to respond to, a collection of information unless it displays a currently valid OMB control number. The OMB control numbers for the EPA's regulations in 40 CFR are listed in 40 CFR part 9. When OMB approves this ICR, the agency will announce that approval in the *Federal Register* and publish a technical amendment to 40 CFR part 9 to display the OMB control number for the approved information collection activities contained in this final rule.

7.3 Regulatory Flexibility Act (RFA)

The EPA certifies that this action will not have a significant economic impact on a substantial number of small entities under the RFA. This action will not impose any requirements on small entities. Specifically, emission guidelines established under CAA section

111(d) do not impose any requirements on regulated entities and, thus, will not have a significant economic impact upon a substantial number of small entities. After emission guidelines are promulgated, states establish emission standards on existing sources, and it is those requirements that could potentially impact small entities.

Our analysis here is consistent with the analysis of the analogous situation arising when the EPA establishes NAAQS, which do not impose any requirements on regulated entities. As here, any impact of a NAAQS on small entities would only arise when states take subsequent action to maintain and/or achieve the NAAQS through their state implementation plans. See *American Trucking Assoc. v. EPA*, 175 F.3d 1029, 1043-45 (D.C. Cir. 1999) (NAAQS do not have significant impacts upon small entities because NAAQS themselves impose no regulations upon small entities).

Nevertheless, the EPA is aware that there is substantial interest in the rule among small entities and, as detailed in section III.A of the preamble to the proposed carbon pollution emission guidelines for existing EGUs (79 FR 34845-34847; June 18, 2014) and in section II.D of the preamble to the proposed carbon pollution emission guidelines for existing EGUs in Indian Country and U.S. Territories (79 FR 65489; November 4, 2014), has conducted an unprecedented amount of stakeholder outreach. As part of that outreach, agency officials participated in many meetings with individual utilities and electric utility associations, as well as industry leaders and trade association representatives from various industries. While formulating the provisions of the rule, the EPA considered the input provided over the course of the stakeholder outreach as well as the input provided in the many public comments.

7.4 Unfunded Mandates Reform Act (UMRA)

This action does not contain an unfunded mandate of \$100 million or more as described in UMRA, 2 U.S.C. 1531–1538, and does not significantly or uniquely affect small governments. The emission guidelines do not impose any direct compliance requirements on EGUs located in states or areas of Indian country. As explained in section XII.B above, the rule also does not impose specific requirements on tribal governments that have affected EGUs located in their area of Indian country. The rule does impose specific requirements on state governments that have affected EGUs. Specifically, states are required to develop plans to implement the guidelines under CAA section 111(d) for affected EGUs. The burden for states to develop CAA section

111(d) plans in the 3-year period following promulgation of the rule was estimated and is listed in section XII.B above, but this burden is estimated to be below \$100 million in any one year. Thus, this rule is not subject to the requirements of section 202 or section 205 of the UMRA.

This rule is also not subject to the requirements of section 203 of UMRA because it contains no regulatory requirements that might significantly or uniquely affect small governments. Specifically, the state governments to which rule requirements apply are not considered small governments.

In light of the interest among governmental entities, the EPA conducted outreach with national organizations representing state and local elected officials and tribal governmental entities while formulating the provisions of this rule. Sections III.A and XI.F of the preamble to the proposed carbon pollution emission guidelines for existing EGUs (79 FR 34845-34847; June 18, 2014) and sections II.D and VI.F of the preamble to the proposed carbon pollution emission guidelines for existing EGUs in areas of Indian Country and U.S. Territories (79 FR 65489; November 4, 2014) describes the extensive stakeholder outreach the EPA has conducted on setting emission guidelines for existing EGUs. The EPA considered the input provided over the course of the stakeholder outreach as well as the input provided in the many public comments when developing the provisions of these emission guidelines.

7.5 Executive Order 13132: Federalism

The EPA has concluded that this action may have federalism implications, pursuant to agency policy for implementing the Order, because it imposes substantial direct compliance costs on state or local governments, and the federal government will not provide the funds necessary to pay those costs. As discussed in the Supporting Statement found in the docket for this rulemaking, the development of state plans will entail many hours of staff time to develop and coordinate programs for compliance with the rule, as well as time to work with state legislatures as appropriate, to develop a plan submittal. Consistent with this determination, the EPA provides the following federalism summary impact statement.

The EPA consulted with state and local officials early in the process of developing the proposed action to permit them to have meaningful and timely input into its development. As described in the Federalism discussion in the preamble to the proposed standards of performance for GHG emissions from new EGUs (79 FR 1501; January 8, 2014), the EPA consulted with

state and local officials in the process of developing the proposed standards for newly constructed EGUs. This outreach addressed planned actions for new, reconstructed, modified and existing sources. The EPA invited the following 10 national organizations representing state and local elected officials to a meeting on April 12, 2011, in Washington DC: (1) National Governors Association; (2) National Conference of State Legislatures, (3) Council of State Governments, (4) National League of Cities, (5) U.S. Conference of Mayors, (6) National Association of Counties, (7) International City/County Management Association, (8) National Association of Towns and Townships, (9) County Executives of America, and (10) Environmental Council of States. The National Association of Clean Air Agencies also participated. On February 26, 2014, the EPA re-engaged with those governmental entities to provide a pre-proposal update on the emission guidelines for existing EGUs and emission standards for modified and reconstructed EGUs. In addition, as described in section III.A of the preamble to the proposed carbon pollution emission guidelines for existing EGUs (79 FR 34845-34847; June 18, 2014), extensive stakeholder outreach conducted by the EPA allowed state leaders, including governors, state attorneys general, environmental commissioners, energy officers, public utility commissioners, and air directors, opportunities to engage with EPA officials and provide input regarding reducing carbon pollution from power plants.

In the spirit of Executive Order 13132, and consistent with the EPA's policy to promote communications between the EPA and state and local governments, the EPA specifically solicited comment on the proposed action from state and local officials. The EPA received comments from over 400 entities representing state and local governments.

Several themes emerged from state and local government comments. Commenters raised concerns with the building blocks that comprise the best system of emission reduction (BSER), including the stringency of the building blocks, and the timing of achieving interim CO₂ levels. They also identified the potential for electric system reliability issues and stranded assets due to the proposed timeframe for plan submittals and CO₂ emission reductions. In addition, states commented on state plan development and implementation topics, including state plan approaches, early actions, trading programs, interstate crediting for RE, and EPA guidance and outreach.

Commenters identified overarching concerns regarding the stringency of the CO₂ goals and the timeframe for achieving reductions that encompassed the building blocks, the BSER, and associated timing for achievement of interim CO₂ levels. State commenters, in particular, identified changes to the stringency of the building blocks, concerns with the timeframe over which reductions must be achieved, and concerns with the approaches and measures used for the BSER. For the final rule, in response to stakeholder comments, the EPA has made refinements to the building blocks, the period of time over which measures are deployed, and the stringency of emission limitations that those measures can achieve in a practical and reasonable cost way. The final BSER reflects those refinements.

To many commenters, the proposal's 2020 compliance date, together with the stringency of the interim CO₂ goal, bore significant reliability implications. In this final rule, the agency is addressing those concerns via adjustments to the compliance timeframe (an 8-year interim period that begins in 2022) and to the approach for meeting interim CO₂ emission performance rates (a glide path separated into three steps, 2022-2024, 2025-2027, and 2028-2029), as well as a more gradual phase in of the emission reduction expectations. These adjustments provide more time for planning, consultation and decision making in the formulation of state plans and in EGUs' choices of compliance strategies. The final rule also retains flexibilities presented in the proposal and offers additional opportunities, including opportunities for trading within and between states, and other multi-state compliance approaches that will further support electric system reliability. The EPA is also requiring states to consult with relevant ISOs/RTOs and/or planning/reliability authorities during plan development, and to document recommendations in their plans – and is providing the time for states to do so. Even with this foundation of flexibility in place, these final guidelines further provide states with the option of proposing amendments to approved plans in the event that unanticipated and significant reliability challenges arise.

Commenters provided compelling information indicating that it will take longer than the agency initially anticipated to adjust investments and achieve interim CO₂ reductions. Recognizing this, as well as the urgent need for actions to reduce GHG emissions, the EPA is requiring states to frame an initial plan by August 31, 2016, and is allowing states two additional years to submit a final plan, if justified (to be submitted by August 31, 2018).

States commented on state plan development and implementation topics that included state plan approaches, early actions being taken into account, trading programs being allowed, interstate crediting for RE being allowed, and guidance and outreach being provided by the EPA. For the state plan approaches, commenters expressed concerns with the proposed “portfolio approach” for state plans, including concerns with enforceability of requirements, and identified a “state commitment approach” with backstop measures as an option for state plans. In this final rule, in response to stakeholder comments on the portfolio approach and alternative approaches, the EPA is finalizing a “state measures” approach that includes a requirement for the inclusion of backstop measures.

State commenters supported providing incentives for states and utilities to deploy CO₂-reducing investments, such as RE and demand-side EE measures, as early as possible. The EPA recognizes the value of such early actions, and in this final rule is establishing a state-federal Clean Energy Incentive Program to reward investment in certain RE and demand-side EE projects that commence construction after the effective date of this rule and that generate MWh or reduce end-use energy demand during 2020 and 2021.

Many state commenters supported the use of mass-based and rate-based emission trading programs in state plans, including interstate emission trading programs. The EPA also received a number of comments from states and stakeholders about the value of EPA support in developing and/or administering tracking systems to support state administration of rate-based and mass-based emission trading programs. In this final rule, states may use trading or averaging approaches and technologies or strategies that are not explicitly mentioned in any of the three building blocks as part of their overall plans, as long as they achieve the required emission reductions from affected fossil-fuel-fired EGUs. In addition, in response to concerns from states and power companies that the need for up-front interstate cooperation in developing multi-state plans could inhibit the development of interstate programs that could lower cost, the final rule provides additional options to allow individual EGUs to use creditable out-of-state reductions to achieve required CO₂ reductions, without the need for up-front interstate agreements. The EPA is committed to working with states to provide support for tracking of emissions and allowances or credits, to help implement multi-state trading or averaging approaches.

In their comments, many states identified the need for the EPA to provide guidance, including guidance on RE and EE emission measurement and verification (EM&V), and to maintain regular contact/forums with states throughout the implementation process. To provide state and local governments and other stakeholders with an understanding of the rule requirements, and to provide efficiencies where possible and reduce the cost and administrative burden, the EPA will continue outreach throughout the plan development and submittal process. Outreach will include opportunities for states to participate in briefings, teleconferences, and meetings about the final rule. The EPA's 10 regional offices will continue to be the entry point for states and tribes to ask technical and policy questions. The agency will host (or partner with appropriate groups to co-host) a number of webinars about various components of the final rule during the first two months after the final rule is issued. The EPA will use information from this outreach process to inform the training and other tools that will be of most use to the states and tribes that are implementing the final rule. The EPA expects to issue guidance on specific topics, including evaluation, measurement and verification (EM&V) for RE and demand-side EE, state-community engagement, and resources and financial assistance for RE and demand-side EE. As guidance documents, tools, templates and other resources become available, the EPA, in consultation with the U.S. Department of Energy and other federal agencies, will continue to make these resources available via a dedicated website.

A list of the state and local government commenters has been provided to OMB and has been placed in the docket for this rulemaking. In addition, the detailed response to comments from these entities is contained in the EPA's response to comments document on this final rulemaking, which has also been placed in the docket for this rulemaking.

As required by section 8(a) of Executive Order 13132, the EPA included a certification from its Federalism Official stating that the EPA had met the Executive Order's requirements in a meaningful and timely manner when it sent the draft of this final action to OMB for review pursuant to Executive Order 12866. A copy of the certification is included in the public version of the official record for this final action.

7.6 Executive Order 13175: Consultation and Coordination with Indian Tribal Governments

This action has tribal implications. However, it will neither impose substantial direct compliance costs on federally recognized tribal governments, nor preempt tribal law. Tribes are not required to develop or adopt CAA programs, but they may apply to the EPA for treatment in a manner similar to states (TAS) and, if approved, do so. As a result, tribes are not required to develop plans to implement the guidelines under CAA section 111(d) for affected EGUs in their areas of Indian country. To the extent that a tribal government seeks and attains TAS status for that purpose, these emission guidelines would require that planning requirements be met and emission management implementation plans be executed by the tribes. The EPA notes that this rule does not directly impose specific requirements on affected EGUs, including those located in areas of Indian country, but provides guidance to any tribe approved by the EPA to address CO₂ emissions from EGUs subject to section 111(d) of the CAA. The EPA also notes that none of the affected EGUs are owned or operated by tribal governments.

As described in sections III.A and XI.F of the preamble to the proposed carbon pollution emission guidelines for existing EGUs (79 FR 34845-34847; June 18, 2014) and sections II.D and VI.F of the preamble to the proposed carbon pollution emission guidelines for existing EGUs in Indian Country and U.S. Territories (79 FR 65489; November 4, 2014), the rule was developed after extensive and vigorous outreach to tribal governments. These tribes expressed varied points of view. Some tribes raised concerns about the impacts of the regulations on EGUs located in their areas of Indian country and the subsequent impact on jobs and revenue for their tribes. Other tribes expressed concern about the impact the regulations would have on the cost of water covered under treaty to their communities as a result of increased costs to the EGU that provide energy to transport the water to the tribes. Other tribes raised concerns about the impacts of climate change on their communities, resources, ways of life and hunting and treaty rights. The tribes were also interested in the scope of the guidelines being considered by the agency (e.g., over what time period, relationship to state and multi-state plans) and how tribes will participate in these planning activities.

The EPA consulted with tribal officials under the EPA Policy on Consultation and Coordination with Indian Tribes early in the process of developing this action to permit them to have meaningful and timely input into its development. A summary of that consultation follows.

Prior to issuing the supplemental proposal on November 4, 2014, the EPA consulted with tribes as follows. The EPA held a consultation with the Ute Tribe, the Crow Nation, and the Mandan, Hidatsa, Arikara (MHA) Nation on July 18, 2014. On August 22, 2014, the EPA held a consultation with the Fort Mojave Tribe. On September 15, 2014, the EPA held a consultation with the Navajo Nation. The Navajo Nation sent a letter to the EPA on September 18, 2014, summarizing the information presented at the consultation and the Navajo Nation's position on the supplemental proposal. One issue raised by tribal officials was the potential impacts of the June 18, 2014 proposal and the supplemental proposal on tribes with budgets that are dependent on revenue from coal mines and power plants, as well as employment at the mines and power plants. The tribes noted the high unemployment rates and lack of access to basic services on their lands. Tribal officials also asked whether the rules will have any impact on a tribe's ability to seek TAS. Tribal officials also expressed interest in agency actions with regard to facilitating power plant compliance with regulatory requirements. The Navajo Nation made the following recommendations in their letter of September 18, 2014: the Navajo Nation supports a mass-based CO₂ emission standard based on the highest historical CO₂ emissions since 1996; the Navajo Nation requests that the EPA grant the Navajo Nation carbon credits and that the Navajo Nation retains ownership and control of such credits; building block 2 is not appropriate for the Navajo Nation because there are no NGCC plants located on the Navajo Nation; building block 3 is not appropriate for the Navajo Nation because the Navajo people already receive virtually all of their electricity from carbon-free sources (mostly hydroelectric power) and their use of electricity is negligible compared to the generation at the power plants; building block 4 is not appropriate for the Navajo Nation because of the inadequate access to electricity, and the goal should allow for an increase in energy consumption on the Navajo Nation; the supplemental proposal should consider the useful life of the power plants located on the Navajo Nation; and the supplemental proposal should clarify that RE projects located within the Navajo Nation that provide electricity outside the Navajo Nation should be counted toward meeting the relevant state's RE goals under the Clean Power Plan.

After issuing the supplemental proposal, the EPA held additional consultation with tribes. On November 18, 2014, the EPA held consultations with the following tribes: Fort McDowell Yavapai Nation, Fort Mojave Tribe, Hopi Tribe, Navajo Nation, and Ak-Chin Indian Community. A consultation with the Ute Indian Tribe of the Uintah and Ouray Reservation was

held on December 16, 2014 and with the Gila River Indian Community on January 15, 2015. The Navajo Nation reiterated the concerns raised during the previous consultation. Several tribes also again indicated that they wanted to ensure they would be included in the development of any tribal or federal plans for areas of Indian country. The Fort Mojave Tribe and the Navajo Nation expressed concern with using data from 2012 as the basis for the goal for their areas of Indian country; in their view, that year was not representative for the affected EGU. On April 28, 2015, the EPA held an additional consultation with the Navajo Nation. The issues raised by the Navajo Nation during the consultation included whether the EPA has the authority to set less stringent standards on a case-by-case basis, and a suggested “parity glide path” that would account and adjust for the very low electricity usage by the Navajo Nation and promote Navajo Nation economic growth and demand. Furthermore, on July 7, 2015 the EPA conducted an additional consultation with the Navajo Nation. One of the goals of the consultation was for the new government of the Navajo Nation to deepen their understanding of the rulemaking. The questions raised by the nation had to do with goal setting and carbon credits, the timing of the rulemaking, and the proposed federal plan. Additionally, on July 14, 2015 the EPA conducted an additional consultation with the Fort Mojave Tribe. The Fort Mojave tribes expressed concerns that 2012 is not a representative year, that natural gas-fired combined cycle power plants should be treated differently from coal-fired power plants, and that the proposed goal for Fort Mojave was not appropriate. Additionally, they also expressed interest in being engaged in the federal plan process. Responses to these comments and others received are available in the Response to Comment Document that is in the docket for this rulemaking. As required by section 7(a), the EPA’s Tribal Consultation Official has certified that the requirements of the executive order have been met in a meaningful and timely manner. A copy of the certification is included in the docket for this action.

7.7 Executive Order 13045: Protection of Children from Environmental Health Risks and Safety Risks

This action is subject to Executive Order 13045 (62 FR 19885, April 23, 1997) because it is an economically significant regulatory action as defined by Executive Order 12866, and the EPA believes that the environmental health or safety risk addressed by this action has a disproportionate effect on children. Accordingly, the agency has evaluated the environmental health and welfare effects of climate change on children.

CO₂ is a potent greenhouse gas that contributes to climate change and is emitted in significant quantities by fossil fuel-fired power plants. The EPA believes that the CO₂ emission reductions resulting from implementation of these final guidelines, as well as substantial ozone and PM_{2.5} emission reductions as a co-benefit, will further improve children's health.

The assessment literature cited in the EPA's 2009 Endangerment Finding concluded that certain populations and lifestages, including children, the elderly, and the poor, are most vulnerable to climate-related health effects. The assessment literature since 2009 strengthens these conclusions by providing more detailed findings regarding these groups' vulnerabilities and the projected impacts they may experience.

These assessments describe how children's unique physiological and developmental factors contribute to making them particularly vulnerable to climate change. Impacts to children are expected from heat waves, air pollution, infectious and waterborne illnesses, and mental health effects resulting from extreme weather events. In addition, children are among those especially susceptible to most allergic diseases, as well as health effects associated with heat waves, storms, and floods. Additional health concerns may arise in low income households, especially those with children, if climate change reduces food availability and increases prices, leading to food insecurity within households.

7.8 Executive Order 13211: Actions Concerning Regulations That Significantly Affect Energy Supply, Distribution, or Use

This action, which is a significant regulatory action under EO 12866, is likely to have a significant effect on the supply, distribution, or use of energy. The EPA has prepared a Statement of Energy Effects for this action as follows. We estimate a 1 to 2 percent change in retail electricity prices on average across the contiguous U.S. in 2025, and a 22 to 23 percent reduction in coal-fired electricity generation as a result of this rule. The EPA projects that utility power sector delivered natural gas prices will increase by up to 2.5 percent in 2030. For more information on the estimated energy effects, please refer to the economic impact analysis for this proposal. The analysis is available in the RIA, which is in the public docket.

7.9 National Technology Transfer and Advancement Act (NTTAA)

This rulemaking does not involve technical standards.

7.10 Executive Order 12898: Federal Actions to Address Environmental Justice in Minority Populations and Low-Income Populations

Executive Order 12898 (59 FR 7629; February 16, 1994) establishes federal executive policy on environmental justice. Its main provision directs federal agencies, to the greatest extent practicable and permitted by law, to make environmental justice part of their mission by identifying and addressing, as appropriate, disproportionately high and adverse human health or environmental effects of their programs, policies, and activities on minority populations and low-income populations in the U.S. The EPA defines environmental justice as the fair treatment and meaningful involvement of all people regardless of race, color, national origin, or income with respect to the development, implementation, and enforcement of environmental laws, regulations, and policies. The EPA has this goal for all communities and persons across this Nation. It will be achieved when everyone enjoys the same degree of protection from environmental and health hazards and equal access to the decision-making process to have a healthy environment in which to live, learn, and work.

Leading up to this rulemaking the EPA summarized the public health and welfare effects of GHG emissions in its 2009 Endangerment Finding. See, section VIII.A of this preamble where the EPA summarizes the public health and welfare impacts from GHG emissions that were detailed in the 2009 Endangerment Finding under CAA section 202(a)(1).¹⁹⁵ As part of the Endangerment Finding, the Administrator considered climate change risks to minority populations and low-income populations, finding that certain parts of the population may be especially vulnerable based on their characteristics or circumstances. Populations that were found to be particularly vulnerable to climate change risks include the poor, the elderly, the very young, those already in poor health, the disabled, those living alone, and/or indigenous populations dependent on one or a few resources. See sections XII.F and XII.G, above, where the EPA discusses Consultation and Coordination with Tribal Governments and Protection of Children. The Administrator placed weight on the fact that certain groups, including children, the elderly, and the poor, are most vulnerable to climate-related health effects.

¹⁹⁵ “Endangerment and Cause or Contribute Findings for Greenhouse Gases Under Section 202(a) of the Clean Air Act,” 74 Fed. Reg. 66,496 (Dec. 15, 2009) (“Endangerment Finding”).

The record for the 2009 Endangerment Finding summarizes the strong scientific evidence in the major assessment reports by the U.S. Global Change Research Program (USGCRP), the Intergovernmental Panel on Climate Change (IPCC), and the National Research Council (NRC) of the National Academies that the potential impacts of climate change raise environmental justice issues. These reports concluded that poor communities can be especially vulnerable to climate change impacts because they tend to have more limited adaptive capacities and are more dependent on climate-sensitive resources such as local water and food supplies. In addition, Native American tribal communities possess unique vulnerabilities to climate change, particularly those impacted by degradation of natural and cultural resources within established reservation boundaries and threats to traditional subsistence lifestyles. Tribal communities whose health, economic well-being, and cultural traditions that depend upon the natural environment will likely be affected by the degradation of ecosystem goods and services associated with climate change. The 2009 Endangerment Finding record also specifically noted that Southwest native cultures are especially vulnerable to water quality and availability impacts. Native Alaskan communities are already experiencing disruptive impacts, including coastal erosion and shifts in the range or abundance of wild species crucial to their livelihoods and well-being.

The most recent assessments continue to strengthen scientific understanding of climate change risks to minority populations and low-income populations in the United States.¹⁹⁶ The new assessment literature provides more detailed findings regarding these populations' vulnerabilities and projected impacts they may experience. In addition, the most recent assessment reports provide new information on how some communities of color (more specifically, populations defined jointly by ethnic/racial characteristics and geographic location)

¹⁹⁶ Melillo, Jerry M., Terese (T.C.) Richmond, and Gary W. Yohe, Eds., 2014: *Climate Change Impacts in the United States: The Third National Climate Assessment*. U.S. Global Change Research Program, 841 pp.

IPCC, 2014: *Climate Change 2014: Impacts, Adaptation, and Vulnerability. Part A: Global and Sectoral Aspects*. Contribution of Working Group II to the Fifth Assessment Report of the Intergovernmental Panel on Climate Change [Field, C.B., V.R. Barros, D.J. Dokken, K.J. Mach, M.D. Mastrandrea, T.E. Bilir, M. Chatterjee, K.L. Ebi, Y.O. Estrada, R.C. Genova, B. Girma, E.S. Kissel, A.N. Levy, S. MacCracken, P.R. Mastrandrea, and L.L. White (eds.)]. Cambridge University Press, 1132 pp.

IPCC, 2014: *Climate Change 2014: Impacts, Adaptation, and Vulnerability. Part B: Regional Aspects*. Contribution of Working Group II to the Fifth Assessment Report of the Intergovernmental Panel on Climate Change [Barros, V.R., C.B. Field, D.J. Dokken, M.D. Mastrandrea, K.J. Mach, T.E. Bilir, M. Chatterjee, K.L. Ebi, Y.O. Estrada, R.C. Genova, B. Girma, E.S. Kissel, A.N. Levy, S. MacCracken, P.R. Mastrandrea, and L.L. White (eds.)]. Cambridge University Press, 688 pp.

may be uniquely vulnerable to climate change health impacts in the United States. These reports find that certain climate change related impacts—including heat waves, degraded air quality, and extreme weather events—have disproportionate effects on low-income populations and some communities of color, raising environmental justice concerns. Existing health disparities and other inequities in these communities increase their vulnerability to the health effects of climate change. In addition, assessment reports also find that climate change poses particular threats to health, well-being, and ways of life of indigenous peoples in the United States.

As the scientific literature presented above and as the 2009 Endangerment Finding illustrates, low income populations and some communities of color are especially vulnerable to the health and other adverse impacts of climate change. The EPA believes that communities will benefit from this final rulemaking because this action directly addresses the impacts of climate change by limiting GHG emissions through the establishment of CO₂ emission guidelines for existing affected fossil fuel-fired EGUs.

In addition to reducing CO₂ emissions, the guidelines finalized in this rulemaking would reduce other emissions from affected EGUs that reduce generation due to higher adoption of energy efficiency and renewable energy. These emission reductions will include SO₂ and NO_x, which form ambient PM_{2.5} and ozone in the atmosphere, and hazardous air pollutants (HAP), such as mercury and hydrochloric acid. In the final rule revising the annual PM_{2.5} NAAQS,¹⁹⁷ the EPA identified low-income populations as being a vulnerable population for experiencing adverse health effects related to PM exposures. Low-income populations have been generally found to have a higher prevalence of pre-existing diseases, limited access to medical treatment, and increased nutritional deficiencies, which can increase this population's susceptibility to PM-related effects.¹⁹⁸ In areas where this rulemaking reduces exposure to PM_{2.5}, ozone, and methylmercury, low-income populations will also benefit from such emissions reductions. The RIA for this rulemaking, included in the docket for this rulemaking, provides additional

¹⁹⁷ “National Ambient Air Quality Standards for Particulate Matter, Final Rule,” 78 FR 3086 (Jan. 15, 2013).

¹⁹⁸ U.S. Environmental Protection Agency (U.S. EPA). 2009. *Integrated Science Assessment for Particulate Matter (Final Report)*. EPA-600-R-08-139F. National Center for Environmental Assessment – RTP Division. December. Available on the Internet at <<http://cfpub.epa.gov/ncea/cfm/recordisplay.cfm?deid=216546>>.

information regarding the health and ecosystem effects associated with these emission reductions.

Additionally, as outlined in the community and environmental justice considerations section IX of this preamble, the EPA has taken a number of actions to help ensure that this action will not have potential disproportionately high and adverse human health or environmental effects on overburdened communities. The EPA consulted its May 2015, *Guidance on Considering Environmental Justice During the Development of Regulatory Actions*, when determining what actions to take.¹⁹⁹ As described in the community and environmental justice considerations section of this preamble the EPA also conducted a proximity analysis, which is available in the docket of this rulemaking and is discussed in section IX. Additionally, as outlined in sections I and IX of this preamble, the EPA has engaged with communities throughout this rulemaking and has devised a robust outreach strategy for continual engagement throughout the implementation phase of this rulemaking.

7.11 Congressional Review Act (CRA)

This final action is subject to the CRA, and the EPA will submit a rule report to each House of the Congress and to the Comptroller General of the United States. This action is a “major rule” as defined by 5 U.S.C. 804(2).

¹⁹⁹ Guidance on Considering Environmental Justice During the Development of Regulatory Actions. <http://epa.gov/environmentaljustice/resources/policy/considering-ej-in-rulemaking-guide-final.pdf>. May 2015.

CHAPTER 8: COMPARISON OF BENEFITS AND COSTS

8.1 Comparison of Benefits and Costs

The benefits, costs, and net benefits of the illustrative plan scenarios are presented in this chapter of the Regulatory Impact Analysis (RIA) for the Final Carbon Pollution Emission Guidelines for Existing Stationary Sources: Electric Utility Generating Units. As discussed in Chapter 1, the EPA is establishing carbon dioxide (CO₂) emission performance rates for two source categories of existing fossil fuel-fired EGUs, fossil fuel-fired electric utility steam generating units and stationary combustion turbines. Given the flexibilities afforded states in complying with the emission guidelines, the benefits, cost and economic impacts reported in this RIA are not definitive estimates, but are instead illustrative of plan approaches states may take.

The EPA has used the social cost of carbon estimates presented in the *Technical Support Document: Technical Update of the Social Cost of Carbon for Regulatory Impact Analysis Under Executive Order 12866 (May 2013, Revised July 2015)* (“current SC-CO₂ TSD”) to analyze CO₂ climate impacts of this rulemaking.²⁰⁰ We refer to these estimates, which were developed by the U.S. government, as “SC-CO₂ estimates.” The SC-CO₂ is an estimate of the monetary value of impacts associated with a marginal change in CO₂ emissions in a given year. The four SC-CO₂ estimates are associated with different discount rates (model average at 2.5 percent discount rate, 3 percent, and 5 percent; 95th percentile at 3 percent), and each increases over time. In this comparison of benefits and costs, the EPA provides the estimate of climate benefits associated with the SC-CO₂ value deemed to be central in the current SC-CO₂ TSD (the model average at 3 percent discount rate). In addition to reducing CO₂ emissions, implementing these final emission guidelines is expected to reduce emissions of SO₂ and NO_x, which are precursors to formation of ambient PM_{2.5}, as well as directly emitted fine particles.²⁰¹ Therefore,

²⁰⁰ Docket ID EPA-HQ-OAR-2013-0495, Technical Support Document: Technical Update of the Social Cost of Carbon for Regulatory Impact Analysis Under Executive Order 12866, Interagency Working Group on Social Cost of Carbon, with participation by Council of Economic Advisers, Council on Environmental Quality, Department of Agriculture, Department of Commerce, Department of Energy, Department of Transportation, Environmental Protection Agency, National Economic Council, Office of Energy and Climate Change, Office of Management and Budget, Office of Science and Technology Policy, and Department of Treasury (May 2013, Revised July 2015). Available at: <<https://www.whitehouse.gov/sites/default/files/omb/inforeg/scc-tsd-final-july-2015.pdf>>.

²⁰¹ We did not estimate the co-benefits associated with reducing direct exposure to SO₂ and NO_x. For this RIA, we did not estimate changes in emissions of directly emitted particles. As a result, quantified PM_{2.5} related benefits are

reducing these emissions would also reduce human exposure to ambient PM_{2.5} and ozone precursors, and the associated PM_{2.5} and ozone related health effects. Tables 8-1 and 8-2 provide a summary of the climate benefits, air quality co-benefits, and costs for the illustrative rate-based and mass-based plan scenarios.

The EPA could not monetize important categories of impacts. Due to current data and modeling limitations, our estimates of the benefits from reducing CO₂ emissions do not include important impacts like ocean acidification or potential tipping points in natural or managed ecosystems. Unquantified impacts also include those associated with changes in emissions of other pollutants that affect the climate, such as methane. In addition, the analysis does not quantify co-benefits from reducing exposure to SO₂, NO_x, and hazardous air pollutants (e.g., mercury), as well as ecosystem effects and visibility impairment.

Based upon the foregoing discussion, it remains clear that this final rule's combined climate benefits and human health co-benefits associated with the reduction in other air pollutants substantially outweigh the costs for both illustrative plan scenarios.

underestimated by a relatively small amount. In the proposal RIA, the benefits from reductions in directly emitted PM_{2.5} were less than 10 percent of total monetized health co-benefits across all scenarios and years.

Table 8-1. Monetized Benefits, Costs, and Net Benefits Under the Rate-based Illustrative Plan Approach (billions of 2011\$)^a

	Rate-Based Scenario					
	2020		2025		2030	
Climate Benefits^b						
5% discount rate	\$0.80		\$3.1		\$6.4	
3% discount rate	\$2.8		\$10		\$20	
2.5% discount rate	\$4.1		\$15		\$29	
95th percentile at 3% discount rate	\$8.2		\$31		\$61	
	<u>Air Quality Co-benefits Discount Rate</u>					
	3%	7%	3%	7%	3%	7%
Air Quality Health Co-benefits^c	\$0.70 to \$1.8	\$0.64 to \$1.7	\$7.4 to \$18	\$6.7 to \$16	\$14 to \$34	\$13 to \$31
Compliance Costs^d	\$2.5		\$1.0		\$8.4	
Net Benefits^e	\$1.0 to \$2.1	\$1.0 to \$2.0	\$17 to \$27	\$16 to \$25	\$26 to \$45	\$25 to \$43
Non-Monetized Benefits	Non-monetized climate benefits Reductions in exposure to ambient NO ₂ and SO ₂ Reductions in mercury deposition Ecosystem benefits associated with reductions in emissions of NO _x , SO ₂ , PM, and mercury Visibility improvement					

^a All are rounded to two significant figures, so figures may not sum.

^b The climate benefit estimate in this summary table reflects global impacts from CO₂ emission changes and does not account for changes in non-CO₂ GHG emissions. Also, different discount rates are applied to SC-CO₂ than to the other estimates because CO₂ emissions are long-lived and subsequent damages occur over many years. The benefit estimates in this table are based on the average SC-CO₂ estimated for a 3 percent discount rate. However we emphasize the importance and value of considering the full range of SC-CO₂ values. As shown in the RIA, climate benefits are also estimated using the other three SC-CO₂ estimates (model average at 2.5 percent discount rate, 3 percent, and 5 percent; 95th percentile at 3 percent). The SC-CO₂ estimates are year-specific and increase over time.

^c The air quality health co-benefits reflect reduced exposure to PM_{2.5} and ozone associated with emission reductions of SO₂ and NO_x. The co-benefits do not include the benefits of reductions in directly emitted PM_{2.5}. These additional benefits would increase overall benefits by a few percent based on the analyses conducted for the proposed rule. The range reflects the use of concentration-response functions from different epidemiology studies. The reduction in premature fatalities each year accounts for over 98 percent of total monetized co-benefits from PM_{2.5} and ozone. These models assume that all fine particles, regardless of their chemical composition, are equally potent in causing premature mortality because the scientific evidence is not yet sufficient to allow differentiation of effect estimates by particle type.

^d Total costs are approximated by the illustrative plan scenario costs estimated using the Integrated Planning Model for the final emission guidelines and a discount rate of approximately 5 percent. This estimate includes monitoring, recordkeeping, and reporting costs and demand side energy efficiency program and participant costs.

^e The estimates of net benefits in this summary table are calculated using the global SC-CO₂ at a 3 percent discount rate (model average). The RIA includes combined climate and health estimates based on additional discount rates.

^f Estimates in the table are presented for three analytical years with air quality co-benefits calculated using two discount rates. The estimates of co-benefits are annual estimates in each of the analytical years, reflecting discounting of mortality benefits over the cessation lag between changes in PM_{2.5} concentrations and changes in risks of premature death (see RIA Chapter 4 for more details), and discounting of morbidity benefits due to the multiple years of costs associated with some illnesses. The estimates are not the present value of the benefits of the rule over the full compliance period.

Table 8-2. Monetized Benefits, Costs, and Net Benefits Under the Mass-based Illustrative Plan Approach Scenario (billions of 2011\$) ^a

	Mass-Based Scenario					
	2020		2025		2030	
Climate Benefits ^b						
5% discount rate	\$0.94		\$3.6		\$6.4	
3% discount rate	\$3.3		\$12		\$20	
2.5% discount rate	\$4.9		\$17		\$29	
95th percentile at 3% discount rate	\$9.7		\$35		\$60	
	<u>Air Quality Co-benefits Discount Rate</u>					
	3%	7%	3%	7%	3%	7%
Air Quality Health Co-benefits ^c	\$2.0 to \$4.8	\$1.8 to \$4.4	\$7.1 to \$17	\$6.5 to \$16	\$12 to \$28	\$11 to \$26
Costs ^d	\$1.4		\$3.0		\$5.1	
Net Benefits ^e	\$3.9 to \$6.7	\$3.7 to \$6.3	\$16 to \$26	\$15 to \$24	\$26 to \$43	\$25 to \$40
	Non-monetized climate benefits					
	Reductions in exposure to ambient NO ₂ and SO ₂					
Non-Monetized Benefits	Reductions in mercury deposition					
	Ecosystem benefits associated with reductions in emissions of NO _x , SO ₂ , PM, and mercury					
	Visibility improvement					

^a All are rounded to two significant figures, so figures may not sum.

^b The climate benefit estimate in this summary table reflects global impacts from CO₂ emission changes and does not account for changes in non-CO₂ GHG emissions. Also, different discount rates are applied to SC-CO₂ than to the other estimates because CO₂ emissions are long-lived and subsequent damages occur over many years. The benefit estimates in this table are based on the average SC-CO₂ estimated for a 3 percent discount rate. However we emphasize the importance and value of considering the full range of SC-CO₂ values. As shown in the RIA, climate benefits are also estimated using the other three SC-CO₂ estimates (model average at 2.5 percent discount rate, 3 percent, and 5 percent; 95th percentile at 3 percent). The SC-CO₂ estimates are year-specific and increase over time.

^c The air quality health co-benefits reflect reduced exposure to PM_{2.5} and ozone associated with emission reductions of SO₂ and NO_x. The co-benefits do not include the benefits of reductions in directly emitted PM_{2.5}. These additional benefits would increase overall benefits by a few percent based on the analyses conducted for the proposed rule. The range reflects the use of concentration-response functions from different epidemiology studies. The reduction in premature fatalities each year accounts for over 98 percent of total monetized co-benefits from PM_{2.5} and ozone. These models assume that all fine particles, regardless of their chemical composition, are equally potent in causing premature mortality because the scientific evidence is not yet sufficient to allow differentiation of effect estimates by particle type.

^d Total costs are approximated by the illustrative plan scenario costs estimated using the Integrated Planning Model for the final emission guidelines and a discount rate of approximately 5 percent. This estimate includes monitoring, recordkeeping, and reporting costs and demand side energy efficiency program and participant costs.

^e The estimates of net benefits in this summary table are calculated using the global SC-CO₂ at a 3 percent discount rate (model average). The RIA includes combined climate and health estimates based on additional discount rates.

^f Estimates in the table are presented for three analytical years with air quality co-benefits calculated using two discount rates. The estimates of co-benefits are annual estimates in each of the analytical years, reflecting discounting of mortality benefits over the cessation lag between changes in PM_{2.5} concentrations and changes in risks of premature death (see RIA Chapter 4 for more details), and discounting of morbidity benefits due to the multiple years of costs associated with some illnesses. The estimates are not the present value of the benefits of the rule over the full compliance period.

8.2 Uncertainty Analysis

The Office of Management and Budget's circular *Regulatory Analysis* (Circular A-4) provides guidance on the preparation of regulatory analyses required under E.O. 12866, and requires an uncertainty analysis for rules with annual benefits or costs of \$1 billion or more.²⁰² This final rulemaking surpasses that threshold for both benefits and costs. Throughout the RIA, we considered a number of sources of uncertainty, both quantitatively and qualitatively, on benefits and costs. We summarize three key elements of our analysis of uncertainty here:

- Evaluating uncertainty in the illustrative plan approaches that states will implement, which influences both costs and benefits.
- Assess uncertainty in the methods used to calculate the health co-benefits associated with the reduction in PM_{2.5} and ozone and the use of a benefits-per-ton approach in estimating these co-benefits.
- Characterizing uncertainty in monetizing climate-related benefits.

Some of these elements are evaluated using probabilistic techniques, whereas for others the underlying likelihoods of certain outcomes are unknown and we use scenario analysis to evaluate their potential effect on the benefits and costs of this rulemaking.

8.2.1 Uncertainty in Costs and Illustrative Plan Approaches

The calculation of the state goals is based on an evaluation of methods for reducing the carbon emissions intensity of electricity generation that may be achieved at reasonable cost. Our best estimates of the costs of these methods of intensity reduction are reported within the cost analysis of this rule and are included in the cost modeling in the RIA.

A source of uncertainty under this regulation is the ultimate approach states will adopt in response to the guidelines, which will affect both the costs and benefits of this rule. For this reason we modeled two potential illustrative plan scenarios: the rate-based illustrative plan scenario and the mass-based illustrative plan scenario.

²⁰² Office of Management and Budget (OMB), 2003, *Circular A-4*, http://www.whitehouse.gov/omb/circulars_a004_a-4 and OMB, 2011. *Regulatory Impact Analysis: A Primer*. http://www.whitehouse.gov/sites/default/files/omb/inforeg/regpol/circular-a-4_regulatory-impact-analysis-a-primer.pdf

8.2.2 *Uncertainty Associated with Estimating the Social Cost of Carbon*

The 2010 SC-CO₂ TSD noted a number of limitations to the SC-CO₂ analysis, including the incomplete way in which the integrated assessment models (IAM) capture catastrophic and non-catastrophic impacts, their incomplete treatment of adaptation and technological change, uncertainty in the extrapolation of damages to high temperatures, and assumptions regarding risk aversion.²⁰³ Currently integrated assessment models do not assign value to all of the important physical, ecological, and economic impacts of climate change recognized in the climate change literature due to a lack of precise information on the nature of damages and because the science incorporated into these models understandably lags behind the most recent research. These individual limitations do not all work in the same direction in terms of their influence on the SC-CO₂ estimates, though taken together they suggest that the SC-CO₂ estimates are likely conservative. In particular, the IPCC Fourth Assessment Report (2007) concluded that “It is very likely that [SC-CO₂ estimates] underestimate the damage costs because they cannot include many non-quantifiable impacts” and the IPCC Fifth Assessment report observed that SC-CO₂ estimates continue to omit various impacts that would likely increase damages. The 95th percentile estimate was included in the recommended range for regulatory impact analysis, in part, to address these concerns.

The modeling underlying the development of the SC-CO₂ estimates addressed uncertainty in several ways. An ensemble of three IAMs were used to generate the SC-CO₂ estimates to capture differences in model structures that, in part, reflect uncertainty in the scientific literature about these relationships. Parametric uncertainty was explicitly addressed in each IAM, though to differing degrees, through Monte Carlo simulations in which explicit probability distributions for key parameters were specified, including the equilibrium climate sensitivity, which represents the long-run responsiveness of the climate to increasing GHG concentrations. Furthermore, the analysis considered five different socioeconomic and emissions

²⁰³ *Technical Support Document: Social Cost of Carbon for Regulatory Impact Analysis Under Executive Order 12866*, Interagency Working Group on Social Cost of Carbon, with participation by the Council of Economic Advisers, Council on Environmental Quality, Department of Agriculture, Department of Commerce, Department of Energy, Department of Transportation, Environmental Protection Agency, National Economic Council, Office of Energy and Climate Change, Office of Management and Budget, Office of Science and Technology Policy, and Department of Treasury (February 2010). Available at: <<http://www.whitehouse.gov/sites/default/files/omb/inforeg/for-agencies/Social-Cost-of-Carbon-for-RIA.pdf>>.

forecasts to capture the sensitivity of the SC-CO₂ estimates to key exogenous projections used in the modeling. Finally, the results were calculated for three discount rates, which were selected, in part, to reflect uncertainty about how interest rates may change over time and the possibility that climate damages are positively correlated with uncertain future economic activity. This analysis produced 45 different distributions of the SC-CO₂ estimates for each emissions year. To produce a range of plausible estimates that are manageable in regulatory analysis but still reflects the uncertainty in the results four point estimates were recommended. The use of this range of point estimates in this rulemaking helps to reflect the uncertainty in the SC-CO₂ estimates. Chapter 4 of this RIA provides a comprehensive discussion about the methodology and application of the SC-CO₂; see both the 2010 TSD and current SC-CO₂ TSD for a full description.

In addition, OMB's Office of Information and Regulatory Affairs received comments regarding uncertainty and the SC-CO₂ estimates in response to a separate request for public comment on the approach used to develop the estimates. Commenters discussed the analyses and presentation of uncertainty in the TSD as well as the implications of uncertainty for use of the SC-CO₂ estimates in regulatory impact analysis. In their response, the interagency working group (IWG) acknowledged uncertainty in the SC-CO₂ estimates but disagreed with commenters that suggested the uncertainty undermines use of the SC-CO₂ estimates in regulatory impact analysis. The IWG went on to note that the uncertainty in the SC-CO₂ estimates is fully acknowledged and comprehensively discussed in the TSDs and supporting academic literature, and that while all regulatory impact analysis involves uncertainty, these analyses can provide useful information to decision makers and the public. See the IWG Response to Comments for the complete response.²⁰⁴

8.2.3 Uncertainty Associated with PM_{2.5} and Ozone Health Co-Benefits Assessment

Our estimate of the total monetized co-benefits is based on EPA's interpretation of the best available scientific literature and methods and supported by the SAB-HES and the National Academies of Science (NRC, 2002). Below are key assumptions underlying the estimates for PM_{2.5}-related premature mortality, which accounts for 98 percent of the monetized PM_{2.5} health co-benefits:

²⁰⁴ See <https://www.whitehouse.gov/sites/default/files/omb/inforeg/scc-response-to-comments-final-july-2015.pdf>

- We assume that all fine particles, regardless of their chemical composition, are equally potent in causing premature mortality. This is an important assumption, because PM_{2.5} varies considerably in composition across sources, but the scientific evidence is not yet sufficient to allow differentiation of effect estimates by particle type. The PM ISA concluded that “many constituents of PM_{2.5} can be linked with multiple health effects, and the evidence is not yet sufficient to allow differentiation of those constituents or sources that are more closely related to specific outcomes” (U.S. EPA, 2009).
- We assume that the health impact function for fine particles is log-linear without a threshold in this analysis. Thus, the estimates include health co-benefits from reducing fine particles in areas with varied concentrations of PM_{2.5}, including both areas that do not meet the fine particle standard and those areas that are in attainment, down to the lowest modeled concentrations.
- We assume that there is a “cessation” lag between the change in PM exposures and the total realization of changes in mortality effects. Specifically, we assume that some of the incidences of premature mortality related to PM_{2.5} exposures occur in a distributed fashion over the 20 years following exposure based on the advice of the SAB-HES (U.S. EPA-SAB, 2004), which affects the valuation of mortality co-benefits at different discount rates. EPA quantitatively assessed uncertainty in the air quality health co-benefits, including probabilistic approaches.

In addition, EPA provides the 95th percentile confidence interval for avoided PM-related premature deaths and the associated economic valuation using two key epidemiology studies. EPA provides the PM-related results using alternate concentration-response relationship provided by an expert elicitation and alternate ozone-related results using concentration-response relationships provided by alternate epidemiology studies. In addition, we include an assessment of the distribution of population exposure in the modeling underlying the benefit-per-ton estimates. For further discussion and characterization of those uncertainties influencing the benefit assessment, see Chapter 4 of this RIA.

As noted and described in Chapter 4 of this RIA, we use a benefit-per-ton approach to quantify health co-benefits. All benefit-per-ton estimates have inherent limitations, including that

the estimates reflect the geographic distribution of the modeled sector emissions, which may not match the emission reductions anticipated by the final emission guidelines, and they may not reflect local variability in population density, meteorology, exposure, baseline health incidence rates, or other local factors for any specific location. In addition, these estimates reflect the regional average benefit-per-ton for each ambient PM_{2.5} precursor emitted from EGUs, which assumes a linear atmospheric response to emission reductions. The regional benefit-per-ton estimates, although less subject to these types of uncertainties than national estimates, still should be interpreted with caution. Even though we assume that all fine particles have equivalent health effects, the benefit-per-ton estimates vary between precursors depending on the location and magnitude of their impact on PM_{2.5} levels, which drive population exposure.

8.3 References

Docket ID EPA-HQ-OAR-2013-0602, Technical Support Document: Technical Update of the Social Cost of Carbon for Regulatory Impact Analysis Under Executive Order 12866, Interagency Working Group on Social Cost of Carbon, with Participation by Council of Economic Advisers, Council on Environmental Quality, Department of Agriculture, Department of Commerce, Department of Energy, Department of Transportation, Domestic Policy Council, Environmental Protection Agency, National Economic Council, Office of Management and Budget, Office of Science and Technology Policy, and Department of Treasury (May 2013, Revised July 2015). Also available at: <<https://www.whitehouse.gov/sites/default/files/omb/inforeg/scc-tsd-final-july-2015.pdf>>. Accessed July 15, 2015.

Interagency Working Group on Social Cost of Carbon, with participation by Council of Economic Advisers, Council on Environmental Quality, Department of Agriculture, Department of Commerce, Department of Energy, Department of Transportation, Environmental Protection Agency, National Economic Council, Office of Management and Budget, Office of Science and Technology Policy, and Department of Treasury. *Response to Comments: Social Cost of Carbon for Regulatory Impact Analysis Under Executive Order 12866*. July 2015. Available at <<https://www.whitehouse.gov/sites/default/files/omb/inforeg/scc-response-to-comments-final-july-2015.pdf>> Accessed July 15, 2015.

- Intergovernmental Panel on Climate Change (IPCC). 2007. *Climate Change 2007: Synthesis Report Contribution of Working Groups I, II and III to the Fourth Assessment Report of the IPCC*. Available at <http://www.ipcc.ch/publications_and_data/publications_ipcc_fourth_assessment_report_synthesis_report.htm>. Accessed June 6, 2015.
- National Research Council (NRC). 2002. *Estimating the Public Health Benefits of Proposed Air Pollution Regulations*. National Academies Press. Washington, DC.
- U.S. Environmental Protection Agency—Science Advisory Board (U.S. EPA-SAB). 2004. *Advisory Council on Clean Air Compliance Analysis Response to Agency Request on Cessation Lag*. EPA-COUNCIL-LTR-05-001. December. Available at <[http://yosemite.epa.gov/sab/sabproduct.nsf/0/39F44B098DB49F3C85257170005293E0/\\$File/council_ltr_05_001.pdf](http://yosemite.epa.gov/sab/sabproduct.nsf/0/39F44B098DB49F3C85257170005293E0/$File/council_ltr_05_001.pdf)>. Accessed June 4, 2015.
- U.S. Environmental Protection Agency (U.S. EPA). 2009. *Integrated Science Assessment for Particulate Matter (Final Report)*. EPA-600-R-08-139F. National Center for Environmental Assessment – RTP Division, Research Triangle Park, NC. Available at <<http://cfpub.epa.gov/ncea/cfm/recordisplay.cfm?deid=216546>>. Accessed June 4, 2015.

United States
Environmental
Protection Agency

Office of Air Quality Planning and Standards
Health and Environmental Impacts Division
Research Triangle Park, NC

Publication No.
EPA-452/R-15-003
August 2015
