

Introduction to Methods of Applied Mathematics  
or  
Advanced Mathematical Methods for Scientists and Engineers

Sean Mauch

<http://www.its.caltech.edu/~sean>

January 24, 2004

# Contents

<b>Anti-Copyright</b>	<b>xxiv</b>
<b>Preface</b>	<b>xxv</b>
0.1 Advice to Teachers . . . . .	xxv
0.2 Acknowledgments . . . . .	xxv
0.3 Warnings and Disclaimers . . . . .	xxvi
0.4 Suggested Use . . . . .	xxvii
0.5 About the Title . . . . .	xxvii
<b>I Algebra</b>	<b>1</b>
<b>1 Sets and Functions</b>	<b>2</b>
1.1 Sets . . . . .	2
1.2 Single Valued Functions . . . . .	4
1.3 Inverses and Multi-Valued Functions . . . . .	6
1.4 Transforming Equations . . . . .	9
1.5 Exercises . . . . .	11
1.6 Hints . . . . .	14
1.7 Solutions . . . . .	16

<b>2</b>	<b>Vectors</b>	<b>22</b>
2.1	Vectors	22
2.1.1	Scalars and Vectors	22
2.1.2	The Kronecker Delta and Einstein Summation Convention	25
2.1.3	The Dot and Cross Product	26
2.2	Sets of Vectors in n Dimensions	33
2.3	Exercises	36
2.4	Hints	38
2.5	Solutions	40

## **II Calculus 47**

<b>3</b>	<b>Differential Calculus</b>	<b>48</b>
3.1	Limits of Functions	48
3.2	Continuous Functions	53
3.3	The Derivative	56
3.4	Implicit Differentiation	61
3.5	Maxima and Minima	62
3.6	Mean Value Theorems	66
3.6.1	Application: Using Taylor's Theorem to Approximate Functions.	68
3.6.2	Application: Finite Difference Schemes	73
3.7	L'Hospital's Rule	75
3.8	Exercises	81
3.8.1	Limits of Functions	81
3.8.2	Continuous Functions	81
3.8.3	The Derivative	82
3.8.4	Implicit Differentiation	84
3.8.5	Maxima and Minima	84
3.8.6	Mean Value Theorems	85

3.8.7	L'Hospital's Rule . . . . .	85
3.9	Hints . . . . .	87
3.10	Solutions . . . . .	93
3.11	Quiz . . . . .	113
3.12	Quiz Solutions . . . . .	114
<b>4</b>	<b>Integral Calculus</b>	<b>116</b>
4.1	The Indefinite Integral . . . . .	116
4.2	The Definite Integral . . . . .	122
4.2.1	Definition . . . . .	122
4.2.2	Properties . . . . .	123
4.3	The Fundamental Theorem of Integral Calculus . . . . .	125
4.4	Techniques of Integration . . . . .	127
4.4.1	Partial Fractions . . . . .	127
4.5	Improper Integrals . . . . .	130
4.6	Exercises . . . . .	134
4.6.1	The Indefinite Integral . . . . .	134
4.6.2	The Definite Integral . . . . .	134
4.6.3	The Fundamental Theorem of Integration . . . . .	136
4.6.4	Techniques of Integration . . . . .	136
4.6.5	Improper Integrals . . . . .	137
4.7	Hints . . . . .	138
4.8	Solutions . . . . .	141
4.9	Quiz . . . . .	150
4.10	Quiz Solutions . . . . .	151
<b>5</b>	<b>Vector Calculus</b>	<b>154</b>
5.1	Vector Functions . . . . .	154
5.2	Gradient, Divergence and Curl . . . . .	155
5.3	Exercises . . . . .	163



5.4	Hints	166
5.5	Solutions	168
5.6	Quiz	177
5.7	Quiz Solutions	178

### **III Functions of a Complex Variable 179**

#### **6 Complex Numbers 180**

6.1	Complex Numbers	180
6.2	The Complex Plane	184
6.3	Polar Form	188
6.4	Arithmetic and Vectors	193
6.5	Integer Exponents	195
6.6	Rational Exponents	197
6.7	Exercises	201
6.8	Hints	208
6.9	Solutions	211

#### **7 Functions of a Complex Variable 239**

7.1	Curves and Regions	239
7.2	The Point at Infinity and the Stereographic Projection	242
7.3	A Gentle Introduction to Branch Points	246
7.4	Cartesian and Modulus-Argument Form	246
7.5	Graphing Functions of a Complex Variable	249
7.6	Trigonometric Functions	252
7.7	Inverse Trigonometric Functions	259
7.8	Riemann Surfaces	268
7.9	Branch Points	270
7.10	Exercises	286

7.11	Hints	297
7.12	Solutions	302
<b>8</b>	<b>Analytic Functions</b>	<b>360</b>
8.1	Complex Derivatives	360
8.2	Cauchy-Riemann Equations	367
8.3	Harmonic Functions	372
8.4	Singularities	377
8.4.1	Categorization of Singularities	377
8.4.2	Isolated and Non-Isolated Singularities	381
8.5	Application: Potential Flow	383
8.6	Exercises	388
8.7	Hints	396
8.8	Solutions	399
<b>9</b>	<b>Analytic Continuation</b>	<b>437</b>
9.1	Analytic Continuation	437
9.2	Analytic Continuation of Sums	440
9.3	Analytic Functions Defined in Terms of Real Variables	442
9.3.1	Polar Coordinates	446
9.3.2	Analytic Functions Defined in Terms of Their Real or Imaginary Parts	450
9.4	Exercises	454
9.5	Hints	456
9.6	Solutions	457
<b>10</b>	<b>Contour Integration and the Cauchy-Goursat Theorem</b>	<b>462</b>
10.1	Line Integrals	462
10.2	Contour Integrals	464
10.2.1	Maximum Modulus Integral Bound	466
10.3	The Cauchy-Goursat Theorem	467

10.4	Contour Deformation	469
10.5	Morera's Theorem.	471
10.6	Indefinite Integrals	473
10.7	Fundamental Theorem of Calculus via Primitives	474
10.7.1	Line Integrals and Primitives	474
10.7.2	Contour Integrals	474
10.8	Fundamental Theorem of Calculus via Complex Calculus	475
10.9	Exercises	478
10.10	Hints	482
10.11	Solutions	483
<b>11</b>	<b>Cauchy's Integral Formula</b>	<b>493</b>
11.1	Cauchy's Integral Formula	494
11.2	The Argument Theorem	501
11.3	Rouche's Theorem	502
11.4	Exercises	505
11.5	Hints	509
11.6	Solutions	511
<b>12</b>	<b>Series and Convergence</b>	<b>525</b>
12.1	Series of Constants	525
12.1.1	Definitions	525
12.1.2	Special Series	527
12.1.3	Convergence Tests	529
12.2	Uniform Convergence	536
12.2.1	Tests for Uniform Convergence	537
12.2.2	Uniform Convergence and Continuous Functions.	539
12.3	Uniformly Convergent Power Series	539
12.4	Integration and Differentiation of Power Series	547
12.5	Taylor Series	550

12.5.1	Newton's Binomial Formula.	553
12.6	Laurent Series	555
12.7	Exercises	560
12.7.1	Series of Constants	560
12.7.2	Uniform Convergence	566
12.7.3	Uniformly Convergent Power Series	566
12.7.4	Integration and Differentiation of Power Series	568
12.7.5	Taylor Series	569
12.7.6	Laurent Series	571
12.8	Hints	574
12.9	Solutions	582
<b>13</b>	<b>The Residue Theorem</b>	<b>626</b>
13.1	The Residue Theorem	626
13.2	Cauchy Principal Value for Real Integrals	634
13.2.1	The Cauchy Principal Value	634
13.3	Cauchy Principal Value for Contour Integrals	639
13.4	Integrals on the Real Axis	643
13.5	Fourier Integrals	647
13.6	Fourier Cosine and Sine Integrals	649
13.7	Contour Integration and Branch Cuts	652
13.8	Exploiting Symmetry	655
13.8.1	Wedge Contours	655
13.8.2	Box Contours	658
13.9	Definite Integrals Involving Sine and Cosine	659
13.10	Infinite Sums	662
13.11	Exercises	666
13.12	Hints	680
13.13	Solutions	686

## 14 First Order Differential Equations

14.1	Notation	773
14.2	Example Problems	775
14.2.1	Growth and Decay	775
14.3	One Parameter Families of Functions	777
14.4	Integrable Forms	779
14.4.1	Separable Equations	780
14.4.2	Exact Equations	782
14.4.3	Homogeneous Coefficient Equations	786
14.5	The First Order, Linear Differential Equation	791
14.5.1	Homogeneous Equations	791
14.5.2	Inhomogeneous Equations	792
14.5.3	Variation of Parameters	795
14.6	Initial Conditions	796
14.6.1	Piecewise Continuous Coefficients and Inhomogeneities	797
14.7	Well-Posed Problems	801
14.8	Equations in the Complex Plane	803
14.8.1	Ordinary Points	803
14.8.2	Regular Singular Points	806
14.8.3	Irregular Singular Points	812
14.8.4	The Point at Infinity	814
14.9	Additional Exercises	816
14.10	Hints	819
14.11	Solutions	822
14.12	Quiz	843
14.13	Quiz Solutions	844

<b>15</b>	<b>First Order Linear Systems of Differential Equations</b>	<b>846</b>
15.1	Introduction	846
15.2	Using Eigenvalues and Eigenvectors to find Homogeneous Solutions	847
15.3	Matrices and Jordan Canonical Form	852
15.4	Using the Matrix Exponential	860
15.5	Exercises	865
15.6	Hints	870
15.7	Solutions	872
<b>16</b>	<b>Theory of Linear Ordinary Differential Equations</b>	<b>900</b>
16.1	Exact Equations	900
16.2	Nature of Solutions	901
16.3	Transformation to a First Order System	905
16.4	The Wronskian	905
16.4.1	Derivative of a Determinant.	905
16.4.2	The Wronskian of a Set of Functions.	906
16.4.3	The Wronskian of the Solutions to a Differential Equation	908
16.5	Well-Posed Problems	911
16.6	The Fundamental Set of Solutions	913
16.7	Adjoint Equations	915
16.8	Additional Exercises	919
16.9	Hints	920
16.10	Solutions	922
16.11	Quiz	928
16.12	Quiz Solutions	929
<b>17</b>	<b>Techniques for Linear Differential Equations</b>	<b>930</b>
17.1	Constant Coefficient Equations	930
17.1.1	Second Order Equations	931
17.1.2	Real-Valued Solutions	935

17.1.3 Higher Order Equations . . . . .	937
17.2 Euler Equations . . . . .	940
17.2.1 Real-Valued Solutions . . . . .	942
17.3 Exact Equations . . . . .	945
17.4 Equations Without Explicit Dependence on $y$ . . . . .	946
17.5 Reduction of Order . . . . .	947
17.6 *Reduction of Order and the Adjoint Equation . . . . .	948
17.7 Additional Exercises . . . . .	951
17.8 Hints . . . . .	957
17.9 Solutions . . . . .	960
<b>18 Techniques for Nonlinear Differential Equations</b>	<b>984</b>
18.1 Bernoulli Equations . . . . .	984
18.2 Riccati Equations . . . . .	986
18.3 Exchanging the Dependent and Independent Variables . . . . .	990
18.4 Autonomous Equations . . . . .	992
18.5 *Equidimensional-in- $x$ Equations . . . . .	995
18.6 *Equidimensional-in- $y$ Equations . . . . .	997
18.7 *Scale-Invariant Equations . . . . .	1000
18.8 Exercises . . . . .	1001
18.9 Hints . . . . .	1004
18.10 Solutions . . . . .	1006
<b>19 Transformations and Canonical Forms</b>	<b>1018</b>
19.1 The Constant Coefficient Equation . . . . .	1018
19.2 Normal Form . . . . .	1021
19.2.1 Second Order Equations . . . . .	1021
19.2.2 Higher Order Differential Equations . . . . .	1022
19.3 Transformations of the Independent Variable . . . . .	1024
19.3.1 Transformation to the form $u'' + a(x)u = 0$ . . . . .	1024

19.3.2	Transformation to a Constant Coefficient Equation . . . . .	1025
19.4	Integral Equations . . . . .	1027
19.4.1	Initial Value Problems . . . . .	1027
19.4.2	Boundary Value Problems . . . . .	1029
19.5	Exercises . . . . .	1032
19.6	Hints . . . . .	1034
19.7	Solutions . . . . .	1035
<b>20</b>	<b>The Dirac Delta Function</b>	<b>1041</b>
20.1	Derivative of the Heaviside Function . . . . .	1041
20.2	The Delta Function as a Limit . . . . .	1043
20.3	Higher Dimensions . . . . .	1045
20.4	Non-Rectangular Coordinate Systems . . . . .	1046
20.5	Exercises . . . . .	1048
20.6	Hints . . . . .	1050
20.7	Solutions . . . . .	1052
<b>21</b>	<b>Inhomogeneous Differential Equations</b>	<b>1059</b>
21.1	Particular Solutions . . . . .	1059
21.2	Method of Undetermined Coefficients . . . . .	1061
21.3	Variation of Parameters . . . . .	1065
21.3.1	Second Order Differential Equations . . . . .	1065
21.3.2	Higher Order Differential Equations . . . . .	1068
21.4	Piecewise Continuous Coefficients and Inhomogeneities . . . . .	1071
21.5	Inhomogeneous Boundary Conditions . . . . .	1074
21.5.1	Eliminating Inhomogeneous Boundary Conditions . . . . .	1074
21.5.2	Separating Inhomogeneous Equations and Inhomogeneous Boundary Conditions . . . . .	1076
21.5.3	Existence of Solutions of Problems with Inhomogeneous Boundary Conditions . . . . .	1077
21.6	Green Functions for First Order Equations . . . . .	1079
21.7	Green Functions for Second Order Equations . . . . .	1082



21.7.1	Green Functions for Sturm-Liouville Problems . . . . .	1092
21.7.2	Initial Value Problems . . . . .	1095
21.7.3	Problems with Unmixed Boundary Conditions . . . . .	1098
21.7.4	Problems with Mixed Boundary Conditions . . . . .	1100
21.8	Green Functions for Higher Order Problems . . . . .	1104
21.9	Fredholm Alternative Theorem . . . . .	1109
21.10	Exercises . . . . .	1117
21.11	Hints . . . . .	1123
21.12	Solutions . . . . .	1126
21.13	Quiz . . . . .	1164
21.14	Quiz Solutions . . . . .	1165
<b>22</b>	<b>Difference Equations</b>	<b>1166</b>
22.1	Introduction . . . . .	1166
22.2	Exact Equations . . . . .	1168
22.3	Homogeneous First Order . . . . .	1169
22.4	Inhomogeneous First Order . . . . .	1171
22.5	Homogeneous Constant Coefficient Equations . . . . .	1174
22.6	Reduction of Order . . . . .	1177
22.7	Exercises . . . . .	1179
22.8	Hints . . . . .	1180
22.9	Solutions . . . . .	1181
<b>23</b>	<b>Series Solutions of Differential Equations</b>	<b>1184</b>
23.1	Ordinary Points . . . . .	1184
23.1.1	Taylor Series Expansion for a Second Order Differential Equation . . . . .	1188
23.2	Regular Singular Points of Second Order Equations . . . . .	1198
23.2.1	Indicial Equation . . . . .	1201
23.2.2	The Case: Double Root . . . . .	1203
23.2.3	The Case: Roots Differ by an Integer . . . . .	1206

23.3 Irregular Singular Points . . . . .	1216
23.4 The Point at Infinity . . . . .	1216
23.5 Exercises . . . . .	1219
23.6 Hints . . . . .	1224
23.7 Solutions . . . . .	1225
23.8 Quiz . . . . .	1248
23.9 Quiz Solutions . . . . .	1249
<b>24 Asymptotic Expansions</b>	<b>1251</b>
24.1 Asymptotic Relations . . . . .	1251
24.2 Leading Order Behavior of Differential Equations . . . . .	1255
24.3 Integration by Parts . . . . .	1263
24.4 Asymptotic Series . . . . .	1270
24.5 Asymptotic Expansions of Differential Equations . . . . .	1272
24.5.1 The Parabolic Cylinder Equation. . . . .	1272
<b>25 Hilbert Spaces</b>	<b>1278</b>
25.1 Linear Spaces . . . . .	1278
25.2 Inner Products . . . . .	1280
25.3 Norms . . . . .	1281
25.4 Linear Independence. . . . .	1283
25.5 Orthogonality . . . . .	1283
25.6 Gramm-Schmidt Orthogonalization . . . . .	1284
25.7 Orthonormal Function Expansion . . . . .	1287
25.8 Sets Of Functions . . . . .	1288
25.9 Least Squares Fit to a Function and Completeness . . . . .	1294
25.10 Closure Relation . . . . .	1297
25.11 Linear Operators . . . . .	1302
25.12 Exercises . . . . .	1303
25.13 Hints . . . . .	1304

25.14	Solutions	1305
<b>26</b>	<b>Self Adjoint Linear Operators</b>	<b>1307</b>
26.1	Adjoint Operators	1307
26.2	Self-Adjoint Operators	1308
26.3	Exercises	1311
26.4	Hints	1312
26.5	Solutions	1313
<b>27</b>	<b>Self-Adjoint Boundary Value Problems</b>	<b>1314</b>
27.1	Summary of Adjoint Operators	1314
27.2	Formally Self-Adjoint Operators	1315
27.3	Self-Adjoint Problems	1318
27.4	Self-Adjoint Eigenvalue Problems	1318
27.5	Inhomogeneous Equations	1323
27.6	Exercises	1326
27.7	Hints	1327
27.8	Solutions	1328
<b>28</b>	<b>Fourier Series</b>	<b>1330</b>
28.1	An Eigenvalue Problem.	1330
28.2	Fourier Series.	1333
28.3	Least Squares Fit	1337
28.4	Fourier Series for Functions Defined on Arbitrary Ranges	1341
28.5	Fourier Cosine Series	1344
28.6	Fourier Sine Series	1345
28.7	Complex Fourier Series and Parseval's Theorem	1346
28.8	Behavior of Fourier Coefficients	1349
28.9	Gibb's Phenomenon	1358
28.10	Integrating and Differentiating Fourier Series	1358

28.11 Exercises	1363
28.12 Hints	1371
28.13 Solutions	1373
<b>29 Regular Sturm-Liouville Problems</b>	<b>1420</b>
29.1 Derivation of the Sturm-Liouville Form	1420
29.2 Properties of Regular Sturm-Liouville Problems	1422
29.3 Solving Differential Equations With Eigenfunction Expansions	1433
29.4 Exercises	1439
29.5 Hints	1443
29.6 Solutions	1445
<b>30 Integrals and Convergence</b>	<b>1470</b>
30.1 Uniform Convergence of Integrals	1470
30.2 The Riemann-Lebesgue Lemma	1471
30.3 Cauchy Principal Value	1472
30.3.1 Integrals on an Infinite Domain	1472
30.3.2 Singular Functions	1473
<b>31 The Laplace Transform</b>	<b>1475</b>
31.1 The Laplace Transform	1475
31.2 The Inverse Laplace Transform	1477
31.2.1 $\hat{f}(s)$ with Poles	1480
31.2.2 $\hat{f}(s)$ with Branch Points	1484
31.2.3 Asymptotic Behavior of $\hat{f}(s)$	1488
31.3 Properties of the Laplace Transform	1489
31.4 Constant Coefficient Differential Equations	1492
31.5 Systems of Constant Coefficient Differential Equations	1495
31.6 Exercises	1497
31.7 Hints	1504

31.8 Solutions . . . . .	1507
<b>32 The Fourier Transform</b>	<b>1539</b>
32.1 Derivation from a Fourier Series . . . . .	1539
32.2 The Fourier Transform . . . . .	1541
32.2.1 A Word of Caution . . . . .	1544
32.3 Evaluating Fourier Integrals . . . . .	1545
32.3.1 Integrals that Converge . . . . .	1545
32.3.2 Cauchy Principal Value and Integrals that are Not Absolutely Convergent. . . . .	1548
32.3.3 Analytic Continuation . . . . .	1550
32.4 Properties of the Fourier Transform . . . . .	1552
32.4.1 Closure Relation. . . . .	1552
32.4.2 Fourier Transform of a Derivative. . . . .	1553
32.4.3 Fourier Convolution Theorem. . . . .	1554
32.4.4 Parseval's Theorem. . . . .	1557
32.4.5 Shift Property. . . . .	1559
32.4.6 Fourier Transform of $x f(x)$ . . . . .	1559
32.5 Solving Differential Equations with the Fourier Transform . . . . .	1560
32.6 The Fourier Cosine and Sine Transform . . . . .	1562
32.6.1 The Fourier Cosine Transform . . . . .	1562
32.6.2 The Fourier Sine Transform . . . . .	1563
32.7 Properties of the Fourier Cosine and Sine Transform . . . . .	1564
32.7.1 Transforms of Derivatives . . . . .	1564
32.7.2 Convolution Theorems . . . . .	1566
32.7.3 Cosine and Sine Transform in Terms of the Fourier Transform . . . . .	1568
32.8 Solving Differential Equations with the Fourier Cosine and Sine Transforms . . . . .	1569
32.9 Exercises . . . . .	1571
32.10 Hints . . . . .	1578
32.11 Solutions . . . . .	1581

<b>33 The Gamma Function</b>	<b>1605</b>
33.1 Euler's Formula	1605
33.2 Hankel's Formula	1607
33.3 Gauss' Formula	1609
33.4 Weierstrass' Formula	1611
33.5 Stirling's Approximation	1613
33.6 Exercises	1618
33.7 Hints	1619
33.8 Solutions	1620
<b>34 Bessel Functions</b>	<b>1622</b>
34.1 Bessel's Equation	1622
34.2 Frobenius Series Solution about $z = 0$	1623
34.2.1 Behavior at Infinity	1626
34.3 Bessel Functions of the First Kind	1628
34.3.1 The Bessel Function Satisfies Bessel's Equation	1629
34.3.2 Series Expansion of the Bessel Function	1630
34.3.3 Bessel Functions of Non-Integer Order	1633
34.3.4 Recursion Formulas	1636
34.3.5 Bessel Functions of Half-Integer Order	1639
34.4 Neumann Expansions	1640
34.5 Bessel Functions of the Second Kind	1644
34.6 Hankel Functions	1646
34.7 The Modified Bessel Equation	1646
34.8 Exercises	1650
34.9 Hints	1655
34.10 Solutions	1657

# V Partial Differential Equations

1680

## 35 Transforming Equations

1681

35.1 Exercises . . . . .	1682
35.2 Hints . . . . .	1683
35.3 Solutions . . . . .	1684

## 36 Classification of Partial Differential Equations

1685

36.1 Classification of Second Order Quasi-Linear Equations . . . . .	1685
36.1.1 Hyperbolic Equations . . . . .	1686
36.1.2 Parabolic equations . . . . .	1691
36.1.3 Elliptic Equations . . . . .	1692
36.2 Equilibrium Solutions . . . . .	1694
36.3 Exercises . . . . .	1696
36.4 Hints . . . . .	1697
36.5 Solutions . . . . .	1698

## 37 Separation of Variables

1704

37.1 Eigensolutions of Homogeneous Equations . . . . .	1704
37.2 Homogeneous Equations with Homogeneous Boundary Conditions . . . . .	1704
37.3 Time-Independent Sources and Boundary Conditions . . . . .	1706
37.4 Inhomogeneous Equations with Homogeneous Boundary Conditions . . . . .	1709
37.5 Inhomogeneous Boundary Conditions . . . . .	1710
37.6 The Wave Equation . . . . .	1713
37.7 General Method . . . . .	1716
37.8 Exercises . . . . .	1718
37.9 Hints . . . . .	1734
37.10 Solutions . . . . .	1739

<b>38 Finite Transforms</b>	<b>1821</b>
38.1 Exercises . . . . .	1825
38.2 Hints . . . . .	1826
38.3 Solutions . . . . .	1827
<b>39 The Diffusion Equation</b>	<b>1831</b>
39.1 Exercises . . . . .	1832
39.2 Hints . . . . .	1834
39.3 Solutions . . . . .	1835
<b>40 Laplace's Equation</b>	<b>1841</b>
40.1 Introduction . . . . .	1841
40.2 Fundamental Solution . . . . .	1841
40.2.1 Two Dimensional Space . . . . .	1842
40.3 Exercises . . . . .	1843
40.4 Hints . . . . .	1846
40.5 Solutions . . . . .	1847
<b>41 Waves</b>	<b>1859</b>
41.1 Exercises . . . . .	1860
41.2 Hints . . . . .	1866
41.3 Solutions . . . . .	1868
<b>42 Similarity Methods</b>	<b>1888</b>
42.1 Exercises . . . . .	1892
42.2 Hints . . . . .	1893
42.3 Solutions . . . . .	1894
<b>43 Method of Characteristics</b>	<b>1897</b>
43.1 First Order Linear Equations . . . . .	1897
43.2 First Order Quasi-Linear Equations . . . . .	1898



43.3	The Method of Characteristics and the Wave Equation . . . . .	1900
43.4	The Wave Equation for an Infinite Domain . . . . .	1901
43.5	The Wave Equation for a Semi-Infinite Domain . . . . .	1902
43.6	The Wave Equation for a Finite Domain . . . . .	1904
43.7	Envelopes of Curves . . . . .	1905
43.8	Exercises . . . . .	1908
43.9	Hints . . . . .	1910
43.10	Solutions . . . . .	1911
<b>44</b>	<b>Transform Methods</b>	<b>1918</b>
44.1	Fourier Transform for Partial Differential Equations . . . . .	1918
44.2	The Fourier Sine Transform . . . . .	1920
44.3	Fourier Transform . . . . .	1920
44.4	Exercises . . . . .	1922
44.5	Hints . . . . .	1926
44.6	Solutions . . . . .	1928
<b>45</b>	<b>Green Functions</b>	<b>1950</b>
45.1	Inhomogeneous Equations and Homogeneous Boundary Conditions . . . . .	1950
45.2	Homogeneous Equations and Inhomogeneous Boundary Conditions . . . . .	1951
45.3	Eigenfunction Expansions for Elliptic Equations . . . . .	1953
45.4	The Method of Images . . . . .	1958
45.5	Exercises . . . . .	1960
45.6	Hints . . . . .	1971
45.7	Solutions . . . . .	1974
<b>46</b>	<b>Conformal Mapping</b>	<b>2034</b>
46.1	Exercises . . . . .	2035
46.2	Hints . . . . .	2038
46.3	Solutions . . . . .	2039

<b>47 Non-Cartesian Coordinates</b>	<b>2051</b>
47.1 Spherical Coordinates . . . . .	2051
47.2 Laplace's Equation in a Disk . . . . .	2052
47.3 Laplace's Equation in an Annulus . . . . .	2055
<b>VI Calculus of Variations</b>	<b>2059</b>
<b>48 Calculus of Variations</b>	<b>2060</b>
48.1 Exercises . . . . .	2061
48.2 Hints . . . . .	2075
48.3 Solutions . . . . .	2079
<b>VII Nonlinear Differential Equations</b>	<b>2166</b>
<b>49 Nonlinear Ordinary Differential Equations</b>	<b>2167</b>
49.1 Exercises . . . . .	2168
49.2 Hints . . . . .	2173
49.3 Solutions . . . . .	2174
<b>50 Nonlinear Partial Differential Equations</b>	<b>2196</b>
50.1 Exercises . . . . .	2197
50.2 Hints . . . . .	2200
50.3 Solutions . . . . .	2201
<b>VIII Appendices</b>	<b>2220</b>
<b>A Greek Letters</b>	<b>2221</b>

<b>B</b>	<b>Notation</b>	<b>2223</b>
<b>C</b>	<b>Formulas from Complex Variables</b>	<b>2225</b>
<b>D</b>	<b>Table of Derivatives</b>	<b>2228</b>
<b>E</b>	<b>Table of Integrals</b>	<b>2232</b>
<b>F</b>	<b>Definite Integrals</b>	<b>2236</b>
<b>G</b>	<b>Table of Sums</b>	<b>2238</b>
<b>H</b>	<b>Table of Taylor Series</b>	<b>2241</b>
<b>I</b>	<b>Continuous Transforms</b>	<b>2244</b>
I.1	Properties of Laplace Transforms . . . . .	2244
I.2	Table of Laplace Transforms . . . . .	2247
I.3	Table of Fourier Transforms . . . . .	2250
I.4	Table of Fourier Transforms in n Dimensions . . . . .	2253
I.5	Table of Fourier Cosine Transforms . . . . .	2254
I.6	Table of Fourier Sine Transforms . . . . .	2255
<b>J</b>	<b>Table of Wronskians</b>	<b>2257</b>
<b>K</b>	<b>Sturm-Liouville Eigenvalue Problems</b>	<b>2259</b>
<b>L</b>	<b>Green Functions for Ordinary Differential Equations</b>	<b>2261</b>
<b>M</b>	<b>Trigonometric Identities</b>	<b>2264</b>
M.1	Circular Functions . . . . .	2264
M.2	Hyperbolic Functions . . . . .	2266

<b>N Bessel Functions</b>	<b>2269</b>
N.1 Definite Integrals . . . . .	2269
<b>O Formulas from Linear Algebra</b>	<b>2270</b>
<b>P Vector Analysis</b>	<b>2271</b>
<b>Q Partial Fractions</b>	<b>2273</b>
<b>R Finite Math</b>	<b>2276</b>
<b>S Physics</b>	<b>2277</b>
<b>T Probability</b>	<b>2278</b>
T.1 Independent Events . . . . .	2278
T.2 Playing the Odds . . . . .	2279
<b>U Economics</b>	<b>2280</b>
<b>V Glossary</b>	<b>2281</b>
<b>W whoami</b>	<b>2283</b>

# Anti-Copyright

Anti-Copyright © 1995-2001 by Mauch Publishing Company, un-Incorporated.

No rights reserved. Any part of this publication may be reproduced, stored in a retrieval system, transmitted or desecrated without permission.

# Preface

During the summer before my final undergraduate year at Caltech I set out to write a math text unlike any other, namely, one written by me. In that respect I have succeeded beautifully. Unfortunately, the text is neither complete nor polished. I have a “Warnings and Disclaimers” section below that is a little amusing, and an appendix on probability that I feel concisely captures the essence of the subject. However, all the material in between is in some stage of development. I am currently working to improve and expand this text.

This text is freely available from my web set. Currently I’m at <http://www.its.caltech.edu/~sean>. I post new versions a couple of times a year.

## 0.1 Advice to Teachers

If you have something worth saying, write it down.

## 0.2 Acknowledgments

I would like to thank Professor Saffman for advising me on this project and the Caltech SURF program for providing the funding for me to write the first edition of this book.

## 0.3 Warnings and Disclaimers

- This book is a work in progress. It contains quite a few mistakes and typos. I would greatly appreciate your constructive criticism. You can reach me at 'sean@caltech.edu'.
- Reading this book impairs your ability to drive a car or operate machinery.
- This book has been found to cause drowsiness in laboratory animals.
- This book contains twenty-three times the US RDA of fiber.
- Caution: FLAMMABLE - Do not read while smoking or near a fire.
- If infection, rash, or irritation develops, discontinue use and consult a physician.
- Warning: For external use only. Use only as directed. Intentional misuse by deliberately concentrating contents can be harmful or fatal. KEEP OUT OF REACH OF CHILDREN.
- In the unlikely event of a water landing do not use this book as a flotation device.
- The material in this text is fiction; any resemblance to real theorems, living or dead, is purely coincidental.
- This is by far the most amusing section of this book.
- Finding the typos and mistakes in this book is left as an exercise for the reader. (Eye owes a spelling chequer from thyme too thyme, sew their should knot bee two many misspellings. Though I ain't so sure the grammar's too good.)
- The theorems and methods in this text are subject to change without notice.
- This is a chain book. If you do not make seven copies and distribute them to your friends within ten days of obtaining this text you will suffer great misfortune and other nastiness.
- The surgeon general has determined that excessive studying is detrimental to your social life.

- This text has been buffered for your protection and ribbed for your pleasure.
- Stop reading this rubbish and get back to work!

## 0.4 Suggested Use

This text is well suited to the student, professional or lay-person. It makes a superb gift. This text has a bouquet that is light and fruity, with some earthy undertones. It is ideal with dinner or as an aperitif. Bon appetit!

## 0.5 About the Title

The title is only making light of naming conventions in the sciences and is not an insult to engineers. If you want to learn about some mathematical subject, look for books with “Introduction” or “Elementary” in the title. If it is an “Intermediate” text it will be incomprehensible. If it is “Advanced” then not only will it be incomprehensible, it will have low production qualities, i.e. a crappy typewriter font, no graphics and no examples. There is an exception to this rule: When the title also contains the word “Scientists” or “Engineers” the advanced book may be quite suitable for actually learning the material.



# Part I

# Algebra

# Chapter 1

## Sets and Functions

### 1.1 Sets

**Definition.** A *set* is a collection of objects. We call the objects, *elements*. A set is denoted by listing the elements between braces. For example:  $\{e, i, \pi, 1\}$  is the set of the integer 1, the pure imaginary number  $i = \sqrt{-1}$  and the transcendental numbers  $e = 2.7182818\dots$  and  $\pi = 3.1415926\dots$ . For elements of a set, we do not count multiplicities. We regard the set  $\{1, 2, 2, 3, 3, 3\}$  as identical to the set  $\{1, 2, 3\}$ . Order is not significant in sets. The set  $\{1, 2, 3\}$  is equivalent to  $\{3, 2, 1\}$ .

In enumerating the elements of a set, we use ellipses to indicate patterns. We denote the set of positive integers as  $\{1, 2, 3, \dots\}$ . We also denote sets with the notation  $\{x \mid \text{conditions on } x\}$  for sets that are more easily described than enumerated. This is read as “the set of elements  $x$  such that  $\dots$ ”.  $x \in S$  is the notation for “ $x$  is an element of the set  $S$ .” To express the opposite we have  $x \notin S$  for “ $x$  is not an element of the set  $S$ .”

**Examples.** We have notations for denoting some of the commonly encountered sets.

- $\emptyset = \{\}$  is the *empty set*, the set containing no elements.
- $\mathbb{Z} = \{\dots, -3, -2, -1, 0, 1, 2, 3, \dots\}$  is the set of *integers*. (Z is for “Zahlen”, the German word for “number”.)

- $\mathbb{Q} = \{p/q | p, q \in \mathbb{Z}, q \neq 0\}$  is the set of *rational numbers*. (Q is for quotient.) <sup>1</sup>
- $\mathbb{R} = \{x | x = a_1a_2 \cdots a_n.b_1b_2 \cdots\}$  is the set of *real numbers*, i.e. the set of numbers with decimal expansions. <sup>2</sup>
- $\mathbb{C} = \{a + ib | a, b \in \mathbb{R}, i^2 = -1\}$  is the set of *complex numbers*.  $i$  is the square root of  $-1$ . (If you haven't seen complex numbers before, don't dismay. We'll cover them later.)
- $\mathbb{Z}^+$ ,  $\mathbb{Q}^+$  and  $\mathbb{R}^+$  are the sets of positive integers, rationals and reals, respectively. For example,  $\mathbb{Z}^+ = \{1, 2, 3, \dots\}$ . We use a  $-$  superscript to denote the sets of negative numbers.
- $\mathbb{Z}^{0+}$ ,  $\mathbb{Q}^{0+}$  and  $\mathbb{R}^{0+}$  are the sets of non-negative integers, rationals and reals, respectively. For example,  $\mathbb{Z}^{0+} = \{0, 1, 2, \dots\}$ .
- $(a \dots b)$  denotes an *open interval* on the real axis.  $(a \dots b) \equiv \{x | x \in \mathbb{R}, a < x < b\}$
- We use brackets to denote the *closed interval*.  $[a..b] \equiv \{x | x \in \mathbb{R}, a \leq x \leq b\}$

The *cardinality* or *order* of a set  $S$  is denoted  $|S|$ . For finite sets, the cardinality is the number of elements in the set. The *Cartesian product* of two sets is the set of ordered pairs:

$$X \times Y \equiv \{(x, y) | x \in X, y \in Y\}.$$

The Cartesian product of  $n$  sets is the set of ordered n-tuples:

$$X_1 \times X_2 \times \cdots \times X_n \equiv \{(x_1, x_2, \dots, x_n) | x_1 \in X_1, x_2 \in X_2, \dots, x_n \in X_n\}.$$

**Equality.** Two sets  $S$  and  $T$  are *equal* if each element of  $S$  is an element of  $T$  and vice versa. This is denoted,  $S = T$ . Inequality is  $S \neq T$ , of course.  $S$  is a *subset* of  $T$ ,  $S \subseteq T$ , if every element of  $S$  is an element of  $T$ .  $S$  is a *proper subset* of  $T$ ,  $S \subset T$ , if  $S \subseteq T$  and  $S \neq T$ . For example: The empty set is a subset of every set,  $\emptyset \subseteq S$ . The rational numbers are a proper subset of the real numbers,  $\mathbb{Q} \subset \mathbb{R}$ .

---

<sup>1</sup> Note that with this description, we enumerate each rational number an infinite number of times. For example:  $1/2 = 2/4 = 3/6 = (-1)/(-2) = \dots$ . This does not pose a problem as we do not count multiplicities.

<sup>2</sup>Guess what R is for.

**Operations.** The *union* of two sets,  $S \cup T$ , is the set whose elements are in either of the two sets. The union of  $n$  sets,

$$\cup_{j=1}^n S_j \equiv S_1 \cup S_2 \cup \cdots \cup S_n$$

is the set whose elements are in any of the sets  $S_j$ . The *intersection* of two sets,  $S \cap T$ , is the set whose elements are in both of the two sets. In other words, the intersection of two sets is the set of elements that the two sets have in common. The intersection of  $n$  sets,

$$\cap_{j=1}^n S_j \equiv S_1 \cap S_2 \cap \cdots \cap S_n$$

is the set whose elements are in all of the sets  $S_j$ . If two sets have no elements in common,  $S \cap T = \emptyset$ , then the sets are *disjoint*. If  $T \subseteq S$ , then the *difference* between  $S$  and  $T$ ,  $S \setminus T$ , is the set of elements in  $S$  which are not in  $T$ .

$$S \setminus T \equiv \{x | x \in S, x \notin T\}$$

The difference of sets is also denoted  $S - T$ .

**Properties.** The following properties are easily verified from the above definitions.

- $S \cup \emptyset = S$ ,  $S \cap \emptyset = \emptyset$ ,  $S \setminus \emptyset = S$ ,  $S \setminus S = \emptyset$ .
- Commutative.  $S \cup T = T \cup S$ ,  $S \cap T = T \cap S$ .
- Associative.  $(S \cup T) \cup U = S \cup (T \cup U) = S \cup T \cup U$ ,  $(S \cap T) \cap U = S \cap (T \cap U) = S \cap T \cap U$ .
- Distributive.  $S \cup (T \cap U) = (S \cup T) \cap (S \cup U)$ ,  $S \cap (T \cup U) = (S \cap T) \cup (S \cap U)$ .

## 1.2 Single Valued Functions

**Single-Valued Functions.** A *single-valued function* or *single-valued mapping* is a mapping of the elements  $x \in X$  into elements  $y \in Y$ . This is expressed as  $f : X \rightarrow Y$  or  $X \xrightarrow{f} Y$ . If such a function is well-defined, then for each  $x \in X$  there exists a unique element of  $Y$  such that  $f(x) = y$ . The set  $X$  is the *domain* of the function,  $Y$  is the *codomain*, (not to be confused with the *range*, which we introduce shortly). To denote the value of a function on a

particular element we can use any of the notations:  $f(x) = y$ ,  $f : x \mapsto y$  or simply  $x \mapsto y$ .  $f$  is the *identity map* on  $X$  if  $f(x) = x$  for all  $x \in X$ .

Let  $f : X \rightarrow Y$ . The *range* or *image* of  $f$  is

$$f(X) = \{y \mid y = f(x) \text{ for some } x \in X\}.$$

The range is a subset of the codomain. For each  $Z \subseteq Y$ , the *inverse image* of  $Z$  is defined:

$$f^{-1}(Z) \equiv \{x \in X \mid f(x) = z \text{ for some } z \in Z\}.$$

### Examples.

- Finite polynomials,  $f(x) = \sum_{k=0}^n a_k x^k$ ,  $a_k \in \mathbb{R}$ , and the exponential function,  $f(x) = e^x$ , are examples of single valued functions which map real numbers to real numbers.
- The *greatest integer function*,  $f(x) = \lfloor x \rfloor$ , is a mapping from  $\mathbb{R}$  to  $\mathbb{Z}$ .  $\lfloor x \rfloor$  is defined as the greatest integer less than or equal to  $x$ . Likewise, the *least integer function*,  $f(x) = \lceil x \rceil$ , is the least integer greater than or equal to  $x$ .

**The -jectives.** A function is *injective* if for each  $x_1 \neq x_2$ ,  $f(x_1) \neq f(x_2)$ . In other words, distinct elements are mapped to distinct elements.  $f$  is *surjective* if for each  $y$  in the codomain, there is an  $x$  such that  $y = f(x)$ . If a function is both injective and surjective, then it is *bijective*. A bijective function is also called a *one-to-one mapping*.

### Examples.

- The exponential function  $f(x) = e^x$ , considered as a mapping from  $\mathbb{R}$  to  $\mathbb{R}^+$ , is bijective, (a one-to-one mapping).
- $f(x) = x^2$  is a bijection from  $\mathbb{R}^+$  to  $\mathbb{R}^+$ .  $f$  is not injective from  $\mathbb{R}$  to  $\mathbb{R}^+$ . For each positive  $y$  in the range, there are two values of  $x$  such that  $y = x^2$ .
- $f(x) = \sin x$  is not injective from  $\mathbb{R}$  to  $[-1..1]$ . For each  $y \in [-1..1]$  there exists an infinite number of values of  $x$  such that  $y = \sin x$ .

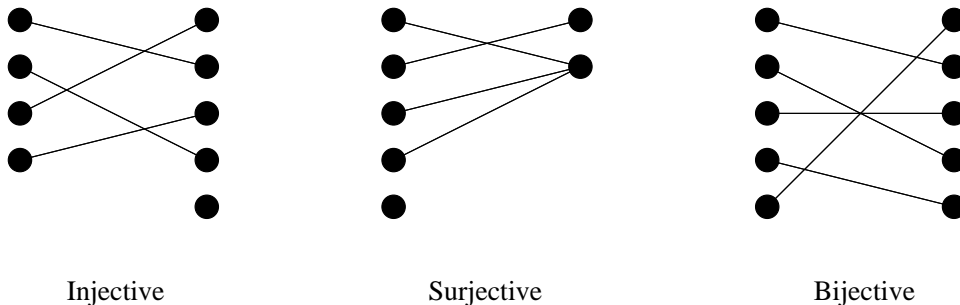

Figure 1.1: Depictions of Injective, Surjective and Bijective Functions

### 1.3 Inverses and Multi-Valued Functions

If  $y = f(x)$ , then we can write  $x = f^{-1}(y)$  where  $f^{-1}$  is the inverse of  $f$ . If  $y = f(x)$  is a one-to-one function, then  $f^{-1}(y)$  is also a one-to-one function. In this case,  $x = f^{-1}(f(x)) = f(f^{-1}(x))$  for values of  $x$  where both  $f(x)$  and  $f^{-1}(x)$  are defined. For example  $\ln x$ , which maps  $\mathbb{R}^+$  to  $\mathbb{R}$  is the inverse of  $e^x$ .  $x = e^{\ln x} = \ln(e^x)$  for all  $x \in \mathbb{R}^+$ . (Note the  $x \in \mathbb{R}^+$  ensures that  $\ln x$  is defined.)

If  $y = f(x)$  is a many-to-one function, then  $x = f^{-1}(y)$  is a one-to-many function.  $f^{-1}(y)$  is a multi-valued function. We have  $x = f(f^{-1}(x))$  for values of  $x$  where  $f^{-1}(x)$  is defined, however  $x \neq f^{-1}(f(x))$ . There are diagrams showing one-to-one, many-to-one and one-to-many functions in Figure 1.2.

**Example 1.3.1**  $y = x^2$ , a many-to-one function has the inverse  $x = y^{1/2}$ . For each positive  $y$ , there are two values of  $x$  such that  $x = y^{1/2}$ .  $y = x^2$  and  $y = x^{1/2}$  are graphed in Figure 1.3.

We say that there are two *branches* of  $y = x^{1/2}$ : the positive and the negative branch. We denote the positive branch as  $y = \sqrt{x}$ ; the negative branch is  $y = -\sqrt{x}$ . We call  $\sqrt{x}$  the *principal branch* of  $x^{1/2}$ . Note that  $\sqrt{x}$  is a one-to-one function. Finally,  $x = (x^{1/2})^2$  since  $(\pm\sqrt{x})^2 = x$ , but  $x \neq (x^2)^{1/2}$  since  $(x^2)^{1/2} = \pm x$ .  $y = \sqrt{x}$  is graphed in Figure 1.4.

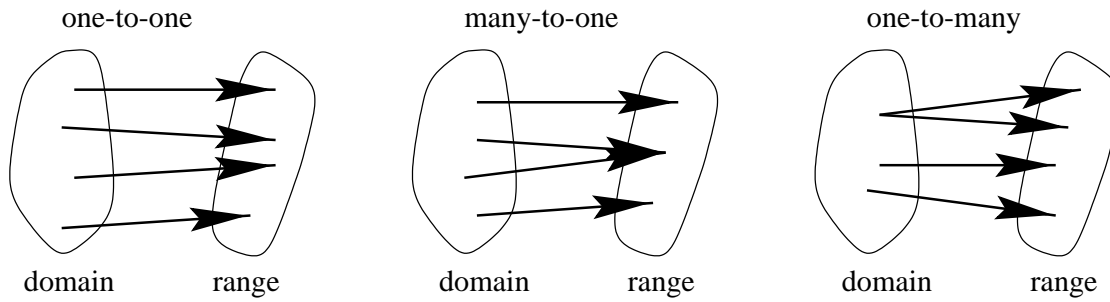

Figure 1.2: Diagrams of One-To-One, Many-To-One and One-To-Many Functions

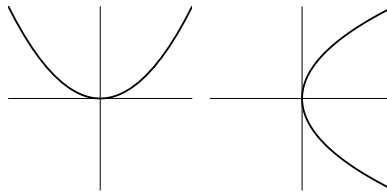

Figure 1.3:  $y = x^2$  and  $y = x^{1/2}$

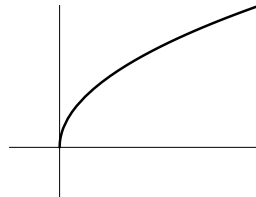

Figure 1.4:  $y = \sqrt{x}$

Now consider the many-to-one function  $y = \sin x$ . The inverse is  $x = \arcsin y$ . For each  $y \in [-1..1]$  there are an infinite number of values  $x$  such that  $x = \arcsin y$ . In Figure 1.5 is a graph of  $y = \sin x$  and a graph of a few branches of  $y = \arcsin x$ .

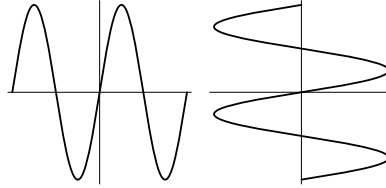

Figure 1.5:  $y = \sin x$  and  $y = \arcsin x$

**Example 1.3.2**  $\arcsin x$  has an infinite number of branches. We will denote the principal branch by  $\text{Arcsin } x$  which maps  $[-1..1]$  to  $[-\frac{\pi}{2}..\frac{\pi}{2}]$ . Note that  $x = \sin(\arcsin x)$ , but  $x \neq \arcsin(\sin x)$ .  $y = \text{Arcsin } x$  in Figure 1.6.

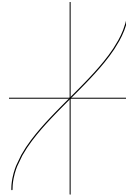

Figure 1.6:  $y = \text{Arcsin } x$

**Example 1.3.3** Consider  $1^{1/3}$ . Since  $x^3$  is a one-to-one function,  $x^{1/3}$  is a single-valued function. (See Figure 1.7.)  $1^{1/3} = 1$ .

**Example 1.3.4** Consider  $\arccos(1/2)$ .  $\cos x$  and a portion of  $\arccos x$  are graphed in Figure 1.8. The equation  $\cos x = 1/2$  has the two solutions  $x = \pm\pi/3$  in the range  $x \in (-\pi..\pi]$ . We use the periodicity of the cosine,



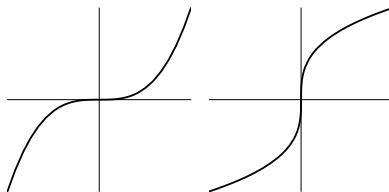

Figure 1.7:  $y = x^3$  and  $y = x^{1/3}$

$\cos(x + 2\pi) = \cos x$ , to find the remaining solutions.

$$\arccos(1/2) = \{\pm\pi/3 + 2n\pi\}, \quad n \in \mathbb{Z}.$$

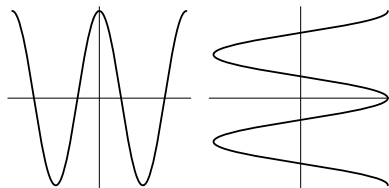

Figure 1.8:  $y = \cos x$  and  $y = \arccos x$

## 1.4 Transforming Equations

Consider the equation  $g(x) = h(x)$  and the single-valued function  $f(x)$ . A particular value of  $x$  is a solution of the equation if substituting that value into the equation results in an identity. In determining the solutions of an equation, we often apply functions to each side of the equation in order to simplify its form. We apply the function to obtain a second equation,  $f(g(x)) = f(h(x))$ . If  $x = \xi$  is a solution of the former equation, (let  $\psi = g(\xi) = h(\xi)$ ), then it

is necessarily a solution of latter. This is because  $f(g(\xi)) = f(h(\xi))$  reduces to the identity  $f(\psi) = f(\psi)$ . If  $f(x)$  is bijective, then the converse is true: any solution of the latter equation is a solution of the former equation. Suppose that  $x = \xi$  is a solution of the latter,  $f(g(\xi)) = f(h(\xi))$ . That  $f(x)$  is a one-to-one mapping implies that  $g(\xi) = h(\xi)$ . Thus  $x = \xi$  is a solution of the former equation.

It is always safe to apply a one-to-one, (bijective), function to an equation, (provided it is defined for that domain). For example, we can apply  $f(x) = x^3$  or  $f(x) = e^x$ , considered as mappings on  $\mathbb{R}$ , to the equation  $x = 1$ . The equations  $x^3 = 1$  and  $e^x = e$  each have the unique solution  $x = 1$  for  $x \in \mathbb{R}$ .

In general, we must take care in applying functions to equations. If we apply a many-to-one function, we may introduce spurious solutions. Applying  $f(x) = x^2$  to the equation  $x = \frac{\pi}{2}$  results in  $x^2 = \frac{\pi^2}{4}$ , which has the two solutions,  $x = \{\pm\frac{\pi}{2}\}$ . Applying  $f(x) = \sin x$  results in  $x^2 = \frac{\pi^2}{4}$ , which has an infinite number of solutions,  $x = \{\frac{\pi}{2} + 2n\pi \mid n \in \mathbb{Z}\}$ .

We do not generally apply a one-to-many, (multi-valued), function to both sides of an equation as this rarely is useful. Rather, we typically use the definition of the inverse function. Consider the equation

$$\sin^2 x = 1.$$

Applying the function  $f(x) = x^{1/2}$  to the equation would not get us anywhere.

$$(\sin^2 x)^{1/2} = 1^{1/2}$$

Since  $(\sin^2 x)^{1/2} \neq \sin x$ , we cannot simplify the left side of the equation. Instead we could use the definition of  $f(x) = x^{1/2}$  as the inverse of the  $x^2$  function to obtain

$$\sin x = 1^{1/2} = \pm 1.$$

Now note that we should not just apply  $\arcsin$  to both sides of the equation as  $\arcsin(\sin x) \neq x$ . Instead we use the definition of  $\arcsin$  as the inverse of  $\sin$ .

$$x = \arcsin(\pm 1)$$

$x = \arcsin(1)$  has the solutions  $x = \pi/2 + 2n\pi$  and  $x = \arcsin(-1)$  has the solutions  $x = -\pi/2 + 2n\pi$ . We enumerate the solutions.

$$x = \left\{ \frac{\pi}{2} + n\pi \mid n \in \mathbb{Z} \right\}$$

## 1.5 Exercises

### Exercise 1.1

The area of a circle is directly proportional to the square of its diameter. What is the constant of proportionality?

[Hint](#), [Solution](#)

### Exercise 1.2

Consider the equation

$$\frac{x+1}{y-2} = \frac{x^2-1}{y^2-4}.$$

1. Why might one think that this is the equation of a line?
2. Graph the solutions of the equation to demonstrate that it is not the equation of a line.

[Hint](#), [Solution](#)

### Exercise 1.3

Consider the function of a real variable,

$$f(x) = \frac{1}{x^2 + 2}.$$

What is the domain and range of the function?

[Hint](#), [Solution](#)

### Exercise 1.4

The temperature measured in degrees Celsius <sup>3</sup> is linearly related to the temperature measured in degrees Fahrenheit <sup>4</sup>. Water freezes at  $0^\circ C = 32^\circ F$  and boils at  $100^\circ C = 212^\circ F$ . Write the temperature in degrees Celsius as a function of degrees Fahrenheit.

---

<sup>3</sup> Originally, it was called degrees *Centigrade*. *centi* because there are 100 degrees between the two calibration points. It is now called degrees Celsius in honor of the inventor.

<sup>4</sup> The Fahrenheit scale, named for Daniel Fahrenheit, was originally calibrated with the freezing point of salt-saturated water to be  $0^\circ$ . Later, the calibration points became the freezing point of water,  $32^\circ$ , and body temperature,  $96^\circ$ . With this method, there are 64 divisions between the calibration points. Finally, the upper calibration point was changed to the boiling point of water at  $212^\circ$ . This gave 180 divisions, (the number of degrees in a half circle), between the two calibration points.

Hint, Solution

### Exercise 1.5

Consider the function graphed in Figure 1.9. Sketch graphs of  $f(-x)$ ,  $f(x+3)$ ,  $f(3-x)+2$ , and  $f^{-1}(x)$ . You may use the blank grids in Figure 1.10.

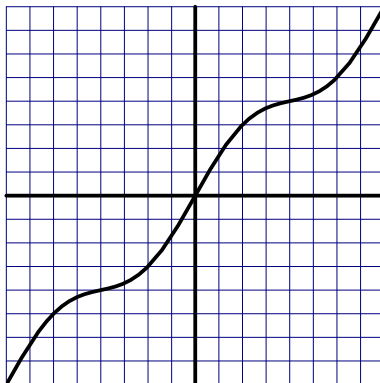

Figure 1.9: Graph of the function.

Hint, Solution

### Exercise 1.6

A culture of bacteria grows at the rate of 10% per minute. At 6:00 pm there are 1 billion bacteria. How many bacteria are there at 7:00 pm? How many were there at 3:00 pm?

Hint, Solution

### Exercise 1.7

The graph in Figure 1.11 shows an even function  $f(x) = p(x)/q(x)$  where  $p(x)$  and  $q(x)$  are rational quadratic polynomials. Give possible formulas for  $p(x)$  and  $q(x)$ .

Hint, Solution

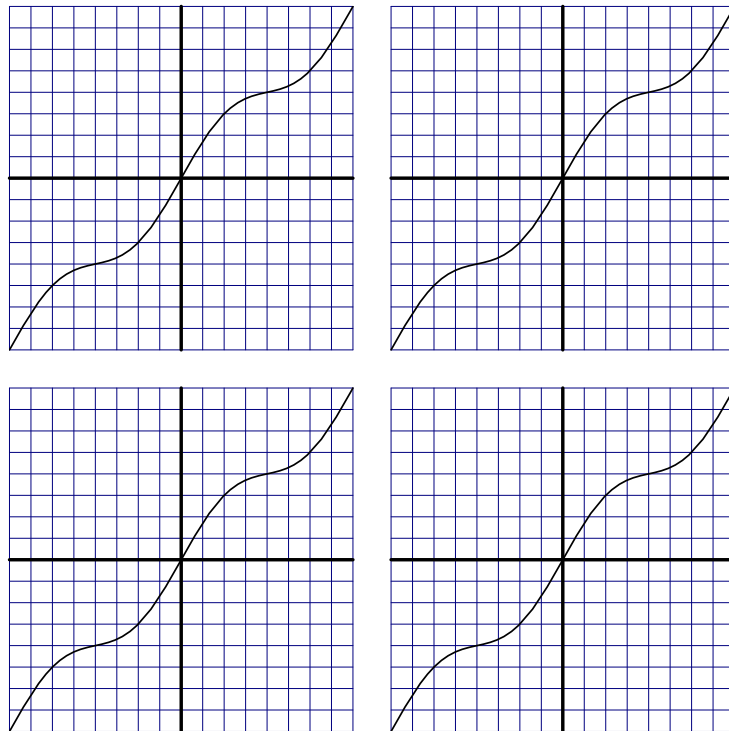

Figure 1.10: Blank grids.

**Exercise 1.8**

Find a polynomial of degree 100 which is zero only at  $x = -2, 1, \pi$  and is non-negative.

[Hint](#), [Solution](#)

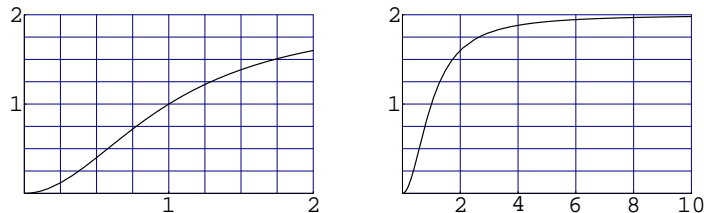

Figure 1.11: Plots of  $f(x) = p(x)/q(x)$ .

## 1.6 Hints

### Hint 1.1

area = constant  $\times$  diameter<sup>2</sup>.

### Hint 1.2

A pair  $(x, y)$  is a solution of the equation if it make the equation an identity.

### Hint 1.3

The domain is the subset of  $\mathbb{R}$  on which the function is defined.

### Hint 1.4

Find the slope and  $x$ -intercept of the line.

### Hint 1.5

The inverse of the function is the reflection of the function across the line  $y = x$ .

### Hint 1.6

The formula for geometric growth/decay is  $x(t) = x_0 r^t$ , where  $r$  is the rate.

**Hint 1.7**

Note that  $p(x)$  and  $q(x)$  appear as a ratio, they are determined only up to a multiplicative constant. We may take the leading coefficient of  $q(x)$  to be unity.

$$f(x) = \frac{p(x)}{q(x)} = \frac{ax^2 + bx + c}{x^2 + \beta x + \chi}$$

Use the properties of the function to solve for the unknown parameters.

**Hint 1.8**

Write the polynomial in factored form.

# 1.7 Solutions

## Solution 1.1

$$\begin{aligned}\text{area} &= \pi \times \text{radius}^2 \\ \text{area} &= \frac{\pi}{4} \times \text{diameter}^2\end{aligned}$$

The constant of proportionality is  $\frac{\pi}{4}$ .

## Solution 1.2

1. If we multiply the equation by  $y^2 - 4$  and divide by  $x + 1$ , we obtain the equation of a line.

$$y + 2 = x - 1$$

2. We factor the quadratics on the right side of the equation.

$$\frac{x + 1}{y - 2} = \frac{(x + 1)(x - 1)}{(y - 2)(y + 2)}.$$

We note that one or both sides of the equation are undefined at  $y = \pm 2$  because of division by zero. There are no solutions for these two values of  $y$  and we assume from this point that  $y \neq \pm 2$ . We multiply by  $(y - 2)(y + 2)$ .

$$(x + 1)(y + 2) = (x + 1)(x - 1)$$

For  $x = -1$ , the equation becomes the identity  $0 = 0$ . Now we consider  $x \neq -1$ . We divide by  $x + 1$  to obtain the equation of a line.

$$\begin{aligned}y + 2 &= x - 1 \\ y &= x - 3\end{aligned}$$

Now we collect the solutions we have found.

$$\boxed{\{(-1, y) : y \neq \pm 2\} \cup \{(x, x - 3) : x \neq -1, 5\}}$$

The solutions are depicted in Figure /reffig not a line.



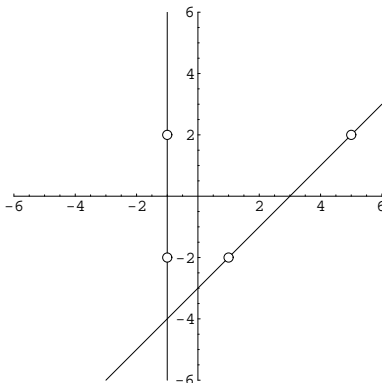

Figure 1.12: The solutions of  $\frac{x+1}{y-2} = \frac{x^2-1}{y^2-4}$ .

### Solution 1.3

The denominator is nonzero for all  $x \in \mathbb{R}$ . Since we don't have any division by zero problems, the domain of the function is  $\mathbb{R}$ . For  $x \in \mathbb{R}$ ,

$$0 < \frac{1}{x^2 + 2} \leq 2.$$

Consider

$$y = \frac{1}{x^2 + 2}. \tag{1.1}$$

For any  $y \in (0 \dots 1/2]$ , there is at least one value of  $x$  that satisfies Equation 1.1.

$$\begin{aligned} x^2 + 2 &= \frac{1}{y} \\ x &= \pm \sqrt{\frac{1}{y} - 2} \end{aligned}$$

Thus the range of the function is  $(0 \dots 1/2]$

**Solution 1.4**

Let  $c$  denote degrees Celsius and  $f$  denote degrees Fahrenheit. The line passes through the points  $(f, c) = (32, 0)$  and  $(f, c) = (212, 100)$ . The  $x$ -intercept is  $f = 32$ . We calculate the slope of the line.

$$\text{slope} = \frac{100 - 0}{212 - 32} = \frac{100}{180} = \frac{5}{9}$$

The relationship between fahrenheit and celcius is

$$c = \frac{5}{9}(f - 32).$$

**Solution 1.5**

We plot the various transformations of  $f(x)$ .

**Solution 1.6**

The formula for geometric growth/decay is  $x(t) = x_0 r^t$ , where  $r$  is the rate. Let  $t = 0$  coincide with 6:00 pm. We determine  $x_0$ .

$$x(0) = 10^9 = x_0 \left(\frac{11}{10}\right)^0 = x_0$$
$$x_0 = 10^9$$

At 7:00 pm the number of bacteria is

$$10^9 \left(\frac{11}{10}\right)^{60} = \frac{11^{60}}{10^{51}} \approx 3.04 \times 10^{11}$$

At 3:00 pm the number of bacteria was

$$10^9 \left(\frac{11}{10}\right)^{-180} = \frac{10^{189}}{11^{180}} \approx 35.4$$

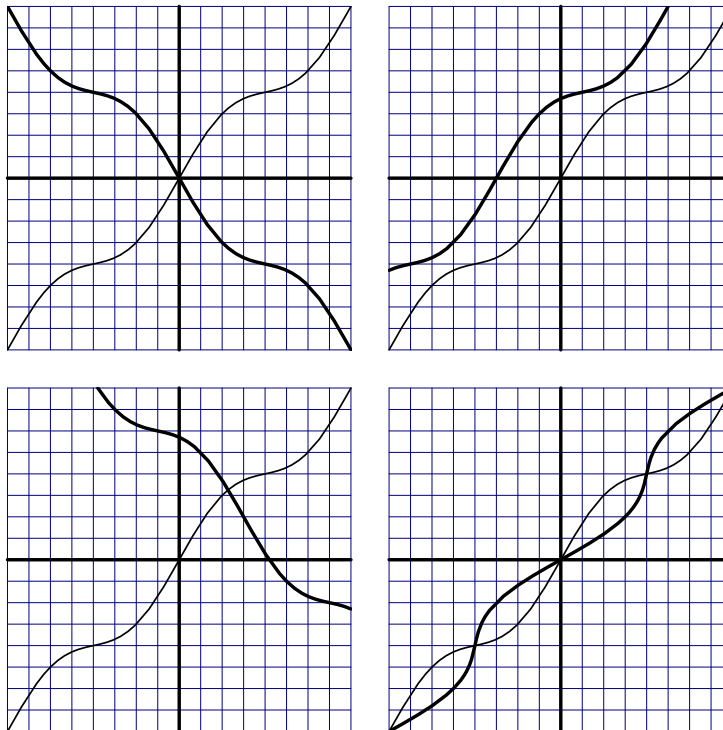

Figure 1.13: Graphs of  $f(-x)$ ,  $f(x+3)$ ,  $f(3-x)+2$ , and  $f^{-1}(x)$ .

### Solution 1.7

We write  $p(x)$  and  $q(x)$  as general quadratic polynomials.

$$f(x) = \frac{p(x)}{q(x)} = \frac{ax^2 + bx + c}{\alpha x^2 + \beta x + \chi}$$

We will use the properties of the function to solve for the unknown parameters.

Note that  $p(x)$  and  $q(x)$  appear as a ratio, they are determined only up to a multiplicative constant. We may take the leading coefficient of  $q(x)$  to be unity.

$$f(x) = \frac{p(x)}{q(x)} = \frac{ax^2 + bx + c}{x^2 + \beta x + \chi}$$

$f(x)$  has a second order zero at  $x = 0$ . This means that  $p(x)$  has a second order zero there and that  $\chi \neq 0$ .

$$f(x) = \frac{ax^2}{x^2 + \beta x + \chi}$$

We note that  $f(x) \rightarrow 2$  as  $x \rightarrow \infty$ . This determines the parameter  $a$ .

$$\begin{aligned} \lim_{x \rightarrow \infty} f(x) &= \lim_{x \rightarrow \infty} \frac{ax^2}{x^2 + \beta x + \chi} \\ &= \lim_{x \rightarrow \infty} \frac{2ax}{2x + \beta} \\ &= \lim_{x \rightarrow \infty} \frac{2a}{2} \\ &= a \end{aligned}$$

$$f(x) = \frac{2x^2}{x^2 + \beta x + \chi}$$

Now we use the fact that  $f(x)$  is even to conclude that  $q(x)$  is even and thus  $\beta = 0$ .

$$f(x) = \frac{2x^2}{x^2 + \chi}$$

Finally, we use that  $f(1) = 1$  to determine  $\chi$ .

$$\boxed{f(x) = \frac{2x^2}{x^2 + 1}}$$

**Solution 1.8**

Consider the polynomial

$$p(x) = (x + 2)^{40}(x - 1)^{30}(x - \pi)^{30}.$$

It is of degree 100. Since the factors only vanish at  $x = -2, 1, \pi$ ,  $p(x)$  only vanishes there. Since factors are non-negative, the polynomial is non-negative.

# Chapter 2

## Vectors

### 2.1 Vectors

#### 2.1.1 Scalars and Vectors

A *vector* is a quantity having both a magnitude and a direction. Examples of vector quantities are velocity, force and position. One can represent a vector in  $n$ -dimensional space with an arrow whose initial point is at the origin, (Figure 2.1). The magnitude is the length of the vector. Typographically, variables representing vectors are often written in capital letters, bold face or with a vector over-line,  $A$ ,  $\mathbf{a}$ ,  $\vec{a}$ . The magnitude of a vector is denoted  $|\mathbf{a}|$ .

A *scalar* has only a magnitude. Examples of scalar quantities are mass, time and speed.

**Vector Algebra.** Two vectors are equal if they have the same magnitude and direction. The negative of a vector, denoted  $-\mathbf{a}$ , is a vector of the same magnitude as  $\mathbf{a}$  but in the opposite direction. We add two vectors  $\mathbf{a}$  and  $\mathbf{b}$  by placing the tail of  $\mathbf{b}$  at the head of  $\mathbf{a}$  and defining  $\mathbf{a} + \mathbf{b}$  to be the vector with tail at the origin and head at the head of  $\mathbf{b}$ . (See Figure 2.2.)

The difference,  $\mathbf{a} - \mathbf{b}$ , is defined as the sum of  $\mathbf{a}$  and the negative of  $\mathbf{b}$ ,  $\mathbf{a} + (-\mathbf{b})$ . The result of multiplying  $\mathbf{a}$  by a scalar  $\alpha$  is a vector of magnitude  $|\alpha| |\mathbf{a}|$  with the same/opposite direction if  $\alpha$  is positive/negative. (See Figure 2.2.)

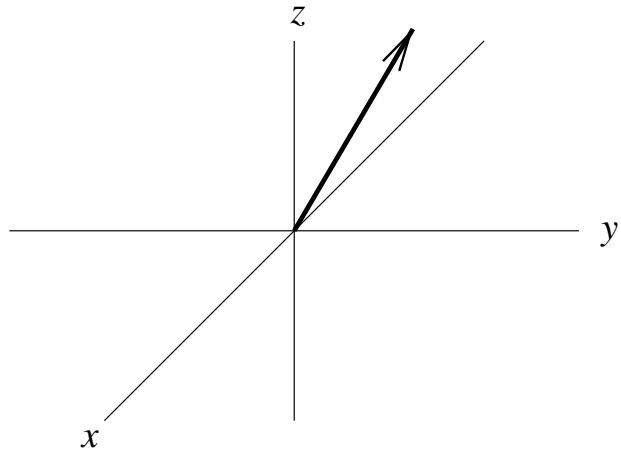

Figure 2.1: Graphical representation of a vector in three dimensions.

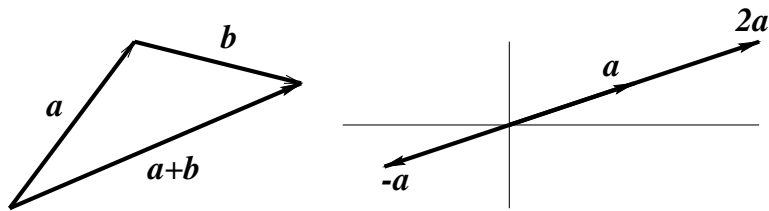

Figure 2.2: Vector arithmetic.

Here are the properties of adding vectors and multiplying them by a scalar. They are evident from geometric

considerations.

$\mathbf{a} + \mathbf{b} = \mathbf{b} + \mathbf{a}$	$\alpha\mathbf{a} = \mathbf{a}\alpha$	commutative laws
$(\mathbf{a} + \mathbf{b}) + \mathbf{c} = \mathbf{a} + (\mathbf{b} + \mathbf{c})$	$\alpha(\beta\mathbf{a}) = (\alpha\beta)\mathbf{a}$	associative laws
$\alpha(\mathbf{a} + \mathbf{b}) = \alpha\mathbf{a} + \alpha\mathbf{b}$	$(\alpha + \beta)\mathbf{a} = \alpha\mathbf{a} + \beta\mathbf{a}$	distributive laws

**Zero and Unit Vectors.** The additive identity element for vectors is the *zero vector* or *null vector*. This is a vector of magnitude zero which is denoted as  $\mathbf{0}$ . A *unit vector* is a vector of magnitude one. If  $\mathbf{a}$  is nonzero then  $\mathbf{a}/|\mathbf{a}|$  is a unit vector in the direction of  $\mathbf{a}$ . Unit vectors are often denoted with a caret over-line,  $\hat{\mathbf{n}}$ .

**Rectangular Unit Vectors.** In  $n$  dimensional Cartesian space,  $\mathbb{R}^n$ , the unit vectors in the directions of the coordinates axes are  $\mathbf{e}_1, \dots, \mathbf{e}_n$ . These are called the *rectangular unit vectors*. To cut down on subscripts, the unit vectors in three dimensional space are often denoted with  $\mathbf{i}$ ,  $\mathbf{j}$  and  $\mathbf{k}$ . (Figure 2.3).

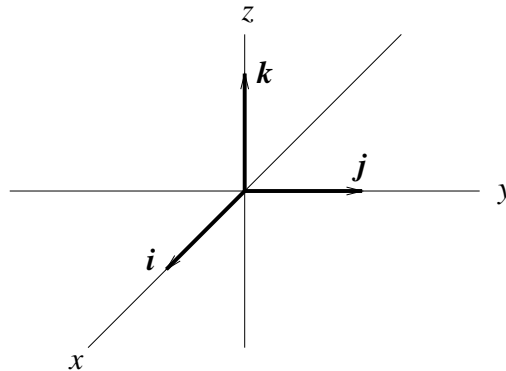

Figure 2.3: Rectangular unit vectors.



**Components of a Vector.** Consider a vector  $\mathbf{a}$  with tail at the origin and head having the Cartesian coordinates  $(a_1, \dots, a_n)$ . We can represent this vector as the sum of  $n$  *rectangular component vectors*,  $\mathbf{a} = a_1\mathbf{e}_1 + \dots + a_n\mathbf{e}_n$ . (See Figure 2.4.) Another notation for the vector  $\mathbf{a}$  is  $\langle a_1, \dots, a_n \rangle$ . By the Pythagorean theorem, the magnitude of the vector  $\mathbf{a}$  is  $|\mathbf{a}| = \sqrt{a_1^2 + \dots + a_n^2}$ .

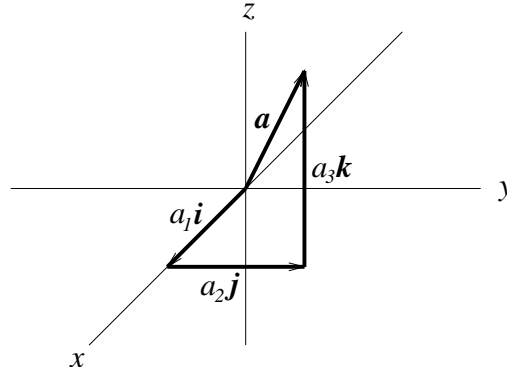

Figure 2.4: Components of a vector.

## 2.1.2 The Kronecker Delta and Einstein Summation Convention

The Kronecker Delta tensor is defined

$$\delta_{ij} = \begin{cases} 1 & \text{if } i = j, \\ 0 & \text{if } i \neq j. \end{cases}$$

This notation will be useful in our work with vectors.

Consider writing a vector in terms of its rectangular components. Instead of using ellipses:  $\mathbf{a} = a_1\mathbf{e}_1 + \dots + a_n\mathbf{e}_n$ , we could write the expression as a sum:  $\mathbf{a} = \sum_{i=1}^n a_i\mathbf{e}_i$ . We can shorten this notation by leaving out the sum:  $\mathbf{a} = a_i\mathbf{e}_i$ , where it is understood that whenever an index is repeated in a term we sum over that index from 1 to  $n$ . This is the

*Einstein summation convention.* A repeated index is called a *summation index* or a *dummy index*. Other indices can take any value from 1 to  $n$  and are called *free indices*.

**Example 2.1.1** Consider the matrix equation:  $\mathbf{A} \cdot \mathbf{x} = \mathbf{b}$ . We can write out the matrix and vectors explicitly.

$$\begin{pmatrix} a_{11} & \cdots & a_{1n} \\ \vdots & \ddots & \vdots \\ a_{n1} & \cdots & a_{nn} \end{pmatrix} \begin{pmatrix} x_1 \\ \vdots \\ x_n \end{pmatrix} = \begin{pmatrix} b_1 \\ \vdots \\ b_n \end{pmatrix}$$

This takes much less space when we use the summation convention.

$$a_{ij}x_j = b_i$$

Here  $j$  is a summation index and  $i$  is a free index.

### 2.1.3 The Dot and Cross Product

**Dot Product.** The *dot product* or *scalar product* of two vectors is defined,

$$\mathbf{a} \cdot \mathbf{b} \equiv |\mathbf{a}||\mathbf{b}| \cos \theta,$$

where  $\theta$  is the angle from  $\mathbf{a}$  to  $\mathbf{b}$ . From this definition one can derive the following properties:

- $\mathbf{a} \cdot \mathbf{b} = \mathbf{b} \cdot \mathbf{a}$ , commutative.
- $\alpha(\mathbf{a} \cdot \mathbf{b}) = (\alpha\mathbf{a}) \cdot \mathbf{b} = \mathbf{a} \cdot (\alpha\mathbf{b})$ , associativity of scalar multiplication.
- $\mathbf{a} \cdot (\mathbf{b} + \mathbf{c}) = \mathbf{a} \cdot \mathbf{b} + \mathbf{a} \cdot \mathbf{c}$ , distributive. (See Exercise 2.1.)
- $\mathbf{e}_i \mathbf{e}_j = \delta_{ij}$ . In three dimensions, this is

$$\mathbf{i} \cdot \mathbf{i} = \mathbf{j} \cdot \mathbf{j} = \mathbf{k} \cdot \mathbf{k} = 1, \quad \mathbf{i} \cdot \mathbf{j} = \mathbf{j} \cdot \mathbf{k} = \mathbf{k} \cdot \mathbf{i} = 0.$$

- $\mathbf{a} \cdot \mathbf{b} = a_i b_i \equiv a_1 b_1 + \cdots + a_n b_n$ , dot product in terms of rectangular components.
- If  $\mathbf{a} \cdot \mathbf{b} = 0$  then either  $\mathbf{a}$  and  $\mathbf{b}$  are orthogonal, (perpendicular), or one of  $\mathbf{a}$  and  $\mathbf{b}$  are zero.

**The Angle Between Two Vectors.** We can use the dot product to find the angle between two vectors,  $\mathbf{a}$  and  $\mathbf{b}$ . From the definition of the dot product,

$$\mathbf{a} \cdot \mathbf{b} = |\mathbf{a}||\mathbf{b}| \cos \theta.$$

If the vectors are nonzero, then

$$\theta = \arccos \left( \frac{\mathbf{a} \cdot \mathbf{b}}{|\mathbf{a}||\mathbf{b}|} \right).$$

**Example 2.1.2** *What is the angle between  $\mathbf{i}$  and  $\mathbf{i} + \mathbf{j}$ ?*

$$\begin{aligned} \theta &= \arccos \left( \frac{\mathbf{i} \cdot (\mathbf{i} + \mathbf{j})}{|\mathbf{i}||\mathbf{i} + \mathbf{j}|} \right) \\ &= \arccos \left( \frac{1}{\sqrt{2}} \right) \\ &= \frac{\pi}{4}. \end{aligned}$$

**Parametric Equation of a Line.** Consider a line in  $\mathbb{R}^n$  that passes through the point  $\mathbf{a}$  and is parallel to the vector  $\mathbf{t}$ , (tangent). A parametric equation of the line is

$$\mathbf{x} = \mathbf{a} + u\mathbf{t}, \quad u \in \mathbb{R}.$$

**Implicit Equation of a Line In 2D.** Consider a line in  $\mathbb{R}^2$  that passes through the point  $\mathbf{a}$  and is normal, (orthogonal, perpendicular), to the vector  $\mathbf{n}$ . All the lines that are normal to  $\mathbf{n}$  have the property that  $\mathbf{x} \cdot \mathbf{n}$  is a constant, where  $\mathbf{x}$  is any point on the line. (See Figure 2.5.)  $\mathbf{x} \cdot \mathbf{n} = 0$  is the line that is normal to  $\mathbf{n}$  and passes through the origin. The line that is normal to  $\mathbf{n}$  and passes through the point  $\mathbf{a}$  is

$$\mathbf{x} \cdot \mathbf{n} = \mathbf{a} \cdot \mathbf{n}.$$

The normal to a line determines an orientation of the line. The normal points in the direction that is above the line. A point  $\mathbf{b}$  is (above/on/below) the line if  $(\mathbf{b} - \mathbf{a}) \cdot \mathbf{n}$  is (positive/zero/negative). The signed distance of a point

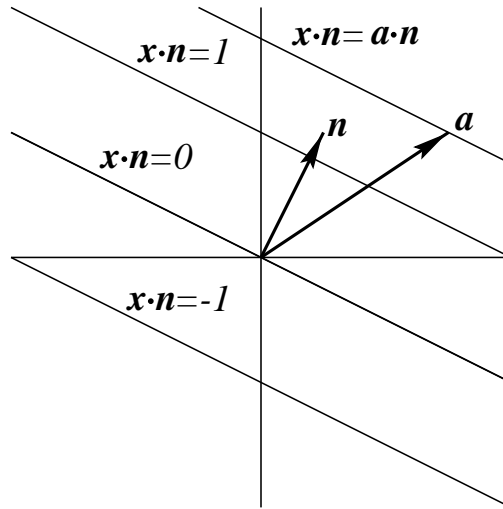

Figure 2.5: Equation for a line.

$\mathbf{b}$  from the line  $\mathbf{x} \cdot \mathbf{n} = \mathbf{a} \cdot \mathbf{n}$  is

$$(\mathbf{b} - \mathbf{a}) \cdot \frac{\mathbf{n}}{|\mathbf{n}|}.$$

**Implicit Equation of a Hyperplane.** A hyperplane in  $\mathbb{R}^n$  is an  $n - 1$  dimensional “sheet” which passes through a given point and is normal to a given direction. In  $\mathbb{R}^3$  we call this a plane. Consider a hyperplane that passes through the point  $\mathbf{a}$  and is normal to the vector  $\mathbf{n}$ . All the hyperplanes that are normal to  $\mathbf{n}$  have the property that  $\mathbf{x} \cdot \mathbf{n}$  is a constant, where  $\mathbf{x}$  is any point in the hyperplane.  $\mathbf{x} \cdot \mathbf{n} = 0$  is the hyperplane that is normal to  $\mathbf{n}$  and passes through the origin. The hyperplane that is normal to  $\mathbf{n}$  and passes through the point  $\mathbf{a}$  is

$$\mathbf{x} \cdot \mathbf{n} = \mathbf{a} \cdot \mathbf{n}.$$

The normal determines an orientation of the hyperplane. The normal points in the direction that is above the hyperplane. A point  $\mathbf{b}$  is (above/on/below) the hyperplane if  $(\mathbf{b} - \mathbf{a}) \cdot \mathbf{n}$  is (positive/zero/negative). The signed

distance of a point  $\mathbf{b}$  from the hyperplane  $\mathbf{x} \cdot \mathbf{n} = \mathbf{a} \cdot \mathbf{n}$  is

$$(\mathbf{b} - \mathbf{a}) \cdot \frac{\mathbf{n}}{|\mathbf{n}|}.$$

**Right and Left-Handed Coordinate Systems.** Consider a rectangular coordinate system in two dimensions. Angles are measured from the positive  $x$  axis in the direction of the positive  $y$  axis. There are two ways of labeling the axes. (See Figure 2.6.) In one the angle increases in the counterclockwise direction and in the other the angle increases in the clockwise direction. The former is the familiar Cartesian coordinate system.

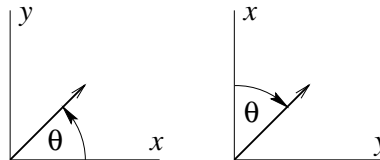

Figure 2.6: There are two ways of labeling the axes in two dimensions.

There are also two ways of labeling the axes in a three-dimensional rectangular coordinate system. These are called right-handed and left-handed coordinate systems. See Figure 2.7. Any other labelling of the axes could be rotated into one of these configurations. The right-handed system is the one that is used by default. If you put your right thumb in the direction of the  $z$  axis in a right-handed coordinate system, then your fingers curl in the direction from the  $x$  axis to the  $y$  axis.

**Cross Product.** The *cross product* or *vector product* is defined,

$$\mathbf{a} \times \mathbf{b} = |\mathbf{a}||\mathbf{b}| \sin \theta \mathbf{n},$$

where  $\theta$  is the angle from  $\mathbf{a}$  to  $\mathbf{b}$  and  $\mathbf{n}$  is a unit vector that is orthogonal to  $\mathbf{a}$  and  $\mathbf{b}$  and in the direction such that the ordered triple of vectors  $\mathbf{a}$ ,  $\mathbf{b}$  and  $\mathbf{n}$  form a right-handed system.

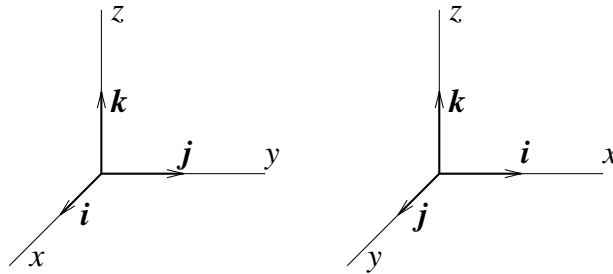

Figure 2.7: Right and left handed coordinate systems.

You can visualize the direction of  $\mathbf{a} \times \mathbf{b}$  by applying the *right hand rule*. Curl the fingers of your right hand in the direction from  $\mathbf{a}$  to  $\mathbf{b}$ . Your thumb points in the direction of  $\mathbf{a} \times \mathbf{b}$ . **Warning:** Unless you are a lefty, get in the habit of putting down your pencil before applying the right hand rule.

The dot and cross products behave a little differently. First note that unlike the dot product, the cross product is not commutative. The magnitudes of  $\mathbf{a} \times \mathbf{b}$  and  $\mathbf{b} \times \mathbf{a}$  are the same, but their directions are opposite. (See Figure 2.8.)

Let

$$\mathbf{a} \times \mathbf{b} = |\mathbf{a}||\mathbf{b}| \sin \theta \mathbf{n} \quad \text{and} \quad \mathbf{b} \times \mathbf{a} = |\mathbf{b}||\mathbf{a}| \sin \phi \mathbf{m}.$$

The angle from  $\mathbf{a}$  to  $\mathbf{b}$  is the same as the angle from  $\mathbf{b}$  to  $\mathbf{a}$ . Since  $\{\mathbf{a}, \mathbf{b}, \mathbf{n}\}$  and  $\{\mathbf{b}, \mathbf{a}, \mathbf{m}\}$  are right-handed systems,  $\mathbf{m}$  points in the opposite direction as  $\mathbf{n}$ . Since  $\mathbf{a} \times \mathbf{b} = -\mathbf{b} \times \mathbf{a}$  we say that the cross product is anti-commutative.

Next we note that since

$$|\mathbf{a} \times \mathbf{b}| = |\mathbf{a}||\mathbf{b}| \sin \theta,$$

the magnitude of  $\mathbf{a} \times \mathbf{b}$  is the area of the parallelogram defined by the two vectors. (See Figure 2.9.) The area of the triangle defined by two vectors is then  $\frac{1}{2}|\mathbf{a} \times \mathbf{b}|$ .

From the definition of the cross product, one can derive the following properties:

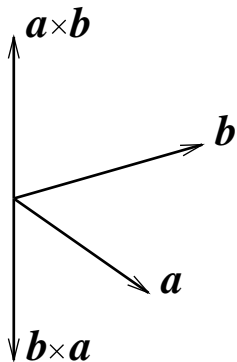

Figure 2.8: The cross product is anti-commutative.

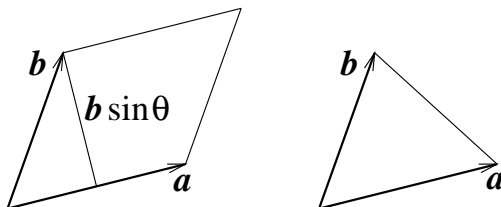

Figure 2.9: The parallelogram and the triangle defined by two vectors.

- $\mathbf{a} \times \mathbf{b} = -\mathbf{b} \times \mathbf{a}$ , anti-commutative.
- $\alpha(\mathbf{a} \times \mathbf{b}) = (\alpha\mathbf{a}) \times \mathbf{b} = \mathbf{a} \times (\alpha\mathbf{b})$ , associativity of scalar multiplication.
- $\mathbf{a} \times (\mathbf{b} + \mathbf{c}) = \mathbf{a} \times \mathbf{b} + \mathbf{a} \times \mathbf{c}$ , distributive.
- $(\mathbf{a} \times \mathbf{b}) \times \mathbf{c} \neq \mathbf{a} \times (\mathbf{b} \times \mathbf{c})$ . The cross product is not associative.
- $\mathbf{i} \times \mathbf{i} = \mathbf{j} \times \mathbf{j} = \mathbf{k} \times \mathbf{k} = \mathbf{0}$ .

- $\mathbf{i} \times \mathbf{j} = \mathbf{k}, \mathbf{j} \times \mathbf{k} = \mathbf{i}, \mathbf{k} \times \mathbf{i} = \mathbf{j}.$

- 

$$\mathbf{a} \times \mathbf{b} = (a_2b_3 - a_3b_2)\mathbf{i} + (a_3b_1 - a_1b_3)\mathbf{j} + (a_1b_2 - a_2b_1)\mathbf{k} = \begin{vmatrix} \mathbf{i} & \mathbf{j} & \mathbf{k} \\ a_1 & a_2 & a_3 \\ b_1 & b_2 & b_3 \end{vmatrix},$$

cross product in terms of rectangular components.

- If  $\mathbf{a} \cdot \mathbf{b} = 0$  then either  $\mathbf{a}$  and  $\mathbf{b}$  are parallel or one of  $\mathbf{a}$  or  $\mathbf{b}$  is zero.

**Scalar Triple Product.** Consider the volume of the parallelepiped defined by three vectors. (See Figure 2.10.) The area of the base is  $\|\mathbf{b}\|\|\mathbf{c}\|\sin\theta$ , where  $\theta$  is the angle between  $\mathbf{b}$  and  $\mathbf{c}$ . The height is  $\|\mathbf{a}\|\cos\phi$ , where  $\phi$  is the angle between  $\mathbf{b} \times \mathbf{c}$  and  $\mathbf{a}$ . Thus the volume of the parallelepiped is  $\|\mathbf{a}\|\|\mathbf{b}\|\|\mathbf{c}\|\sin\theta\cos\phi$ .

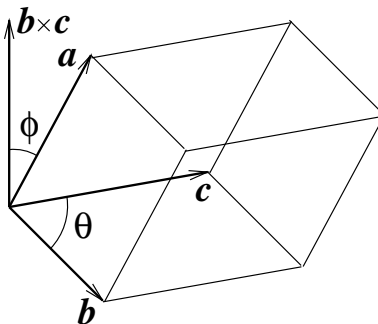

Figure 2.10: The parallelepiped defined by three vectors.

Note that

$$\begin{aligned} |\mathbf{a} \cdot (\mathbf{b} \times \mathbf{c})| &= |\mathbf{a} \cdot (\|\mathbf{b}\|\|\mathbf{c}\|\sin\theta \mathbf{n})| \\ &= \|\mathbf{a}\|\|\mathbf{b}\|\|\mathbf{c}\|\sin\theta\cos\phi|. \end{aligned}$$



Thus  $|\mathbf{a} \cdot (\mathbf{b} \times \mathbf{c})|$  is the volume of the parallelepiped.  $\mathbf{a} \cdot (\mathbf{b} \times \mathbf{c})$  is the volume or the negative of the volume depending on whether  $\{\mathbf{a}, \mathbf{b}, \mathbf{c}\}$  is a right or left-handed system.

Note that parentheses are unnecessary in  $\mathbf{a} \cdot \mathbf{b} \times \mathbf{c}$ . There is only one way to interpret the expression. If you did the dot product first then you would be left with the cross product of a scalar and a vector which is meaningless.  $\mathbf{a} \cdot \mathbf{b} \times \mathbf{c}$  is called the *scalar triple product*.

**Plane Defined by Three Points.** Three points which are not collinear define a plane. Consider a plane that passes through the three points  $\mathbf{a}$ ,  $\mathbf{b}$  and  $\mathbf{c}$ . One way of expressing that the point  $\mathbf{x}$  lies in the plane is that the vectors  $\mathbf{x} - \mathbf{a}$ ,  $\mathbf{b} - \mathbf{a}$  and  $\mathbf{c} - \mathbf{a}$  are coplanar. (See Figure 2.11.) If the vectors are coplanar, then the parallelepiped defined by these three vectors will have zero volume. We can express this in an equation using the scalar triple product,

$$(\mathbf{x} - \mathbf{a}) \cdot (\mathbf{b} - \mathbf{a}) \times (\mathbf{c} - \mathbf{a}) = 0.$$

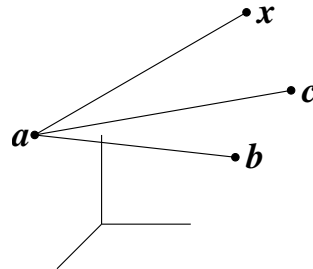

Figure 2.11: Three points define a plane.

## 2.2 Sets of Vectors in $n$ Dimensions

**Orthogonality.** Consider two  $n$ -dimensional vectors

$$\mathbf{x} = (x_1, x_2, \dots, x_n), \quad \mathbf{y} = (y_1, y_2, \dots, y_n).$$

The inner product of these vectors can be defined

$$\langle \mathbf{x} | \mathbf{y} \rangle \equiv \mathbf{x} \cdot \mathbf{y} = \sum_{i=1}^n x_i y_i.$$

The vectors are orthogonal if  $\mathbf{x} \cdot \mathbf{y} = 0$ . The norm of a vector is the length of the vector generalized to  $n$  dimensions.

$$\|\mathbf{x}\| = \sqrt{\mathbf{x} \cdot \mathbf{x}}$$

Consider a set of vectors

$$\{\mathbf{x}_1, \mathbf{x}_2, \dots, \mathbf{x}_m\}.$$

If each pair of vectors in the set is orthogonal, then the set is orthogonal.

$$\mathbf{x}_i \cdot \mathbf{x}_j = 0 \quad \text{if } i \neq j$$

If in addition each vector in the set has norm 1, then the set is orthonormal.

$$\mathbf{x}_i \cdot \mathbf{x}_j = \delta_{ij} = \begin{cases} 1 & \text{if } i = j \\ 0 & \text{if } i \neq j \end{cases}$$

Here  $\delta_{ij}$  is known as the Kronecker delta function.

**Completeness.** A set of  $n$ ,  $n$ -dimensional vectors

$$\{\mathbf{x}_1, \mathbf{x}_2, \dots, \mathbf{x}_n\}$$

is *complete* if any  $n$ -dimensional vector can be written as a linear combination of the vectors in the set. That is, any vector  $\mathbf{y}$  can be written

$$\mathbf{y} = \sum_{i=1}^n c_i \mathbf{x}_i.$$

Taking the inner product of each side of this equation with  $\mathbf{x}_m$ ,

$$\begin{aligned}\mathbf{y} \cdot \mathbf{x}_m &= \left( \sum_{i=1}^n c_i \mathbf{x}_i \right) \cdot \mathbf{x}_m \\ &= \sum_{i=1}^n c_i \mathbf{x}_i \cdot \mathbf{x}_m \\ &= c_m \mathbf{x}_m \cdot \mathbf{x}_m \\ c_m &= \frac{\mathbf{y} \cdot \mathbf{x}_m}{\|\mathbf{x}_m\|^2}\end{aligned}$$

Thus  $\mathbf{y}$  has the expansion

$$\mathbf{y} = \sum_{i=1}^n \frac{\mathbf{y} \cdot \mathbf{x}_i}{\|\mathbf{x}_i\|^2} \mathbf{x}_i.$$

If in addition the set is orthonormal, then

$$\mathbf{y} = \sum_{i=1}^n (\mathbf{y} \cdot \mathbf{x}_i) \mathbf{x}_i.$$

## 2.3 Exercises

### The Dot and Cross Product

#### Exercise 2.1

Prove the distributive law for the dot product,

$$\mathbf{a} \cdot (\mathbf{b} + \mathbf{c}) = \mathbf{a} \cdot \mathbf{b} + \mathbf{a} \cdot \mathbf{c}.$$

Hint, Solution

#### Exercise 2.2

Prove that

$$\mathbf{a} \cdot \mathbf{b} = a_i b_i \equiv a_1 b_1 + \cdots + a_n b_n.$$

Hint, Solution

#### Exercise 2.3

What is the angle between the vectors  $\mathbf{i} + \mathbf{j}$  and  $\mathbf{i} + 3\mathbf{j}$ ?

Hint, Solution

#### Exercise 2.4

Prove the distributive law for the cross product,

$$\mathbf{a} \times (\mathbf{b} + \mathbf{c}) = \mathbf{a} \times \mathbf{b} + \mathbf{a} \times \mathbf{c}.$$

Hint, Solution

#### Exercise 2.5

Show that

$$\mathbf{a} \times \mathbf{b} = \begin{vmatrix} \mathbf{i} & \mathbf{j} & \mathbf{k} \\ a_1 & a_2 & a_3 \\ b_1 & b_2 & b_3 \end{vmatrix}$$

Hint, Solution

**Exercise 2.6**

What is the area of the quadrilateral with vertices at  $(1, 1)$ ,  $(4, 2)$ ,  $(3, 7)$  and  $(2, 3)$ ?

[Hint](#), [Solution](#)

**Exercise 2.7**

What is the volume of the tetrahedron with vertices at  $(1, 1, 0)$ ,  $(3, 2, 1)$ ,  $(2, 4, 1)$  and  $(1, 2, 5)$ ?

[Hint](#), [Solution](#)

**Exercise 2.8**

What is the equation of the plane that passes through the points  $(1, 2, 3)$ ,  $(2, 3, 1)$  and  $(3, 1, 2)$ ? What is the distance from the point  $(2, 3, 5)$  to the plane?

[Hint](#), [Solution](#)

## 2.4 Hints

### The Dot and Cross Product

#### Hint 2.1

First prove the distributive law when the first vector is of unit length,

$$\mathbf{n} \cdot (\mathbf{b} + \mathbf{c}) = \mathbf{n} \cdot \mathbf{b} + \mathbf{n} \cdot \mathbf{c}.$$

Then all the quantities in the equation are projections onto the unit vector  $\mathbf{n}$  and you can use geometry.

#### Hint 2.2

First prove that the dot product of a rectangular unit vector with itself is one and the dot product of two distinct rectangular unit vectors is zero. Then write  $\mathbf{a}$  and  $\mathbf{b}$  in rectangular components and use the distributive law.

#### Hint 2.3

Use  $\mathbf{a} \cdot \mathbf{b} = |\mathbf{a}||\mathbf{b}| \cos \theta$ .

#### Hint 2.4

First consider the case that both  $\mathbf{b}$  and  $\mathbf{c}$  are orthogonal to  $\mathbf{a}$ . Prove the distributive law in this case from geometric considerations.

Next consider two arbitrary vectors  $\mathbf{a}$  and  $\mathbf{b}$ . We can write  $\mathbf{b} = \mathbf{b}_\perp + \mathbf{b}_\parallel$  where  $\mathbf{b}_\perp$  is orthogonal to  $\mathbf{a}$  and  $\mathbf{b}_\parallel$  is parallel to  $\mathbf{a}$ . Show that

$$\mathbf{a} \times \mathbf{b} = \mathbf{a} \times \mathbf{b}_\perp.$$

Finally prove the distributive law for arbitrary  $\mathbf{b}$  and  $\mathbf{c}$ .

#### Hint 2.5

Write the vectors in their rectangular components and use,

$$\mathbf{i} \times \mathbf{j} = \mathbf{k}, \quad \mathbf{j} \times \mathbf{k} = \mathbf{i}, \quad \mathbf{k} \times \mathbf{i} = \mathbf{j},$$

and,

$$\mathbf{i} \times \mathbf{i} = \mathbf{j} \times \mathbf{j} = \mathbf{k} \times \mathbf{k} = 0.$$

**Hint 2.6**

The quadrilateral is composed of two triangles. The area of a triangle defined by the two vectors  $\mathbf{a}$  and  $\mathbf{b}$  is  $\frac{1}{2}|\mathbf{a} \cdot \mathbf{b}|$ .

**Hint 2.7**

Justify that the area of a tetrahedron determined by three vectors is one sixth the area of the parallelogram determined by those three vectors. The area of a parallelogram determined by three vectors is the magnitude of the scalar triple product of the vectors:  $\mathbf{a} \cdot \mathbf{b} \times \mathbf{c}$ .

**Hint 2.8**

The equation of a line that is orthogonal to  $\mathbf{a}$  and passes through the point  $\mathbf{b}$  is  $\mathbf{a} \cdot \mathbf{x} = \mathbf{a} \cdot \mathbf{b}$ . The distance of a point  $\mathbf{c}$  from the plane is

$$\left| (\mathbf{c} - \mathbf{b}) \cdot \frac{\mathbf{a}}{|\mathbf{a}|} \right|$$

## 2.5 Solutions

### The Dot and Cross Product

#### Solution 2.1

First we prove the distributive law when the first vector is of unit length, i.e.,

$$\mathbf{n} \cdot (\mathbf{b} + \mathbf{c}) = \mathbf{n} \cdot \mathbf{b} + \mathbf{n} \cdot \mathbf{c}. \quad (2.1)$$

From Figure 2.12 we see that the projection of the vector  $\mathbf{b} + \mathbf{c}$  onto  $\mathbf{n}$  is equal to the sum of the projections  $\mathbf{b} \cdot \mathbf{n}$  and  $\mathbf{c} \cdot \mathbf{n}$ .

Now we extend the result to the case when the first vector has arbitrary length. We define  $\mathbf{a} = |\mathbf{a}|\mathbf{n}$  and multiply Equation 2.1 by the scalar,  $|\mathbf{a}|$ .

$$|\mathbf{a}|\mathbf{n} \cdot (\mathbf{b} + \mathbf{c}) = |\mathbf{a}|\mathbf{n} \cdot \mathbf{b} + |\mathbf{a}|\mathbf{n} \cdot \mathbf{c}$$

$$\mathbf{a} \cdot (\mathbf{b} + \mathbf{c}) = \mathbf{a} \cdot \mathbf{b} + \mathbf{a} \cdot \mathbf{c}.$$

#### Solution 2.2

First note that

$$\mathbf{e}_i \cdot \mathbf{e}_i = |\mathbf{e}_i||\mathbf{e}_i| \cos(0) = 1.$$

Then note that that dot product of any two distinct rectangular unit vectors is zero because they are orthogonal. Now we write  $\mathbf{a}$  and  $\mathbf{b}$  in terms of their rectangular components and use the distributive law.

$$\begin{aligned} \mathbf{a} \cdot \mathbf{b} &= a_i \mathbf{e}_i \cdot b_j \mathbf{e}_j \\ &= a_i b_j \mathbf{e}_i \cdot \mathbf{e}_j \\ &= a_i b_j \delta_{ij} \\ &= a_i b_i \end{aligned}$$

#### Solution 2.3

Since  $\mathbf{a} \cdot \mathbf{b} = |\mathbf{a}||\mathbf{b}| \cos \theta$ , we have

$$\theta = \arccos \left( \frac{\mathbf{a} \cdot \mathbf{b}}{|\mathbf{a}||\mathbf{b}|} \right)$$



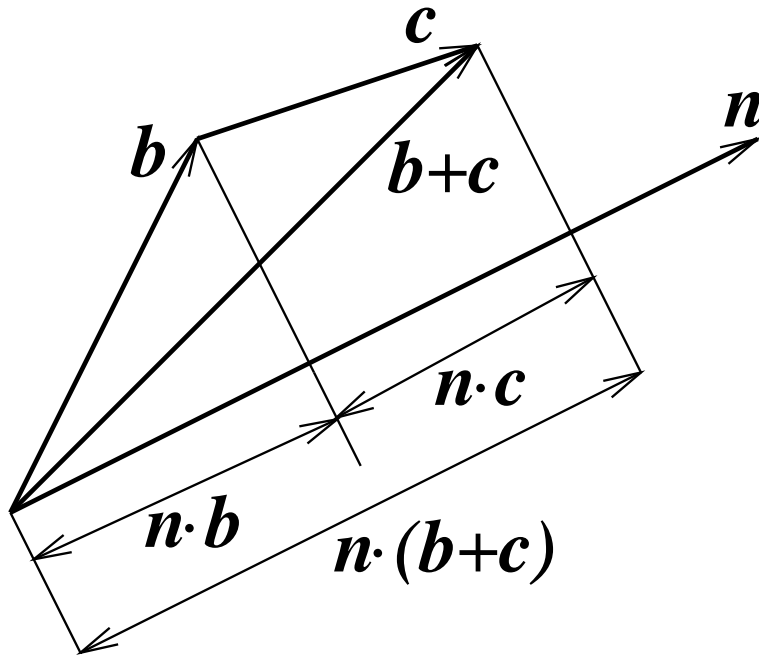

Figure 2.12: The distributive law for the dot product.

when  $\mathbf{a}$  and  $\mathbf{b}$  are nonzero.

$$\theta = \arccos \left( \frac{(\mathbf{i} + \mathbf{j}) \cdot (\mathbf{i} + 3\mathbf{j})}{\|\mathbf{i} + \mathbf{j}\| \|\mathbf{i} + 3\mathbf{j}\|} \right) = \arccos \left( \frac{4}{\sqrt{2}\sqrt{10}} \right) = \arccos \left( \frac{2\sqrt{5}}{5} \right) \approx 0.463648$$

#### Solution 2.4

First consider the case that both  $\mathbf{b}$  and  $\mathbf{c}$  are orthogonal to  $\mathbf{a}$ .  $\mathbf{b} + \mathbf{c}$  is the diagonal of the parallelogram defined by  $\mathbf{b}$  and  $\mathbf{c}$ , (see Figure 2.13). Since  $\mathbf{a}$  is orthogonal to each of these vectors, taking the cross product of  $\mathbf{a}$  with these vectors has the effect of rotating the vectors through  $\pi/2$  radians about  $\mathbf{a}$  and multiplying their length by  $|\mathbf{a}|$ . Note

that  $\mathbf{a} \times (\mathbf{b} + \mathbf{c})$  is the diagonal of the parallelogram defined by  $\mathbf{a} \times \mathbf{b}$  and  $\mathbf{a} \times \mathbf{c}$ . Thus we see that the distributive law holds when  $\mathbf{a}$  is orthogonal to both  $\mathbf{b}$  and  $\mathbf{c}$ ,

$$\mathbf{a} \times (\mathbf{b} + \mathbf{c}) = \mathbf{a} \times \mathbf{b} + \mathbf{a} \times \mathbf{c}.$$

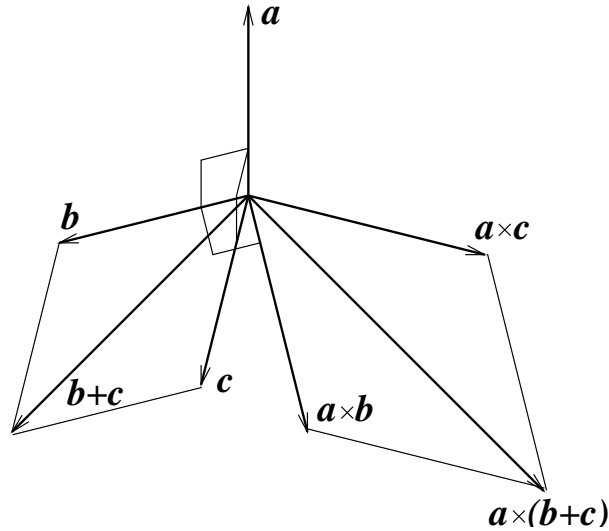

Figure 2.13: The distributive law for the cross product.

Now consider two arbitrary vectors  $\mathbf{a}$  and  $\mathbf{b}$ . We can write  $\mathbf{b} = \mathbf{b}_\perp + \mathbf{b}_\parallel$  where  $\mathbf{b}_\perp$  is orthogonal to  $\mathbf{a}$  and  $\mathbf{b}_\parallel$  is parallel to  $\mathbf{a}$ , (see Figure 2.14).

By the definition of the cross product,

$$\mathbf{a} \times \mathbf{b} = |\mathbf{a}||\mathbf{b}| \sin \theta \mathbf{n}.$$

Note that

$$|\mathbf{b}_\perp| = |\mathbf{b}| \sin \theta,$$

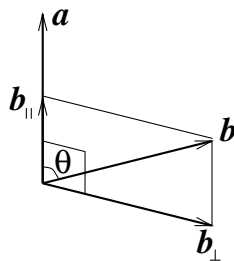

Figure 2.14: The vector  $\mathbf{b}$  written as a sum of components orthogonal and parallel to  $\mathbf{a}$ .

and that  $\mathbf{a} \times \mathbf{b}_\perp$  is a vector in the same direction as  $\mathbf{a} \times \mathbf{b}$ . Thus we see that

$$\begin{aligned} \mathbf{a} \times \mathbf{b} &= |\mathbf{a}||\mathbf{b}| \sin \theta \mathbf{n} \\ &= |\mathbf{a}|(\sin \theta |\mathbf{b}|)\mathbf{n} \\ &= |\mathbf{a}||\mathbf{b}_\perp|\mathbf{n} &= |\mathbf{a}||\mathbf{b}_\perp| \sin(\pi/2)\mathbf{n} \end{aligned}$$

$$\mathbf{a} \times \mathbf{b} = \mathbf{a} \times \mathbf{b}_\perp.$$

Now we are prepared to prove the distributive law for arbitrary  $\mathbf{b}$  and  $\mathbf{c}$ .

$$\begin{aligned} \mathbf{a} \times (\mathbf{b} + \mathbf{c}) &= \mathbf{a} \times (\mathbf{b}_\perp + \mathbf{b}_\parallel + \mathbf{c}_\perp + \mathbf{c}_\parallel) \\ &= \mathbf{a} \times ((\mathbf{b} + \mathbf{c})_\perp + (\mathbf{b} + \mathbf{c})_\parallel) \\ &= \mathbf{a} \times ((\mathbf{b} + \mathbf{c})_\perp) \\ &= \mathbf{a} \times \mathbf{b}_\perp + \mathbf{a} \times \mathbf{c}_\perp \\ &= \mathbf{a} \times \mathbf{b} + \mathbf{a} \times \mathbf{c} \end{aligned}$$

$$\boxed{\mathbf{a} \times (\mathbf{b} + \mathbf{c}) = \mathbf{a} \times \mathbf{b} + \mathbf{a} \times \mathbf{c}}$$

### Solution 2.5

We know that

$$\mathbf{i} \times \mathbf{j} = \mathbf{k}, \quad \mathbf{j} \times \mathbf{k} = \mathbf{i}, \quad \mathbf{k} \times \mathbf{i} = \mathbf{j},$$

and that

$$\mathbf{i} \times \mathbf{i} = \mathbf{j} \times \mathbf{j} = \mathbf{k} \times \mathbf{k} = \mathbf{0}.$$

Now we write  $\mathbf{a}$  and  $\mathbf{b}$  in terms of their rectangular components and use the distributive law to expand the cross product.

$$\begin{aligned} \mathbf{a} \times \mathbf{b} &= (a_1\mathbf{i} + a_2\mathbf{j} + a_3\mathbf{k}) \times (b_1\mathbf{i} + b_2\mathbf{j} + b_3\mathbf{k}) \\ &= a_1\mathbf{i} \times (b_1\mathbf{i} + b_2\mathbf{j} + b_3\mathbf{k}) + a_2\mathbf{j} \times (b_1\mathbf{i} + b_2\mathbf{j} + b_3\mathbf{k}) + a_3\mathbf{k} \times (b_1\mathbf{i} + b_2\mathbf{j} + b_3\mathbf{k}) \\ &= a_1b_2\mathbf{k} + a_1b_3(-\mathbf{j}) + a_2b_1(-\mathbf{k}) + a_2b_3\mathbf{i} + a_3b_1\mathbf{j} + a_3b_2(-\mathbf{i}) \\ &= (a_2b_3 - a_3b_2)\mathbf{i} - (a_1b_3 - a_3b_1)\mathbf{j} + (a_1b_2 - a_2b_1)\mathbf{k} \end{aligned}$$

Next we evaluate the determinant.

$$\begin{aligned} \begin{vmatrix} \mathbf{i} & \mathbf{j} & \mathbf{k} \\ a_1 & a_2 & a_3 \\ b_1 & b_2 & b_3 \end{vmatrix} &= \mathbf{i} \begin{vmatrix} a_2 & a_3 \\ b_2 & b_3 \end{vmatrix} - \mathbf{j} \begin{vmatrix} a_1 & a_3 \\ b_1 & b_3 \end{vmatrix} + \mathbf{k} \begin{vmatrix} a_1 & a_2 \\ b_1 & b_2 \end{vmatrix} \\ &= (a_2b_3 - a_3b_2)\mathbf{i} - (a_1b_3 - a_3b_1)\mathbf{j} + (a_1b_2 - a_2b_1)\mathbf{k} \end{aligned}$$

Thus we see that,

$$\mathbf{a} \times \mathbf{b} = \begin{vmatrix} \mathbf{i} & \mathbf{j} & \mathbf{k} \\ a_1 & a_2 & a_3 \\ b_1 & b_2 & b_3 \end{vmatrix}$$

### Solution 2.6

The area of the quadrilateral is the area of two triangles. The first triangle is defined by the vector from  $(1, 1)$  to  $(4, 2)$  and the vector from  $(1, 1)$  to  $(2, 3)$ . The second triangle is defined by the vector from  $(3, 7)$  to  $(4, 2)$  and the vector from  $(3, 7)$  to  $(2, 3)$ . (See Figure 2.15.) The area of a triangle defined by the two vectors  $\mathbf{a}$  and  $\mathbf{b}$  is  $\frac{1}{2}|\mathbf{a} \cdot \mathbf{b}|$ .

The area of the quadrilateral is then,

$$\frac{1}{2}|(3\mathbf{i} + \mathbf{j}) \cdot (\mathbf{i} + 2\mathbf{j})| + \frac{1}{2}|(\mathbf{i} - 5\mathbf{j}) \cdot (-\mathbf{i} - 4\mathbf{j})| = \frac{1}{2}(5) + \frac{1}{2}(19) = 12.$$

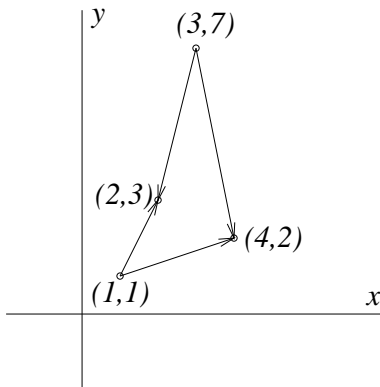

Figure 2.15: Quadrilateral.

### Solution 2.7

The tetrahedron is determined by the three vectors with tail at  $(1, 1, 0)$  and heads at  $(3, 2, 1)$ ,  $(2, 4, 1)$  and  $(1, 2, 5)$ . These are  $\langle 2, 1, 1 \rangle$ ,  $\langle 1, 3, 1 \rangle$  and  $\langle 0, 1, 5 \rangle$ . The area of the tetrahedron is one sixth the area of the parallelogram determined by these vectors. (This is because the area of a pyramid is  $\frac{1}{3}(\text{base})(\text{height})$ . The base of the tetrahedron is half the area of the parallelogram and the heights are the same.  $\frac{1}{2} \cdot \frac{1}{3} = \frac{1}{6}$  ) Thus the area of a tetrahedron determined by three vectors is  $\frac{1}{6}|\mathbf{a} \cdot \mathbf{b} \times \mathbf{c}|$ . The area of the tetrahedron is

$$\frac{1}{6}|\langle 2, 1, 1 \rangle \cdot \langle 1, 3, 1 \rangle \times \langle 1, 2, 5 \rangle| = \frac{1}{6}|\langle 2, 1, 1 \rangle \cdot \langle 13, -4, -1 \rangle| = \frac{7}{2}$$

**Solution 2.8**

The two vectors with tails at  $(1, 2, 3)$  and heads at  $(2, 3, 1)$  and  $(3, 1, 2)$  are parallel to the plane. Taking the cross product of these two vectors gives us a vector that is orthogonal to the plane.

$$\langle 1, 1, -2 \rangle \times \langle 2, -1, -1 \rangle = \langle -3, -3, -3 \rangle$$

We see that the plane is orthogonal to the vector  $\langle 1, 1, 1 \rangle$  and passes through the point  $(1, 2, 3)$ . The equation of the plane is

$$\begin{aligned}\langle 1, 1, 1 \rangle \cdot \langle x, y, z \rangle &= \langle 1, 1, 1 \rangle \cdot \langle 1, 2, 3 \rangle, \\ x + y + z &= 6.\end{aligned}$$

Consider the vector with tail at  $(1, 2, 3)$  and head at  $(2, 3, 5)$ . The magnitude of the dot product of this vector with the unit normal vector gives the distance from the plane.

$$\left| \langle 1, 1, 2 \rangle \cdot \frac{\langle 1, 1, 1 \rangle}{|\langle 1, 1, 1 \rangle|} \right| = \frac{4}{\sqrt{3}} = \frac{4\sqrt{3}}{3}$$

# Part II

## Calculus

# Chapter 3

## Differential Calculus

### 3.1 Limits of Functions

**Definition of a Limit.** If the value of the function  $y(x)$  gets arbitrarily close to  $\psi$  as  $x$  approaches the point  $\xi$ , then we say that the limit of the function as  $x$  approaches  $\xi$  is equal to  $\psi$ . This is written:

$$\lim_{x \rightarrow \xi} y(x) = \psi$$

Now we make the notion of “arbitrarily close” precise. For any  $\epsilon > 0$  there exists a  $\delta > 0$  such that  $|y(x) - \psi| < \epsilon$  for all  $0 < |x - \xi| < \delta$ . That is, there is an interval surrounding the point  $x = \xi$  for which the function is within  $\epsilon$  of  $\psi$ . See Figure 3.1. Note that the interval surrounding  $x = \xi$  is a deleted neighborhood, that is it does not contain the point  $x = \xi$ . Thus the value of the function at  $x = \xi$  need not be equal to  $\psi$  for the limit to exist. Indeed the function need not even be defined at  $x = \xi$ .

To prove that a function has a limit at a point  $\xi$  we first bound  $|y(x) - \psi|$  in terms of  $\delta$  for values of  $x$  satisfying  $0 < |x - \xi| < \delta$ . Denote this upper bound by  $u(\delta)$ . Then for an arbitrary  $\epsilon > 0$ , we determine a  $\delta > 0$  such that the the upper bound  $u(\delta)$  and hence  $|y(x) - \psi|$  is less than  $\epsilon$ .



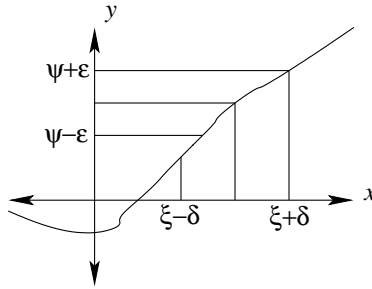

Figure 3.1: The  $\delta$  neighborhood of  $x = \xi$  such that  $|y(x) - \psi| < \epsilon$ .

**Example 3.1.1** Show that

$$\lim_{x \rightarrow 1} x^2 = 1.$$

Consider any  $\epsilon > 0$ . We need to show that there exists a  $\delta > 0$  such that  $|x^2 - 1| < \epsilon$  for all  $|x - 1| < \delta$ . First we obtain a bound on  $|x^2 - 1|$ .

$$\begin{aligned} |x^2 - 1| &= |(x - 1)(x + 1)| \\ &= |x - 1||x + 1| \\ &< \delta|x + 1| \\ &= \delta|(x - 1) + 2| \\ &< \delta(\delta + 2) \end{aligned}$$

Now we choose a positive  $\delta$  such that,

$$\delta(\delta + 2) = \epsilon.$$

We see that

$$\delta = \sqrt{1 + \epsilon} - 1,$$

is positive and satisfies the criterion that  $|x^2 - 1| < \epsilon$  for all  $0 < |x - 1| < \delta$ . Thus the limit exists.

**Example 3.1.2** Recall that the value of the function  $y(\xi)$  need not be equal to  $\lim_{x \rightarrow \xi} y(x)$  for the limit to exist. We show an example of this. Consider the function

$$y(x) = \begin{cases} 1 & \text{for } x \in \mathbb{Z}, \\ 0 & \text{for } x \notin \mathbb{Z}. \end{cases}$$

For what values of  $\xi$  does  $\lim_{x \rightarrow \xi} y(x)$  exist?

First consider  $\xi \notin \mathbb{Z}$ . Then there exists an open neighborhood  $a < \xi < b$  around  $\xi$  such that  $y(x)$  is identically zero for  $x \in (a, b)$ . Then trivially,  $\lim_{x \rightarrow \xi} y(x) = 0$ .

Now consider  $\xi \in \mathbb{Z}$ . Consider any  $\epsilon > 0$ . Then if  $|x - \xi| < 1$  then  $|y(x) - 0| = 0 < \epsilon$ . Thus we see that  $\lim_{x \rightarrow \xi} y(x) = 0$ .

Thus, regardless of the value of  $\xi$ ,  $\lim_{x \rightarrow \xi} y(x) = 0$ .

**Left and Right Limits.** With the notation  $\lim_{x \rightarrow \xi^+} y(x)$  we denote the right limit of  $y(x)$ . This is the limit as  $x$  approaches  $\xi$  from above. Mathematically:  $\lim_{x \rightarrow \xi^+}$  exists if for any  $\epsilon > 0$  there exists a  $\delta > 0$  such that  $|y(x) - \psi| < \epsilon$  for all  $0 < x - \xi < \delta$ . The left limit  $\lim_{x \rightarrow \xi^-} y(x)$  is defined analogously.

**Example 3.1.3** Consider the function,  $\frac{\sin x}{|x|}$ , defined for  $x \neq 0$ . (See Figure 3.2.) The left and right limits exist as  $x$  approaches zero.

$$\lim_{x \rightarrow 0^+} \frac{\sin x}{|x|} = 1, \quad \lim_{x \rightarrow 0^-} \frac{\sin x}{|x|} = -1$$

However the limit,

$$\lim_{x \rightarrow 0} \frac{\sin x}{|x|},$$

does not exist.

**Properties of Limits.** Let  $\lim_{x \rightarrow \xi} f(x)$  and  $\lim_{x \rightarrow \xi} g(x)$  exist.

- $\lim_{x \rightarrow \xi} (af(x) + bg(x)) = a \lim_{x \rightarrow \xi} f(x) + b \lim_{x \rightarrow \xi} g(x)$ .

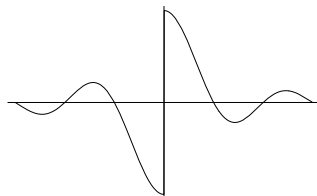

Figure 3.2: Plot of  $\sin(x)/|x|$ .

- $\lim_{x \rightarrow \xi} (f(x)g(x)) = \left( \lim_{x \rightarrow \xi} f(x) \right) \left( \lim_{x \rightarrow \xi} g(x) \right)$ .
- $\lim_{x \rightarrow \xi} \left( \frac{f(x)}{g(x)} \right) = \frac{\lim_{x \rightarrow \xi} f(x)}{\lim_{x \rightarrow \xi} g(x)}$  if  $\lim_{x \rightarrow \xi} g(x) \neq 0$ .

**Example 3.1.4** We prove that if  $\lim_{x \rightarrow \xi} f(x) = \phi$  and  $\lim_{x \rightarrow \xi} g(x) = \gamma$  exist then

$$\lim_{x \rightarrow \xi} (f(x)g(x)) = \left( \lim_{x \rightarrow \xi} f(x) \right) \left( \lim_{x \rightarrow \xi} g(x) \right).$$

Since the limit exists for  $f(x)$ , we know that for all  $\epsilon > 0$  there exists  $\delta > 0$  such that  $|f(x) - \phi| < \epsilon$  for  $|x - \xi| < \delta$ . Likewise for  $g(x)$ . We seek to show that for all  $\epsilon > 0$  there exists  $\delta > 0$  such that  $|f(x)g(x) - \phi\gamma| < \epsilon$  for  $|x - \xi| < \delta$ . We proceed by writing  $|f(x)g(x) - \phi\gamma|$ , in terms of  $|f(x) - \phi|$  and  $|g(x) - \gamma|$ , which we know how to bound.

$$\begin{aligned} |f(x)g(x) - \phi\gamma| &= |f(x)(g(x) - \gamma) + (f(x) - \phi)\gamma| \\ &\leq |f(x)||g(x) - \gamma| + |f(x) - \phi||\gamma| \end{aligned}$$

If we choose a  $\delta$  such that  $|f(x)||g(x) - \gamma| < \epsilon/2$  and  $|f(x) - \phi||\gamma| < \epsilon/2$  then we will have the desired result:  $|f(x)g(x) - \phi\gamma| < \epsilon$ . Trying to ensure that  $|f(x)||g(x) - \gamma| < \epsilon/2$  is hard because of the  $|f(x)|$  factor. We will replace that factor with a constant. We want to write  $|f(x) - \phi||\gamma| < \epsilon/2$  as  $|f(x) - \phi| < \epsilon/(2|\gamma|)$ , but this is problematic for the case  $\gamma = 0$ . We fix these two problems and then proceed. We choose  $\delta_1$  such that  $|f(x) - \phi| < 1$  for  $|x - \xi| < \delta_1$ .

*This gives us the desired form.*

$$|f(x)g(x) - \phi\gamma| \leq (|\phi| + 1)|g(x) - \gamma| + |f(x) - \phi|(|\gamma| + 1), \text{ for } |x - \xi| < \delta_1$$

*Next we choose  $\delta_2$  such that  $|g(x) - \gamma| < \epsilon/(2(|\phi| + 1))$  for  $|x - \xi| < \delta_2$  and choose  $\delta_3$  such that  $|f(x) - \phi| < \epsilon/(2(|\gamma| + 1))$  for  $|x - \xi| < \delta_3$ . Let  $\delta$  be the minimum of  $\delta_1$ ,  $\delta_2$  and  $\delta_3$ .*

$$\begin{aligned} |f(x)g(x) - \phi\gamma| &\leq (|\phi| + 1)|g(x) - \gamma| + |f(x) - \phi|(|\gamma| + 1) < \frac{\epsilon}{2} + \frac{\epsilon}{2}, \text{ for } |x - \xi| < \delta \\ |f(x)g(x) - \phi\gamma| &< \epsilon, \text{ for } |x - \xi| < \delta \end{aligned}$$

*We conclude that the limit of a product is the product of the limits.*

$$\lim_{x \rightarrow \xi} (f(x)g(x)) = \left( \lim_{x \rightarrow \xi} f(x) \right) \left( \lim_{x \rightarrow \xi} g(x) \right) = \phi\gamma.$$

**Result 3.1.1 Definition of a Limit.** The statement:

$$\lim_{x \rightarrow \xi} y(x) = \psi$$

means that  $y(x)$  gets arbitrarily close to  $\psi$  as  $x$  approaches  $\xi$ . For any  $\epsilon > 0$  there exists a  $\delta > 0$  such that  $|y(x) - \psi| < \epsilon$  for all  $x$  in the neighborhood  $0 < |x - \xi| < \delta$ . The left and right limits,

$$\lim_{x \rightarrow \xi^-} y(x) = \psi \quad \text{and} \quad \lim_{x \rightarrow \xi^+} y(x) = \psi$$

denote the limiting value as  $x$  approaches  $\xi$  respectively from below and above. The neighborhoods are respectively  $-\delta < x - \xi < 0$  and  $0 < x - \xi < \delta$ .

**Properties of Limits.** Let  $\lim_{x \rightarrow \xi} u(x)$  and  $\lim_{x \rightarrow \xi} v(x)$  exist.

- $\lim_{x \rightarrow \xi} (au(x) + bv(x)) = a \lim_{x \rightarrow \xi} u(x) + b \lim_{x \rightarrow \xi} v(x)$ .
- $\lim_{x \rightarrow \xi} (u(x)v(x)) = \left( \lim_{x \rightarrow \xi} u(x) \right) \left( \lim_{x \rightarrow \xi} v(x) \right)$ .
- $\lim_{x \rightarrow \xi} \left( \frac{u(x)}{v(x)} \right) = \frac{\lim_{x \rightarrow \xi} u(x)}{\lim_{x \rightarrow \xi} v(x)}$  if  $\lim_{x \rightarrow \xi} v(x) \neq 0$ .

## 3.2 Continuous Functions

**Definition of Continuity.** A function  $y(x)$  is said to be *continuous at*  $x = \xi$  if the value of the function is equal to its limit, that is,  $\lim_{x \rightarrow \xi} y(x) = y(\xi)$ . Note that this one condition is actually the three conditions:  $y(\xi)$  is

defined,  $\lim_{x \rightarrow \xi} y(x)$  exists and  $\lim_{x \rightarrow \xi} y(x) = y(\xi)$ . A function is *continuous* if it is continuous at each point in its domain. A function is *continuous on the closed interval*  $[a, b]$  if the function is continuous for each point  $x \in (a, b)$  and  $\lim_{x \rightarrow a^+} y(x) = y(a)$  and  $\lim_{x \rightarrow b^-} y(x) = y(b)$ .

**Discontinuous Functions.** If a function is not continuous at a point it is called *discontinuous* at that point. If  $\lim_{x \rightarrow \xi} y(x)$  exists but is not equal to  $y(\xi)$ , then the function has a *removable discontinuity*. It is thus named because we could define a continuous function

$$z(x) = \begin{cases} y(x) & \text{for } x \neq \xi, \\ \lim_{x \rightarrow \xi} y(x) & \text{for } x = \xi, \end{cases}$$

to remove the discontinuity. If both the left and right limit of a function at a point exist, but are not equal, then the function has a *jump discontinuity* at that point. If either the left or right limit of a function does not exist, then the function is said to have an *infinite discontinuity* at that point.

**Example 3.2.1**  $\frac{\sin x}{x}$  has a removable discontinuity at  $x = 0$ . The Heaviside function,

$$H(x) = \begin{cases} 0 & \text{for } x < 0, \\ 1/2 & \text{for } x = 0, \\ 1 & \text{for } x > 0, \end{cases}$$

has a jump discontinuity at  $x = 0$ .  $\frac{1}{x}$  has an infinite discontinuity at  $x = 0$ . See Figure 3.3.

### Properties of Continuous Functions.

**Arithmetic.** If  $u(x)$  and  $v(x)$  are continuous at  $x = \xi$  then  $u(x) \pm v(x)$  and  $u(x)v(x)$  are continuous at  $x = \xi$ .  $\frac{u(x)}{v(x)}$  is continuous at  $x = \xi$  if  $v(\xi) \neq 0$ .

**Function Composition.** If  $u(x)$  is continuous at  $x = \xi$  and  $v(x)$  is continuous at  $x = \mu = u(\xi)$  then  $u(v(x))$  is continuous at  $x = \xi$ . The composition of continuous functions is a continuous function.

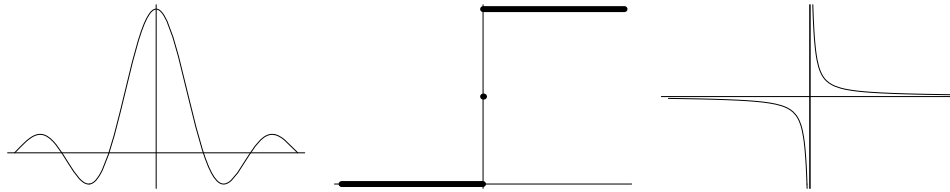

Figure 3.3: A Removable discontinuity, a Jump Discontinuity and an Infinite Discontinuity

**Boundedness.** A function which is continuous on a closed interval is bounded in that closed interval.

**Nonzero in a Neighborhood.** If  $y(\xi) \neq 0$  then there exists a neighborhood  $(\xi - \epsilon, \xi + \epsilon)$ ,  $\epsilon > 0$  of the point  $\xi$  such that  $y(x) \neq 0$  for  $x \in (\xi - \epsilon, \xi + \epsilon)$ .

**Intermediate Value Theorem.** Let  $u(x)$  be continuous on  $[a, b]$ . If  $u(a) \leq \mu \leq u(b)$  then there exists  $\xi \in [a, b]$  such that  $u(\xi) = \mu$ . This is known as the *intermediate value theorem*. A corollary of this is that if  $u(a)$  and  $u(b)$  are of opposite sign then  $u(x)$  has at least one zero on the interval  $(a, b)$ .

**Maxima and Minima.** If  $u(x)$  is continuous on  $[a, b]$  then  $u(x)$  has a maximum and a minimum on  $[a, b]$ . That is, there is at least one point  $\xi \in [a, b]$  such that  $u(\xi) \geq u(x)$  for all  $x \in [a, b]$  and there is at least one point  $\psi \in [a, b]$  such that  $u(\psi) \leq u(x)$  for all  $x \in [a, b]$ .

**Piecewise Continuous Functions.** A function is *piecewise continuous* on an interval if the function is bounded on the interval and the interval can be divided into a finite number of intervals on each of which the function is continuous. For example, the greatest integer function,  $[x]$ , is piecewise continuous. ( $[x]$  is defined to be the greatest integer less than or equal to  $x$ .) See Figure 3.4 for graphs of two piecewise continuous functions.

**Uniform Continuity.** Consider a function  $f(x)$  that is continuous on an interval. This means that for any point  $\xi$  in the interval and any positive  $\epsilon$  there exists a  $\delta > 0$  such that  $|f(x) - f(\xi)| < \epsilon$  for all  $0 < |x - \xi| < \delta$ . In general, this value of  $\delta$  depends on both  $\xi$  and  $\epsilon$ . If  $\delta$  can be chosen so it is a function of  $\epsilon$  alone and independent of  $\xi$  then

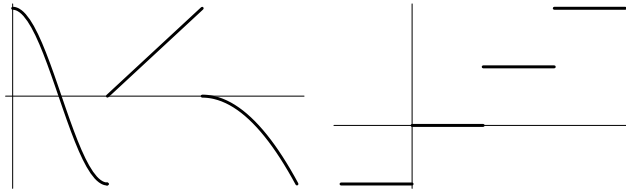

Figure 3.4: Piecewise Continuous Functions

the function is said to be *uniformly continuous* on the interval. A sufficient condition for uniform continuity is that the function is continuous on a closed interval.

### 3.3 The Derivative

Consider a function  $y(x)$  on the interval  $(x \dots x + \Delta x)$  for some  $\Delta x > 0$ . We define the increment  $\Delta y = y(x + \Delta x) - y(x)$ . The *average rate of change*, (average velocity), of the function on the interval is  $\frac{\Delta y}{\Delta x}$ . The average rate of change is the slope of the secant line that passes through the points  $(x, y(x))$  and  $(x + \Delta x, y(x + \Delta x))$ . See Figure 3.5.

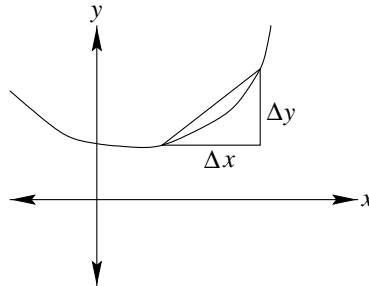

Figure 3.5: The increments  $\Delta x$  and  $\Delta y$ .



If the slope of the secant line has a limit as  $\Delta x$  approaches zero then we call this slope the *derivative* or *instantaneous rate of change* of the function at the point  $x$ . We denote the derivative by  $\frac{dy}{dx}$ , which is a nice notation as the derivative is the limit of  $\frac{\Delta y}{\Delta x}$  as  $\Delta x \rightarrow 0$ .

$$\frac{dy}{dx} \equiv \lim_{\Delta x \rightarrow 0} \frac{y(x + \Delta x) - y(x)}{\Delta x}.$$

$\Delta x$  may approach zero from below or above. It is common to denote the derivative  $\frac{dy}{dx}$  by  $\frac{d}{dx}y$ ,  $y'(x)$ ,  $y'$  or  $Dy$ .

A function is said to be *differentiable* at a point if the derivative exists there. Note that differentiability implies continuity, but not vice versa.

**Example 3.3.1** Consider the derivative of  $y(x) = x^2$  at the point  $x = 1$ .

$$\begin{aligned} y'(1) &\equiv \lim_{\Delta x \rightarrow 0} \frac{y(1 + \Delta x) - y(1)}{\Delta x} \\ &= \lim_{\Delta x \rightarrow 0} \frac{(1 + \Delta x)^2 - 1}{\Delta x} \\ &= \lim_{\Delta x \rightarrow 0} (2 + \Delta x) \\ &= 2 \end{aligned}$$

Figure 3.6 shows the secant lines approaching the tangent line as  $\Delta x$  approaches zero from above and below.

**Example 3.3.2** We can compute the derivative of  $y(x) = x^2$  at an arbitrary point  $x$ .

$$\begin{aligned} \frac{d}{dx} [x^2] &= \lim_{\Delta x \rightarrow 0} \frac{(x + \Delta x)^2 - x^2}{\Delta x} \\ &= \lim_{\Delta x \rightarrow 0} (2x + \Delta x) \\ &= 2x \end{aligned}$$

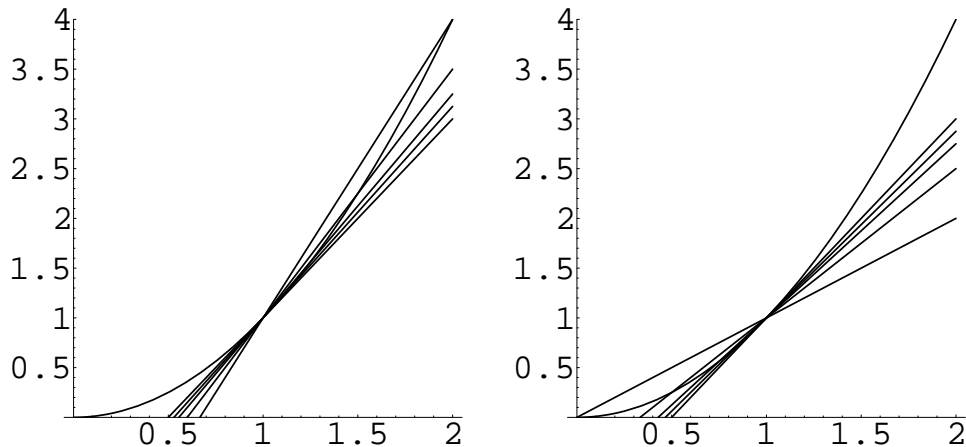

Figure 3.6: Secant lines and the tangent to  $x^2$  at  $x = 1$ .

**Properties.** Let  $u(x)$  and  $v(x)$  be differentiable. Let  $a$  and  $b$  be constants. Some fundamental properties of derivatives are:

$\frac{d}{dx}(au + bv) = a \frac{du}{dx} + b \frac{dv}{dx}$	Linearity
$\frac{d}{dx}(uv) = \frac{du}{dx}v + u \frac{dv}{dx}$	Product Rule
$\frac{d}{dx} \left( \frac{u}{v} \right) = \frac{v \frac{du}{dx} - u \frac{dv}{dx}}{v^2}$	Quotient Rule
$\frac{d}{dx}(u^a) = au^{a-1} \frac{du}{dx}$	Power Rule
$\frac{d}{dx}(u(v(x))) = \frac{du}{dv} \frac{dv}{dx} = u'(v(x))v'(x)$	Chain Rule

These can be proved by using the definition of differentiation.

**Example 3.3.3** Prove the quotient rule for derivatives.

$$\begin{aligned}\frac{d}{dx} \left( \frac{u}{v} \right) &= \lim_{\Delta x \rightarrow 0} \frac{\frac{u(x+\Delta x)}{v(x+\Delta x)} - \frac{u(x)}{v(x)}}{\Delta x} \\ &= \lim_{\Delta x \rightarrow 0} \frac{u(x+\Delta x)v(x) - u(x)v(x+\Delta x)}{\Delta x v(x)v(x+\Delta x)} \\ &= \lim_{\Delta x \rightarrow 0} \frac{u(x+\Delta x)v(x) - u(x)v(x) - u(x)v(x+\Delta x) + u(x)v(x)}{\Delta x v(x)v(x)} \\ &= \lim_{\Delta x \rightarrow 0} \frac{(u(x+\Delta x) - u(x))v(x) - u(x)(v(x+\Delta x) - v(x))}{\Delta x v^2(x)} \\ &= \frac{\lim_{\Delta x \rightarrow 0} \frac{u(x+\Delta x) - u(x)}{\Delta x} v(x) - u(x) \lim_{\Delta x \rightarrow 0} \frac{v(x+\Delta x) - v(x)}{\Delta x}}{v^2(x)} \\ &= \frac{v \frac{du}{dx} - u \frac{dv}{dx}}{v^2}\end{aligned}$$

**Trigonometric Functions.** Some derivatives of trigonometric functions are:

$$\begin{array}{ll} \frac{d}{dx} \sin x = \cos x & \frac{d}{dx} \arcsin x = \frac{1}{(1-x^2)^{1/2}} \\ \frac{d}{dx} \cos x = -\sin x & \frac{d}{dx} \arccos x = \frac{-1}{(1-x^2)^{1/2}} \\ \frac{d}{dx} \tan x = \frac{1}{\cos^2 x} & \frac{d}{dx} \arctan x = \frac{1}{1+x^2} \\ \frac{d}{dx} e^x = e^x & \frac{d}{dx} \ln x = \frac{1}{x} \\ \frac{d}{dx} \sinh x = \cosh x & \frac{d}{dx} \operatorname{arcsinh} x = \frac{1}{(x^2+1)^{1/2}} \\ \frac{d}{dx} \cosh x = \sinh x & \frac{d}{dx} \operatorname{arccosh} x = \frac{1}{(x^2-1)^{1/2}} \\ \frac{d}{dx} \tanh x = \frac{1}{\cosh^2 x} & \frac{d}{dx} \operatorname{arctanh} x = \frac{1}{1-x^2} \end{array}$$

**Example 3.3.4** We can evaluate the derivative of  $x^x$  by using the identity  $a^b = e^{b \ln a}$ .

$$\begin{aligned} \frac{d}{dx} x^x &= \frac{d}{dx} e^{x \ln x} \\ &= e^{x \ln x} \frac{d}{dx} (x \ln x) \\ &= x^x \left( 1 \cdot \ln x + x \frac{1}{x} \right) \\ &= x^x (1 + \ln x) \end{aligned}$$

**Inverse Functions.** If we have a function  $y(x)$ , we can consider  $x$  as a function of  $y$ ,  $x(y)$ . For example, if  $y(x) = 8x^3$  then  $x(y) = \sqrt[3]{y}/2$ ; if  $y(x) = \frac{x+2}{x+1}$  then  $x(y) = \frac{2-y}{y-1}$ . The derivative of an inverse function is

$$\frac{d}{dy} x(y) = \frac{1}{\frac{dy}{dx}}.$$

**Example 3.3.5** The inverse function of  $y(x) = e^x$  is  $x(y) = \ln y$ . We can obtain the derivative of the logarithm from the derivative of the exponential. The derivative of the exponential is

$$\frac{dy}{dx} = e^x.$$

Thus the derivative of the logarithm is

$$\frac{d}{dy} \ln y = \frac{d}{dy} x(y) = \frac{1}{\frac{dy}{dx}} = \frac{1}{e^x} = \frac{1}{y}.$$

## 3.4 Implicit Differentiation

An *explicitly defined* function has the form  $y = f(x)$ . A *implicitly defined* function has the form  $f(x, y) = 0$ . A few examples of implicit functions are  $x^2 + y^2 - 1 = 0$  and  $x + y + \sin(xy) = 0$ . Often it is not possible to write an implicit equation in explicit form. This is true of the latter example above. One can calculate the derivative of  $y(x)$  in terms of  $x$  and  $y$  even when  $y(x)$  is defined by an implicit equation.

**Example 3.4.1** Consider the implicit equation

$$x^2 - xy - y^2 = 1.$$

This implicit equation can be solved for the dependent variable.

$$y(x) = \frac{1}{2} \left( -x \pm \sqrt{5x^2 - 4} \right).$$

We can differentiate this expression to obtain

$$y' = \frac{1}{2} \left( -1 \pm \frac{5x}{\sqrt{5x^2 - 4}} \right).$$

One can obtain the same result without first solving for  $y$ . If we differentiate the implicit equation, we obtain

$$2x - y - x \frac{dy}{dx} - 2y \frac{dy}{dx} = 0.$$

We can solve this equation for  $\frac{dy}{dx}$ .

$$\frac{dy}{dx} = \frac{2x - y}{x + 2y}$$

We can differentiate this expression to obtain the second derivative of  $y$ .

$$\begin{aligned}\frac{d^2y}{dx^2} &= \frac{(x + 2y)(2 - y') - (2x - y)(1 + 2y')}{(x + 2y)^2} \\ &= \frac{5(y - xy')}{(x + 2y)^2}\end{aligned}$$

Substitute in the expression for  $y'$ .

$$= -\frac{10(x^2 - xy - y^2)}{(x + 2y)^2}$$

Use the original implicit equation.

$$= -\frac{10}{(x + 2y)^2}$$

## 3.5 Maxima and Minima

A differentiable function is *increasing* where  $f'(x) > 0$ , *decreasing* where  $f'(x) < 0$  and *stationary* where  $f'(x) = 0$ .

A function  $f(x)$  has a *relative maxima* at a point  $x = \xi$  if there exists a neighborhood around  $\xi$  such that  $f(x) \leq f(\xi)$  for  $x \in (x - \delta, x + \delta)$ ,  $\delta > 0$ . The *relative minima* is defined analogously. Note that this definition does not require that the function be differentiable, or even continuous. We refer to relative maxima and minima collectively as *relative extrema*.

**Relative Extrema and Stationary Points.** If  $f(x)$  is differentiable and  $f(\xi)$  is a relative extrema then  $x = \xi$  is a stationary point,  $f'(\xi) = 0$ . We can prove this using left and right limits. Assume that  $f(\xi)$  is a relative maxima. Then there is a neighborhood  $(x - \delta, x + \delta)$ ,  $\delta > 0$  for which  $f(x) \leq f(\xi)$ . Since  $f(x)$  is differentiable the derivative at  $x = \xi$ ,

$$f'(\xi) = \lim_{\Delta x \rightarrow 0} \frac{f(\xi + \Delta x) - f(\xi)}{\Delta x},$$

exists. This in turn means that the left and right limits exist and are equal. Since  $f(x) \leq f(\xi)$  for  $\xi - \delta < x < \xi$  the left limit is non-positive,

$$f'(\xi) = \lim_{\Delta x \rightarrow 0^-} \frac{f(\xi + \Delta x) - f(\xi)}{\Delta x} \leq 0.$$

Since  $f(x) \leq f(\xi)$  for  $\xi < x < \xi + \delta$  the right limit is nonnegative,

$$f'(\xi) = \lim_{\Delta x \rightarrow 0^+} \frac{f(\xi + \Delta x) - f(\xi)}{\Delta x} \geq 0.$$

Thus we have  $0 \leq f'(\xi) \leq 0$  which implies that  $f'(\xi) = 0$ .

It is not true that all stationary points are relative extrema. That is,  $f'(\xi) = 0$  does not imply that  $x = \xi$  is an extrema. Consider the function  $f(x) = x^3$ .  $x = 0$  is a stationary point since  $f'(x) = x^2$ ,  $f'(0) = 0$ . However,  $x = 0$  is neither a relative maxima nor a relative minima.

It is also not true that all relative extrema are stationary points. Consider the function  $f(x) = |x|$ . The point  $x = 0$  is a relative minima, but the derivative at that point is undefined.

**First Derivative Test.** Let  $f(x)$  be differentiable and  $f'(\xi) = 0$ .

- If  $f'(x)$  changes sign from positive to negative as we pass through  $x = \xi$  then the point is a relative maxima.
- If  $f'(x)$  changes sign from negative to positive as we pass through  $x = \xi$  then the point is a relative minima.

- If  $f'(x)$  is not identically zero in a neighborhood of  $x = \xi$  and it does not change sign as we pass through the point then  $x = \xi$  is not a relative extrema.

**Example 3.5.1** Consider  $y = x^2$  and the point  $x = 0$ . The function is differentiable. The derivative,  $y' = 2x$ , vanishes at  $x = 0$ . Since  $y'(x)$  is negative for  $x < 0$  and positive for  $x > 0$ , the point  $x = 0$  is a relative minima. See Figure 3.7.

**Example 3.5.2** Consider  $y = \cos x$  and the point  $x = 0$ . The function is differentiable. The derivative,  $y' = -\sin x$  is positive for  $-\pi < x < 0$  and negative for  $0 < x < \pi$ . Since the sign of  $y'$  goes from positive to negative,  $x = 0$  is a relative maxima. See Figure 3.7.

**Example 3.5.3** Consider  $y = x^3$  and the point  $x = 0$ . The function is differentiable. The derivative,  $y' = 3x^2$  is positive for  $x < 0$  and positive for  $0 < x$ . Since  $y'$  is not identically zero and the sign of  $y'$  does not change,  $x = 0$  is not a relative extrema. See Figure 3.7.

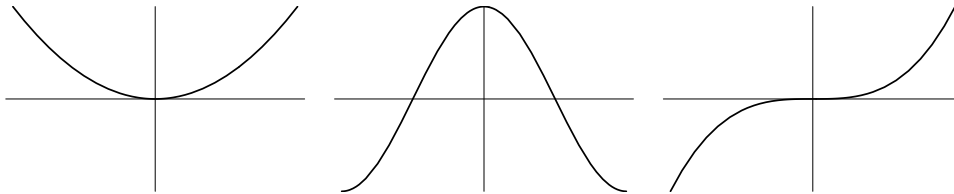

Figure 3.7: Graphs of  $x^2$ ,  $\cos x$  and  $x^3$ .

**Concavity.** If the portion of a curve in some neighborhood of a point lies above the tangent line through that point, the curve is said to be *concave upward*. If it lies below the tangent it is *concave downward*. If a function is twice differentiable then  $f''(x) > 0$  where it is concave upward and  $f''(x) < 0$  where it is concave downward. Note that  $f''(x) > 0$  is a sufficient, but not a necessary condition for a curve to be concave upward at a point. A curve may be concave upward at a point where the second derivative vanishes. A point where the curve changes concavity is called a *point of inflection*. At such a point the second derivative vanishes,  $f''(x) = 0$ . For twice continuously differentiable



functions,  $f''(x) = 0$  is a necessary but not a sufficient condition for an inflection point. The second derivative may vanish at places which are not inflection points. See Figure 3.8.

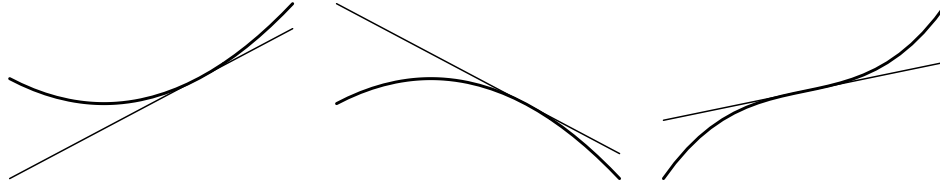

Figure 3.8: Concave Upward, Concave Downward and an Inflection Point.

**Second Derivative Test.** Let  $f(x)$  be twice differentiable and let  $x = \xi$  be a stationary point,  $f'(\xi) = 0$ .

- If  $f''(\xi) < 0$  then the point is a relative maxima.
- If  $f''(\xi) > 0$  then the point is a relative minima.
- If  $f''(\xi) = 0$  then the test fails.

**Example 3.5.4** Consider the function  $f(x) = \cos x$  and the point  $x = 0$ . The derivatives of the function are  $f'(x) = -\sin x$ ,  $f''(x) = -\cos x$ . The point  $x = 0$  is a stationary point,  $f'(0) = -\sin(0) = 0$ . Since the second derivative is negative there,  $f''(0) = -\cos(0) = -1$ , the point is a relative maxima.

**Example 3.5.5** Consider the function  $f(x) = x^4$  and the point  $x = 0$ . The derivatives of the function are  $f'(x) = 4x^3$ ,  $f''(x) = 12x^2$ . The point  $x = 0$  is a stationary point. Since the second derivative also vanishes at that point the second derivative test fails. One must use the first derivative test to determine that  $x = 0$  is a relative minima.

## 3.6 Mean Value Theorems

**Rolle's Theorem.** If  $f(x)$  is continuous in  $[a, b]$ , differentiable in  $(a, b)$  and  $f(a) = f(b) = 0$  then there exists a point  $\xi \in (a, b)$  such that  $f'(\xi) = 0$ . See Figure 3.9.

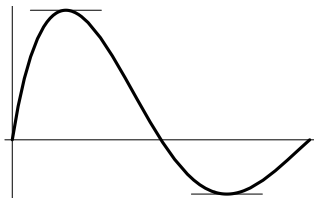

Figure 3.9: Rolle's Theorem.

To prove this we consider two cases. First we have the trivial case that  $f(x) \equiv 0$ . If  $f(x)$  is not identically zero then continuity implies that it must have a nonzero relative maxima or minima in  $(a, b)$ . Let  $x = \xi$  be one of these relative extrema. Since  $f(x)$  is differentiable,  $x = \xi$  must be a stationary point,  $f'(\xi) = 0$ .

**Theorem of the Mean.** If  $f(x)$  is continuous in  $[a, b]$  and differentiable in  $(a, b)$  then there exists a point  $x = \xi$  such that

$$f'(\xi) = \frac{f(b) - f(a)}{b - a}.$$

That is, there is a point where the instantaneous velocity is equal to the average velocity on the interval.

We prove this theorem by applying Rolle's theorem. Consider the new function

$$g(x) = f(x) - f(a) - \frac{f(b) - f(a)}{b - a}(x - a)$$

Note that  $g(a) = g(b) = 0$ , so it satisfies the conditions of Rolle's theorem. There is a point  $x = \xi$  such that  $g'(\xi) = 0$ . We differentiate the expression for  $g(x)$  and substitute in  $x = \xi$  to obtain the result.

$$g'(x) = f'(x) - \frac{f(b) - f(a)}{b - a}$$

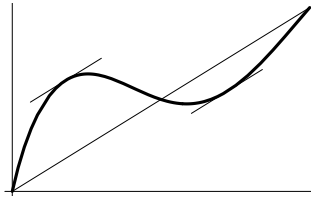

Figure 3.10: Theorem of the Mean.

$$g'(\xi) = f'(\xi) - \frac{f(b) - f(a)}{b - a} = 0$$

$$f'(\xi) = \frac{f(b) - f(a)}{b - a}$$

**Generalized Theorem of the Mean.** If  $f(x)$  and  $g(x)$  are continuous in  $[a, b]$  and differentiable in  $(a, b)$ , then there exists a point  $x = \xi$  such that

$$\frac{f'(\xi)}{g'(\xi)} = \frac{f(b) - f(a)}{g(b) - g(a)}.$$

We have assumed that  $g(a) \neq g(b)$  so that the denominator does not vanish and that  $f'(x)$  and  $g'(x)$  are not simultaneously zero which would produce an indeterminate form. Note that this theorem reduces to the regular theorem of the mean when  $g(x) = x$ . The proof of the theorem is similar to that for the theorem of the mean.

**Taylor's Theorem of the Mean.** If  $f(x)$  is  $n + 1$  times continuously differentiable in  $(a, b)$  then there exists a point  $x = \xi \in (a, b)$  such that

$$f(b) = f(a) + (b - a)f'(a) + \frac{(b - a)^2}{2!}f''(a) + \cdots + \frac{(b - a)^n}{n!}f^{(n)}(a) + \frac{(b - a)^{n+1}}{(n + 1)!}f^{(n+1)}(\xi). \quad (3.1)$$

For the case  $n = 0$ , the formula is

$$f(b) = f(a) + (b - a)f'(\xi),$$

which is just a rearrangement of the terms in the theorem of the mean,

$$f'(\xi) = \frac{f(b) - f(a)}{b - a}.$$

### 3.6.1 Application: Using Taylor's Theorem to Approximate Functions.

One can use Taylor's theorem to approximate functions with polynomials. Consider an infinitely differentiable function  $f(x)$  and a point  $x = a$ . Substituting  $x$  for  $b$  into Equation 3.1 we obtain,

$$f(x) = f(a) + (x - a)f'(a) + \frac{(x - a)^2}{2!}f''(a) + \cdots + \frac{(x - a)^n}{n!}f^{(n)}(a) + \frac{(x - a)^{n+1}}{(n + 1)!}f^{(n+1)}(\xi).$$

If the last term in the sum is small then we can approximate our function with an  $n^{\text{th}}$  order polynomial.

$$f(x) \approx f(a) + (x - a)f'(a) + \frac{(x - a)^2}{2!}f''(a) + \cdots + \frac{(x - a)^n}{n!}f^{(n)}(a)$$

The last term in Equation 3.6.1 is called the remainder or the error term,

$$R_n = \frac{(x - a)^{n+1}}{(n + 1)!}f^{(n+1)}(\xi).$$

Since the function is infinitely differentiable,  $f^{(n+1)}(\xi)$  exists and is bounded. Therefore we note that the error must vanish as  $x \rightarrow 0$  because of the  $(x - a)^{n+1}$  factor. We therefore suspect that our approximation would be a good one if  $x$  is close to  $a$ . Also note that  $n!$  eventually grows faster than  $(x - a)^n$ ,

$$\lim_{n \rightarrow \infty} \frac{(x - a)^n}{n!} = 0.$$

So if the derivative term,  $f^{(n+1)}(\xi)$ , does not grow too quickly, the error for a certain value of  $x$  will get smaller with increasing  $n$  and the polynomial will become a better approximation of the function. (It is also possible that the derivative factor grows very quickly and the approximation gets worse with increasing  $n$ .)

**Example 3.6.1** Consider the function  $f(x) = e^x$ . We want a polynomial approximation of this function near the point  $x = 0$ . Since the derivative of  $e^x$  is  $e^x$ , the value of all the derivatives at  $x = 0$  is  $f^{(n)}(0) = e^0 = 1$ . Taylor's theorem thus states that

$$e^x = 1 + x + \frac{x^2}{2!} + \frac{x^3}{3!} + \cdots + \frac{x^n}{n!} + \frac{x^{n+1}}{(n+1)!} e^\xi,$$

for some  $\xi \in (0, x)$ . The first few polynomial approximations of the exponent about the point  $x = 0$  are

$$f_1(x) = 1$$

$$f_2(x) = 1 + x$$

$$f_3(x) = 1 + x + \frac{x^2}{2}$$

$$f_4(x) = 1 + x + \frac{x^2}{2} + \frac{x^3}{6}$$

The four approximations are graphed in Figure 3.11.

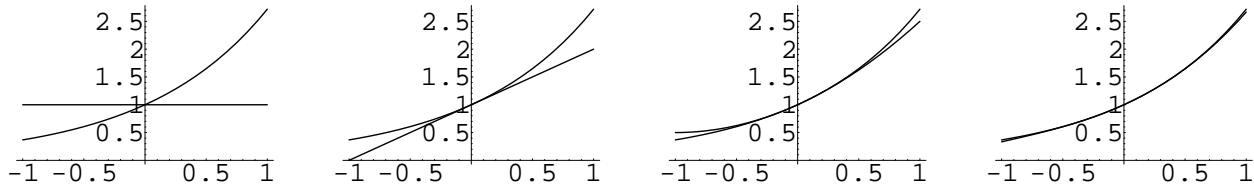

Figure 3.11: Four Finite Taylor Series Approximations of  $e^x$

Note that for the range of  $x$  we are looking at, the approximations become more accurate as the number of terms increases.

**Example 3.6.2** Consider the function  $f(x) = \cos x$ . We want a polynomial approximation of this function near the

point  $x = 0$ . The first few derivatives of  $f$  are

$$\begin{aligned} f(x) &= \cos x \\ f'(x) &= -\sin x \\ f''(x) &= -\cos x \\ f'''(x) &= \sin x \\ f^{(4)}(x) &= \cos x \end{aligned}$$

It's easy to pick out the pattern here,

$$f^{(n)}(x) = \begin{cases} (-1)^{n/2} \cos x & \text{for even } n, \\ (-1)^{(n+1)/2} \sin x & \text{for odd } n. \end{cases}$$

Since  $\cos(0) = 1$  and  $\sin(0) = 0$  the  $n$ -term approximation of the cosine is,

$$\cos x = 1 - \frac{x^2}{2!} + \frac{x^4}{4!} - \frac{x^6}{6!} + \cdots + (-1)^{2(n-1)} \frac{x^{2(n-1)}}{(2(n-1))!} + \frac{x^{2n}}{(2n)!} \cos \xi.$$

Here are graphs of the one, two, three and four term approximations.

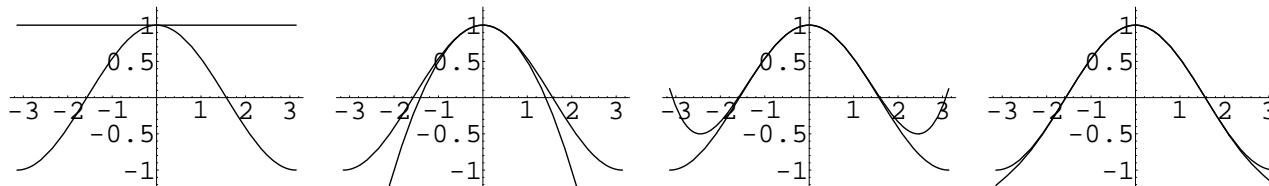

Figure 3.12: Taylor Series Approximations of  $\cos x$

Note that for the range of  $x$  we are looking at, the approximations become more accurate as the number of terms increases. Consider the ten term approximation of the cosine about  $x = 0$ ,

$$\cos x = 1 - \frac{x^2}{2!} + \frac{x^4}{4!} - \cdots - \frac{x^{18}}{18!} + \frac{x^{20}}{20!} \cos \xi.$$

Note that for any value of  $\xi$ ,  $|\cos \xi| \leq 1$ . Therefore the absolute value of the error term satisfies,

$$|R| = \left| \frac{x^{20}}{20!} \cos \xi \right| \leq \frac{|x|^{20}}{20!}.$$

$x^{20}/20!$  is plotted in Figure 3.13.

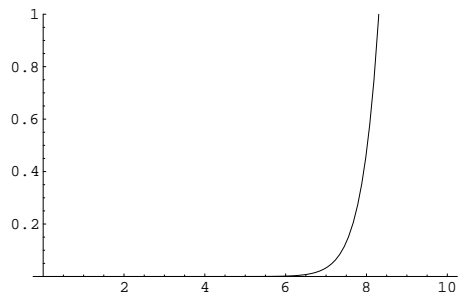

Figure 3.13: Plot of  $x^{20}/20!$ .

Note that the error is very small for  $x < 6$ , fairly small but non-negligible for  $x \approx 7$  and large for  $x > 8$ . The ten term approximation of the cosine, plotted below, behaves just we would predict.

The error is very small until it becomes non-negligible at  $x \approx 7$  and large at  $x \approx 8$ .

**Example 3.6.3** Consider the function  $f(x) = \ln x$ . We want a polynomial approximation of this function near the

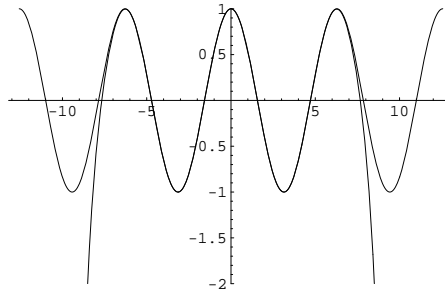

Figure 3.14: Ten Term Taylor Series Approximation of  $\cos x$

point  $x = 1$ . The first few derivatives of  $f$  are

$$f(x) = \ln x$$

$$f'(x) = \frac{1}{x}$$

$$f''(x) = -\frac{1}{x^2}$$

$$f'''(x) = \frac{2}{x^3}$$

$$f^{(4)}(x) = -\frac{3}{x^4}$$

The derivatives evaluated at  $x = 1$  are

$$f(0) = 0, \quad f^{(n)}(0) = (-1)^{n-1}(n-1)!, \quad \text{for } n \geq 1.$$

By Taylor's theorem of the mean we have,

$$\ln x = (x-1) - \frac{(x-1)^2}{2} + \frac{(x-1)^3}{3} - \frac{(x-1)^4}{4} + \cdots + (-1)^{n-1} \frac{(x-1)^n}{n} + (-1)^n \frac{(x-1)^{n+1}}{n+1} \frac{1}{\xi^{n+1}}.$$



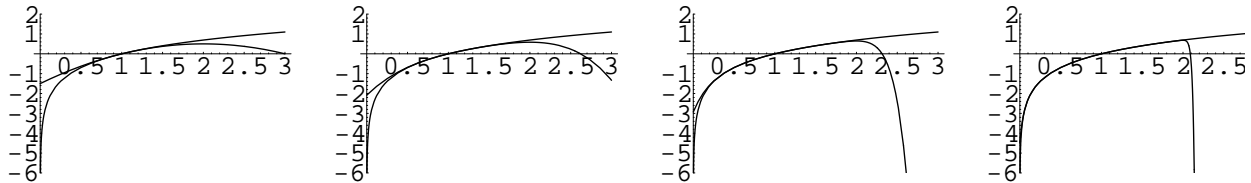

Figure 3.15: The 2, 4, 10 and 50 Term Approximations of  $\ln x$

Below are plots of the 2, 4, 10 and 50 term approximations.

Note that the approximation gets better on the interval  $(0, 2)$  and worse outside this interval as the number of terms increases. The Taylor series converges to  $\ln x$  only on this interval.

### 3.6.2 Application: Finite Difference Schemes

**Example 3.6.4** Suppose you sample a function at the discrete points  $n\Delta x$ ,  $n \in \mathbb{Z}$ . In Figure 3.16 we sample the function  $f(x) = \sin x$  on the interval  $[-4, 4]$  with  $\Delta x = 1/4$  and plot the data points.

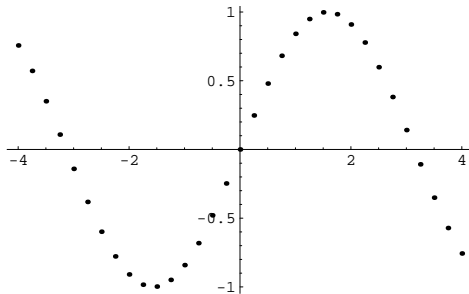

Figure 3.16: Sampling of  $\sin x$

We wish to approximate the derivative of the function on the grid points using only the value of the function on

those discrete points. From the definition of the derivative, one is lead to the formula

$$f'(x) \approx \frac{f(x + \Delta x) - f(x)}{\Delta x}. \quad (3.2)$$

Taylor's theorem states that

$$f(x + \Delta x) = f(x) + \Delta x f'(x) + \frac{\Delta x^2}{2} f''(\xi).$$

Substituting this expression into our formula for approximating the derivative we obtain

$$\frac{f(x + \Delta x) - f(x)}{\Delta x} = \frac{f(x) + \Delta x f'(x) + \frac{\Delta x^2}{2} f''(\xi) - f(x)}{\Delta x} = f'(x) + \frac{\Delta x}{2} f''(\xi).$$

Thus we see that the error in our approximation of the first derivative is  $\frac{\Delta x}{2} f''(\xi)$ . Since the error has a linear factor of  $\Delta x$ , we call this a first order accurate method. Equation 3.2 is called the forward difference scheme for calculating the first derivative. Figure 3.17 shows a plot of the value of this scheme for the function  $f(x) = \sin x$  and  $\Delta x = 1/4$ . The first derivative of the function  $f'(x) = \cos x$  is shown for comparison.

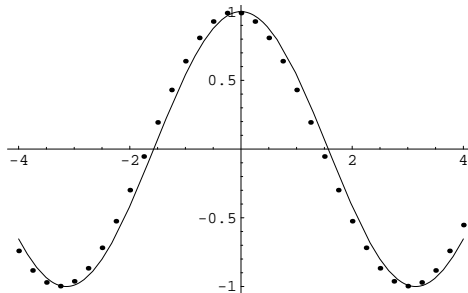

Figure 3.17: The Forward Difference Scheme Approximation of the Derivative

Another scheme for approximating the first derivative is the centered difference scheme,

$$f'(x) \approx \frac{f(x + \Delta x) - f(x - \Delta x)}{2\Delta x}.$$

Expanding the numerator using Taylor's theorem,

$$\begin{aligned} & \frac{f(x + \Delta x) - f(x - \Delta x)}{2\Delta x} \\ &= \frac{f(x) + \Delta x f'(x) + \frac{\Delta x^2}{2} f''(x) + \frac{\Delta x^3}{6} f'''(\xi) - f(x) + \Delta x f'(x) - \frac{\Delta x^2}{2} f''(x) + \frac{\Delta x^3}{6} f'''(\psi)}{2\Delta x} \\ &= f'(x) + \frac{\Delta x^2}{12} (f'''(\xi) + f'''(\psi)). \end{aligned}$$

The error in the approximation is quadratic in  $\Delta x$ . Therefore this is a second order accurate scheme. Below is a plot of the derivative of the function and the value of this scheme for the function  $f(x) = \sin x$  and  $\Delta x = 1/4$ .

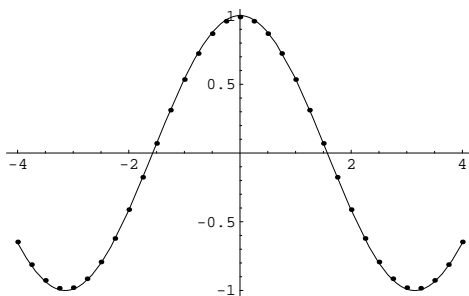

Figure 3.18: Centered Difference Scheme Approximation of the Derivative

Notice how the centered difference scheme gives a better approximation of the derivative than the forward difference scheme.

## 3.7 L'Hospital's Rule

Some singularities are easy to diagnose. Consider the function  $\frac{\cos x}{x}$  at the point  $x = 0$ . The function evaluates to  $\frac{1}{0}$  and is thus discontinuous at that point. Since the numerator and denominator are continuous functions and the

denominator vanishes while the numerator does not, the left and right limits as  $x \rightarrow 0$  do not exist. Thus the function has an infinite discontinuity at the point  $x = 0$ . More generally, a function which is composed of continuous functions and evaluates to  $\frac{a}{0}$  at a point where  $a \neq 0$  must have an infinite discontinuity there.

Other singularities require more analysis to diagnose. Consider the functions  $\frac{\sin x}{x}$ ,  $\frac{\sin x}{|x|}$  and  $\frac{\sin x}{1-\cos x}$  at the point  $x = 0$ . All three functions evaluate to  $\frac{0}{0}$  at that point, but have different kinds of singularities. The first has a removable discontinuity, the second has a finite discontinuity and the third has an infinite discontinuity. See Figure 3.19.

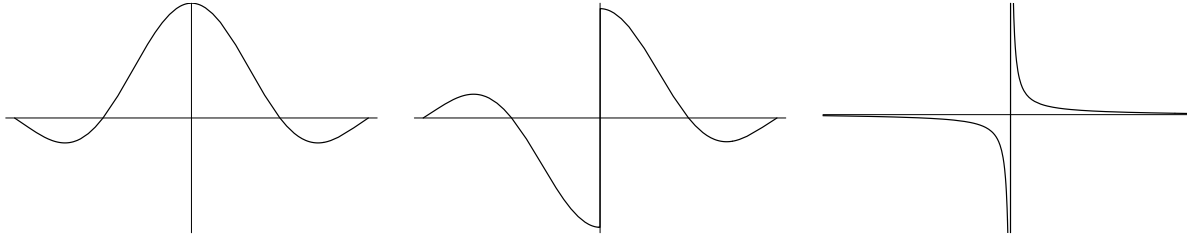

Figure 3.19: The functions  $\frac{\sin x}{x}$ ,  $\frac{\sin x}{|x|}$  and  $\frac{\sin x}{1-\cos x}$ .

An expression that evaluates to  $\frac{0}{0}$ ,  $\frac{\infty}{\infty}$ ,  $0 \cdot \infty$ ,  $\infty - \infty$ ,  $1^\infty$ ,  $0^0$  or  $\infty^0$  is called an *indeterminate*. A function  $f(x)$  which is indeterminate at the point  $x = \xi$  is singular at that point. The singularity may be a removable discontinuity, a finite discontinuity or an infinite discontinuity depending on the behavior of the function around that point. If  $\lim_{x \rightarrow \xi} f(x)$  exists, then the function has a removable discontinuity. If the limit does not exist, but the left and right limits do exist, then the function has a finite discontinuity. If either the left or right limit does not exist then the function has an infinite discontinuity.

**L'Hospital's Rule.** Let  $f(x)$  and  $g(x)$  be differentiable and  $f(\xi) = g(\xi) = 0$ . Further, let  $g(x)$  be nonzero in a deleted neighborhood of  $x = \xi$ , ( $g(x) \neq 0$  for  $x \in 0 < |x - \xi| < \delta$ ). Then

$$\lim_{x \rightarrow \xi} \frac{f(x)}{g(x)} = \lim_{x \rightarrow \xi} \frac{f'(x)}{g'(x)}.$$

To prove this, we note that  $f(\xi) = g(\xi) = 0$  and apply the generalized theorem of the mean. Note that

$$\frac{f(x)}{g(x)} = \frac{f(x) - f(\xi)}{g(x) - g(\xi)} = \frac{f'(\psi)}{g'(\psi)}$$

for some  $\psi$  between  $\xi$  and  $x$ . Thus

$$\lim_{x \rightarrow \xi} \frac{f(x)}{g(x)} = \lim_{\psi \rightarrow \xi} \frac{f'(\psi)}{g'(\psi)} = \lim_{x \rightarrow \xi} \frac{f'(x)}{g'(x)}$$

provided that the limits exist.

L'Hospital's Rule is also applicable when both functions tend to infinity instead of zero or when the limit point,  $\xi$ , is at infinity. It is also valid for one-sided limits.

L'Hospital's rule is directly applicable to the indeterminate forms  $\frac{0}{0}$  and  $\frac{\infty}{\infty}$ .

**Example 3.7.1** Consider the three functions  $\frac{\sin x}{x}$ ,  $\frac{\sin x}{|x|}$  and  $\frac{\sin x}{1 - \cos x}$  at the point  $x = 0$ .

$$\lim_{x \rightarrow 0} \frac{\sin x}{x} = \lim_{x \rightarrow 0} \frac{\cos x}{1} = 1$$

Thus  $\frac{\sin x}{x}$  has a removable discontinuity at  $x = 0$ .

$$\lim_{x \rightarrow 0^+} \frac{\sin x}{|x|} = \lim_{x \rightarrow 0^+} \frac{\sin x}{x} = 1$$

$$\lim_{x \rightarrow 0^-} \frac{\sin x}{|x|} = \lim_{x \rightarrow 0^-} \frac{\sin x}{-x} = -1$$

Thus  $\frac{\sin x}{|x|}$  has a finite discontinuity at  $x = 0$ .

$$\lim_{x \rightarrow 0} \frac{\sin x}{1 - \cos x} = \lim_{x \rightarrow 0} \frac{\cos x}{\sin x} = \frac{1}{0} = \infty$$

Thus  $\frac{\sin x}{1 - \cos x}$  has an infinite discontinuity at  $x = 0$ .

**Example 3.7.2** Let  $a$  and  $d$  be nonzero.

$$\begin{aligned} \lim_{x \rightarrow \infty} \frac{ax^2 + bx + c}{dx^2 + ex + f} &= \lim_{x \rightarrow \infty} \frac{2ax + b}{2dx + e} \\ &= \lim_{x \rightarrow \infty} \frac{2a}{2d} \\ &= \frac{a}{d} \end{aligned}$$

**Example 3.7.3** Consider

$$\lim_{x \rightarrow 0} \frac{\cos x - 1}{x \sin x}.$$

This limit is an indeterminate of the form  $\frac{0}{0}$ . Applying L'Hospital's rule we see that limit is equal to

$$\lim_{x \rightarrow 0} \frac{-\sin x}{x \cos x + \sin x}.$$

This limit is again an indeterminate of the form  $\frac{0}{0}$ . We apply L'Hospital's rule again.

$$\lim_{x \rightarrow 0} \frac{-\cos x}{-x \sin x + 2 \cos x} = -\frac{1}{2}$$

Thus the value of the original limit is  $-\frac{1}{2}$ . We could also obtain this result by expanding the functions in Taylor series.

$$\begin{aligned}
 \lim_{x \rightarrow 0} \frac{\cos x - 1}{x \sin x} &= \lim_{x \rightarrow 0} \frac{\left(1 - \frac{x^2}{2} + \frac{x^4}{24} - \dots\right) - 1}{x \left(x - \frac{x^3}{6} + \frac{x^5}{120} - \dots\right)} \\
 &= \lim_{x \rightarrow 0} \frac{-\frac{x^2}{2} + \frac{x^4}{24} - \dots}{x^2 - \frac{x^4}{6} + \frac{x^6}{120} - \dots} \\
 &= \lim_{x \rightarrow 0} \frac{-\frac{1}{2} + \frac{x^2}{24} - \dots}{1 - \frac{x^2}{6} + \frac{x^4}{120} - \dots} \\
 &= -\frac{1}{2}
 \end{aligned}$$

We can apply L'Hospital's Rule to the indeterminate forms  $0 \cdot \infty$  and  $\infty - \infty$  by rewriting the expression in a different form, (perhaps putting the expression over a common denominator). If at first you don't succeed, try, try again. You may have to apply L'Hospital's rule several times to evaluate a limit.

### Example 3.7.4

$$\begin{aligned}
 \lim_{x \rightarrow 0} \left( \cot x - \frac{1}{x} \right) &= \lim_{x \rightarrow 0} \frac{x \cos x - \sin x}{x \sin x} \\
 &= \lim_{x \rightarrow 0} \frac{\cos x - x \sin x - \cos x}{\sin x + x \cos x} \\
 &= \lim_{x \rightarrow 0} \frac{-x \sin x}{\sin x + x \cos x} \\
 &= \lim_{x \rightarrow 0} \frac{-x \cos x - \sin x}{\cos x + \cos x - x \sin x} \\
 &= 0
 \end{aligned}$$

You can apply L'Hospital's rule to the indeterminate forms  $1^\infty$ ,  $0^0$  or  $\infty^0$  by taking the logarithm of the expression.

**Example 3.7.5** Consider the limit,

$$\lim_{x \rightarrow 0} x^x,$$

which gives us the indeterminate form  $0^0$ . The logarithm of the expression is

$$\ln(x^x) = x \ln x.$$

As  $x \rightarrow 0$  we now have the indeterminate form  $0 \cdot \infty$ . By rewriting the expression, we can apply L'Hospital's rule.

$$\begin{aligned} \lim_{x \rightarrow 0} \frac{\ln x}{1/x} &= \lim_{x \rightarrow 0} \frac{1/x}{-1/x^2} \\ &= \lim_{x \rightarrow 0} (-x) \\ &= 0 \end{aligned}$$

Thus the original limit is

$$\lim_{x \rightarrow 0} x^x = e^0 = 1.$$



## 3.8 Exercises

### 3.8.1 Limits of Functions

#### Exercise 3.1

Does

$$\lim_{x \rightarrow 0} \sin\left(\frac{1}{x}\right)$$

exist?

[Hint](#), [Solution](#)

#### Exercise 3.2

Does

$$\lim_{x \rightarrow 0} x \sin\left(\frac{1}{x}\right)$$

exist?

[Hint](#), [Solution](#)

#### Exercise 3.3

Evaluate the limit:

$$\lim_{n \rightarrow \infty} \sqrt[n]{5}.$$

[Hint](#), [Solution](#)

### 3.8.2 Continuous Functions

#### Exercise 3.4

Is the function  $\sin(1/x)$  continuous in the open interval  $(0, 1)$ ? Is there a value of  $a$  such that the function defined by

$$f(x) = \begin{cases} \sin(1/x) & \text{for } x \neq 0, \\ a & \text{for } x = 0 \end{cases}$$

is continuous on the closed interval  $[0, 1]$ ?

[Hint](#), [Solution](#)

### Exercise 3.5

Is the function  $\sin(1/x)$  uniformly continuous in the open interval  $(0, 1)$ ?

[Hint](#), [Solution](#)

### Exercise 3.6

Are the functions  $\sqrt{x}$  and  $\frac{1}{x}$  uniformly continuous on the interval  $(0, 1)$ ?

[Hint](#), [Solution](#)

### Exercise 3.7

Prove that a function which is continuous on a closed interval is uniformly continuous on that interval.

[Hint](#), [Solution](#)

### Exercise 3.8

Prove or disprove each of the following.

1. If  $\lim_{n \rightarrow \infty} a_n = L$  then  $\lim_{n \rightarrow \infty} a_n^2 = L^2$ .
2. If  $\lim_{n \rightarrow \infty} a_n^2 = L^2$  then  $\lim_{n \rightarrow \infty} a_n = L$ .
3. If  $a_n > 0$  for all  $n > 200$ , and  $\lim_{n \rightarrow \infty} a_n = L$ , then  $L > 0$ .
4. If  $f : \mathbb{R} \mapsto \mathbb{R}$  is continuous and  $\lim_{x \rightarrow \infty} f(x) = L$ , then for  $n \in \mathbb{Z}$ ,  $\lim_{n \rightarrow \infty} f(n) = L$ .
5. If  $f : \mathbb{R} \mapsto \mathbb{R}$  is continuous and  $\lim_{n \rightarrow \infty} f(n) = L$ , then for  $x \in \mathbb{R}$ ,  $\lim_{x \rightarrow \infty} f(x) = L$ .

[Hint](#), [Solution](#)

## 3.8.3 The Derivative

### Exercise 3.9 (mathematica/calculus/differential/definition.nb)

Use the definition of differentiation to prove the following identities where  $f(x)$  and  $g(x)$  are differentiable functions and  $n$  is a positive integer.

1.  $\frac{d}{dx}(x^n) = nx^{n-1}$ , (I suggest that you use Newton's binomial formula.)
2.  $\frac{d}{dx}(f(x)g(x)) = f\frac{dg}{dx} + g\frac{df}{dx}$
3.  $\frac{d}{dx}(\sin x) = \cos x$ . (You'll need to use some trig identities.)
4.  $\frac{d}{dx}(f(g(x))) = f'(g(x))g'(x)$

Hint, Solution

### Exercise 3.10

Use the definition of differentiation to determine if the following functions differentiable at  $x = 0$ .

1.  $f(x) = x|x|$
2.  $f(x) = \sqrt{1 + |x|}$

Hint, Solution

### Exercise 3.11 (mathematica/calculus/differential/rules.nb)

Find the first derivatives of the following:

- a.  $x \sin(\cos x)$
- b.  $f(\cos(g(x)))$
- c.  $\frac{1}{f(\ln x)}$
- d.  $x^{x^x}$
- e.  $|x| \sin |x|$

Hint, Solution

### Exercise 3.12 (mathematica/calculus/differential/rules.nb)

Using

$$\frac{d}{dx} \sin x = \cos x \quad \text{and} \quad \frac{d}{dx} \tan x = \frac{1}{\cos^2 x}$$

find the derivatives of  $\arcsin x$  and  $\arctan x$ .

**Hint, Solution**

## 3.8.4 Implicit Differentiation

### Exercise 3.13 (mathematica/calculus/differential/implicit.nb)

Find  $y'(x)$ , given that  $x^2 + y^2 = 1$ . What is  $y'(1/2)$ ?

**Hint, Solution**

### Exercise 3.14 (mathematica/calculus/differential/implicit.nb)

Find  $y'(x)$  and  $y''(x)$ , given that  $x^2 - xy + y^2 = 3$ .

**Hint, Solution**

## 3.8.5 Maxima and Minima

### Exercise 3.15 (mathematica/calculus/differential/maxima.nb)

Identify any maxima and minima of the following functions.

a.  $f(x) = x(12 - 2x)^2$ .

b.  $f(x) = (x - 2)^{2/3}$ .

**Hint, Solution**

### Exercise 3.16 (mathematica/calculus/differential/maxima.nb)

A cylindrical container with a circular base and an open top is to hold  $64 \text{ cm}^3$ . Find its dimensions so that the surface area of the cup is a minimum.

**Hint, Solution**

## 3.8.6 Mean Value Theorems

### Exercise 3.17

Prove the generalized theorem of the mean. If  $f(x)$  and  $g(x)$  are continuous in  $[a, b]$  and differentiable in  $(a, b)$ , then there exists a point  $x = \xi$  such that

$$\frac{f'(\xi)}{g'(\xi)} = \frac{f(b) - f(a)}{g(b) - g(a)}.$$

Assume that  $g(a) \neq g(b)$  so that the denominator does not vanish and that  $f'(x)$  and  $g'(x)$  are not simultaneously zero which would produce an indeterminate form.

[Hint](#), [Solution](#)

### Exercise 3.18 (mathematica/calculus/differential/taylor.nb)

Find a polynomial approximation of  $\sin x$  on the interval  $[-1, 1]$  that has a maximum error of  $\frac{1}{1000}$ . Don't use any more terms than you need to. Prove the error bound. Use your polynomial to approximate  $\sin 1$ .

[Hint](#), [Solution](#)

### Exercise 3.19 (mathematica/calculus/differential/taylor.nb)

You use the formula  $\frac{f(x+\Delta x)-2f(x)+f(x-\Delta x))}{\Delta x^2}$  to approximate  $f''(x)$ . What is the error in this approximation?

[Hint](#), [Solution](#)

### Exercise 3.20

The formulas  $\frac{f(x+\Delta x)-f(x)}{\Delta x}$  and  $\frac{f(x+\Delta x)-f(x-\Delta x)}{2\Delta x}$  are first and second order accurate schemes for approximating the first derivative  $f'(x)$ . Find a couple other schemes that have successively higher orders of accuracy. Would these higher order schemes actually give a better approximation of  $f'(x)$ ? Remember that  $\Delta x$  is small, but not infinitesimal.

[Hint](#), [Solution](#)

## 3.8.7 L'Hospital's Rule

### Exercise 3.21 (mathematica/calculus/differential/lhospitals.nb)

Evaluate the following limits.

a.  $\lim_{x \rightarrow 0} \frac{x - \sin x}{x^3}$

b.  $\lim_{x \rightarrow 0} \left( \csc x - \frac{1}{x} \right)$

c.  $\lim_{x \rightarrow +\infty} \left( 1 + \frac{1}{x} \right)^x$

d.  $\lim_{x \rightarrow 0} \left( \csc^2 x - \frac{1}{x^2} \right)$ . (First evaluate using L'Hospital's rule then using a Taylor series expansion. You will find that the latter method is more convenient.)

Hint, Solution

**Exercise 3.22 (mathematica/calculus/differential/lhospitals.nb)**

Evaluate the following limits,

$$\lim_{x \rightarrow \infty} x^{a/x}, \quad \lim_{x \rightarrow \infty} \left( 1 + \frac{a}{x} \right)^{bx},$$

where  $a$  and  $b$  are constants.

Hint, Solution

## 3.9 Hints

### Hint 3.1

Apply the  $\epsilon, \delta$  definition of a limit.

### Hint 3.2

Set  $y = 1/x$ . Consider  $\lim_{y \rightarrow \infty}$ .

### Hint 3.3

Write  $\sqrt[n]{5}$  in terms of the exponential function.

### Hint 3.4

The composition of continuous functions is continuous. Apply the definition of continuity and look at the point  $x = 0$ .

### Hint 3.5

Note that for  $x_1 = \frac{1}{(n-1/2)\pi}$  and  $x_2 = \frac{1}{(n+1/2)\pi}$  where  $n \in \mathbb{Z}$  we have  $|\sin(1/x_1) - \sin(1/x_2)| = 2$ .

### Hint 3.6

Note that the function  $\sqrt{x+\delta} - \sqrt{x}$  is a decreasing function of  $x$  and an increasing function of  $\delta$  for positive  $x$  and  $\delta$ . Bound this function for fixed  $\delta$ .

Consider any positive  $\delta$  and  $\epsilon$ . For what values of  $x$  is

$$\frac{1}{x} - \frac{1}{x+\delta} > \epsilon.$$

### Hint 3.7

Let the function  $f(x)$  be continuous on a closed interval. Consider the function

$$e(x, \delta) = \sup_{|\xi-x|<\delta} |f(\xi) - f(x)|.$$

Bound  $e(x, \delta)$  with a function of  $\delta$  alone.

**Hint 3.8**

CONTINUE

1. If  $\lim_{n \rightarrow \infty} a_n = L$  then  $\lim_{n \rightarrow \infty} a_n^2 = L^2$ .
2. If  $\lim_{n \rightarrow \infty} a_n^2 = L^2$  then  $\lim_{n \rightarrow \infty} a_n = L$ .
3. If  $a_n > 0$  for all  $n > 200$ , and  $\lim_{n \rightarrow \infty} a_n = L$ , then  $L > 0$ .
4. If  $f : \mathbb{R} \mapsto \mathbb{R}$  is continuous and  $\lim_{x \rightarrow \infty} f(x) = L$ , then for  $n \in \mathbb{Z}$ ,  $\lim_{n \rightarrow \infty} f(n) = L$ .
5. If  $f : \mathbb{R} \mapsto \mathbb{R}$  is continuous and  $\lim_{n \rightarrow \infty} f(n) = L$ , then for  $x \in \mathbb{R}$ ,  $\lim_{x \rightarrow \infty} f(x) = L$ .

**Hint 3.9**

- a. Newton's binomial formula is

$$(a + b)^n = \sum_{k=0}^n \binom{n}{k} a^{n-k} b^k = a^n + a^{n-1}b + \frac{n(n-1)}{2} a^{n-2}b^2 + \dots + nab^{n-1} + b^n.$$

Recall that the binomial coefficient is

$$\binom{n}{k} = \frac{n!}{(n-k)!k!}.$$

- b. Note that

$$\frac{d}{dx}(f(x)g(x)) = \lim_{\Delta x \rightarrow 0} \left[ \frac{f(x + \Delta x)g(x + \Delta x) - f(x)g(x)}{\Delta x} \right]$$

and

$$g(x)f'(x) + f(x)g'(x) = g(x) \lim_{\Delta x \rightarrow 0} \left[ \frac{f(x + \Delta x) - f(x)}{\Delta x} \right] + f(x) \lim_{\Delta x \rightarrow 0} \left[ \frac{g(x + \Delta x) - g(x)}{\Delta x} \right].$$

Fill in the blank.



c. First prove that

$$\lim_{\theta \rightarrow 0} \frac{\sin \theta}{\theta} = 1.$$

and

$$\lim_{\theta \rightarrow 0} \left[ \frac{\cos \theta - 1}{\theta} \right] = 0.$$

d. Let  $u = g(x)$ . Consider a nonzero increment  $\Delta x$ , which induces the increments  $\Delta u$  and  $\Delta f$ . By definition,

$$\Delta f = f(u + \Delta u) - f(u), \quad \Delta u = g(x + \Delta x) - g(x),$$

and  $\Delta f, \Delta u \rightarrow 0$  as  $\Delta x \rightarrow 0$ . If  $\Delta u \neq 0$  then we have

$$\epsilon = \frac{\Delta f}{\Delta u} - \frac{df}{du} \rightarrow 0 \quad \text{as} \quad \Delta u \rightarrow 0.$$

If  $\Delta u = 0$  for some values of  $\Delta x$  then  $\Delta f$  also vanishes and we define  $\epsilon = 0$  for these values. In either case,

$$\Delta y = \frac{df}{du} \Delta u + \epsilon \Delta u.$$

Continue from here.

### Hint 3.10

### Hint 3.11

- Use the product rule and the chain rule.
- Use the chain rule.
- Use the quotient rule and the chain rule.
- Use the identity  $a^b = e^{b \ln a}$ .

e. For  $x > 0$ , the expression is  $x \sin x$ ; for  $x < 0$ , the expression is  $(-x) \sin(-x) = x \sin x$ . Do both cases.

### Hint 3.12

Use that  $x'(y) = 1/y'(x)$  and the identities  $\cos x = (1 - \sin^2 x)^{1/2}$  and  $\cos(\arctan x) = \frac{1}{(1+x^2)^{1/2}}$ .

### Hint 3.13

Differentiating the equation

$$x^2 + [y(x)]^2 = 1$$

yields

$$2x + 2y(x)y'(x) = 0.$$

Solve this equation for  $y'(x)$  and write  $y(x)$  in terms of  $x$ .

### Hint 3.14

Differentiate the equation and solve for  $y'(x)$  in terms of  $x$  and  $y(x)$ . Differentiate the expression for  $y'(x)$  to obtain  $y''(x)$ . You'll use that

$$x^2 - xy(x) + [y(x)]^2 = 3$$

### Hint 3.15

a. Use the second derivative test.

b. The function is not differentiable at the point  $x = 2$  so you can't use a derivative test at that point.

### Hint 3.16

Let  $r$  be the radius and  $h$  the height of the cylinder. The volume of the cup is  $\pi r^2 h = 64$ . The radius and height are related by  $h = \frac{64}{\pi r^2}$ . The surface area of the cup is  $f(r) = \pi r^2 + 2\pi r h = \pi r^2 + \frac{128}{r}$ . Use the second derivative test to find the minimum of  $f(r)$ .

### Hint 3.17

The proof is analogous to the proof of the theorem of the mean.

**Hint 3.18**

The first few terms in the Taylor series of  $\sin(x)$  about  $x = 0$  are

$$\sin(x) = x - \frac{x^3}{6} + \frac{x^5}{120} - \frac{x^7}{5040} + \frac{x^9}{362880} + \cdots.$$

When determining the error, use the fact that  $|\cos x_0| \leq 1$  and  $|x^n| \leq 1$  for  $x \in [-1, 1]$ .

**Hint 3.19**

The terms in the approximation have the Taylor series,

$$f(x + \Delta x) = f(x) + \Delta x f'(x) + \frac{\Delta x^2}{2} f''(x) + \frac{\Delta x^3}{6} f'''(x) + \frac{\Delta x^4}{24} f''''(x_1),$$

$$f(x - \Delta x) = f(x) - \Delta x f'(x) + \frac{\Delta x^2}{2} f''(x) - \frac{\Delta x^3}{6} f'''(x) + \frac{\Delta x^4}{24} f''''(x_2),$$

where  $x \leq x_1 \leq x + \Delta x$  and  $x - \Delta x \leq x_2 \leq x$ .

**Hint 3.20****Hint 3.21**

- Apply L'Hospital's rule three times.
- You can write the expression as

$$\frac{x - \sin x}{x \sin x}.$$

- Find the limit of the logarithm of the expression.
- It takes four successive applications of L'Hospital's rule to evaluate the limit.

For the Taylor series expansion method,

$$\csc^2 x - \frac{1}{x^2} = \frac{x^2 - \sin^2 x}{x^2 \sin^2 x} = \frac{x^2 - (x - x^3/6 + O(x^5))^2}{x^2(x + O(x^3))^2}$$

**Hint 3.22**

To evaluate the limits use the identity  $a^b = e^{b \ln a}$  and then apply L'Hospital's rule.

## 3.10 Solutions

### Solution 3.1

Note that in any open neighborhood of zero,  $(-\delta, \delta)$ , the function  $\sin(1/x)$  takes on all values in the interval  $[-1, 1]$ . Thus if we choose a positive  $\epsilon$  such that  $\epsilon < 1$  then there is no value of  $\psi$  for which  $|\sin(1/x) - \psi| < \epsilon$  for all  $x \in (-\epsilon, \epsilon)$ . Thus the limit does not exist.

### Solution 3.2

We make the change of variables  $y = 1/x$  and consider  $y \rightarrow \infty$ . We use that  $\sin(y)$  is bounded.

$$\lim_{x \rightarrow 0} x \sin\left(\frac{1}{x}\right) = \lim_{y \rightarrow \infty} \frac{1}{y} \sin(y) = 0$$

### Solution 3.3

We write  $\sqrt[n]{5}$  in terms of the exponential function and then evaluate the limit.

$$\begin{aligned} \lim_{n \rightarrow \infty} \sqrt[n]{5} &= \lim_{n \rightarrow \infty} \exp\left(\frac{\ln 5}{n}\right) \\ &= \exp\left(\lim_{n \rightarrow \infty} \frac{\ln 5}{n}\right) \\ &= e^0 \\ &= 1 \end{aligned}$$

### Solution 3.4

Since  $\frac{1}{x}$  is continuous in the interval  $(0, 1)$  and the function  $\sin(x)$  is continuous everywhere, the composition  $\sin(1/x)$  is continuous in the interval  $(0, 1)$ .

Since  $\lim_{x \rightarrow 0} \sin(1/x)$  does not exist, there is no way of defining  $\sin(1/x)$  at  $x = 0$  to produce a function that is continuous in  $[0, 1]$ .

### Solution 3.5

Note that for  $x_1 = \frac{1}{(n-1/2)\pi}$  and  $x_2 = \frac{1}{(n+1/2)\pi}$  where  $n \in \mathbb{Z}$  we have  $|\sin(1/x_1) - \sin(1/x_2)| = 2$ . Thus for any

$0 < \epsilon < 2$  there is no value of  $\delta > 0$  such that  $|\sin(1/x_1) - \sin(1/x_2)| < \epsilon$  for all  $x_1, x_2 \in (0, 1)$  and  $|x_1 - x_2| < \delta$ . Thus  $\sin(1/x)$  is not uniformly continuous in the open interval  $(0, 1)$ .

### Solution 3.6

First consider the function  $\sqrt{x}$ . Note that the function  $\sqrt{x + \delta} - \sqrt{x}$  is a decreasing function of  $x$  and an increasing function of  $\delta$  for positive  $x$  and  $\delta$ . Thus for any fixed  $\delta$ , the maximum value of  $\sqrt{x + \delta} - \sqrt{x}$  is bounded by  $\sqrt{\delta}$ . Therefore on the interval  $(0, 1)$ , a sufficient condition for  $|\sqrt{x} - \sqrt{\xi}| < \epsilon$  is  $|x - \xi| < \epsilon^2$ . The function  $\sqrt{x}$  is uniformly continuous on the interval  $(0, 1)$ .

Consider any positive  $\delta$  and  $\epsilon$ . Note that

$$\frac{1}{x} - \frac{1}{x + \delta} > \epsilon$$

for

$$x < \frac{1}{2} \left( \sqrt{\delta^2 + \frac{4\delta}{\epsilon}} - \delta \right).$$

Thus there is no value of  $\delta$  such that

$$\left| \frac{1}{x} - \frac{1}{\xi} \right| < \epsilon$$

for all  $|x - \xi| < \delta$ . The function  $\frac{1}{x}$  is not uniformly continuous on the interval  $(0, 1)$ .

### Solution 3.7

Let the function  $f(x)$  be continuous on a closed interval. Consider the function

$$e(x, \delta) = \sup_{|\xi - x| < \delta} |f(\xi) - f(x)|.$$

Since  $f(x)$  is continuous,  $e(x, \delta)$  is a continuous function of  $x$  on the same closed interval. Since continuous functions on closed intervals are bounded, there is a continuous, increasing function  $\epsilon(\delta)$  satisfying,

$$e(x, \delta) \leq \epsilon(\delta),$$

for all  $x$  in the closed interval. Since  $\epsilon(\delta)$  is continuous and increasing, it has an inverse  $\delta(\epsilon)$ . Now note that  $|f(x) - f(\xi)| < \epsilon$  for all  $x$  and  $\xi$  in the closed interval satisfying  $|x - \xi| < \delta(\epsilon)$ . Thus the function is uniformly continuous in the closed interval.

### Solution 3.8

1. The statement

$$\lim_{n \rightarrow \infty} a_n = L$$

is equivalent to

$$\forall \epsilon > 0, \exists N \text{ s.t. } n > N \Rightarrow |a_n - L| < \epsilon.$$

We want to show that

$$\forall \delta > 0, \exists M \text{ s.t. } m > M \Rightarrow |a_n^2 - L^2| < \delta.$$

Suppose that  $|a_n - L| < \epsilon$ . We obtain an upper bound on  $|a_n^2 - L^2|$ .

$$|a_n^2 - L^2| = |a_n - L||a_n + L| < \epsilon(|2L| + \epsilon)$$

Now we choose a value of  $\epsilon$  such that  $|a_n^2 - L^2| < \delta$

$$\begin{aligned}\epsilon(|2L| + \epsilon) &= \delta \\ \epsilon &= \sqrt{L^2 + \delta} - |L|\end{aligned}$$

Consider any fixed  $\delta > 0$ . We see that since

$$\text{for } \epsilon = \sqrt{L^2 + \delta} - |L|, \exists N \text{ s.t. } n > N \Rightarrow |a_n - L| < \epsilon$$

implies that

$$n > N \Rightarrow |a_n^2 - L^2| < \delta.$$

Therefore

$$\forall \delta > 0, \exists M \text{ s.t. } m > M \Rightarrow |a_n^2 - L^2| < \delta.$$

We conclude that  $\lim_{n \rightarrow \infty} a_n^2 = L^2$ .

2.  $\lim_{n \rightarrow \infty} a_n^2 = L^2$  does not imply that  $\lim_{n \rightarrow \infty} a_n = L$ . Consider  $a_n = -1$ . In this case  $\lim_{n \rightarrow \infty} a_n^2 = 1$  and  $\lim_{n \rightarrow \infty} a_n = -1$ .

3. If  $a_n > 0$  for all  $n > 200$ , and  $\lim_{n \rightarrow \infty} a_n = L$ , then  $L$  is not necessarily positive. Consider  $a_n = 1/n$ , which satisfies the two constraints.

$$\lim_{n \rightarrow \infty} \frac{1}{n} = 0$$

4. The statement  $\lim_{x \rightarrow \infty} f(x) = L$  is equivalent to

$$\forall \epsilon > 0, \exists X \text{ s.t. } x > X \Rightarrow |f(x) - L| < \epsilon.$$

This implies that for  $n > \lceil X \rceil$ ,  $|f(n) - L| < \epsilon$ .

$$\forall \epsilon > 0, \exists N \text{ s.t. } n > N \Rightarrow |f(n) - L| < \epsilon$$

$$\lim_{n \rightarrow \infty} f(n) = L$$

5. If  $f : \mathbb{R} \mapsto \mathbb{R}$  is continuous and  $\lim_{n \rightarrow \infty} f(n) = L$ , then for  $x \in \mathbb{R}$ , it is not necessarily true that  $\lim_{x \rightarrow \infty} f(x) = L$ . Consider  $f(x) = \sin(\pi x)$ .

$$\lim_{n \rightarrow \infty} \sin(\pi n) = \lim_{n \rightarrow \infty} 0 = 0$$

$\lim_{x \rightarrow \infty} \sin(\pi x)$  does not exist.

### Solution 3.9

a.

$$\begin{aligned} \frac{d}{dx}(x^n) &= \lim_{\Delta x \rightarrow 0} \left[ \frac{(x + \Delta x)^n - x^n}{\Delta x} \right] \\ &= \lim_{\Delta x \rightarrow 0} \left[ \frac{\left( x^n + nx^{n-1}\Delta x + \frac{n(n-1)}{2}x^{n-2}\Delta x^2 + \dots + \Delta x^n \right) - x^n}{\Delta x} \right] \\ &= \lim_{\Delta x \rightarrow 0} \left[ nx^{n-1} + \frac{n(n-1)}{2}x^{n-2}\Delta x + \dots + \Delta x^{n-1} \right] \\ &= nx^{n-1} \end{aligned}$$



$$\frac{d}{dx}(x^n) = nx^{n-1}$$

b.

$$\begin{aligned}\frac{d}{dx}(f(x)g(x)) &= \lim_{\Delta x \rightarrow 0} \left[ \frac{f(x + \Delta x)g(x + \Delta x) - f(x)g(x)}{\Delta x} \right] \\ &= \lim_{\Delta x \rightarrow 0} \left[ \frac{[f(x + \Delta x)g(x + \Delta x) - f(x)g(x + \Delta x)] + [f(x)g(x + \Delta x) - f(x)g(x)]}{\Delta x} \right] \\ &= \lim_{\Delta x \rightarrow 0} [g(x + \Delta x)] \lim_{\Delta x \rightarrow 0} \left[ \frac{f(x + \Delta x) - f(x)}{\Delta x} \right] + f(x) \lim_{\Delta x \rightarrow 0} \left[ \frac{g(x + \Delta x) - g(x)}{\Delta x} \right] \\ &= g(x)f'(x) + f(x)g'(x)\end{aligned}$$

$$\frac{d}{dx}(f(x)g(x)) = f(x)g'(x) + f'(x)g(x)$$

c. Consider a right triangle with hypotenuse of length 1 in the first quadrant of the plane. Label the vertices  $A$ ,  $B$ ,  $C$ , in clockwise order, starting with the vertex at the origin. The angle of  $A$  is  $\theta$ . The length of a circular arc of radius  $\cos \theta$  that connects  $C$  to the hypotenuse is  $\theta \cos \theta$ . The length of the side  $BC$  is  $\sin \theta$ . The length of a circular arc of radius 1 that connects  $B$  to the  $x$  axis is  $\theta$ . (See Figure 3.20.)

Considering the length of these three curves gives us the inequality:

$$\theta \cos \theta \leq \sin \theta \leq \theta.$$

Dividing by  $\theta$ ,

$$\cos \theta \leq \frac{\sin \theta}{\theta} \leq 1.$$

Taking the limit as  $\theta \rightarrow 0$  gives us

$$\lim_{\theta \rightarrow 0} \frac{\sin \theta}{\theta} = 1.$$

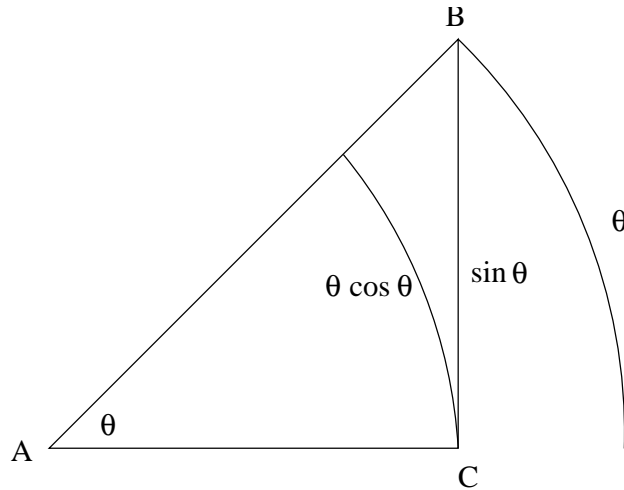

Figure 3.20:

One more little tidbit we'll need to know is

$$\begin{aligned}
 \lim_{\theta \rightarrow 0} \left[ \frac{\cos \theta - 1}{\theta} \right] &= \lim_{\theta \rightarrow 0} \left[ \frac{\cos \theta - 1}{\theta} \frac{\cos \theta + 1}{\cos \theta + 1} \right] \\
 &= \lim_{\theta \rightarrow 0} \left[ \frac{\cos^2 \theta - 1}{\theta(\cos \theta + 1)} \right] \\
 &= \lim_{\theta \rightarrow 0} \left[ \frac{-\sin^2 \theta}{\theta(\cos \theta + 1)} \right] \\
 &= \lim_{\theta \rightarrow 0} \left[ \frac{-\sin \theta}{\theta} \right] \lim_{\theta \rightarrow 0} \left[ \frac{\sin \theta}{(\cos \theta + 1)} \right] \\
 &= (-1) \left( \frac{0}{2} \right) \\
 &= 0.
 \end{aligned}$$

Now we're ready to find the derivative of  $\sin x$ .

$$\begin{aligned}\frac{d}{dx}(\sin x) &= \lim_{\Delta x \rightarrow 0} \left[ \frac{\sin(x + \Delta x) - \sin x}{\Delta x} \right] \\ &= \lim_{\Delta x \rightarrow 0} \left[ \frac{\cos x \sin \Delta x + \sin x \cos \Delta x - \sin x}{\Delta x} \right] \\ &= \cos x \lim_{\Delta x \rightarrow 0} \left[ \frac{\sin \Delta x}{\Delta x} \right] + \sin x \lim_{\Delta x \rightarrow 0} \left[ \frac{\cos \Delta x - 1}{\Delta x} \right] \\ &= \cos x\end{aligned}$$

$$\boxed{\frac{d}{dx}(\sin x) = \cos x}$$

d. Let  $u = g(x)$ . Consider a nonzero increment  $\Delta x$ , which induces the increments  $\Delta u$  and  $\Delta f$ . By definition,

$$\Delta f = f(u + \Delta u) - f(u), \quad \Delta u = g(x + \Delta x) - g(x),$$

and  $\Delta f, \Delta u \rightarrow 0$  as  $\Delta x \rightarrow 0$ . If  $\Delta u \neq 0$  then we have

$$\epsilon = \frac{\Delta f}{\Delta u} - \frac{df}{du} \rightarrow 0 \quad \text{as} \quad \Delta u \rightarrow 0.$$

If  $\Delta u = 0$  for some values of  $\Delta x$  then  $\Delta f$  also vanishes and we define  $\epsilon = 0$  for these values. In either case,

$$\Delta y = \frac{df}{du} \Delta u + \epsilon \Delta u.$$

We divide this equation by  $\Delta x$  and take the limit as  $\Delta x \rightarrow 0$ .

$$\begin{aligned}\frac{df}{dx} &= \lim_{\Delta x \rightarrow 0} \frac{\Delta f}{\Delta x} \\ &= \lim_{\Delta x \rightarrow 0} \left( \frac{df}{du} \frac{\Delta u}{\Delta x} + \epsilon \frac{\Delta u}{\Delta x} \right) \\ &= \left( \frac{df}{du} \right) \left( \lim_{\Delta x \rightarrow 0} \frac{\Delta f}{\Delta x} \right) + \left( \lim_{\Delta x \rightarrow 0} \epsilon \right) \left( \lim_{\Delta x \rightarrow 0} \frac{\Delta u}{\Delta x} \right) \\ &= \frac{df}{du} \frac{du}{dx} + (0) \left( \frac{du}{dx} \right) \\ &= \frac{df}{du} \frac{du}{dx}\end{aligned}$$

Thus we see that

$$\boxed{\frac{d}{dx}(f(g(x))) = f'(g(x))g'(x).}$$

### Solution 3.10

1.

$$\begin{aligned}f'(0) &= \lim_{\epsilon \rightarrow 0} \frac{\epsilon|\epsilon| - 0}{\epsilon} \\ &= \lim_{\epsilon \rightarrow 0} |\epsilon| \\ &= 0\end{aligned}$$

The function is differentiable at  $x = 0$ .

2.

$$\begin{aligned} f'(0) &= \lim_{\epsilon \rightarrow 0} \frac{\sqrt{1+|\epsilon|} - 1}{\epsilon} \\ &= \lim_{\epsilon \rightarrow 0} \frac{\frac{1}{2}(1+|\epsilon|)^{-1/2} \text{sign}(\epsilon)}{1} \\ &= \lim_{\epsilon \rightarrow 0} \frac{1}{2} \text{sign}(\epsilon) \end{aligned}$$

Since the limit does not exist, the function is not differentiable at  $x = 0$ .

### Solution 3.11

a.

$$\begin{aligned} \frac{d}{dx}[x \sin(\cos x)] &= \frac{d}{dx}[x] \sin(\cos x) + x \frac{d}{dx}[\sin(\cos x)] \\ &= \sin(\cos x) + x \cos(\cos x) \frac{d}{dx}[\cos x] \\ &= \sin(\cos x) - x \cos(\cos x) \sin x \end{aligned}$$

$$\boxed{\frac{d}{dx}[x \sin(\cos x)] = \sin(\cos x) - x \cos(\cos x) \sin x}$$

b.

$$\begin{aligned} \frac{d}{dx}[f(\cos(g(x)))] &= f'(\cos(g(x))) \frac{d}{dx}[\cos(g(x))] \\ &= -f'(\cos(g(x))) \sin(g(x)) \frac{d}{dx}[g(x)] \\ &= -f'(\cos(g(x))) \sin(g(x)) g'(x) \end{aligned}$$

$$\boxed{\frac{d}{dx}[f(\cos(g(x)))] = -f'(\cos(g(x))) \sin(g(x)) g'(x)}$$

c.

$$\begin{aligned}\frac{d}{dx} \left[ \frac{1}{f(\ln x)} \right] &= -\frac{\frac{d}{dx}[f(\ln x)]}{[f(\ln x)]^2} \\ &= -\frac{f'(\ln x) \frac{d}{dx}[\ln x]}{[f(\ln x)]^2} \\ &= -\frac{f'(\ln x)}{x[f(\ln x)]^2}\end{aligned}$$

$$\boxed{\frac{d}{dx} \left[ \frac{1}{f(\ln x)} \right] = -\frac{f'(\ln x)}{x[f(\ln x)]^2}}$$

d. First we write the expression in terms exponentials and logarithms,

$$x^{x^x} = x^{\exp(x \ln x)} = \exp(\exp(x \ln x) \ln x).$$

Then we differentiate using the chain rule and the product rule.

$$\begin{aligned}\frac{d}{dx} \exp(\exp(x \ln x) \ln x) &= \exp(\exp(x \ln x) \ln x) \frac{d}{dx}(\exp(x \ln x) \ln x) \\ &= x^{x^x} \left( \exp(x \ln x) \frac{d}{dx}(x \ln x) \ln x + \exp(x \ln x) \frac{1}{x} \right) \\ &= x^{x^x} \left( x^x (\ln x + x \frac{1}{x}) \ln x + x^{-1} \exp(x \ln x) \right) \\ &= x^{x^x} (x^x (\ln x + 1) \ln x + x^{-1} x^x) \\ &= x^{x^x+x} (x^{-1} + \ln x + \ln^2 x)\end{aligned}$$

$$\boxed{\frac{d}{dx} x^{x^x} = x^{x^x+x} (x^{-1} + \ln x + \ln^2 x)}$$

e. For  $x > 0$ , the expression is  $x \sin x$ ; for  $x < 0$ , the expression is  $(-x) \sin(-x) = x \sin x$ . Thus we see that

$$|x| \sin |x| = x \sin x.$$

The first derivative of this is

$$\sin x + x \cos x.$$

$$\boxed{\frac{d}{dx}(|x| \sin |x|) = \sin x + x \cos x}$$

### Solution 3.12

Let  $y(x) = \sin x$ . Then  $y'(x) = \cos x$ .

$$\begin{aligned} \frac{d}{dy} \arcsin y &= \frac{1}{y'(x)} \\ &= \frac{1}{\cos x} \\ &= \frac{1}{(1 - \sin^2 x)^{1/2}} \\ &= \frac{1}{(1 - y^2)^{1/2}} \end{aligned}$$

$$\boxed{\frac{d}{dx} \arcsin x = \frac{1}{(1 - x^2)^{1/2}}}$$

Let  $y(x) = \tan x$ . Then  $y'(x) = 1/\cos^2 x$ .

$$\begin{aligned}\frac{d}{dy} \arctan y &= \frac{1}{y'(x)} \\ &= \cos^2 x \\ &= \cos^2(\arctan y) \\ &= \left( \frac{1}{(1+y^2)^{1/2}} \right) \\ &= \frac{1}{1+y^2}\end{aligned}$$

$$\boxed{\frac{d}{dx} \arctan x = \frac{1}{1+x^2}}$$

### Solution 3.13

Differentiating the equation

$$x^2 + [y(x)]^2 = 1$$

yields

$$2x + 2y(x)y'(x) = 0.$$

We can solve this equation for  $y'(x)$ .

$$y'(x) = -\frac{x}{y(x)}$$

To find  $y'(1/2)$  we need to find  $y(x)$  in terms of  $x$ .

$$y(x) = \pm\sqrt{1-x^2}$$

Thus  $y'(x)$  is

$$y'(x) = \pm\frac{x}{\sqrt{1-x^2}}.$$



$y'(1/2)$  can have the two values:

$$y' \left( \frac{1}{2} \right) = \pm \frac{1}{\sqrt{3}}.$$

### Solution 3.14

Differentiating the equation

$$x^2 - xy(x) + [y(x)]^2 = 3$$

yields

$$2x - y(x) - xy'(x) + 2y(x)y'(x) = 0.$$

Solving this equation for  $y'(x)$

$$y'(x) = \frac{y(x) - 2x}{2y(x) - x}.$$

Now we differentiate  $y'(x)$  to get  $y''(x)$ .

$$y''(x) = \frac{(y'(x) - 2)(2y(x) - x) - (y(x) - 2x)(2y'(x) - 1)}{(2y(x) - x)^2},$$

$$y''(x) = 3 \frac{xy'(x) - y(x)}{(2y(x) - x)^2},$$

$$y''(x) = 3 \frac{x \frac{y(x) - 2x}{2y(x) - x} - y(x)}{(2y(x) - x)^2},$$

$$y''(x) = 3 \frac{x(y(x) - 2x) - y(x)(2y(x) - x)}{(2y(x) - x)^3},$$

$$y''(x) = -6 \frac{x^2 - xy(x) + [y(x)]^2}{(2y(x) - x)^3},$$

$$y''(x) = \frac{-18}{(2y(x) - x)^3},$$

### Solution 3.15

a.

$$\begin{aligned}f'(x) &= (12 - 2x)^2 + 2x(12 - 2x)(-2) \\ &= 4(x - 6)^2 + 8x(x - 6) \\ &= 12(x - 2)(x - 6)\end{aligned}$$

There are critical points at  $x = 2$  and  $x = 6$ .

$$f''(x) = 12(x - 2) + 12(x - 6) = 24(x - 4)$$

Since  $f''(2) = -48 < 0$ ,  $x = 2$  is a local maximum. Since  $f''(6) = 48 > 0$ ,  $x = 6$  is a local minimum.

b.

$$f'(x) = \frac{2}{3}(x - 2)^{-1/3}$$

The first derivative exists and is nonzero for  $x \neq 2$ . At  $x = 2$ , the derivative does not exist and thus  $x = 2$  is a critical point. For  $x < 2$ ,  $f'(x) < 0$  and for  $x > 2$ ,  $f'(x) > 0$ .  $x = 2$  is a local minimum.

### Solution 3.16

Let  $r$  be the radius and  $h$  the height of the cylinder. The volume of the cup is  $\pi r^2 h = 64$ . The radius and height are related by  $h = \frac{64}{\pi r^2}$ . The surface area of the cup is  $f(r) = \pi r^2 + 2\pi r h = \pi r^2 + \frac{128}{r}$ . The first derivative of the surface area is  $f'(r) = 2\pi r - \frac{128}{r^2}$ . Finding the zeros of  $f'(r)$ ,

$$2\pi r - \frac{128}{r^2} = 0,$$

$$2\pi r^3 - 128 = 0,$$

$$r = \frac{4}{\sqrt[3]{\pi}}.$$

The second derivative of the surface area is  $f''(r) = 2\pi + \frac{256}{r^3}$ . Since  $f''(\frac{4}{\sqrt[3]{\pi}}) = 6\pi$ ,  $r = \frac{4}{\sqrt[3]{\pi}}$  is a local minimum of  $f(r)$ . Since this is the only critical point for  $r > 0$ , it must be a global minimum.

The cup has a radius of  $\frac{4}{\sqrt[3]{\pi}}$  cm and a height of  $\frac{4}{\sqrt[3]{\pi}}$ .

**Solution 3.17**

We define the function

$$h(x) = f(x) - f(a) - \frac{f(b) - f(a)}{g(b) - g(a)}(g(x) - g(a)).$$

Note that  $h(x)$  is differentiable and that  $h(a) = h(b) = 0$ . Thus  $h(x)$  satisfies the conditions of Rolle's theorem and there exists a point  $\xi \in (a, b)$  such that

$$h'(\xi) = f'(\xi) - \frac{f(b) - f(a)}{g(b) - g(a)}g'(\xi) = 0,$$

$$\frac{f'(\xi)}{g'(\xi)} = \frac{f(b) - f(a)}{g(b) - g(a)}.$$

**Solution 3.18**

The first few terms in the Taylor series of  $\sin(x)$  about  $x = 0$  are

$$\sin(x) = x - \frac{x^3}{6} + \frac{x^5}{120} - \frac{x^7}{5040} + \frac{x^9}{362880} + \cdots.$$

The seventh derivative of  $\sin x$  is  $-\cos x$ . Thus we have that

$$\sin(x) = x - \frac{x^3}{6} + \frac{x^5}{120} - \frac{\cos x_0}{5040}x^7,$$

where  $0 \leq x_0 \leq x$ . Since we are considering  $x \in [-1, 1]$  and  $-1 \leq \cos(x_0) \leq 1$ , the approximation

$$\boxed{\sin x \approx x - \frac{x^3}{6} + \frac{x^5}{120}}$$

has a maximum error of  $\frac{1}{5040} \approx 0.000198$ . Using this polynomial to approximate  $\sin(1)$ ,

$$\boxed{1 - \frac{1^3}{6} + \frac{1^5}{120} \approx 0.841667.}$$

To see that this has the required accuracy,

$$\sin(1) \approx 0.841471.$$

### Solution 3.19

Expanding the terms in the approximation in Taylor series,

$$f(x + \Delta x) = f(x) + \Delta x f'(x) + \frac{\Delta x^2}{2} f''(x) + \frac{\Delta x^3}{6} f'''(x) + \frac{\Delta x^4}{24} f''''(x_1),$$

$$f(x - \Delta x) = f(x) - \Delta x f'(x) + \frac{\Delta x^2}{2} f''(x) - \frac{\Delta x^3}{6} f'''(x) + \frac{\Delta x^4}{24} f''''(x_2),$$

where  $x \leq x_1 \leq x + \Delta x$  and  $x - \Delta x \leq x_2 \leq x$ . Substituting the expansions into the formula,

$$\frac{f(x + \Delta x) - 2f(x) + f(x - \Delta x)}{\Delta x^2} = f''(x) + \frac{\Delta x^2}{24} [f''''(x_1) + f''''(x_2)].$$

Thus the error in the approximation is

$$\boxed{\frac{\Delta x^2}{24} [f''''(x_1) + f''''(x_2)]}.$$

### Solution 3.20

### Solution 3.21

a.

$$\begin{aligned} \lim_{x \rightarrow 0} \left[ \frac{x - \sin x}{x^3} \right] &= \lim_{x \rightarrow 0} \left[ \frac{1 - \cos x}{3x^2} \right] \\ &= \lim_{x \rightarrow 0} \left[ \frac{\sin x}{6x} \right] \\ &= \lim_{x \rightarrow 0} \left[ \frac{\cos x}{6} \right] \\ &= \frac{1}{6} \end{aligned}$$

$$\lim_{x \rightarrow 0} \left[ \frac{x - \sin x}{x^3} \right] = \frac{1}{6}$$

b.

$$\begin{aligned} \lim_{x \rightarrow 0} \left( \csc x - \frac{1}{x} \right) &= \lim_{x \rightarrow 0} \left( \frac{1}{\sin x} - \frac{1}{x} \right) \\ &= \lim_{x \rightarrow 0} \left( \frac{x - \sin x}{x \sin x} \right) \\ &= \lim_{x \rightarrow 0} \left( \frac{1 - \cos x}{x \cos x + \sin x} \right) \\ &= \lim_{x \rightarrow 0} \left( \frac{\sin x}{-x \sin x + \cos x + \cos x} \right) \\ &= \frac{0}{2} \\ &= 0 \end{aligned}$$

$$\lim_{x \rightarrow 0} \left( \csc x - \frac{1}{x} \right) = 0$$

C.

$$\begin{aligned}\ln \left( \lim_{x \rightarrow +\infty} \left[ \left( 1 + \frac{1}{x} \right)^x \right] \right) &= \lim_{x \rightarrow +\infty} \left[ \ln \left( \left( 1 + \frac{1}{x} \right)^x \right) \right] \\ &= \lim_{x \rightarrow +\infty} \left[ x \ln \left( 1 + \frac{1}{x} \right) \right] \\ &= \lim_{x \rightarrow +\infty} \left[ \frac{\ln \left( 1 + \frac{1}{x} \right)}{1/x} \right] \\ &= \lim_{x \rightarrow +\infty} \left[ \frac{\left( 1 + \frac{1}{x} \right)^{-1} \left( -\frac{1}{x^2} \right)}{-1/x^2} \right] \\ &= \lim_{x \rightarrow +\infty} \left[ \left( 1 + \frac{1}{x} \right)^{-1} \right] \\ &= 1\end{aligned}$$

Thus we have

$$\boxed{\lim_{x \rightarrow +\infty} \left[ \left( 1 + \frac{1}{x} \right)^x \right] = e.}$$

d. It takes four successive applications of L'Hospital's rule to evaluate the limit.

$$\begin{aligned}
 \lim_{x \rightarrow 0} \left( \csc^2 x - \frac{1}{x^2} \right) &= \lim_{x \rightarrow 0} \frac{x^2 - \sin^2 x}{x^2 \sin^2 x} \\
 &= \lim_{x \rightarrow 0} \frac{2x - 2 \cos x \sin x}{2x^2 \cos x \sin x + 2x \sin^2 x} \\
 &= \lim_{x \rightarrow 0} \frac{2 - 2 \cos^2 x + 2 \sin^2 x}{2x^2 \cos^2 x + 8x \cos x \sin x + 2 \sin^2 x - 2x^2 \sin^2 x} \\
 &= \lim_{x \rightarrow 0} \frac{8 \cos x \sin x}{12x \cos^2 x + 12 \cos x \sin x - 8x^2 \cos x \sin x - 12x \sin^2 x} \\
 &= \lim_{x \rightarrow 0} \frac{8 \cos^2 x - 8 \sin^2 x}{24 \cos^2 x - 8x^2 \cos^2 x - 64x \cos x \sin x - 24 \sin^2 x + 8x^2 \sin^2 x} \\
 &= \frac{1}{3}
 \end{aligned}$$

It is easier to use a Taylor series expansion.

$$\begin{aligned}
 \lim_{x \rightarrow 0} \left( \csc^2 x - \frac{1}{x^2} \right) &= \lim_{x \rightarrow 0} \frac{x^2 - \sin^2 x}{x^2 \sin^2 x} \\
 &= \lim_{x \rightarrow 0} \frac{x^2 - (x - x^3/6 + O(x^5))^2}{x^2(x + O(x^3))^2} \\
 &= \lim_{x \rightarrow 0} \frac{x^2 - (x^2 - x^4/3 + O(x^6))}{x^4 + O(x^6)} \\
 &= \lim_{x \rightarrow 0} \left( \frac{1}{3} + O(x^2) \right) \\
 &= \frac{1}{3}
 \end{aligned}$$

**Solution 3.22**

To evaluate the first limit, we use the identity  $a^b = e^{b \ln a}$  and then apply L'Hospital's rule.

$$\begin{aligned}\lim_{x \rightarrow \infty} x^{a/x} &= \lim_{x \rightarrow \infty} e^{\frac{a \ln x}{x}} \\ &= \exp \left( \lim_{x \rightarrow \infty} \frac{a \ln x}{x} \right) \\ &= \exp \left( \lim_{x \rightarrow \infty} \frac{a/x}{1} \right) \\ &= e^0\end{aligned}$$

$$\boxed{\lim_{x \rightarrow \infty} x^{a/x} = 1}$$

We use the same method to evaluate the second limit.

$$\begin{aligned}\lim_{x \rightarrow \infty} \left(1 + \frac{a}{x}\right)^{bx} &= \lim_{x \rightarrow \infty} \exp \left( bx \ln \left(1 + \frac{a}{x}\right) \right) \\ &= \exp \left( \lim_{x \rightarrow \infty} bx \ln \left(1 + \frac{a}{x}\right) \right) \\ &= \exp \left( \lim_{x \rightarrow \infty} b \frac{\ln(1 + a/x)}{1/x} \right) \\ &= \exp \left( \lim_{x \rightarrow \infty} b \frac{\frac{-a/x^2}{1+a/x}}{-1/x^2} \right) \\ &= \exp \left( \lim_{x \rightarrow \infty} b \frac{a}{1 + a/x} \right)\end{aligned}$$

$$\boxed{\lim_{x \rightarrow \infty} \left(1 + \frac{a}{x}\right)^{bx} = e^{ab}}$$



## 3.11 Quiz

### Problem 3.1

Define *continuity*.

**Solution**

### Problem 3.2

Fill in the blank with *necessary*, *sufficient* or *necessary and sufficient*.

Continuity is a \_\_\_\_\_ condition for differentiability.

Differentiability is a \_\_\_\_\_ condition for continuity.

Existence of  $\lim_{\Delta x \rightarrow 0} \frac{f(x+\Delta x) - f(x)}{\Delta x}$  is a \_\_\_\_\_ condition for differentiability.

**Solution**

### Problem 3.3

Evaluate  $\frac{d}{dx} f(g(x)h(x))$ .

**Solution**

### Problem 3.4

Evaluate  $\frac{d}{dx} f(x)^{g(x)}$ .

**Solution**

### Problem 3.5

State the Theorem of the Mean. Interpret the theorem physically.

**Solution**

### Problem 3.6

State Taylor's Theorem of the Mean.

**Solution**

### Problem 3.7

Evaluate  $\lim_{x \rightarrow 0} (\sin x)^{\sin x}$ .

**Solution**

## 3.12 Quiz Solutions

### Solution 3.1

A function  $y(x)$  is said to be *continuous at*  $x = \xi$  if  $\lim_{x \rightarrow \xi} y(x) = y(\xi)$ .

### Solution 3.2

Continuity is a necessary condition for differentiability.

Differentiability is a sufficient condition for continuity.

Existence of  $\lim_{\Delta x \rightarrow 0} \frac{f(x+\Delta x) - f(x)}{\Delta x}$  is a necessary and sufficient condition for differentiability.

### Solution 3.3

$$\frac{d}{dx} f(g(x)h(x)) = f'(g(x)h(x)) \frac{d}{dx} (g(x)h(x)) = f'(g(x)h(x))(g'(x)h(x) + g(x)h'(x))$$

### Solution 3.4

$$\begin{aligned} \frac{d}{dx} f(x)^{g(x)} &= \frac{d}{dx} e^{g(x) \ln f(x)} \\ &= e^{g(x) \ln f(x)} \frac{d}{dx} (g(x) \ln f(x)) \\ &= f(x)^{g(x)} \left( g'(x) \ln f(x) + g(x) \frac{f'(x)}{f(x)} \right) \end{aligned}$$

### Solution 3.5

If  $f(x)$  is continuous in  $[a..b]$  and differentiable in  $(a..b)$  then there exists a point  $x = \xi$  such that

$$f'(\xi) = \frac{f(b) - f(a)}{b - a}.$$

That is, there is a point where the instantaneous velocity is equal to the average velocity on the interval.

**Solution 3.6**

If  $f(x)$  is  $n + 1$  times continuously differentiable in  $(a..b)$  then there exists a point  $x = \xi \in (a..b)$  such that

$$f(b) = f(a) + (b - a)f'(a) + \frac{(b - a)^2}{2!}f''(a) + \dots + \frac{(b - a)^n}{n!}f^{(n)}(a) + \frac{(b - a)^{n+1}}{(n + 1)!}f^{(n+1)}(\xi).$$

**Solution 3.7**

Consider  $\lim_{x \rightarrow 0} (\sin x)^{\sin x}$ . This is an indeterminate of the form  $0^0$ . The limit of the logarithm of the expression is  $\lim_{x \rightarrow 0} \sin x \ln(\sin x)$ . This is an indeterminate of the form  $0 \cdot \infty$ . We can rearrange the expression to obtain an indeterminate of the form  $\frac{\infty}{\infty}$  and then apply L'Hospital's rule.

$$\lim_{x \rightarrow 0} \frac{\ln(\sin x)}{1/\sin x} = \lim_{x \rightarrow 0} \frac{\cos x / \sin x}{-\cos x / \sin^2 x} = \lim_{x \rightarrow 0} (-\sin x) = 0$$

The original limit is

$$\lim_{x \rightarrow 0} (\sin x)^{\sin x} = e^0 = 1.$$

# Chapter 4

## Integral Calculus

### 4.1 The Indefinite Integral

The opposite of a derivative is the *anti-derivative* or the *indefinite integral*. The indefinite integral of a function  $f(x)$  is denoted,

$$\int f(x) \, dx.$$

It is defined by the property that

$$\frac{d}{dx} \int f(x) \, dx = f(x).$$

While a function  $f(x)$  has a unique derivative if it is differentiable, it has an infinite number of indefinite integrals, each of which differ by an additive constant.

**Zero Slope Implies a Constant Function.** If the value of a function's derivative is identically zero,  $\frac{df}{dx} = 0$ , then the function is a constant,  $f(x) = c$ . To prove this, we assume that there exists a non-constant differentiable function whose derivative is zero and obtain a contradiction. Let  $f(x)$  be such a function. Since  $f(x)$  is non-constant, there exist points  $a$  and  $b$  such that  $f(a) \neq f(b)$ . By the Mean Value Theorem of differential calculus, there exists a

point  $\xi \in (a, b)$  such that

$$f'(\xi) = \frac{f(b) - f(a)}{b - a} \neq 0,$$

which contradicts that the derivative is everywhere zero.

**Indefinite Integrals Differ by an Additive Constant.** Suppose that  $F(x)$  and  $G(x)$  are indefinite integrals of  $f(x)$ . Then we have

$$\frac{d}{dx}(F(x) - G(x)) = F'(x) - G'(x) = f(x) - f(x) = 0.$$

Thus we see that  $F(x) - G(x) = c$  and the two indefinite integrals must differ by a constant. For example, we have  $\int \sin x \, dx = -\cos x + c$ . While every function that can be expressed in terms of elementary functions, (the exponent, logarithm, trigonometric functions, etc.), has a derivative that can be written explicitly in terms of elementary functions, the same is not true of integrals. For example,  $\int \sin(\sin x) \, dx$  cannot be written explicitly in terms of elementary functions.

**Properties.** Since the derivative is linear, so is the indefinite integral. That is,

$$\int (af(x) + bg(x)) \, dx = a \int f(x) \, dx + b \int g(x) \, dx.$$

For each derivative identity there is a corresponding integral identity. Consider the power law identity,  $\frac{d}{dx}(f(x))^a = a(f(x))^{a-1}f'(x)$ . The corresponding integral identity is

$$\int (f(x))^a f'(x) \, dx = \frac{(f(x))^{a+1}}{a+1} + c, \quad a \neq -1,$$

where we require that  $a \neq -1$  to avoid division by zero. From the derivative of a logarithm,  $\frac{d}{dx} \ln(f(x)) = \frac{f'(x)}{f(x)}$ , we obtain,

$$\int \frac{f'(x)}{f(x)} \, dx = \ln |f(x)| + c.$$

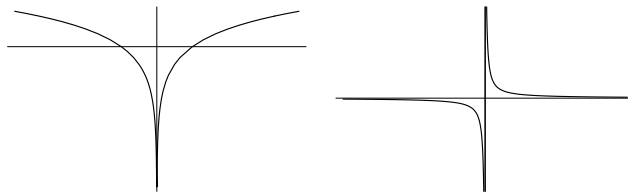

Figure 4.1: Plot of  $\ln|x|$  and  $1/x$ .

Note the absolute value signs. This is because  $\frac{d}{dx} \ln|x| = \frac{1}{x}$  for  $x \neq 0$ . In Figure 4.1 is a plot of  $\ln|x|$  and  $\frac{1}{x}$  to reinforce this.

**Example 4.1.1** Consider

$$I = \int \frac{x}{(x^2 + 1)^2} dx.$$

We evaluate the integral by choosing  $u = x^2 + 1$ ,  $du = 2x dx$ .

$$\begin{aligned} I &= \frac{1}{2} \int \frac{2x}{(x^2 + 1)^2} dx \\ &= \frac{1}{2} \int \frac{du}{u^2} \\ &= \frac{1}{2} \frac{-1}{u} \\ &= -\frac{1}{2(x^2 + 1)}. \end{aligned}$$

**Example 4.1.2** Consider

$$I = \int \tan x dx = \int \frac{\sin x}{\cos x} dx.$$

By choosing  $f(x) = \cos x$ ,  $f'(x) = -\sin x$ , we see that the integral is

$$I = - \int \frac{-\sin x}{\cos x} dx = -\ln |\cos x| + c.$$

**Change of Variable.** The differential of a function  $g(x)$  is  $dg = g'(x) dx$ . Thus one might suspect that for  $\xi = g(x)$ ,

$$\int f(\xi) d\xi = \int f(g(x))g'(x) dx, \quad (4.1)$$

since  $d\xi = dg = g'(x) dx$ . This turns out to be true. To prove it we will appeal to the chain rule for differentiation. Let  $\xi$  be a function of  $x$ . The chain rule is

$$\frac{d}{dx}f(\xi) = f'(\xi)\xi'(x),$$

$$\frac{d}{dx}f(\xi) = \frac{df}{d\xi} \frac{d\xi}{dx}.$$

We can also write this as

$$\frac{df}{d\xi} = \frac{dx}{d\xi} \frac{df}{dx},$$

or in operator notation,

$$\frac{d}{d\xi} = \frac{dx}{d\xi} \frac{d}{dx}.$$

Now we're ready to start. The derivative of the left side of Equation 4.1 is

$$\frac{d}{d\xi} \int f(\xi) d\xi = f(\xi).$$

Next we differentiate the right side,

$$\begin{aligned}\frac{d}{d\xi} \int f(g(x))g'(x) dx &= \frac{dx}{d\xi} \frac{d}{dx} \int f(g(x))g'(x) dx \\ &= \frac{dx}{d\xi} f(g(x))g'(x) \\ &= \frac{dx}{dg} f(g(x)) \frac{dg}{dx} \\ &= f(g(x)) \\ &= f(\xi)\end{aligned}$$

to see that it is in fact an identity for  $\xi = g(x)$ .

**Example 4.1.3** Consider

$$\int x \sin(x^2) dx.$$

We choose  $\xi = x^2$ ,  $d\xi = 2x dx$  to evaluate the integral.

$$\begin{aligned}\int x \sin(x^2) dx &= \frac{1}{2} \int \sin(x^2) 2x dx \\ &= \frac{1}{2} \int \sin \xi d\xi \\ &= \frac{1}{2} (-\cos \xi) + c \\ &= -\frac{1}{2} \cos(x^2) + c\end{aligned}$$



**Integration by Parts.** The product rule for differentiation gives us an identity called integration by parts. We start with the product rule and then integrate both sides of the equation.

$$\begin{aligned}\frac{d}{dx}(u(x)v(x)) &= u'(x)v(x) + u(x)v'(x) \\ \int (u'(x)v(x) + u(x)v'(x)) dx &= u(x)v(x) + c \\ \int u'(x)v(x) dx + \int u(x)v'(x) dx &= u(x)v(x) \\ \int u(x)v'(x) dx &= u(x)v(x) - \int v(x)u'(x) dx\end{aligned}$$

The theorem is most often written in the form

$$\int u dv = uv - \int v du.$$

So what is the usefulness of this? Well, it may happen for some integrals and a good choice of  $u$  and  $v$  that the integral on the right is easier to evaluate than the integral on the left.

**Example 4.1.4** Consider  $\int x e^x dx$ . If we choose  $u = x$ ,  $dv = e^x dx$  then integration by parts yields

$$\int x e^x dx = x e^x - \int e^x dx = (x - 1) e^x.$$

Now notice what happens when we choose  $u = e^x$ ,  $dv = x dx$ .

$$\int x e^x dx = \frac{1}{2} x^2 e^x - \int \frac{1}{2} x^2 e^x dx$$

The integral gets harder instead of easier.

When applying integration by parts, one must choose  $u$  and  $dv$  wisely. As general rules of thumb:

- Pick  $u$  so that  $u'$  is simpler than  $u$ .
- Pick  $dv$  so that  $v$  is not more complicated, (hopefully simpler), than  $dv$ .

Also note that you may have to apply integration by parts several times to evaluate some integrals.

## 4.2 The Definite Integral

### 4.2.1 Definition

The area bounded by the  $x$  axis, the vertical lines  $x = a$  and  $x = b$  and the function  $f(x)$  is denoted with a *definite integral*,

$$\int_a^b f(x) dx.$$

The area is signed, that is, if  $f(x)$  is negative, then the area is negative. We measure the area with a divide-and-conquer strategy. First partition the interval  $(a, b)$  with  $a = x_0 < x_1 < \cdots < x_{n-1} < x_n = b$ . Note that the area under the curve on the subinterval is approximately the area of a rectangle of base  $\Delta x_i = x_{i+1} - x_i$  and height  $f(\xi_i)$ , where  $\xi_i \in [x_i, x_{i+1}]$ . If we add up the areas of the rectangles, we get an approximation of the area under the curve. See Figure 4.2

$$\int_a^b f(x) dx \approx \sum_{i=0}^{n-1} f(\xi_i) \Delta x_i$$

As the  $\Delta x_i$ 's get smaller, we expect the approximation of the area to get better. Let  $\Delta x = \max_{0 \leq i \leq n-1} \Delta x_i$ . We define the definite integral as the sum of the areas of the rectangles in the limit that  $\Delta x \rightarrow 0$ .

$$\int_a^b f(x) dx = \lim_{\Delta x \rightarrow 0} \sum_{i=0}^{n-1} f(\xi_i) \Delta x_i$$

The integral is defined when the limit exists. This is known as the *Riemann integral* of  $f(x)$ .  $f(x)$  is called the *integrand*.

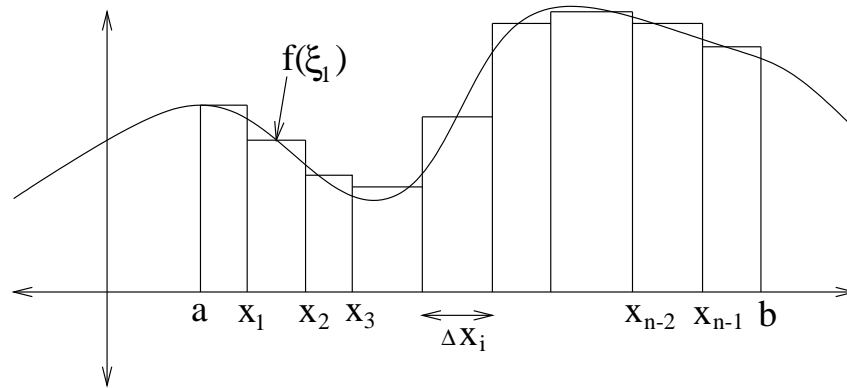

Figure 4.2: Divide-and-Conquer Strategy for Approximating a Definite Integral.

## 4.2.2 Properties

**Linearity and the Basics.** Because summation is a linear operator, that is

$$\sum_{i=0}^{n-1} (cf_i + dg_i) = c \sum_{i=0}^{n-1} f_i + d \sum_{i=0}^{n-1} g_i,$$

definite integrals are linear,

$$\int_a^b (cf(x) + dg(x)) dx = c \int_a^b f(x) dx + d \int_a^b g(x) dx.$$

One can also divide the *range of integration*.

$$\int_a^b f(x) dx = \int_a^c f(x) dx + \int_c^b f(x) dx$$

We assume that each of the above integrals exist. If  $a \leq b$ , and we integrate from  $b$  to  $a$ , then each of the  $\Delta x_i$  will be negative. From this observation, it is clear that

$$\int_a^b f(x) \, dx = - \int_b^a f(x) \, dx.$$

If we integrate any function from a point  $a$  to that same point  $a$ , then all the  $\Delta x_i$  are zero and

$$\int_a^a f(x) \, dx = 0.$$

**Bounding the Integral.** Recall that if  $f_i \leq g_i$ , then

$$\sum_{i=0}^{n-1} f_i \leq \sum_{i=0}^{n-1} g_i.$$

Let  $m = \min_{x \in [a,b]} f(x)$  and  $M = \max_{x \in [a,b]} f(x)$ . Then

$$(b-a)m = \sum_{i=0}^{n-1} m \Delta x_i \leq \sum_{i=0}^{n-1} f(\xi_i) \Delta x_i \leq \sum_{i=0}^{n-1} M \Delta x_i = (b-a)M$$

implies that

$$(b-a)m \leq \int_a^b f(x) \, dx \leq (b-a)M.$$

Since

$$\left| \sum_{i=0}^{n-1} f_i \right| \leq \sum_{i=0}^{n-1} |f_i|,$$

we have

$$\left| \int_a^b f(x) \, dx \right| \leq \int_a^b |f(x)| \, dx.$$

**Mean Value Theorem of Integral Calculus.** Let  $f(x)$  be continuous. We know from above that

$$(b - a)m \leq \int_a^b f(x) \, dx \leq (b - a)M.$$

Therefore there exists a constant  $c \in [m, M]$  satisfying

$$\int_a^b f(x) \, dx = (b - a)c.$$

Since  $f(x)$  is continuous, there is a point  $\xi \in [a, b]$  such that  $f(\xi) = c$ . Thus we see that

$$\int_a^b f(x) \, dx = (b - a)f(\xi),$$

for some  $\xi \in [a, b]$ .

## 4.3 The Fundamental Theorem of Integral Calculus

**Definite Integrals with Variable Limits of Integration.** Consider  $a$  to be a constant and  $x$  variable, then the function  $F(x)$  defined by

$$F(x) = \int_a^x f(t) \, dt \tag{4.2}$$

is an anti-derivative of  $f(x)$ , that is  $F'(x) = f(x)$ . To show this we apply the definition of differentiation and the integral mean value theorem.

$$\begin{aligned}
 F'(x) &= \lim_{\Delta x \rightarrow 0} \frac{F(x + \Delta x) - F(x)}{\Delta x} \\
 &= \lim_{\Delta x \rightarrow 0} \frac{\int_a^{x+\Delta x} f(t) dt - \int_a^x f(t) dt}{\Delta x} \\
 &= \lim_{\Delta x \rightarrow 0} \frac{\int_x^{x+\Delta x} f(t) dt}{\Delta x} \\
 &= \lim_{\Delta x \rightarrow 0} \frac{f(\xi)\Delta x}{\Delta x}, \quad \xi \in [x, x + \Delta x] \\
 &= f(x)
 \end{aligned}$$

**The Fundamental Theorem of Integral Calculus.** Let  $F(x)$  be any anti-derivative of  $f(x)$ . Noting that all anti-derivatives of  $f(x)$  differ by a constant and replacing  $x$  by  $b$  in Equation 4.2, we see that there exists a constant  $c$  such that

$$\int_a^b f(x) dx = F(b) + c.$$

Now to find the constant. By plugging in  $b = a$ ,

$$\int_a^a f(x) dx = F(a) + c = 0,$$

we see that  $c = -F(a)$ . This gives us a result known as the *Fundamental Theorem of Integral Calculus*.

$$\int_a^b f(x) dx = F(b) - F(a).$$

We introduce the notation

$$[F(x)]_a^b \equiv F(b) - F(a).$$

### Example 4.3.1

$$\int_0^{\pi} \sin x \, dx = [-\cos x]_0^{\pi} = -\cos(\pi) + \cos(0) = 2$$

## 4.4 Techniques of Integration

### 4.4.1 Partial Fractions

A proper rational function

$$\frac{p(x)}{q(x)} = \frac{p(x)}{(x-a)^n r(x)}$$

Can be written in the form

$$\frac{p(x)}{(x-\alpha)^n r(x)} = \left( \frac{a_0}{(x-\alpha)^n} + \frac{a_1}{(x-\alpha)^{n-1}} + \cdots + \frac{a_{n-1}}{x-\alpha} \right) + (\cdots)$$

where the  $a_k$ 's are constants and the last ellipses represents the partial fractions expansion of the roots of  $r(x)$ . The coefficients are

$$a_k = \frac{1}{k!} \frac{d^k}{dx^k} \left( \frac{p(x)}{r(x)} \right) \Big|_{x=\alpha}.$$

**Example 4.4.1** Consider the partial fraction expansion of

$$\frac{1+x+x^2}{(x-1)^3}.$$

The expansion has the form

$$\frac{a_0}{(x-1)^3} + \frac{a_1}{(x-1)^2} + \frac{a_2}{x-1}.$$

The coefficients are

$$\begin{aligned}a_0 &= \frac{1}{0!}(1+x+x^2)|_{x=1} = 3, \\a_1 &= \frac{1}{1!} \frac{d}{dx}(1+x+x^2)|_{x=1} = (1+2x)|_{x=1} = 3, \\a_2 &= \frac{1}{2!} \frac{d^2}{dx^2}(1+x+x^2)|_{x=1} = \frac{1}{2}(2)|_{x=1} = 1.\end{aligned}$$

Thus we have

$$\frac{1+x+x^2}{(x-1)^3} = \frac{3}{(x-1)^3} + \frac{3}{(x-1)^2} + \frac{1}{x-1}.$$

**Example 4.4.2** Suppose we want to evaluate

$$\int \frac{1+x+x^2}{(x-1)^3} dx.$$

If we expand the integrand in a partial fraction expansion, then the integral becomes easy.

$$\begin{aligned}\int \frac{1+x+x^2}{(x-1)^3} dx &= \int \left( \frac{3}{(x-1)^3} + \frac{3}{(x-1)^2} + \frac{1}{x-1} \right) dx \\&= -\frac{3}{2(x-1)^2} - \frac{3}{x-1} + \ln(x-1)\end{aligned}$$

**Example 4.4.3** Consider the partial fraction expansion of

$$\frac{1+x+x^2}{x^2(x-1)^2}.$$

The expansion has the form

$$\frac{a_0}{x^2} + \frac{a_1}{x} + \frac{b_0}{(x-1)^2} + \frac{b_1}{x-1}.$$



The coefficients are

$$\begin{aligned}
 a_0 &= \frac{1}{0!} \left( \frac{1+x+x^2}{(x-1)^2} \right) \Big|_{x=0} = 1, \\
 a_1 &= \frac{1}{1!} \frac{d}{dx} \left( \frac{1+x+x^2}{(x-1)^2} \right) \Big|_{x=0} = \left( \frac{1+2x}{(x-1)^2} - \frac{2(1+x+x^2)}{(x-1)^3} \right) \Big|_{x=0} = 3, \\
 b_0 &= \frac{1}{0!} \left( \frac{1+x+x^2}{x^2} \right) \Big|_{x=1} = 3, \\
 b_1 &= \frac{1}{1!} \frac{d}{dx} \left( \frac{1+x+x^2}{x^2} \right) \Big|_{x=1} = \left( \frac{1+2x}{x^2} - \frac{2(1+x+x^2)}{x^3} \right) \Big|_{x=1} = -3,
 \end{aligned}$$

Thus we have

$$\frac{1+x+x^2}{x^2(x-1)^2} = \frac{1}{x^2} + \frac{3}{x} + \frac{3}{(x-1)^2} - \frac{3}{x-1}.$$

If the rational function has real coefficients and the denominator has complex roots, then you can reduce the work in finding the partial fraction expansion with the following trick: Let  $\alpha$  and  $\bar{\alpha}$  be complex conjugate pairs of roots of the denominator.

$$\begin{aligned}
 \frac{p(x)}{(x-\alpha)^n(x-\bar{\alpha})^nr(x)} &= \left( \frac{a_0}{(x-\alpha)^n} + \frac{a_1}{(x-\alpha)^{n-1}} + \cdots + \frac{a_{n-1}}{x-\alpha} \right) \\
 &\quad + \left( \frac{\bar{a}_0}{(x-\bar{\alpha})^n} + \frac{\bar{a}_1}{(x-\bar{\alpha})^{n-1}} + \cdots + \frac{\bar{a}_{n-1}}{x-\bar{\alpha}} \right) + (\cdots)
 \end{aligned}$$

Thus we don't have to calculate the coefficients for the root at  $\bar{\alpha}$ . We just take the complex conjugate of the coefficients for  $\alpha$ .

**Example 4.4.4** Consider the partial fraction expansion of

$$\frac{1+x}{x^2+1}.$$

The expansion has the form

$$\frac{a_0}{x-i} + \frac{\overline{a_0}}{x+i}$$

The coefficients are

$$a_0 = \frac{1}{0!} \left( \frac{1+x}{x+i} \right) \Big|_{x=i} = \frac{1}{2}(1-i),$$
$$\overline{a_0} = \frac{1}{2}(1-i) = \frac{1}{2}(1+i)$$

Thus we have

$$\frac{1+x}{x^2+1} = \frac{1-i}{2(x-i)} + \frac{1+i}{2(x+i)}.$$

## 4.5 Improper Integrals

If the range of integration is infinite or  $f(x)$  is discontinuous at some points then  $\int_a^b f(x) dx$  is called an *improper integral*.

**Discontinuous Functions.** If  $f(x)$  is continuous on the interval  $a \leq x \leq b$  except at the point  $x = c$  where  $a < c < b$  then

$$\int_a^b f(x) dx = \lim_{\delta \rightarrow 0^+} \int_a^{c-\delta} f(x) dx + \lim_{\epsilon \rightarrow 0^+} \int_{c+\epsilon}^b f(x) dx$$

provided that both limits exist.

**Example 4.5.1** Consider the integral of  $\ln x$  on the interval  $[0, 1]$ . Since the logarithm has a singularity at  $x = 0$ , this

is an improper integral. We write the integral in terms of a limit and evaluate the limit with L'Hospital's rule.

$$\begin{aligned}
 \int_0^1 \ln x \, dx &= \lim_{\delta \rightarrow 0} \int_{\delta}^1 \ln x \, dx \\
 &= \lim_{\delta \rightarrow 0} [x \ln x - x]_{\delta}^1 \\
 &= 1 \ln(1) - 1 - \lim_{\delta \rightarrow 0} (\delta \ln \delta - \delta) \\
 &= -1 - \lim_{\delta \rightarrow 0} (\delta \ln \delta) \\
 &= -1 - \lim_{\delta \rightarrow 0} \left( \frac{\ln \delta}{1/\delta} \right) \\
 &= -1 - \lim_{\delta \rightarrow 0} \left( \frac{1/\delta}{-1/\delta^2} \right) \\
 &= -1
 \end{aligned}$$

**Example 4.5.2** Consider the integral of  $x^a$  on the range  $[0, 1]$ . If  $a < 0$  then there is a singularity at  $x = 0$ . First assume that  $a \neq -1$ .

$$\begin{aligned}
 \int_0^1 x^a \, dx &= \lim_{\delta \rightarrow 0^+} \left[ \frac{x^{a+1}}{a+1} \right]_{\delta}^1 \\
 &= \frac{1}{a+1} - \lim_{\delta \rightarrow 0^+} \frac{\delta^{a+1}}{a+1}
 \end{aligned}$$

This limit exists only for  $a > -1$ . Now consider the case that  $a = -1$ .

$$\begin{aligned}
 \int_0^1 x^{-1} \, dx &= \lim_{\delta \rightarrow 0^+} [\ln x]_{\delta}^1 \\
 &= \ln(0) - \lim_{\delta \rightarrow 0^+} \ln \delta
 \end{aligned}$$

This limit does not exist. We obtain the result,

$$\int_0^1 x^a \, dx = \frac{1}{a+1}, \quad \text{for } a > -1.$$

**Infinite Limits of Integration.** If the range of integration is infinite, say  $[a, \infty)$  then we define the integral as

$$\int_a^\infty f(x) dx = \lim_{\alpha \rightarrow \infty} \int_a^\alpha f(x) dx,$$

provided that the limit exists. If the range of integration is  $(-\infty, \infty)$  then

$$\int_{-\infty}^\infty f(x) dx = \lim_{\alpha \rightarrow -\infty} \int_\alpha^a f(x) dx + \lim_{\beta \rightarrow +\infty} \int_a^\beta f(x) dx.$$

### Example 4.5.3

$$\begin{aligned} \int_1^\infty \frac{\ln x}{x^2} dx &= \int_1^\infty \ln x \left( \frac{d}{dx} \frac{-1}{x} \right) dx \\ &= \left[ \ln x \frac{-1}{x} \right]_1^\infty - \int_1^\infty \frac{-1}{x} \frac{1}{x} dx \\ &= \lim_{x \rightarrow +\infty} \left( -\frac{\ln x}{x} \right) - \left[ \frac{1}{x} \right]_1^\infty \\ &= \lim_{x \rightarrow +\infty} \left( -\frac{1/x}{1} \right) - \lim_{x \rightarrow \infty} \frac{1}{x} + 1 \\ &= 1 \end{aligned}$$

**Example 4.5.4** Consider the integral of  $x^a$  on  $[1, \infty)$ . First assume that  $a \neq -1$ .

$$\begin{aligned} \int_1^\infty x^a dx &= \lim_{\beta \rightarrow +\infty} \left[ \frac{x^{a+1}}{a+1} \right]_1^\beta \\ &= \lim_{\beta \rightarrow +\infty} \frac{\beta^{a+1}}{a+1} - \frac{1}{a+1} \end{aligned}$$

The limit exists for  $\beta < -1$ . Now consider the case  $a = -1$ .

$$\begin{aligned}\int_1^{\infty} x^{-1} dx &= \lim_{\beta \rightarrow +\infty} [\ln x]_1^{\beta} \\ &= \lim_{\beta \rightarrow +\infty} \ln \beta - \frac{1}{a+1}\end{aligned}$$

This limit does not exist. Thus we have

$$\int_1^{\infty} x^a dx = -\frac{1}{a+1}, \quad \text{for } a < -1.$$

## 4.6 Exercises

### 4.6.1 The Indefinite Integral

**Exercise 4.1** ([mathematica/calculus/integral/fundamental.nb](#))

Evaluate  $\int (2x + 3)^{10} dx$ .

[Hint](#), [Solution](#)

**Exercise 4.2** ([mathematica/calculus/integral/fundamental.nb](#))

Evaluate  $\int \frac{(\ln x)^2}{x} dx$ .

[Hint](#), [Solution](#)

**Exercise 4.3** ([mathematica/calculus/integral/fundamental.nb](#))

Evaluate  $\int x\sqrt{x^2 + 3} dx$ .

[Hint](#), [Solution](#)

**Exercise 4.4** ([mathematica/calculus/integral/fundamental.nb](#))

Evaluate  $\int \frac{\cos x}{\sin x} dx$ .

[Hint](#), [Solution](#)

**Exercise 4.5** ([mathematica/calculus/integral/fundamental.nb](#))

Evaluate  $\int \frac{x^2}{x^3 - 5} dx$ .

[Hint](#), [Solution](#)

### 4.6.2 The Definite Integral

**Exercise 4.6** ([mathematica/calculus/integral/definite.nb](#))

Use the result

$$\int_a^b f(x) dx = \lim_{N \rightarrow \infty} \sum_{n=0}^{N-1} f(x_n) \Delta x$$

where  $\Delta x = \frac{b-a}{N}$  and  $x_n = a + n\Delta x$ , to show that

$$\int_0^1 x \, dx = \frac{1}{2}.$$

**Hint, Solution**

**Exercise 4.7 (mathematica/calculus/integral/definite.nb)**

Evaluate the following integral using integration by parts and the Pythagorean identity.  $\int_0^\pi \sin^2 x \, dx$

**Hint, Solution**

**Exercise 4.8 (mathematica/calculus/integral/definite.nb)**

Prove that

$$\frac{d}{dx} \int_{g(x)}^{f(x)} h(\xi) \, d\xi = h(f(x))f'(x) - h(g(x))g'(x).$$

(Don't use the limit definition of differentiation, use the Fundamental Theorem of Integral Calculus.)

**Hint, Solution**

**Exercise 4.9 (mathematica/calculus/integral/definite.nb)**

Let  $A_n$  be the area between the curves  $x$  and  $x_n$  on the interval  $[0 \dots 1]$ . What is  $\lim_{n \rightarrow \infty} A_n$ ? Explain this result geometrically.

**Hint, Solution**

**Exercise 4.10 (mathematica/calculus/integral/taylor.nb)**

a. Show that

$$f(x) = f(0) + \int_0^x f'(x - \xi) \, d\xi.$$

b. From the above identity show that

$$f(x) = f(0) + xf'(0) + \int_0^x \xi f''(x - \xi) \, d\xi.$$

c. Using induction, show that

$$f(x) = f(0) + xf'(0) + \frac{1}{2}x^2 f''(0) + \cdots + \frac{1}{n!}x^n f^{(n)}(0) + \int_0^x \frac{1}{n!}\xi^n f^{(n+1)}(x - \xi) d\xi.$$

Hint, Solution

### Exercise 4.11

Find a function  $f(x)$  whose arc length from 0 to  $x$  is  $2x$ .

Hint, Solution

### Exercise 4.12

Consider a curve  $C$ , bounded by  $-1$  and  $1$ , on the interval  $(-1 \dots 1)$ . Can the length of  $C$  be unbounded? What if we change to the closed interval  $[-1 \dots 1]$ ?

Hint, Solution

## 4.6.3 The Fundamental Theorem of Integration

### 4.6.4 Techniques of Integration

#### Exercise 4.13 (mathematica/calculus/integral/parts.nb)

Evaluate  $\int x \sin x dx$ .

Hint, Solution

#### Exercise 4.14 (mathematica/calculus/integral/parts.nb)

Evaluate  $\int x^3 e^{2x} dx$ .

Hint, Solution

#### Exercise 4.15 (mathematica/calculus/integral/partial.nb)

Evaluate  $\int \frac{1}{x^2-4} dx$ .

Hint, Solution



**Exercise 4.16 (mathematica/calculus/integral/partial.nb)**

Evaluate  $\int \frac{x+1}{x^3+x^2-6x} dx$ .

[Hint](#), [Solution](#)

## 4.6.5 Improper Integrals

**Exercise 4.17 (mathematica/calculus/integral/improper.nb)**

Evaluate  $\int_0^4 \frac{1}{(x-1)^2} dx$ .

[Hint](#), [Solution](#)

**Exercise 4.18 (mathematica/calculus/integral/improper.nb)**

Evaluate  $\int_0^1 \frac{1}{\sqrt{x}} dx$ .

[Hint](#), [Solution](#)

**Exercise 4.19 (mathematica/calculus/integral/improper.nb)**

Evaluate  $\int_0^\infty \frac{1}{x^2+4} dx$ .

[Hint](#), [Solution](#)

## 4.7 Hints

### Hint 4.1

Make the change of variables  $u = 2x + 3$ .

### Hint 4.2

Make the change of variables  $u = \ln x$ .

### Hint 4.3

Make the change of variables  $u = x^2 + 3$ .

### Hint 4.4

Make the change of variables  $u = \sin x$ .

### Hint 4.5

Make the change of variables  $u = x^3 - 5$ .

### Hint 4.6

$$\begin{aligned}\int_0^1 x \, dx &= \lim_{N \rightarrow \infty} \sum_{n=0}^{N-1} x_n \Delta x \\ &= \lim_{N \rightarrow \infty} \sum_{n=0}^{N-1} (n\Delta x) \Delta x\end{aligned}$$

### Hint 4.7

Let  $u = \sin x$  and  $dv = \sin x \, dx$ . Integration by parts will give you an equation for  $\int_0^\pi \sin^2 x \, dx$ .

### Hint 4.8

Let  $H'(x) = h(x)$  and evaluate the integral in terms of  $H(x)$ .

**Hint 4.9**

CONTINUE

**Hint 4.10**

- Evaluate the integral.
- Use integration by parts to evaluate the integral.
- Use integration by parts with  $u = f^{(n+1)}(x - \xi)$  and  $dv = \frac{1}{n!}\xi^n$ .

**Hint 4.11**The arc length from 0 to  $x$  is

$$\int_0^x \sqrt{1 + (f'(\xi))^2} d\xi \quad (4.3)$$

First show that the arc length of  $f(x)$  from  $a$  to  $b$  is  $2(b - a)$ . Then conclude that the integrand in Equation 4.3 must everywhere be 2.

**Hint 4.12**

CONTINUE

**Hint 4.13**Let  $u = x$ , and  $dv = \sin x dx$ .**Hint 4.14**Perform integration by parts three successive times. For the first one let  $u = x^3$  and  $dv = e^{2x} dx$ .**Hint 4.15**

Expanding the integrand in partial fractions,

$$\frac{1}{x^2 - 4} = \frac{1}{(x - 2)(x + 2)} = \frac{a}{(x - 2)} + \frac{b}{(x + 2)}$$

$$1 = a(x + 2) + b(x - 2)$$

Set  $x = 2$  and  $x = -2$  to solve for  $a$  and  $b$ .

**Hint 4.16**

Expanding the integral in partial fractions,

$$\frac{x+1}{x^3+x^2-6x} = \frac{x+1}{x(x-2)(x+3)} = \frac{a}{x} + \frac{b}{x-2} + \frac{c}{x+3}$$

$$x+1 = a(x-2)(x+3) + bx(x+3) + cx(x-2)$$

Set  $x = 0$ ,  $x = 2$  and  $x = -3$  to solve for  $a$ ,  $b$  and  $c$ .

**Hint 4.17**

$$\int_0^4 \frac{1}{(x-1)^2} dx = \lim_{\delta \rightarrow 0^+} \int_0^{1-\delta} \frac{1}{(x-1)^2} dx + \lim_{\epsilon \rightarrow 0^+} \int_{1+\epsilon}^4 \frac{1}{(x-1)^2} dx$$

**Hint 4.18**

$$\int_0^1 \frac{1}{\sqrt{x}} dx = \lim_{\epsilon \rightarrow 0^+} \int_{\epsilon}^1 \frac{1}{\sqrt{x}} dx$$

**Hint 4.19**

$$\int \frac{1}{x^2+a^2} dx = \frac{1}{a} \arctan\left(\frac{x}{a}\right)$$

## 4.8 Solutions

### Solution 4.1

$$\int (2x + 3)^{10} dx$$

Let  $u = 2x + 3$ ,  $g(u) = x = \frac{u-3}{2}$ ,  $g'(u) = \frac{1}{2}$ .

$$\begin{aligned}\int (2x + 3)^{10} dx &= \int u^{10} \frac{1}{2} du \\ &= \frac{u^{11}}{11} \frac{1}{2} \\ &= \frac{(2x + 3)^{11}}{22}\end{aligned}$$

### Solution 4.2

$$\begin{aligned}\int \frac{(\ln x)^2}{x} dx &= \int (\ln x)^2 \frac{d(\ln x)}{dx} dx \\ &= \frac{(\ln x)^3}{3}\end{aligned}$$

### Solution 4.3

$$\begin{aligned}\int x\sqrt{x^2 + 3} dx &= \int \sqrt{x^2 + 3} \frac{1}{2} \frac{d(x^2)}{dx} dx \\ &= \frac{1}{2} \frac{(x^2 + 3)^{3/2}}{3/2} \\ &= \frac{(x^2 + 3)^{3/2}}{3}\end{aligned}$$

**Solution 4.4**

$$\begin{aligned}\int \frac{\cos x}{\sin x} dx &= \int \frac{1}{\sin x} \frac{d(\sin x)}{dx} dx \\ &= \ln |\sin x|\end{aligned}$$

**Solution 4.5**

$$\begin{aligned}\int \frac{x^2}{x^3 - 5} dx &= \int \frac{1}{x^3 - 5} \frac{1}{3} \frac{d(x^3)}{dx} dx \\ &= \frac{1}{3} \ln |x^3 - 5|\end{aligned}$$

**Solution 4.6**

$$\begin{aligned}\int_0^1 x dx &= \lim_{N \rightarrow \infty} \sum_{n=0}^{N-1} x_n \Delta x \\ &= \lim_{N \rightarrow \infty} \sum_{n=0}^{N-1} (n\Delta x) \Delta x \\ &= \lim_{N \rightarrow \infty} \Delta x^2 \sum_{n=0}^{N-1} n \\ &= \lim_{N \rightarrow \infty} \Delta x^2 \frac{N(N-1)}{2} \\ &= \lim_{N \rightarrow \infty} \frac{N(N-1)}{2N^2} \\ &= \frac{1}{2}\end{aligned}$$

**Solution 4.7**

Let  $u = \sin x$  and  $dv = \sin x \, dx$ . Then  $du = \cos x \, dx$  and  $v = -\cos x$ .

$$\begin{aligned}\int_0^\pi \sin^2 x \, dx &= [-\sin x \cos x]_0^\pi + \int_0^\pi \cos^2 x \, dx \\ &= \int_0^\pi \cos^2 x \, dx \\ &= \int_0^\pi (1 - \sin^2 x) \, dx \\ &= \pi - \int_0^\pi \sin^2 x \, dx \\ 2 \int_0^\pi \sin^2 x \, dx &= \pi \\ \int_0^\pi \sin^2 x \, dx &= \frac{\pi}{2}\end{aligned}$$

**Solution 4.8**

Let  $H'(x) = h(x)$ .

$$\begin{aligned}\frac{d}{dx} \int_{g(x)}^{f(x)} h(\xi) \, d\xi &= \frac{d}{dx} (H(f(x)) - H(g(x))) \\ &= H'(f(x))f'(x) - H'(g(x))g'(x) \\ &= h(f(x))f'(x) - h(g(x))g'(x)\end{aligned}$$

**Solution 4.9**

First we compute the area for positive integer  $n$ .

$$A_n = \int_0^1 (x - x^n) \, dx = \left[ \frac{x^2}{2} - \frac{x^{n+1}}{n+1} \right]_0^1 = \frac{1}{2} - \frac{1}{n+1}$$

Then we consider the area in the limit as  $n \rightarrow \infty$ .

$$\lim_{n \rightarrow \infty} A_n = \lim_{n \rightarrow \infty} \left( \frac{1}{2} - \frac{1}{n+1} \right) = \frac{1}{2}$$

In Figure 4.3 we plot the functions  $x^1, x^2, x^4, x^8, \dots, x^{1024}$ . In the limit as  $n \rightarrow \infty$ ,  $x^n$  on the interval  $[0 \dots 1]$  tends to the function

$$\begin{cases} 0 & 0 \leq x < 1 \\ 1 & x = 1 \end{cases}$$

Thus the area tends to the area of the right triangle with unit base and height.

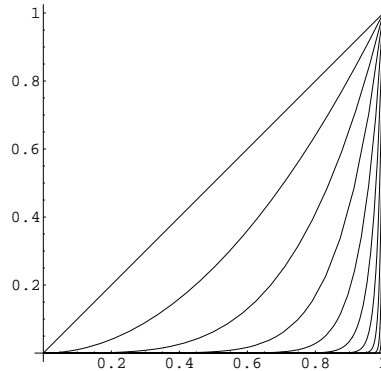

Figure 4.3: Plots of  $x^1, x^2, x^4, x^8, \dots, x^{1024}$ .



**Solution 4.10**

1.

$$\begin{aligned}
 f(0) + \int_0^x f'(x - \xi) \, d\xi &= f(0) + [-f(x - \xi)]_0^x \\
 &= f(0) - f(0) + f(x) \\
 &= f(x)
 \end{aligned}$$

2.

$$\begin{aligned}
 f(0) + x f'(0) + \int_0^x \xi f''(x - \xi) \, d\xi &= f(0) + x f'(0) + [-\xi f'(x - \xi)]_0^x - \int_0^x -f'(x - \xi) \, d\xi \\
 &= f(0) + x f'(0) - x f'(0) - [f(x - \xi)]_0^x \\
 &= f(0) - f(0) + f(x) \\
 &= f(x)
 \end{aligned}$$

3. Above we showed that the hypothesis holds for  $n = 0$  and  $n = 1$ . Assume that it holds for some  $n = m \geq 0$ .

$$\begin{aligned}
 f(x) &= f(0) + x f'(0) + \frac{1}{2} x^2 f''(0) + \cdots + \frac{1}{n!} x^n f^{(n)}(0) + \int_0^x \frac{1}{n!} \xi^n f^{(n+1)}(x - \xi) \, d\xi \\
 &= f(0) + x f'(0) + \frac{1}{2} x^2 f''(0) + \cdots + \frac{1}{n!} x^n f^{(n)}(0) + \left[ \frac{1}{(n+1)!} \xi^{n+1} f^{(n+1)}(x - \xi) \right]_0^x \\
 &\quad - \int_0^x -\frac{1}{(n+1)!} \xi^{n+1} f^{(n+2)}(x - \xi) \, d\xi \\
 &= f(0) + x f'(0) + \frac{1}{2} x^2 f''(0) + \cdots + \frac{1}{n!} x^n f^{(n)}(0) + \frac{1}{(n+1)!} x^{n+1} f^{(n+1)}(0) \\
 &\quad + \int_0^x \frac{1}{(n+1)!} \xi^{n+1} f^{(n+2)}(x - \xi) \, d\xi
 \end{aligned}$$

This shows that the hypothesis holds for  $n = m + 1$ . By induction, the hypothesis hold for all  $n \geq 0$ .

**Solution 4.11**

First note that the arc length from  $a$  to  $b$  is  $2(b - a)$ .

$$\int_a^b \sqrt{1 + (f'(x))^2} dx = \int_0^b \sqrt{1 + (f'(x))^2} dx - \int_0^a \sqrt{1 + (f'(x))^2} dx = 2b - 2a$$

Since  $a$  and  $b$  are arbitrary, we conclude that the integrand must everywhere be 2.

$$\begin{aligned}\sqrt{1 + (f'(x))^2} &= 2 \\ f'(x) &= \pm\sqrt{3}\end{aligned}$$

$f(x)$  is a continuous, piecewise differentiable function which satisfies  $f'(x) = \pm\sqrt{3}$  at the points where it is differentiable. One example is

$$f(x) = \sqrt{3}x$$

**Solution 4.12**

CONTINUE

**Solution 4.13**

Let  $u = x$ , and  $dv = \sin x dx$ . Then  $du = dx$  and  $v = -\cos x$ .

$$\begin{aligned}\int x \sin x dx &= -x \cos x + \int \cos x dx \\ &= -x \cos x + \sin x + C\end{aligned}$$

**Solution 4.14**

Let  $u = x^3$  and  $dv = e^{2x} dx$ . Then  $du = 3x^2 dx$  and  $v = \frac{1}{2} e^{2x}$ .

$$\int x^3 e^{2x} dx = \frac{1}{2} x^3 e^{2x} - \frac{3}{2} \int x^2 e^{2x} dx$$

Let  $u = x^2$  and  $dv = e^{2x} dx$ . Then  $du = 2x dx$  and  $v = \frac{1}{2} e^{2x}$ .

$$\int x^3 e^{2x} dx = \frac{1}{2} x^3 e^{2x} - \frac{3}{2} \left( \frac{1}{2} x^2 e^{2x} - \int x e^{2x} dx \right)$$

$$\int x^3 e^{2x} dx = \frac{1}{2} x^3 e^{2x} - \frac{3}{4} x^2 e^{2x} + \frac{3}{2} \int x e^{2x} dx$$

Let  $u = x$  and  $dv = e^{2x} dx$ . Then  $du = dx$  and  $v = \frac{1}{2} e^{2x}$ .

$$\int x^3 e^{2x} dx = \frac{1}{2} x^3 e^{2x} - \frac{3}{4} x^2 e^{2x} + \frac{3}{2} \left( \frac{1}{2} x e^{2x} - \frac{1}{2} \int e^{2x} dx \right)$$

$$\int x^3 e^{2x} dx = \frac{1}{2} x^3 e^{2x} - \frac{3}{4} x^2 e^{2x} + \frac{3}{4} x e^{2x} - \frac{3}{8} e^{2x} + C$$

### Solution 4.15

Expanding the integrand in partial fractions,

$$\frac{1}{x^2 - 4} = \frac{1}{(x - 2)(x + 2)} = \frac{A}{(x - 2)} + \frac{B}{(x + 2)}$$

$$1 = A(x + 2) + B(x - 2)$$

Setting  $x = 2$  yields  $A = \frac{1}{4}$ . Setting  $x = -2$  yields  $B = -\frac{1}{4}$ . Now we can do the integral.

$$\begin{aligned} \int \frac{1}{x^2 - 4} dx &= \int \left( \frac{1}{4(x - 2)} - \frac{1}{4(x + 2)} \right) dx \\ &= \frac{1}{4} \ln |x - 2| - \frac{1}{4} \ln |x + 2| + C \\ &= \frac{1}{4} \left| \frac{x - 2}{x + 2} \right| + C \end{aligned}$$

**Solution 4.16**

Expanding the integral in partial fractions,

$$\frac{x+1}{x^3+x^2-6x} = \frac{x+1}{x(x-2)(x+3)} = \frac{A}{x} + \frac{B}{x-2} + \frac{C}{x+3}$$

$$x+1 = A(x-2)(x+3) + Bx(x+3) + Cx(x-2)$$

Setting  $x = 0$  yields  $A = -\frac{1}{6}$ . Setting  $x = 2$  yields  $B = \frac{3}{10}$ . Setting  $x = -3$  yields  $C = -\frac{2}{15}$ .

$$\begin{aligned} \int \frac{x+1}{x^3+x^2-6x} dx &= \int \left( -\frac{1}{6x} + \frac{3}{10(x-2)} - \frac{2}{15(x+3)} \right) dx \\ &= -\frac{1}{6} \ln|x| + \frac{3}{10} \ln|x-2| - \frac{2}{15} \ln|x+3| + C \\ &= \ln \frac{|x-2|^{3/10}}{|x|^{1/6}|x+3|^{2/15}} + C \end{aligned}$$

**Solution 4.17**

$$\begin{aligned} \int_0^4 \frac{1}{(x-1)^2} dx &= \lim_{\delta \rightarrow 0^+} \int_0^{1-\delta} \frac{1}{(x-1)^2} dx + \lim_{\epsilon \rightarrow 0^+} \int_{1+\epsilon}^4 \frac{1}{(x-1)^2} dx \\ &= \lim_{\delta \rightarrow 0^+} \left[ -\frac{1}{x-1} \right]_0^{1-\delta} + \lim_{\epsilon \rightarrow 0^+} \left[ -\frac{1}{x-1} \right]_{1+\epsilon}^4 \\ &= \lim_{\delta \rightarrow 0^+} \left( \frac{1}{\delta} - 1 \right) + \lim_{\epsilon \rightarrow 0^+} \left( -\frac{1}{3} + \frac{1}{\epsilon} \right) \\ &= \infty + \infty \end{aligned}$$

The integral diverges.

**Solution 4.18**

$$\begin{aligned}\int_0^1 \frac{1}{\sqrt{x}} dx &= \lim_{\epsilon \rightarrow 0^+} \int_{\epsilon}^1 \frac{1}{\sqrt{x}} dx \\ &= \lim_{\epsilon \rightarrow 0^+} [2\sqrt{x}]_{\epsilon}^1 \\ &= \lim_{\epsilon \rightarrow 0^+} 2(1 - \sqrt{\epsilon}) \\ &= 2\end{aligned}$$

**Solution 4.19**

$$\begin{aligned}\int_0^{\infty} \frac{1}{x^2 + 4} dx &= \lim_{\alpha \rightarrow \infty} \int_0^{\alpha} \frac{1}{x^2 + 4} dx \\ &= \lim_{\alpha \rightarrow \infty} \left[ \frac{1}{2} \arctan \left( \frac{x}{2} \right) \right]_0^{\alpha} \\ &= \frac{1}{2} \left( \frac{\pi}{2} - 0 \right) \\ &= \frac{\pi}{4}\end{aligned}$$

## 4.9 Quiz

### Problem 4.1

Write the limit-sum definition of  $\int_a^b f(x) dx$ .

**Solution**

### Problem 4.2

Evaluate  $\int_{-1}^2 \sqrt{|x|} dx$ .

**Solution**

### Problem 4.3

Evaluate  $\frac{d}{dx} \int_x^{x^2} f(\xi) d\xi$ .

**Solution**

### Problem 4.4

Evaluate  $\int \frac{1+x+x^2}{(x+1)^3} dx$ .

**Solution**

### Problem 4.5

State the integral mean value theorem.

**Solution**

### Problem 4.6

What is the partial fraction expansion of  $\frac{1}{x(x-1)(x-2)(x-3)}$ ?

**Solution**

## 4.10 Quiz Solutions

### Solution 4.1

Let  $a = x_0 < x_1 < \cdots < x_{n-1} < x_n = b$  be a partition of the interval  $(a..b)$ . We define  $\Delta x_i = x_{i+1} - x_i$  and  $\Delta x = \max_i \Delta x_i$  and choose  $\xi_i \in [x_i..x_{i+1}]$ .

$$\int_a^b f(x) dx = \lim_{\Delta x \rightarrow 0} \sum_{i=0}^{n-1} f(\xi_i) \Delta x_i$$

### Solution 4.2

$$\begin{aligned} \int_{-1}^2 \sqrt{|x|} dx &= \int_{-1}^0 \sqrt{-x} dx + \int_0^2 \sqrt{x} dx \\ &= \int_0^1 \sqrt{x} dx + \int_0^2 \sqrt{x} dx \\ &= \left[ \frac{2}{3} x^{3/2} \right]_0^1 + \left[ \frac{2}{3} x^{3/2} \right]_0^2 \\ &= \frac{2}{3} + \frac{2}{3} 2^{3/2} \\ &= \frac{2}{3} (1 + 2\sqrt{2}) \end{aligned}$$

### Solution 4.3

$$\begin{aligned} \frac{d}{dx} \int_x^{x^2} f(\xi) d\xi &= f(x^2) \frac{d}{dx}(x^2) - f(x) \frac{d}{dx}(x) \\ &= 2x f(x^2) - f(x) \end{aligned}$$

**Solution 4.4**

First we expand the integrand in partial fractions.

$$\frac{1+x+x^2}{(x+1)^3} = \frac{a}{(x+1)^3} + \frac{b}{(x+1)^2} + \frac{c}{x+1}$$

$$a = (1+x+x^2)|_{x=-1} = 1$$

$$b = \frac{1}{1!} \left( \frac{d}{dx}(1+x+x^2) \right) \Big|_{x=-1} = (1+2x)|_{x=-1} = -1$$

$$c = \frac{1}{2!} \left( \frac{d^2}{dx^2}(1+x+x^2) \right) \Big|_{x=-1} = \frac{1}{2}(2)|_{x=-1} = 1$$

Then we can do the integration.

$$\begin{aligned} \int \frac{1+x+x^2}{(x+1)^3} dx &= \int \left( \frac{1}{(x+1)^3} - \frac{1}{(x+1)^2} + \frac{1}{x+1} \right) dx \\ &= -\frac{1}{2(x+1)^2} + \frac{1}{x+1} + \ln|x+1| \\ &= \frac{x+1/2}{(x+1)^2} + \ln|x+1| \end{aligned}$$

**Solution 4.5**

Let  $f(x)$  be continuous. Then

$$\int_a^b f(x) dx = (b-a)f(\xi),$$

for some  $\xi \in [a..b]$ .

**Solution 4.6**

$$\frac{1}{x(x-1)(x-2)(x-3)} = \frac{a}{x} + \frac{b}{x-1} + \frac{c}{x-2} + \frac{d}{x-3}$$



$$a = \frac{1}{(0-1)(0-2)(0-3)} = -\frac{1}{6}$$

$$b = \frac{1}{(1)(1-2)(1-3)} = \frac{1}{2}$$

$$c = \frac{1}{(2)(2-1)(2-3)} = -\frac{1}{2}$$

$$d = \frac{1}{(3)(3-1)(3-2)} = \frac{1}{6}$$

$$\frac{1}{x(x-1)(x-2)(x-3)} = -\frac{1}{6x} + \frac{1}{2(x-1)} - \frac{1}{2(x-2)} + \frac{1}{6(x-3)}$$

# Chapter 5

## Vector Calculus

### 5.1 Vector Functions

**Vector-valued Functions.** A vector-valued function,  $\mathbf{r}(t)$ , is a mapping  $\mathbf{r} : \mathbb{R} \mapsto \mathbb{R}^n$  that assigns a vector to each value of  $t$ .

$$\mathbf{r}(t) = r_1(t)\mathbf{e}_1 + \cdots + r_n(t)\mathbf{e}_n.$$

An example of a vector-valued function is the position of an object in space as a function of time. The function is continuous at a point  $t = \tau$  if

$$\lim_{t \rightarrow \tau} \mathbf{r}(t) = \mathbf{r}(\tau).$$

This occurs if and only if the component functions are continuous. The function is differentiable if

$$\frac{d\mathbf{r}}{dt} \equiv \lim_{\Delta t \rightarrow 0} \frac{\mathbf{r}(t + \Delta t) - \mathbf{r}(t)}{\Delta t}$$

exists. This occurs if and only if the component functions are differentiable.

If  $\mathbf{r}(t)$  represents the position of a particle at time  $t$ , then the velocity and acceleration of the particle are

$$\frac{d\mathbf{r}}{dt} \quad \text{and} \quad \frac{d^2\mathbf{r}}{dt^2},$$

respectively. The speed of the particle is  $|\mathbf{r}'(t)|$ .

**Differentiation Formulas.** Let  $\mathbf{f}(t)$  and  $\mathbf{g}(t)$  be vector functions and  $a(t)$  be a scalar function. By writing out components you can verify the differentiation formulas:

$$\begin{aligned}\frac{d}{dt}(\mathbf{f} \cdot \mathbf{g}) &= \mathbf{f}' \cdot \mathbf{g} + \mathbf{f} \cdot \mathbf{g}' \\ \frac{d}{dt}(\mathbf{f} \times \mathbf{g}) &= \mathbf{f}' \times \mathbf{g} + \mathbf{f} \times \mathbf{g}' \\ \frac{d}{dt}(a\mathbf{f}) &= a'\mathbf{f} + a\mathbf{f}'\end{aligned}$$

## 5.2 Gradient, Divergence and Curl

**Scalar and Vector Fields.** A *scalar field* is a function of position  $u(\mathbf{x})$  that assigns a scalar to each point in space. A function that gives the temperature of a material is an example of a scalar field. In two dimensions, you can graph a scalar field as a surface plot, (Figure 5.1), with the vertical axis for the value of the function.

A *vector field* is a function of position  $\mathbf{u}(\mathbf{x})$  that assigns a vector to each point in space. Examples of vector fields are functions that give the acceleration due to gravity or the velocity of a fluid. You can graph a vector field in two or three dimension by drawing vectors at regularly spaced points. (See Figure 5.1 for a vector field in two dimensions.)

**Partial Derivatives of Scalar Fields.** Consider a scalar field  $u(\mathbf{x})$ . The *partial derivative* of  $u$  with respect to  $x_k$  is the derivative of  $u$  in which  $x_k$  is considered to be a variable and the remaining arguments are considered to be parameters. The partial derivative is denoted  $\frac{\partial}{\partial x_k}u(\mathbf{x})$ ,  $\frac{\partial u}{\partial x_k}$  or  $u_{x_k}$  and is defined

$$\frac{\partial u}{\partial x_k} \equiv \lim_{\Delta x \rightarrow 0} \frac{u(x_1, \dots, x_k + \Delta x, \dots, x_n) - u(x_1, \dots, x_k, \dots, x_n)}{\Delta x}.$$

Partial derivatives have the same differentiation formulas as ordinary derivatives.

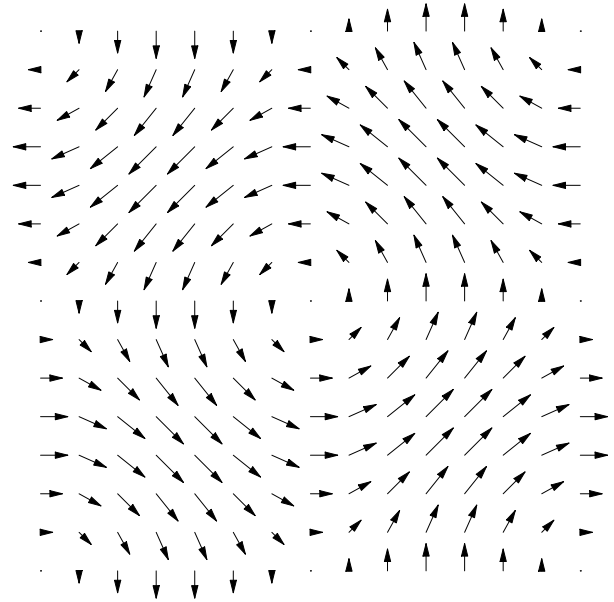
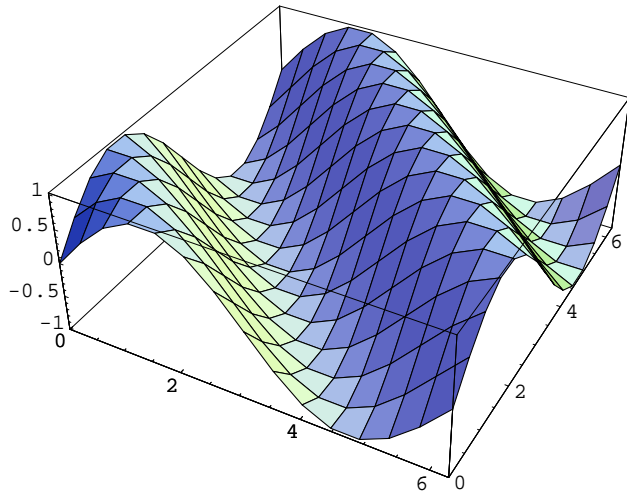

Figure 5.1: A Scalar Field and a Vector Field

Consider a scalar field in  $\mathbb{R}^3$ ,  $u(x, y, z)$ . Higher derivatives of  $u$  are denoted:

$$u_{xx} \equiv \frac{\partial^2 u}{\partial x^2} \equiv \frac{\partial}{\partial x} \frac{\partial u}{\partial x},$$

$$u_{xy} \equiv \frac{\partial^2 u}{\partial x \partial y} \equiv \frac{\partial}{\partial x} \frac{\partial u}{\partial y},$$

$$u_{xyz} \equiv \frac{\partial^3 u}{\partial x^2 \partial y \partial z} \equiv \frac{\partial^2}{\partial x^2} \frac{\partial u}{\partial y \partial z}.$$

If  $u_{xy}$  and  $u_{yx}$  are continuous, then

$$\frac{\partial^2 u}{\partial x \partial y} = \frac{\partial^2 u}{\partial y \partial x}.$$

This is referred to as the *equality of mixed partial derivatives*.

**Partial Derivatives of Vector Fields.** Consider a vector field  $\mathbf{u}(\mathbf{x})$ . The partial derivative of  $\mathbf{u}$  with respect to  $x_k$  is denoted  $\frac{\partial}{\partial x_k} \mathbf{u}(\mathbf{x})$ ,  $\frac{\partial \mathbf{u}}{\partial x_k}$  or  $\mathbf{u}_{x_k}$  and is defined

$$\frac{\partial \mathbf{u}}{\partial x_k} \equiv \lim_{\Delta x \rightarrow 0} \frac{\mathbf{u}(x_1, \dots, x_k + \Delta x, \dots, x_n) - \mathbf{u}(x_1, \dots, x_k, \dots, x_n)}{\Delta x}.$$

Partial derivatives of vector fields have the same differentiation formulas as ordinary derivatives.

**Gradient.** We introduce the vector differential operator,

$$\nabla \equiv \frac{\partial}{\partial x_1} \mathbf{e}_1 + \cdots + \frac{\partial}{\partial x_n} \mathbf{e}_n,$$

which is known as *del* or *nabla*. In  $\mathbb{R}^3$  it is

$$\nabla \equiv \frac{\partial}{\partial x} \mathbf{i} + \frac{\partial}{\partial y} \mathbf{j} + \frac{\partial}{\partial z} \mathbf{k}.$$

Let  $u(\mathbf{x})$  be a differential scalar field. The *gradient* of  $u$  is,

$$\nabla u \equiv \frac{\partial u}{\partial x_1} \mathbf{e}_1 + \cdots + \frac{\partial u}{\partial x_n} \mathbf{e}_n,$$

**Directional Derivative.** Suppose you are standing on some terrain. The slope of the ground in a particular direction is the *directional derivative* of the elevation in that direction. Consider a differentiable scalar field,  $u(\mathbf{x})$ . The

derivative of the function in the direction of the unit vector  $\mathbf{a}$  is the rate of change of the function in that direction. Thus the directional derivative,  $D_{\mathbf{a}}u$ , is defined:

$$\begin{aligned} D_{\mathbf{a}}u(\mathbf{x}) &= \lim_{\epsilon \rightarrow 0} \frac{u(\mathbf{x} + \epsilon \mathbf{a}) - u(\mathbf{x})}{\epsilon} \\ &= \lim_{\epsilon \rightarrow 0} \frac{u(x_1 + \epsilon a_1, \dots, x_n + \epsilon a_n) - u(x_1, \dots, x_n)}{\epsilon} \\ &= \lim_{\epsilon \rightarrow 0} \frac{(u(\mathbf{x}) + \epsilon a_1 u_{x_1}(\mathbf{x}) + \dots + \epsilon a_n u_{x_n}(\mathbf{x}) + \mathcal{O}(\epsilon^2)) - u(\mathbf{x})}{\epsilon} \\ &= a_1 u_{x_1}(\mathbf{x}) + \dots + a_n u_{x_n}(\mathbf{x}) \\ D_{\mathbf{a}}u(\mathbf{x}) &= \nabla u(\mathbf{x}) \cdot \mathbf{a}. \end{aligned}$$

**Tangent to a Surface.** The gradient,  $\nabla f$ , is orthogonal to the surface  $f(\mathbf{x}) = 0$ . Consider a point  $\boldsymbol{\xi}$  on the surface. Let the differential  $d\mathbf{r} = dx_1 \mathbf{e}_1 + \dots + dx_n \mathbf{e}_n$  lie in the tangent plane at  $\boldsymbol{\xi}$ . Then

$$df = \frac{\partial f}{\partial x_1} dx_1 + \dots + \frac{\partial f}{\partial x_n} dx_n = 0$$

since  $f(\mathbf{x}) = 0$  on the surface. Then

$$\begin{aligned} \nabla f \cdot d\mathbf{r} &= \left( \frac{\partial f}{\partial x_1} \mathbf{e}_1 + \dots + \frac{\partial f}{\partial x_n} \mathbf{e}_n \right) \cdot (dx_1 \mathbf{e}_1 + \dots + dx_n \mathbf{e}_n) \\ &= \frac{\partial f}{\partial x_1} dx_1 + \dots + \frac{\partial f}{\partial x_n} dx_n \\ &= 0 \end{aligned}$$

Thus  $\nabla f$  is orthogonal to the tangent plane and hence to the surface.

**Example 5.2.1** Consider the paraboloid,  $x^2 + y^2 - z = 0$ . We want to find the tangent plane to the surface at the point  $(1, 1, 2)$ . The gradient is

$$\nabla f = 2x\mathbf{i} + 2y\mathbf{j} - \mathbf{k}.$$

At the point  $(1, 1, 2)$  this is

$$\nabla f(1, 1, 2) = 2\mathbf{i} + 2\mathbf{j} - \mathbf{k}.$$

We know a point on the tangent plane,  $(1, 1, 2)$ , and the normal,  $\nabla f(1, 1, 2)$ . The equation of the plane is

$$\nabla f(1, 1, 2) \cdot (x, y, z) = \nabla f(1, 1, 2) \cdot (1, 1, 2)$$

$$\boxed{2x + 2y - z = 2}$$

The gradient of the function  $f(\mathbf{x}) = 0$ ,  $\nabla f(\mathbf{x})$ , is in the direction of the maximum directional derivative. The magnitude of the gradient,  $|\nabla f(\mathbf{x})|$ , is the value of the directional derivative in that direction. To derive this, note that

$$D_{\mathbf{a}}f = \nabla f \cdot \mathbf{a} = |\nabla f| \cos \theta,$$

where  $\theta$  is the angle between  $\nabla f$  and  $\mathbf{a}$ .  $D_{\mathbf{a}}f$  is maximum when  $\theta = 0$ , i.e. when  $\mathbf{a}$  is the same direction as  $\nabla f$ . In this direction,  $D_{\mathbf{a}}f = |\nabla f|$ . To use the elevation example,  $\nabla f$  points in the uphill direction and  $|\nabla f|$  is the uphill slope.

**Example 5.2.2** Suppose that the two surfaces  $f(\mathbf{x}) = 0$  and  $g(\mathbf{x}) = 0$  intersect at the point  $\mathbf{x} = \boldsymbol{\xi}$ . What is the angle between their tangent planes at that point? First we note that the angle between the tangent planes is by definition the angle between their normals. These normals are in the direction of  $\nabla f(\boldsymbol{\xi})$  and  $\nabla g(\boldsymbol{\xi})$ . (We assume these are nonzero.) The angle,  $\theta$ , between the tangent planes to the surfaces is

$$\boxed{\theta = \arccos \left( \frac{\nabla f(\boldsymbol{\xi}) \cdot \nabla g(\boldsymbol{\xi})}{|\nabla f(\boldsymbol{\xi})| |\nabla g(\boldsymbol{\xi})|} \right)}.$$

**Example 5.2.3** Let  $u$  be the distance from the origin:

$$u(\mathbf{x}) = \sqrt{\mathbf{x} \cdot \mathbf{x}} = \sqrt{x_i x_i}.$$

In three dimensions, this is

$$u(x, y, z) = \sqrt{x^2 + y^2 + z^2}.$$

The gradient of  $u$ ,  $\nabla(\mathbf{x})$ , is a unit vector in the direction of  $\mathbf{x}$ . The gradient is:

$$\nabla u(\mathbf{x}) = \left\langle \frac{x_1}{\sqrt{\mathbf{x} \cdot \mathbf{x}}}, \dots, \frac{x_n}{\sqrt{\mathbf{x} \cdot \mathbf{x}}} \right\rangle = \frac{x_i \mathbf{e}_i}{\sqrt{x_j x_j}}.$$

In three dimensions, we have

$$\nabla u(x, y, z) = \left\langle \frac{x}{\sqrt{x^2 + y^2 + z^2}}, \frac{y}{\sqrt{x^2 + y^2 + z^2}}, \frac{z}{\sqrt{x^2 + y^2 + z^2}} \right\rangle.$$

This is a unit vector because the sum of the squared components sums to unity.

$$\nabla u \cdot \nabla u = \frac{x_i \mathbf{e}_i}{\sqrt{x_j x_j}} \cdot \frac{x_k \mathbf{e}_k}{\sqrt{x_l x_l}} \frac{x_i x_i}{x_j x_j} = 1$$

Figure 5.2 shows a plot of the vector field of  $\nabla u$  in two dimensions.

**Example 5.2.4** Consider an ellipse. An implicit equation of an ellipse is

$$\frac{x^2}{a^2} + \frac{y^2}{b^2} = 1.$$

We can also express an ellipse as  $u(x, y) + v(x, y) = c$  where  $u$  and  $v$  are the distance from the two foci. That is, an ellipse is the set of points such that the sum of the distances from the two foci is a constant. Let  $\mathbf{n} = \nabla(u + v)$ . This is a vector which is orthogonal to the ellipse when evaluated on the surface. Let  $\mathbf{t}$  be a unit tangent to the surface. Since  $\mathbf{n}$  and  $\mathbf{t}$  are orthogonal,

$$\begin{aligned} \mathbf{n} \cdot \mathbf{t} &= 0 \\ (\nabla u + \nabla v) \cdot \mathbf{t} &= 0 \\ \nabla u \cdot \mathbf{t} &= \nabla v \cdot (-\mathbf{t}). \end{aligned}$$

Since these are unit vectors, the angle between  $\nabla u$  and  $\mathbf{t}$  is equal to the angle between  $\nabla v$  and  $-\mathbf{t}$ . In other words: If we draw rays from the foci to a point on the ellipse, the rays make equal angles with the ellipse. If the ellipse were



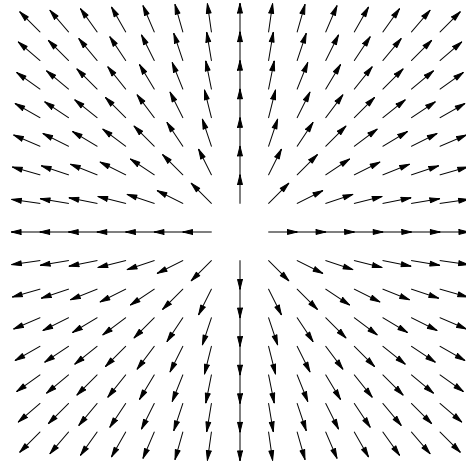

Figure 5.2: The gradient of the distance from the origin.

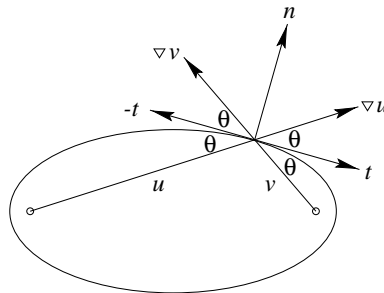

Figure 5.3: An ellipse and rays from the foci.

a reflective surface, a wave starting at one focus would be reflected from the ellipse and travel to the other focus. See Figure 5.3. This result also holds for ellipsoids,  $u(x, y, z) + v(x, y, z) = c$ .

*We see that an ellipsoidal dish could be used to collect spherical waves, (waves emanating from a point). If the dish is shaped so that the source of the waves is located at one foci and a collector is placed at the second, then any wave starting at the source and reflecting off the dish will travel to the collector. See Figure 5.4.*

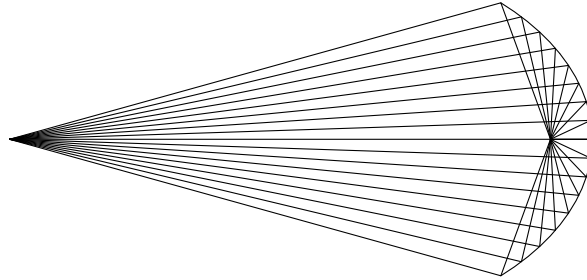

Figure 5.4: An elliptical dish.

## 5.3 Exercises

### Vector Functions

#### Exercise 5.1

Consider the parametric curve

$$\mathbf{r} = \cos\left(\frac{t}{2}\right) \mathbf{i} + \sin\left(\frac{t}{2}\right) \mathbf{j}.$$

Calculate  $\frac{d\mathbf{r}}{dt}$  and  $\frac{d^2\mathbf{r}}{dt^2}$ . Plot the position and some velocity and acceleration vectors.

[Hint](#), [Solution](#)

#### Exercise 5.2

Let  $\mathbf{r}(t)$  be the position of an object moving with constant speed. Show that the acceleration of the object is orthogonal to the velocity of the object.

[Hint](#), [Solution](#)

### Vector Fields

#### Exercise 5.3

Consider the paraboloid  $x^2 + y^2 - z = 0$ . What is the angle between the two tangent planes that touch the surface at  $(1, 1, 2)$  and  $(1, -1, 2)$ ? What are the equations of the tangent planes at these points?

[Hint](#), [Solution](#)

#### Exercise 5.4

Consider the paraboloid  $x^2 + y^2 - z = 0$ . What is the point on the paraboloid that is closest to  $(1, 0, 0)$ ?

[Hint](#), [Solution](#)

#### Exercise 5.5

Consider the region  $R$  defined by  $x^2 + xy + y^2 \leq 9$ . What is the volume of the solid obtained by rotating  $R$  about the  $y$  axis?

Is this the same as the volume of the solid obtained by rotating  $R$  about the  $x$  axis? Give geometric and algebraic explanations of this.

Hint, Solution

### Exercise 5.6

Two cylinders of unit radius intersect at right angles as shown in Figure 5.5. What is the volume of the solid enclosed by the cylinders?

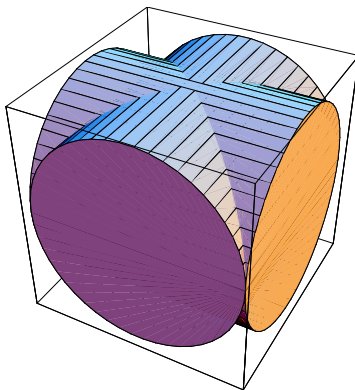

Figure 5.5: Two cylinders intersecting.

Hint, Solution

### Exercise 5.7

Consider the curve  $f(x) = 1/x$  on the interval  $[1 \dots \infty)$ . Let  $S$  be the solid obtained by rotating  $f(x)$  about the  $x$  axis. (See Figure 5.6.) Show that the length of  $f(x)$  and the lateral area of  $S$  are infinite. Find the volume of  $S$ .<sup>1</sup>

Hint, Solution

### Exercise 5.8

Suppose that a deposit of oil looks like a cone in the ground as illustrated in Figure 5.7. Suppose that the oil has a

---

<sup>1</sup>You could fill  $S$  with a finite amount of paint, but it would take an infinite amount of paint to cover its surface.

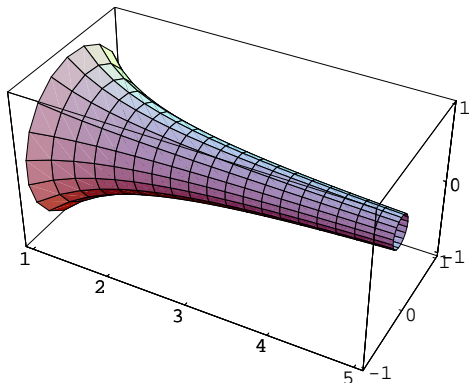

Figure 5.6: The rotation of  $1/x$  about the  $x$  axis.

density of  $800\text{kg/m}^3$  and its vertical depth is 12m. How much work<sup>2</sup> would it take to get the oil to the surface.

[Hint](#), [Solution](#)

### Exercise 5.9

Find the area and volume of a sphere of radius  $R$  by integrating in spherical coordinates.

[Hint](#), [Solution](#)

---

<sup>2</sup> Recall that work = force  $\times$  distance and force = mass  $\times$  acceleration.

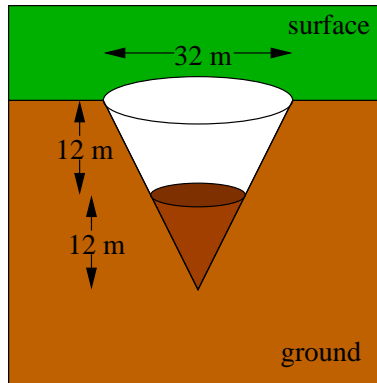

Figure 5.7: The oil deposit.

## 5.4 Hints

### Vector Functions

#### Hint 5.1

Plot the velocity and acceleration vectors at regular intervals along the path of motion.

#### Hint 5.2

If  $\mathbf{r}(t)$  has constant speed, then  $|\mathbf{r}'(t)| = c$ . The condition that the acceleration is orthogonal to the velocity can be stated mathematically in terms of the dot product,  $\mathbf{r}''(t) \cdot \mathbf{r}'(t) = 0$ . Write the condition of constant speed in terms of a dot product and go from there.

### Vector Fields

#### Hint 5.3

The angle between two planes is the angle between the vectors orthogonal to the planes. The angle between the two

vectors is

$$\theta = \arccos \left( \frac{\langle 2, 2, -1 \rangle \cdot \langle 2, -2, -1 \rangle}{|\langle 2, 2, -1 \rangle| |\langle 2, -2, -1 \rangle|} \right)$$

The equation of a line orthogonal to  $\mathbf{a}$  and passing through the point  $\mathbf{b}$  is  $\mathbf{a} \cdot \mathbf{x} = \mathbf{a} \cdot \mathbf{b}$ .

**Hint 5.4**

Since the paraboloid is a differentiable surface, the normal to the surface at the closest point will be parallel to the vector from the closest point to  $(1, 0, 0)$ . We can express this using the gradient and the cross product. If  $(x, y, z)$  is the closest point on the paraboloid, then a vector orthogonal to the surface there is  $\nabla f = \langle 2x, 2y, -1 \rangle$ . The vector from the surface to the point  $(1, 0, 0)$  is  $\langle 1 - x, -y, -z \rangle$ . These two vectors are parallel if their cross product is zero.

**Hint 5.5**

CONTINUE

**Hint 5.6**

CONTINUE

**Hint 5.7**

CONTINUE

**Hint 5.8**

Start with the formula for the work required to move the oil to the surface. Integrate over the mass of the oil.

$$\text{Work} = \int (\text{acceleration}) (\text{distance}) d(\text{mass})$$

Here (distance) is the distance of the differential of mass from the surface. The acceleration is that of gravity,  $g$ .

**Hint 5.9**

CONTINUE

## 5.5 Solutions

### Vector Functions

#### Solution 5.1

The velocity is

$$\mathbf{r}' = -\frac{1}{2} \sin\left(\frac{t}{2}\right) \mathbf{i} + \frac{1}{2} \cos\left(\frac{t}{2}\right) \mathbf{j}.$$

The acceleration is

$$\mathbf{r}'' = -\frac{1}{4} \cos\left(\frac{t}{2}\right) \mathbf{i} - \frac{1}{4} \sin\left(\frac{t}{2}\right) \mathbf{j}.$$

See Figure 5.8 for plots of position, velocity and acceleration.

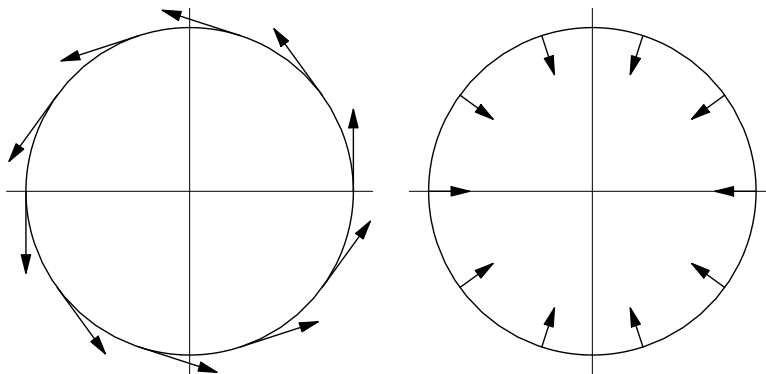

Figure 5.8: A Graph of Position and Velocity and of Position and Acceleration

#### Solution 5.2

If  $\mathbf{r}(t)$  has constant speed, then  $|\mathbf{r}'(t)| = c$ . The condition that the acceleration is orthogonal to the velocity can be stated mathematically in terms of the dot product,  $\mathbf{r}''(t) \cdot \mathbf{r}'(t) = 0$ . Note that we can write the condition of constant



speed in terms of a dot product,

$$\begin{aligned}\sqrt{\mathbf{r}'(t) \cdot \mathbf{r}'(t)} &= c, \\ \mathbf{r}'(t) \cdot \mathbf{r}'(t) &= c^2.\end{aligned}$$

Differentiating this equation yields,

$$\begin{aligned}\mathbf{r}''(t) \cdot \mathbf{r}'(t) + \mathbf{r}'(t) \cdot \mathbf{r}''(t) &= 0 \\ \mathbf{r}''(t) \cdot \mathbf{r}'(t) &= 0.\end{aligned}$$

This shows that the acceleration is orthogonal to the velocity.

## Vector Fields

### Solution 5.3

The gradient, which is orthogonal to the surface when evaluated there is  $\nabla f = 2x\mathbf{i} + 2y\mathbf{j} - \mathbf{k}$ .  $2\mathbf{i} + 2\mathbf{j} - \mathbf{k}$  and  $2\mathbf{i} - 2\mathbf{j} - \mathbf{k}$  are orthogonal to the paraboloid, (and hence the tangent planes), at the points  $(1, 1, 2)$  and  $(1, -1, 2)$ , respectively. The angle between the tangent planes is the angle between the vectors orthogonal to the planes. The angle between the two vectors is

$$\theta = \arccos \left( \frac{\langle 2, 2, -1 \rangle \cdot \langle 2, -2, -1 \rangle}{|\langle 2, 2, -1 \rangle| |\langle 2, -2, -1 \rangle|} \right)$$

$$\theta = \arccos \left( \frac{1}{9} \right) \approx 1.45946.$$

Recall that the equation of a line orthogonal to  $\mathbf{a}$  and passing through the point  $\mathbf{b}$  is  $\mathbf{a} \cdot \mathbf{x} = \mathbf{a} \cdot \mathbf{b}$ . The equations of the tangent planes are

$$\langle 2, \pm 2, -1 \rangle \cdot \langle x, y, z \rangle = \langle 2, \pm 2, -1 \rangle \cdot \langle 1, \pm 1, 2 \rangle,$$

$$2x \pm 2y - z = 2.$$

The paraboloid and the tangent planes are shown in Figure 5.9.

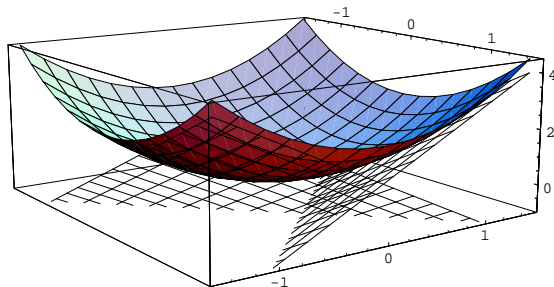

Figure 5.9: Paraboloid and Two Tangent Planes

### Solution 5.4

Since the paraboloid is a differentiable surface, the normal to the surface at the closest point will be parallel to the vector from the closest point to  $(1, 0, 0)$ . We can express this using the gradient and the cross product. If  $(x, y, z)$  is the closest point on the paraboloid, then a vector orthogonal to the surface there is  $\nabla f = \langle 2x, 2y, -1 \rangle$ . The vector from the surface to the point  $(1, 0, 0)$  is  $\langle 1 - x, -y, -z \rangle$ . These two vectors are parallel if their cross product is zero,

$$\langle 2x, 2y, -1 \rangle \times \langle 1 - x, -y, -z \rangle = \langle -y - 2yz, -1 + x + 2xz, -2y \rangle = \mathbf{0}.$$

This gives us the three equations,

$$\begin{aligned} -y - 2yz &= 0, \\ -1 + x + 2xz &= 0, \\ -2y &= 0. \end{aligned}$$

The third equation requires that  $y = 0$ . The first equation then becomes trivial and we are left with the second equation,

$$-1 + x + 2xz = 0.$$

Substituting  $z = x^2 + y^2$  into this equation yields,

$$2x^3 + x - 1 = 0.$$

The only real valued solution of this polynomial is

$$x = \frac{6^{-2/3} (9 + \sqrt{87})^{2/3} - 6^{-1/3}}{(9 + \sqrt{87})^{1/3}} \approx 0.589755.$$

Thus the closest point to  $(1, 0, 0)$  on the paraboloid is

$$\left( \frac{6^{-2/3} (9 + \sqrt{87})^{2/3} - 6^{-1/3}}{(9 + \sqrt{87})^{1/3}}, 0, \left( \frac{6^{-2/3} (9 + \sqrt{87})^{2/3} - 6^{-1/3}}{(9 + \sqrt{87})^{1/3}} \right)^2 \right) \approx (0.589755, 0, 0.34781).$$

The closest point is shown graphically in Figure 5.10.

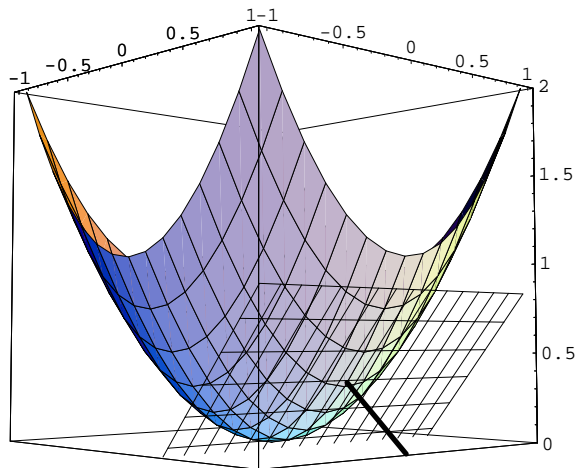

Figure 5.10: Paraboloid, Tangent Plane and Line Connecting  $(1, 0, 0)$  to Closest Point

### Solution 5.5

We consider the region  $R$  defined by  $x^2 + xy + y^2 \leq 9$ . The boundary of the region is an ellipse. (See Figure 5.11 for the ellipse and the solid obtained by rotating the region.) Note that in rotating the region about the  $y$  axis, only the

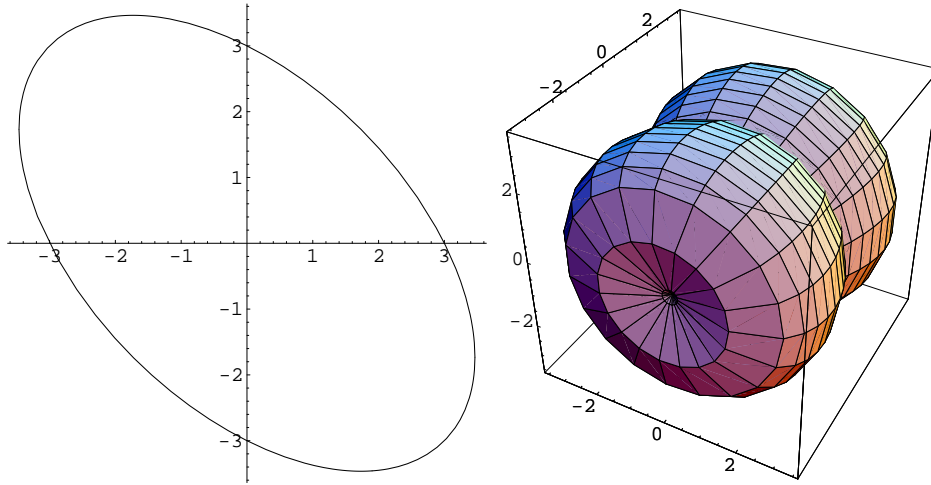

Figure 5.11: The curve  $x^2 + xy + y^2 = 9$ .

portions in the second and fourth quadrants make a contribution. Since the solid is symmetric across the  $xz$  plane, we will find the volume of the top half and then double this to get the volume of the whole solid. Now we consider rotating the region in the second quadrant about the  $y$  axis. In the equation for the ellipse,  $x^2 + xy + y^2 = 9$ , we solve for  $x$ .

$$x = \frac{1}{2} \left( -y \pm \sqrt{3} \sqrt{12 - y^2} \right)$$

In the second quadrant, the curve  $(-y - \sqrt{3} \sqrt{12 - y^2})/2$  is defined on  $y \in [0 \dots \sqrt{12}]$  and the curve  $(-y + \sqrt{3} \sqrt{12 - y^2})/2$  is defined on  $y \in [3 \dots \sqrt{12}]$ . (See Figure 5.12.) We find the volume obtained by rotating the

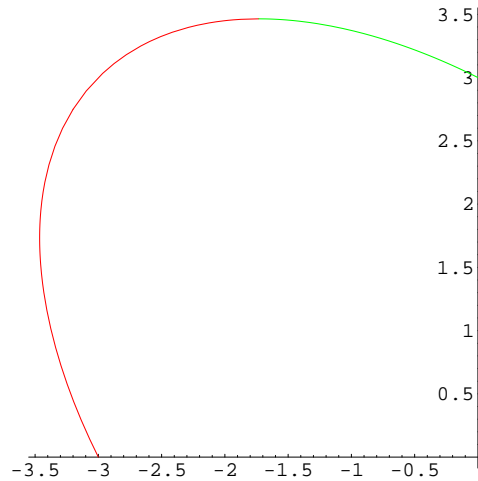

Figure 5.12:  $(-y - \sqrt{3}\sqrt{12 - y^2})/2$  in red and  $(-y + \sqrt{3}\sqrt{12 - y^2})/2$  in green.

first curve and subtract the volume from rotating the second curve.

$$\begin{aligned}
 V &= 2 \left( \int_0^{\sqrt{12}} \pi \left( \frac{-y - \sqrt{3}\sqrt{12 - y^2}}{2} \right)^2 dy - \int_3^{\sqrt{12}} \pi \left( \frac{-y + \sqrt{3}\sqrt{12 - y^2}}{2} \right)^2 dy \right) \\
 V &= \frac{\pi}{2} \left( \int_0^{\sqrt{12}} (y + \sqrt{3}\sqrt{12 - y^2})^2 dy - \int_3^{\sqrt{12}} (-y + \sqrt{3}\sqrt{12 - y^2})^2 dy \right) \\
 V &= \frac{\pi}{2} \left( \int_0^{\sqrt{12}} (-2y^2 + \sqrt{12}y\sqrt{12 - y^2} + 36) dy - \int_3^{\sqrt{12}} (-2y^2 - \sqrt{12}y\sqrt{12 - y^2} + 36) dy \right) \\
 V &= \frac{\pi}{2} \left( \left[ -\frac{2}{3}y^3 - \frac{2}{\sqrt{3}}(12 - y^2)^{3/2} + 36y \right]_0^{\sqrt{12}} - \left[ -\frac{2}{3}y^3 + \frac{2}{\sqrt{3}}(12 - y^2)^{3/2} + 36y \right]_3^{\sqrt{12}} \right) \\
 &\quad \boxed{V = 72\pi}
 \end{aligned}$$

Now consider the volume of the solid obtained by rotating  $R$  about the  $x$  axis? This is the same as the volume of the solid obtained by rotating  $R$  about the  $y$  axis. Geometrically we know this because  $R$  is symmetric about the line  $y = x$ .

Now we justify it algebraically. Consider the phrase: Rotate the region  $x^2 + xy + y^2 \leq 9$  about the  $x$  axis. We formally swap  $x$  and  $y$  to obtain: Rotate the region  $y^2 + yx + x^2 \leq 9$  about the  $y$  axis. Which is the original problem.

### Solution 5.6

We find the volume of the intersecting cylinders by summing the volumes of the two cylinders and then subtracting the volume of their intersection. The volume of each of the cylinders is  $2\pi$ . The intersection is shown in Figure 5.13. If we slice this solid along the plane  $z = \text{const}$  we have a square with side length  $2\sqrt{1 - z^2}$ . The volume of the intersection of the cylinders is

$$\int_{-1}^1 4(1 - z^2) dz.$$

We compute the volume of the intersecting cylinders.

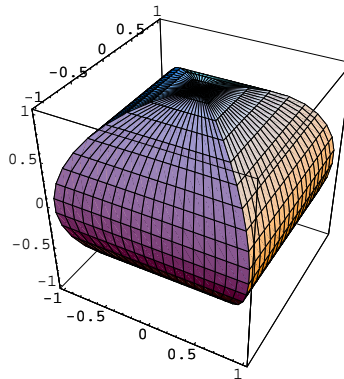

Figure 5.13: The intersection of the two cylinders.

$$V = 2(2\pi) - 2 \int_0^1 4(1 - z^2) dz$$

$$V = 4\pi - \frac{16}{3}$$

### Solution 5.7

The length of  $f(x)$  is

$$L = \int_1^{\infty} \sqrt{1 + 1/x^2} dx.$$

Since  $\sqrt{1 + 1/x^2} > 1/x$ , the integral diverges. The length is infinite.

We find the area of  $S$  by integrating the length of circles.

$$A = \int_1^{\infty} \frac{2\pi}{x} dx$$

This integral also diverges. The area is infinite.

Finally we find the volume of  $S$  by integrating the area of disks.

$$V = \int_1^{\infty} \frac{\pi}{x^2} dx = \left[ -\frac{\pi}{x} \right]_1^{\infty} = \pi$$

### Solution 5.8

First we write the formula for the work required to move the oil to the surface. We integrate over the mass of the oil.

$$\text{Work} = \int (\text{acceleration}) (\text{distance}) d(\text{mass})$$

Here (distance) is the distance of the differential of mass from the surface. The acceleration is that of gravity,  $g$ . The differential of mass can be represented as a differential of volume times the density of the oil,  $800 \text{ kg/m}^3$ .

$$\text{Work} = \int 800g(\text{distance}) d(\text{volume})$$

We place the coordinate axis so that  $z = 0$  coincides with the bottom of the cone. The oil lies between  $z = 0$  and  $z = 12$ . The cross sectional area of the oil deposit at a fixed depth is  $\pi z^2$ . Thus the differential of volume is  $\pi z^2 dz$ . This oil must be raised a distance of  $24 - z$ .

$$W = \int_0^{12} 800g(24 - z)\pi z^2 dz$$

$$W = 6912000g\pi$$

$$W \approx 2.13 \times 10^8 \frac{\text{kg m}^2}{\text{s}^2}$$

### Solution 5.9

The Jacobian in spherical coordinates is  $r^2 \sin \phi$ .

$$\text{area} = \int_0^{2\pi} \int_0^\pi R^2 \sin \phi d\phi d\theta$$

$$= 2\pi R^2 \int_0^\pi \sin \phi d\phi$$

$$= 2\pi R^2 [-\cos \phi]_0^\pi$$

$$\text{area} = 4\pi R^2$$

$$\text{volume} = \int_0^R \int_0^{2\pi} \int_0^\pi r^2 \sin \phi d\phi d\theta dr$$

$$= 2\pi \int_0^R \int_0^\pi r^2 \sin \phi d\phi dr$$

$$= 2\pi \left[ \frac{r^3}{3} \right]_0^R [-\cos \phi]_0^\pi$$

$$\text{volume} = \frac{4}{3}\pi R^3$$



## 5.6 Quiz

### Problem 5.1

What is the distance from the origin to the plane  $x + 2y + 3z = 4$ ?

**Solution**

### Problem 5.2

A bead of mass  $m$  slides frictionlessly on a wire determined parametrically by  $\mathbf{w}(s)$ . The bead moves under the force of gravity. What is the acceleration of the bead as a function of the parameter  $s$ ?

**Solution**

## 5.7 Quiz Solutions

### Solution 5.1

Recall that the equation of a plane is  $\mathbf{x} \cdot \mathbf{n} = \mathbf{a} \cdot \mathbf{n}$  where  $\mathbf{a}$  is a point in the plane and  $\mathbf{n}$  is normal to the plane. We are considering the plane  $x + 2y + 3z = 4$ . A normal to the plane is  $\langle 1, 2, 3 \rangle$ . The unit normal is

$$\mathbf{n} = \frac{1}{\sqrt{15}} \langle 1, 2, 3 \rangle.$$

By substituting in  $x = y = 0$ , we see that a point in the plane is  $\mathbf{a} = \langle 0, 0, 4/3 \rangle$ . The distance of the plane from the origin is  $\mathbf{a} \cdot \mathbf{n} = \frac{4}{\sqrt{15}}$ .

### Solution 5.2

The force of gravity is  $-g\mathbf{k}$ . The unit tangent to the wire is  $\mathbf{w}'(s)/|\mathbf{w}'(s)|$ . The component of the gravitational force in the tangential direction is  $-g\mathbf{k} \cdot \mathbf{w}'(s)/|\mathbf{w}'(s)|$ . Thus the acceleration of the bead is

$$-\frac{g\mathbf{k} \cdot \mathbf{w}'(s)}{m|\mathbf{w}'(s)|}.$$

## Part III

# Functions of a Complex Variable

# Chapter 6

## Complex Numbers

I'm sorry. You have reached an imaginary number. Please rotate your phone 90 degrees and dial again.

-Message on answering machine of Cathy Vargas.

### 6.1 Complex Numbers

**Shortcomings of real numbers.** When you started algebra, you learned that the quadratic equation:  $x^2 + 2ax + b = 0$  has either two, one or no solutions. For example:

- $x^2 - 3x + 2 = 0$  has the two solutions  $x = 1$  and  $x = 2$ .
- For  $x^2 - 2x + 1 = 0$ ,  $x = 1$  is a solution of multiplicity two.
- $x^2 + 1 = 0$  has no solutions.

This is a little unsatisfactory. We can formally solve the general quadratic equation.

$$\begin{aligned}x^2 + 2ax + b &= 0 \\(x + a)^2 &= a^2 - b \\x &= -a \pm \sqrt{a^2 - b}\end{aligned}$$

However, the solutions are defined only when the discriminant  $a^2 - b$  is non-negative. This is because the square root function  $\sqrt{x}$  is a bijection from  $\mathbb{R}^{0+}$  to  $\mathbb{R}^{0+}$ . (See Figure 6.1.)

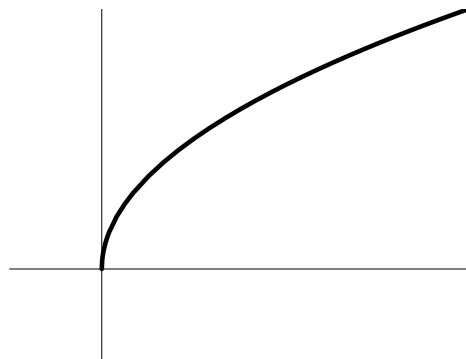

Figure 6.1:  $y = \sqrt{x}$

**A new mathematical constant.** We cannot solve  $x^2 = -1$  because the square root of  $-1$  is not defined. To overcome this apparent shortcoming of the real number system, we create a new symbolic constant  $\sqrt{-1}$ . In performing arithmetic, we will treat  $\sqrt{-1}$  as we would a real constant like  $\pi$  or a formal variable like  $x$ , i.e.  $\sqrt{-1} + \sqrt{-1} = 2\sqrt{-1}$ . This constant has the property:  $(\sqrt{-1})^2 = -1$ . Now we can express the solutions of  $x^2 = -1$  as  $x = \sqrt{-1}$  and  $x = -\sqrt{-1}$ . These satisfy the equation since  $(\sqrt{-1})^2 = -1$  and  $(-\sqrt{-1})^2 = (-1)^2 (\sqrt{-1})^2 = -1$ . Note that we can express the square root of any negative real number in terms of  $\sqrt{-1}$ :  $\sqrt{-r} = \sqrt{-1}\sqrt{r}$  for  $r \geq 0$ .

**Euler's notation.** Euler introduced the notation of using the letter  $i$  to denote  $\sqrt{-1}$ . We will use the symbol  $\iota$ , an  $i$  without a dot, to denote  $\sqrt{-1}$ . This helps us distinguish it from  $i$  used as a variable or index.<sup>1</sup> We call any number of the form  $\iota b$ ,  $b \in \mathbb{R}$ , a *pure imaginary number*.<sup>2</sup> Let  $a$  and  $b$  be real numbers. The product of a real number and an imaginary number is an imaginary number:  $(a)(\iota b) = \iota(ab)$ . The product of two imaginary numbers is a real number:  $(\iota a)(\iota b) = -ab$ . However the sum of a real number and an imaginary number  $a + \iota b$  is neither real nor imaginary. We call numbers of the form  $a + \iota b$  *complex numbers*.<sup>3</sup>

**The quadratic.** Now we return to the quadratic with real coefficients,  $x^2 + 2ax + b = 0$ . It has the solutions  $x = -a \pm \sqrt{a^2 - b}$ . The solutions are real-valued only if  $a^2 - b \geq 0$ . If not, then we can define solutions as complex numbers. If the discriminant is negative, we write  $x = -a \pm \iota\sqrt{b - a^2}$ . Thus every quadratic polynomial with real coefficients has exactly two solutions, counting multiplicities. The fundamental theorem of algebra states that an  $n^{\text{th}}$  degree polynomial with complex coefficients has  $n$ , not necessarily distinct, complex roots. We will prove this result later using the theory of functions of a complex variable.

**Component operations.** Consider the complex number  $z = x + \iota y$ , ( $x, y \in \mathbb{R}$ ). The *real part* of  $z$  is  $\Re(z) = x$ ; the *imaginary part* of  $z$  is  $\Im(z) = y$ . Two complex numbers,  $z = x + \iota y$  and  $\zeta = \xi + \iota\psi$ , are equal if and only if  $x = \xi$  and  $y = \psi$ . The *complex conjugate*<sup>4</sup> of  $z = x + \iota y$  is  $\bar{z} \equiv x - \iota y$ . The notation  $z^* \equiv x - \iota y$  is also used.

**A little arithmetic.** Consider two complex numbers:  $z = x + \iota y$ ,  $\zeta = \xi + \iota\psi$ . It is easy to express the sum or difference as a complex number.

$$z + \zeta = (x + \xi) + \iota(y + \psi), \quad z - \zeta = (x - \xi) + \iota(y - \psi)$$

It is also easy to form the product.

$$z\zeta = (x + \iota y)(\xi + \iota\psi) = x\xi + \iota x\psi + \iota y\xi + \iota^2 y\psi = (x\xi - y\psi) + \iota(x\psi + y\xi)$$

---

<sup>1</sup> Electrical engineering types prefer to use  $j$  or  $j$  to denote  $\sqrt{-1}$ .

<sup>2</sup> "Imaginary" is an unfortunate term. Real numbers are artificial; constructs of the mind. Real numbers are no more real than imaginary numbers.

<sup>3</sup> Here complex means "composed of two or more parts", not "hard to separate, analyze, or solve". Those who disagree have a complex number complex.

<sup>4</sup> Conjugate: having features in common but opposite or inverse in some particular.

The quotient is a bit more difficult. (Assume that  $\zeta$  is nonzero.) How do we express  $z/\zeta = (x + iy)/(\xi + i\psi)$  as the sum of a real number and an imaginary number? The trick is to multiply the numerator and denominator by the complex conjugate of  $\zeta$ .

$$\frac{z}{\zeta} = \frac{x + iy}{\xi + i\psi} = \frac{x + iy}{\xi + i\psi} \frac{\xi - i\psi}{\xi - i\psi} = \frac{x\xi - ix\psi - iy\xi - i^2y\psi}{\xi^2 - i\xi\psi + i\psi\xi - i^2\psi^2} = \frac{(x\xi + y\psi) - i(x\psi + y\xi)}{\xi^2 + \psi^2} = \frac{(x\xi + y\psi)}{\xi^2 + \psi^2} - i \frac{x\psi + y\xi}{\xi^2 + \psi^2}$$

Now we recognize it as a complex number.

**Field properties.** The set of complex numbers  $\mathbb{C}$  form a field. That essentially means that we can do arithmetic with complex numbers. When performing arithmetic, we simply treat  $i$  as a symbolic constant with the property that  $i^2 = -1$ . The field of complex numbers satisfy the following list of properties. Each one is easy to verify; some are proved below. (Let  $z, \zeta, \omega \in \mathbb{C}$ .)

1. Closure under addition and multiplication.

$$\begin{aligned} z + \zeta &= (x + iy) + (\xi + i\psi) \\ &= (x + \xi) + i(y + \psi) \in \mathbb{C} \\ z\zeta &= (x + iy)(\xi + i\psi) \\ &= x\xi + ix\psi + iy\xi + i^2y\psi \\ &= (x\xi - y\psi) + i(x\psi + \xi y) \in \mathbb{C} \end{aligned}$$

2. Commutativity of addition and multiplication.  $z + \zeta = \zeta + z$ .  $z\zeta = \zeta z$ .
3. Associativity of addition and multiplication.  $(z + \zeta) + \omega = z + (\zeta + \omega)$ .  $(z\zeta)\omega = z(\zeta\omega)$ .
4. Distributive law.  $z(\zeta + \omega) = z\zeta + z\omega$ .
5. Identity with respect to addition and multiplication. Zero is the additive identity element,  $z + 0 = z$ ; unity is the multiplicative identity element,  $z(1) = z$ .
6. Inverse with respect to addition.  $z + (-z) = (x + iy) + (-x - iy) = (x - x) + i(y - y) = 0$ .

7. Inverse with respect to multiplication for nonzero numbers.  $zz^{-1} = 1$ , where

$$z^{-1} = \frac{1}{z} = \frac{1}{x + iy} = \frac{1}{x + iy} \frac{x - iy}{x - iy} = \frac{x - iy}{x^2 + y^2} = \frac{x}{x^2 + y^2} - i \frac{y}{x^2 + y^2}$$

**Properties of the complex conjugate.** Using the field properties of complex numbers, we can derive the following properties of the complex conjugate,  $\bar{z} = x - iy$ .

1.  $\overline{\bar{z}} = z$ ,

2.  $\overline{z + \zeta} = \bar{z} + \bar{\zeta}$ ,

3.  $\overline{z\zeta} = \bar{z}\bar{\zeta}$ ,

4.  $\overline{\left(\frac{z}{\zeta}\right)} = \frac{\bar{z}}{\bar{\zeta}}$ .

## 6.2 The Complex Plane

**Complex plane.** We can denote a complex number  $z = x + iy$  as an ordered pair of real numbers  $(x, y)$ . Thus we can represent a complex number as a point in  $\mathbb{R}^2$  where the first component is the real part and the second component is the imaginary part of  $z$ . This is called the *complex plane* or the *Argand diagram*. (See Figure 6.2.) A complex number written as  $z = x + iy$  is said to be in *Cartesian form*, or  *$a + ib$  form*.

Recall that there are two ways of describing a point in the complex plane: an ordered pair of coordinates  $(x, y)$  that give the horizontal and vertical offset from the origin or the distance  $r$  from the origin and the angle  $\theta$  from the positive horizontal axis. The angle  $\theta$  is not unique. It is only determined up to an additive integer multiple of  $2\pi$ .



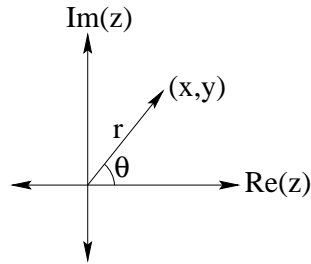

Figure 6.2: The complex plane.

**Modulus.** The *magnitude* or *modulus* of a complex number is the distance of the point from the origin. It is defined as  $|z| = |x + iy| = \sqrt{x^2 + y^2}$ . Note that  $z\bar{z} = (x + iy)(x - iy) = x^2 + y^2 = |z|^2$ . The modulus has the following properties.

1.  $|z\zeta| = |z| |\zeta|$
2.  $\left| \frac{z}{\zeta} \right| = \frac{|z|}{|\zeta|}$  for  $\zeta \neq 0$ .
3.  $|z + \zeta| \leq |z| + |\zeta|$
4.  $|z + \zeta| \geq ||z| - |\zeta||$

We could prove the first two properties by expanding in  $x + iy$  form, but it would be fairly messy. The proofs will become simple after polar form has been introduced. The second two properties follow from the triangle inequalities in geometry. This will become apparent after the relationship between complex numbers and vectors is introduced. One can show that

$$|z_1 z_2 \cdots z_n| = |z_1| |z_2| \cdots |z_n|$$

and

$$|z_1 + z_2 + \cdots + z_n| \leq |z_1| + |z_2| + \cdots + |z_n|$$

with proof by induction.

**Argument.** The *argument* of a complex number is the angle that the vector with tail at the origin and head at  $z = x + iy$  makes with the positive  $x$ -axis. The argument is denoted  $\arg(z)$ . Note that the argument is defined for all nonzero numbers and is only determined up to an additive integer multiple of  $2\pi$ . That is, the argument of a complex number is the set of values:  $\{\theta + 2\pi n \mid n \in \mathbb{Z}\}$ . The *principal argument* of a complex number is that angle in the set  $\arg(z)$  which lies in the range  $(-\pi, \pi]$ . The principal argument is denoted  $\text{Arg}(z)$ . We prove the following identities in Exercise 6.10.

$$\begin{aligned}\arg(z\zeta) &= \arg(z) + \arg(\zeta) \\ \text{Arg}(z\zeta) &\neq \text{Arg}(z) + \text{Arg}(\zeta) \\ \arg(z^2) &= \arg(z) + \arg(z) \neq 2\arg(z)\end{aligned}$$

**Example 6.2.1** Consider the equation  $|z - 1 - i| = 2$ . The set of points satisfying this equation is a circle of radius 2 and center at  $1 + i$  in the complex plane. You can see this by noting that  $|z - 1 - i|$  is the distance from the point  $(1, 1)$ . (See Figure 6.3.)

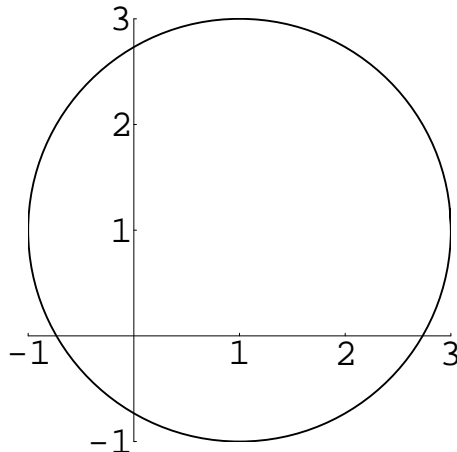

Figure 6.3: Solution of  $|z - 1 - i| = 2$ .

Another way to derive this is to substitute  $z = x + iy$  into the equation.

$$\begin{aligned}|x + iy - 1 - i| &= 2 \\ \sqrt{(x-1)^2 + (y-1)^2} &= 2 \\ (x-1)^2 + (y-1)^2 &= 4\end{aligned}$$

This is the analytic geometry equation for a circle of radius 2 centered about  $(1, 1)$ .

**Example 6.2.2** Consider the curve described by

$$|z| + |z - 2| = 4.$$

Note that  $|z|$  is the distance from the origin in the complex plane and  $|z - 2|$  is the distance from  $z = 2$ . The equation is

$$(\text{distance from } (0, 0)) + (\text{distance from } (2, 0)) = 4.$$

From geometry, we know that this is an ellipse with foci at  $(0, 0)$  and  $(2, 0)$ , major axis 2, and minor axis  $\sqrt{3}$ . (See Figure 6.4.)

We can use the substitution  $z = x + iy$  to get the equation in algebraic form.

$$\begin{aligned}|z| + |z - 2| &= 4 \\ |x + iy| + |x + iy - 2| &= 4 \\ \sqrt{x^2 + y^2} + \sqrt{(x-2)^2 + y^2} &= 4 \\ x^2 + y^2 &= 16 - 8\sqrt{(x-2)^2 + y^2} + x^2 - 4x + 4 + y^2 \\ x - 5 &= -2\sqrt{(x-2)^2 + y^2} \\ x^2 - 10x + 25 &= 4x^2 - 16x + 16 + 4y^2 \\ \frac{1}{4}(x-1)^2 + \frac{1}{3}y^2 &= 1\end{aligned}$$

Thus we have the standard form for an equation describing an ellipse.

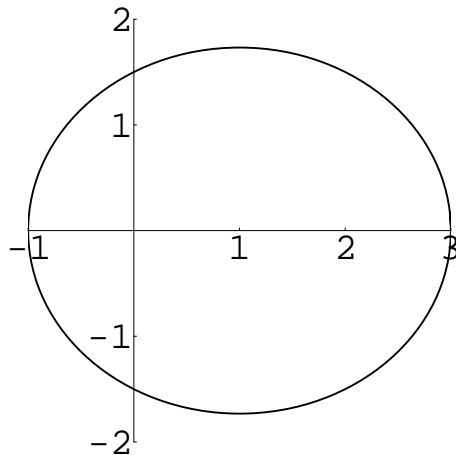

Figure 6.4: Solution of  $|z| + |z - 2| = 4$ .

## 6.3 Polar Form

**Polar form.** A complex number written in Cartesian form,  $z = x + iy$ , can be converted *polar form*,  $z = r(\cos \theta + i \sin \theta)$ , using trigonometry. Here  $r = |z|$  is the modulus and  $\theta = \arctan(x, y)$  is the argument of  $z$ . The argument is the angle between the  $x$  axis and the vector with its head at  $(x, y)$ . (See Figure 6.5.) Note that  $\theta$  is not unique. If  $z = r(\cos \theta + i \sin \theta)$  then  $z = r(\cos(\theta + 2n\pi) + i \sin(\theta + 2n\pi))$  for any  $n \in \mathbb{Z}$ .

**The arctangent.** Note that  $\arctan(x, y)$  is not the same thing as the old arctangent that you learned about in trigonometry  $\arctan(x, y)$  is sensitive to the quadrant of the point  $(x, y)$ , while  $\arctan\left(\frac{y}{x}\right)$  is not. For example,

$$\arctan(1, 1) = \frac{\pi}{4} + 2n\pi \quad \text{and} \quad \arctan(-1, -1) = \frac{-3\pi}{4} + 2n\pi,$$

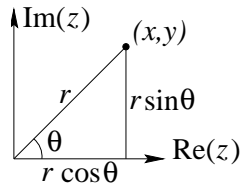

Figure 6.5: Polar form.

whereas

$$\arctan\left(\frac{-1}{-1}\right) = \arctan\left(\frac{1}{1}\right) = \arctan(1).$$

**Euler's formula.** *Euler's formula*,  $e^{i\theta} = \cos\theta + i\sin\theta$ ,<sup>5</sup> allows us to write the polar form more compactly. Expressing the polar form in terms of the exponential function of imaginary argument makes arithmetic with complex numbers much more convenient.

$$z = r(\cos\theta + i\sin\theta) = r e^{i\theta}$$

The exponential of an imaginary argument has all the nice properties that we know from studying functions of a real variable, like  $e^{ia} e^{ib} = e^{i(a+b)}$ . Later on we will introduce the exponential of a complex number.

Using Euler's Formula, we can express the cosine and sine in terms of the exponential.

$$\begin{aligned} \frac{e^{i\theta} + e^{-i\theta}}{2} &= \frac{(\cos(\theta) + i\sin(\theta)) + (\cos(-\theta) + i\sin(-\theta))}{2} = \cos(\theta) \\ \frac{e^{i\theta} - e^{-i\theta}}{i2} &= \frac{(\cos(\theta) + i\sin(\theta)) - (\cos(-\theta) + i\sin(-\theta))}{i2} = \sin(\theta) \end{aligned}$$

**Arithmetic with complex numbers.** Note that it is convenient to add complex numbers in Cartesian form.

$$z + \zeta = (x + iy) + (\xi + i\psi) = (x + \xi) + i(y + \psi)$$

<sup>5</sup> See Exercise 6.17 for justification of Euler's formula.

However, it is difficult to multiply or divide them in Cartesian form.

$$z\zeta = (x + iy)(\xi + i\psi) = (x\xi - y\psi) + i(x\psi + \xi y)$$

$$\frac{z}{\zeta} = \frac{x + iy}{\xi + i\psi} = \frac{(x + iy)(\xi - i\psi)}{(\xi + i\psi)(\xi - i\psi)} = \frac{x\xi + y\psi}{\xi^2 + \psi^2} + i\frac{\xi y - x\psi}{\xi^2 + \psi^2}$$

On the other hand, it is difficult to add complex numbers in polar form.

$$z + \zeta = r e^{i\theta} + \rho e^{i\phi}$$

$$= r(\cos \theta + i \sin \theta) + \rho(\cos \phi + i \sin \phi)$$

$$= r \cos \theta + \rho \cos \phi + i(r \sin \theta + \rho \sin \phi)$$

$$= \sqrt{(r \cos \theta + \rho \cos \phi)^2 + (r \sin \theta + \rho \sin \phi)^2}$$

$$\quad \times e^{i \arctan(r \cos \theta + \rho \cos \phi, r \sin \theta + \rho \sin \phi)}$$

$$= \sqrt{r^2 + \rho^2 + 2 \cos(\theta - \phi)} e^{i \arctan(r \cos \theta + \rho \cos \phi, r \sin \theta + \rho \sin \phi)}$$

However, it is convenient to multiply and divide them in polar form.

$$z\zeta = r e^{i\theta} \rho e^{i\phi} = r\rho e^{i(\theta+\phi)}$$

$$\frac{z}{\zeta} = \frac{r e^{i\theta}}{\rho e^{i\phi}} = \frac{r}{\rho} e^{i(\theta-\phi)}$$

Keeping this in mind will make working with complex numbers a shade or two less grungy.

**Result 6.3.1** Euler's formula is

$$e^{i\theta} = \cos \theta + i \sin \theta.$$

We can write the cosine and sine in terms of the exponential.

$$\cos(\theta) = \frac{e^{i\theta} + e^{-i\theta}}{2}, \quad \sin(\theta) = \frac{e^{i\theta} - e^{-i\theta}}{i2}$$

To change between Cartesian and polar form, use the identities

$$\begin{aligned} r e^{i\theta} &= r \cos \theta + i r \sin \theta, \\ x + iy &= \sqrt{x^2 + y^2} e^{i \arctan(x,y)}. \end{aligned}$$

Cartesian form is convenient for addition. Polar form is convenient for multiplication and division.

**Example 6.3.1** We write  $5 + i7$  in polar form.

$$5 + i7 = \sqrt{74} e^{i \arctan(5,7)}$$

We write  $2 e^{i\pi/6}$  in Cartesian form.

$$\begin{aligned} 2 e^{i\pi/6} &= 2 \cos\left(\frac{\pi}{6}\right) + 2i \sin\left(\frac{\pi}{6}\right) \\ &= \sqrt{3} + i \end{aligned}$$

**Example 6.3.2** We will prove the trigonometric identity

$$\cos^4 \theta = \frac{1}{8} \cos(4\theta) + \frac{1}{2} \cos(2\theta) + \frac{3}{8}.$$

We start by writing the cosine in terms of the exponential.

$$\begin{aligned}\cos^4 \theta &= \left( \frac{e^{i\theta} + e^{-i\theta}}{2} \right)^4 \\ &= \frac{1}{16} (e^{i4\theta} + 4e^{i2\theta} + 6 + 4e^{-i2\theta} + e^{-i4\theta}) \\ &= \frac{1}{8} \left( \frac{e^{i4\theta} + e^{-i4\theta}}{2} \right) + \frac{1}{2} \left( \frac{e^{i2\theta} + e^{-i2\theta}}{2} \right) + \frac{3}{8} \\ &= \frac{1}{8} \cos(4\theta) + \frac{1}{2} \cos(2\theta) + \frac{3}{8}\end{aligned}$$

By the definition of exponentiation, we have  $e^{n\theta} = (e^{i\theta})^n$ . We apply Euler's formula to obtain a result which is useful in deriving trigonometric identities.

$$\cos(n\theta) + i \sin(n\theta) = (\cos \theta + i \sin \theta)^n$$

**Result 6.3.2 DeMoivre's Theorem.**<sup>a</sup>

$$\cos(n\theta) + i \sin(n\theta) = (\cos \theta + i \sin \theta)^n$$

<sup>a</sup>It's amazing what passes for a theorem these days. I would think that this would be a corollary at most.

**Example 6.3.3** We will express  $\cos(5\theta)$  in terms of  $\cos \theta$  and  $\sin(5\theta)$  in terms of  $\sin \theta$ . We start with DeMoivre's theorem.

$$e^{i5\theta} = (e^{i\theta})^5$$



$$\begin{aligned}
\cos(5\theta) + i \sin(5\theta) &= (\cos \theta + i \sin \theta)^5 \\
&= \binom{5}{0} \cos^5 \theta + i \binom{5}{1} \cos^4 \theta \sin \theta - \binom{5}{2} \cos^3 \theta \sin^2 \theta - i \binom{5}{3} \cos^2 \theta \sin^3 \theta \\
&\quad + \binom{5}{4} \cos \theta \sin^4 \theta + i \binom{5}{5} \sin^5 \theta \\
&= (\cos^5 \theta - 10 \cos^3 \theta \sin^2 \theta + 5 \cos \theta \sin^4 \theta) + i (5 \cos^4 \theta \sin \theta - 10 \cos^2 \theta \sin^3 \theta + \sin^5 \theta)
\end{aligned}$$

Then we equate the real and imaginary parts.

$$\begin{aligned}
\cos(5\theta) &= \cos^5 \theta - 10 \cos^3 \theta \sin^2 \theta + 5 \cos \theta \sin^4 \theta \\
\sin(5\theta) &= 5 \cos^4 \theta \sin \theta - 10 \cos^2 \theta \sin^3 \theta + \sin^5 \theta
\end{aligned}$$

Finally we use the Pythagorean identity,  $\cos^2 \theta + \sin^2 \theta = 1$ .

$$\cos(5\theta) = \cos^5 \theta - 10 \cos^3 \theta (1 - \cos^2 \theta) + 5 \cos \theta (1 - \cos^2 \theta)^2$$

$$\boxed{\cos(5\theta) = 16 \cos^5 \theta - 20 \cos^3 \theta + 5 \cos \theta}$$

$$\sin(5\theta) = 5 (1 - \sin^2 \theta)^2 \sin \theta - 10 (1 - \sin^2 \theta) \sin^3 \theta + \sin^5 \theta$$

$$\boxed{\sin(5\theta) = 16 \sin^5 \theta - 20 \sin^3 \theta + 5 \sin \theta}$$

## 6.4 Arithmetic and Vectors

**Addition.** We can represent the complex number  $z = x + iy = r e^{i\theta}$  as a vector in Cartesian space with tail at the origin and head at  $(x, y)$ , or equivalently, the vector of length  $r$  and angle  $\theta$ . With the vector representation, we can add complex numbers by connecting the tail of one vector to the head of the other. The vector  $z + \zeta$  is the diagonal of the parallelogram defined by  $z$  and  $\zeta$ . (See Figure 6.6.)

**Negation.** The negative of  $z = x + iy$  is  $-z = -x - iy$ . In polar form we have  $z = r e^{i\theta}$  and  $-z = r e^{i(\theta+\pi)}$ , (more generally,  $z = r e^{i(\theta+(2n+1)\pi)}$ ,  $n \in \mathbb{Z}$ ). In terms of vectors,  $-z$  has the same magnitude but opposite direction as  $z$ . (See Figure 6.6.)

**Multiplication.** The product of  $z = r e^{i\theta}$  and  $\zeta = \rho e^{i\phi}$  is  $z\zeta = r\rho e^{i(\theta+\phi)}$ . The length of the vector  $z\zeta$  is the product of the lengths of  $z$  and  $\zeta$ . The angle of  $z\zeta$  is the sum of the angles of  $z$  and  $\zeta$ . (See Figure 6.6.)

Note that  $\arg(z\zeta) = \arg(z) + \arg(\zeta)$ . Each of these arguments has an infinite number of values. If we write out the multi-valuedness explicitly, we have

$$\{\theta + \phi + 2\pi n : n \in \mathbb{Z}\} = \{\theta + 2\pi n : n \in \mathbb{Z}\} + \{\phi + 2\pi n : n \in \mathbb{Z}\}$$

The same is not true of the principal argument. In general,  $\text{Arg}(z\zeta) \neq \text{Arg}(z) + \text{Arg}(\zeta)$ . Consider the case  $z = \zeta = e^{i3\pi/4}$ . Then  $\text{Arg}(z) = \text{Arg}(\zeta) = 3\pi/4$ , however,  $\text{Arg}(z\zeta) = -\pi/2$ .

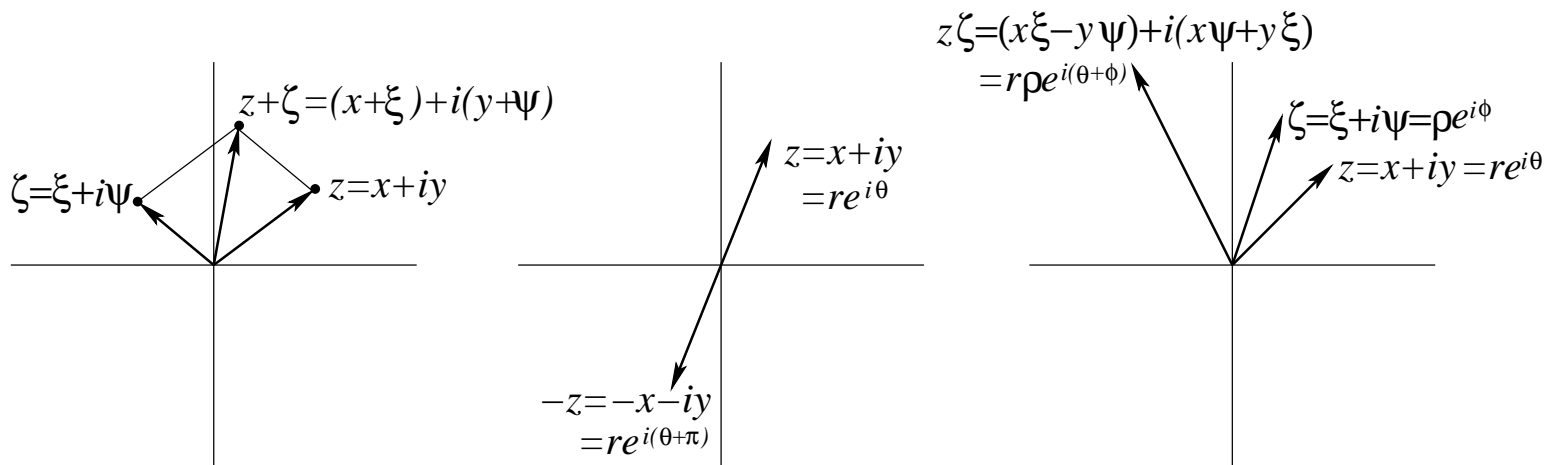

Figure 6.6: Addition, negation and multiplication.

**Multiplicative inverse.** Assume that  $z$  is nonzero. The multiplicative inverse of  $z = r e^{i\theta}$  is  $\frac{1}{z} = \frac{1}{r} e^{-i\theta}$ . The length of  $\frac{1}{z}$  is the multiplicative inverse of the length of  $z$ . The angle of  $\frac{1}{z}$  is the negative of the angle of  $z$ . (See Figure 6.7.)

**Division.** Assume that  $\zeta$  is nonzero. The quotient of  $z = r e^{i\theta}$  and  $\zeta = \rho e^{i\phi}$  is  $\frac{z}{\zeta} = \frac{r}{\rho} e^{i(\theta-\phi)}$ . The length of the vector  $\frac{z}{\zeta}$  is the quotient of the lengths of  $z$  and  $\zeta$ . The angle of  $\frac{z}{\zeta}$  is the difference of the angles of  $z$  and  $\zeta$ . (See Figure 6.7.)

**Complex conjugate.** The complex conjugate of  $z = x + iy = r e^{i\theta}$  is  $\bar{z} = x - iy = r e^{-i\theta}$ .  $\bar{z}$  is the mirror image of  $z$ , reflected across the  $x$  axis. In other words,  $\bar{z}$  has the same magnitude as  $z$  and the angle of  $\bar{z}$  is the negative of the angle of  $z$ . (See Figure 6.7.)

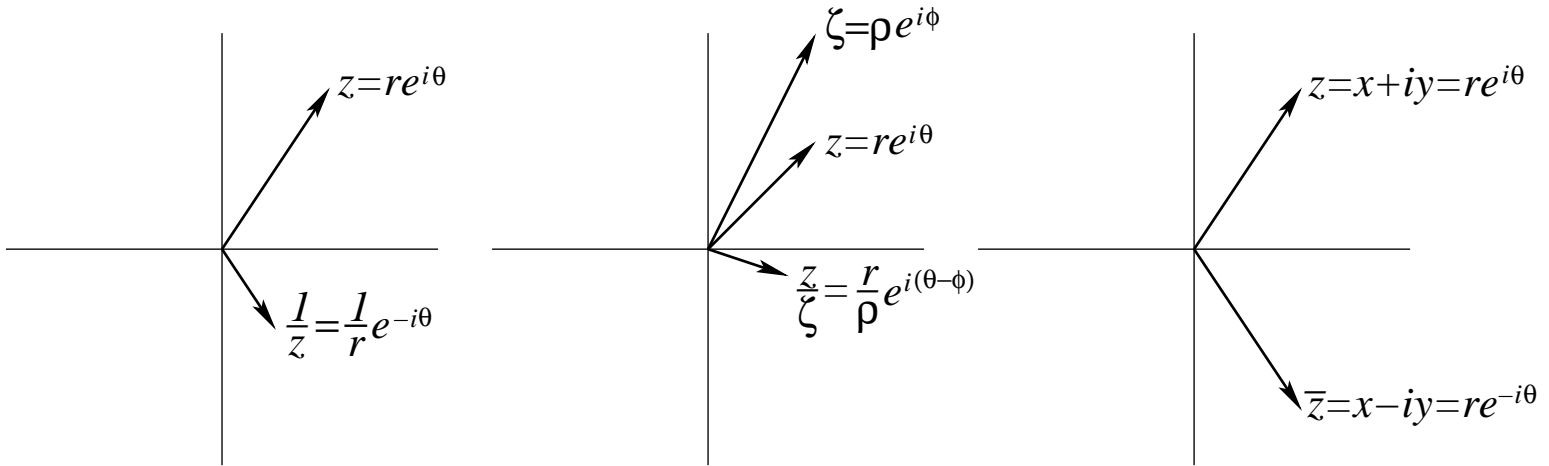

Figure 6.7: Multiplicative inverse, division and complex conjugate.

## 6.5 Integer Exponents

Consider the product  $(a + b)^n$ ,  $n \in \mathbb{Z}$ . If we know  $\arctan(a, b)$  then it will be most convenient to expand the product working in polar form. If not, we can write  $n$  in base 2 to efficiently do the multiplications.

**Example 6.5.1** Suppose that we want to write  $(\sqrt{3} + i)^{20}$  in Cartesian form.<sup>6</sup> We can do the multiplication directly. Note that 20 is 10100 in base 2. That is,  $20 = 2^4 + 2^2$ . We first calculate the powers of the form  $(\sqrt{3} + i)^{2^n}$  by successive squaring:

$$\begin{aligned}(\sqrt{3} + i)^2 &= 2 + i2\sqrt{3} \\(\sqrt{3} + i)^4 &= -8 + i8\sqrt{3} \\(\sqrt{3} + i)^8 &= -128 - i128\sqrt{3} \\(\sqrt{3} + i)^{16} &= -32768 + i32768\sqrt{3}\end{aligned}$$

Next we multiply  $(\sqrt{3} + i)^4$  and  $(\sqrt{3} + i)^{16}$  to obtain the answer.

$$(\sqrt{3} + i)^{20} = (-32768 + i32768\sqrt{3})(-8 + i8\sqrt{3}) = -524288 - i524288\sqrt{3}$$

Since we know that  $\arctan(\sqrt{3}, 1) = \pi/6$ , it is easiest to do this problem by first changing to modulus-argument form.

$$\begin{aligned}(\sqrt{3} + i)^{20} &= \left( \sqrt{(\sqrt{3})^2 + 1^2} e^{i\arctan(\sqrt{3},1)} \right)^{20} \\&= (2 e^{i\pi/6})^{20} \\&= 2^{20} e^{i4\pi/3} \\&= 1048576 \left( -\frac{1}{2} - i\frac{\sqrt{3}}{2} \right) \\&= -524288 - i524288\sqrt{3}\end{aligned}$$

---

<sup>6</sup>No, I have no idea why we would want to do that. Just humor me. If you pretend that you're interested, I'll do the same. Believe me, expressing your real feelings here isn't going to do anyone any good.

**Example 6.5.2** Consider  $(5 + i7)^{11}$ . We will do the exponentiation in polar form and write the result in Cartesian form.

$$\begin{aligned}(5 + i7)^{11} &= \left(\sqrt{74} e^{i \arctan(5,7)}\right)^{11} \\ &= 74^5 \sqrt{74} (\cos(11 \arctan(5, 7)) + i \sin(11 \arctan(5, 7))) \\ &= 2219006624 \sqrt{74} \cos(11 \arctan(5, 7)) + i 2219006624 \sqrt{74} \sin(11 \arctan(5, 7))\end{aligned}$$

The result is correct, but not very satisfying. This expression could be simplified. You could evaluate the trigonometric functions with some fairly messy trigonometric identities. This would take much more work than directly multiplying  $(5 + i7)^{11}$ .

## 6.6 Rational Exponents

In this section we consider complex numbers with rational exponents,  $z^{p/q}$ , where  $p/q$  is a rational number. First we consider unity raised to the  $1/n$  power. We define  $1^{1/n}$  as the set of numbers  $\{z\}$  such that  $z^n = 1$ .

$$1^{1/n} = \{z \mid z^n = 1\}$$

We can find these values by writing  $z$  in modulus-argument form.

$$\begin{aligned}z^n &= 1 \\ r^n e^{in\theta} &= 1 \\ r^n = 1 \quad n\theta &= 0 \pmod{2\pi} \\ r = 1 \quad \theta &= 2\pi k \text{ for } k \in \mathbb{Z} \\ 1^{1/n} &= \{e^{i2\pi k/n} \mid k \in \mathbb{Z}\}\end{aligned}$$

There are only  $n$  distinct values as a result of the  $2\pi$  periodicity of  $e^{i\theta}$ .  $e^{i2\pi} = e^{i0}$ .

$$1^{1/n} = \{e^{i2\pi k/n} \mid k = 0, \dots, n-1\}$$

These values are equally spaced points on the unit circle in the complex plane.

**Example 6.6.1**  $1^{1/6}$  has the 6 values,

$$\{e^{i0}, e^{i\pi/3}, e^{i2\pi/3}, e^{i\pi}, e^{i4\pi/3}, e^{i5\pi/3}\}.$$

In Cartesian form this is

$$\left\{1, \frac{1 + i\sqrt{3}}{2}, \frac{-1 + i\sqrt{3}}{2}, -1, \frac{-1 - i\sqrt{3}}{2}, \frac{1 - i\sqrt{3}}{2}\right\}.$$

The sixth roots of unity are plotted in Figure 6.8.

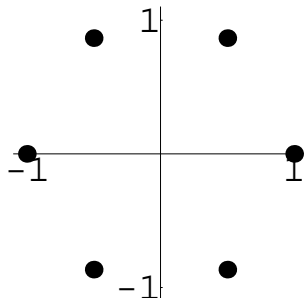

Figure 6.8: The sixth roots of unity.

The  $n^{\text{th}}$  roots of the complex number  $c = \alpha e^{i\beta}$  are the set of numbers  $z = r e^{i\theta}$  such that

$$z^n = c = \alpha e^{i\beta}$$

$$r^n e^{in\theta} = \alpha e^{i\beta}$$

$$r = \sqrt[n]{\alpha} \quad n\theta = \beta \pmod{2\pi}$$

$$r = \sqrt[n]{\alpha} \quad \theta = (\beta + 2\pi k)/n \text{ for } k = 0, \dots, n-1.$$

Thus

$$c^{1/n} = \left\{ \sqrt[n]{\alpha} e^{i(\beta+2\pi k)/n} \mid k = 0, \dots, n-1 \right\} = \left\{ \sqrt[n]{|c|} e^{i(\text{Arg}(c)+2\pi k)/n} \mid k = 0, \dots, n-1 \right\}$$

**Principal roots.** The *principal*  $n^{\text{th}}$  root is denoted

$$\sqrt[n]{z} \equiv \sqrt[n]{r} e^{i \text{Arg}(z)/n} .$$

Thus the principal root has the property

$$-\pi/n < \text{Arg} \left( \sqrt[n]{z} \right) \leq \pi/n .$$

This is consistent with the notation from functions of a real variable:  $\sqrt[n]{x}$  denotes the positive  $n^{\text{th}}$  root of a positive real number. We adopt the convention that  $z^{1/n}$  denotes the  $n^{\text{th}}$  roots of  $z$ , which is a set of  $n$  numbers and  $\sqrt[n]{z}$  is the principal  $n^{\text{th}}$  root of  $z$ , which is a single number. The  $n^{\text{th}}$  roots of  $z$  are the principal  $n^{\text{th}}$  root of  $z$  times the  $n^{\text{th}}$  roots of unity.

$$\begin{aligned} z^{1/n} &= \left\{ \sqrt[n]{r} e^{i(\text{Arg}(z)+2\pi k)/n} \mid k = 0, \dots, n-1 \right\} \\ z^{1/n} &= \left\{ \sqrt[n]{z} e^{i2\pi k/n} \mid k = 0, \dots, n-1 \right\} \\ z^{1/n} &= \sqrt[n]{z} 1^{1/n} \end{aligned}$$

**Rational exponents.** We interpret  $z^{p/q}$  to mean  $z^{(p/q)}$ . That is, we first simplify the exponent, i.e. reduce the fraction, before carrying out the exponentiation. Therefore  $z^{2/4} = z^{1/2}$  and  $z^{10/5} = z^2$ . If  $p/q$  is a reduced fraction, ( $p$  and  $q$  are relatively prime, in other words, they have no common factors), then

$$z^{p/q} \equiv (z^p)^{1/q} .$$

Thus  $z^{p/q}$  is a set of  $q$  values. Note that for an un-reduced fraction  $r/s$ ,

$$(z^r)^{1/s} \neq (z^{1/s})^r .$$

The former expression is a set of  $s$  values while the latter is a set of no more than  $s$  values. For instance,  $(1^2)^{1/2} = 1^{1/2} = \pm 1$  and  $(1^{1/2})^2 = (\pm 1)^2 = 1$ .

**Example 6.6.2** Consider  $2^{1/5}$ ,  $(1+i)^{1/3}$  and  $(2+i)^{5/6}$ .

$$2^{1/5} = \sqrt[5]{2} e^{i2\pi k/5}, \quad \text{for } k = 0, 1, 2, 3, 4$$

$$\begin{aligned}
(1 + i)^{1/3} &= \left(\sqrt{2} e^{i\pi/4}\right)^{1/3} \\
&= \sqrt[6]{2} e^{i\pi/12} e^{i2\pi k/3}, \quad \text{for } k = 0, 1, 2
\end{aligned}$$

$$\begin{aligned}
(2 + i)^{5/6} &= \left(\sqrt{5} e^{i \operatorname{Arctan}(2,1)}\right)^{5/6} \\
&= \left(\sqrt{5^5} e^{i5 \operatorname{Arctan}(2,1)}\right)^{1/6} \\
&= \sqrt[12]{5^5} e^{i\frac{5}{6} \operatorname{Arctan}(2,1)} e^{i\pi k/3}, \quad \text{for } k = 0, 1, 2, 3, 4, 5
\end{aligned}$$

**Example 6.6.3** We find the roots of  $z^5 + 4$ .

$$\begin{aligned}
(-4)^{1/5} &= (4 e^{i\pi})^{1/5} \\
&= \sqrt[5]{4} e^{i\pi(1+2k)/5}, \quad \text{for } k = 0, 1, 2, 3, 4
\end{aligned}$$



## 6.7 Exercises

### Complex Numbers

#### Exercise 6.1

If  $z = x + iy$ , write the following in the form  $a + ib$ :

1.  $(1 + i2)^7$

2.  $\frac{1}{(\overline{z\overline{z}})}$

3.  $\frac{iz + \overline{z}}{(3 + i)^9}$

Hint, Solution

#### Exercise 6.2

Verify that:

1.  $\frac{1 + i2}{3 - i4} + \frac{2 - i}{i5} = -\frac{2}{5}$

2.  $(1 - i)^4 = -4$

Hint, Solution

#### Exercise 6.3

Write the following complex numbers in the form  $a + ib$ .

1.  $(1 + i\sqrt{3})^{-10}$

2.  $(11 + i4)^2$

Hint, Solution

### Exercise 6.4

Write the following complex numbers in the form  $a + ib$

1.  $\left(\frac{2+i}{i6 - (1-i2)}\right)^2$

2.  $(1-i)^7$

Hint, Solution

### Exercise 6.5

If  $z = x + iy$ , write the following in the form  $u(x, y) + v(x, y)$ .

1.  $\overline{\left(\frac{\bar{z}}{z}\right)}$

2.  $\frac{z + i2}{2 - i\bar{z}}$

Hint, Solution

### Exercise 6.6

Quaternions are sometimes used as a generalization of complex numbers. A quaternion  $u$  may be defined as

$$u = u_0 + uu_1 + ju_2 + ku_3$$

where  $u_0, u_1, u_2$  and  $u_3$  are real numbers and  $i, j$  and  $k$  are objects which satisfy

$$i^2 = j^2 = k^2 = -1, \quad ij = k, \quad ju = -k$$

and the usual associative and distributive laws. Show that for any quaternions  $u, w$  there exists a quaternion  $v$  such that

$$uv = w$$

except for the case  $u_0 = u_1 = u_2 = u_3$ .

Hint, Solution

### Exercise 6.7

Let  $\alpha \neq 0$ ,  $\beta \neq 0$  be two complex numbers. Show that  $\alpha = t\beta$  for some real number  $t$  (i.e. the vectors defined by  $\alpha$  and  $\beta$  are parallel) if and only if  $\Im(\alpha\bar{\beta}) = 0$ .

[Hint](#), [Solution](#)

## The Complex Plane

### Exercise 6.8

Find and depict all values of

1.  $(1 + i)^{1/3}$
2.  $i^{1/4}$

Identify the principal root.

[Hint](#), [Solution](#)

### Exercise 6.9

Sketch the regions of the complex plane:

1.  $|\Re(z)| + 2|\Im(z)| \leq 1$
2.  $1 \leq |z - i| \leq 2$
3.  $|z - i| \leq |z + i|$

[Hint](#), [Solution](#)

### Exercise 6.10

Prove the following identities.

1.  $\arg(z\zeta) = \arg(z) + \arg(\zeta)$
2.  $\text{Arg}(z\zeta) \neq \text{Arg}(z) + \text{Arg}(\zeta)$

$$3. \arg(z^2) = \arg(z) + \arg(z) \neq 2\arg(z)$$

Hint, Solution

### Exercise 6.11

Show, both by geometric and algebraic arguments, that for complex numbers  $z$  and  $\zeta$  the inequalities

$$||z| - |\zeta|| \leq |z + \zeta| \leq |z| + |\zeta|$$

hold.

Hint, Solution

### Exercise 6.12

Find all the values of

1.  $(-1)^{-3/4}$

2.  $8^{1/6}$

and show them graphically.

Hint, Solution

### Exercise 6.13

Find all values of

1.  $(-1)^{-1/4}$

2.  $16^{1/8}$

and show them graphically.

Hint, Solution

### Exercise 6.14

Sketch the regions or curves described by

1.  $1 < |z - i2| < 2$
2.  $|\Re(z)| + 5|\Im(z)| = 1$
3.  $|z - i| = |z + i|$

Hint, Solution

### Exercise 6.15

Sketch the regions or curves described by

1.  $|z - 1 + i| \leq 1$
2.  $\Re(z) - \Im(z) = 5$
3.  $|z - i| + |z + i| = 1$

Hint, Solution

### Exercise 6.16

Solve the equation

$$|e^{i\theta} - 1| = 2$$

for  $\theta$  ( $0 \leq \theta \leq \pi$ ) and verify the solution geometrically.

Hint, Solution

## Polar Form

### Exercise 6.17

Show that Euler's formula,  $e^{i\theta} = \cos \theta + i \sin \theta$ , is formally consistent with the standard Taylor series expansions for the real functions  $e^x$ ,  $\cos x$  and  $\sin x$ . Consider the Taylor series of  $e^x$  about  $x = 0$  to be the definition of the exponential function for complex argument.

Hint, Solution

### Exercise 6.18

Use de Moivre's formula to derive the trigonometric identity

$$\cos(3\theta) = \cos^3(\theta) - 3\cos(\theta)\sin^2(\theta).$$

**Hint, Solution**

### Exercise 6.19

Establish the formula

$$1 + z + z^2 + \cdots + z^n = \frac{1 - z^{n+1}}{1 - z}, \quad (z \neq 1),$$

for the sum of a finite geometric series; then derive the formulas

- $1 + \cos(\theta) + \cos(2\theta) + \cdots + \cos(n\theta) = \frac{1}{2} + \frac{\sin((n+1/2)\theta)}{2\sin(\theta/2)}$
- $\sin(\theta) + \sin(2\theta) + \cdots + \sin(n\theta) = \frac{1}{2} \cot \frac{\theta}{2} - \frac{\cos((n+1/2)\theta)}{2\sin(\theta/2)}$

where  $0 < \theta < 2\pi$ .

**Hint, Solution**

## Arithmetic and Vectors

### Exercise 6.20

Prove  $|z\zeta| = |z||\zeta|$  and  $\left|\frac{z}{\zeta}\right| = \frac{|z|}{|\zeta|}$  using polar form.

**Hint, Solution**

### Exercise 6.21

Prove that

$$|z + \zeta|^2 + |z - \zeta|^2 = 2(|z|^2 + |\zeta|^2).$$

Interpret this geometrically.

**Hint, Solution**

## Integer Exponents

### Exercise 6.22

Write  $(1 + i)^{10}$  in Cartesian form with the following two methods:

1. Just do the multiplication. If it takes you more than four multiplications, you suck.
2. Do the multiplication in polar form.

Hint, Solution

## Rational Exponents

### Exercise 6.23

Show that each of the numbers  $z = -a + (a^2 - b)^{1/2}$  satisfies the equation  $z^2 + 2az + b = 0$ .

Hint, Solution

## 6.8 Hints

### Complex Numbers

Hint 6.1

Hint 6.2

Hint 6.3

Hint 6.4

Hint 6.5

Hint 6.6

Hint 6.7

### The Complex Plane

Hint 6.8

Hint 6.9



**Hint 6.10**

Write the multivaluedness explicitly.

**Hint 6.11**

Consider a triangle with vertices at  $0$ ,  $z$  and  $z + \zeta$ .

**Hint 6.12****Hint 6.13****Hint 6.14****Hint 6.15****Hint 6.16****Polar Form****Hint 6.17**

Find the Taylor series of  $e^{i\theta}$ ,  $\cos \theta$  and  $\sin \theta$ . Note that  $i^{2n} = (-1)^n$ .

**Hint 6.18****Hint 6.19****Arithmetic and Vectors**

**Hint 6.20**

$$|e^{i\theta}| = 1.$$

**Hint 6.21**

Consider the parallelogram defined by  $z$  and  $\zeta$ .

**Integer Exponents****Hint 6.22**

For the first part,

$$(1 + i)^{10} = \left( \left( (1 + i)^2 \right)^2 \right)^2 (1 + i)^2.$$

**Rational Exponents****Hint 6.23**

Substitute the numbers into the equation.

## 6.9 Solutions

### Complex Numbers

#### Solution 6.1

1. We can do the exponentiation by directly multiplying.

$$\begin{aligned}(1 + i2)^7 &= (1 + i2)(1 + i2)^2(1 + i2)^4 \\ &= (1 + i2)(-3 + i4)(-3 + i4)^2 \\ &= (11 - i2)(-7 - i24) \\ &= 29 + i278\end{aligned}$$

We can also do the problem using De Moivre's Theorem.

$$\begin{aligned}(1 + i2)^7 &= \left(\sqrt{5} e^{i \arctan(1,2)}\right)^7 \\ &= 125\sqrt{5} e^{i7 \arctan(1,2)} \\ &= 125\sqrt{5} \cos(7 \arctan(1, 2)) + i125\sqrt{5} \sin(7 \arctan(1, 2))\end{aligned}$$

- 2.

$$\begin{aligned}\frac{1}{(\bar{z}\bar{z})} &= \frac{1}{(x - iy)^2} \\ &= \frac{1}{(x - iy)^2} \frac{(x + iy)^2}{(x + iy)^2} \\ &= \frac{(x + iy)^2}{(x^2 + y^2)^2} \\ &= \frac{x^2 - y^2}{(x^2 + y^2)^2} + i \frac{2xy}{(x^2 + y^2)^2}\end{aligned}$$

3. We can evaluate the expression using De Moivre's Theorem.

$$\begin{aligned}\frac{\iota z + \bar{z}}{(3 + \iota)^9} &= (-y + \iota x + x - \iota y)(3 + \iota)^{-9} \\ &= (1 + \iota)(x - y) \left( \sqrt{10} e^{\iota \arctan(3,1)} \right)^{-9} \\ &= (1 + \iota)(x - y) \frac{1}{10000\sqrt{10}} e^{-\iota 9 \arctan(3,1)} \\ &= \frac{(1 + \iota)(x - y)}{10000\sqrt{10}} (\cos(9 \arctan(3, 1)) - \iota \sin(9 \arctan(3, 1))) \\ &= \frac{(x - y)}{10000\sqrt{10}} (\cos(9 \arctan(3, 1)) + \sin(9 \arctan(3, 1))) \\ &\quad + \iota \frac{(x - y)}{10000\sqrt{10}} (\cos(9 \arctan(3, 1)) - \sin(9 \arctan(3, 1)))\end{aligned}$$

We can also do this problem by directly multiplying but it's a little grungy.

$$\begin{aligned}
 \frac{iz + \bar{z}}{(3+i)^9} &= \frac{(-y + ix + x - iy)(3-i)^9}{10^9} \\
 &= \frac{(1+i)(x-y)(3-i) \left( ((3-i)^2)^2 \right)^2}{10^9} \\
 &= \frac{(1+i)(x-y)(3-i) ((8-i6)^2)^2}{10^9} \\
 &= \frac{(1+i)(x-y)(3-i)(28-i96)^2}{10^9} \\
 &= \frac{(1+i)(x-y)(3-i)(-8432-i5376)}{10^9} \\
 &= \frac{(x-y)(-22976-i38368)}{10^9} \\
 &= \frac{359(y-x)}{15625000} + i \frac{1199(y-x)}{31250000}
 \end{aligned}$$

## Solution 6.2

1.

$$\begin{aligned}
 \frac{1+i2}{3-i4} + \frac{2-i}{i5} &= \frac{1+i2}{3-i4} \frac{3+i4}{3+i4} + \frac{2-i-i}{i5} \frac{-i}{-i} \\
 &= \frac{-5+i10}{25} + \frac{-1-i2}{5} \\
 &= -\frac{2}{5}
 \end{aligned}$$

2.

$$(1-i)^4 = (-i2)^2 = -4$$

### Solution 6.3

1. First we do the multiplication in Cartesian form.

$$\begin{aligned}(1 + i\sqrt{3})^{-10} &= \left( (1 + i\sqrt{3})^2 (1 + i\sqrt{3})^8 \right)^{-1} \\ &= \left( (-2 + i2\sqrt{3}) (-2 + i2\sqrt{3})^4 \right)^{-1} \\ &= \left( (-2 + i2\sqrt{3}) (-8 - i8\sqrt{3})^2 \right)^{-1} \\ &= \left( (-2 + i2\sqrt{3}) (-128 + i128\sqrt{3}) \right)^{-1} \\ &= (-512 - i512\sqrt{3})^{-1} \\ &= \frac{1}{512} \frac{-1}{1 + i\sqrt{3}} \\ &= \frac{1}{512} \frac{-1}{1 + i\sqrt{3}} \frac{1 - i\sqrt{3}}{1 - i\sqrt{3}} \\ &= -\frac{1}{2048} + i\frac{\sqrt{3}}{2048}\end{aligned}$$

Now we do the multiplication in modulus-argument, (polar), form.

$$\begin{aligned}\left(1 + i\sqrt{3}\right)^{-10} &= \left(2 e^{i\pi/3}\right)^{-10} \\ &= 2^{-10} e^{-i10\pi/3} \\ &= \frac{1}{1024} \left( \cos\left(-\frac{10\pi}{3}\right) + i \sin\left(-\frac{10\pi}{3}\right) \right) \\ &= \frac{1}{1024} \left( \cos\left(\frac{4\pi}{3}\right) - i \sin\left(\frac{4\pi}{3}\right) \right) \\ &= \frac{1}{1024} \left( -\frac{1}{2} + i \frac{\sqrt{3}}{2} \right) \\ &= -\frac{1}{2048} + i \frac{\sqrt{3}}{2048}\end{aligned}$$

2.

$$(11 + i4)^2 = 105 + i88$$

#### Solution 6.4

1.

$$\begin{aligned}\left(\frac{2 + i}{i6 - (1 - i2)}\right)^2 &= \left(\frac{2 + i}{-1 + i8}\right)^2 \\ &= \frac{3 + i4}{-63 - i16} \\ &= \frac{3 + i4}{-63 - i16} \frac{-63 + i16}{-63 + i16} \\ &= -\frac{253}{4225} - i \frac{204}{4225}\end{aligned}$$

2.

$$\begin{aligned}(1 - i)^7 &= ((1 - i)^2)^2 (1 - i)^2 (1 - i) \\ &= (-i2)^2 (-i2) (1 - i) \\ &= (-4)(-2 - i2) \\ &= 8 + i8\end{aligned}$$

### Solution 6.5

1.

$$\begin{aligned}\overline{\left(\frac{\bar{z}}{z}\right)} &= \overline{\left(\frac{x + iy}{x + iy}\right)} \\ &= \overline{\left(\frac{x - iy}{x + iy}\right)} \\ &= \frac{x + iy}{x - iy} \\ &= \frac{x + iy}{x - iy} \frac{x + iy}{x + iy} \\ &= \frac{x^2 - y^2}{x^2 + y^2} + i \frac{2xy}{x^2 + y^2}\end{aligned}$$



2.

$$\begin{aligned}
 \frac{z + i2}{2 - i\bar{z}} &= \frac{x + iy + i2}{2 - i(x - iy)} \\
 &= \frac{x + i(y + 2)}{2 - y - ix} \\
 &= \frac{x + i(y + 2)}{2 - y - ix} \frac{2 - y + ix}{2 - y + ix} \\
 &= \frac{x(2 - y) - (y + 2)x}{(2 - y)^2 + x^2} + i \frac{x^2 + (y + 2)(2 - y)}{(2 - y)^2 + x^2} \\
 &= \frac{-2xy}{(2 - y)^2 + x^2} + i \frac{4 + x^2 - y^2}{(2 - y)^2 + x^2}
 \end{aligned}$$

### Solution 6.6

**Method 1.** We expand the equation  $uv = w$  in its components.

$$uv = w$$

$$(u_0 + iu_1 + ju_2 + ku_3)(v_0 + i v_1 + j v_2 + k v_3) = w_0 + i w_1 + j w_2 + k w_3$$

$$\begin{aligned}
 (u_0 v_0 - u_1 v_1 - u_2 v_2 - u_3 v_3) + i(u_1 v_0 + u_0 v_1 - u_3 v_2 + u_2 v_3) + j(u_2 v_0 + u_3 v_1 + u_0 v_2 - u_1 v_3) \\
 + k(u_3 v_0 - u_2 v_1 + u_1 v_2 + u_0 v_3) = w_0 + i w_1 + j w_2 + k w_3
 \end{aligned}$$

We can write this as a matrix equation.

$$\begin{pmatrix} u_0 & -u_1 & -u_2 & -u_3 \\ u_1 & u_0 & -u_3 & u_2 \\ u_2 & u_3 & u_0 & -u_1 \\ u_3 & -u_2 & u_1 & u_0 \end{pmatrix} \begin{pmatrix} v_0 \\ v_1 \\ v_2 \\ v_3 \end{pmatrix} = \begin{pmatrix} w_0 \\ w_1 \\ w_2 \\ w_3 \end{pmatrix}$$

This linear system of equations has a unique solution for  $v$  if and only if the determinant of the matrix is nonzero. The determinant of the matrix is  $(u_0^2 + u_1^2 + u_2^2 + u_3^2)^2$ . This is zero if and only if  $u_0 = u_1 = u_2 = u_3 = 0$ . Thus there

exists a unique  $v$  such that  $uv = w$  if  $u$  is nonzero. This  $v$  is

$$v = \left( (u_0w_0 + u_1w_1 + u_2w_2 + u_3w_3) + i(-u_1w_0 + u_0w_1 + u_3w_2 - u_2w_3) + j(-u_2w_0 - u_3w_1 + u_0w_2 + u_1w_3) + k(-u_3w_0 + u_2w_1 - u_1w_2 + u_0w_3) \right) / (u_0^2 + u_1^2 + u_2^2 + u_3^2)$$

**Method 2.** Note that  $\bar{u}u$  is a real number.

$$\begin{aligned} \bar{u}u &= (u_0 - iu_1 - ju_2 - ku_3)(u_0 + iu_1 + ju_2 + ku_3) \\ &= (u_0^2 + u_1^2 + u_2^2 + u_3^2) + i(u_0u_1 - u_1u_0 - u_2u_3 + u_3u_2) \\ &\quad + j(u_0u_2 + u_1u_3 - u_2u_0 - u_3u_1) + k(u_0u_3 - u_1u_2 + u_2u_1 - u_3u_0) \\ &= (u_0^2 + u_1^2 + u_2^2 + u_3^2) \end{aligned}$$

$\bar{u}u = 0$  only if  $u = 0$ . We solve for  $v$  by multiplying by the conjugate of  $u$  and dividing by  $\bar{u}u$ .

$$\begin{aligned} uv &= w \\ \bar{u}uv &= \bar{u}w \\ v &= \frac{\bar{u}w}{\bar{u}u} \\ v &= \frac{(u_0 - iu_1 - ju_2 - ku_3)(w_0 + iw_1 + jw_2 + kw_3)}{u_0^2 + u_1^2 + u_2^2 + u_3^2} \end{aligned}$$

$$v = \left( (u_0w_0 + u_1w_1 + u_2w_2 + u_3w_3) + i(-u_1w_0 + u_0w_1 + u_3w_2 - u_2w_3) + j(-u_2w_0 - u_3w_1 + u_0w_2 + u_1w_3) + k(-u_3w_0 + u_2w_1 - u_1w_2 + u_0w_3) \right) / (u_0^2 + u_1^2 + u_2^2 + u_3^2)$$

### Solution 6.7

If  $\alpha = t\beta$ , then  $\alpha\bar{\beta} = t|\beta|^2$ , which is a real number. Hence  $\Im(\alpha\bar{\beta}) = 0$ .

Now assume that  $\Im(\alpha\bar{\beta}) = 0$ . This implies that  $\alpha\bar{\beta} = r$  for some  $r \in \mathbb{R}$ . We multiply by  $\beta$  and simplify.

$$\begin{aligned} \alpha|\beta|^2 &= r\beta \\ \alpha &= \frac{r}{|\beta|^2}\beta \end{aligned}$$

By taking  $t = \frac{r}{|\beta|^2}$  We see that  $\alpha = t\beta$  for some real number  $t$ .

# The Complex Plane

## Solution 6.8

1.

$$\begin{aligned}(1 + i)^{1/3} &= \left(\sqrt{2} e^{i\pi/4}\right)^{1/3} \\ &= \sqrt[6]{2} e^{i\pi/12} 1^{1/3} \\ &= \sqrt[6]{2} e^{i\pi/12} e^{i2\pi k/3}, \quad k = 0, 1, 2 \\ &= \left\{ \sqrt[6]{2} e^{i\pi/12}, \sqrt[6]{2} e^{i3\pi/4}, \sqrt[6]{2} e^{i17\pi/12} \right\}\end{aligned}$$

The principal root is

$$\sqrt[3]{1 + i} = \sqrt[6]{2} e^{i\pi/12}.$$

The roots are depicted in Figure 6.9.

2.

$$\begin{aligned}i^{1/4} &= \left(e^{i\pi/2}\right)^{1/4} \\ &= e^{i\pi/8} 1^{1/4} \\ &= e^{i\pi/8} e^{i2\pi k/4}, \quad k = 0, 1, 2, 3 \\ &= \left\{ e^{i\pi/8}, e^{i5\pi/8}, e^{i9\pi/8}, e^{i13\pi/8} \right\}\end{aligned}$$

The principal root is

$$\sqrt[4]{i} = e^{i\pi/8}.$$

The roots are depicted in Figure 6.10.

## Solution 6.9

1.

$$\begin{aligned}|\Re(z)| + 2|\Im(z)| &\leq 1 \\ |x| + 2|y| &\leq 1\end{aligned}$$

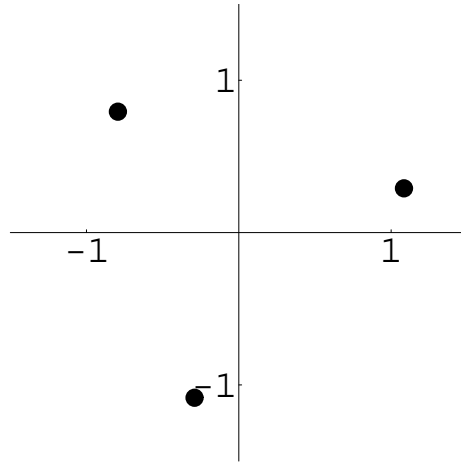

Figure 6.9:  $(1 + \iota)^{1/3}$

In the first quadrant, this is the triangle below the line  $y = (1-x)/2$ . We reflect this triangle across the coordinate axes to obtain triangles in the other quadrants. Explicitly, we have the set of points:  $\{z = x + iy \mid -1 \leq x \leq 1 \wedge |y| \leq (1 - |x|)/2\}$ . See Figure 6.11.

2.  $|z - \iota|$  is the distance from the point  $\iota$  in the complex plane. Thus  $1 < |z - \iota| < 2$  is an annulus centered at  $z = \iota$  between the radii 1 and 2. See Figure 6.12.
3. The points which are closer to  $z = \iota$  than  $z = -\iota$  are those points in the upper half plane. See Figure 6.13.

### Solution 6.10

Let  $z = r e^{i\theta}$  and  $\zeta = \rho e^{i\phi}$ .

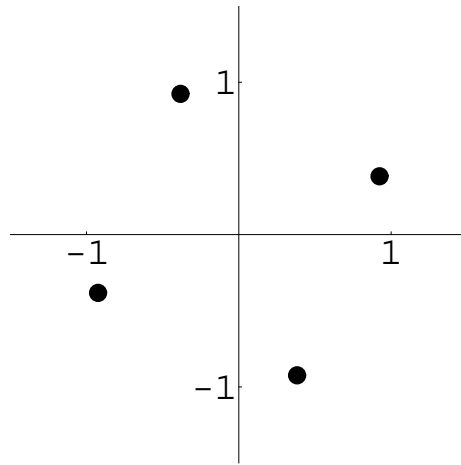

Figure 6.10:  $i^{1/4}$

1.

$$\begin{aligned}\arg(z\zeta) &= \arg(z) + \arg(\zeta) \\ \arg(r\rho e^{i(\theta+\phi)}) &= \{\theta + 2\pi m\} + \{\phi + 2\pi n\} \\ \{\theta + \phi + 2\pi k\} &= \{\theta + \phi + 2\pi m\}\end{aligned}$$

2.

$$\text{Arg}(z\zeta) \neq \text{Arg}(z) + \text{Arg}(\zeta)$$

Consider  $z = \zeta = -1$ .  $\text{Arg}(z) = \text{Arg}(\zeta) = \pi$ , however  $\text{Arg}(z\zeta) = \text{Arg}(1) = 0$ . The identity becomes  $0 \neq 2\pi$ .

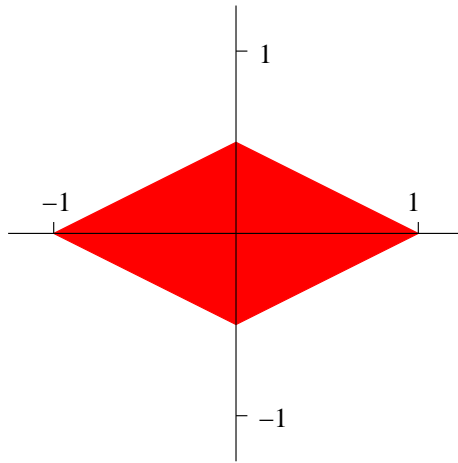

Figure 6.11:  $|\Re(z)| + 2|\Im(z)| \leq 1$

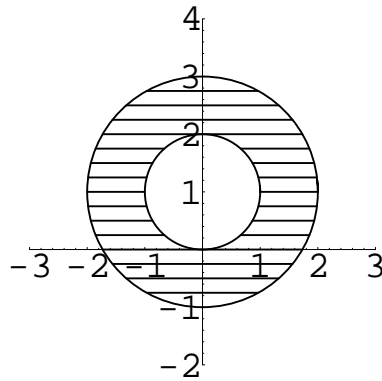

Figure 6.12:  $1 < |z - i| < 2$

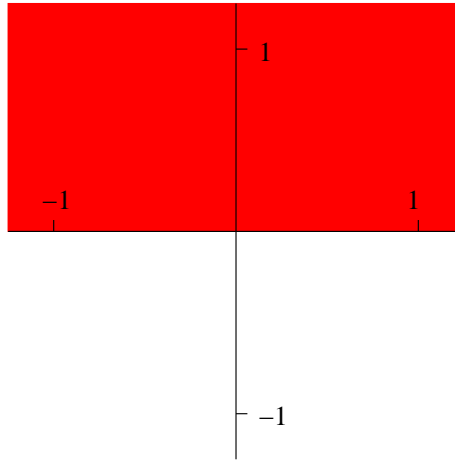

Figure 6.13: The upper half plane.

3.

$$\begin{aligned} \arg(z^2) &= \arg(z) + \arg(z) \neq 2\arg(z) \\ \arg(r^2 e^{i2\theta}) &= \{\theta + 2\pi k\} + \{\theta + 2\pi m\} \neq 2\{\theta + 2\pi n\} \\ \{2\theta + 2\pi k\} &= \{2\theta + 2\pi m\} \neq \{2\theta + 4\pi n\} \end{aligned}$$

### Solution 6.11

Consider a triangle in the complex plane with vertices at  $0$ ,  $z$  and  $z + \zeta$ . (See Figure 6.14.)

The lengths of the sides of the triangle are  $|z|$ ,  $|\zeta|$  and  $|z + \zeta|$ . The second inequality shows that one side of the triangle must be less than or equal to the sum of the other two sides.

$$|z + \zeta| \leq |z| + |\zeta|$$

The first inequality shows that the length of one side of the triangle must be greater than or equal to the difference in

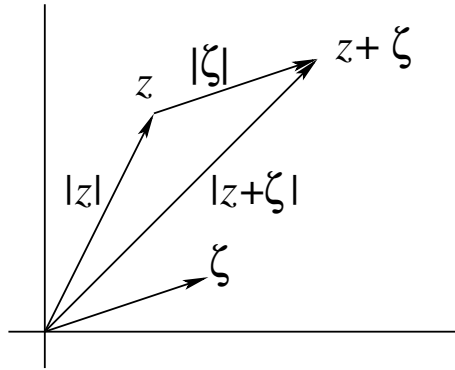

Figure 6.14: Triangle inequality.

the length of the other two sides.

$$|z + \zeta| \geq ||z| - |\zeta||$$

Now we prove the inequalities algebraically. We will reduce the inequality to an identity. Let  $z = r e^{i\theta}$ ,  $\zeta = \rho e^{i\phi}$ .

$$\begin{aligned} ||z| - |\zeta|| &\leq |z + \zeta| \leq |z| + |\zeta| \\ |r - \rho| &\leq |r e^{i\theta} + \rho e^{i\phi}| \leq r + \rho \\ (r - \rho)^2 &\leq (r e^{i\theta} + \rho e^{i\phi})(r e^{-i\theta} + \rho e^{-i\phi}) \leq (r + \rho)^2 \\ r^2 + \rho^2 - 2r\rho &\leq r^2 + \rho^2 + r\rho e^{i(\theta-\phi)} + r\rho e^{i(-\theta+\phi)} \leq r^2 + \rho^2 + 2r\rho \\ -2r\rho &\leq 2r\rho \cos(\theta - \phi) \leq 2r\rho \\ -1 &\leq \cos(\theta - \phi) \leq 1 \end{aligned}$$



## Solution 6.12

1.

$$\begin{aligned}(-1)^{-3/4} &= ((-1)^{-3})^{1/4} \\ &= (-1)^{1/4} \\ &= (e^{i\pi})^{1/4} \\ &= e^{i\pi/4} 1^{1/4} \\ &= e^{i\pi/4} e^{ik\pi/2}, \quad k = 0, 1, 2, 3 \\ &= \{e^{i\pi/4}, e^{i3\pi/4}, e^{i5\pi/4}, e^{i7\pi/4}\} \\ &= \left\{ \frac{1+i}{\sqrt{2}}, \frac{-1+i}{\sqrt{2}}, \frac{-1-i}{\sqrt{2}}, \frac{1-i}{\sqrt{2}} \right\}\end{aligned}$$

See Figure 6.15.

2.

$$\begin{aligned}8^{1/6} &= \sqrt[6]{81}^{1/6} \\ &= \sqrt{2} e^{ik\pi/3}, \quad k = 0, 1, 2, 3, 4, 5 \\ &= \left\{ \sqrt{2}, \sqrt{2} e^{i\pi/3}, \sqrt{2} e^{i2\pi/3}, \sqrt{2} e^{i\pi}, \sqrt{2} e^{i4\pi/3}, \sqrt{2} e^{i5\pi/3} \right\} \\ &= \left\{ \sqrt{2}, \frac{1+i\sqrt{3}}{\sqrt{2}}, \frac{-1+i\sqrt{3}}{\sqrt{2}}, -\sqrt{2}, \frac{-1-i\sqrt{3}}{\sqrt{2}}, \frac{1-i\sqrt{3}}{\sqrt{2}} \right\}\end{aligned}$$

See Figure 6.16.

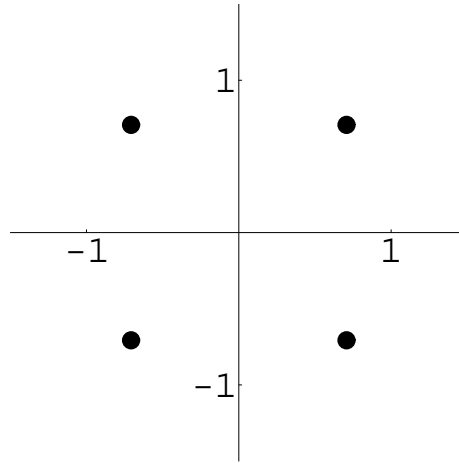

Figure 6.15:  $(-1)^{-3/4}$

### Solution 6.13

1.

$$\begin{aligned}
 (-1)^{-1/4} &= ((-1)^{-1})^{1/4} \\
 &= (-1)^{1/4} \\
 &= (e^{i\pi})^{1/4} \\
 &= e^{i\pi/4} 1^{1/4} \\
 &= e^{i\pi/4} e^{ik\pi/2}, \quad k = 0, 1, 2, 3 \\
 &= \{e^{i\pi/4}, e^{i3\pi/4}, e^{i5\pi/4}, e^{i7\pi/4}\} \\
 &= \left\{ \frac{1+i}{\sqrt{2}}, \frac{-1+i}{\sqrt{2}}, \frac{-1-i}{\sqrt{2}}, \frac{1-i}{\sqrt{2}} \right\}
 \end{aligned}$$

See Figure 6.17.

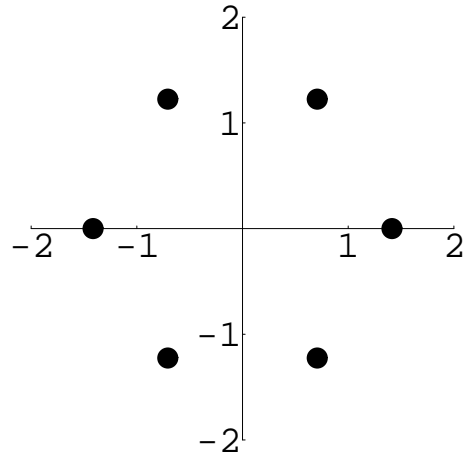

Figure 6.16:  $8^{1/6}$

2.

$$\begin{aligned}
 16^{1/8} &= \sqrt[8]{16}^{1/8} \\
 &= \sqrt{2} e^{ik\pi/4}, \quad k = 0, 1, 2, 3, 4, 5, 6, 7 \\
 &= \left\{ \sqrt{2}, \sqrt{2} e^{i\pi/4}, \sqrt{2} e^{i\pi/2}, \sqrt{2} e^{i3\pi/4}, \sqrt{2} e^{i\pi}, \sqrt{2} e^{i5\pi/4}, \sqrt{2} e^{i3\pi/2}, \sqrt{2} e^{i7\pi/4} \right\} \\
 &= \left\{ \sqrt{2}, 1 + i, i\sqrt{2}, -1 + i, -\sqrt{2}, -1 - i, -i\sqrt{2}, 1 - i \right\}
 \end{aligned}$$

See Figure 6.18.

### Solution 6.14

1.  $|z - i2|$  is the distance from the point  $i2$  in the complex plane. Thus  $1 < |z - i2| < 2$  is an annulus. See Figure 6.19.

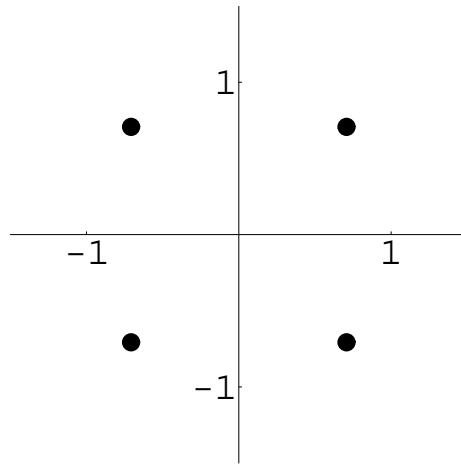

Figure 6.17:  $(-1)^{-1/4}$

2.

$$\begin{aligned} |\Re(z)| + 5|\Im(z)| &= 1 \\ |x| + 5|y| &= 1 \end{aligned}$$

In the first quadrant this is the line  $y = (1 - x)/5$ . We reflect this line segment across the coordinate axes to obtain line segments in the other quadrants. Explicitly, we have the set of points:  $\{z = x + iy \mid -1 < x < 1 \wedge y = \pm(1 - |x|)/5\}$ . See Figure 6.20.

3. The set of points equidistant from  $i$  and  $-i$  is the real axis. See Figure 6.21.

### Solution 6.15

1.  $|z - 1 + i|$  is the distance from the point  $(1 - i)$ . Thus  $|z - 1 + i| \leq 1$  is the disk of unit radius centered at  $(1 - i)$ . See Figure 6.22.

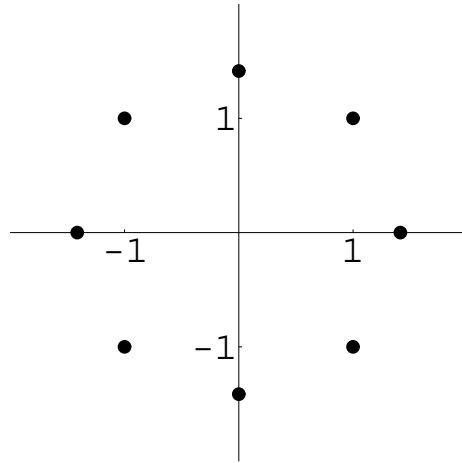

Figure 6.18:  $16^{-1/8}$

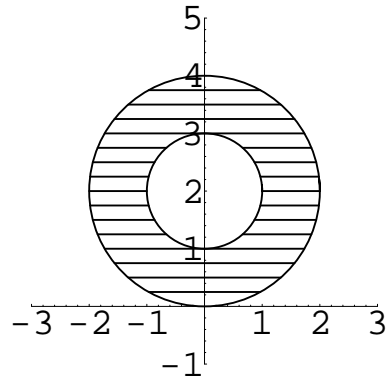

Figure 6.19:  $1 < |z - i2| < 2$

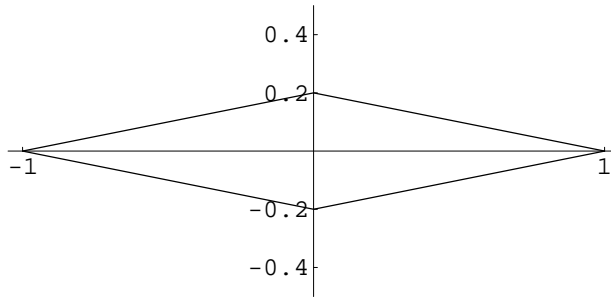

Figure 6.20:  $|\Re(z)| + 5|\Im(z)| = 1$

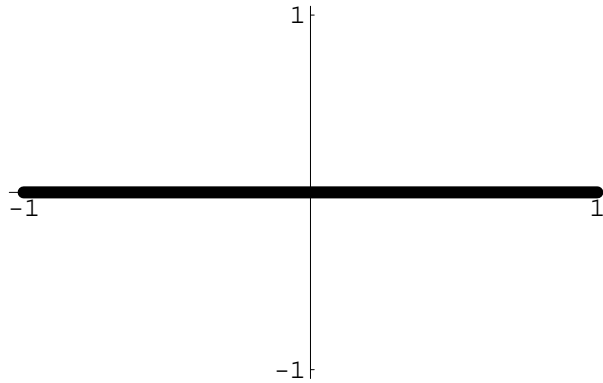

Figure 6.21:  $|z - i| = |z + i|$

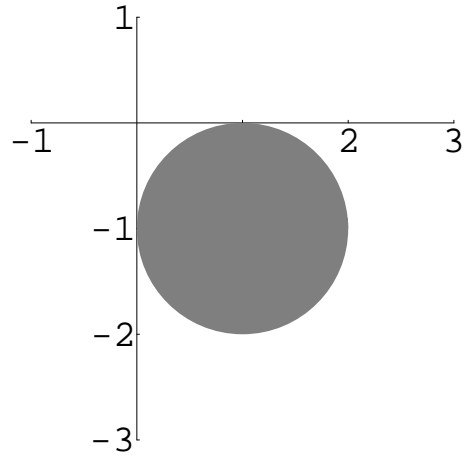

Figure 6.22:  $|z - 1 + i| < 1$

2.

$$\Re(z) - \Im(z) = 5$$

$$x - y = 5$$

$$y = x - 5$$

See Figure 6.23.

3. Since  $|z - i| + |z + i| \geq 2$ , there are no solutions of  $|z - i| + |z + i| = 1$ .

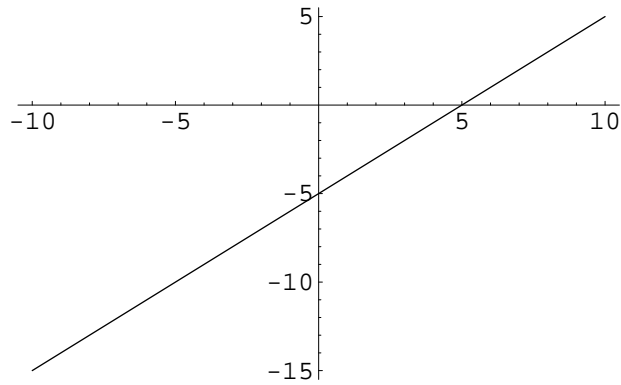

Figure 6.23:  $\Re(z) - \Im(z) = 5$

### Solution 6.16

$$\begin{aligned}
 |e^{i\theta} - 1| &= 2 \\
 (e^{i\theta} - 1)(e^{-i\theta} - 1) &= 4 \\
 1 - e^{i\theta} - e^{-i\theta} + 1 &= 4 \\
 -2\cos(\theta) &= 2 \\
 \theta &= \pi
 \end{aligned}$$

$\{e^{i\theta} \mid 0 \leq \theta \leq \pi\}$  is a unit semi-circle in the upper half of the complex plane from 1 to  $-1$ . The only point on this semi-circle that is a distance 2 from the point 1 is the point  $-1$ , which corresponds to  $\theta = \pi$ .

### Polar Form



**Solution 6.17**

We recall the Taylor series expansion of  $e^x$  about  $x = 0$ .

$$e^x = \sum_{n=0}^{\infty} \frac{x^n}{n!}.$$

We take this as the definition of the exponential function for complex argument.

$$\begin{aligned} e^{i\theta} &= \sum_{n=0}^{\infty} \frac{(i\theta)^n}{n!} \\ &= \sum_{n=0}^{\infty} \frac{i^n \theta^n}{n!} \\ &= \sum_{n=0}^{\infty} \frac{(-1)^n}{(2n)!} \theta^{2n} + i \sum_{n=0}^{\infty} \frac{(-1)^n}{(2n+1)!} \theta^{2n+1} \end{aligned}$$

We compare this expression to the Taylor series for the sine and cosine.

$$\cos \theta = \sum_{n=0}^{\infty} \frac{(-1)^n}{(2n)!} \theta^{2n}, \quad \sin \theta = \sum_{n=0}^{\infty} \frac{(-1)^n}{(2n+1)!} \theta^{2n+1},$$

Thus  $e^{i\theta}$  and  $\cos \theta + i \sin \theta$  have the same Taylor series expansions about  $\theta = 0$ .

$$\boxed{e^{i\theta} = \cos \theta + i \sin \theta}$$

**Solution 6.18**

$$\begin{aligned} \cos(3\theta) + i \sin(3\theta) &= (\cos \theta + i \sin \theta)^3 \\ \cos(3\theta) + i \sin(3\theta) &= \cos^3 \theta + i3 \cos^2 \theta \sin \theta - 3 \cos \theta \sin^2 \theta - i \sin^3 \theta \end{aligned}$$

We equate the real parts of the equation.

$$\cos(3\theta) = \cos^3 \theta - 3 \cos \theta \sin^2 \theta$$

**Solution 6.19**

Define the partial sum,

$$S_n(z) = \sum_{k=0}^n z^k.$$

Now consider  $(1 - z)S_n(z)$ .

$$\begin{aligned} (1 - z)S_n(z) &= (1 - z) \sum_{k=0}^n z^k \\ (1 - z)S_n(z) &= \sum_{k=0}^n z^k - \sum_{k=1}^{n+1} z^k \\ (1 - z)S_n(z) &= 1 - z^{n+1} \end{aligned}$$

We divide by  $1 - z$ . Note that  $1 - z$  is nonzero.

$$\begin{aligned} S_n(z) &= \frac{1 - z^{n+1}}{1 - z} \\ 1 + z + z^2 + \cdots + z^n &= \frac{1 - z^{n+1}}{1 - z}, \quad (z \neq 1) \end{aligned}$$

Now consider  $z = e^{i\theta}$  where  $0 < \theta < 2\pi$  so that  $z$  is not unity.

$$\begin{aligned} \sum_{k=0}^n (e^{i\theta})^k &= \frac{1 - (e^{i\theta})^{n+1}}{1 - e^{i\theta}} \\ \sum_{k=0}^n e^{ik\theta} &= \frac{1 - e^{i(n+1)\theta}}{1 - e^{i\theta}} \end{aligned}$$

In order to get  $\sin(\theta/2)$  in the denominator, we multiply top and bottom by  $e^{-i\theta/2}$ .

$$\sum_{k=0}^n (\cos(k\theta) + i \sin(k\theta)) = \frac{e^{-i\theta/2} - e^{i(n+1/2)\theta}}{e^{-i\theta/2} - e^{i\theta/2}}$$

$$\sum_{k=0}^n \cos(k\theta) + i \sum_{k=0}^n \sin(k\theta) = \frac{\cos(\theta/2) - i \sin(\theta/2) - \cos((n+1/2)\theta) - i \sin((n+1/2)\theta)}{-2i \sin(\theta/2)}$$

$$\sum_{k=0}^n \cos(k\theta) + i \sum_{k=1}^n \sin(k\theta) = \frac{1}{2} + \frac{\sin((n+1/2)\theta)}{\sin(\theta/2)} + i \left( \frac{1}{2} \cot(\theta/2) - \frac{\cos((n+1/2)\theta)}{\sin(\theta/2)} \right)$$

1. We take the real and imaginary part of this to obtain the identities.

$$\boxed{\sum_{k=0}^n \cos(k\theta) = \frac{1}{2} + \frac{\sin((n+1/2)\theta)}{2 \sin(\theta/2)}}$$

2.

$$\boxed{\sum_{k=1}^n \sin(k\theta) = \frac{1}{2} \cot(\theta/2) - \frac{\cos((n+1/2)\theta)}{2 \sin(\theta/2)}}$$

## Arithmetic and Vectors

### Solution 6.20

$$\begin{aligned} |z\zeta| &= |r e^{i\theta} \rho e^{i\phi}| \\ &= |r\rho e^{i(\theta+\phi)}| \\ &= |r\rho| \\ &= |r||\rho| \\ &= |z||\zeta| \end{aligned}$$

$$\begin{aligned}
\left| \frac{z}{\zeta} \right| &= \left| \frac{r e^{i\theta}}{\rho e^{i\phi}} \right| \\
&= \left| \frac{r}{\rho} e^{i(\theta-\phi)} \right| \\
&= \left| \frac{r}{\rho} \right| \\
&= \frac{|r|}{|\rho|} \\
&= \frac{|z|}{|\zeta|}
\end{aligned}$$

### Solution 6.21

$$\begin{aligned}
|z + \zeta|^2 + |z - \zeta|^2 &= (z + \zeta)(\bar{z} + \bar{\zeta}) + (z - \zeta)(\bar{z} - \bar{\zeta}) \\
&= z\bar{z} + z\bar{\zeta} + \zeta\bar{z} + \zeta\bar{\zeta} + z\bar{z} - z\bar{\zeta} - \zeta\bar{z} + \zeta\bar{\zeta} \\
&= 2(|z|^2 + |\zeta|^2)
\end{aligned}$$

Consider the parallelogram defined by the vectors  $z$  and  $\zeta$ . The lengths of the sides are  $z$  and  $\zeta$  and the lengths of the diagonals are  $z + \zeta$  and  $z - \zeta$ . We know from geometry that the sum of the squared lengths of the diagonals of a parallelogram is equal to the sum of the squared lengths of the four sides. (See Figure 6.24.)

## Integer Exponents

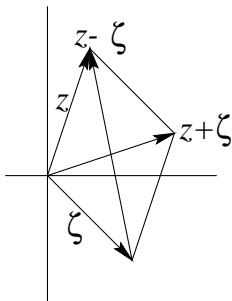

Figure 6.24: The parallelogram defined by  $z$  and  $\zeta$ .

**Solution 6.22**

1.

$$\begin{aligned}
 (1+i)^{10} &= \left( ((1+i)^2)^2 \right)^2 (1+i)^2 \\
 &= ((i2)^2)^2 (i2) \\
 &= (-4)^2 (i2) \\
 &= 16(i2) \\
 &= i32
 \end{aligned}$$

2.

$$\begin{aligned}
 (1+i)^{10} &= \left( \sqrt{2} e^{i\pi/4} \right)^{10} \\
 &= \left( \sqrt{2} \right)^{10} e^{i10\pi/4} \\
 &= 32 e^{i\pi/2} \\
 &= i32
 \end{aligned}$$

## Rational Exponents

### Solution 6.23

We substitute the numbers into the equation to obtain an identity.

$$z^2 + 2az + b = 0$$

$$\left(-a + (a^2 - b)^{1/2}\right)^2 + 2a\left(-a + (a^2 - b)^{1/2}\right) + b = 0$$

$$a^2 - 2a(a^2 - b)^{1/2} + a^2 - b - 2a^2 + 2a(a^2 - b)^{1/2} + b = 0$$

$$0 = 0$$

# Chapter 7

## Functions of a Complex Variable

If brute force isn't working, you're not using enough of it.

-Tim Mauch

In this chapter we introduce the algebra of functions of a complex variable. We will cover the trigonometric and inverse trigonometric functions. The properties of trigonometric functions carry over directly from real-variable theory. However, because of multi-valuedness, the inverse trigonometric functions are significantly trickier than their real-variable counterparts.

### 7.1 Curves and Regions

In this section we introduce curves and regions in the complex plane. This material is necessary for the study of branch points in this chapter and later for contour integration.

**Curves.** Consider two continuous functions  $x(t)$  and  $y(t)$  defined on the interval  $t \in [t_0..t_1]$ . The set of points in the complex plane,

$$\{z(t) = x(t) + iy(t) \mid t \in [t_0 \dots t_1]\},$$

defines a *continuous curve* or simply a *curve*. If the endpoints coincide ( $z(t_0) = z(t_1)$ ) it is a *closed curve*. (We assume that  $t_0 \neq t_1$ .) If the curve does not intersect itself, then it is said to be a *simple curve*.

If  $x(t)$  and  $y(t)$  have continuous derivatives and the derivatives do not both vanish at any point, then it is a *smooth curve*.<sup>1</sup> This essentially means that the curve does not have any corners or other nastiness.

A continuous curve which is composed of a finite number of smooth curves is called a *piecewise smooth curve*. We will use the word *contour* as a synonym for a piecewise smooth curve.

See Figure 7.1 for a smooth curve, a piecewise smooth curve, a simple closed curve and a non-simple closed curve.

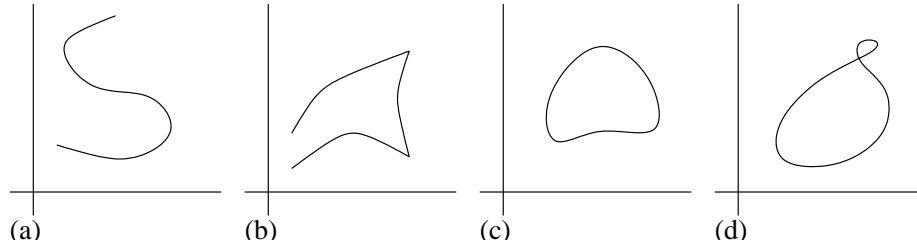

Figure 7.1: (a) Smooth curve. (b) Piecewise smooth curve. (c) Simple closed curve. (d) Non-simple closed curve.

**Regions.** A region  $R$  is *connected* if any two points in  $R$  can be connected by a curve which lies entirely in  $R$ . A region is *simply-connected* if every closed curve in  $R$  can be continuously shrunk to a point without leaving  $R$ . A region which is not simply-connected is said to be a *multiply-connected region*. Another way of defining simply-connected is that a path connecting two points in  $R$  can be continuously deformed into any other path that connects those points. Figure 7.2 shows a simply-connected region with two paths which can be continuously deformed into one another and two multiply-connected regions with paths which cannot be deformed into one another.

**Jordan curve theorem.** A continuous, simple, closed curve is known as a *Jordan curve*. The Jordan Curve Theorem, which seems intuitively obvious but is difficult to prove, states that a Jordan curve divides the plane into

---

<sup>1</sup>Why is it necessary that the derivatives do not both vanish?



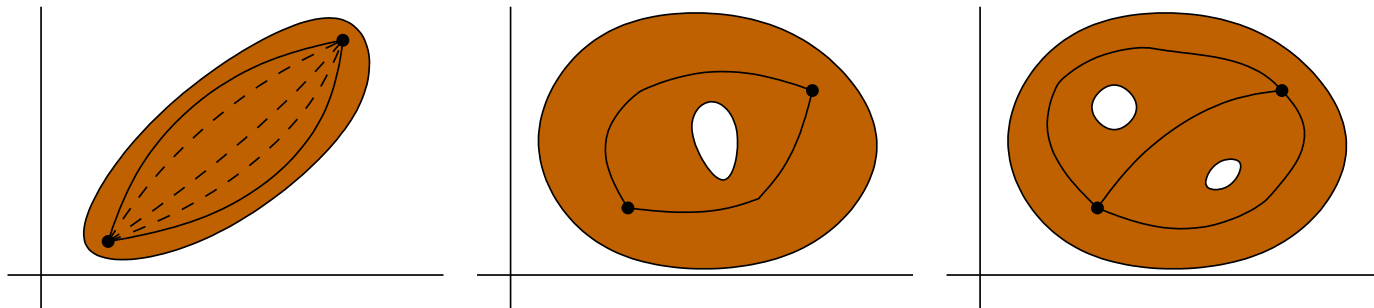

Figure 7.2: A simply-connected and two multiply-connected regions.

a simply-connected, bounded region and an unbounded region. These two regions are called the interior and exterior regions, respectively. The two regions share the curve as a boundary. Points in the interior are said to be inside the curve; points in the exterior are said to be outside the curve.

**Traversal of a contour.** Consider a Jordan curve. If you traverse the curve in the *positive* direction, then the inside is to your left. If you traverse the curve in the opposite direction, then the outside will be to your left and you will go around the curve in the negative direction. For circles, the positive direction is the *counter-clockwise* direction. The positive direction is consistent with the way angles are measured in a right-handed coordinate system, i.e. for a circle centered on the origin, the positive direction is the direction of increasing angle. For an oriented contour  $C$ , we denote the contour with opposite orientation as  $-C$ .

**Boundary of a region.** Consider a simply-connected region. The boundary of the region is traversed in the positive direction if the region is to the left as you walk along the contour. For multiply-connected regions, the boundary may be a set of contours. In this case the boundary is traversed in the positive direction if each of the contours is traversed in the positive direction. When we refer to the boundary of a region we will assume it is given the positive orientation. In Figure 7.3 the boundaries of three regions are traversed in the positive direction.

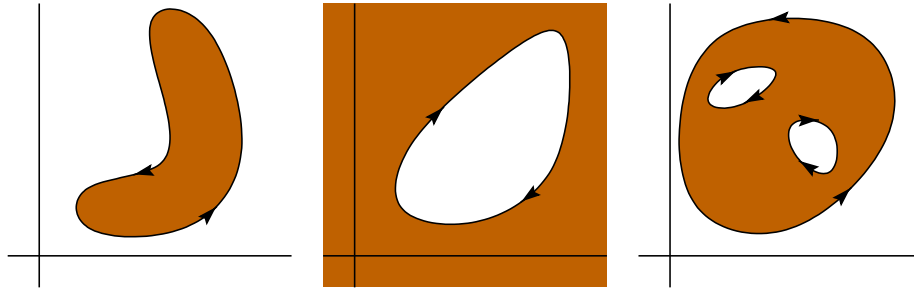

Figure 7.3: Traversing the boundary in the positive direction.

**Two interpretations of a curve.** Consider a simple closed curve as depicted in Figure 7.4a. By giving it an orientation, we can make a contour that either encloses the bounded domain Figure 7.4b or the unbounded domain Figure 7.4c. Thus a curve has two interpretations. It can be thought of as enclosing either the points which are “inside” or the points which are “outside”.<sup>2</sup>

## 7.2 The Point at Infinity and the Stereographic Projection

**Complex infinity.** In real variables, there are only two ways to get to infinity. We can either go up or down the number line. Thus signed infinity makes sense. By going up or down we respectively approach  $+\infty$  and  $-\infty$ . In the complex plane there are an infinite number of ways to approach infinity. We stand at the origin, point ourselves in any direction and go straight. We could walk along the positive real axis and approach infinity via positive real numbers. We could walk along the positive imaginary axis and approach infinity via pure imaginary numbers. We could generalize the real variable notion of signed infinity to a complex variable notion of directional infinity, but this will not be useful

---

<sup>2</sup> A farmer wanted to know the most efficient way to build a pen to enclose his sheep, so he consulted an engineer, a physicist and a mathematician. The engineer suggested that he build a circular pen to get the maximum area for any given perimeter. The physicist suggested that he build a fence at infinity and then shrink it to fit the sheep. The mathematician constructed a little fence around himself and then defined himself to be outside.

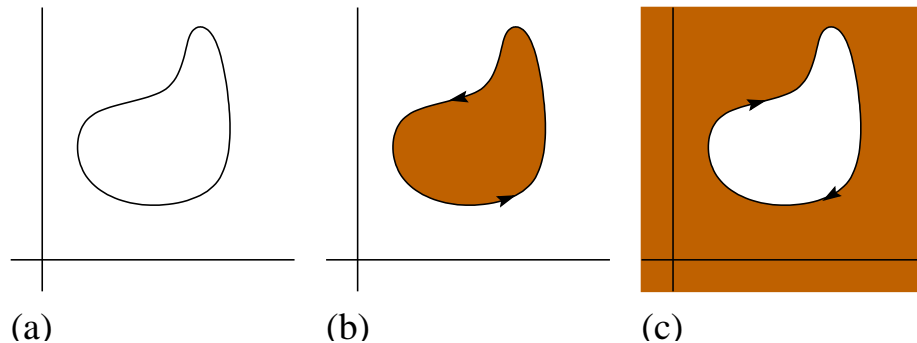

Figure 7.4: Two interpretations of a curve.

for our purposes. Instead, we introduce *complex infinity* or the *point at infinity* as the limit of going infinitely far along any direction in the complex plane. The complex plane together with the point at infinity form the *extended complex plane*.

**Stereographic projection.** We can visualize the point at infinity with the *stereographic projection*. We place a unit sphere on top of the complex plane so that the south pole of the sphere is at the origin. Consider a line passing through the north pole and a point  $z = x + iy$  in the complex plane. In the stereographic projection, the point  $z$  is mapped to the point where the line intersects the sphere. (See Figure 7.5.) Each point  $z = x + iy$  in the complex plane is mapped to a unique point  $(X, Y, Z)$  on the sphere.

$$X = \frac{4x}{|z|^2 + 4}, \quad Y = \frac{4y}{|z|^2 + 4}, \quad Z = \frac{2|z|^2}{|z|^2 + 4}$$

The origin is mapped to the south pole. The point at infinity,  $|z| = \infty$ , is mapped to the north pole.

In the stereographic projection, circles in the complex plane are mapped to circles on the unit sphere. Figure 7.6 shows circles along the real and imaginary axes under the mapping. Lines in the complex plane are also mapped to circles on the unit sphere. The right diagram in Figure 7.6 shows lines emanating from the origin under the mapping.

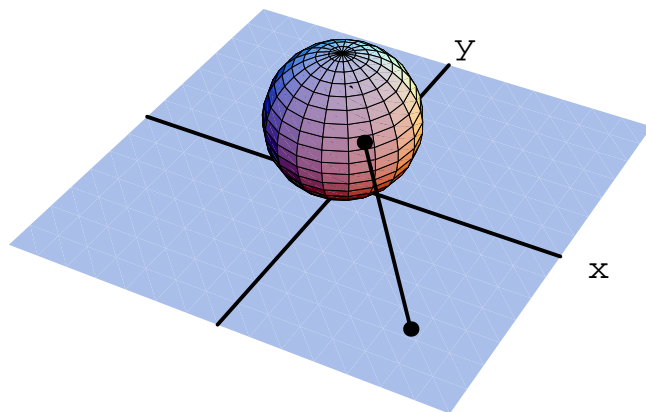

Figure 7.5: The stereographic projection.

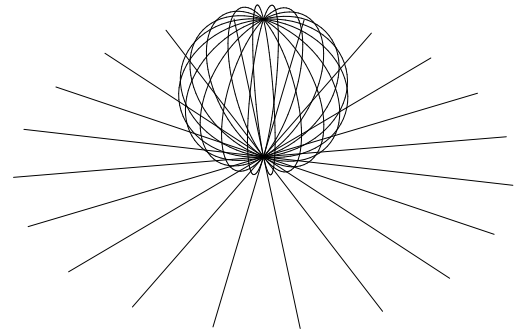
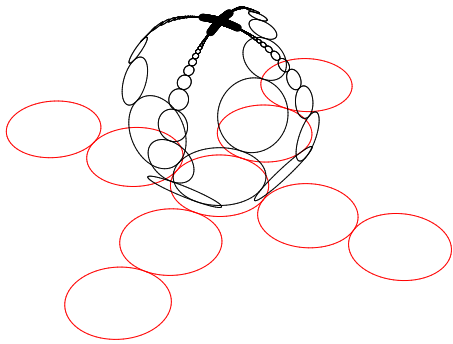

Figure 7.6: The stereographic projection of circles and lines.

The stereographic projection helps us reason about the point at infinity. When we consider the complex plane by itself, the point at infinity is an abstract notion. We can't draw a picture of the point at infinity. It may be hard to accept the notion of a Jordan curve enclosing the point at infinity. However, in the stereographic projection, the point at infinity is just an ordinary point (namely the north pole of the sphere).

## 7.3 A Gentle Introduction to Branch Points

In this section we will introduce the concepts of *branches*, *branch points* and *branch cuts*. These concepts (which are notoriously difficult to understand for beginners) are typically defined in terms of functions of a complex variable. Here we will develop these ideas as they relate to the arctangent function  $\arctan(x, y)$ . Hopefully this simple example will make the treatment in Section 7.9 more palatable.

First we review some properties of the arctangent. It is a mapping from  $\mathbb{R}^2$  to  $\mathbb{R}$ . It measures the angle around the origin from the positive  $x$  axis. Thus it is a multi-valued function. For a fixed point in the domain, the function values differ by integer multiples of  $2\pi$ . The arctangent is not defined at the origin nor at the point at infinity; it is singular at these two points. If we plot some of the values of the arctangent, it looks like a corkscrew with axis through the origin. A portion of this function is plotted in Figure 7.7.

Most of the tools we have for analyzing functions (continuity, differentiability, etc.) depend on the fact that the function is single-valued. In order to work with the arctangent we need to select a portion to obtain a single-valued function. Consider the domain  $(-1..2) \times (1..4)$ . On this domain we select the value of the arctangent that is between 0 and  $\pi$ . The domain and a plot of the selected values of the arctangent are shown in Figure 7.8.

CONTINUE.

## 7.4 Cartesian and Modulus-Argument Form

We can write a function of a complex variable  $z$  as a function of  $x$  and  $y$  or as a function of  $r$  and  $\theta$  with the substitutions  $z = x + iy$  and  $z = r e^{i\theta}$ , respectively. Then we can separate the real and imaginary components or write the function in modulus-argument form,

$$f(z) = u(x, y) + w(x, y), \quad \text{or} \quad f(z) = u(r, \theta) + w(r, \theta),$$

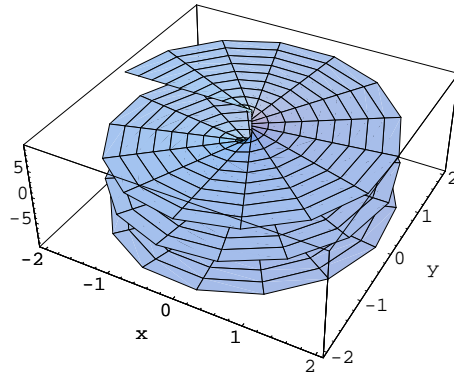

Figure 7.7: Plots of  $\Re(\log z)$  and a portion of  $\Im(\log z)$ .

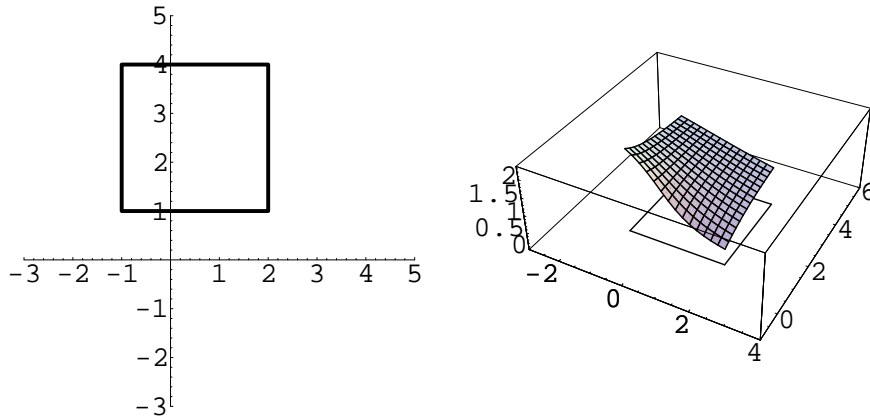

Figure 7.8: A domain and a selected value of the arctangent for the points in the domain.

$$f(z) = \rho(x, y) e^{i\phi(x, y)}, \quad \text{or} \quad f(z) = \rho(r, \theta) e^{i\phi(r, \theta)}.$$

**Example 7.4.1** Consider the functions  $f(z) = z$ ,  $f(z) = z^3$  and  $f(z) = \frac{1}{1-z}$ . We write the functions in terms of  $x$  and  $y$  and separate them into their real and imaginary components.

$$\begin{aligned} f(z) &= z \\ &= x + iy \end{aligned}$$

$$\begin{aligned} f(z) &= z^3 \\ &= (x + iy)^3 \\ &= x^3 + ix^2y - xy^2 - iy^3 \\ &= (x^3 - xy^2) + i(x^2y - y^3) \end{aligned}$$

$$\begin{aligned} f(z) &= \frac{1}{1-z} \\ &= \frac{1}{1-x-iy} \\ &= \frac{1}{1-x-iy} \frac{1-x+iy}{1-x+iy} \\ &= \frac{1-x}{(1-x)^2+y^2} + i \frac{y}{(1-x)^2+y^2} \end{aligned}$$

**Example 7.4.2** Consider the functions  $f(z) = z$ ,  $f(z) = z^3$  and  $f(z) = \frac{1}{1-z}$ . We write the functions in terms of  $r$  and  $\theta$  and write them in modulus-argument form.

$$\begin{aligned} f(z) &= z \\ &= r e^{i\theta} \end{aligned}$$



$$\begin{aligned}
f(z) &= z^3 \\
&= (r e^{i\theta})^3 \\
&= r^3 e^{i3\theta}
\end{aligned}$$

$$\begin{aligned}
f(z) &= \frac{1}{1-z} \\
&= \frac{1}{1-r e^{i\theta}} \\
&= \frac{1}{1-r e^{i\theta}} \frac{1}{1-r e^{-i\theta}} \\
&= \frac{1-r e^{-i\theta}}{1-r e^{i\theta}-r e^{-i\theta}+r^2} \\
&= \frac{1-r \cos \theta + ir \sin \theta}{1-2r \cos \theta + r^2}
\end{aligned}$$

*Note that the denominator is real and non-negative.*

$$\begin{aligned}
&= \frac{1}{1-2r \cos \theta + r^2} |1-r \cos \theta + ir \sin \theta| e^{i \arctan(1-r \cos \theta, r \sin \theta)} \\
&= \frac{1}{1-2r \cos \theta + r^2} \sqrt{(1-r \cos \theta)^2 + r^2 \sin^2 \theta} e^{i \arctan(1-r \cos \theta, r \sin \theta)} \\
&= \frac{1}{1-2r \cos \theta + r^2} \sqrt{1-2r \cos \theta + r^2 \cos^2 \theta + r^2 \sin^2 \theta} e^{i \arctan(1-r \cos \theta, r \sin \theta)} \\
&= \frac{1}{\sqrt{1-2r \cos \theta + r^2}} e^{i \arctan(1-r \cos \theta, r \sin \theta)}
\end{aligned}$$

## 7.5 Graphing Functions of a Complex Variable

We cannot directly graph functions of a complex variable as they are mappings from  $\mathbb{R}^2$  to  $\mathbb{R}^2$ . To do so would require four dimensions. However, we can use a surface plot to graph the real part, the imaginary part, the modulus or the

argument of a function of a complex variable. Each of these are scalar fields, mappings from  $\mathbb{R}^2$  to  $\mathbb{R}$ .

**Example 7.5.1** Consider the identity function,  $f(z) = z$ . In Cartesian coordinates and Cartesian form, the function is  $f(z) = x + iy$ . The real and imaginary components are  $u(x, y) = x$  and  $v(x, y) = y$ . (See Figure 7.9.) In modulus

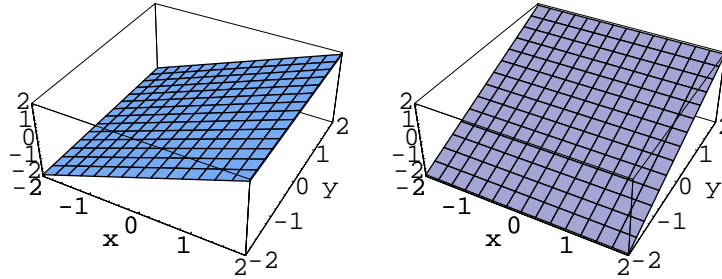

Figure 7.9: The real and imaginary parts of  $f(z) = z = x + iy$ .

argument form the function is

$$f(z) = z = r e^{i\theta} = \sqrt{x^2 + y^2} e^{i \arctan(x, y)}.$$

The modulus of  $f(z)$  is a single-valued function which is the distance from the origin. The argument of  $f(z)$  is a multi-valued function. Recall that  $\arctan(x, y)$  has an infinite number of values each of which differ by an integer multiple of  $2\pi$ . A few branches of  $\arg(f(z))$  are plotted in Figure 7.10. The modulus and principal argument of  $f(z) = z$  are plotted in Figure 7.11.

**Example 7.5.2** Consider the function  $f(z) = z^2$ . In Cartesian coordinates and separated into its real and imaginary components the function is

$$f(z) = z^2 = (x + iy)^2 = (x^2 - y^2) + i2xy.$$

Figure 7.12 shows surface plots of the real and imaginary parts of  $z^2$ . The magnitude of  $z^2$  is

$$|z^2| = \sqrt{z^2 \bar{z}^2} = z \bar{z} = (x + iy)(x - iy) = x^2 + y^2.$$

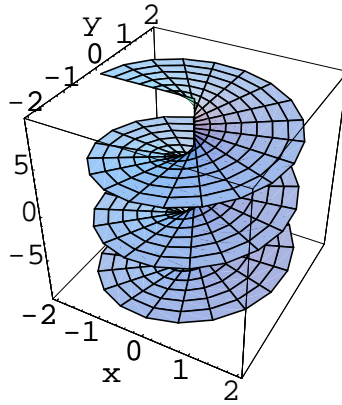

Figure 7.10: A few branches of  $\arg(z)$ .

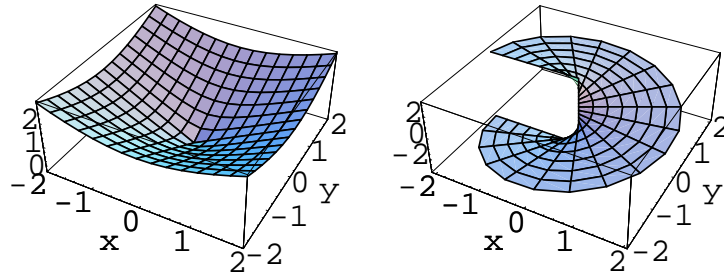

Figure 7.11: Plots of  $|z|$  and  $\text{Arg}(z)$ .

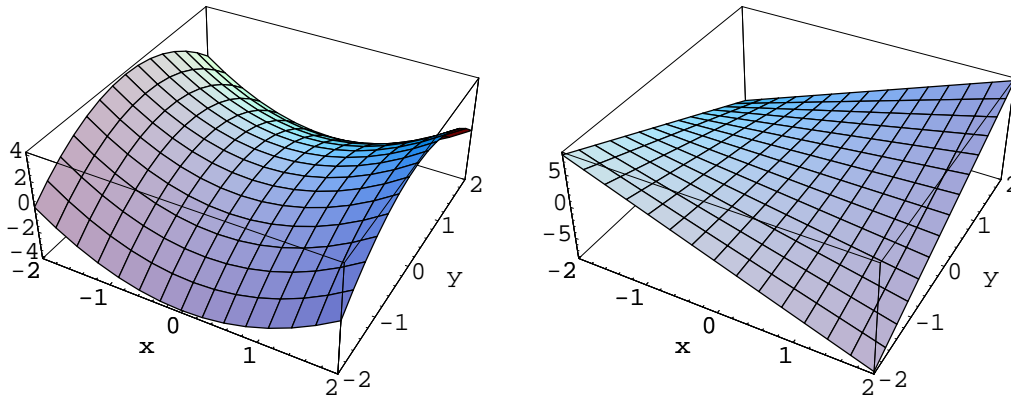

Figure 7.12: Plots of  $\Re(z^2)$  and  $\Im(z^2)$ .

Note that

$$z^2 = (r e^{i\theta})^2 = r^2 e^{i2\theta}.$$

In Figure 7.13 are plots of  $|z^2|$  and a branch of  $\arg(z^2)$ .

## 7.6 Trigonometric Functions

**The exponential function.** Consider the exponential function  $e^z$ . We can use Euler's formula to write  $e^z = e^{x+iy}$  in terms of its real and imaginary parts.

$$e^z = e^{x+iy} = e^x e^{iy} = e^x \cos y + i e^x \sin y$$

From this we see that the exponential function is  $i2\pi$  periodic:  $e^{z+i2\pi} = e^z$ , and  $i\pi$  odd periodic:  $e^{z+i\pi} = -e^z$ . Figure 7.14 has surface plots of the real and imaginary parts of  $e^z$  which show this periodicity.

The modulus of  $e^z$  is a function of  $x$  alone.

$$|e^z| = |e^{x+iy}| = e^x$$

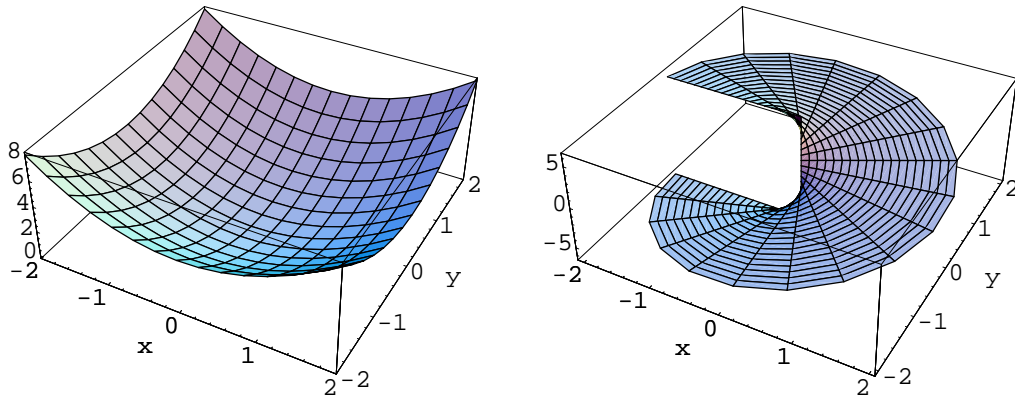

Figure 7.13: Plots of  $|z^2|$  and a branch of  $\arg(z^2)$ .

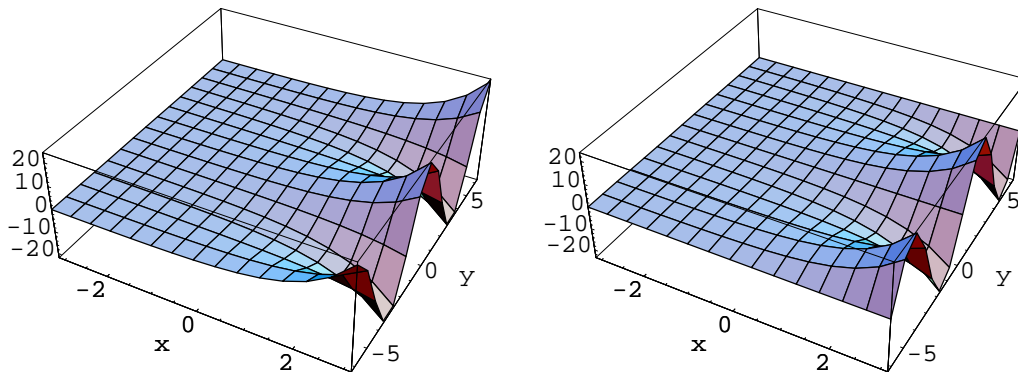

Figure 7.14: Plots of  $\Re(e^z)$  and  $\Im(e^z)$ .

The argument of  $e^z$  is a function of  $y$  alone.

$$\arg(e^z) = \arg(e^{x+iy}) = \{y + 2\pi n \mid n \in \mathbb{Z}\}$$

In Figure 7.15 are plots of  $|e^z|$  and a branch of  $\arg(e^z)$ .

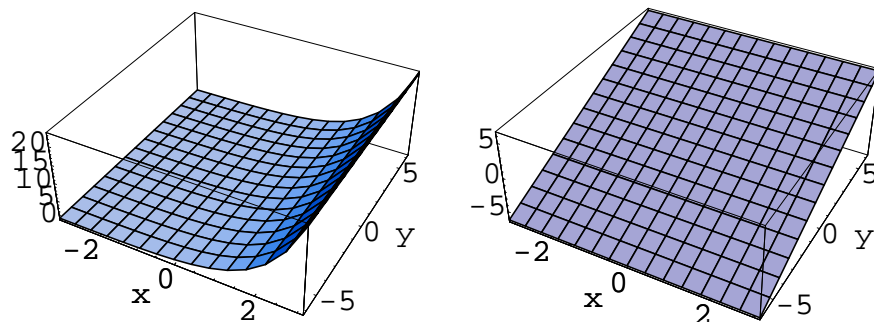

Figure 7.15: Plots of  $|e^z|$  and a branch of  $\arg(e^z)$ .

**Example 7.6.1** Show that the transformation  $w = e^z$  maps the infinite strip,  $-\infty < x < \infty$ ,  $0 < y < \pi$ , onto the upper half-plane.

**Method 1.** Consider the line  $z = x + ic$ ,  $-\infty < x < \infty$ . Under the transformation, this is mapped to

$$w = e^{x+ic} = e^{ic} e^x, \quad -\infty < x < \infty.$$

This is a ray from the origin to infinity in the direction of  $e^{ic}$ . Thus we see that  $z = x$  is mapped to the positive, real  $w$  axis,  $z = x + i\pi$  is mapped to the negative, real axis, and  $z = x + ic$ ,  $0 < c < \pi$  is mapped to a ray with angle  $c$  in the upper half-plane. Thus the strip is mapped to the upper half-plane. See Figure 7.16.

**Method 2.** Consider the line  $z = c + iy$ ,  $0 < y < \pi$ . Under the transformation, this is mapped to

$$w = e^{c+iy} = e^c e^{iy}, \quad 0 < y < \pi.$$

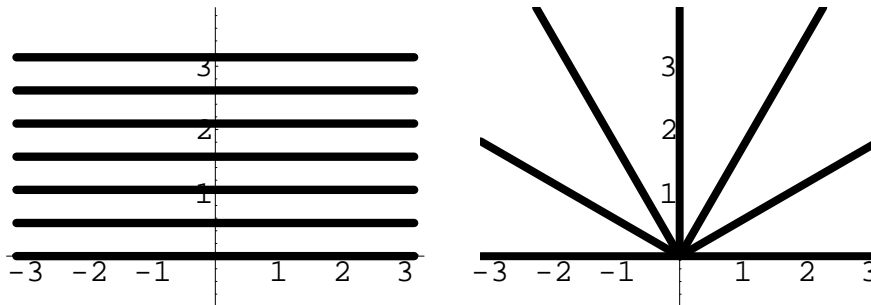

Figure 7.16:  $e^z$  maps horizontal lines to rays.

*This is a semi-circle in the upper half-plane of radius  $e^c$ . As  $c \rightarrow -\infty$ , the radius goes to zero. As  $c \rightarrow \infty$ , the radius goes to infinity. Thus the strip is mapped to the upper half-plane. See Figure 7.17.*

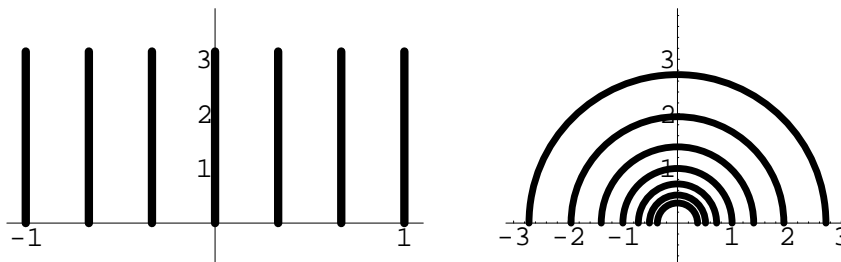

Figure 7.17:  $e^z$  maps vertical lines to circular arcs.

**The sine and cosine.** We can write the sine and cosine in terms of the exponential function.

$$\begin{aligned}\frac{e^{iz} + e^{-iz}}{2} &= \frac{\cos(z) + i \sin(z) + \cos(-z) + i \sin(-z)}{2} \\ &= \frac{\cos(z) + i \sin(z) + \cos(z) - i \sin(z)}{2} \\ &= \cos z\end{aligned}$$

$$\begin{aligned}\frac{e^{iz} - e^{-iz}}{i2} &= \frac{\cos(z) + i \sin(z) - \cos(-z) - i \sin(-z)}{2} \\ &= \frac{\cos(z) + i \sin(z) - \cos(z) + i \sin(z)}{2} \\ &= \sin z\end{aligned}$$

We separate the sine and cosine into their real and imaginary parts.

$$\cos z = \cos x \cosh y - i \sin x \sinh y \quad \sin z = \sin x \cosh y + i \cos x \sinh y$$

For fixed  $y$ , the sine and cosine are oscillatory in  $x$ . The amplitude of the oscillations grows with increasing  $|y|$ . See Figure 7.18 and Figure 7.19 for plots of the real and imaginary parts of the cosine and sine, respectively. Figure 7.20 shows the modulus of the cosine and the sine.

**The hyperbolic sine and cosine.** The hyperbolic sine and cosine have the familiar definitions in terms of the exponential function. Thus not surprisingly, we can write the sine in terms of the hyperbolic sine and write the cosine in terms of the hyperbolic cosine. Below is a collection of trigonometric identities.



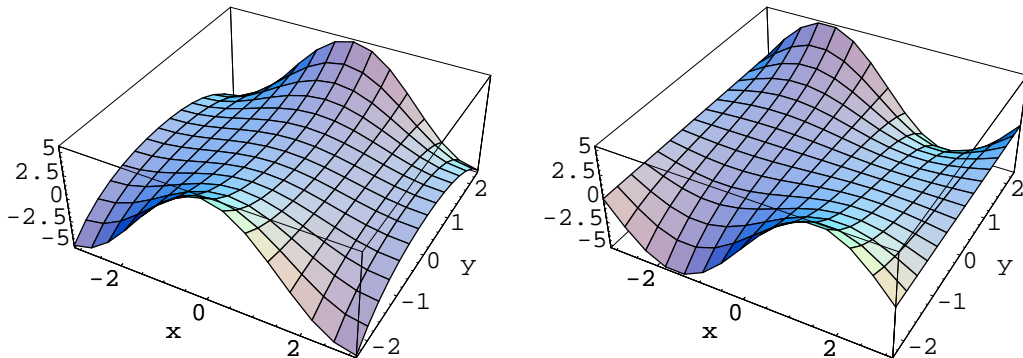

Figure 7.18: Plots of  $\Re(\cos(z))$  and  $\Im(\cos(z))$ .

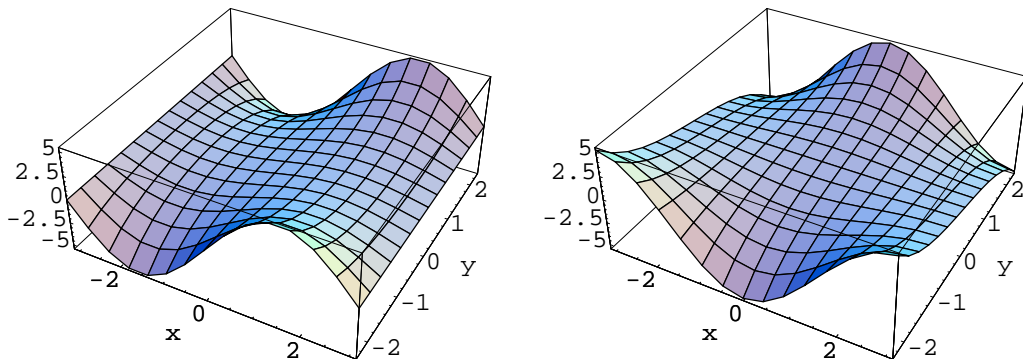

Figure 7.19: Plots of  $\Re(\sin(z))$  and  $\Im(\sin(z))$ .

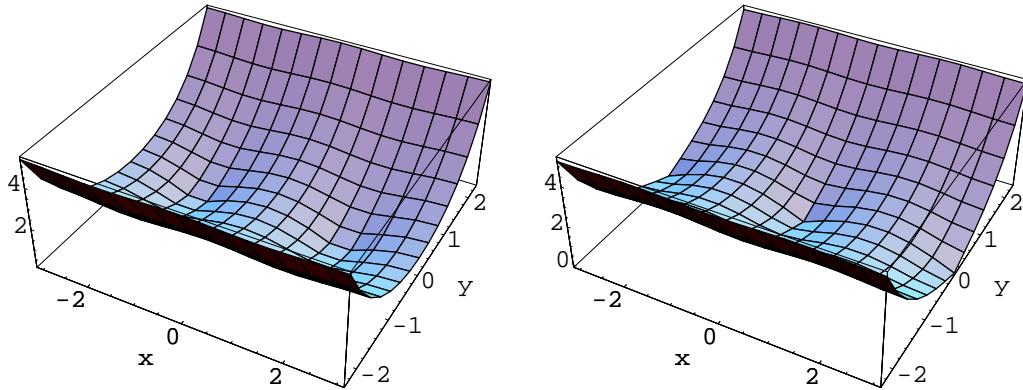

Figure 7.20: Plots of  $|\cos(z)|$  and  $|\sin(z)|$ .

### Result 7.6.1

$$e^z = e^x(\cos y + i \sin y)$$

$$\cos z = \frac{e^{iz} + e^{-iz}}{2}$$

$$\sin z = \frac{e^{iz} - e^{-iz}}{i2}$$

$$\cos z = \cos x \cosh y - i \sin x \sinh y$$

$$\sin z = \sin x \cosh y + i \cos x \sinh y$$

$$\cosh z = \frac{e^z + e^{-z}}{2}$$

$$\sinh z = \frac{e^z - e^{-z}}{2}$$

$$\cosh z = \cosh x \cos y + i \sinh x \sin y$$

$$\sinh z = \sinh x \cos y + i \cosh x \sin y$$

$$\sin(iz) = i \sinh z$$

$$\sinh(iz) = i \sin z$$

$$\cos(iz) = \cosh z$$

$$\cosh(iz) = \cos z$$

$$\log z = \ln |z| + i \arg(z) = \ln |z| + i \operatorname{Arg}(z) + i2\pi n, \quad n \in \mathbb{Z}$$

## 7.7 Inverse Trigonometric Functions

**The logarithm.** The logarithm,  $\log(z)$ , is defined as the inverse of the exponential function  $e^z$ . The exponential function is many-to-one and thus has a multi-valued inverse. From what we know of many-to-one functions, we conclude that

$$e^{\log z} = z, \quad \text{but} \quad \log(e^z) \neq z.$$

This is because  $e^{\log z}$  is single-valued but  $\log(e^z)$  is not. Because  $e^z$  is  $i2\pi$  periodic, the logarithm of a number is a set of numbers which differ by integer multiples of  $i2\pi$ . For instance,  $e^{i2\pi n} = 1$  so that  $\log(1) = \{i2\pi n : n \in \mathbb{Z}\}$ . The logarithmic function has an infinite number of branches. The value of the function on the branches differs by integer multiples of  $i2\pi$ . It has singularities at zero and infinity.  $|\log(z)| \rightarrow \infty$  as either  $z \rightarrow 0$  or  $z \rightarrow \infty$ .

We will derive the formula for the complex variable logarithm. For now, let  $\ln(x)$  denote the real variable logarithm that is defined for positive real numbers. Consider  $w = \log z$ . This means that  $e^w = z$ . We write  $w = u + iv$  in Cartesian form and  $z = r e^{i\theta}$  in polar form.

$$e^{u+iv} = r e^{i\theta}$$

We equate the modulus and argument of this expression.

$$\begin{aligned} e^u &= r & v &= \theta + 2\pi n \\ u &= \ln r & v &= \theta + 2\pi n \end{aligned}$$

With  $\log z = u + iv$ , we have a formula for the logarithm.

$$\boxed{\log z = \ln |z| + i \arg(z)}$$

If we write out the multi-valuedness of the argument function we note that this has the form that we expected.

$$\log z = \ln |z| + i(\text{Arg}(z) + 2\pi n), \quad n \in \mathbb{Z}$$

We check that our formula is correct by showing that  $e^{\log z} = z$

$$e^{\log z} = e^{\ln |z| + i \arg(z)} = e^{\ln r + i\theta + i2\pi n} = r e^{i\theta} = z$$

Note again that  $\log(e^z) \neq z$ .

$$\log(e^z) = \ln|e^z| + i \arg(e^z) = \ln(e^x) + i \arg(e^{x+iy}) = x + i(y + 2\pi n) = z + i2n\pi \neq z$$

The real part of the logarithm is the single-valued  $\ln r$ ; the imaginary part is the multi-valued  $\arg(z)$ . We define the principal branch of the logarithm  $\text{Log } z$  to be the branch that satisfies  $-\pi < \Im(\text{Log } z) \leq \pi$ . For positive, real numbers the principal branch,  $\text{Log } x$  is real-valued. We can write  $\text{Log } z$  in terms of the principal argument,  $\text{Arg } z$ .

$$\text{Log } z = \ln|z| + i \text{Arg}(z)$$

See Figure 7.21 for plots of the real and imaginary part of  $\text{Log } z$ .

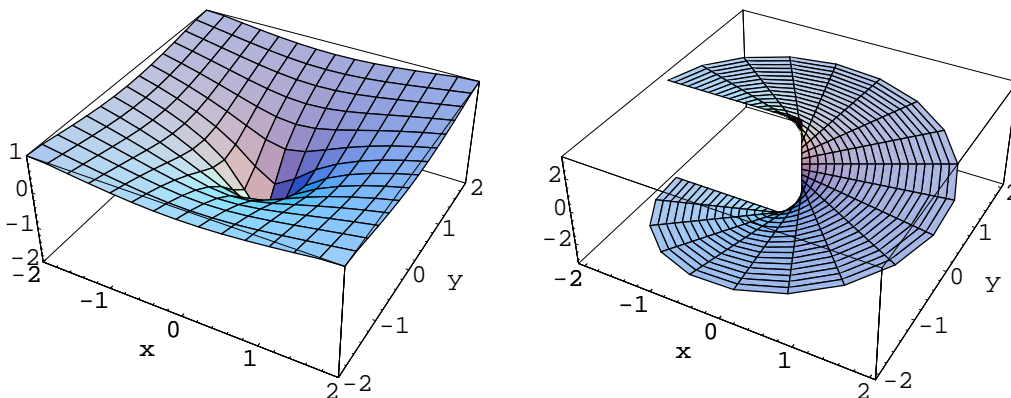

Figure 7.21: Plots of  $\Re(\text{Log } z)$  and  $\Im(\text{Log } z)$ .

**The form:  $a^b$ .** Consider  $a^b$  where  $a$  and  $b$  are complex and  $a$  is nonzero. We define this expression in terms of the exponential and the logarithm as

$$a^b = e^{b \log a}.$$

Note that the multi-valuedness of the logarithm may make  $a^b$  multi-valued. First consider the case that the exponent is an integer.

$$a^m = e^{m \log a} = e^{m(\operatorname{Log} a + i2n\pi)} = e^{m \operatorname{Log} a} e^{i2mn\pi} = e^{m \operatorname{Log} a}$$

Thus we see that  $a^m$  has a single value where  $m$  is an integer.

Now consider the case that the exponent is a rational number. Let  $p/q$  be a rational number in reduced form.

$$a^{p/q} = e^{\frac{p}{q} \log a} = e^{\frac{p}{q}(\operatorname{Log} a + i2n\pi)} = e^{\frac{p}{q} \operatorname{Log} a} e^{i2np\pi/q}.$$

This expression has  $q$  distinct values as

$$e^{i2np\pi/q} = e^{i2mp\pi/q} \quad \text{if and only if} \quad n = m \pmod{q}.$$

Finally consider the case that the exponent  $b$  is an irrational number.

$$a^b = e^{b \log a} = e^{b(\operatorname{Log} a + i2n\pi)} = e^{b \operatorname{Log} a} e^{i2bn\pi}$$

Note that  $e^{i2bn\pi}$  and  $e^{i2bm\pi}$  are equal if and only if  $i2bn\pi$  and  $i2bm\pi$  differ by an integer multiple of  $i2\pi$ , which means that  $bn$  and  $bm$  differ by an integer. This occurs only when  $n = m$ . Thus  $e^{i2bn\pi}$  has a distinct value for each different integer  $n$ . We conclude that  $a^b$  has an infinite number of values.

You may have noticed something a little fishy. If  $b$  is not an integer and  $a$  is any non-zero complex number, then  $a^b$  is multi-valued. Then why have we been treating  $e^b$  as single-valued, when it is merely the case  $a = e$ ? The answer is that in the realm of functions of a complex variable,  $e^z$  is an abuse of notation. We write  $e^z$  when we mean  $\exp(z)$ , the single-valued exponential function. Thus when we write  $e^z$  we do not mean “the number  $e$  raised to the  $z$  power”, we mean “the exponential function of  $z$ ”. We denote the former scenario as  $(e)^z$ , which is multi-valued.

**Logarithmic identities.** Back in high school trigonometry when you thought that the logarithm was only defined for positive real numbers you learned the identity  $\log x^a = a \log x$ . This identity doesn't hold when the logarithm is defined for nonzero complex numbers. Consider the logarithm of  $z^a$ .

$$\log z^a = \operatorname{Log} z^a + i2\pi n$$

$$a \log z = a(\operatorname{Log} z + i2\pi n) = a \operatorname{Log} z + i2a\pi n$$

Note that

$$\log z^a \neq a \log z$$

Furthermore, since

$$\operatorname{Log} z^a = \ln |z^a| + i \operatorname{Arg}(z^a), \quad a \operatorname{Log} z = a \ln |z| + ia \operatorname{Arg}(z)$$

and  $\operatorname{Arg}(z^a)$  is not necessarily the same as  $a \operatorname{Arg}(z)$  we see that

$$\operatorname{Log} z^a \neq a \operatorname{Log} z.$$

Consider the logarithm of a product.

$$\begin{aligned} \log(ab) &= \ln |ab| + i \arg(ab) \\ &= \ln |a| + \ln |b| + i \arg(a) + i \arg(b) \\ &= \log a + \log b \end{aligned}$$

There is not an analogous identity for the principal branch of the logarithm since  $\operatorname{Arg}(ab)$  is not in general the same as  $\operatorname{Arg}(a) + \operatorname{Arg}(b)$ .

Using  $\log(ab) = \log(a) + \log(b)$  we can deduce that  $\log(a^n) = \sum_{k=1}^n \log a = n \log a$ , where  $n$  is a positive integer. This result is simple, straightforward and wrong. I have led you down the merry path to damnation.<sup>3</sup> In fact,  $\log(a^2) \neq 2 \log a$ . Just write the multi-valuedness explicitly,

$$\log(a^2) = \operatorname{Log}(a^2) + i2n\pi, \quad 2 \log a = 2(\operatorname{Log} a + i2n\pi) = 2 \operatorname{Log} a + i4n\pi.$$

You can verify that

$$\log\left(\frac{1}{a}\right) = -\log a.$$

We can use this and the product identity to expand the logarithm of a quotient.

$$\log\left(\frac{a}{b}\right) = \log a - \log b$$

---

<sup>3</sup> Don't feel bad if you fell for it. The logarithm is a tricky bastard.

For general values of  $a$ ,  $\log z^a \neq a \log z$ . However, for some values of  $a$ , equality holds. We already know that  $a = 1$  and  $a = -1$  work. To determine if equality holds for other values of  $a$ , we explicitly write the multi-valuedness.

$$\begin{aligned}\log z^a &= \log (e^{a \log z}) = a \log z + i2\pi k, & k \in \mathbb{Z} \\ a \log z &= a \ln |z| + ia \operatorname{Arg} z + ia2\pi m, & m \in \mathbb{Z}\end{aligned}$$

We see that  $\log z^a = a \log z$  if and only if

$$\{am \mid m \in \mathbb{Z}\} = \{am + k \mid k, m \in \mathbb{Z}\}.$$

The sets are equal if and only if  $a = 1/n$ ,  $n \in \mathbb{Z}^\pm$ . Thus we have the identity:

$$\log (z^{1/n}) = \frac{1}{n} \log z, \quad n \in \mathbb{Z}^\pm$$

### Result 7.7.1 Logarithmic Identities.

$$a^b = e^{b \log a}$$

$$e^{\log z} = e^{\text{Log } z} = z$$

$$\log(ab) = \log a + \log b$$

$$\log(1/a) = -\log a$$

$$\log(a/b) = \log a - \log b$$

$$\log\left(z^{1/n}\right) = \frac{1}{n} \log z, \quad n \in \mathbb{Z}^{\pm}$$

### Logarithmic Inequalities.

$$\text{Log}(uv) \neq \text{Log}(u) + \text{Log}(v)$$

$$\log z^a \neq a \log z$$

$$\text{Log } z^a \neq a \text{Log } z$$

$$\log e^z \neq z$$

**Example 7.7.1** Consider  $1^\pi$ . We apply the definition  $a^b = e^{b \log a}$ .

$$\begin{aligned} 1^\pi &= e^{\pi \log(1)} \\ &= e^{\pi(\ln(1) + i2n\pi)} \\ &= e^{i2n\pi^2} \end{aligned}$$

Thus we see that  $1^\pi$  has an infinite number of values, all of which lie on the unit circle  $|z| = 1$  in the complex plane. However, the set  $1^\pi$  is not equal to the set  $|z| = 1$ . There are points in the latter which are not in the former. This is analogous to the fact that the rational numbers are dense in the real numbers, but are a subset of the real numbers.



**Example 7.7.2** We find the zeros of  $\sin z$ .

$$\begin{aligned}\sin z &= \frac{e^{iz} - e^{-iz}}{i2} = 0 \\ e^{iz} &= e^{-iz} \\ e^{i2z} &= 1 \\ 2z \pmod{2\pi} &= 0 \\ \boxed{z = n\pi, \quad n \in \mathbb{Z}}\end{aligned}$$

Equivalently, we could use the identity

$$\sin z = \sin x \cosh y + i \cos x \sinh y = 0.$$

This becomes the two equations (for the real and imaginary parts)

$$\sin x \cosh y = 0 \quad \text{and} \quad \cos x \sinh y = 0.$$

Since  $\cosh$  is real-valued and positive for real argument, the first equation dictates that  $x = n\pi$ ,  $n \in \mathbb{Z}$ . Since  $\cos(n\pi) = (-1)^n$  for  $n \in \mathbb{Z}$ , the second equation implies that  $\sinh y = 0$ . For real argument,  $\sinh y$  is only zero at  $y = 0$ . Thus the zeros are

$$\boxed{z = n\pi, \quad n \in \mathbb{Z}}$$

**Example 7.7.3** Since we can express  $\sin z$  in terms of the exponential function, one would expect that we could express

the  $\sin^{-1} z$  in terms of the logarithm.

$$\begin{aligned}
 w &= \sin^{-1} z \\
 z &= \sin w \\
 z &= \frac{e^{iw} - e^{-iw}}{i2} \\
 e^{i2w} - i2z e^{iw} - 1 &= 0 \\
 e^{iw} &= iz \pm \sqrt{1 - z^2} \\
 w &= -i \log \left( iz \pm \sqrt{1 - z^2} \right)
 \end{aligned}$$

Thus we see how the multi-valued  $\sin^{-1}$  is related to the logarithm.

$$\boxed{\sin^{-1} z = -i \log \left( iz \pm \sqrt{1 - z^2} \right)}$$

**Example 7.7.4** Consider the equation  $\sin^3 z = 1$ .

$$\begin{aligned}
 \sin^3 z &= 1 \\
 \sin z &= 1^{1/3} \\
 \frac{e^{iz} - e^{-iz}}{i2} &= 1^{1/3} \\
 e^{iz} - i2(1)^{1/3} - e^{-iz} &= 0 \\
 e^{i2z} - i2(1)^{1/3} e^{iz} - 1 &= 0 \\
 e^{iz} &= \frac{i2(1)^{1/3} \pm \sqrt{-4(1)^{2/3} + 4}}{2} \\
 e^{iz} &= i(1)^{1/3} \pm \sqrt{1 - (1)^{2/3}}
 \end{aligned}$$

$$\boxed{z = -i \log \left( i(1)^{1/3} \pm \sqrt{1 - 1^{2/3}} \right)}$$

Note that there are three sources of multi-valuedness in the expression for  $z$ . The two values of the square root are shown explicitly. There are three cube roots of unity. Finally, the logarithm has an infinite number of branches. To show this multi-valuedness explicitly, we could write

$$z = -i \operatorname{Log} \left( i e^{i2m\pi/3} \pm \sqrt{1 - e^{i4m\pi/3}} \right) + 2\pi n, \quad m = 0, 1, 2, \quad n = \dots, -1, 0, 1, \dots$$

**Example 7.7.5** Consider the harmless looking equation,  $i^z = 1$ .

Before we start with the algebra, note that the right side of the equation is a single number.  $i^z$  is single-valued only when  $z$  is an integer. Thus we know that if there are solutions for  $z$ , they are integers. We now proceed to solve the equation.

$$i^z = 1$$

$$(e^{i\pi/2})^z = 1$$

Use the fact that  $z$  is an integer.

$$e^{i\pi z/2} = 1$$

$$i\pi z/2 = i2n\pi, \quad \text{for some } n \in \mathbb{Z}$$

$$z = 4n, \quad n \in \mathbb{Z}$$

Here is a different approach. We write down the multi-valued form of  $i^z$ . We solve the equation by requiring that all the values of  $i^z$  are 1.

$$i^z = 1$$

$$e^{z \log i} = 1$$

$$z \log i = i2\pi n, \quad \text{for some } n \in \mathbb{Z}$$

$$z \left( i\frac{\pi}{2} + i2\pi m \right) = i2\pi n, \quad \forall m \in \mathbb{Z}, \quad \text{for some } n \in \mathbb{Z}$$

$$i\frac{\pi}{2}z + i2\pi m z = i2\pi n, \quad \forall m \in \mathbb{Z}, \quad \text{for some } n \in \mathbb{Z}$$

The only solutions that satisfy the above equation are

$$z = 4k, \quad k \in \mathbb{Z}.$$

Now let's consider a slightly different problem:  $1 \in i^z$ . For what values of  $z$  does  $i^z$  have 1 as one of its values.

$$\begin{aligned} 1 &\in i^z \\ 1 &\in e^{z \log i} \\ 1 &\in \{e^{z(i\pi/2 + i2\pi n)} \mid n \in \mathbb{Z}\} \\ z(i\pi/2 + i2\pi n) &= i2\pi m, \quad m, n \in \mathbb{Z} \end{aligned}$$

$$z = \frac{4m}{1 + 4n}, \quad m, n \in \mathbb{Z}$$

There are an infinite set of rational numbers for which  $i^z$  has 1 as one of its values. For example,

$$i^{4/5} = 1^{1/5} = \{1, e^{i2\pi/5}, e^{i4\pi/5}, e^{i6\pi/5}, e^{i8\pi/5}\}$$

## 7.8 Riemann Surfaces

Consider the mapping  $w = \log(z)$ . Each nonzero point in the  $z$ -plane is mapped to an infinite number of points in the  $w$  plane.

$$w = \{\ln |z| + i \arg(z)\} = \{\ln |z| + i(\text{Arg}(z) + 2\pi n) \mid n \in \mathbb{Z}\}$$

This multi-valuedness makes it hard to work with the logarithm. We would like to select one of the branches of the logarithm. One way of doing this is to decompose the  $z$ -plane into an infinite number of sheets. The sheets lie above one another and are labeled with the integers,  $n \in \mathbb{Z}$ . (See Figure 7.22.) We label the point  $z$  on the  $n^{\text{th}}$  sheet as  $(z, n)$ . Now each point  $(z, n)$  maps to a single point in the  $w$ -plane. For instance, we can make the zeroth sheet map to the principal branch of the logarithm. This would give us the following mapping.

$$\log(z, n) = \text{Log } z + i2\pi n$$

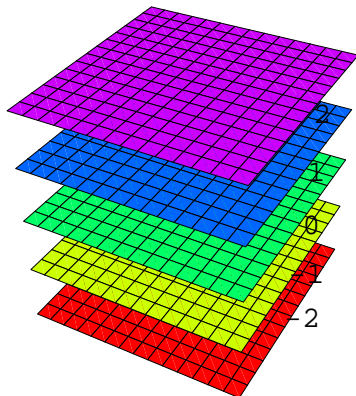

Figure 7.22: The  $z$ -plane decomposed into flat sheets.

This is a nice idea, but it has some problems. The mappings are not continuous. Consider the mapping on the zeroth sheet. As we approach the negative real axis from above  $z$  is mapped to  $\ln|z| + i\pi$  as we approach from below it is mapped to  $\ln|z| - i\pi$ . (Recall Figure 7.21.) The mapping is not continuous across the negative real axis.

Let's go back to the regular  $z$ -plane for a moment. We start at the point  $z = 1$  and selecting the branch of the logarithm that maps to zero. ( $\log(1) = i2\pi n$ ). We make the logarithm vary continuously as we walk around the origin once in the positive direction and return to the point  $z = 1$ . Since the argument of  $z$  has increased by  $2\pi$ , the value of the logarithm has changed to  $i2\pi$ . If we walk around the origin again we will have  $\log(1) = i4\pi$ . Our flat sheet decomposition of the  $z$ -plane does not reflect this property. We need a decomposition with a geometry that makes the mapping continuous and connects the various branches of the logarithm.

Drawing inspiration from the plot of  $\arg(z)$ , Figure 7.10, we decompose the  $z$ -plane into an infinite corkscrew with axis at the origin. (See Figure 7.23.) We define the mapping so that the logarithm varies continuously on this surface. Consider a point  $z$  on one of the sheets. The value of the logarithm at that same point on the sheet directly above it is  $i2\pi$  more than the original value. We call this surface, the *Riemann surface* for the logarithm. The mapping from the Riemann surface to the  $w$ -plane is continuous and one-to-one.

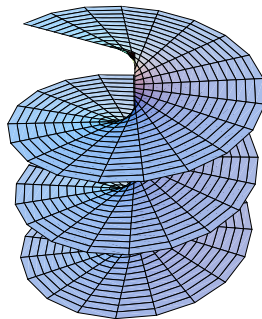

Figure 7.23: The Riemann surface for the logarithm.

## 7.9 Branch Points

**Example 7.9.1** Consider the function  $z^{1/2}$ . For each value of  $z$ , there are two values of  $z^{1/2}$ . We write  $z^{1/2}$  in modulus-argument and Cartesian form.

$$z^{1/2} = \sqrt{|z|} e^{i \arg(z)/2}$$

$$z^{1/2} = \sqrt{|z|} \cos(\arg(z)/2) + i \sqrt{|z|} \sin(\arg(z)/2)$$

Figure 7.24 shows the real and imaginary parts of  $z^{1/2}$  from three different viewpoints. The second and third views are looking down the  $x$  axis and  $y$  axis, respectively. Consider  $\Re(z^{1/2})$ . This is a double layered sheet which intersects itself on the negative real axis. ( $\Im(z^{1/2})$  has a similar structure, but intersects itself on the positive real axis.) Let's start at a point on the positive real axis on the lower sheet. If we walk around the origin once and return to the positive real axis, we will be on the upper sheet. If we do this again, we will return to the lower sheet.

Suppose we are at a point in the complex plane. We pick one of the two values of  $z^{1/2}$ . If the function varies continuously as we walk around the origin and back to our starting point, the value of  $z^{1/2}$  will have changed. We will

be on the other branch. Because walking around the point  $z = 0$  takes us to a different branch of the function, we refer to  $z = 0$  as a branch point.

Now consider the modulus-argument form of  $z^{1/2}$ :

$$z^{1/2} = \sqrt{|z|} e^{i \arg(z)/2}.$$

Figure 7.25 shows the modulus and the principal argument of  $z^{1/2}$ . We see that each time we walk around the origin, the argument of  $z^{1/2}$  changes by  $\pi$ . This means that the value of the function changes by the factor  $e^{i\pi} = -1$ , i.e. the function changes sign. If we walk around the origin twice, the argument changes by  $2\pi$ , so that the value of the function does not change,  $e^{i2\pi} = 1$ .

$z^{1/2}$  is a continuous function except at  $z = 0$ . Suppose we start at  $z = 1 = e^{i0}$  and the function value  $(e^{i0})^{1/2} = 1$ . If we follow the first path in Figure 7.26, the argument of  $z$  varies from up to about  $\frac{\pi}{4}$ , down to about  $-\frac{\pi}{4}$  and back to 0. The value of the function is still  $(e^{i0})^{1/2}$ .

Now suppose we follow a circular path around the origin in the positive, counter-clockwise, direction. (See the second path in Figure 7.26.) The argument of  $z$  increases by  $2\pi$ . The value of the function at half turns on the path is

$$\begin{aligned} (e^{i0})^{1/2} &= 1, \\ (e^{i\pi})^{1/2} &= e^{i\pi/2} = i, \\ (e^{i2\pi})^{1/2} &= e^{i\pi} = -1 \end{aligned}$$

As we return to the point  $z = 1$ , the argument of the function has changed by  $\pi$  and the value of the function has changed from 1 to  $-1$ . If we were to walk along the circular path again, the argument of  $z$  would increase by another  $2\pi$ . The argument of the function would increase by another  $\pi$  and the value of the function would return to 1.

$$(e^{i4\pi})^{1/2} = e^{i2\pi} = 1$$

In general, any time we walk around the origin, the value of  $z^{1/2}$  changes by the factor  $-1$ . We call  $z = 0$  a branch point. If we want a single-valued square root, we need something to prevent us from walking around the origin. We achieve this by introducing a branch cut. Suppose we have the complex plane drawn on an infinite sheet of paper. With a scissors we cut the paper from the origin to  $-\infty$  along the real axis. Then if we start at  $z = e^{i0}$ , and draw a

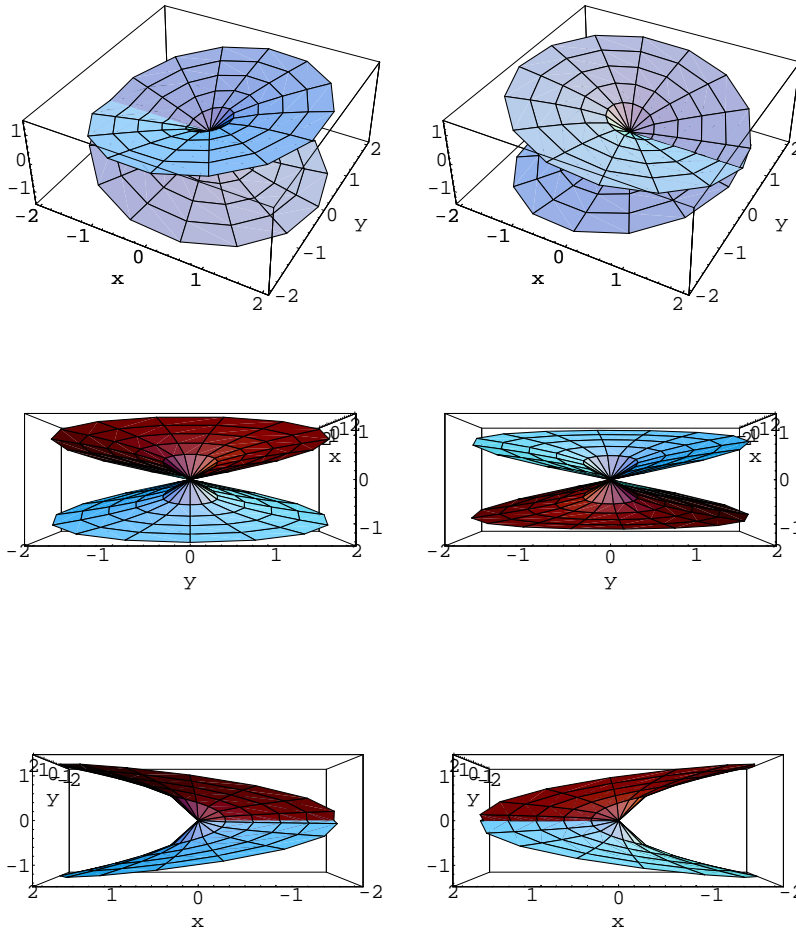

Figure 7.24: Plots of  $\Re(z^{1/2})$  (left) and  $\Im(z^{1/2})$  (right) from three viewpoints.



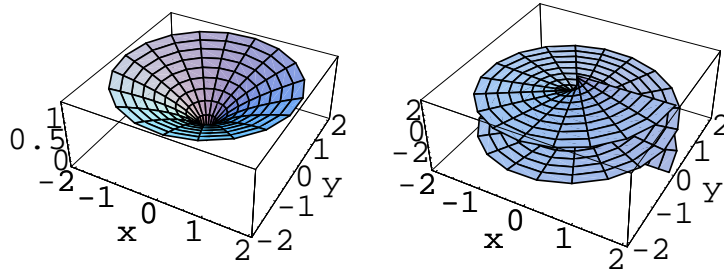

Figure 7.25: Plots of  $|z^{1/2}|$  and  $\text{Arg}(z^{1/2})$ .

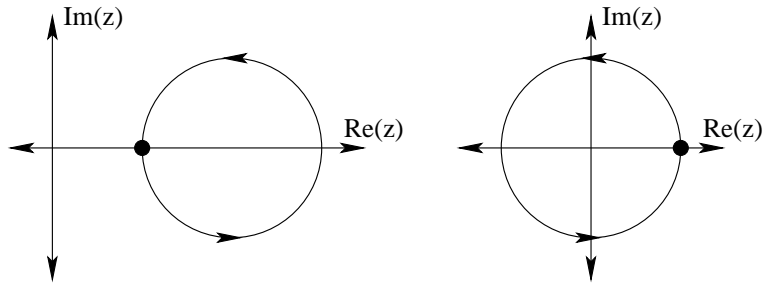

Figure 7.26: A path that does not encircle the origin and a path around the origin.

continuous line without leaving the paper, the argument of  $z$  will always be in the range  $-\pi < \arg z < \pi$ . This means that  $-\frac{\pi}{2} < \arg(z^{1/2}) < \frac{\pi}{2}$ . No matter what path we follow in this cut plane,  $z = 1$  has argument zero and  $(1)^{1/2} = 1$ . By never crossing the negative real axis, we have constructed a single valued **branch** of the square root function. We call the cut along the negative real axis a **branch cut**.

**Example 7.9.2** Consider the logarithmic function  $\log z$ . For each value of  $z$ , there are an infinite number of values of  $\log z$ . We write  $\log z$  in Cartesian form.

$$\log z = \ln |z| + i \arg z$$

Figure 7.27 shows the real and imaginary parts of the logarithm. The real part is single-valued. The imaginary part is multi-valued and has an infinite number of branches. The values of the logarithm form an infinite-layered sheet. If we start on one of the sheets and walk around the origin once in the positive direction, then the value of the logarithm increases by  $i2\pi$  and we move to the next branch.  $z = 0$  is a branch point of the logarithm.

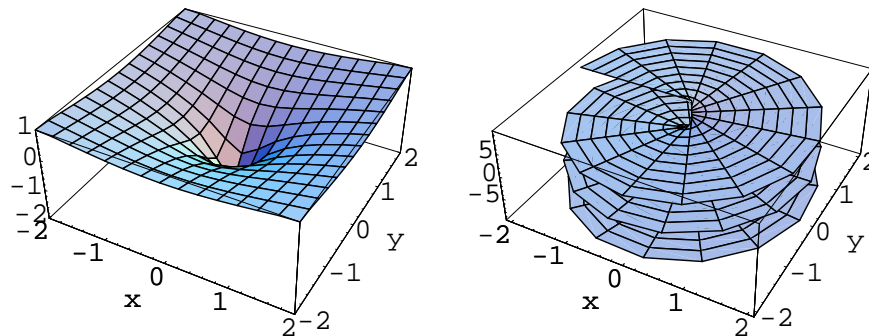

Figure 7.27: Plots of  $\Re(\log z)$  and a portion of  $\Im(\log z)$ .

The logarithm is a continuous function except at  $z = 0$ . Suppose we start at  $z = 1 = e^{i0}$  and the function value  $\log(e^{i0}) = \ln(1) + i0 = 0$ . If we follow the first path in Figure 7.26, the argument of  $z$  and thus the imaginary part of the logarithm varies from up to about  $\frac{\pi}{4}$ , down to about  $-\frac{\pi}{4}$  and back to 0. The value of the logarithm is still 0.

Now suppose we follow a circular path around the origin in the positive direction. (See the second path in Figure 7.26.) The argument of  $z$  increases by  $2\pi$ . The value of the logarithm at half turns on the path is

$$\begin{aligned}\log(e^{i0}) &= 0, \\ \log(e^{i\pi}) &= i\pi, \\ \log(e^{i2\pi}) &= i2\pi\end{aligned}$$

As we return to the point  $z = 1$ , the value of the logarithm has changed by  $i2\pi$ . If we were to walk along the circular path again, the argument of  $z$  would increase by another  $2\pi$  and the value of the logarithm would increase by another  $i2\pi$ .

**Result 7.9.1** A point  $z_0$  is a **branch point** of a function  $f(z)$  if the function changes value when you walk around the point on any path that encloses no singularities other than the one at  $z = z_0$ .

**Branch points at infinity : mapping infinity to the origin.** Up to this point we have considered only branch points in the finite plane. Now we consider the possibility of a branch point at infinity. As a first method of approaching this problem we map the point at infinity to the origin with the transformation  $\zeta = 1/z$  and examine the point  $\zeta = 0$ .

**Example 7.9.3** Again consider the function  $z^{1/2}$ . Mapping the point at infinity to the origin, we have  $f(\zeta) = (1/\zeta)^{1/2} = \zeta^{-1/2}$ . For each value of  $\zeta$ , there are two values of  $\zeta^{-1/2}$ . We write  $\zeta^{-1/2}$  in modulus-argument form.

$$\zeta^{-1/2} = \frac{1}{\sqrt{|\zeta|}} e^{-i \arg(\zeta)/2}$$

Like  $z^{1/2}$ ,  $\zeta^{-1/2}$  has a double-layered sheet of values. Figure 7.28 shows the modulus and the principal argument of  $\zeta^{-1/2}$ . We see that each time we walk around the origin, the argument of  $\zeta^{-1/2}$  changes by  $-\pi$ . This means that the value of the function changes by the factor  $e^{-i\pi} = -1$ , i.e. the function changes sign. If we walk around the origin twice, the argument changes by  $-2\pi$ , so that the value of the function does not change,  $e^{-i2\pi} = 1$ .

Since  $\zeta^{-1/2}$  has a branch point at zero, we conclude that  $z^{1/2}$  has a branch point at infinity.

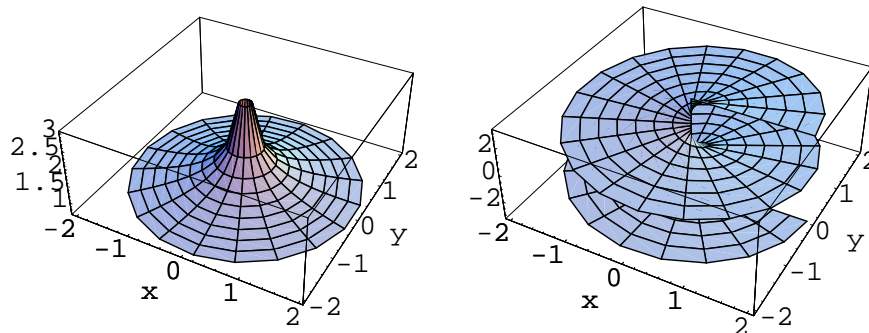

Figure 7.28: Plots of  $|\zeta^{-1/2}|$  and  $\text{Arg}(\zeta^{-1/2})$ .

**Example 7.9.4** Again consider the logarithmic function  $\log z$ . Mapping the point at infinity to the origin, we have  $f(\zeta) = \log(1/\zeta) = -\log(\zeta)$ . From Example 7.9.2 we know that  $-\log(\zeta)$  has a branch point at  $\zeta = 0$ . Thus  $\log z$  has a branch point at infinity.

**Branch points at infinity : paths around infinity.** We can also check for a branch point at infinity by following a path that encloses the point at infinity and no other singularities. Just draw a simple closed curve that separates the complex plane into a bounded component that contains all the singularities of the function in the finite plane. Then, depending on orientation, the curve is a contour enclosing all the finite singularities, or the point at infinity and no other singularities.

**Example 7.9.5** Once again consider the function  $z^{1/2}$ . We know that the function changes value on a curve that goes once around the origin. Such a curve can be considered to be either a path around the origin or a path around infinity. In either case the path encloses one singularity. There are branch points at the origin and at infinity. Now consider a curve that does not go around the origin. Such a curve can be considered to be either a path around neither of the branch points or both of them. Thus we see that  $z^{1/2}$  does not change value when we follow a path that encloses neither or both of its branch points.

**Example 7.9.6** Consider  $f(z) = (z^2 - 1)^{1/2}$ . We factor the function.

$$f(z) = (z - 1)^{1/2}(z + 1)^{1/2}$$

There are branch points at  $z = \pm 1$ . Now consider the point at infinity.

$$f(\zeta^{-1}) = (\zeta^{-2} - 1)^{1/2} = \pm \zeta^{-1} (1 - \zeta^2)^{1/2}$$

Since  $f(\zeta^{-1})$  does not have a branch point at  $\zeta = 0$ ,  $f(z)$  does not have a branch point at infinity. We could reach the same conclusion by considering a path around infinity. Consider a path that circles the branch points at  $z = \pm 1$  once in the positive direction. Such a path circles the point at infinity once in the negative direction. In traversing this path, the value of  $f(z)$  is multiplied by the factor  $(e^{i2\pi})^{1/2} (e^{i2\pi})^{1/2} = e^{i2\pi} = 1$ . Thus the value of the function does not change. There is no branch point at infinity.

**Diagnosing branch points.** We have the definition of a branch point, but we do not have a convenient criterion for determining if a particular function has a branch point. We have seen that  $\log z$  and  $z^\alpha$  for non-integer  $\alpha$  have branch points at zero and infinity. The inverse trigonometric functions like the arcsine also have branch points, but they can be written in terms of the logarithm and the square root. In fact all the elementary functions with branch points can be written in terms of the functions  $\log z$  and  $z^\alpha$ . Furthermore, note that the multi-valuedness of  $z^\alpha$  comes from the logarithm,  $z^\alpha = e^{\alpha \log z}$ . This gives us a way of quickly determining if and where a function may have branch points.

**Result 7.9.2** Let  $f(z)$  be a single-valued function. Then  $\log(f(z))$  and  $(f(z))^\alpha$  may have branch points only where  $f(z)$  is zero or singular.

**Example 7.9.7** Consider the functions,

1.  $(z^2)^{1/2}$
2.  $(z^{1/2})^2$
3.  $(z^{1/2})^3$

Are they multi-valued? Do they have branch points?

1.

$$(z^2)^{1/2} = \pm\sqrt{z^2} = \pm z$$

Because of the  $(\cdot)^{1/2}$ , the function is multi-valued. The only possible branch points are at zero and infinity. If  $\left((e^{i0})^2\right)^{1/2} = 1$ , then  $\left((e^{i2\pi})^2\right)^{1/2} = (e^{i4\pi})^{1/2} = e^{i2\pi} = 1$ . Thus we see that the function does not change value when we walk around the origin. We can also consider this to be a path around infinity. This function is multi-valued, but has no branch points.

2.

$$(z^{1/2})^2 = (\pm\sqrt{z})^2 = z$$

This function is single-valued.

3.

$$(z^{1/2})^3 = (\pm\sqrt{z})^3 = \pm(\sqrt{z})^3$$

This function is multi-valued. We consider the possible branch point at  $z = 0$ . If  $\left((e^0)^{1/2}\right)^3 = 1$ , then  $\left((e^{i2\pi})^{1/2}\right)^3 = (e^{i\pi})^3 = e^{i3\pi} = -1$ . Since the function changes value when we walk around the origin, it has a branch point at  $z = 0$ . Since this is also a path around infinity, there is a branch point there.

**Example 7.9.8** Consider the function  $f(z) = \log\left(\frac{1}{z-1}\right)$ . Since  $\frac{1}{z-1}$  is only zero at infinity and its only singularity is at  $z = 1$ , the only possibilities for branch points are at  $z = 1$  and  $z = \infty$ . Since

$$\log\left(\frac{1}{z-1}\right) = -\log(z-1)$$

and  $\log w$  has branch points at zero and infinity, we see that  $f(z)$  has branch points at  $z = 1$  and  $z = \infty$ .

**Example 7.9.9** Consider the functions,

1.  $e^{\log z}$

2.  $\log e^z$ .

Are they multi-valued? Do they have branch points?

1.

$$e^{\log z} = \exp(\text{Log } z + i2\pi n) = e^{\text{Log } z} e^{i2\pi n} = z$$

*This function is single-valued.*

2.

$$\log e^z = \text{Log } e^z + i2\pi n = z + i2\pi n$$

*This function is multi-valued. It may have branch points only where  $e^z$  is zero or infinite. This only occurs at  $z = \infty$ . Thus there are no branch points in the finite plane. The function does not change when traversing a simple closed path. Since this path can be considered to enclose infinity, there is no branch point at infinity.*

Consider  $(f(z))^\alpha$  where  $f(z)$  is single-valued and  $f(z)$  has either a zero or a singularity at  $z = z_0$ .  $(f(z))^\alpha$  may have a branch point at  $z = z_0$ . If  $f(z)$  is not a power of  $z$ , then it may be difficult to tell if  $(f(z))^\alpha$  changes value when we walk around  $z_0$ . Factor  $f(z)$  into  $f(z) = g(z)h(z)$  where  $h(z)$  is nonzero and finite at  $z_0$ . Then  $g(z)$  captures the important behavior of  $f(z)$  at the  $z_0$ .  $g(z)$  tells us how fast  $f(z)$  vanishes or blows up. Since  $(f(z))^\alpha = (g(z))^\alpha (h(z))^\alpha$  and  $(h(z))^\alpha$  does not have a branch point at  $z_0$ ,  $(f(z))^\alpha$  has a branch point at  $z_0$  if and only if  $(g(z))^\alpha$  has a branch point there.

Similarly, we can decompose

$$\log(f(z)) = \log(g(z)h(z)) = \log(g(z)) + \log(h(z))$$

to see that  $\log(f(z))$  has a branch point at  $z_0$  if and only if  $\log(g(z))$  has a branch point there.

**Result 7.9.3** Consider a single-valued function  $f(z)$  that has either a zero or a singularity at  $z = z_0$ . Let  $f(z) = g(z)h(z)$  where  $h(z)$  is nonzero and finite.  $(f(z))^\alpha$  has a branch point at  $z = z_0$  if and only if  $(g(z))^\alpha$  has a branch point there.  $\log(f(z))$  has a branch point at  $z = z_0$  if and only if  $\log(g(z))$  has a branch point there.

**Example 7.9.10** Consider the functions,

1.  $\sin z^{1/2}$
2.  $(\sin z)^{1/2}$
3.  $z^{1/2} \sin z^{1/2}$
4.  $(\sin z^2)^{1/2}$

Find the branch points and the number of branches.

1.

$$\sin z^{1/2} = \sin(\pm\sqrt{z}) = \pm \sin \sqrt{z}$$

$\sin z^{1/2}$  is multi-valued. It has two branches. There may be branch points at zero and infinity. Consider the unit circle which is a path around the origin or infinity. If  $\sin\left((e^{i0})^{1/2}\right) = \sin(1)$ , then  $\sin\left((e^{i2\pi})^{1/2}\right) = \sin(e^{i\pi}) = \sin(-1) = -\sin(1)$ . There are branch points at the origin and infinity.

2.

$$(\sin z)^{1/2} = \pm\sqrt{\sin z}$$

The function is multi-valued with two branches. The sine vanishes at  $z = n\pi$  and is singular at infinity. There could be branch points at these locations. Consider the point  $z = n\pi$ . We can write

$$\sin z = (z - n\pi) \frac{\sin z}{z - n\pi}$$

Note that  $\frac{\sin z}{z - n\pi}$  is nonzero and has a removable singularity at  $z = n\pi$ .

$$\lim_{z \rightarrow n\pi} \frac{\sin z}{z - n\pi} = \lim_{z \rightarrow n\pi} \frac{\cos z}{1} = (-1)^n$$

Since  $(z - n\pi)^{1/2}$  has a branch point at  $z = n\pi$ ,  $(\sin z)^{1/2}$  has branch points at  $z = n\pi$ .



Since the branch points at  $z = n\pi$  go all the way out to infinity. It is not possible to make a path that encloses infinity and no other singularities. The point at infinity is a non-isolated singularity. A point can be a branch point only if it is an isolated singularity.

3.

$$\begin{aligned} z^{1/2} \sin z^{1/2} &= \pm\sqrt{z} \sin(\pm\sqrt{z}) \\ &= \pm\sqrt{z} (\pm \sin \sqrt{z}) \\ &= \sqrt{z} \sin \sqrt{z} \end{aligned}$$

The function is single-valued. Thus there could be no branch points.

4.

$$(\sin z^2)^{1/2} = \pm\sqrt{\sin z^2}$$

This function is multi-valued. Since  $\sin z^2 = 0$  at  $z = (n\pi)^{1/2}$ , there may be branch points there. First consider the point  $z = 0$ . We can write

$$\sin z^2 = z^2 \frac{\sin z^2}{z^2}$$

where  $\sin(z^2)/z^2$  is nonzero and has a removable singularity at  $z = 0$ .

$$\lim_{z \rightarrow 0} \frac{\sin z^2}{z^2} = \lim_{z \rightarrow 0} \frac{2z \cos z^2}{2z} = 1.$$

Since  $(z^2)^{1/2}$  does not have a branch point at  $z = 0$ ,  $(\sin z^2)^{1/2}$  does not have a branch point there either.

Now consider the point  $z = \sqrt{n\pi}$ .

$$\sin z^2 = (z - \sqrt{n\pi}) \frac{\sin z^2}{z - \sqrt{n\pi}}$$

$\sin(z^2)/(z - \sqrt{n\pi})$  is nonzero and has a removable singularity at  $z = \sqrt{n\pi}$ .

$$\lim_{z \rightarrow \sqrt{n\pi}} \frac{\sin z^2}{z - \sqrt{n\pi}} = \lim_{z \rightarrow \sqrt{n\pi}} \frac{2z \cos z^2}{1} = 2\sqrt{n\pi}(-1)^n$$

Since  $(z - \sqrt{n\pi})^{1/2}$  has a branch point at  $z = \sqrt{n\pi}$ ,  $(\sin z^2)^{1/2}$  also has a branch point there.

Thus we see that  $(\sin z^2)^{1/2}$  has branch points at  $z = (n\pi)^{1/2}$  for  $n \in \mathbb{Z} \setminus \{0\}$ . This is the set of numbers:  $\{\pm\sqrt{\pi}, \pm\sqrt{2\pi}, \dots, \pm i\sqrt{\pi}, \pm i\sqrt{2\pi}, \dots\}$ . The point at infinity is a non-isolated singularity.

**Example 7.9.11** Find the branch points of

$$f(z) = (z^3 - z)^{1/3}.$$

Introduce branch cuts. If  $f(2) = \sqrt[3]{6}$  then what is  $f(-2)$ ?

We expand  $f(z)$ .

$$f(z) = z^{1/3}(z-1)^{1/3}(z+1)^{1/3}.$$

There are branch points at  $z = -1, 0, 1$ . We consider the point at infinity.

$$\begin{aligned} f\left(\frac{1}{\zeta}\right) &= \left(\frac{1}{\zeta}\right)^{1/3} \left(\frac{1}{\zeta} - 1\right)^{1/3} \left(\frac{1}{\zeta} + 1\right)^{1/3} \\ &= \frac{1}{\zeta} (1 - \zeta)^{1/3} (1 + \zeta)^{1/3} \end{aligned}$$

Since  $f(1/\zeta)$  does not have a branch point at  $\zeta = 0$ ,  $f(z)$  does not have a branch point at infinity. Consider the three possible branch cuts in Figure 7.29.

The first and the third branch cuts will make the function single valued, the second will not. It is clear that the first set makes the function single valued since it is not possible to walk around any of the branch points.

The second set of branch cuts would allow you to walk around the branch points at  $z = \pm 1$ . If you walked around these two once in the positive direction, the value of the function would change by the factor  $e^{i4\pi/3}$ .

The third set of branch cuts would allow you to walk around all three branch points together. You can verify that if you walk around the three branch points, the value of the function will not change ( $e^{i6\pi/3} = e^{i2\pi} = 1$ ).

Suppose we introduce the third set of branch cuts and are on the branch with  $f(2) = \sqrt[3]{6}$ .

$$f(2) = (2e^{i0})^{1/3} (1e^{i0})^{1/3} (3e^{i0})^{1/3} = \sqrt[3]{6}$$

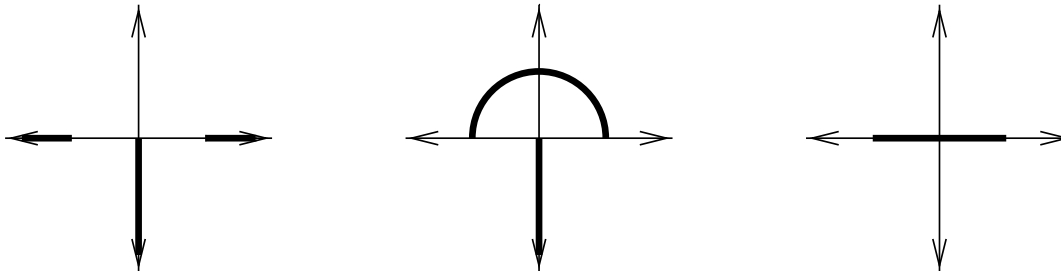

Figure 7.29: Three Possible Branch Cuts for  $f(z) = (z^3 - z)^{1/3}$ .

The value of  $f(-2)$  is

$$\begin{aligned}
 f(-2) &= (2 e^{i\pi})^{1/3} (3 e^{i\pi})^{1/3} (1 e^{i\pi})^{1/3} \\
 &= \sqrt[3]{2} e^{i\pi/3} \sqrt[3]{3} e^{i\pi/3} \sqrt[3]{1} e^{i\pi/3} \\
 &= \sqrt[3]{6} e^{i\pi} \\
 &= -\sqrt[3]{6}.
 \end{aligned}$$

**Example 7.9.12** Find the branch points and number of branches for

$$f(z) = z^{z^2}.$$

$$z^{z^2} = \exp(z^2 \log z)$$

There may be branch points at the origin and infinity due to the logarithm. Consider walking around a circle of radius  $r$  centered at the origin in the positive direction. Since the logarithm changes by  $i2\pi$ , the value of  $f(z)$  changes by the factor  $e^{i2\pi r^2}$ . There are branch points at the origin and infinity. The function has an infinite number of branches.

**Example 7.9.13** Construct a branch of

$$f(z) = (z^2 + 1)^{1/3}$$

such that

$$f(0) = \frac{1}{2} \left( -1 + i\sqrt{3} \right).$$

First we factor  $f(z)$ .

$$f(z) = (z - i)^{1/3} (z + i)^{1/3}$$

There are branch points at  $z = \pm i$ . Figure 7.30 shows one way to introduce branch cuts.

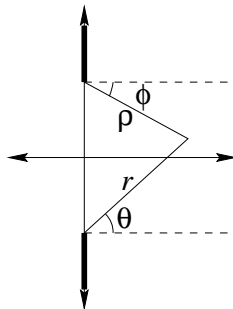

Figure 7.30: Branch Cuts for  $f(z) = (z^2 + 1)^{1/3}$ .

Since it is not possible to walk around any branch point, these cuts make the function single valued. We introduce the coordinates:

$$z - i = \rho e^{i\phi}, \quad z + i = r e^{i\theta}.$$

$$\begin{aligned} f(z) &= (\rho e^{i\phi})^{1/3} (r e^{i\theta})^{1/3} \\ &= \sqrt[3]{\rho r} e^{i(\phi+\theta)/3} \end{aligned}$$

The condition

$$f(0) = \frac{1}{2} \left( -1 + i\sqrt{3} \right) = e^{i(2\pi/3+2\pi n)}$$

can be stated

$$\sqrt[3]{1} e^{i(\phi+\theta)/3} = e^{i(2\pi/3+2\pi n)}$$

$$\phi + \theta = 2\pi + 6\pi n$$

The angles must be defined to satisfy this relation. One choice is

$$\boxed{\frac{\pi}{2} < \phi < \frac{5\pi}{2}, \quad -\frac{\pi}{2} < \theta < \frac{3\pi}{2}.}$$

**Principal branches.** We construct the principal branch of the logarithm by putting a branch cut on the negative real axis choose  $z = r e^{i\theta}$ ,  $\theta \in (-\pi, \pi)$ . Thus the principal branch of the logarithm is

$$\text{Log } z = \ln r + i\theta, \quad -\pi < \theta < \pi.$$

Note that the if  $x$  is a negative real number, (and thus lies on the branch cut), then  $\text{Log } x$  is undefined.

The principal branch of  $z^\alpha$  is

$$z^\alpha = e^{\alpha \text{Log } z}.$$

Note that there is a branch cut on the negative real axis.

$$-\alpha\pi < \arg(e^{\alpha \text{Log } z}) < \alpha\pi$$

The principal branch of the  $z^{1/2}$  is denoted  $\sqrt{z}$ . The principal branch of  $z^{1/n}$  is denoted  $\sqrt[n]{z}$ .

**Example 7.9.14** Construct  $\sqrt{1-z^2}$ , the principal branch of  $(1-z^2)^{1/2}$ .

First note that since  $(1-z^2)^{1/2} = (1-z)^{1/2}(1+z)^{1/2}$  there are branch points at  $z = 1$  and  $z = -1$ . The principal branch of the square root has a branch cut on the negative real axis.  $1-z^2$  is a negative real number for  $z \in (-\infty \dots -1) \cup (1 \dots \infty)$ . Thus we put branch cuts on  $(-\infty \dots -1]$  and  $[1 \dots \infty)$ .

## 7.10 Exercises

### Cartesian and Modulus-Argument Form

#### Exercise 7.1

Find the image of the strip  $2 < x < 3$  under the mapping  $w = f(z) = z^2$ . Does the image constitute a domain?

[Hint](#), [Solution](#)

#### Exercise 7.2

For a given real number  $\phi$ ,  $0 \leq \phi < 2\pi$ , find the image of the sector  $0 \leq \arg(z) < \phi$  under the transformation  $w = z^4$ . How large should  $\phi$  be so that the  $w$  plane is covered exactly once?

[Hint](#), [Solution](#)

### Trigonometric Functions

#### Exercise 7.3

In Cartesian coordinates,  $z = x + iy$ , write  $\sin(z)$  in Cartesian and modulus-argument form.

[Hint](#), [Solution](#)

#### Exercise 7.4

Show that  $e^z$  is nonzero for all finite  $z$ .

[Hint](#), [Solution](#)

#### Exercise 7.5

Show that

$$\left| e^{z^2} \right| \leq e^{|z|^2}.$$

When does equality hold?

[Hint](#), [Solution](#)

#### Exercise 7.6

Solve  $\coth(z) = 1$ .

[Hint](#), [Solution](#)

### Exercise 7.7

Solve  $2 \in 2^z$ . That is, for what values of  $z$  is 2 one of the values of  $2^z$ ? Derive this result then verify your answer by evaluating  $2^z$  for the solutions that you find.

[Hint](#), [Solution](#)

### Exercise 7.8

Solve  $1 \in 1^z$ . That is, for what values of  $z$  is 1 one of the values of  $1^z$ ? Derive this result then verify your answer by evaluating  $1^z$  for the solutions that you find.

[Hint](#), [Solution](#)

## Logarithmic Identities

### Exercise 7.9

Show that if  $\Re(z_1) > 0$  and  $\Re(z_2) > 0$  then

$$\text{Log}(z_1 z_2) = \text{Log}(z_1) + \text{Log}(z_2)$$

and illustrate that this relationship does not hold in general.

[Hint](#), [Solution](#)

### Exercise 7.10

Find the fallacy in the following arguments:

1.  $\log(-1) = \log\left(\frac{1}{-1}\right) = \log(1) - \log(-1) = -\log(-1)$ , therefore,  $\log(-1) = 0$ .
2.  $1 = 1^{1/2} = ((-1)(-1))^{1/2} = (-1)^{1/2}(-1)^{1/2} = u = -1$ , therefore,  $1 = -1$ .

[Hint](#), [Solution](#)

### Exercise 7.11

Write the following expressions in modulus-argument or Cartesian form. Denote any multi-valuedness explicitly.

$$2^{2/5}, \quad 3^{1+i}, \quad \left(\sqrt{3} - i\right)^{1/4}, \quad 1^{i/4}.$$

[Hint](#), [Solution](#)

**Exercise 7.12**

Solve  $\cos z = 69$ .

[Hint](#), [Solution](#)

**Exercise 7.13**

Solve  $\cot z = i47$ .

[Hint](#), [Solution](#)

**Exercise 7.14**

Determine all values of

1.  $\log(-i)$
2.  $(-i)^{-i}$
3.  $3^\pi$
4.  $\log(\log(i))$

and plot them in the complex plane.

[Hint](#), [Solution](#)

**Exercise 7.15**

Evaluate and plot the following in the complex plane:

1.  $(\cosh(i\pi))^{i2}$
2.  $\log\left(\frac{1}{1+i}\right)$
3.  $\arctan(i3)$

[Hint](#), [Solution](#)



### Exercise 7.16

Determine all values of  $i^i$  and  $\log((1+i)^{i\pi})$  and plot them in the complex plane.

Hint, Solution

### Exercise 7.17

Find all  $z$  for which

1.  $e^z = i$
2.  $\cos z = \sin z$
3.  $\tan^2 z = -1$

Hint, Solution

### Exercise 7.18

Prove the following identities and identify the branch points of the functions in the extended complex plane.

1.  $\arctan(z) = \frac{i}{2} \log\left(\frac{i+z}{i-z}\right)$
2.  $\operatorname{arctanh}(z) = \frac{1}{2} \log\left(\frac{1+z}{1-z}\right)$
3.  $\operatorname{arccosh}(z) = \log\left(z + (z^2 - 1)^{1/2}\right)$

Hint, Solution

## Branch Points and Branch Cuts

### Exercise 7.19

Identify the branch points of the function

$$f(z) = \log\left(\frac{z(z+1)}{z-1}\right)$$

and introduce appropriate branch cuts to ensure that the function is single-valued.

**Hint, Solution**

### Exercise 7.20

Identify all the branch points of the function

$$w = f(z) = (z^3 + z^2 - 6z)^{1/2}$$

in the extended complex plane. Give a polar description of  $f(z)$  and specify branch cuts so that your choice of angles gives a single-valued function that is continuous at  $z = -1$  with  $f(-1) = -\sqrt{6}$ . Sketch the branch cuts in the stereographic projection.

**Hint, Solution**

### Exercise 7.21

Consider the mapping  $w = f(z) = z^{1/3}$  and the inverse mapping  $z = g(w) = w^3$ .

1. Describe the multiple-valuedness of  $f(z)$ .
2. Describe a region of the  $w$ -plane that  $g(w)$  maps one-to-one to the whole  $z$ -plane.
3. Describe and attempt to draw a Riemann surface on which  $f(z)$  is single-valued and to which  $g(w)$  maps one-to-one. Comment on the misleading nature of your picture.
4. Identify the branch points of  $f(z)$  and introduce a branch cut to make  $f(z)$  single-valued.

**Hint, Solution**

### Exercise 7.22

Determine the branch points of the function

$$f(z) = (z^3 - 1)^{1/2}.$$

Construct cuts and define a branch so that  $z = 0$  and  $z = -1$  do not lie on a cut, and such that  $f(0) = -i$ . What is  $f(-1)$  for this branch?

**Hint, Solution**

**Exercise 7.23**

Determine the branch points of the function

$$w(z) = ((z - 1)(z - 6)(z + 2))^{1/2}$$

Construct cuts and define a branch so that  $z = 4$  does not lie on a cut, and such that  $w = i6$  when  $z = 4$ .

**Hint, Solution**

**Exercise 7.24**

Give the number of branches and locations of the branch points for the functions

1.  $\cos(z^{1/2})$
2.  $(z + i)^{-z}$

**Hint, Solution**

**Exercise 7.25**

Find the branch points of the following functions in the extended complex plane, (the complex plane including the point at infinity).

1.  $(z^2 + 1)^{1/2}$
2.  $(z^3 - z)^{1/2}$
3.  $\log(z^2 - 1)$
4.  $\log\left(\frac{z + 1}{z - 1}\right)$

Introduce branch cuts to make the functions single valued.

**Hint, Solution**

### Exercise 7.26

Find all branch points and introduce cuts to make the following functions single-valued: For the first function, choose cuts so that there is no cut within the disk  $|z| < 2$ .

1.  $f(z) = (z^3 + 8)^{1/2}$

2.  $f(z) = \log \left( 5 + \left( \frac{z+1}{z-1} \right)^{1/2} \right)$

3.  $f(z) = (z + i3)^{1/2}$

Hint, Solution

### Exercise 7.27

Let  $f(z)$  have branch points at  $z = 0$  and  $z = \pm i$ , but nowhere else in the extended complex plane. How does the value and argument of  $f(z)$  change while traversing the contour in Figure 7.31? Does the branch cut in Figure 7.31 make the function single-valued?

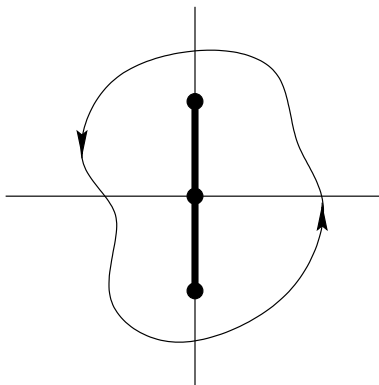

Figure 7.31: Contour around the branch points and the branch cut.

Hint, Solution

### Exercise 7.28

Let  $f(z)$  be analytic except for no more than a countably infinite number of singularities. Suppose that  $f(z)$  has only one branch point in the finite complex plane. Does  $f(z)$  have a branch point at infinity? Now suppose that  $f(z)$  has two or more branch points in the finite complex plane. Does  $f(z)$  have a branch point at infinity?

Hint, Solution

### Exercise 7.29

Find all branch points of  $(z^4 + 1)^{1/4}$  in the extended complex plane. Which of the branch cuts in Figure 7.32 make the function single-valued.

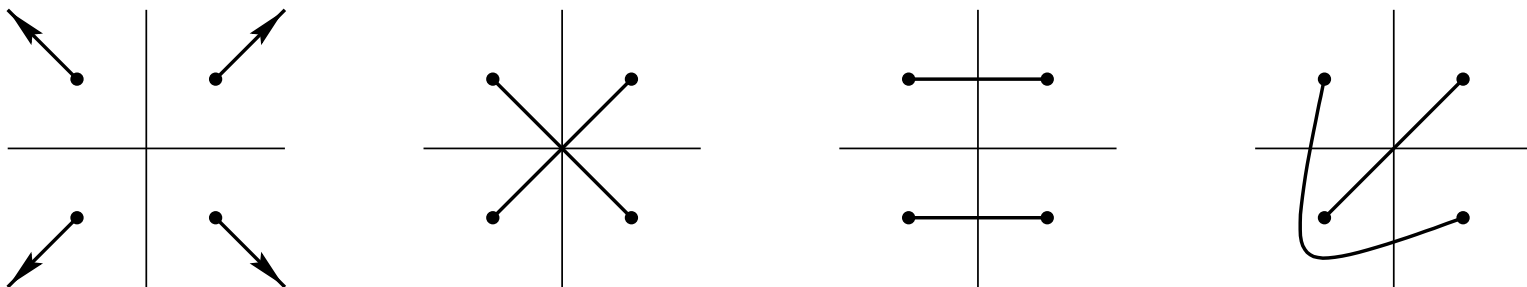

Figure 7.32: Four candidate sets of branch cuts for  $(z^4 + 1)^{1/4}$ .

Hint, Solution

### Exercise 7.30

Find the branch points of

$$f(z) = \left( \frac{z}{z^2 + 1} \right)^{1/3}$$

in the extended complex plane. Introduce branch cuts that make the function single-valued and such that the function

is defined on the positive real axis. Define a branch such that  $f(1) = 1/\sqrt[3]{2}$ . Write down an explicit formula for the value of the branch. What is  $f(1+i)$ ? What is the value of  $f(z)$  on either side of the branch cuts?

Hint, Solution

### Exercise 7.31

Find all branch points of

$$f(z) = ((z-1)(z-2)(z-3))^{1/2}$$

in the extended complex plane. Which of the branch cuts in Figure 7.33 will make the function single-valued. Using the first set of branch cuts in this figure define a branch on which  $f(0) = i\sqrt{6}$ . Write out an explicit formula for the value of the function on this branch.

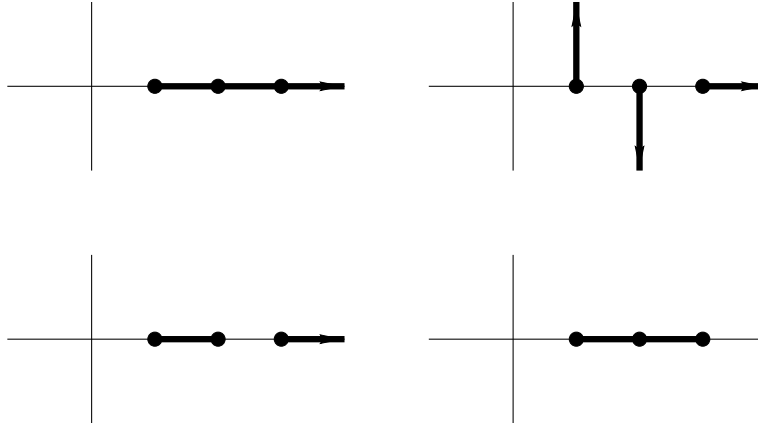

Figure 7.33: Four candidate sets of branch cuts for  $((z-1)(z-2)(z-3))^{1/2}$ .

Hint, Solution

### Exercise 7.32

Determine the branch points of the function

$$w = ((z^2 - 2)(z + 2))^{1/3}.$$

Construct and define a branch so that the resulting cut is one line of finite extent and  $w(2) = 2$ . What is  $w(-3)$  for this branch? What are the limiting values of  $w$  on either side of the branch cut?

[Hint](#), [Solution](#)

### Exercise 7.33

Construct the principal branch of  $\arccos(z)$ . ( $\text{Arccos}(z)$  has the property that if  $x \in [-1, 1]$  then  $\text{Arccos}(x) \in [0, \pi]$ . In particular,  $\text{Arccos}(0) = \frac{\pi}{2}$ ).

[Hint](#), [Solution](#)

### Exercise 7.34

Find the branch points of  $(z^{1/2} - 1)^{1/2}$  in the finite complex plane. Introduce branch cuts to make the function single-valued.

[Hint](#), [Solution](#)

### Exercise 7.35

For the linkage illustrated in Figure 7.34, use complex variables to outline a scheme for expressing the angular position, velocity and acceleration of arm  $c$  in terms of those of arm  $a$ . (You needn't work out the equations.)

[Hint](#), [Solution](#)

### Exercise 7.36

Find the image of the strip  $|\Re(z)| < 1$  and of the strip  $1 < \Im(z) < 2$  under the transformations:

1.  $w = 2z^2$
2.  $w = \frac{z+1}{z-1}$

[Hint](#), [Solution](#)

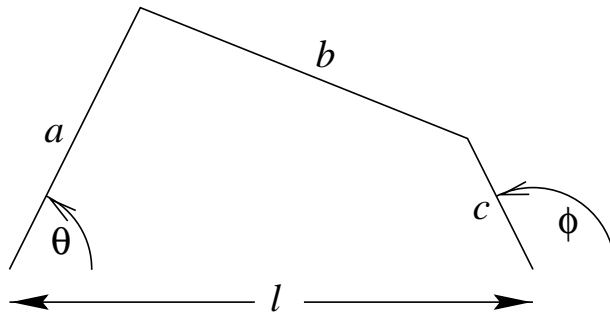

Figure 7.34: A linkage.

### Exercise 7.37

Locate and classify all the singularities of the following functions:

1.  $\frac{(z+1)^{1/2}}{z+2}$

2.  $\cos\left(\frac{1}{1+z}\right)$

3.  $\frac{1}{(1-e^z)^2}$

In each case discuss the possibility of a singularity at the point  $\infty$ .

**Hint, Solution**

### Exercise 7.38

Describe how the mapping  $w = \sinh(z)$  transforms the infinite strip  $-\infty < x < \infty$ ,  $0 < y < \pi$  into the  $w$ -plane. Find cuts in the  $w$ -plane which make the mapping continuous both ways. What are the images of the lines (a)  $y = \pi/4$ ; (b)  $x = 1$ ?

**Hint, Solution**



## 7.11 Hints

### Cartesian and Modulus-Argument Form

**Hint 7.1**

**Hint 7.2**

### Trigonometric Functions

**Hint 7.3**

Recall that  $\sin(z) = \frac{1}{i2} (e^{iz} - e^{-iz})$ . Use Result 6.3.1 to convert between Cartesian and modulus-argument form.

**Hint 7.4**

Write  $e^z$  in polar form.

**Hint 7.5**

The exponential is an increasing function for real variables.

**Hint 7.6**

Write the hyperbolic cotangent in terms of exponentials.

**Hint 7.7**

Write out the multi-valuedness of  $2^z$ . There is a doubly-infinite set of solutions to this problem.

**Hint 7.8**

Write out the multi-valuedness of  $1^z$ .

### Logarithmic Identities

**Hint 7.9****Hint 7.10**

Write out the multi-valuedness of the expressions.

**Hint 7.11**

Do the exponentiations in polar form.

**Hint 7.12**

Write the cosine in terms of exponentials. Multiply by  $e^{iz}$  to get a quadratic equation for  $e^{iz}$ .

**Hint 7.13**

Write the cotangent in terms of exponentials. Get a quadratic equation for  $e^{iz}$ .

**Hint 7.14****Hint 7.15****Hint 7.16**

$i^i$  has an infinite number of real, positive values.  $i^i = e^{i \log i}$ .  $\log((1+i)^{i\pi})$  has a doubly infinite set of values.  
 $\log((1+i)^{i\pi}) = \log(\exp(i\pi \log(1+i)))$ .

**Hint 7.17****Hint 7.18****Branch Points and Branch Cuts**

**Hint 7.19**

**Hint 7.20**

**Hint 7.21**

**Hint 7.22**

**Hint 7.23**

**Hint 7.24**

**Hint 7.25**

1.  $(z^2 + 1)^{1/2} = (z - i)^{1/2}(z + i)^{1/2}$

2.  $(z^3 - z)^{1/2} = z^{1/2}(z - 1)^{1/2}(z + 1)^{1/2}$

3.  $\log(z^2 - 1) = \log(z - 1) + \log(z + 1)$

4.  $\log\left(\frac{z+1}{z-1}\right) = \log(z + 1) - \log(z - 1)$

**Hint 7.26**

**Hint 7.27**

Reverse the orientation of the contour so that it encircles infinity and does not contain any branch points.

**Hint 7.28**

Consider a contour that encircles all the branch points in the finite complex plane. Reverse the orientation of the contour so that it contains the point at infinity and does not contain any branch points in the finite complex plane.

**Hint 7.29**

Factor the polynomial. The argument of  $z^{1/4}$  changes by  $\pi/2$  on a contour that goes around the origin once in the positive direction.

**Hint 7.30****Hint 7.31**

To define the branch, define angles from each of the branch points in the finite complex plane.

**Hint 7.32****Hint 7.33****Hint 7.34****Hint 7.35****Hint 7.36****Hint 7.37**

**Hint 7.38**

## 7.12 Solutions

### Cartesian and Modulus-Argument Form

#### Solution 7.1

Let  $w = u + iv$ . We consider the strip  $2 < x < 3$  as composed of vertical lines. Consider the vertical line:  $z = c + iy$ ,  $y \in \mathbb{R}$  for constant  $c$ . We find the image of this line under the mapping.

$$\begin{aligned}w &= (c + iy)^2 \\w &= c^2 - y^2 + i2cy \\u &= c^2 - y^2, \quad v = 2cy\end{aligned}$$

This is a parabola that opens to the left. We can parameterize the curve in terms of  $v$ .

$$u = c^2 - \frac{1}{4c^2}v^2, \quad v \in \mathbb{R}$$

The boundaries of the region,  $x = 2$  and  $x = 3$ , are respectively mapped to the parabolas:

$$u = 4 - \frac{1}{16}v^2, \quad v \in \mathbb{R} \quad \text{and} \quad u = 9 - \frac{1}{36}v^2, \quad v \in \mathbb{R}$$

We write the image of the mapping in set notation.

$$\left\{ w = u + iv : v \in \mathbb{R} \text{ and } 4 - \frac{1}{16}v^2 < u < 9 - \frac{1}{36}v^2 \right\}.$$

See Figure 7.35 for depictions of the strip and its image under the mapping. The mapping is one-to-one. Since the image of the strip is open and connected, it is a domain.

#### Solution 7.2

We write the mapping  $w = z^4$  in polar coordinates.

$$w = z^4 = (r e^{i\theta})^4 = r^4 e^{i4\theta}$$

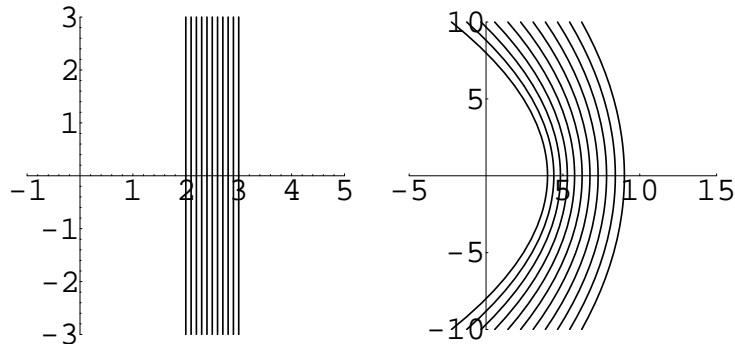

Figure 7.35: The domain  $2 < x < 3$  and its image under the mapping  $w = z^2$ .

Thus we see that

$$w : \{r e^{i\theta} \mid r \geq 0, 0 \leq \theta < \phi\} \rightarrow \{r^4 e^{i4\theta} \mid r \geq 0, 0 \leq \theta < \phi\} = \{r e^{i\theta} \mid r \geq 0, 0 \leq \theta < 4\phi\}.$$

We can state this in terms of the argument.

$$w : \{z \mid 0 \leq \arg(z) < \phi\} \rightarrow \{z \mid 0 \leq \arg(z) < 4\phi\}$$

If  $\phi = \pi/2$ , the sector will be mapped exactly to the whole complex plane.

## Trigonometric Functions

### Solution 7.3

$$\begin{aligned}\sin z &= \frac{1}{i2} (e^{iz} - e^{-iz}) \\ &= \frac{1}{i2} (e^{-y+ix} - e^{y-ix}) \\ &= \frac{1}{i2} (e^{-y}(\cos x + i \sin x) - e^y(\cos x - i \sin x)) \\ &= \frac{1}{2} (e^{-y}(\sin x - i \cos x) + e^y(\sin x + i \cos x)) \\ &= \sin x \cosh y + i \cos x \sinh y\end{aligned}$$

$$\begin{aligned}\sin z &= \sqrt{\sin^2 x \cosh^2 y + \cos^2 x \sinh^2 y} \exp(i \arctan(\sin x \cosh y, \cos x \sinh y)) \\ &= \sqrt{\cosh^2 y - \cos^2 x} \exp(i \arctan(\sin x \cosh y, \cos x \sinh y)) \\ &= \sqrt{\frac{1}{2} (\cosh(2y) - \cos(2x))} \exp(i \arctan(\sin x \cosh y, \cos x \sinh y))\end{aligned}$$

### Solution 7.4

In order that  $e^z$  be zero, the modulus,  $e^x$  must be zero. Since  $e^x$  has no finite solutions,  $e^z = 0$  has no finite solutions.

### Solution 7.5

We write the expressions in terms of Cartesian coordinates.

$$\begin{aligned}|e^{z^2}| &= |e^{(x+iy)^2}| \\ &= |e^{x^2-y^2+i2xy}| \\ &= e^{x^2-y^2}\end{aligned}$$



$$e^{|z|^2} = e^{|x+iy|^2} = e^{x^2+y^2}$$

The exponential function is an increasing function for real variables. Since  $x^2 - y^2 \leq x^2 + y^2$ ,  $e^{x^2-y^2} \leq e^{x^2+y^2}$ .

$$\left| e^{z^2} \right| \leq e^{|z|^2}$$

Equality holds only when  $y = 0$ .

### Solution 7.6

$$\begin{aligned} \coth(z) &= 1 \\ \frac{(e^z + e^{-z})/2}{(e^z - e^{-z})/2} &= 1 \\ e^z + e^{-z} &= e^z - e^{-z} \\ e^{-z} &= 0 \end{aligned}$$

There are no solutions.

### Solution 7.7

We write out the multi-valuedness of  $2^z$ .

$$\begin{aligned} 2 &\in 2^z \\ e^{\ln 2} &\in e^{z \log(2)} \\ e^{\ln 2} &\in \{e^{z(\ln(2)+i2\pi n)} \mid n \in \mathbb{Z}\} \\ \ln 2 &\in z\{\ln 2 + i2\pi n + i2\pi m \mid m, n \in \mathbb{Z}\} \\ z &= \left\{ \frac{\ln(2) + i2\pi m}{\ln(2) + i2\pi n} \mid m, n \in \mathbb{Z} \right\} \end{aligned}$$

We verify this solution. Consider  $m$  and  $n$  to be fixed integers. We express the multi-valuedness in terms of  $k$ .

$$\begin{aligned} 2^{(\ln(2)+i2\pi m)/(\ln(2)+i2\pi n)} &= e^{(\ln(2)+i2\pi m)/(\ln(2)+i2\pi n) \log(2)} \\ &= e^{(\ln(2)+i2\pi m)/(\ln(2)+i2\pi n)(\ln(2)+i2\pi k)} \end{aligned}$$

For  $k = n$ , this has the value,  $e^{\ln(2)+i2\pi n} = e^{\ln(2)} = 2$ .

### Solution 7.8

We write out the multi-valuedness of  $1^z$ .

$$\begin{aligned} 1 &\in 1^z \\ 1 &\in e^{z \log(1)} \\ 1 &\in \{e^{iz2\pi n} \mid n \in \mathbb{Z}\} \end{aligned}$$

The element corresponding to  $n = 0$  is  $e^0 = 1$ . Thus  $1 \in 1^z$  has the solutions,

$$\boxed{z \in \mathbb{C}.}$$

That is,  $z$  may be any complex number. We verify this solution.

$$1^z = e^{z \log(1)} = e^{iz2\pi n}$$

For  $n = 0$ , this has the value 1.

## Logarithmic Identities

### Solution 7.9

We write the relationship in terms of the natural logarithm and the principal argument.

$$\begin{aligned} \text{Log}(z_1 z_2) &= \text{Log}(z_1) + \text{Log}(z_2) \\ \ln |z_1 z_2| + i \text{Arg}(z_1 z_2) &= \ln |z_1| + i \text{Arg}(z_1) + \ln |z_2| + i \text{Arg}(z_2) \\ \text{Arg}(z_1 z_2) &= \text{Arg}(z_1) + \text{Arg}(z_2) \end{aligned}$$

$\Re(z_k) > 0$  implies that  $\text{Arg}(z_k) \in (-\pi/2 \dots \pi/2)$ . Thus  $\text{Arg}(z_1) + \text{Arg}(z_2) \in (-\pi \dots \pi)$ . In this case the relationship holds.

The relationship does not hold in general because  $\text{Arg}(z_1) + \text{Arg}(z_2)$  is not necessarily in the interval  $(-\pi \dots \pi]$ . Consider  $z_1 = z_2 = -1$ .

$$\begin{aligned} \text{Arg}((-1)(-1)) &= \text{Arg}(1) = 0, & \text{Arg}(-1) + \text{Arg}(-1) &= 2\pi \\ \text{Log}((-1)(-1)) &= \text{Log}(1) = 0, & \text{Log}(-1) + \text{Log}(-1) &= i2\pi \end{aligned}$$

### Solution 7.10

1. The algebraic manipulations are fine. We write out the multi-valuedness of the logarithms.

$$\log(-1) = \log\left(\frac{1}{-1}\right) = \log(1) - \log(-1) = -\log(-1)$$

$$\begin{aligned}\{i\pi + i2\pi n : n \in \mathbb{Z}\} &= \{i\pi + i2\pi n : n \in \mathbb{Z}\} \\ &= \{i2\pi n : n \in \mathbb{Z}\} - \{i\pi + i2\pi n : n \in \mathbb{Z}\} = \{-i\pi - i2\pi n : n \in \mathbb{Z}\}\end{aligned}$$

Thus  $\log(-1) = -\log(-1)$ . However this does not imply that  $\log(-1) = 0$ . This is because the logarithm is a set-valued function  $\log(-1) = -\log(-1)$  is really saying:

$$\{i\pi + i2\pi n : n \in \mathbb{Z}\} = \{-i\pi - i2\pi n : n \in \mathbb{Z}\}$$

2. We consider

$$1 = 1^{1/2} = ((-1)(-1))^{1/2} = (-1)^{1/2}(-1)^{1/2} = i = -1.$$

There are three multi-valued expressions above.

$$\begin{aligned}1^{1/2} &= \pm 1 \\ ((-1)(-1))^{1/2} &= \pm 1 \\ (-1)^{1/2}(-1)^{1/2} &= (\pm i)(\pm i) = \pm 1\end{aligned}$$

Thus we see that the first and fourth equalities are incorrect.

$$1 \neq 1^{1/2}, \quad (-1)^{1/2}(-1)^{1/2} \neq i$$

### Solution 7.11

$$\begin{aligned}2^{2/5} &= 4^{1/5} \\ &= \sqrt[5]{4} 1^{1/5} \\ &= \sqrt[5]{4} e^{i2n\pi/5}, \quad n = 0, 1, 2, 3, 4\end{aligned}$$

$$\begin{aligned}
3^{1+i} &= e^{(1+i)\log 3} \\
&= e^{(1+i)(\ln 3+i2\pi n)} \\
&= e^{\ln 3-2\pi n} e^{i(\ln 3+2\pi n)}, \quad n \in \mathbb{Z}
\end{aligned}$$

$$\begin{aligned}
(\sqrt{3}-i)^{1/4} &= (2e^{-i\pi/6})^{1/4} \\
&= \sqrt[4]{2} e^{-i\pi/24} 1^{1/4} \\
&= \sqrt[4]{2} e^{i(\pi n/2-\pi/24)}, \quad n = 0, 1, 2, 3
\end{aligned}$$

$$\begin{aligned}
1^{i/4} &= e^{(i/4)\log 1} \\
&= e^{(i/4)(i2\pi n)} \\
&= e^{-\pi n/2}, \quad n \in \mathbb{Z}
\end{aligned}$$

## Solution 7.12

$$\cos z = 69$$

$$\frac{e^{iz} + e^{-iz}}{2} = 69$$

$$e^{i2z} - 138 e^{iz} + 1 = 0$$

$$e^{iz} = \frac{1}{2} \left( 138 \pm \sqrt{138^2 - 4} \right)$$

$$z = -i \log \left( 69 \pm 2\sqrt{1190} \right)$$

$$z = -i \left( \ln \left( 69 \pm 2\sqrt{1190} \right) + i2\pi n \right)$$

$$z = 2\pi n - i \ln \left( 69 \pm 2\sqrt{1190} \right), \quad n \in \mathbb{Z}$$

### Solution 7.13

$$\begin{aligned}\cot z &= i47 \\ \frac{(e^{iz} + e^{-iz})/2}{(e^{iz} - e^{-iz})/(i2)} &= i47 \\ e^{iz} + e^{-iz} &= 47(e^{iz} - e^{-iz}) \\ 46e^{i2z} - 48 &= 0 \\ i2z &= \log \frac{24}{23} \\ z &= -\frac{i}{2} \log \frac{24}{23} \\ z &= -\frac{i}{2} \left( \ln \frac{24}{23} + i2\pi n \right), \quad n \in \mathbb{Z} \\ z &= \pi n - \frac{i}{2} \ln \frac{24}{23}, \quad n \in \mathbb{Z}\end{aligned}$$

### Solution 7.14

1.

$$\begin{aligned}\log(-i) &= \ln |-i| + i \arg(-i) \\ &= \ln(1) + i \left( -\frac{\pi}{2} + 2\pi n \right), \quad n \in \mathbb{Z}\end{aligned}$$

$$\log(-i) = -i\frac{\pi}{2} + i2\pi n, \quad n \in \mathbb{Z}$$

These are equally spaced points in the imaginary axis. See Figure 7.36.

2.

$$\begin{aligned}(-i)^{-i} &= e^{-i \log(-i)} \\ &= e^{-i(-i\pi/2 + i2\pi n)}, \quad n \in \mathbb{Z}\end{aligned}$$

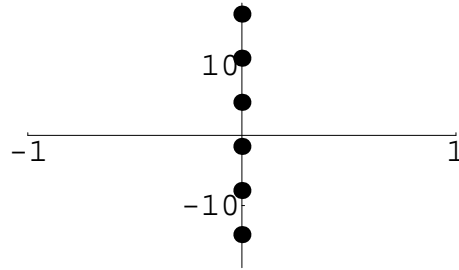

Figure 7.36: The values of  $\log(-i)$ .

$$\boxed{(-i)^{-i} = e^{-\pi/2+2\pi n}, \quad n \in \mathbb{Z}}$$

These are points on the positive real axis with an accumulation point at the origin. See Figure 7.37.

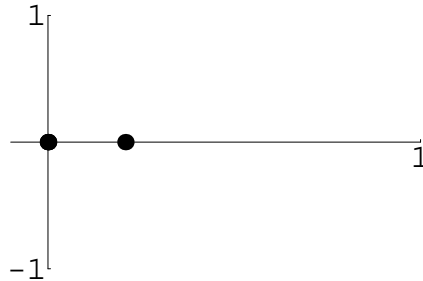

Figure 7.37: The values of  $(-i)^{-i}$ .

3.

$$\begin{aligned} 3^\pi &= e^{\pi \log(3)} \\ &= e^{\pi(\ln(3)+i \arg(3))} \end{aligned}$$

$$3^\pi = e^{\pi(\ln(3)+i2\pi n)}, \quad n \in \mathbb{Z}$$

These points all lie on the circle of radius  $|e^\pi|$  centered about the origin in the complex plane. See Figure 7.38.

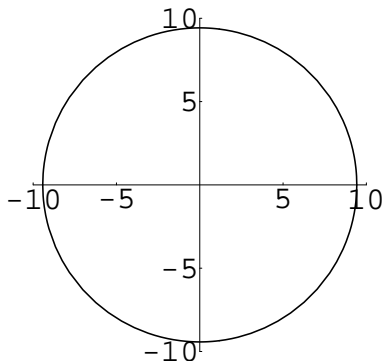

Figure 7.38: The values of  $3^\pi$ .

4.

$$\begin{aligned} \log(\log(i)) &= \log\left(i\left(\frac{\pi}{2} + 2\pi m\right)\right), \quad m \in \mathbb{Z} \\ &= \ln\left|\frac{\pi}{2} + 2\pi m\right| + i \operatorname{Arg}\left(i\left(\frac{\pi}{2} + 2\pi m\right)\right) + i2\pi n, \quad m, n \in \mathbb{Z} \\ &= \ln\left|\frac{\pi}{2} + 2\pi m\right| + i \operatorname{sign}(1 + 4m)\frac{\pi}{2} + i2\pi n, \quad m, n \in \mathbb{Z} \end{aligned}$$

These points all lie in the right half-plane. See Figure 7.39.



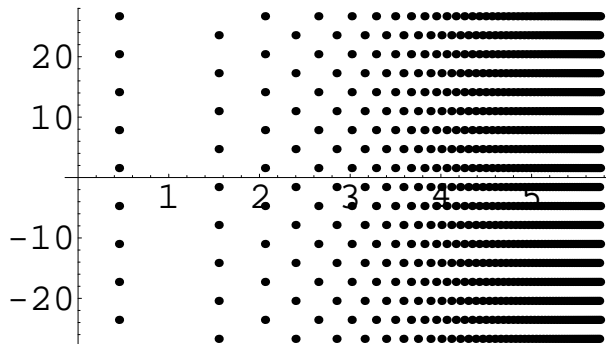

Figure 7.39: The values of  $\log(\log(i))$ .

### Solution 7.15

1.

$$\begin{aligned}
 (\cosh(i\pi))^{i2} &= \left( \frac{e^{i\pi} + e^{-i\pi}}{2} \right)^{i2} \\
 &= (-1)^{i2} \\
 &= e^{i2 \log(-1)} \\
 &= e^{i2(\ln(1) + i\pi + i2\pi n)}, \quad n \in \mathbb{Z} \\
 &= e^{-2\pi(1+2n)}, \quad n \in \mathbb{Z}
 \end{aligned}$$

These are points on the positive real axis with an accumulation point at the origin. See Figure 7.40.

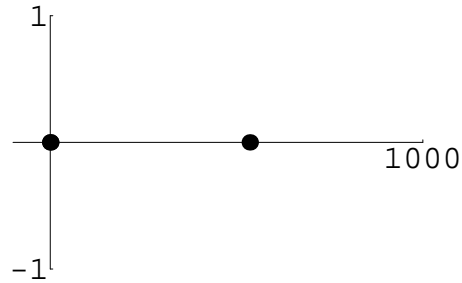

Figure 7.40: The values of  $(\cosh(i\pi))^{i^2}$ .

2.

$$\begin{aligned}
 \log\left(\frac{1}{1+i}\right) &= -\log(1+i) \\
 &= -\log\left(\sqrt{2}e^{i\pi/4}\right) \\
 &= -\frac{1}{2}\ln(2) - \log(e^{i\pi/4}) \\
 &= -\frac{1}{2}\ln(2) - i\pi/4 + i2\pi n, \quad n \in \mathbb{Z}
 \end{aligned}$$

These are points on a vertical line in the complex plane. See Figure 7.41.

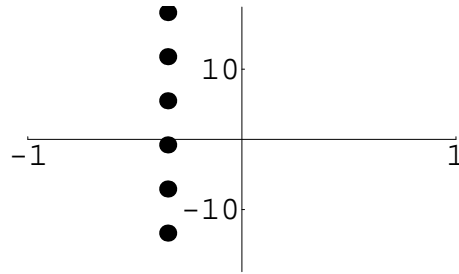

Figure 7.41: The values of  $\log\left(\frac{1}{1+i}\right)$ .

3.

$$\begin{aligned}
 \arctan(i3) &= \frac{1}{i2} \log\left(\frac{i - i3}{i + i3}\right) \\
 &= \frac{1}{i2} \log\left(-\frac{1}{2}\right) \\
 &= \frac{1}{i2} \left( \ln\left(\frac{1}{2}\right) + i\pi + i2\pi n \right), \quad n \in \mathbb{Z} \\
 &= \frac{\pi}{2} + \pi n + \frac{i}{2} \ln(2)
 \end{aligned}$$

These are points on a horizontal line in the complex plane. See Figure 7.42.

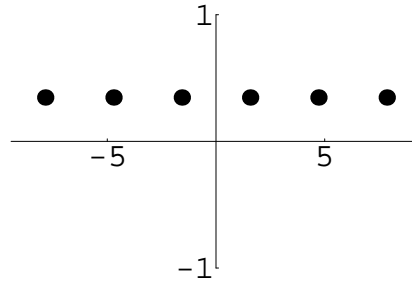

Figure 7.42: The values of  $\arctan(i3)$ .

### Solution 7.16

$$\begin{aligned}
 i^i &= e^{i \log(i)} \\
 &= e^{i(\ln|i| + i \operatorname{Arg}(i) + i2\pi n)}, \quad n \in \mathbb{Z} \\
 &= e^{i(\pi/2 + i2\pi n)}, \quad n \in \mathbb{Z} \\
 &= e^{-\pi(1/2 + 2n)}, \quad n \in \mathbb{Z}
 \end{aligned}$$

These are points on the positive real axis. There is an accumulation point at  $z = 0$ . See Figure 7.43.

$$\begin{aligned}
 \log((1+i)^{i\pi}) &= \log(e^{i\pi \log(1+i)}) \\
 &= i\pi \log(1+i) + i2\pi n, \quad n \in \mathbb{Z} \\
 &= i\pi (\ln|1+i| + i \operatorname{Arg}(1+i) + i2\pi m) + i2\pi n, \quad m, n \in \mathbb{Z} \\
 &= i\pi \left( \frac{1}{2} \ln 2 + i\frac{\pi}{4} + i2\pi m \right) + i2\pi n, \quad m, n \in \mathbb{Z} \\
 &= -\pi^2 \left( \frac{1}{4} + 2m \right) + i\pi \left( \frac{1}{2} \ln 2 + 2n \right), \quad m, n \in \mathbb{Z}
 \end{aligned}$$

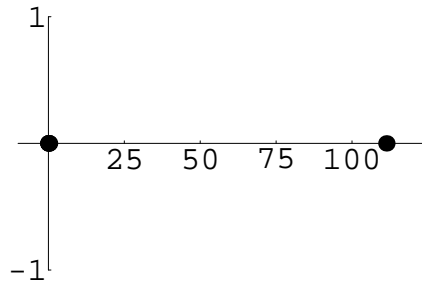

Figure 7.43: The values of  $i^2$ .

See Figure 7.44 for a plot.

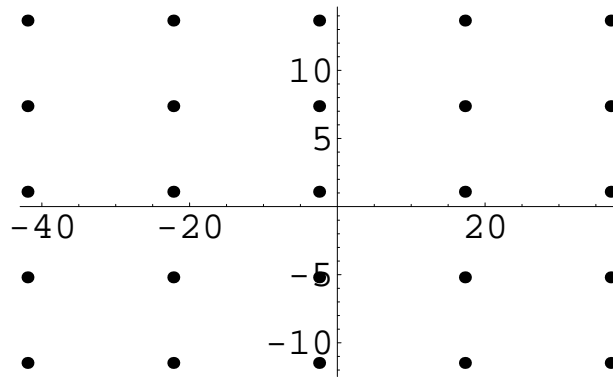

Figure 7.44: The values of  $\log((1+i)^{2\pi})$ .

**Solution 7.17**

1.

$$\begin{aligned}e^z &= i \\z &= \log i \\z &= \ln|i| + i \arg(i) \\z &= \ln(1) + i \left( \frac{\pi}{2} + 2\pi n \right), \quad n \in \mathbb{Z}\end{aligned}$$

$$z = i \frac{\pi}{2} + i2\pi n, \quad n \in \mathbb{Z}$$

2. We can solve the equation by writing the cosine and sine in terms of the exponential.

$$\begin{aligned}\cos z &= \sin z \\ \frac{e^{iz} + e^{-iz}}{2} &= \frac{e^{iz} - e^{-iz}}{i2} \\ (1+i)e^{iz} &= (-1+i)e^{-iz} \\ e^{i2z} &= \frac{-1+i}{1+i} \\ e^{i2z} &= i \\ i2z &= \log(i) \\ i2z &= i \frac{\pi}{2} + i2\pi n, \quad n \in \mathbb{Z}\end{aligned}$$

$$z = \frac{\pi}{4} + \pi n, \quad n \in \mathbb{Z}$$

3.

$$\tan^2 z = -1$$

$$\sin^2 z = -\cos^2 z$$

$$\cos z = \pm i \sin z$$

$$\frac{e^{iz} + e^{-iz}}{2} = \pm i \frac{e^{iz} - e^{-iz}}{i2}$$

$$e^{-iz} = -e^{-iz} \quad \text{or} \quad e^{iz} = -e^{iz}$$

$$e^{-iz} = 0 \quad \text{or} \quad e^{iz} = 0$$

$$e^{y-ix} = 0 \quad \text{or} \quad e^{-y+ix} = 0$$

$$e^y = 0 \quad \text{or} \quad e^{-y} = 0$$

$$z = \emptyset$$

There are no solutions for finite  $z$ .

**Solution 7.18**

1.

$$w = \arctan(z)$$

$$z = \tan(w)$$

$$z = \frac{\sin(w)}{\cos(w)}$$

$$z = \frac{(e^{iw} - e^{-iw}) / (i2)}{(e^{iw} + e^{-iw}) / 2}$$

$$z e^{iw} + z e^{-iw} = -i e^{iw} + i e^{-iw}$$

$$(i + z) e^{i2w} = (i - z)$$

$$e^{iw} = \left( \frac{i - z}{i + z} \right)^{1/2}$$

$$w = -i \log \left( \frac{i - z}{i + z} \right)^{1/2}$$

$$\boxed{\arctan(z) = \frac{i}{2} \log \left( \frac{i + z}{i - z} \right)}$$

We identify the branch points of the arctangent.

$$\arctan(z) = \frac{i}{2} (\log(i + z) - \log(i - z))$$

There are branch points at  $z = \pm i$  due to the logarithm terms. We examine the point at infinity with the change of variables  $\zeta = 1/z$ .

$$\arctan(1/\zeta) = \frac{i}{2} \log \left( \frac{i + 1/\zeta}{i - 1/\zeta} \right)$$

$$\arctan(1/\zeta) = \frac{i}{2} \log \left( \frac{i\zeta + 1}{i\zeta - 1} \right)$$



As  $\zeta \rightarrow 0$ , the argument of the logarithm term tends to  $-1$ . The logarithm does not have a branch point at that point. Since  $\arctan(1/\zeta)$  does not have a branch point at  $\zeta = 0$ ,  $\arctan(z)$  does not have a branch point at infinity.

2.

$$\begin{aligned}
 w &= \operatorname{arctanh}(z) \\
 z &= \tanh(w) \\
 z &= \frac{\sinh(w)}{\cosh(w)} \\
 z &= \frac{(e^w - e^{-w})/2}{(e^w + e^{-w})/2} \\
 z e^w + z e^{-w} &= e^w - e^{-w} \\
 (z - 1) e^{2w} &= -z - 1 \\
 e^w &= \left( \frac{-z - 1}{z - 1} \right)^{1/2} \\
 w &= \log \left( \frac{z + 1}{1 - z} \right)^{1/2}
 \end{aligned}$$

$$\boxed{\operatorname{arctanh}(z) = \frac{1}{2} \log \left( \frac{1 + z}{1 - z} \right)}$$

We identify the branch points of the hyperbolic arctangent.

$$\operatorname{arctanh}(z) = \frac{1}{2} (\log(1 + z) - \log(1 - z))$$

There are branch points at  $z = \pm 1$  due to the logarithm terms. We examine the point at infinity with the change

of variables  $\zeta = 1/z$ .

$$\operatorname{arctanh}(1/\zeta) = \frac{1}{2} \log \left( \frac{1 + 1/\zeta}{1 - 1/\zeta} \right)$$

$$\operatorname{arctanh}(1/\zeta) = \frac{1}{2} \log \left( \frac{\zeta + 1}{\zeta - 1} \right)$$

As  $\zeta \rightarrow 0$ , the argument of the logarithm term tends to  $-1$ . The logarithm does not have a branch point at that point. Since  $\operatorname{arctanh}(1/\zeta)$  does not have a branch point at  $\zeta = 0$ ,  $\operatorname{arctanh}(z)$  does not have a branch point at infinity.

3.

$$w = \operatorname{arccosh}(z)$$

$$z = \cosh(w)$$

$$z = \frac{e^w + e^{-w}}{2}$$

$$e^{2w} - 2ze^w + 1 = 0$$

$$e^w = z + (z^2 - 1)^{1/2}$$

$$w = \log \left( z + (z^2 - 1)^{1/2} \right)$$

$$\boxed{\operatorname{arccosh}(z) = \log \left( z + (z^2 - 1)^{1/2} \right)}$$

We identify the branch points of the hyperbolic arc-cosine.

$$\operatorname{arccosh}(z) = \log \left( z + (z - 1)^{1/2}(z + 1)^{1/2} \right)$$

First we consider branch points due to the square root. There are branch points at  $z = \pm 1$  due to the square root terms. If we walk around the singularity at  $z = 1$  and no other singularities, the  $(z^2 - 1)^{1/2}$  term changes

sign. This will change the value of  $\operatorname{arccosh}(z)$ . The same is true for the point  $z = -1$ . The point at infinity is not a branch point for  $(z^2 - 1)^{1/2}$ . We factor the expression to verify this.

$$(z^2 - 1)^{1/2} = (z^2)^{1/2} (1 - z^{-2})^{1/2}$$

$(z^2)^{1/2}$  does not have a branch point at infinity. It is multi-valued, but it has no branch points.  $(1 - z^{-2})^{1/2}$  does not have a branch point at infinity, The argument of the square root function tends to unity there. In summary, there are branch points at  $z = \pm 1$  due to the square root. If we walk around either one of these branch points. the square root term will change value. If we walk around both of these points, the square root term will not change value.

Now we consider branch points due to logarithm. There may be branch points where the argument of the logarithm vanishes or tends to infinity. We see if the argument of the logarithm vanishes.

$$\begin{aligned} z + (z^2 - 1)^{1/2} &= 0 \\ z^2 &= z^2 - 1 \end{aligned}$$

$z + (z^2 - 1)^{1/2}$  is non-zero and finite everywhere in the complex plane. The only possibility for a branch point in the logarithm term is the point at infinity. We see if the argument of  $z + (z^2 - 1)^{1/2}$  changes when we walk around infinity but no other singularity. We consider a circular path with center at the origin and radius greater than unity. We can either say that this path encloses the two branch points at  $z = \pm 1$  and no other singularities or we can say that this path encloses the point at infinity and no other singularities. We examine the value of the argument of the logarithm on this path.

$$z + (z^2 - 1)^{1/2} = z + (z^2)^{1/2} (1 - z^{-2})^{1/2}$$

Neither  $(z^2)^{1/2}$  nor  $(1 - z^{-2})^{1/2}$  changes value as we walk the path. Thus we can use the principal branch of the square root in the expression.

$$z + (z^2 - 1)^{1/2} = z \pm z\sqrt{1 - z^{-2}} = z \left( 1 \pm \sqrt{1 - z^{-2}} \right)$$

First consider the “+” branch.

$$z \left( 1 + \sqrt{1 - z^{-2}} \right)$$

As we walk the path around infinity, the argument of  $z$  changes by  $2\pi$  while the argument of  $(1 + \sqrt{1 - z^{-2}})$  does not change. Thus the argument of  $z + (z^2 - 1)^{1/2}$  changes by  $2\pi$  when we go around infinity. This makes the value of the logarithm change by  $i2\pi$ . There is a branch point at infinity.

First consider the “-” branch.

$$\begin{aligned} z \left( 1 - \sqrt{1 - z^{-2}} \right) &= z \left( 1 - \left( 1 - \frac{1}{2}z^{-2} + \mathcal{O}(z^{-4}) \right) \right) \\ &= z \left( \frac{1}{2}z^{-2} + \mathcal{O}(z^{-4}) \right) \\ &= \frac{1}{2}z^{-1} (1 + \mathcal{O}(z^{-2})) \end{aligned}$$

As we walk the path around infinity, the argument of  $z^{-1}$  changes by  $-2\pi$  while the argument of  $(1 + \mathcal{O}(z^{-2}))$  does not change. Thus the argument of  $z + (z^2 - 1)^{1/2}$  changes by  $-2\pi$  when we go around infinity. This makes the value of the logarithm change by  $-i2\pi$ . Again we conclude that there is a branch point at infinity.

For the sole purpose of overkill, let's repeat the above analysis from a geometric viewpoint. Again we consider the possibility of a branch point at infinity due to the logarithm. We walk along the circle shown in the first plot of Figure 7.45. Traversing this path, we go around infinity, but no other singularities. We consider the mapping  $w = z + (z^2 - 1)^{1/2}$ . Depending on the branch of the square root, the circle is mapped to one of the contours shown in the second plot. For each branch, the argument of  $w$  changes by  $\pm 2\pi$  as we traverse the circle in the  $z$ -plane. Therefore the value of  $\operatorname{arccosh}(z) = \log \left( z + (z^2 - 1)^{1/2} \right)$  changes by  $\pm i2\pi$  as we traverse the circle. We again conclude that there is a branch point at infinity due to the logarithm.

To summarize: There are branch points at  $z = \pm 1$  due to the square root and a branch point at infinity due to the logarithm.

## Branch Points and Branch Cuts

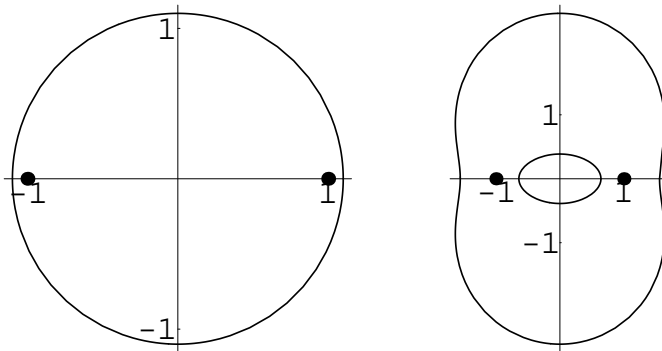

Figure 7.45: The mapping of a circle under  $w = z + (z^2 - 1)^{1/2}$ .

### Solution 7.19

We expand the function to diagnose the branch points in the finite complex plane.

$$f(z) = \log \left( \frac{z(z+1)}{z-1} \right) = \log(z) + \log(z+1) - \log(z-1)$$

The are branch points at  $z = -1, 0, 1$ . Now we examine the point at infinity. We make the change of variables  $z = 1/\zeta$ .

$$\begin{aligned} f\left(\frac{1}{\zeta}\right) &= \log \left( \frac{(1/\zeta)(1/\zeta + 1)}{(1/\zeta - 1)} \right) \\ &= \log \left( \frac{1}{\zeta} \frac{1 + \zeta}{1 - \zeta} \right) \\ &= \log(1 + \zeta) - \log(1 - \zeta) - \log(\zeta) \end{aligned}$$

$\log(\zeta)$  has a branch point at  $\zeta = 0$ . The other terms do not have branch points there. Since  $f(1/\zeta)$  has a branch point at  $\zeta = 0$   $f(z)$  has a branch point at infinity.

Note that in walking around either  $z = -1$  or  $z = 0$  once in the positive direction, the argument of  $z(z+1)/(z-1)$  changes by  $2\pi$ . In walking around  $z = 1$ , the argument of  $z(z+1)/(z-1)$  changes by  $-2\pi$ . This argument does not

change if we walk around both  $z = 0$  and  $z = 1$ . Thus we put a branch cut between  $z = 0$  and  $z = 1$ . Next we put a branch cut between  $z = -1$  and the point at infinity. This prevents us from walking around either of these branch points. These two branch cuts separate the branches of the function. See Figure 7.46

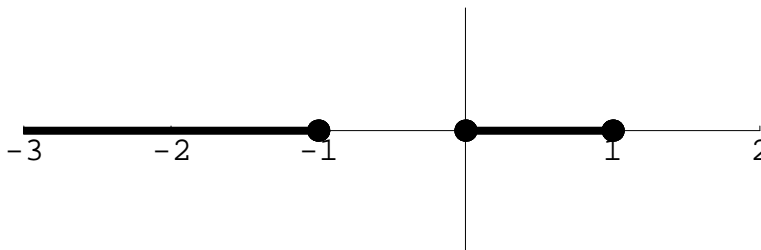

Figure 7.46: Branch cuts for  $\log\left(\frac{z(z+1)}{z-1}\right)$ .

### Solution 7.20

First we factor the function.

$$f(z) = (z(z+3)(z-2))^{1/2} = z^{1/2}(z+3)^{1/2}(z-2)^{1/2}$$

There are branch points at  $z = -3, 0, 2$ . Now we examine the point at infinity.

$$f\left(\frac{1}{\zeta}\right) = \left(\frac{1}{\zeta}\left(\frac{1}{\zeta} + 3\right)\left(\frac{1}{\zeta} - 2\right)\right)^{1/2} = \zeta^{-3/2}((1+3\zeta)(1-2\zeta))^{1/2}$$

Since  $\zeta^{-3/2}$  has a branch point at  $\zeta = 0$  and the rest of the terms are analytic there,  $f(z)$  has a branch point at infinity.

Consider the set of branch cuts in Figure 7.47. These cuts do not permit us to walk around any single branch point. We can only walk around none or all of the branch points, (which is the same thing). The cuts can be used to define a single-valued branch of the function.

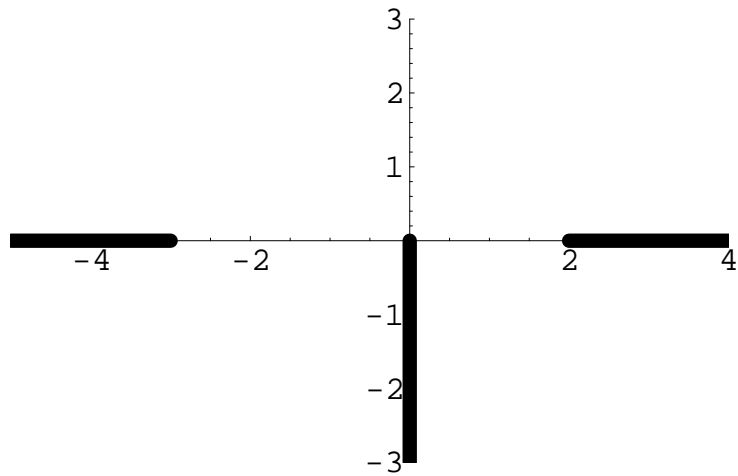

Figure 7.47: Branch cuts for  $(z^3 + z^2 - 6z)^{1/2}$ .

Now to define the branch. We make a choice of angles.

$$\begin{aligned} z + 3 &= r_1 e^{i\theta_1}, & -\pi < \theta_1 < \pi \\ z &= r_2 e^{i\theta_2}, & -\frac{\pi}{2} < \theta_2 < \frac{3\pi}{2} \\ z - 2 &= r_3 e^{i\theta_3}, & 0 < \theta_3 < 2\pi \end{aligned}$$

The function is

$$f(z) = (r_1 e^{i\theta_1} r_2 e^{i\theta_2} r_3 e^{i\theta_3})^{1/2} = \sqrt{r_1 r_2 r_3} e^{i(\theta_1 + \theta_2 + \theta_3)/2}.$$

We evaluate the function at  $z = -1$ .

$$f(-1) = \sqrt{(2)(1)(3)} e^{i(0 + \pi + \pi)/2} = -\sqrt{6}$$

We see that our choice of angles gives us the desired branch.

The stereographic projection is the projection from the complex plane onto a unit sphere with south pole at the origin. The point  $z = x + iy$  is mapped to the point  $(X, Y, Z)$  on the sphere with

$$X = \frac{4x}{|z|^2 + 4}, \quad Y = \frac{4y}{|z|^2 + 4}, \quad Z = \frac{2|z|^2}{|z|^2 + 4}.$$

Figure 7.48 first shows the branch cuts and their stereographic projections and then shows the stereographic projections alone.

### Solution 7.21

1. For each value of  $z$ ,  $f(z) = z^{1/3}$  has three values.

$$f(z) = z^{1/3} = \sqrt[3]{z} e^{ik2\pi/3}, \quad k = 0, 1, 2$$

- 2.

$$g(w) = w^3 = |w|^3 e^{i3\arg(w)}$$



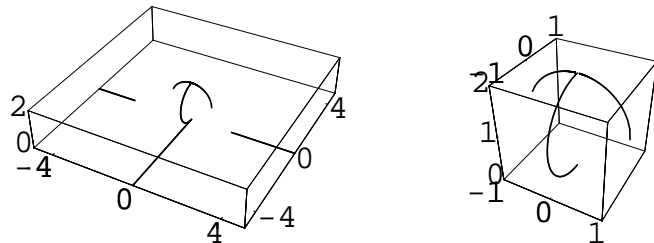

Figure 7.48: Branch cuts for  $(z^3 + z^2 - 6z)^{1/2}$  and their stereographic projections.

Any sector of the  $w$  plane of angle  $2\pi/3$  maps one-to-one to the whole  $z$ -plane.

$$g : \{r e^{i\theta} \mid r \geq 0, \theta_0 \leq \theta < \theta_0 + 2\pi/3\} \mapsto \{r^3 e^{i3\theta} \mid r \geq 0, \theta_0 \leq \theta < \theta_0 + 2\pi/3\}$$

$$g : \{r e^{i\theta} \mid r \geq 0, \theta_0 \leq \theta < \theta_0 + 2\pi/3\} \mapsto \{r e^{i\theta} \mid r \geq 0, 3\theta_0 \leq \theta < 3\theta_0 + 2\pi\}$$

$$g : \{r e^{i\theta} \mid r \geq 0, \theta_0 \leq \theta < \theta_0 + 2\pi/3\} \mapsto \mathbb{C}$$

See Figure 7.49 to see how  $g(w)$  maps the sector  $0 \leq \theta < 2\pi/3$ .

3. See Figure 7.50 for a depiction of the Riemann surface for  $f(z) = z^{1/3}$ . We show two views of the surface and a curve that traces the edge of the shown portion of the surface. The depiction is misleading because the surface is not self-intersecting. We would need four dimensions to properly visualize the this Riemann surface.
4.  $f(z) = z^{1/3}$  has branch points at  $z = 0$  and  $z = \infty$ . Any branch cut which connects these two points would prevent us from walking around the points singly and would thus separate the branches of the function. For example, we could put a branch cut on the negative real axis. Defining the angle  $-\pi < \theta < \pi$  for the mapping

$$f(r e^{i\theta}) = \sqrt[3]{r} e^{i\theta/3}$$

defines a single-valued branch of the function.

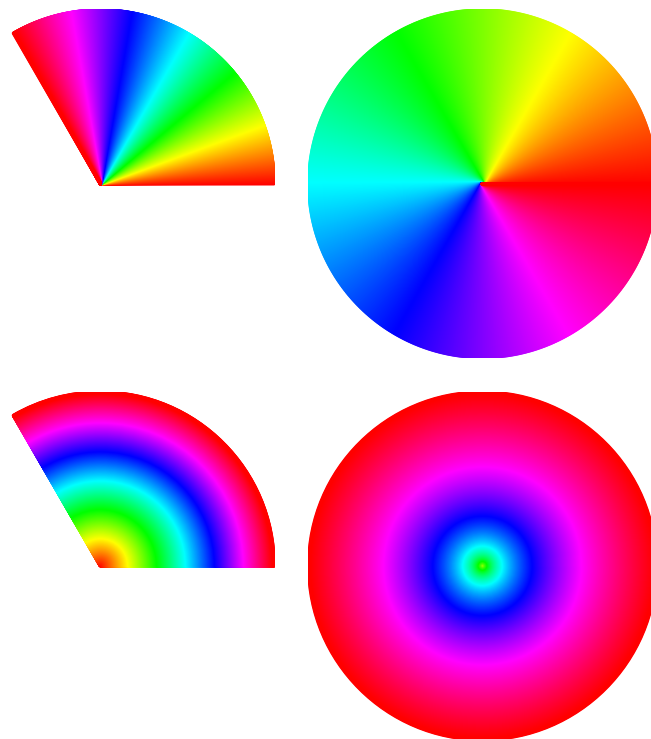

Figure 7.49: The function  $g(w) = w^3$  maps the sector  $0 \leq \theta < 2\pi/3$  one-to-one to the whole  $z$ -plane.

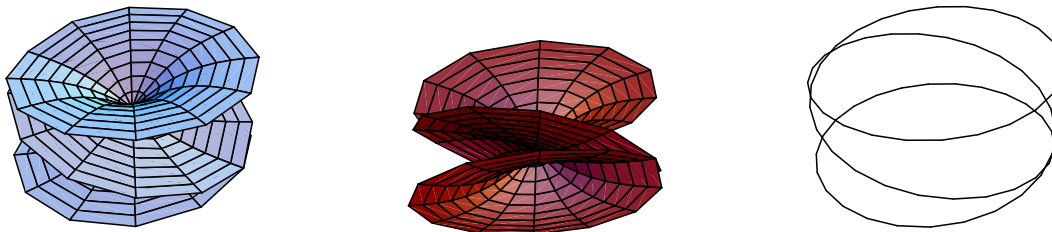

Figure 7.50: Riemann surface for  $f(z) = z^{1/3}$ .

### Solution 7.22

The cube roots of 1 are

$$\{1, e^{i2\pi/3}, e^{i4\pi/3}\} = \left\{1, \frac{-1 + i\sqrt{3}}{2}, \frac{-1 - i\sqrt{3}}{2}\right\}.$$

We factor the polynomial.

$$(z^3 - 1)^{1/2} = (z - 1)^{1/2} \left(z + \frac{1 - i\sqrt{3}}{2}\right)^{1/2} \left(z + \frac{1 + i\sqrt{3}}{2}\right)^{1/2}$$

There are branch points at each of the cube roots of unity.

$$z = \left\{1, \frac{-1 + i\sqrt{3}}{2}, \frac{-1 - i\sqrt{3}}{2}\right\}$$

Now we examine the point at infinity. We make the change of variables  $z = 1/\zeta$ .

$$f(1/\zeta) = (1/\zeta^3 - 1)^{1/2} = \zeta^{-3/2} (1 - \zeta^3)^{1/2}$$

$\zeta^{-3/2}$  has a branch point at  $\zeta = 0$ , while  $(1 - \zeta^3)^{1/2}$  is not singular there. Since  $f(1/\zeta)$  has a branch point at  $\zeta = 0$ ,  $f(z)$  has a branch point at infinity.

There are several ways of introducing branch cuts to separate the branches of the function. The easiest approach is to put a branch cut from each of the three branch points in the finite complex plane out to the branch point at infinity. See Figure 7.51a. Clearly this makes the function single valued as it is impossible to walk around any of the branch points. Another approach is to have a branch cut from one of the branch points in the finite plane to the branch point at infinity and a branch cut connecting the remaining two branch points. See Figure 7.51bcd. Note that in walking around any one of the finite branch points, (in the positive direction), the argument of the function changes by  $\pi$ . This means that the value of the function changes by  $e^{i\pi}$ , which is to say the value of the function changes sign. In walking around any two of the finite branch points, (again in the positive direction), the argument of the function changes by  $2\pi$ . This means that the value of the function changes by  $e^{i2\pi}$ , which is to say that the value of the function does not change. This demonstrates that the latter branch cut approach makes the function single-valued.

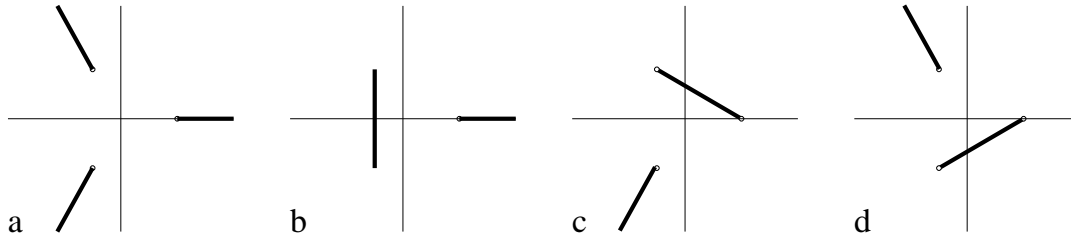

Figure 7.51: Suitable branch cuts for  $(z^3 - 1)^{1/2}$ .

Now we construct a branch. We will use the branch cuts in Figure 7.51a. We introduce variables to measure radii

and angles from the three finite branch points.

$$\begin{aligned} z - 1 &= r_1 e^{i\theta_1}, & 0 < \theta_1 < 2\pi \\ z + \frac{1 - i\sqrt{3}}{2} &= r_2 e^{i\theta_2}, & -\frac{2\pi}{3} < \theta_2 < \frac{\pi}{3} \\ z + \frac{1 + i\sqrt{3}}{2} &= r_3 e^{i\theta_3}, & -\frac{\pi}{3} < \theta_3 < \frac{2\pi}{3} \end{aligned}$$

We compute  $f(0)$  to see if it has the desired value.

$$\begin{aligned} f(z) &= \sqrt{r_1 r_2 r_3} e^{i(\theta_1 + \theta_2 + \theta_3)/2} \\ f(0) &= e^{i(\pi - \pi/3 + \pi/3)/2} = i \end{aligned}$$

Since it does not have the desired value, we change the range of  $\theta_1$ .

$$z - 1 = r_1 e^{i\theta_1}, \quad 2\pi < \theta_1 < 4\pi$$

$f(0)$  now has the desired value.

$$f(0) = e^{i(3\pi - \pi/3 + \pi/3)/2} = -i$$

We compute  $f(-1)$ .

$$f(-1) = \sqrt{2} e^{i(3\pi - 2\pi/3 + 2\pi/3)/2} = -i\sqrt{2}$$

### Solution 7.23

First we factor the function.

$$w(z) = ((z + 2)(z - 1)(z - 6))^{1/2} = (z + 2)^{1/2}(z - 1)^{1/2}(z - 6)^{1/2}$$

There are branch points at  $z = -2, 1, 6$ . Now we examine the point at infinity.

$$w\left(\frac{1}{\zeta}\right) = \left(\left(\frac{1}{\zeta} + 2\right)\left(\frac{1}{\zeta} - 1\right)\left(\frac{1}{\zeta} - 6\right)\right)^{1/2} = \zeta^{-3/2} \left(\left(1 + \frac{2}{\zeta}\right)\left(1 - \frac{1}{\zeta}\right)\left(1 - \frac{6}{\zeta}\right)\right)^{1/2}$$

Since  $\zeta^{-3/2}$  has a branch point at  $\zeta = 0$  and the rest of the terms are analytic there,  $w(z)$  has a branch point at infinity.

Consider the set of branch cuts in Figure 7.52. These cuts let us walk around the branch points at  $z = -2$  and  $z = 1$  together or if we change our perspective, we would be walking around the branch points at  $z = 6$  and  $z = \infty$  together. Consider a contour in this cut plane that encircles the branch points at  $z = -2$  and  $z = 1$ . Since the argument of  $(z - z_0)^{1/2}$  changes by  $\pi$  when we walk around  $z_0$ , the argument of  $w(z)$  changes by  $2\pi$  when we traverse the contour. Thus the value of the function does not change and it is a valid set of branch cuts.

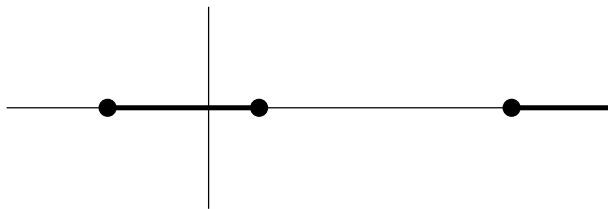

Figure 7.52: Branch cuts for  $((z + 2)(z - 1)(z - 6))^{1/2}$ .

Now to define the branch. We make a choice of angles.

$$z + 2 = r_1 e^{i\theta_1}, \quad \theta_1 = \theta_2 \text{ for } z \in (1 \dots 6),$$

$$z - 1 = r_2 e^{i\theta_2}, \quad \theta_2 = \theta_1 \text{ for } z \in (1 \dots 6),$$

$$z - 6 = r_3 e^{i\theta_3}, \quad 0 < \theta_3 < 2\pi$$

The function is

$$w(z) = (r_1 e^{i\theta_1} r_2 e^{i\theta_2} r_3 e^{i\theta_3})^{1/2} = \sqrt{r_1 r_2 r_3} e^{i(\theta_1 + \theta_2 + \theta_3)/2}.$$

We evaluate the function at  $z = 4$ .

$$w(4) = \sqrt{(6)(3)(2)} e^{i(2\pi n + 2\pi n + \pi)/2} = i6$$

We see that our choice of angles gives us the desired branch.

**Solution 7.24**

1.

$$\cos(z^{1/2}) = \cos(\pm\sqrt{z}) = \cos(\sqrt{z})$$

This is a single-valued function. There are no branch points.

2.

$$\begin{aligned}(z+i)^{-z} &= e^{-z \log(z+i)} \\ &= e^{-z(\ln|z+i| + i \operatorname{Arg}(z+i) + i2\pi n)}, \quad n \in \mathbb{Z}\end{aligned}$$

There is a branch point at  $z = -i$ . There are an infinite number of branches.

**Solution 7.25**

1.

$$f(z) = (z^2 + 1)^{1/2} = (z+i)^{1/2}(z-i)^{1/2}$$

We see that there are branch points at  $z = \pm i$ . To examine the point at infinity, we substitute  $z = 1/\zeta$  and examine the point  $\zeta = 0$ .

$$\left( \left( \frac{1}{\zeta} \right)^2 + 1 \right)^{1/2} = \frac{1}{(\zeta^2)^{1/2}} (1 + \zeta^2)^{1/2}$$

Since there is no branch point at  $\zeta = 0$ ,  $f(z)$  has no branch point at infinity.

A branch cut connecting  $z = \pm i$  would make the function single-valued. We could also accomplish this with two branch cuts starting  $z = \pm i$  and going to infinity.

2.

$$f(z) = (z^3 - z)^{1/2} = z^{1/2}(z-1)^{1/2}(z+1)^{1/2}$$

There are branch points at  $z = -1, 0, 1$ . Now we consider the point at infinity.

$$f\left(\frac{1}{\zeta}\right) = \left( \left( \frac{1}{\zeta} \right)^3 - \frac{1}{\zeta} \right)^{1/2} = \zeta^{-3/2} (1 - \zeta^2)^{1/2}$$

There is a branch point at infinity.

One can make the function single-valued with three branch cuts that start at  $z = -1, 0, 1$  and each go to infinity. We can also make the function single-valued with a branch cut that connects two of the points  $z = -1, 0, 1$  and another branch cut that starts at the remaining point and goes to infinity.

3.

$$f(z) = \log(z^2 - 1) = \log(z - 1) + \log(z + 1)$$

There are branch points at  $z = \pm 1$ .

$$f\left(\frac{1}{\zeta}\right) = \log\left(\frac{1}{\zeta^2} - 1\right) = \log(\zeta^{-2}) + \log(1 - \zeta^2)$$

$\log(\zeta^{-2})$  has a branch point at  $\zeta = 0$ .

$$\log(\zeta^{-2}) = \ln|\zeta^{-2}| + i \arg(\zeta^{-2}) = \ln|\zeta^{-2}| - i2 \arg(\zeta)$$

Every time we walk around the point  $\zeta = 0$  in the positive direction, the value of the function changes by  $-i4\pi$ .  $f(z)$  has a branch point at infinity.

We can make the function single-valued by introducing two branch cuts that start at  $z = \pm 1$  and each go to infinity.

4.

$$f(z) = \log\left(\frac{z+1}{z-1}\right) = \log(z+1) - \log(z-1)$$

There are branch points at  $z = \pm 1$ .

$$f\left(\frac{1}{\zeta}\right) = \log\left(\frac{1/\zeta + 1}{1/\zeta - 1}\right) = \log\left(\frac{1 + \zeta}{1 - \zeta}\right)$$

There is no branch point at  $\zeta = 0$ .  $f(z)$  has no branch point at infinity.



We can make the function single-valued by introducing two branch cuts that start at  $z = \pm 1$  and each go to infinity. We can also make the function single-valued with a branch cut that connects the points  $z = \pm 1$ . This is because  $\log(z + 1)$  and  $-\log(z - 1)$  change by  $i2\pi$  and  $-i2\pi$ , respectively, when you walk around their branch points once in the positive direction.

### Solution 7.26

1. The cube roots of  $-8$  are

$$\{-2, -2e^{i2\pi/3}, -2e^{i4\pi/3}\} = \{-2, 1 + i\sqrt{3}, 1 - i\sqrt{3}\}.$$

Thus we can write

$$(z^3 + 8)^{1/2} = (z + 2)^{1/2} (z - 1 - i\sqrt{3})^{1/2} (z - 1 + i\sqrt{3})^{1/2}.$$

There are three branch points on the circle of radius 2.

$$z = \{-2, 1 + i\sqrt{3}, 1 - i\sqrt{3}\}.$$

We examine the point at infinity.

$$f(1/\zeta) = (1/\zeta^3 + 8)^{1/2} = \zeta^{-3/2} (1 + 8\zeta^3)^{1/2}$$

Since  $f(1/\zeta)$  has a branch point at  $\zeta = 0$ ,  $f(z)$  has a branch point at infinity.

There are several ways of introducing branch cuts outside of the disk  $|z| < 2$  to separate the branches of the function. The easiest approach is to put a branch cut from each of the three branch points in the finite complex plane out to the branch point at infinity. See Figure 7.53a. Clearly this makes the function single valued as it is impossible to walk around any of the branch points. Another approach is to have a branch cut from one of the branch points in the finite plane to the branch point at infinity and a branch cut connecting the remaining two branch points. See Figure 7.53bcd. Note that in walking around any one of the finite branch points, (in the positive direction), the argument of the function changes by  $\pi$ . This means that the value of the function changes by  $e^{z\pi}$ , which is to say the value of the function changes sign. In walking around any two of the finite

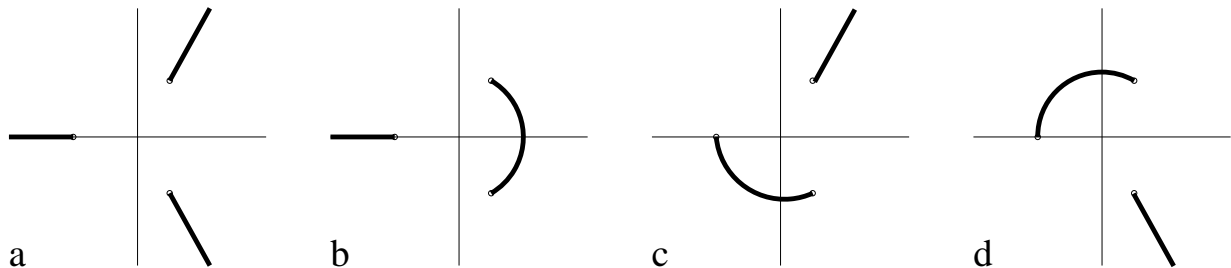

Figure 7.53: Suitable branch cuts for  $(z^3 + 8)^{1/2}$ .

branch points, (again in the positive direction), the argument of the function changes by  $2\pi$ . This means that the value of the function changes by  $e^{i2\pi}$ , which is to say that the value of the function does not change. This demonstrates that the latter branch cut approach makes the function single-valued.

2.

$$f(z) = \log \left( 5 + \left( \frac{z+1}{z-1} \right)^{1/2} \right)$$

First we deal with the function

$$g(z) = \left( \frac{z+1}{z-1} \right)^{1/2}$$

Note that it has branch points at  $z = \pm 1$ . Consider the point at infinity.

$$g(1/\zeta) = \left( \frac{1/\zeta + 1}{1/\zeta - 1} \right)^{1/2} = \left( \frac{1 + \zeta}{1 - \zeta} \right)^{1/2}$$

Since  $g(1/\zeta)$  has no branch point at  $\zeta = 0$ ,  $g(z)$  has no branch point at infinity. This means that if we walk around both of the branch points at  $z = \pm 1$ , the function does not change value. We can verify this with another method: When we walk around the point  $z = -1$  once in the positive direction, the argument of  $z + 1$  changes by  $2\pi$ , the argument of  $(z + 1)^{1/2}$  changes by  $\pi$  and thus the value of  $(z + 1)^{1/2}$  changes by  $e^{i\pi} = -1$ . When we

walk around the point  $z = 1$  once in the positive direction, the argument of  $z - 1$  changes by  $2\pi$ , the argument of  $(z - 1)^{-1/2}$  changes by  $-\pi$  and thus the value of  $(z - 1)^{-1/2}$  changes by  $e^{-i\pi} = -1$ .  $f(z)$  has branch points at  $z = \pm 1$ . When we walk around both points  $z = \pm 1$  once in the positive direction, the value of  $\left(\frac{z+1}{z-1}\right)^{1/2}$  does not change. Thus we can make the function single-valued with a branch cut which enables us to walk around either none or both of these branch points. We put a branch cut from  $-1$  to  $1$  on the real axis.

$f(z)$  has branch points where

$$5 + \left(\frac{z+1}{z-1}\right)^{1/2}$$

is either zero or infinite. The only place in the extended complex plane where the expression becomes infinite is at  $z = 1$ . Now we look for the zeros.

$$5 + \left(\frac{z+1}{z-1}\right)^{1/2} = 0$$

$$\left(\frac{z+1}{z-1}\right)^{1/2} = -5$$

$$\frac{z+1}{z-1} = 25$$

$$z + 1 = 25z - 25$$

$$z = \frac{13}{12}$$

Note that

$$\left(\frac{13/12 + 1}{13/12 - 1}\right)^{1/2} = 25^{1/2} = \pm 5.$$

On one branch, (which we call the positive branch), of the function  $g(z)$  the quantity

$$5 + \left(\frac{z+1}{z-1}\right)^{1/2}$$

is always nonzero. On the other (negative) branch of the function, this quantity has a zero at  $z = 13/12$ .

The logarithm introduces branch points at  $z = 1$  on both the positive and negative branch of  $g(z)$ . It introduces a branch point at  $z = 13/12$  on the negative branch of  $g(z)$ . To determine if additional branch cuts are needed to separate the branches, we consider

$$w = 5 + \left( \frac{z+1}{z-1} \right)^{1/2}$$

and see where the branch cut between  $\pm 1$  gets mapped to in the  $w$  plane. We rewrite the mapping.

$$w = 5 + \left( 1 + \frac{2}{z-1} \right)^{1/2}$$

The mapping is the following sequence of simple transformations:

(a)  $z \mapsto z - 1$

(b)  $z \mapsto \frac{1}{z}$

(c)  $z \mapsto 2z$

(d)  $z \mapsto z + 1$

(e)  $z \mapsto z^{1/2}$

(f)  $z \mapsto z + 5$

We show these transformations graphically below.

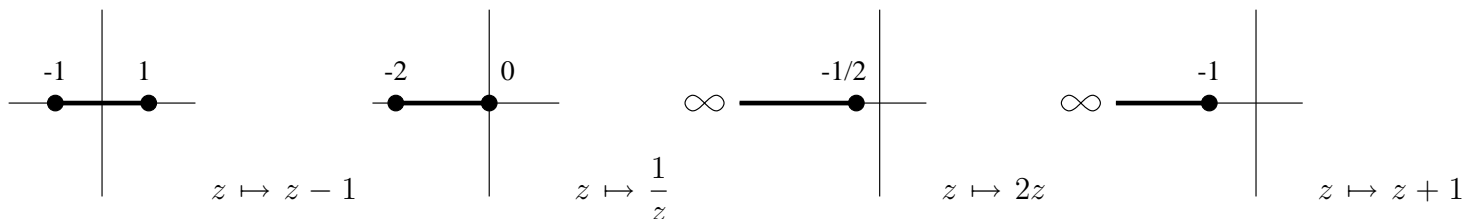

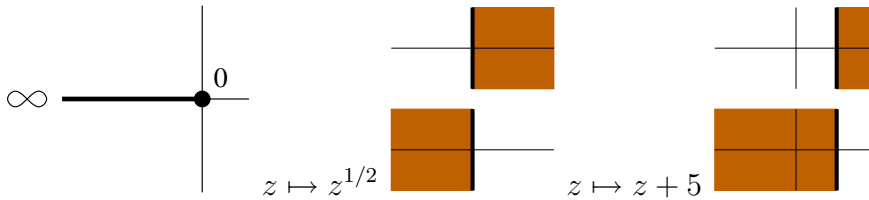

For the positive branch of  $g(z)$ , the branch cut is mapped to the line  $x = 5$  and the  $z$  plane is mapped to the half-plane  $x > 5$ .  $\log(w)$  has branch points at  $w = 0$  and  $w = \infty$ . It is possible to walk around only one of these points in the half-plane  $x > 5$ . Thus no additional branch cuts are needed in the positive sheet of  $g(z)$ .

For the negative branch of  $g(z)$ , the branch cut is mapped to the line  $x = 5$  and the  $z$  plane is mapped to the half-plane  $x < 5$ . It is possible to walk around either  $w = 0$  or  $w = \infty$  alone in this half-plane. Thus we need an additional branch cut. On the negative sheet of  $g(z)$ , we put a branch cut between  $z = 1$  and  $z = 13/12$ . This puts a branch cut between  $w = \infty$  and  $w = 0$  and thus separates the branches of the logarithm.

Figure 7.54 shows the branch cuts in the positive and negative sheets of  $g(z)$ .

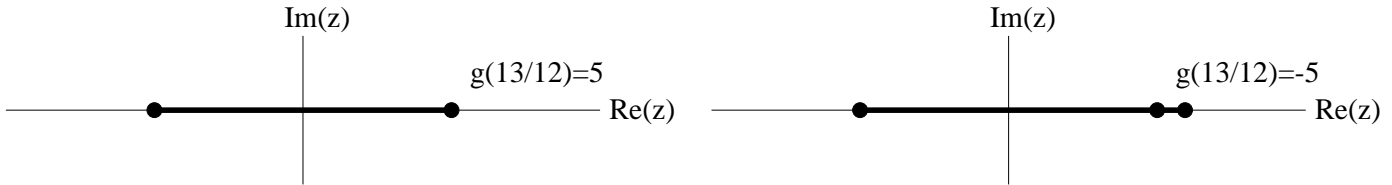

Figure 7.54: The branch cuts for  $f(z) = \log\left(5 + \left(\frac{z+1}{z-1}\right)^{1/2}\right)$ .

- The function  $f(z) = (z+i3)^{1/2}$  has a branch point at  $z = -i3$ . The function is made single-valued by connecting this point and the point at infinity with a branch cut.

### Solution 7.27

Note that the curve with opposite orientation goes around infinity in the positive direction and does not enclose any branch points. Thus the value of the function does not change when traversing the curve, (with either orientation, of

course). This means that the argument of the function must change by an integer multiple of  $2\pi$ . Since the branch cut only allows us to encircle all three or none of the branch points, it makes the function single valued.

### Solution 7.28

We suppose that  $f(z)$  has only one branch point in the finite complex plane. Consider any contour that encircles this branch point in the positive direction.  $f(z)$  changes value if we traverse the contour. If we reverse the orientation of the contour, then it encircles infinity in the positive direction, but contains no branch points in the finite complex plane. Since the function changes value when we traverse the contour, we conclude that the point at infinity must be a branch point. If  $f(z)$  has only a single branch point in the finite complex plane then it must have a branch point at infinity.

If  $f(z)$  has two or more branch points in the finite complex plane then it may or may not have a branch point at infinity. This is because the value of the function may or may not change on a contour that encircles all the branch points in the finite complex plane.

### Solution 7.29

First we factor the function,

$$f(z) = (z^4 + 1)^{1/4} = \left(z - \frac{1+i}{\sqrt{2}}\right)^{1/4} \left(z - \frac{-1+i}{\sqrt{2}}\right)^{1/4} \left(z - \frac{-1-i}{\sqrt{2}}\right)^{1/4} \left(z - \frac{1-i}{\sqrt{2}}\right)^{1/4}.$$

There are branch points at  $z = \frac{\pm 1 \pm i}{\sqrt{2}}$ . We make the substitution  $z = 1/\zeta$  to examine the point at infinity.

$$\begin{aligned} f\left(\frac{1}{\zeta}\right) &= \left(\frac{1}{\zeta^4} + 1\right)^{1/4} \\ &= \frac{1}{(\zeta^4)^{1/4}} (1 + \zeta^4)^{1/4} \end{aligned}$$

$(\zeta^{1/4})^4$  has a removable singularity at the point  $\zeta = 0$ , but no branch point there. Thus  $(z^4 + 1)^{1/4}$  has no branch point at infinity.

Note that the argument of  $(z^4 - z_0)^{1/4}$  changes by  $\pi/2$  on a contour that goes around the point  $z_0$  once in the positive direction. The argument of  $(z^4 + 1)^{1/4}$  changes by  $n\pi/2$  on a contour that goes around  $n$  of its branch points.

Thus any set of branch cuts that permit you to walk around only one, two or three of the branch points will not make the function single valued. A set of branch cuts that permit us to walk around only zero or all four of the branch points will make the function single-valued. Thus we see that the first two sets of branch cuts in Figure 7.32 will make the function single-valued, while the remaining two will not.

Consider the contour in Figure 7.32. There are two ways to see that the function does not change value while traversing the contour. The first is to note that each of the branch points makes the argument of the function increase by  $\pi/2$ . Thus the argument of  $(z^4 + 1)^{1/4}$  changes by  $4(\pi/2) = 2\pi$  on the contour. This means that the value of the function changes by the factor  $e^{i2\pi} = 1$ . If we change the orientation of the contour, then it is a contour that encircles infinity once in the positive direction. There are no branch points inside the this contour with opposite orientation. (Recall that the inside of a contour lies to your left as you walk around it.) Since there are no branch points inside this contour, the function cannot change value as we traverse it.

### Solution 7.30

$$f(z) = \left( \frac{z}{z^2 + 1} \right)^{1/3} = z^{1/3} (z - i)^{-1/3} (z + i)^{-1/3}$$

There are branch points at  $z = 0, \pm i$ .

$$f\left(\frac{1}{\zeta}\right) = \left( \frac{1/\zeta}{(1/\zeta)^2 + 1} \right)^{1/3} = \frac{\zeta^{1/3}}{(1 + \zeta^2)^{1/3}}$$

There is a branch point at  $\zeta = 0$ .  $f(z)$  has a branch point at infinity.

We introduce branch cuts from  $z = 0$  to infinity on the negative real axis, from  $z = i$  to infinity on the positive imaginary axis and from  $z = -i$  to infinity on the negative imaginary axis. As we cannot walk around any of the branch points, this makes the function single-valued.

We define a branch by defining angles from the branch points. Let

$$\begin{aligned} z &= r e^{i\theta} & -\pi < \theta < \pi, \\ (z - i) &= s e^{i\phi} & -3\pi/2 < \phi < \pi/2, \\ (z + i) &= t e^{i\psi} & -\pi/2 < \psi < 3\pi/2. \end{aligned}$$

With

$$\begin{aligned}
 f(z) &= z^{1/3}(z - i)^{-1/3}(z + i)^{-1/3} \\
 &= \sqrt[3]{r} e^{i\theta/3} \frac{1}{\sqrt[3]{s}} e^{-i\phi/3} \frac{1}{\sqrt[3]{t}} e^{-i\psi/3} \\
 &= \sqrt[3]{\frac{r}{st}} e^{i(\theta - \phi - \psi)/3}
 \end{aligned}$$

we have an explicit formula for computing the value of the function for this branch. Now we compute  $f(1)$  to see if we chose the correct ranges for the angles. (If not, we'll just change one of them.)

$$f(1) = \sqrt[3]{\frac{1}{\sqrt{2}\sqrt{2}}} e^{i(0 - \pi/4 - (-\pi/4))/3} = \frac{1}{\sqrt[3]{2}}$$

We made the right choice for the angles. Now to compute  $f(1 + i)$ .

$$f(1 + i) = \sqrt[3]{\frac{\sqrt{2}}{1\sqrt{5}}} e^{i(\pi/4 - 0 - \text{Arctan}(2))/3} = \sqrt[6]{\frac{2}{5}} e^{i(\pi/4 - \text{Arctan}(2))/3}$$

Consider the value of the function above and below the branch cut on the negative real axis. Above the branch cut the function is

$$f(-x + i0) = \sqrt[3]{\frac{x}{\sqrt{x^2 + 1}\sqrt{x^2 + 1}}} e^{i(\pi - \phi - \psi)/3}$$

Note that  $\phi = -\psi$  so that

$$f(-x + i0) = \sqrt[3]{\frac{x}{x^2 + 1}} e^{i\pi/3} = \sqrt[3]{\frac{x}{x^2 + 1}} \frac{1 + i\sqrt{3}}{2}.$$

Below the branch cut  $\theta = -\pi$  and

$$f(-x - i0) = \sqrt[3]{\frac{x}{x^2 + 1}} e^{i(-\pi)/3} = \sqrt[3]{\frac{x}{x^2 + 1}} \frac{1 - i\sqrt{3}}{2}.$$



For the branch cut along the positive imaginary axis,

$$\begin{aligned}
 f(iy + 0) &= \sqrt[3]{\frac{y}{(y-1)(y+1)}} e^{i(\pi/2 - \pi/2 - \pi/2)/3} \\
 &= \sqrt[3]{\frac{y}{(y-1)(y+1)}} e^{-i\pi/6} \\
 &= \sqrt[3]{\frac{y}{(y-1)(y+1)}} \frac{\sqrt{3} - i}{2},
 \end{aligned}$$

$$\begin{aligned}
 f(iy - 0) &= \sqrt[3]{\frac{y}{(y-1)(y+1)}} e^{i(\pi/2 - (-3\pi/2) - \pi/2)/3} \\
 &= \sqrt[3]{\frac{y}{(y-1)(y+1)}} e^{i\pi/2} \\
 &= i \sqrt[3]{\frac{y}{(y-1)(y+1)}}.
 \end{aligned}$$

For the branch cut along the negative imaginary axis,

$$\begin{aligned}
 f(-iy + 0) &= \sqrt[3]{\frac{y}{(y+1)(y-1)}} e^{i(-\pi/2 - (-\pi/2) - (-\pi/2))/3} \\
 &= \sqrt[3]{\frac{y}{(y+1)(y-1)}} e^{i\pi/6} \\
 &= \sqrt[3]{\frac{y}{(y+1)(y-1)}} \frac{\sqrt{3} + i}{2},
 \end{aligned}$$

$$\begin{aligned}
f(-iy - 0) &= \sqrt[3]{\frac{y}{(y+1)(y-1)}} e^{i(-\pi/2 - (-\pi/2) - (3\pi/2))/3} \\
&= \sqrt[3]{\frac{y}{(y+1)(y-1)}} e^{-i\pi/2} \\
&= -i \sqrt[3]{\frac{y}{(y+1)(y-1)}}.
\end{aligned}$$

### Solution 7.31

First we factor the function.

$$f(z) = ((z-1)(z-2)(z-3))^{1/2} = (z-1)^{1/2}(z-2)^{1/2}(z-3)^{1/2}$$

There are branch points at  $z = 1, 2, 3$ . Now we examine the point at infinity.

$$f\left(\frac{1}{\zeta}\right) = \left(\left(\frac{1}{\zeta} - 1\right)\left(\frac{1}{\zeta} - 2\right)\left(\frac{1}{\zeta} - 3\right)\right)^{1/2} = \zeta^{-3/2} \left(\left(1 - \frac{1}{\zeta}\right)\left(1 - \frac{2}{\zeta}\right)\left(1 - \frac{3}{\zeta}\right)\right)^{1/2}$$

Since  $\zeta^{-3/2}$  has a branch point at  $\zeta = 0$  and the rest of the terms are analytic there,  $f(z)$  has a branch point at infinity.

The first two sets of branch cuts in Figure 7.33 do not permit us to walk around any of the branch points, including the point at infinity, and thus make the function single-valued. The third set of branch cuts lets us walk around the branch points at  $z = 1$  and  $z = 2$  together or if we change our perspective, we would be walking around the branch points at  $z = 3$  and  $z = \infty$  together. Consider a contour in this cut plane that encircles the branch points at  $z = 1$  and  $z = 2$ . Since the argument of  $(z - z_0)^{1/2}$  changes by  $\pi$  when we walk around  $z_0$ , the argument of  $f(z)$  changes by  $2\pi$  when we traverse the contour. Thus the value of the function does not change and it is a valid set of branch cuts. Clearly the fourth set of branch cuts does not make the function single-valued as there are contours that encircle the branch point at infinity and no other branch points. The other way to see this is to note that the argument of  $f(z)$  changes by  $3\pi$  as we traverse a contour that goes around the branch points at  $z = 1, 2, 3$  once in the positive direction.

Now to define the branch. We make the preliminary choice of angles,

$$z - 1 = r_1 e^{i\theta_1}, \quad 0 < \theta_1 < 2\pi,$$

$$z - 2 = r_2 e^{i\theta_2}, \quad 0 < \theta_2 < 2\pi,$$

$$z - 3 = r_3 e^{i\theta_3}, \quad 0 < \theta_3 < 2\pi.$$

The function is

$$f(z) = (r_1 e^{i\theta_1} r_2 e^{i\theta_2} r_3 e^{i\theta_3})^{1/2} = \sqrt{r_1 r_2 r_3} e^{i(\theta_1 + \theta_2 + \theta_3)/2}.$$

The value of the function at the origin is

$$f(0) = \sqrt{6} e^{i(3\pi)/2} = -i\sqrt{6},$$

which is not what we wanted. We will change range of one of the angles to get the desired result.

$$z - 1 = r_1 e^{i\theta_1}, \quad 0 < \theta_1 < 2\pi,$$

$$z - 2 = r_2 e^{i\theta_2}, \quad 0 < \theta_2 < 2\pi,$$

$$z - 3 = r_3 e^{i\theta_3}, \quad 2\pi < \theta_3 < 4\pi.$$

$$f(0) = \sqrt{6} e^{i(5\pi)/2} = i\sqrt{6},$$

### Solution 7.32

$$w = ((z^2 - 2)(z + 2))^{1/3} (z + \sqrt{2})^{1/3} (z - \sqrt{2})^{1/3} (z + 2)^{1/3}$$

There are branch points at  $z = \pm\sqrt{2}$  and  $z = -2$ . If we walk around any one of the branch points once in the positive direction, the argument of  $w$  changes by  $2\pi/3$  and thus the value of the function changes by  $e^{i2\pi/3}$ . If we walk around all three branch points then the argument of  $w$  changes by  $3 \times 2\pi/3 = 2\pi$ . The value of the function is unchanged as  $e^{i2\pi} = 1$ . Thus the branch cut on the real axis from  $-2$  to  $\sqrt{2}$  makes the function single-valued.

Now we define a branch. Let

$$z - \sqrt{2} = a e^{i\alpha}, \quad z + \sqrt{2} = b e^{i\beta}, \quad z + 2 = c e^{i\gamma}.$$

We constrain the angles as follows: On the positive real axis,  $\alpha = \beta = \gamma$ . See Figure 7.55.

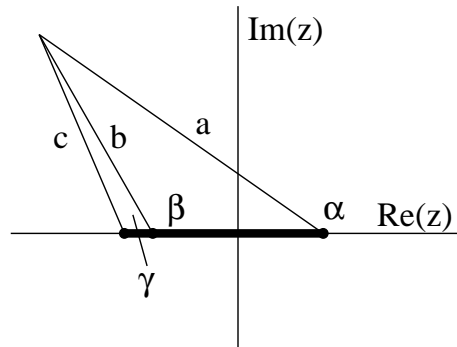

Figure 7.55: A branch of  $((z^2 - 2)(z + 2))^{1/3}$ .

Now we determine  $w(2)$ .

$$\begin{aligned}
 w(2) &= (2 - \sqrt{2})^{1/3} (2 + \sqrt{2})^{1/3} (2 + 2)^{1/3} \\
 &= \sqrt[3]{2 - \sqrt{2}} e^{i0} \sqrt[3]{2 + \sqrt{2}} e^{i0} \sqrt[3]{4} e^{i0} \\
 &= \sqrt[3]{2} \sqrt[3]{4} \\
 &= 2.
 \end{aligned}$$

Note that we didn't have to choose the angle from each of the branch points as zero. Choosing any integer multiple of  $2\pi$  would give us the same result.

$$\begin{aligned}
w(-3) &= (-3 - \sqrt{2})^{1/3} (-3 + \sqrt{2})^{1/3} (-3 + 2)^{1/3} \\
&= \sqrt[3]{3 + \sqrt{2}} e^{i\pi/3} \sqrt[3]{3 - \sqrt{2}} e^{i\pi/3} \sqrt[3]{1} e^{i\pi/3} \\
&= \sqrt[3]{7} e^{i\pi} \\
&= -\sqrt[3]{7}
\end{aligned}$$

The value of the function is

$$w = \sqrt[3]{abc} e^{i(\alpha+\beta+\gamma)/3}.$$

Consider the interval  $(-\sqrt{2} \dots \sqrt{2})$ . As we approach the branch cut from above, the function has the value,

$$w = \sqrt[3]{abc} e^{i\pi/3} = \sqrt[3]{(\sqrt{2} - x)(x + \sqrt{2})(x + 2)} e^{i\pi/3}.$$

As we approach the branch cut from below, the function has the value,

$$w = \sqrt[3]{abc} e^{-i\pi/3} = \sqrt[3]{(\sqrt{2} - x)(x + \sqrt{2})(x + 2)} e^{-i\pi/3}.$$

Consider the interval  $(-2 \dots -\sqrt{2})$ . As we approach the branch cut from above, the function has the value,

$$w = \sqrt[3]{abc} e^{i2\pi/3} = \sqrt[3]{(\sqrt{2} - x)(-x - \sqrt{2})(x + 2)} e^{i2\pi/3}.$$

As we approach the branch cut from below, the function has the value,

$$w = \sqrt[3]{abc} e^{-i2\pi/3} = \sqrt[3]{(\sqrt{2} - x)(-x - \sqrt{2})(x + 2)} e^{-i2\pi/3}.$$

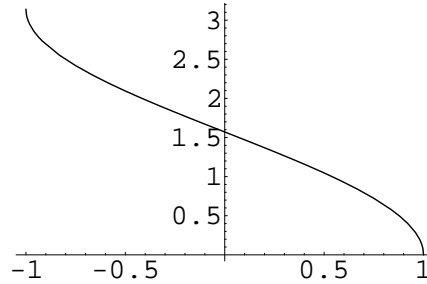

Figure 7.56: The principal branch of the arc cosine,  $\text{Arccos}(x)$ .

### Solution 7.33

$\text{Arccos}(x)$  is shown in Figure 7.56 for real variables in the range  $[-1 \dots 1]$ .

First we write  $\arccos(z)$  in terms of  $\log(z)$ . If  $\cos(w) = z$ , then  $w = \arccos(z)$ .

$$\begin{aligned} \cos(w) &= z \\ \frac{e^{iw} + e^{-iw}}{2} &= z \\ (e^{iw})^2 - 2ze^{iw} + 1 &= 0 \\ e^{iw} &= z + (z^2 - 1)^{1/2} \\ w &= -i \log \left( z + (z^2 - 1)^{1/2} \right) \end{aligned}$$

Thus we have

$$\boxed{\arccos(z) = -i \log \left( z + (z^2 - 1)^{1/2} \right).}$$

Since  $\text{Arccos}(0) = \frac{\pi}{2}$ , we must find the branch such that

$$\begin{aligned} -i \log \left( 0 + (0^2 - 1)^{1/2} \right) &= 0 \\ -i \log \left( (-1)^{1/2} \right) &= 0. \end{aligned}$$

Since

$$-i \log(i) = -i \left( i \frac{\pi}{2} + i2\pi n \right) = \frac{\pi}{2} + 2\pi n$$

and

$$-i \log(-i) = -i \left( -i \frac{\pi}{2} + i2\pi n \right) = -\frac{\pi}{2} + 2\pi n$$

we must choose the branch of the square root such that  $(-1)^{1/2} = i$  and the branch of the logarithm such that  $\log(i) = i\frac{\pi}{2}$ .

First we construct the branch of the square root.

$$(z^2 - 1)^{1/2} = (z + 1)^{1/2}(z - 1)^{1/2}$$

We see that there are branch points at  $z = -1$  and  $z = 1$ . In particular we want the  $\text{Arccos}$  to be defined for  $z = x$ ,  $x \in [-1 \dots 1]$ . Hence we introduce branch cuts on the lines  $-\infty < x \leq -1$  and  $1 \leq x < \infty$ . Define the local coordinates

$$z + 1 = r e^{i\theta}, \quad z - 1 = \rho e^{i\phi}.$$

With the given branch cuts, the angles have the possible ranges

$$\{\theta\} = \{\dots, (-\pi \dots \pi), (\pi \dots 3\pi), \dots\}, \quad \{\phi\} = \{\dots, (0 \dots 2\pi), (2\pi \dots 4\pi), \dots\}.$$

Now we choose ranges for  $\theta$  and  $\phi$  and see if we get the desired branch. If not, we choose a different range for one of the angles. First we choose the ranges

$$\theta \in (-\pi \dots \pi), \quad \phi \in (0 \dots 2\pi).$$

If we substitute in  $z = 0$  we get

$$(0^2 - 1)^{1/2} = (1 e^{i0})^{1/2} (1 e^{i\pi})^{1/2} = e^{i0} e^{i\pi/2} = i$$

Thus we see that this choice of angles gives us the desired branch.

Now we go back to the expression

$$\arccos(z) = -i \log \left( z + (z^2 - 1)^{1/2} \right).$$

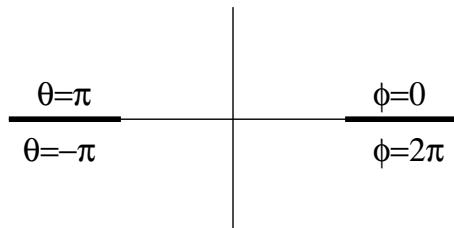

Figure 7.57: Branch cuts and angles for  $(z^2 - 1)^{1/2}$ .

We have already seen that there are branch points at  $z = -1$  and  $z = 1$  because of  $(z^2 - 1)^{1/2}$ . Now we must determine if the logarithm introduces additional branch points. The only possibilities for branch points are where the argument of the logarithm is zero.

$$\begin{aligned} z + (z^2 - 1)^{1/2} &= 0 \\ z^2 &= z^2 - 1 \\ 0 &= -1 \end{aligned}$$

We see that the argument of the logarithm is nonzero and thus there are no additional branch points. Introduce the variable,  $w = z + (z^2 - 1)^{1/2}$ . What is the image of the branch cuts in the  $w$  plane? We parameterize the branch cut connecting  $z = 1$  and  $z = +\infty$  with  $z = r + 1$ ,  $r \in [0 \dots \infty)$ .

$$\begin{aligned} w &= r + 1 + ((r + 1)^2 - 1)^{1/2} \\ &= r + 1 \pm \sqrt{r(r + 2)} \\ &= r \left( 1 \pm \sqrt{1 + 2/r} \right) + 1 \end{aligned}$$

$r \left( 1 + \sqrt{1 + 2/r} \right) + 1$  is the interval  $[1 \dots \infty)$ ;  $r \left( 1 - \sqrt{1 + 2/r} \right) + 1$  is the interval  $(0 \dots 1]$ . Thus we see that this branch cut is mapped to the interval  $(0 \dots \infty)$  in the  $w$  plane. Similarly, we could show that the branch cut  $(-\infty \dots -1]$



in the  $z$  plane is mapped to  $(-\infty \dots 0)$  in the  $w$  plane. In the  $w$  plane there is a branch cut along the real  $w$  axis from  $-\infty$  to  $\infty$ . Thus cut makes the logarithm single-valued. For the branch of the square root that we chose, all the points in the  $z$  plane get mapped to the upper half of the  $w$  plane.

With the branch cuts we have introduced so far and the chosen branch of the square root we have

$$\begin{aligned} \arccos(0) &= -i \log \left( 0 + (0^2 - 1)^{1/2} \right) \\ &= -i \log i \\ &= -i \left( i \frac{\pi}{2} + i2\pi n \right) \\ &= \frac{\pi}{2} + 2\pi n \end{aligned}$$

Choosing the  $n = 0$  branch of the logarithm will give us  $\text{Arccos}(z)$ . We see that we can write

$$\text{Arccos}(z) = -i \text{Log} \left( z + (z^2 - 1)^{1/2} \right).$$

### Solution 7.34

We consider the function  $f(z) = (z^{1/2} - 1)^{1/2}$ . First note that  $z^{1/2}$  has a branch point at  $z = 0$ . We place a branch cut on the negative real axis to make it single valued.  $f(z)$  will have a branch point where  $z^{1/2} - 1 = 0$ . This occurs at  $z = 1$  on the branch of  $z^{1/2}$  on which  $1^{1/2} = 1$ . ( $1^{1/2}$  has the value 1 on one branch of  $z^{1/2}$  and  $-1$  on the other branch.) For this branch we introduce a branch cut connecting  $z = 1$  with the point at infinity. (See Figure 7.58.)

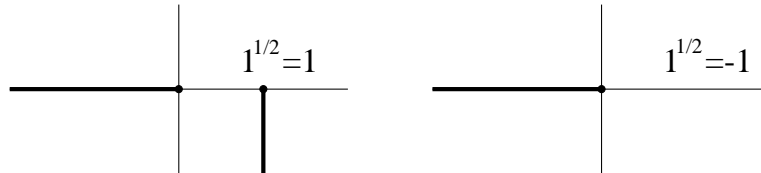

Figure 7.58: Branch cuts for  $(z^{1/2} - 1)^{1/2}$ .

### Solution 7.35

The distance between the end of rod  $a$  and the end of rod  $c$  is  $b$ . In the complex plane, these points are  $a e^{i\theta}$  and  $l + c e^{i\phi}$ , respectively. We write this out mathematically.

$$\begin{aligned} |l + c e^{i\phi} - a e^{i\theta}| &= b \\ (l + c e^{i\phi} - a e^{i\theta})(l + c e^{-i\phi} - a e^{-i\theta}) &= b^2 \\ l^2 + cl e^{-i\phi} - al e^{-i\theta} + cl e^{i\phi} + c^2 - ac e^{i(\phi-\theta)} - al e^{i\theta} - ac e^{i(\theta-\phi)} + a^2 &= b^2 \end{aligned}$$

$$\boxed{cl \cos \phi - ac \cos(\phi - \theta) - al \cos \theta = \frac{1}{2} (b^2 - a^2 - c^2 - l^2)}$$

This equation relates the two angular positions. One could differentiate the equation to relate the velocities and accelerations.

### Solution 7.36

1. Let  $w = u + iv$ . First we do the strip:  $|\Re(z)| < 1$ . Consider the vertical line:  $z = c + iy$ ,  $y \in \mathbb{R}$ . This line is mapped to

$$\begin{aligned} w &= 2(c + iy)^2 \\ w &= 2c^2 - 2y^2 + i4cy \\ u &= 2c^2 - 2y^2, \quad v = 4cy \end{aligned}$$

This is a parabola that opens to the left. For the case  $c = 0$  it is the negative  $u$  axis. We can parametrize the curve in terms of  $v$ .

$$u = 2c^2 - \frac{1}{8c^2}v^2, \quad v \in \mathbb{R}$$

The boundaries of the region are both mapped to the parabolas:

$$u = 2 - \frac{1}{8}v^2, \quad v \in \mathbb{R}.$$

The image of the mapping is

$$\boxed{\left\{ w = u + iv : v \in \mathbb{R} \text{ and } u < 2 - \frac{1}{8}v^2 \right\}}.$$

Note that the mapping is two-to-one.

Now we do the strip  $1 < \Im(z) < 2$ . Consider the horizontal line:  $z = x + ic$ ,  $x \in \mathbb{R}$ . This line is mapped to

$$\begin{aligned}w &= 2(x + ic)^2 \\w &= 2x^2 - 2c^2 + i4cx \\u &= 2x^2 - 2c^2, \quad v = 4cx\end{aligned}$$

This is a parabola that opens upward. We can parametrize the curve in terms of  $v$ .

$$u = \frac{1}{8c^2}v^2 - 2c^2, \quad v \in \mathbb{R}$$

The boundary  $\Im(z) = 1$  is mapped to

$$u = \frac{1}{8}v^2 - 2, \quad v \in \mathbb{R}.$$

The boundary  $\Im(z) = 2$  is mapped to

$$u = \frac{1}{32}v^2 - 8, \quad v \in \mathbb{R}$$

The image of the mapping is

$$\left\{ w = u + iv : v \in \mathbb{R} \text{ and } \frac{1}{32}v^2 - 8 < u < \frac{1}{8}v^2 - 2 \right\}.$$

2. We write the transformation as

$$\frac{z+1}{z-1} = 1 + \frac{2}{z-1}.$$

Thus we see that the transformation is the sequence:

- (a) translation by  $-1$
- (b) inversion

(c) magnification by 2

(d) translation by 1

Consider the strip  $|\Re(z)| < 1$ . The translation by  $-1$  maps this to  $-2 < \Re(z) < 0$ . Now we do the inversion. The left edge,  $\Re(z) = 0$ , is mapped to itself. The right edge,  $\Re(z) = -2$ , is mapped to the circle  $|z + 1/4| = 1/4$ . Thus the current image is the left half plane minus a circle:

$$\Re(z) < 0 \quad \text{and} \quad \left| z + \frac{1}{4} \right| > \frac{1}{4}.$$

The magnification by 2 yields

$$\Re(z) < 0 \quad \text{and} \quad \left| z + \frac{1}{2} \right| > \frac{1}{2}.$$

The final step is a translation by 1.

$$\boxed{\Re(z) < 1 \quad \text{and} \quad \left| z - \frac{1}{2} \right| > \frac{1}{2}.}$$

Now consider the strip  $1 < \Im(z) < 2$ . The translation by  $-1$  does not change the domain. Now we do the inversion. The bottom edge,  $\Im(z) = 1$ , is mapped to the circle  $|z + i/2| = 1/2$ . The top edge,  $\Im(z) = 2$ , is mapped to the circle  $|z + i/4| = 1/4$ . Thus the current image is the region between two circles:

$$\left| z + \frac{i}{2} \right| < \frac{1}{2} \quad \text{and} \quad \left| z + \frac{i}{4} \right| > \frac{1}{4}.$$

The magnification by 2 yields

$$|z + i| < 1 \quad \text{and} \quad \left| z + \frac{i}{2} \right| > \frac{1}{2}.$$

The final step is a translation by 1.

$$\boxed{|z - 1 + i| < 1 \quad \text{and} \quad \left| z - 1 + \frac{i}{2} \right| > \frac{1}{2}.}$$

### Solution 7.37

1. There is a simple pole at  $z = -2$ . The function has a branch point at  $z = -1$ . Since this is the only branch point in the finite complex plane there is also a branch point at infinity. We can verify this with the substitution  $z = 1/\zeta$ .

$$\begin{aligned} f\left(\frac{1}{\zeta}\right) &= \frac{(1/\zeta + 1)^{1/2}}{1/\zeta + 2} \\ &= \frac{\zeta^{1/2}(1 + \zeta)^{1/2}}{1 + 2\zeta} \end{aligned}$$

Since  $f(1/\zeta)$  has a branch point at  $\zeta = 0$ ,  $f(z)$  has a branch point at infinity.

2.  $\cos z$  is an entire function with an essential singularity at infinity. Thus  $f(z)$  has singularities only where  $1/(1+z)$  has singularities.  $1/(1+z)$  has a first order pole at  $z = -1$ . It is analytic everywhere else, including the point at infinity. Thus we conclude that  $f(z)$  has an essential singularity at  $z = -1$  and is analytic elsewhere. To explicitly show that  $z = -1$  is an essential singularity, we can find the Laurent series expansion of  $f(z)$  about  $z = -1$ .

$$\cos\left(\frac{1}{1+z}\right) = \sum_{n=0}^{\infty} \frac{(-1)^n}{(2n)!} (z+1)^{-2n}$$

3.  $1 - e^z$  has simple zeros at  $z = i2n\pi$ ,  $n \in \mathbb{Z}$ . Thus  $f(z)$  has second order poles at those points.

The point at infinity is a non-isolated singularity. To justify this: Note that

$$f(z) = \frac{1}{(1 - e^z)^2}$$

has second order poles at  $z = i2n\pi$ ,  $n \in \mathbb{Z}$ . This means that  $f(1/\zeta)$  has second order poles at  $\zeta = \frac{1}{i2n\pi}$ ,  $n \in \mathbb{Z}$ . These second order poles get arbitrarily close to  $\zeta = 0$ . There is no deleted neighborhood around  $\zeta = 0$  in which  $f(1/\zeta)$  is analytic. Thus the point  $\zeta = 0$ , ( $z = \infty$ ), is a non-isolated singularity. There is no Laurent series expansion about the point  $\zeta = 0$ , ( $z = \infty$ ).

The point at infinity is neither a branch point nor a removable singularity. It is not a pole either. If it were, there would be an  $n$  such that  $\lim_{z \rightarrow \infty} z^{-n} f(z) = \text{const} \neq 0$ . Since  $z^{-n} f(z)$  has second order poles in every deleted neighborhood of infinity, the above limit does not exist. Thus we conclude that the point at infinity is an essential singularity.

### Solution 7.38

We write  $\sinh z$  in Cartesian form.

$$w = \sinh z = \sinh x \cos y + i \cosh x \sin y = u + iv$$

Consider the line segment  $x = c, y \in (0 \dots \pi)$ . Its image is

$$\{\sinh c \cos y + i \cosh c \sin y \mid y \in (0 \dots \pi)\}.$$

This is the parametric equation for the upper half of an ellipse. Also note that  $u$  and  $v$  satisfy the equation for an ellipse.

$$\frac{u^2}{\sinh^2 c} + \frac{v^2}{\cosh^2 c} = 1$$

The ellipse starts at the point  $(\sinh(c), 0)$ , passes through the point  $(0, \cosh(c))$  and ends at  $(-\sinh(c), 0)$ . As  $c$  varies from zero to  $\infty$  or from zero to  $-\infty$ , the semi-ellipses cover the upper half  $w$  plane. Thus the mapping is 2-to-1.

Consider the infinite line  $y = c, x \in (-\infty \dots \infty)$ . Its image is

$$\{\sinh x \cos c + i \cosh x \sin c \mid x \in (-\infty \dots \infty)\}.$$

This is the parametric equation for the upper half of a hyperbola. Also note that  $u$  and  $v$  satisfy the equation for a hyperbola.

$$-\frac{u^2}{\cos^2 c} + \frac{v^2}{\sin^2 c} = 1$$

As  $c$  varies from 0 to  $\pi/2$  or from  $\pi/2$  to  $\pi$ , the semi-hyperbola cover the upper half  $w$  plane. Thus the mapping is 2-to-1.

We look for branch points of  $\sinh^{-1} w$ .

$$\begin{aligned}w &= \sinh z \\w &= \frac{e^z - e^{-z}}{2} \\e^{2z} - 2w e^z - 1 &= 0 \\e^z &= w + (w^2 + 1)^{1/2} \\z &= \log (w + (w - i)^{1/2}(w + i)^{1/2})\end{aligned}$$

There are branch points at  $w = \pm i$ . Since  $w + (w^2 + 1)^{1/2}$  is nonzero and finite in the finite complex plane, the logarithm does not introduce any branch points in the finite plane. Thus the only branch point in the upper half  $w$  plane is at  $w = i$ . Any branch cut that connects  $w = i$  with the boundary of  $\Im(w) > 0$  will separate the branches under the inverse mapping.

Consider the line  $y = \pi/4$ . The image under the mapping is the upper half of the hyperbola

$$2u^2 + 2v^2 = 1.$$

Consider the segment  $x = 1$ . The image under the mapping is the upper half of the ellipse

$$\frac{u^2}{\sinh^2 1} + \frac{v^2}{\cosh^2 1} = 1.$$

# Chapter 8

## Analytic Functions

Students need encouragement. So if a student gets an answer right, tell them it was a lucky guess. That way, they develop a good, lucky feeling.<sup>1</sup>

-Jack Hanley

### 8.1 Complex Derivatives

**Functions of a Real Variable.** The derivative of a function of a real variable is

$$\frac{d}{dx}f(x) = \lim_{\Delta x \rightarrow 0} \frac{f(x + \Delta x) - f(x)}{\Delta x}.$$

If the limit exists then the function is differentiable at the point  $x$ . Note that  $\Delta x$  can approach zero from above or below. The limit cannot depend on the direction in which  $\Delta x$  vanishes.

Consider  $f(x) = |x|$ . The function is not differentiable at  $x = 0$  since

$$\lim_{\Delta x \rightarrow 0^+} \frac{|0 + \Delta x| - |0|}{\Delta x} = 1$$

---

<sup>1</sup>Quote slightly modified.



and

$$\lim_{\Delta x \rightarrow 0^-} \frac{|0 + \Delta x| - |0|}{\Delta x} = -1.$$

**Analyticity.** The *complex derivative*, (or simply *derivative* if the context is clear), is defined,

$$\frac{d}{dz}f(z) = \lim_{\Delta z \rightarrow 0} \frac{f(z + \Delta z) - f(z)}{\Delta z}.$$

The complex derivative exists if this limit exists. This means that the value of the limit is independent of the manner in which  $\Delta z \rightarrow 0$ . If the complex derivative exists at a point, then we say that the function is *complex differentiable* there.

A function of a complex variable is *analytic* at a point  $z_0$  if the complex derivative exists in a neighborhood about that point. The function is analytic in an open set if it has a complex derivative at each point in that set. Note that complex differentiable has a different meaning than analytic. Analyticity refers to the behavior of a function on an open set. A function can be complex differentiable at isolated points, but the function would not be analytic at those points. Analytic functions are also called *regular* or *holomorphic*. If a function is analytic everywhere in the finite complex plane, it is called *entire*.

**Example 8.1.1** Consider  $z^n$ ,  $n \in \mathbb{Z}^+$ , Is the function differentiable? Is it analytic? What is the value of the derivative?

We determine differentiability by trying to differentiate the function. We use the limit definition of differentiation. We will use Newton's binomial formula to expand  $(z + \Delta z)^n$ .

$$\begin{aligned} \frac{d}{dz}z^n &= \lim_{\Delta z \rightarrow 0} \frac{(z + \Delta z)^n - z^n}{\Delta z} \\ &= \lim_{\Delta z \rightarrow 0} \frac{\left(z^n + nz^{n-1}\Delta z + \frac{n(n-1)}{2}z^{n-2}\Delta z^2 + \dots + \Delta z^n\right) - z^n}{\Delta z} \\ &= \lim_{\Delta z \rightarrow 0} \left(nz^{n-1} + \frac{n(n-1)}{2}z^{n-2}\Delta z + \dots + \Delta z^{n-1}\right) \\ &= nz^{n-1} \end{aligned}$$

The derivative exists everywhere. The function is analytic in the whole complex plane so it is entire. The value of the derivative is  $\frac{d}{dz} = nz^{n-1}$ .

**Example 8.1.2** We will show that  $f(z) = \bar{z}$  is not differentiable. Consider its derivative.

$$\frac{d}{dz}f(z) = \lim_{\Delta z \rightarrow 0} \frac{f(z + \Delta z) - f(z)}{\Delta z}.$$

$$\begin{aligned} \frac{d}{dz}\bar{z} &= \lim_{\Delta z \rightarrow 0} \frac{\overline{z + \Delta z} - \bar{z}}{\Delta z} \\ &= \lim_{\Delta z \rightarrow 0} \frac{\overline{\Delta z}}{\Delta z} \end{aligned}$$

First we take  $\Delta z = \Delta x$  and evaluate the limit.

$$\lim_{\Delta x \rightarrow 0} \frac{\Delta x}{\Delta x} = 1$$

Then we take  $\Delta z = i\Delta y$ .

$$\lim_{\Delta y \rightarrow 0} \frac{-i\Delta y}{i\Delta y} = -1$$

Since the limit depends on the way that  $\Delta z \rightarrow 0$ , the function is nowhere differentiable. Thus the function is not analytic.

**Complex Derivatives in Terms of Plane Coordinates.** Let  $z = \zeta(\xi, \psi)$  be a system of coordinates in the complex plane. (For example, we could have Cartesian coordinates  $z = \zeta(x, y) = x + iy$  or polar coordinates  $z = \zeta(r, \theta) = r e^{i\theta}$ .) Let  $f(z) = \phi(\xi, \psi)$  be a complex-valued function. (For example we might have a function in the form  $\phi(x, y) = u(x, y) + iv(x, y)$  or  $\phi(r, \theta) = R(r, \theta) e^{i\Theta(r, \theta)}$ .) If  $f(z) = \phi(\xi, \psi)$  is analytic, its complex derivative is

equal to the derivative in any direction. In particular, it is equal to the derivatives in the coordinate directions.

$$\frac{df}{dz} = \lim_{\Delta\xi \rightarrow 0, \Delta\psi=0} \frac{f(z + \Delta z) - f(z)}{\Delta z} = \lim_{\Delta\xi \rightarrow 0} \frac{\phi(\xi + \Delta\xi, \psi) - \phi(\xi, \psi)}{\frac{\partial\zeta}{\partial\xi}\Delta\xi} = \left(\frac{\partial\zeta}{\partial\xi}\right)^{-1} \frac{\partial\phi}{\partial\xi}$$

$$\frac{df}{dz} = \lim_{\Delta\xi=0, \Delta\psi \rightarrow 0} \frac{f(z + \Delta z) - f(z)}{\Delta z} = \lim_{\Delta\psi \rightarrow 0} \frac{\phi(\xi, \psi + \Delta\psi) - \phi(\xi, \psi)}{\frac{\partial\zeta}{\partial\psi}\Delta\psi} = \left(\frac{\partial\zeta}{\partial\psi}\right)^{-1} \frac{\partial\phi}{\partial\psi}$$

**Example 8.1.3** Consider the Cartesian coordinates  $z = x + iy$ . We write the complex derivative as derivatives in the coordinate directions for  $f(z) = \phi(x, y)$ .

$$\frac{df}{dz} = \left(\frac{\partial(x + iy)}{\partial x}\right)^{-1} \frac{\partial\phi}{\partial x} = \frac{\partial\phi}{\partial x}$$

$$\frac{df}{dz} = \left(\frac{\partial(x + iy)}{\partial y}\right)^{-1} \frac{\partial\phi}{\partial y} = -i \frac{\partial\phi}{\partial y}$$

We write this in operator notation.

$$\frac{d}{dz} = \frac{\partial}{\partial x} = -i \frac{\partial}{\partial y}.$$

**Example 8.1.4** In Example 8.1.1 we showed that  $z^n$ ,  $n \in \mathbb{Z}^+$ , is an entire function and that  $\frac{d}{dz}z^n = nz^{n-1}$ . Now we corroborate this by calculating the complex derivative in the Cartesian coordinate directions.

$$\begin{aligned} \frac{d}{dz}z^n &= \frac{\partial}{\partial x}(x + iy)^n \\ &= n(x + iy)^{n-1} \\ &= nz^{n-1} \end{aligned}$$

$$\begin{aligned} \frac{d}{dz}z^n &= -i \frac{\partial}{\partial y}(x + iy)^n \\ &= -in(x + iy)^{n-1} \\ &= nz^{n-1} \end{aligned}$$

**Complex Derivatives are Not the Same as Partial Derivatives** Recall from calculus that

$$f(x, y) = g(s, t) \quad \rightarrow \quad \frac{\partial f}{\partial x} = \frac{\partial g}{\partial s} \frac{\partial s}{\partial x} + \frac{\partial g}{\partial t} \frac{\partial t}{\partial x}$$

Do not make the mistake of using a similar formula for functions of a complex variable. If  $f(z) = \phi(x, y)$  then

$$\frac{df}{dz} \neq \frac{\partial \phi}{\partial x} \frac{\partial x}{\partial z} + \frac{\partial \phi}{\partial y} \frac{\partial y}{\partial z}.$$

This is because the  $\frac{d}{dz}$  operator means “The derivative in any direction in the complex plane.” Since  $f(z)$  is analytic,  $f'(z)$  is the same no matter in which direction we take the derivative.

**Rules of Differentiation.** For an analytic function defined in terms of  $z$  we can calculate the complex derivative using all the usual rules of differentiation that we know from calculus like the product rule,

$$\frac{d}{dz} f(z)g(z) = f'(z)g(z) + f(z)g'(z),$$

or the chain rule,

$$\frac{d}{dz} f(g(z)) = f'(g(z))g'(z).$$

This is because the complex derivative derives its properties from properties of limits, just like its real variable counterpart.

**Result 8.1.1** The complex derivative is,

$$\frac{d}{dz}f(z) = \lim_{\Delta z \rightarrow 0} \frac{f(z + \Delta z) - f(z)}{\Delta z}.$$

The complex derivative is defined if the limit exists and is independent of the manner in which  $\Delta z \rightarrow 0$ . A function is analytic at a point if the complex derivative exists in a neighborhood of that point.

Let  $z = \zeta(\xi, \psi)$  define coordinates in the complex plane. The complex derivative in the coordinate directions is

$$\frac{d}{dz} = \left(\frac{\partial \zeta}{\partial \xi}\right)^{-1} \frac{\partial}{\partial \xi} = \left(\frac{\partial \zeta}{\partial \psi}\right)^{-1} \frac{\partial}{\partial \psi}.$$

In Cartesian coordinates, this is

$$\frac{d}{dz} = \frac{\partial}{\partial x} = -i \frac{\partial}{\partial y}.$$

In polar coordinates, this is

$$\frac{d}{dz} = e^{-i\theta} \frac{\partial}{\partial r} = -\frac{i}{r} e^{-i\theta} \frac{\partial}{\partial \theta}$$

Since the complex derivative is defined with the same limit formula as real derivatives, all the rules from the calculus of functions of a real variable may be used to differentiate functions of a complex variable.

**Example 8.1.5** We have shown that  $z^n$ ,  $n \in \mathbb{Z}^+$ , is an entire function. Now we corroborate that  $\frac{d}{dz}z^n = nz^{n-1}$  by

calculating the complex derivative in the polar coordinate directions.

$$\begin{aligned}\frac{d}{dz}z^n &= e^{-i\theta} \frac{\partial}{\partial r} r^n e^{in\theta} \\ &= e^{-i\theta} nr^{n-1} e^{in\theta} \\ &= nr^{n-1} e^{i(n-1)\theta} \\ &= nz^{n-1}\end{aligned}$$

$$\begin{aligned}\frac{d}{dz}z^n &= -\frac{i}{r} e^{-i\theta} \frac{\partial}{\partial \theta} r^n e^{in\theta} \\ &= -\frac{i}{r} e^{-i\theta} r^n in e^{in\theta} \\ &= nr^{n-1} e^{i(n-1)\theta} \\ &= nz^{n-1}\end{aligned}$$

**Analytic Functions can be Written in Terms of  $z$ .** Consider an analytic function expressed in terms of  $x$  and  $y$ ,  $\phi(x, y)$ . We can write  $\phi$  as a function of  $z = x + iy$  and  $\bar{z} = x - iy$ .

$$f(z, \bar{z}) = \phi\left(\frac{z + \bar{z}}{2}, \frac{z - \bar{z}}{i2}\right)$$

We treat  $z$  and  $\bar{z}$  as independent variables. We find the partial derivatives with respect to these variables.

$$\begin{aligned}\frac{\partial}{\partial z} &= \frac{\partial x}{\partial z} \frac{\partial}{\partial x} + \frac{\partial y}{\partial z} \frac{\partial}{\partial y} = \frac{1}{2} \left( \frac{\partial}{\partial x} - i \frac{\partial}{\partial y} \right) \\ \frac{\partial}{\partial \bar{z}} &= \frac{\partial x}{\partial \bar{z}} \frac{\partial}{\partial x} + \frac{\partial y}{\partial \bar{z}} \frac{\partial}{\partial y} = \frac{1}{2} \left( \frac{\partial}{\partial x} + i \frac{\partial}{\partial y} \right)\end{aligned}$$

Since  $\phi$  is analytic, the complex derivatives in the  $x$  and  $y$  directions are equal.

$$\frac{\partial \phi}{\partial x} = -i \frac{\partial \phi}{\partial y}$$

The partial derivative of  $f(z, \bar{z})$  with respect to  $\bar{z}$  is zero.

$$\frac{\partial f}{\partial \bar{z}} = \frac{1}{2} \left( \frac{\partial \phi}{\partial x} + i \frac{\partial \phi}{\partial y} \right) = 0$$

Thus  $f(z, \bar{z})$  has no functional dependence on  $\bar{z}$ , it can be written as a function of  $z$  alone.

If we were considering an analytic function expressed in polar coordinates  $\phi(r, \theta)$ , then we could write it in Cartesian coordinates with the substitutions:

$$r = \sqrt{x^2 + y^2}, \quad \theta = \arctan(x, y).$$

Thus we could write  $\phi(r, \theta)$  as a function of  $z$  alone.

**Result 8.1.2** Any analytic function  $\phi(x, y)$  or  $\phi(r, \theta)$  can be written as a function of  $z$  alone.

## 8.2 Cauchy-Riemann Equations

If we know that a function is analytic, then we have a convenient way of determining its complex derivative. We just express the complex derivative in terms of the derivative in a coordinate direction. However, we don't have a nice way of determining if a function is analytic. The definition of complex derivative in terms of a limit is cumbersome to work with. In this section we remedy this problem.

**A necessary condition for analyticity.** Consider a function  $f(z) = \phi(x, y)$ . If  $f(z)$  is analytic, the complex derivative is equal to the derivatives in the coordinate directions. We equate the derivatives in the  $x$  and  $y$  directions to obtain the *Cauchy-Riemann equations* in Cartesian coordinates.

$$\phi_x = -i\phi_y \tag{8.1}$$

This equation is a necessary condition for the analyticity of  $f(z)$ .

Let  $\phi(x, y) = u(x, y) + v(x, y)$  where  $u$  and  $v$  are real-valued functions. We equate the real and imaginary parts of Equation 8.1 to obtain another form for the Cauchy-Riemann equations in Cartesian coordinates.

$$u_x = v_y, \quad u_y = -v_x.$$

Note that this is a necessary and not a sufficient condition for analyticity of  $f(z)$ . That is,  $u$  and  $v$  may satisfy the Cauchy-Riemann equations but  $f(z)$  may not be analytic. At this point, Cauchy-Riemann equations give us an easy test for determining if a function is not analytic.

**Example 8.2.1** In Example 8.1.2 we showed that  $\bar{z}$  is not analytic using the definition of complex differentiation. Now we obtain the same result using the Cauchy-Riemann equations.

$$\begin{aligned}\bar{z} &= x - iy \\ u_x &= 1, \quad v_y = -1\end{aligned}$$

We see that the first Cauchy-Riemann equation is not satisfied; the function is not analytic at any point.

**A sufficient condition for analyticity.** A sufficient condition for  $f(z) = \phi(x, y)$  to be analytic at a point  $z_0 = (x_0, y_0)$  is that the partial derivatives of  $\phi(x, y)$  exist and are continuous in some neighborhood of  $z_0$  and satisfy the Cauchy-Riemann equations there. If the partial derivatives of  $\phi$  exist and are continuous then

$$\phi(x + \Delta x, y + \Delta y) = \phi(x, y) + \Delta x \phi_x(x, y) + \Delta y \phi_y(x, y) + o(\Delta x) + o(\Delta y).$$

Here the notation  $o(\Delta x)$  means “terms smaller than  $\Delta x$ ”. We calculate the derivative of  $f(z)$ .

$$\begin{aligned}f'(z) &= \lim_{\Delta z \rightarrow 0} \frac{f(z + \Delta z) - f(z)}{\Delta z} \\ &= \lim_{\Delta x, \Delta y \rightarrow 0} \frac{\phi(x + \Delta x, y + \Delta y) - \phi(x, y)}{\Delta x + i\Delta y} \\ &= \lim_{\Delta x, \Delta y \rightarrow 0} \frac{\phi(x, y) + \Delta x \phi_x(x, y) + \Delta y \phi_y(x, y) + o(\Delta x) + o(\Delta y) - \phi(x, y)}{\Delta x + i\Delta y} \\ &= \lim_{\Delta x, \Delta y \rightarrow 0} \frac{\Delta x \phi_x(x, y) + \Delta y \phi_y(x, y) + o(\Delta x) + o(\Delta y)}{\Delta x + i\Delta y}\end{aligned}$$



Here we use the Cauchy-Riemann equations.

$$\begin{aligned} &= \lim_{\Delta x, \Delta y \rightarrow 0} \frac{(\Delta x + i\Delta y)\phi_x(x, y)}{\Delta x + i\Delta y} + \lim_{\Delta x, \Delta y \rightarrow 0} \frac{o(\Delta x) + o(\Delta y)}{\Delta x + i\Delta y} \\ &= \phi_x(x, y) \end{aligned}$$

Thus we see that the derivative is well defined.

**Cauchy-Riemann Equations in General Coordinates** Let  $z = \zeta(\xi, \psi)$  be a system of coordinates in the complex plane. Let  $\phi(\xi, \psi)$  be a function which we write in terms of these coordinates, A necessary condition for analyticity of  $\phi(\xi, \psi)$  is that the complex derivatives in the coordinate directions exist and are equal. Equating the derivatives in the  $\xi$  and  $\psi$  directions gives us the *Cauchy-Riemann equations*.

$$\left(\frac{\partial \zeta}{\partial \xi}\right)^{-1} \frac{\partial \phi}{\partial \xi} = \left(\frac{\partial \zeta}{\partial \psi}\right)^{-1} \frac{\partial \phi}{\partial \psi}$$

We could separate this into two equations by equating the real and imaginary parts or the modulus and argument.

**Result 8.2.1** A necessary condition for analyticity of  $\phi(\xi, \psi)$ , where  $z = \zeta(\xi, \psi)$ , at  $z = z_0$  is that the Cauchy-Riemann equations are satisfied in a neighborhood of  $z = z_0$ .

$$\left(\frac{\partial \zeta}{\partial \xi}\right)^{-1} \frac{\partial \phi}{\partial \xi} = \left(\frac{\partial \zeta}{\partial \psi}\right)^{-1} \frac{\partial \phi}{\partial \psi}.$$

(We could equate the real and imaginary parts or the modulus and argument of this to obtain two equations.) A sufficient condition for analyticity of  $f(z)$  is that the Cauchy-Riemann equations hold and the first partial derivatives of  $\phi$  exist and are continuous in a neighborhood of  $z = z_0$ .

Below are the Cauchy-Riemann equations for various forms of  $f(z)$ .

$$\begin{aligned} f(z) &= \phi(x, y), & \phi_x &= -i\phi_y \\ f(z) &= u(x, y) + w(x, y), & u_x &= v_y, \quad u_y = -v_x \\ f(z) &= \phi(r, \theta), & \phi_r &= -\frac{i}{r}\phi_\theta \\ f(z) &= u(r, \theta) + w(r, \theta), & u_r &= \frac{1}{r}v_\theta, \quad u_\theta = -rv_r \\ f(z) &= R(r, \theta) e^{i\Theta(r, \theta)}, & R_r &= \frac{R}{r}\Theta_\theta, \quad \frac{1}{r}R_\theta = -R\Theta_r \\ f(z) &= R(x, y) e^{i\Theta(x, y)}, & R_x &= R\Theta_y, \quad R_y = -R\Theta_x \end{aligned}$$

**Example 8.2.2** Consider the Cauchy-Riemann equations for  $f(z) = u(r, \theta) + w(r, \theta)$ . From Exercise 8.3 we know that the complex derivative in the polar coordinate directions is

$$\frac{d}{dz} = e^{-i\theta} \frac{\partial}{\partial r} = -\frac{i}{r} e^{-i\theta} \frac{\partial}{\partial \theta}.$$

From Result 8.2.1 we have the equation,

$$e^{-i\theta} \frac{\partial}{\partial r}[u + iv] = -\frac{i}{r} e^{-i\theta} \frac{\partial}{\partial \theta}[u + iv].$$

We multiply by  $e^{i\theta}$  and equate the real and imaginary components to obtain the Cauchy-Riemann equations.

$$u_r = \frac{1}{r}v_\theta, \quad u_\theta = -rv_r$$

**Example 8.2.3** Consider the exponential function.

$$e^z = \phi(x, y) = e^x(\cos y + i \sin(y))$$

We use the Cauchy-Riemann equations to show that the function is entire.

$$\begin{aligned}\phi_x &= -i\phi_y \\ e^x(\cos y + i \sin(y)) &= -i e^x(-\sin y + i \cos(y)) \\ e^x(\cos y + i \sin(y)) &= e^x(\cos y + i \sin(y))\end{aligned}$$

Since the function satisfies the Cauchy-Riemann equations and the first partial derivatives are continuous everywhere in the finite complex plane, the exponential function is entire.

Now we find the value of the complex derivative.

$$\frac{d}{dz} e^z = \frac{\partial \phi}{\partial x} = e^x(\cos y + i \sin(y)) = e^z$$

The differentiability of the exponential function implies the differentiability of the trigonometric functions, as they can be written in terms of the exponential.

In Exercise 8.13 you can show that the logarithm  $\log z$  is differentiable for  $z \neq 0$ . This implies the differentiability of  $z^\alpha$  and the inverse trigonometric functions as they can be written in terms of the logarithm.

**Example 8.2.4** We compute the derivative of  $z^z$ .

$$\begin{aligned}\frac{d}{dz}(z^z) &= \frac{d}{dz} e^{z \log z} \\ &= (1 + \log z) e^{z \log z} \\ &= (1 + \log z) z^z \\ &= z^z + z^z \log z\end{aligned}$$

## 8.3 Harmonic Functions

A function  $u$  is harmonic if its second partial derivatives exist, are continuous and satisfy Laplace's equation  $\Delta u = 0$ .<sup>2</sup> (In Cartesian coordinates the Laplacian is  $\Delta u \equiv u_{xx} + u_{yy}$ .) If  $f(z) = u + v$  is an analytic function then  $u$  and  $v$  are harmonic functions. To see why this is so, we start with the Cauchy-Riemann equations.

$$u_x = v_y, \quad u_y = -v_x$$

We differentiate the first equation with respect to  $x$  and the second with respect to  $y$ . (We assume that  $u$  and  $v$  are twice continuously differentiable. We will see later that they are infinitely differentiable.)

$$u_{xx} = v_{xy}, \quad u_{yy} = -v_{yx}$$

Thus we see that  $u$  is harmonic.

$$\Delta u \equiv u_{xx} + u_{yy} = v_{xy} - v_{yx} = 0$$

One can use the same method to show that  $\Delta v = 0$ .

If  $u$  is harmonic on some simply-connected domain, then there exists a harmonic function  $v$  such that  $f(z) = u + v$  is analytic in the domain.  $v$  is called the *harmonic conjugate* of  $u$ . The harmonic conjugate is unique up to an additive

---

<sup>2</sup> The capital Greek letter  $\Delta$  is used to denote the Laplacian, like  $\Delta u(x, y)$ , and differentials, like  $\Delta x$ .

constant. To demonstrate this, let  $w$  be another harmonic conjugate of  $u$ . Both the pair  $u$  and  $v$  and the pair  $u$  and  $w$  satisfy the Cauchy-Riemann equations.

$$u_x = v_y, \quad u_y = -v_x, \quad u_x = w_y, \quad u_y = -w_x$$

We take the difference of these equations.

$$v_x - w_x = 0, \quad v_y - w_y = 0$$

On a simply connected domain, the difference between  $v$  and  $w$  is thus a constant.

To prove the existence of the harmonic conjugate, we first write  $v$  as an integral.

$$v(x, y) = v(x_0, y_0) + \int_{(x_0, y_0)}^{(x, y)} v_x dx + v_y dy$$

On a simply connected domain, the integral is path independent and defines a unique  $v$  in terms of  $v_x$  and  $v_y$ . We use the Cauchy-Riemann equations to write  $v$  in terms of  $u_x$  and  $u_y$ .

$$v(x, y) = v(x_0, y_0) + \int_{(x_0, y_0)}^{(x, y)} -u_y dx + u_x dy$$

Changing the starting point  $(x_0, y_0)$  changes  $v$  by an additive constant. The harmonic conjugate of  $u$  to within an additive constant is

$$v(x, y) = \int -u_y dx + u_x dy.$$

This proves the existence<sup>3</sup> of the harmonic conjugate. This is not the formula one would use to construct the harmonic conjugate of a  $u$ . One accomplishes this by solving the Cauchy-Riemann equations.

---

<sup>3</sup> A mathematician returns to his office to find that a cigarette tossed in the trash has started a small fire. Being calm and a quick thinker he notes that there is a fire extinguisher by the window. He then closes the door and walks away because “the solution exists.”

**Result 8.3.1** If  $f(z) = u + iv$  is an analytic function then  $u$  and  $v$  are harmonic functions. That is, the Laplacians of  $u$  and  $v$  vanish  $\Delta u = \Delta v = 0$ . The Laplacian in Cartesian and polar coordinates is

$$\Delta = \frac{\partial^2}{\partial x^2} + \frac{\partial^2}{\partial y^2}, \quad \Delta = \frac{1}{r} \frac{\partial}{\partial r} \left( r \frac{\partial}{\partial r} \right) + \frac{1}{r^2} \frac{\partial^2}{\partial \theta^2}.$$

Given a harmonic function  $u$  in a simply connected domain, there exists a harmonic function  $v$ , (unique up to an additive constant), such that  $f(z) = u + iv$  is analytic in the domain. One can construct  $v$  by solving the Cauchy-Riemann equations.

**Example 8.3.1** Is  $x^2$  the real part of an analytic function?

The Laplacian of  $x^2$  is

$$\Delta[x^2] = 2 + 0$$

$x^2$  is not harmonic and thus is not the real part of an analytic function.

**Example 8.3.2** Show that  $u = e^{-x}(x \sin y - y \cos y)$  is harmonic.

$$\begin{aligned} \frac{\partial u}{\partial x} &= e^{-x} \sin y - e^x(x \sin y - y \cos y) \\ &= e^{-x} \sin y - x e^{-x} \sin y + y e^{-x} \cos y \end{aligned}$$

$$\begin{aligned} \frac{\partial^2 u}{\partial x^2} &= -e^{-x} \sin y - e^{-x} \sin y + x e^{-x} \sin y - y e^{-x} \cos y \\ &= -2e^{-x} \sin y + x e^{-x} \sin y - y e^{-x} \cos y \end{aligned}$$

$$\frac{\partial u}{\partial y} = e^{-x}(x \cos y - \cos y + y \sin y)$$

$$\begin{aligned}\frac{\partial^2 u}{\partial y^2} &= e^{-x}(-x \sin y + \sin y + y \cos y + \sin y) \\ &= -x e^{-x} \sin y + 2 e^{-x} \sin y + y e^{-x} \cos y\end{aligned}$$

Thus we see that  $\frac{\partial^2 u}{\partial x^2} + \frac{\partial^2 u}{\partial y^2} = 0$  and  $u$  is harmonic.

**Example 8.3.3** Consider  $u = \cos x \cosh y$ . This function is harmonic.

$$u_{xx} + u_{yy} = -\cos x \cosh y + \cos x \cosh y = 0$$

Thus it is the real part of an analytic function,  $f(z)$ . We find the harmonic conjugate,  $v$ , with the Cauchy-Riemann equations. We integrate the first Cauchy-Riemann equation.

$$\begin{aligned}v_y &= u_x = -\sin x \cosh y \\ v &= -\sin x \sinh y + a(x)\end{aligned}$$

Here  $a(x)$  is a constant of integration. We substitute this into the second Cauchy-Riemann equation to determine  $a(x)$ .

$$\begin{aligned}v_x &= -u_y \\ -\cos x \sinh y + a'(x) &= -\cos x \sinh y \\ a'(x) &= 0 \\ a(x) &= c\end{aligned}$$

Here  $c$  is a real constant. Thus the harmonic conjugate is

$$v = -\sin x \sinh y + c.$$

The analytic function is

$$f(z) = \cos x \cosh y - i \sin x \sinh y + ic$$

We recognize this as

$$f(z) = \cos z + ic.$$

**Example 8.3.4** Here we consider an example that demonstrates the need for a simply connected domain. Consider  $u = \text{Log } r$  in the multiply connected domain,  $r > 0$ .  $u$  is harmonic.

$$\Delta \text{Log } r = \frac{1}{r} \frac{\partial}{\partial r} \left( r \frac{\partial}{\partial r} \text{Log } r \right) + \frac{1}{r^2} \frac{\partial^2}{\partial \theta^2} \text{Log } r = 0$$

We solve the Cauchy-Riemann equations to try to find the harmonic conjugate.

$$\begin{aligned} u_r &= \frac{1}{r} v_\theta, & u_\theta &= -r v_r \\ v_r &= 0, & v_\theta &= 1 \\ v &= \theta + c \end{aligned}$$

We are able to solve for  $v$ , but it is multi-valued. Any single-valued branch of  $\theta$  that we choose will not be continuous on the domain. Thus there is no harmonic conjugate of  $u = \text{Log } r$  for the domain  $r > 0$ .

If we had instead considered the simply-connected domain  $r > 0$ ,  $|\arg(z)| < \pi$  then the harmonic conjugate would be  $v = \text{Arg}(z) + c$ . The corresponding analytic function is  $f(z) = \text{Log } z + ic$ .

**Example 8.3.5** Consider  $u = x^3 - 3xy^2 + x$ . This function is harmonic.

$$u_{xx} + u_{yy} = 6x - 6x = 0$$

Thus it is the real part of an analytic function,  $f(z)$ . We find the harmonic conjugate,  $v$ , with the Cauchy-Riemann equations. We integrate the first Cauchy-Riemann equation.

$$\begin{aligned} v_y &= u_x = 3x^2 - 3y^2 + 1 \\ v &= 3x^2y - y^3 + y + a(x) \end{aligned}$$

Here  $a(x)$  is a constant of integration. We substitute this into the second Cauchy-Riemann equation to determine  $a(x)$ .

$$\begin{aligned} v_x &= -u_y \\ 6xy + a'(x) &= 6xy \\ a'(x) &= 0 \\ a(x) &= c \end{aligned}$$



Here  $c$  is a real constant. The harmonic conjugate is

$$v = 3x^2y - y^3 + y + c.$$

The analytic function is

$$f(z) = x^3 - 3xy^2 + x + i(3x^2y - y^3 + y) + ic$$

$$f(z) = x^3 + i3x^2y - 3xy^2 - iy^2 + x + iy + ic$$

$$f(z) = z^3 + z + ic$$

## 8.4 Singularities

Any point at which a function is not analytic is called a *singularity*. In this section we will classify the different flavors of singularities.

**Result 8.4.1 Singularities.** If a function is not analytic at a point, then that point is a *singular point* or a *singularity* of the function.

### 8.4.1 Categorization of Singularities

**Branch Points.** If  $f(z)$  has a branch point at  $z_0$ , then we cannot define a branch of  $f(z)$  that is continuous in a neighborhood of  $z_0$ . Continuity is necessary for analyticity. Thus all branch points are singularities. Since functions are discontinuous across branch cuts, all points on a branch cut are singularities.

**Example 8.4.1** Consider  $f(z) = z^{3/2}$ . The origin and infinity are branch points and are thus singularities of  $f(z)$ . We choose the branch  $g(z) = \sqrt{z^3}$ . All the points on the negative real axis, including the origin, are singularities of  $g(z)$ .

**Removable Singularities.**

**Example 8.4.2** Consider

$$f(z) = \frac{\sin z}{z}.$$

This function is undefined at  $z = 0$  because  $f(0)$  is the indeterminate form  $0/0$ .  $f(z)$  is analytic everywhere in the finite complex plane except  $z = 0$ . Note that the limit as  $z \rightarrow 0$  of  $f(z)$  exists.

$$\lim_{z \rightarrow 0} \frac{\sin z}{z} = \lim_{z \rightarrow 0} \frac{\cos z}{1} = 1$$

If we were to fill in the hole in the definition of  $f(z)$ , we could make it differentiable at  $z = 0$ . Consider the function

$$g(z) = \begin{cases} \frac{\sin z}{z} & z \neq 0, \\ 1 & z = 0. \end{cases}$$

We calculate the derivative at  $z = 0$  to verify that  $g(z)$  is analytic there.

$$\begin{aligned} f'(0) &= \lim_{z \rightarrow 0} \frac{f(0) - f(z)}{z} \\ &= \lim_{z \rightarrow 0} \frac{1 - \sin(z)/z}{z} \\ &= \lim_{z \rightarrow 0} \frac{z - \sin(z)}{z^2} \\ &= \lim_{z \rightarrow 0} \frac{1 - \cos(z)}{2z} \\ &= \lim_{z \rightarrow 0} \frac{\sin(z)}{2} \\ &= 0 \end{aligned}$$

We call the point at  $z = 0$  a removable singularity of  $\sin(z)/z$  because we can remove the singularity by defining the value of the function to be its limiting value there.

Consider a function  $f(z)$  that is analytic in a deleted neighborhood of  $z = z_0$ . If  $f(z)$  is not analytic at  $z_0$ , but  $\lim_{z \rightarrow z_0} f(z)$  exists, then the function has a removable singularity at  $z_0$ . The function

$$g(z) = \begin{cases} f(z) & z \neq z_0 \\ \lim_{z \rightarrow z_0} f(z) & z = z_0 \end{cases}$$

is analytic in a neighborhood of  $z = z_0$ . We show this by calculating  $g'(z_0)$ .

$$\begin{aligned} g'(z_0) &= \lim_{z \rightarrow z_0} \frac{g(z_0) - g(z)}{z_0 - z} \\ &= \lim_{z \rightarrow z_0} \frac{-g'(z)}{-1} \\ &= \lim_{z \rightarrow z_0} f'(z) \end{aligned}$$

This limit exists because  $f(z)$  is analytic in a deleted neighborhood of  $z = z_0$ .

**Poles.** If a function  $f(z)$  behaves like  $c/(z - z_0)^n$  near  $z = z_0$  then the function has an  $n^{\text{th}}$  order pole at that point. More mathematically we say

$$\lim_{z \rightarrow z_0} (z - z_0)^n f(z) = c \neq 0.$$

We require the constant  $c$  to be nonzero so we know that it is not a pole of lower order. We can denote a removable singularity as a pole of order zero.

Another way to say that a function has an  $n^{\text{th}}$  order pole is that  $f(z)$  is not analytic at  $z = z_0$ , but  $(z - z_0)^n f(z)$  is either analytic or has a removable singularity at that point.

**Example 8.4.3**  $1/\sin(z^2)$  has a second order pole at  $z = 0$  and first order poles at  $z = (n\pi)^{1/2}$ ,  $n \in \mathbb{Z}^\pm$ .

$$\begin{aligned} \lim_{z \rightarrow 0} \frac{z^2}{\sin(z^2)} &= \lim_{z \rightarrow 0} \frac{2z}{2z \cos(z^2)} \\ &= \lim_{z \rightarrow 0} \frac{2}{2 \cos(z^2) - 4z^2 \sin(z^2)} \\ &= 1 \end{aligned}$$

$$\begin{aligned} \lim_{z \rightarrow (n\pi)^{1/2}} \frac{z - (n\pi)^{1/2}}{\sin(z^2)} &= \lim_{z \rightarrow (n\pi)^{1/2}} \frac{1}{2z \cos(z^2)} \\ &= \frac{1}{2(n\pi)^{1/2}(-1)^n} \end{aligned}$$

**Example 8.4.4**  $e^{1/z}$  is singular at  $z = 0$ . The function is not analytic as  $\lim_{z \rightarrow 0} e^{1/z}$  does not exist. We check if the function has a pole of order  $n$  at  $z = 0$ .

$$\begin{aligned} \lim_{z \rightarrow 0} z^n e^{1/z} &= \lim_{\zeta \rightarrow \infty} \frac{e^\zeta}{\zeta^n} \\ &= \lim_{\zeta \rightarrow \infty} \frac{e^\zeta}{n!} \end{aligned}$$

Since the limit does not exist for any value of  $n$ , the singularity is not a pole. We could say that  $e^{1/z}$  is more singular than any power of  $1/z$ .

**Essential Singularities.** If a function  $f(z)$  is singular at  $z = z_0$ , but the singularity is not a branch point, or a pole, the the point is an *essential singularity* of the function.

**The point at infinity.** We can consider the point at infinity  $z \rightarrow \infty$  by making the change of variables  $z = 1/\zeta$  and considering  $\zeta \rightarrow 0$ . If  $f(1/\zeta)$  is analytic at  $\zeta = 0$  then  $f(z)$  is analytic at infinity. We have encountered branch points at infinity before (Section 7.9). Assume that  $f(z)$  is not analytic at infinity. If  $\lim_{z \rightarrow \infty} f(z)$  exists then  $f(z)$  has a removable singularity at infinity. If  $\lim_{z \rightarrow \infty} f(z)/z^n = c \neq 0$  then  $f(z)$  has an  $n^{\text{th}}$  order pole at infinity.

**Result 8.4.2 Categorization of Singularities.** Consider a function  $f(z)$  that has a singularity at the point  $z = z_0$ . Singularities come in four flavors:

**Branch Points.** Branch points of multi-valued functions are singularities.

**Removable Singularities.** If  $\lim_{z \rightarrow z_0} f(z)$  exists, then  $z_0$  is a removable singularity. It is thus named because the singularity could be removed and thus the function made analytic at  $z_0$  by redefining the value of  $f(z_0)$ .

**Poles.** If  $\lim_{z \rightarrow z_0} (z - z_0)^n f(z) = \text{const} \neq 0$  then  $f(z)$  has an  $n^{\text{th}}$  order pole at  $z_0$ .

**Essential Singularities.** Instead of defining what an essential singularity is, we say what it is not. If  $z_0$  neither a branch point, a removable singularity nor a pole, it is an essential singularity.

A pole may be called a non-essential singularity. This is because multiplying the function by an integral power of  $z - z_0$  will make the function analytic. Then an essential singularity is a point  $z_0$  such that there does not exist an  $n$  such that  $(z - z_0)^n f(z)$  is analytic there.

## 8.4.2 Isolated and Non-Isolated Singularities

**Result 8.4.3 Isolated and Non-Isolated Singularities.** Suppose  $f(z)$  has a singularity at  $z_0$ . If there exists a deleted neighborhood of  $z_0$  containing no singularities then the point is an **isolated singularity**. Otherwise it is a **non-isolated singularity**.

If you don't like the abstract notion of a deleted neighborhood, you can work with a deleted circular neighborhood. However, this will require the introduction of more math symbols and a Greek letter.  $z = z_0$  is an isolated singularity if there exists a  $\delta > 0$  such that there are no singularities in  $0 < |z - z_0| < \delta$ .

**Example 8.4.5** We classify the singularities of  $f(z) = z/\sin z$ .

$z$  has a simple zero at  $z = 0$ .  $\sin z$  has simple zeros at  $z = n\pi$ . Thus  $f(z)$  has a removable singularity at  $z = 0$  and has first order poles at  $z = n\pi$  for  $n \in \mathbb{Z}^\pm$ . We can corroborate this by taking limits.

$$\lim_{z \rightarrow 0} f(z) = \lim_{z \rightarrow 0} \frac{z}{\sin z} = \lim_{z \rightarrow 0} \frac{1}{\cos z} = 1$$

$$\begin{aligned} \lim_{z \rightarrow n\pi} (z - n\pi)f(z) &= \lim_{z \rightarrow n\pi} \frac{(z - n\pi)z}{\sin z} \\ &= \lim_{z \rightarrow n\pi} \frac{2z - n\pi}{\cos z} \\ &= \frac{n\pi}{(-1)^n} \\ &\neq 0 \end{aligned}$$

Now to examine the behavior at infinity. There is no neighborhood of infinity that does not contain first order poles of  $f(z)$ . (Another way of saying this is that there does not exist an  $R$  such that there are no singularities in  $R < |z| < \infty$ .) Thus  $z = \infty$  is a non-isolated singularity.

We could also determine this by setting  $\zeta = 1/z$  and examining the point  $\zeta = 0$ .  $f(1/\zeta)$  has first order poles at  $\zeta = 1/(n\pi)$  for  $n \in \mathbb{Z} \setminus \{0\}$ . These first order poles come arbitrarily close to the point  $\zeta = 0$ . There is no deleted neighborhood of  $\zeta = 0$  which does not contain singularities. Thus  $\zeta = 0$ , and hence  $z = \infty$  is a non-isolated singularity.

The point at infinity is an essential singularity. It is certainly not a branch point or a removable singularity. It is not a pole, because there is no  $n$  such that  $\lim_{z \rightarrow \infty} z^{-n}f(z) = \text{const} \neq 0$ .  $z^{-n}f(z)$  has first order poles in any neighborhood of infinity, so this limit does not exist.

## 8.5 Application: Potential Flow

**Example 8.5.1** We consider 2 dimensional uniform flow in a given direction. The flow corresponds to the complex potential

$$\Phi(z) = v_0 e^{-i\theta_0} z,$$

where  $v_0$  is the fluid speed and  $\theta_0$  is the direction. We find the velocity potential  $\phi$  and stream function  $\psi$ .

$$\Phi(z) = \phi + i\psi$$

$$\phi = v_0(\cos(\theta_0)x + \sin(\theta_0)y), \quad \psi = v_0(-\sin(\theta_0)x + \cos(\theta_0)y)$$

These are plotted in Figure 8.1 for  $\theta_0 = \pi/6$ .

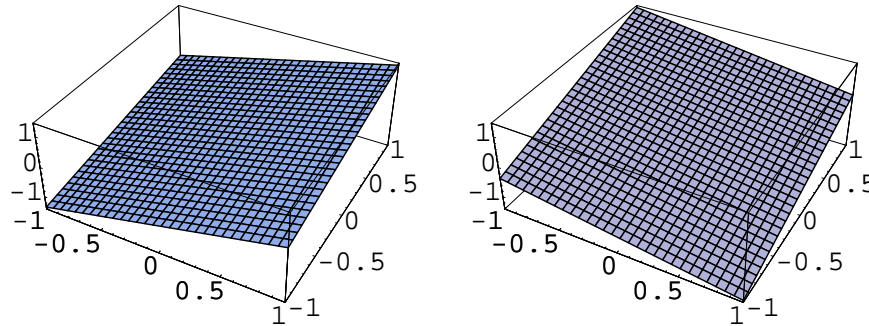

Figure 8.1: The velocity potential  $\phi$  and stream function  $\psi$  for  $\Phi(z) = v_0 e^{-i\theta_0} z$ .

Next we find the stream lines,  $\psi = c$ .

$$\begin{aligned} v_0(-\sin(\theta_0)x + \cos(\theta_0)y) &= c \\ y &= \frac{c}{v_0 \cos(\theta_0)} + \tan(\theta_0)x \end{aligned}$$

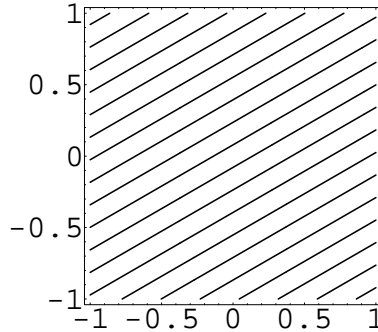

Figure 8.2: Streamlines for  $\psi = v_0(-\sin(\theta_0)x + \cos(\theta_0)y)$ .

Figure 8.2 shows how the streamlines go straight along the  $\theta_0$  direction. Next we find the velocity field.

$$\begin{aligned}\mathbf{v} &= \nabla\phi \\ \mathbf{v} &= \phi_x\hat{\mathbf{x}} + \phi_y\hat{\mathbf{y}} \\ \mathbf{v} &= v_0\cos(\theta_0)\hat{\mathbf{x}} + v_0\sin(\theta_0)\hat{\mathbf{y}}\end{aligned}$$

The velocity field is shown in Figure 8.3.

**Example 8.5.2** Steady, incompressible, inviscid, irrotational flow is governed by the Laplace equation. We consider flow around an infinite cylinder of radius  $a$ . Because the flow does not vary along the axis of the cylinder, this is a two-dimensional problem. The flow corresponds to the complex potential

$$\Phi(z) = v_0 \left( z + \frac{a^2}{z} \right).$$



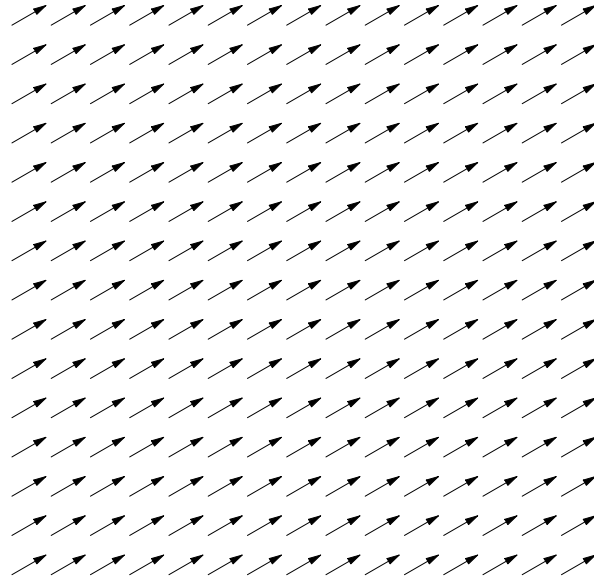

Figure 8.3: Velocity field and velocity direction field for  $\phi = v_0(\cos(\theta_0)x + \sin(\theta_0)y)$ .

*We find the velocity potential  $\phi$  and stream function  $\psi$ .*

$$\Phi(z) = \phi + i\psi$$

$$\phi = v_0 \left( r + \frac{a^2}{r} \right) \cos \theta, \quad \psi = v_0 \left( r - \frac{a^2}{r} \right) \sin \theta$$

*These are plotted in Figure 8.4.*

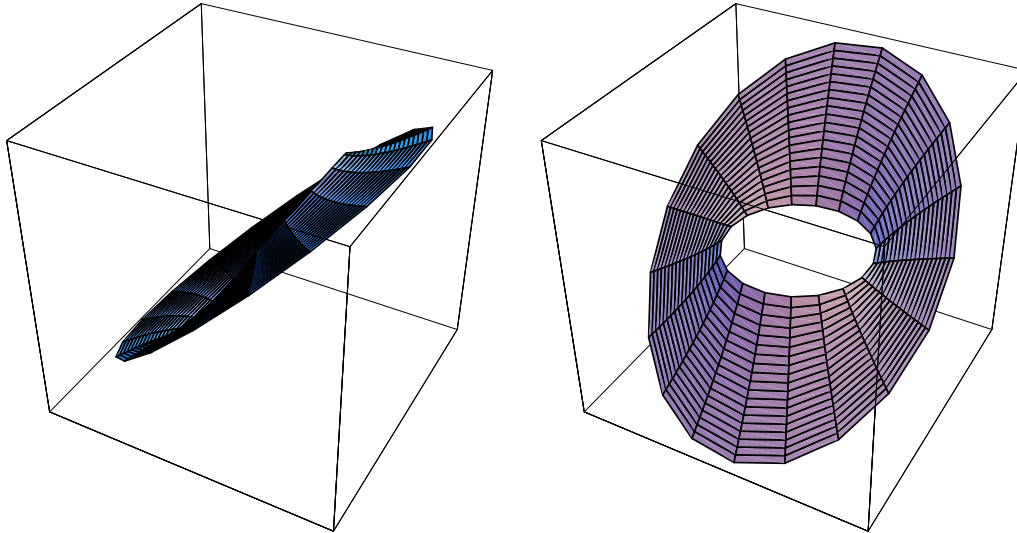

Figure 8.4: The velocity potential  $\phi$  and stream function  $\psi$  for  $\Phi(z) = v_0 \left( z + \frac{a^2}{z} \right)$ .

Next we find the stream lines,  $\psi = c$ .

$$v_0 \left( r - \frac{a^2}{r} \right) \sin \theta = c$$

$$r = \frac{c \pm \sqrt{c^2 + 4v_0 \sin^2 \theta}}{2v_0 \sin \theta}$$

Figure 8.5 shows how the streamlines go around the cylinder. Next we find the velocity field.

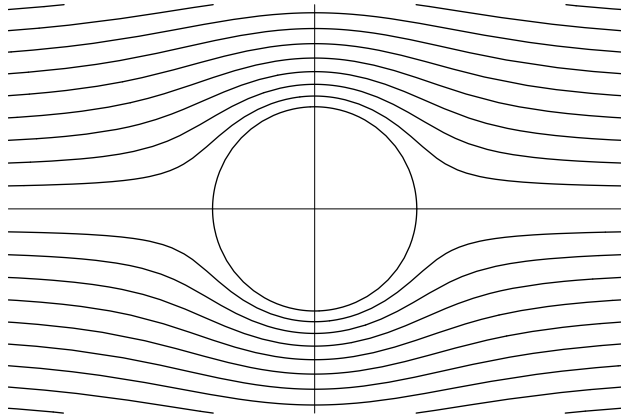

Figure 8.5: Streamlines for  $\psi = v_0 \left( r - \frac{a^2}{r} \right) \sin \theta$ .

$$\begin{aligned} \mathbf{v} &= \nabla \phi \\ \mathbf{v} &= \phi_r \hat{\mathbf{r}} + \frac{\phi_\theta}{r} \hat{\boldsymbol{\theta}} \\ \mathbf{v} &= v_0 \left( 1 - \frac{a^2}{r^2} \right) \cos \theta \hat{\mathbf{r}} - v_0 \left( 1 + \frac{a^2}{r^2} \right) \sin \theta \hat{\boldsymbol{\theta}} \end{aligned}$$

The velocity field is shown in Figure 8.6.

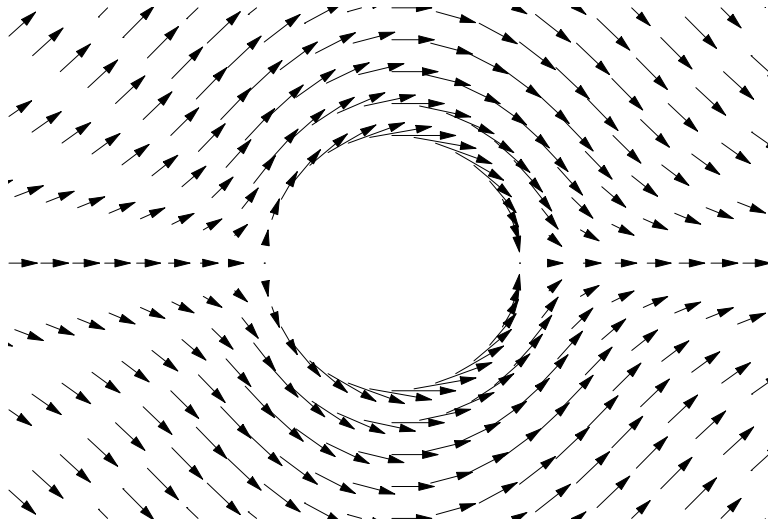

Figure 8.6: Velocity field and velocity direction field for  $\phi = v_0 \left( r + \frac{a^2}{r} \right) \cos \theta$ .

## 8.6 Exercises

### Complex Derivatives

#### Exercise 8.1

Consider two functions  $f(z)$  and  $g(z)$  analytic at  $z_0$  with  $f(z_0) = g(z_0) = 0$  and  $g'(z_0) \neq 0$ .

1. Use the definition of the complex derivative to justify L'Hospital's rule:

$$\lim_{z \rightarrow z_0} \frac{f(z)}{g(z)} = \frac{f'(z_0)}{g'(z_0)}$$

2. Evaluate the limits

$$\lim_{z \rightarrow i} \frac{1 + z^2}{2 + 2z^6}, \quad \lim_{z \rightarrow i\pi} \frac{\sinh(z)}{e^z + 1}$$

Hint, Solution

### Exercise 8.2

Show that if  $f(z)$  is analytic and  $\phi(x, y) = f(z)$  is twice continuously differentiable then  $f'(z)$  is analytic.

Hint, Solution

### Exercise 8.3

Find the complex derivative in the coordinate directions for  $f(z) = \phi(r, \theta)$ .

Hint, Solution

### Exercise 8.4

Show that the following functions are nowhere analytic by checking where the derivative with respect to  $z$  exists.

1.  $\sin x \cosh y - i \cos x \sinh y$
2.  $x^2 - y^2 + x + i(2xy - y)$

Hint, Solution

### Exercise 8.5

$f(z)$  is analytic for all  $z$ , ( $|z| < \infty$ ).  $f(z_1 + z_2) = f(z_1)f(z_2)$  for all  $z_1$  and  $z_2$ . (This is known as a *functional equation*). Prove that  $f(z) = \exp(f'(0)z)$ .

Hint, Solution

## Cauchy-Riemann Equations

### Exercise 8.6

If  $f(z)$  is analytic in a domain and has a constant real part, a constant imaginary part, or a constant modulus, show that  $f(z)$  is constant.

Hint, Solution

### Exercise 8.7

Show that the function

$$f(z) = \begin{cases} e^{-z^{-4}} & \text{for } z \neq 0, \\ 0 & \text{for } z = 0. \end{cases}$$

satisfies the Cauchy-Riemann equations everywhere, including at  $z = 0$ , but  $f(z)$  is not analytic at the origin.

**Hint, Solution**

### Exercise 8.8

Find the Cauchy-Riemann equations for the following forms.

1.  $f(z) = R(r, \theta) e^{i\Theta(r, \theta)}$
2.  $f(z) = R(x, y) e^{i\Theta(x, y)}$

**Hint, Solution**

### Exercise 8.9

1. Show that  $e^{\bar{z}}$  is not analytic.
2.  $f(z)$  is an analytic function of  $z$ . Show that  $\bar{f}(z) = \overline{f(\bar{z})}$  is also an analytic function of  $z$ .

**Hint, Solution**

### Exercise 8.10

1. Determine all points  $z = x + iy$  where the following functions are differentiable with respect to  $z$ :

(a)  $x^3 + y^3$

(b)  $\frac{x-1}{(x-1)^2 + y^2} - i \frac{y}{(x-1)^2 + y^2}$

2. Determine all points  $z$  where these functions are analytic.
3. Determine which of the following functions  $v(x, y)$  are the imaginary part of an analytic function  $u(x, y) + iv(x, y)$ . For those that are, compute the real part  $u(x, y)$  and re-express the answer as an explicit function of  $z = x + iy$ :

(a)  $x^2 - y^2$

(b)  $3x^2y$

Hint, Solution

### Exercise 8.11

Let

$$f(z) = \begin{cases} \frac{x^{4/3}y^{5/3} + iy^{5/3}x^{4/3}}{x^2 + y^2} & \text{for } z \neq 0, \\ 0 & \text{for } z = 0. \end{cases}$$

Show that the Cauchy-Riemann equations hold at  $z = 0$ , but that  $f$  is not differentiable at this point.

Hint, Solution

### Exercise 8.12

Consider the complex function

$$f(z) = u + iv = \begin{cases} \frac{x^3(1+i) - y^3(1-i)}{x^2 + y^2} & \text{for } z \neq 0, \\ 0 & \text{for } z = 0. \end{cases}$$

Show that the partial derivatives of  $u$  and  $v$  with respect to  $x$  and  $y$  exist at  $z = 0$  and that  $u_x = v_y$  and  $u_y = -v_x$  there: the Cauchy-Riemann equations are satisfied at  $z = 0$ . On the other hand, show that

$$\lim_{z \rightarrow 0} \frac{f(z)}{z}$$

does not exist, that is,  $f$  is not complex-differentiable at  $z = 0$ .

Hint, Solution

### Exercise 8.13

Show that the logarithm  $\log z$  is differentiable for  $z \neq 0$ . Find the derivative of the logarithm.

Hint, Solution

**Exercise 8.14**

Show that the Cauchy-Riemann equations for the analytic function  $f(z) = u(r, \theta) + v(r, \theta)$  are

$$u_r = v_\theta/r, \quad u_\theta = -rv_r.$$

**Hint, Solution**

**Exercise 8.15**

$w = u + v$  is an analytic function of  $z$ .  $\phi(x, y)$  is an arbitrary smooth function of  $x$  and  $y$ . When expressed in terms of  $u$  and  $v$ ,  $\phi(x, y) = \Phi(u, v)$ . Show that ( $w' \neq 0$ )

$$\frac{\partial \Phi}{\partial u} - i \frac{\partial \Phi}{\partial v} = \left( \frac{dw}{dz} \right)^{-1} \left( \frac{\partial \phi}{\partial x} - i \frac{\partial \phi}{\partial y} \right).$$

Deduce

$$\frac{\partial^2 \Phi}{\partial u^2} + \frac{\partial^2 \Phi}{\partial v^2} = \left| \frac{dw}{dz} \right|^{-2} \left( \frac{\partial^2 \phi}{\partial x^2} + \frac{\partial^2 \phi}{\partial y^2} \right).$$

**Hint, Solution**

**Exercise 8.16**

Show that the functions defined by  $f(z) = \log|z| + i \arg(z)$  and  $f(z) = \sqrt{|z|} e^{i \arg(z)/2}$  are analytic in the sector  $|z| > 0$ ,  $|\arg(z)| < \pi$ . What are the corresponding derivatives  $df/dz$ ?

**Hint, Solution**

**Exercise 8.17**

Show that the following functions are harmonic. For each one of them find its harmonic conjugate and form the corresponding holomorphic function.

1.  $u(x, y) = x \operatorname{Log}(r) - y \arctan(x, y)$  ( $r \neq 0$ )
2.  $u(x, y) = \arg(z)$  ( $|\arg(z)| < \pi$ ,  $r \neq 0$ )
3.  $u(x, y) = r^n \cos(n\theta)$



4.  $u(x, y) = y/r^2$  ( $r \neq 0$ )

Hint, Solution

### Exercise 8.18

1. Use the Cauchy-Riemann equations to determine where the function

$$f(z) = (x - y)^2 + i2(x + y)$$

is differentiable and where it is analytic.

2. Evaluate the derivative of

$$f(z) = e^{x^2 - y^2}(\cos(2xy) + i \sin(2xy))$$

and describe the domain of analyticity.

Hint, Solution

### Exercise 8.19

Consider the function  $f(z) = u + iv$  with real and imaginary parts expressed in terms of either  $x$  and  $y$  or  $r$  and  $\theta$ .

1. Show that the Cauchy-Riemann equations

$$u_x = v_y, \quad u_y = -v_x$$

are satisfied and these partial derivatives are continuous at a point  $z$  if and only if the polar form of the Cauchy-Riemann equations

$$u_r = \frac{1}{r}v_\theta, \quad \frac{1}{r}u_\theta = -v_r$$

is satisfied and these partial derivatives are continuous there.

2. Show that it is easy to verify that  $\text{Log } z$  is analytic for  $r > 0$  and  $-\pi < \theta < \pi$  using the polar form of the Cauchy-Riemann equations and that the value of the derivative is easily obtained from a polar differentiation formula.

3. Show that in polar coordinates, Laplace's equation becomes

$$\phi_{rr} + \frac{1}{r}\phi_r + \frac{1}{r^2}\phi_{\theta\theta} = 0.$$

**Hint, Solution**

### Exercise 8.20

Determine which of the following functions are the real parts of an analytic function.

1.  $u(x, y) = x^3 - y^3$
2.  $u(x, y) = \sinh x \cos y + x$
3.  $u(r, \theta) = r^n \cos(n\theta)$

and find  $f(z)$  for those that are.

**Hint, Solution**

### Exercise 8.21

Consider steady, incompressible, inviscid, irrotational flow governed by the Laplace equation. Determine the form of the velocity potential and stream function contours for the complex potentials

1.  $\Phi(z) = \phi(x, y) + i\psi(x, y) = \log z + i \log z$
2.  $\Phi(z) = \log(z - 1) + \log(z + 1)$

Plot and describe the features of the flows you are considering.

**Hint, Solution**

### Exercise 8.22

1. Classify all the singularities (removable, poles, isolated essential, branch points, non-isolated essential) of the following functions in the extended complex plane

(a)  $\frac{z}{z^2 + 1}$

(b)  $\frac{1}{\sin z}$

(c)  $\log(1 + z^2)$

(d)  $z \sin(1/z)$

(e)  $\frac{\tan^{-1}(z)}{z \sinh^2(\pi z)}$

2. Construct functions that have the following zeros or singularities:

(a) a simple zero at  $z = i$  and an isolated essential singularity at  $z = 1$ .

(b) a removable singularity at  $z = 3$ , a pole of order 6 at  $z = -i$  and an essential singularity at  $z_\infty$ .

Hint, Solution

## 8.7 Hints

### Complex Derivatives

#### Hint 8.1

#### Hint 8.2

Start with the Cauchy-Riemann equation and then differentiate with respect to  $x$ .

#### Hint 8.3

Read Example 8.1.3 and use Result 8.1.1.

#### Hint 8.4

Use Result 8.1.1.

#### Hint 8.5

Take the logarithm of the equation to get a linear equation.

### Cauchy-Riemann Equations

#### Hint 8.6

#### Hint 8.7

#### Hint 8.8

For the first part use the result of Exercise 8.3.

#### Hint 8.9

Use the Cauchy-Riemann equations.

**Hint 8.10****Hint 8.11**

To evaluate  $u_x(0, 0)$ , etc. use the definition of differentiation. Try to find  $f'(z)$  with the definition of complex differentiation. Consider  $\Delta z = \Delta r e^{i\theta}$ .

**Hint 8.12**

To evaluate  $u_x(0, 0)$ , etc. use the definition of differentiation. Try to find  $f'(z)$  with the definition of complex differentiation. Consider  $\Delta z = \Delta r e^{i\theta}$ .

**Hint 8.13****Hint 8.14****Hint 8.15****Hint 8.16****Hint 8.17****Hint 8.18****Hint 8.19**

**Hint 8.20**

**Hint 8.21**

**Hint 8.22**  
CONTINUE

## 8.8 Solutions

### Complex Derivatives

#### Solution 8.1

1. We consider L'Hospital's rule.

$$\lim_{z \rightarrow z_0} \frac{f(z)}{g(z)} = \frac{f'(z_0)}{g'(z_0)}$$

We start with the right side and show that it is equal to the left side. First we apply the definition of complex differentiation.

$$\frac{f'(z_0)}{g'(z_0)} = \frac{\lim_{\epsilon \rightarrow 0} \frac{f(z_0 + \epsilon) - f(z_0)}{\epsilon}}{\lim_{\delta \rightarrow 0} \frac{g(z_0 + \delta) - g(z_0)}{\delta}} = \frac{\lim_{\epsilon \rightarrow 0} \frac{f(z_0 + \epsilon)}{\epsilon}}{\lim_{\delta \rightarrow 0} \frac{g(z_0 + \delta)}{\delta}}$$

Since both of the limits exist, we may take the limits with  $\epsilon = \delta$ .

$$\begin{aligned} \frac{f'(z_0)}{g'(z_0)} &= \lim_{\epsilon \rightarrow 0} \frac{f(z_0 + \epsilon)}{g(z_0 + \epsilon)} \\ &= \lim_{z \rightarrow z_0} \frac{f(z)}{g(z)} \end{aligned}$$

This proves L'Hospital's rule.

- 2.

$$\lim_{z \rightarrow i} \frac{1 + z^2}{2 + 2z^6} = \left[ \frac{2z}{12z^5} \right]_{z=i} = \frac{1}{6}$$

$$\lim_{z \rightarrow i\pi} \frac{\sinh(z)}{e^z + 1} = \left[ \frac{\cosh(z)}{e^z} \right]_{z=i\pi} = 1$$

### Solution 8.2

We start with the Cauchy-Riemann equation and then differentiate with respect to  $x$ .

$$\begin{aligned}\phi_x &= -i\phi_y \\ \phi_{xx} &= -i\phi_{yx}\end{aligned}$$

We interchange the order of differentiation.

$$\begin{aligned}(\phi_x)_x &= -i(\phi_x)_y \\ (f')_x &= -i(f')_y\end{aligned}$$

Since  $f'(z)$  satisfies the Cauchy-Riemann equation and its partial derivatives exist and are continuous, it is analytic.

### Solution 8.3

We calculate the complex derivative in the coordinate directions.

$$\begin{aligned}\frac{df}{dz} &= \left( \frac{\partial (r e^{i\theta})}{\partial r} \right)^{-1} \frac{\partial \phi}{\partial r} = e^{-i\theta} \frac{\partial \phi}{\partial r}, \\ \frac{df}{dz} &= \left( \frac{\partial (r e^{i\theta})}{\partial \theta} \right)^{-1} \frac{\partial \phi}{\partial \theta} = -\frac{i}{r} e^{-i\theta} \frac{\partial \phi}{\partial \theta}.\end{aligned}$$

We can write this in operator notation.

$$\frac{d}{dz} = e^{-i\theta} \frac{\partial}{\partial r} = -\frac{i}{r} e^{-i\theta} \frac{\partial}{\partial \theta}$$

### Solution 8.4

1. Consider  $f(x, y) = \sin x \cosh y - i \cos x \sinh y$ . The derivatives in the  $x$  and  $y$  directions are

$$\begin{aligned}\frac{\partial f}{\partial x} &= \cos x \cosh y + i \sin x \sinh y \\ -i \frac{\partial f}{\partial y} &= -\cos x \cosh y - i \sin x \sinh y\end{aligned}$$



These derivatives exist and are everywhere continuous. We equate the expressions to get a set of two equations.

$$\begin{aligned}\cos x \cosh y &= -\cos x \cosh y, & \sin x \sinh y &= -\sin x \sinh y \\ \cos x \cosh y &= 0, & \sin x \sinh y &= 0 \\ \left(x = \frac{\pi}{2} + n\pi\right) & \text{ and } (x = m\pi \text{ or } y = 0)\end{aligned}$$

The function may be differentiable only at the points

$$\boxed{x = \frac{\pi}{2} + n\pi, \quad y = 0.}$$

Thus the function is nowhere analytic.

2. Consider  $f(x, y) = x^2 - y^2 + x + i(2xy - y)$ . The derivatives in the  $x$  and  $y$  directions are

$$\begin{aligned}\frac{\partial f}{\partial x} &= 2x + 1 + i2y \\ -i \frac{\partial f}{\partial y} &= i2y + 2x - 1\end{aligned}$$

These derivatives exist and are everywhere continuous. We equate the expressions to get a set of two equations.

$$2x + 1 = 2x - 1, \quad 2y = 2y.$$

Since this set of equations has no solutions, there are no points at which the function is differentiable. The function is nowhere analytic.

### Solution 8.5

$$\begin{aligned}f(z_1 + z_2) &= f(z_1) f(z_2) \\ \log(f(z_1 + z_2)) &= \log(f(z_1)) + \log(f(z_2))\end{aligned}$$

We define  $g(z) = \log(f(z))$ .

$$g(z_1 + z_2) = g(z_1) + g(z_2)$$

This is a linear equation which has exactly the solutions:

$$g(z) = cz.$$

Thus  $f(z)$  has the solutions:

$$f(z) = e^{cz},$$

where  $c$  is any complex constant. We can write this constant in terms of  $f'(0)$ . We differentiate the original equation with respect to  $z_1$  and then substitute  $z_1 = 0$ .

$$f'(z_1 + z_2) = f'(z_1) f(z_2)$$

$$f'(z_2) = f'(0) f(z_2)$$

$$f'(z) = f'(0) f(z)$$

We substitute in the form of the solution.

$$c e^{cz} = f'(0) e^{cz}$$

$$c = f'(0)$$

Thus we see that

$$f(z) = e^{f'(0)z}.$$

## Cauchy-Riemann Equations

### Solution 8.6

**Constant Real Part.** First assume that  $f(z)$  has constant real part. We solve the Cauchy-Riemann equations to determine the imaginary part.

$$u_x = v_y, \quad u_y = -v_x$$

$$v_x = 0, \quad v_y = 0$$

We integrate the first equation to obtain  $v = a + g(y)$  where  $a$  is a constant and  $g(y)$  is an arbitrary function. Then we substitute this into the second equation to determine  $g(y)$ .

$$\begin{aligned}g'(y) &= 0 \\g(y) &= b\end{aligned}$$

We see that the imaginary part of  $f(z)$  is a constant and conclude that  $f(z)$  is constant.

**Constant Imaginary Part.** Next assume that  $f(z)$  has constant imaginary part. We solve the Cauchy-Riemann equations to determine the real part.

$$\begin{aligned}u_x &= v_y, & u_y &= -v_x \\u_x &= 0, & u_y &= 0\end{aligned}$$

We integrate the first equation to obtain  $u = a + g(y)$  where  $a$  is a constant and  $g(y)$  is an arbitrary function. Then we substitute this into the second equation to determine  $g(y)$ .

$$\begin{aligned}g'(y) &= 0 \\g(y) &= b\end{aligned}$$

We see that the real part of  $f(z)$  is a constant and conclude that  $f(z)$  is constant.

**Constant Modulus.** Finally assume that  $f(z)$  has constant modulus.

$$\begin{aligned}|f(z)| &= \text{constant} \\ \sqrt{u^2 + v^2} &= \text{constant} \\ u^2 + v^2 &= \text{constant}\end{aligned}$$

We differentiate this equation with respect to  $x$  and  $y$ .

$$\begin{aligned}2uu_x + 2vv_x &= 0, & 2uu_y + 2vv_y &= 0 \\ \begin{pmatrix} u_x & v_x \\ u_y & v_y \end{pmatrix} \begin{pmatrix} u \\ v \end{pmatrix} &= 0\end{aligned}$$

This system has non-trivial solutions for  $u$  and  $v$  only if the matrix is non-singular. (The trivial solution  $u = v = 0$  is the constant function  $f(z) = 0$ .) We set the determinant of the matrix to zero.

$$u_x v_y - u_y v_x = 0$$

We use the Cauchy-Riemann equations to write this in terms of  $u_x$  and  $u_y$ .

$$u_x^2 + u_y^2 = 0$$

$$u_x = u_y = 0$$

Since its partial derivatives vanish,  $u$  is a constant. From the Cauchy-Riemann equations we see that the partial derivatives of  $v$  vanish as well, so it is constant. We conclude that  $f(z)$  is a constant.

**Constant Modulus.** Here is another method for the constant modulus case. We solve the Cauchy-Riemann equations in polar form to determine the argument of  $f(z) = R(x, y) e^{i\Theta(x, y)}$ . Since the function has constant modulus  $R$ , its partial derivatives vanish.

$$R_x = R\Theta_y, \quad R_y = -R\Theta_x$$

$$R\Theta_y = 0, \quad R\Theta_x = 0$$

The equations are satisfied for  $R = 0$ . For this case,  $f(z) = 0$ . We consider nonzero  $R$ .

$$\Theta_y = 0, \quad \Theta_x = 0$$

We see that the argument of  $f(z)$  is a constant and conclude that  $f(z)$  is constant.

### Solution 8.7

First we verify that the Cauchy-Riemann equations are satisfied for  $z \neq 0$ . Note that the form

$$f_x = -i f_y$$

will be far more convenient than the form

$$u_x = v_y, \quad u_y = -v_x$$

for this problem.

$$f_x = 4(x + iy)^{-5} e^{-(x+iy)^{-4}}$$

$$-i f_y = -i 4(x + iy)^{-5} i e^{-(x+iy)^{-4}} = 4(x + iy)^{-5} e^{-(x+iy)^{-4}}$$

The Cauchy-Riemann equations are satisfied for  $z \neq 0$ .

Now we consider the point  $z = 0$ .

$$f_x(0, 0) = \lim_{\Delta x \rightarrow 0} \frac{f(\Delta x, 0) - f(0, 0)}{\Delta x}$$

$$= \lim_{\Delta x \rightarrow 0} \frac{e^{-\Delta x^{-4}}}{\Delta x}$$

$$= 0$$

$$-i f_y(0, 0) = -i \lim_{\Delta y \rightarrow 0} \frac{f(0, \Delta y) - f(0, 0)}{\Delta y}$$

$$= -i \lim_{\Delta y \rightarrow 0} \frac{e^{-\Delta y^{-4}}}{\Delta y}$$

$$= 0$$

The Cauchy-Riemann equations are satisfied for  $z = 0$ .

$f(z)$  is not analytic at the point  $z = 0$ . We show this by calculating the derivative.

$$f'(0) = \lim_{\Delta z \rightarrow 0} \frac{f(\Delta z) - f(0)}{\Delta z} = \lim_{\Delta z \rightarrow 0} \frac{f(\Delta z)}{\Delta z}$$

Let  $\Delta z = \Delta r e^{i\theta}$ , that is, we approach the origin at an angle of  $\theta$ .

$$f'(0) = \lim_{\Delta r \rightarrow 0} \frac{f(\Delta r e^{i\theta})}{\Delta r e^{i\theta}}$$

$$= \lim_{\Delta r \rightarrow 0} \frac{e^{-r^{-4} e^{-i4\theta}}}{\Delta r e^{i\theta}}$$

For most values of  $\theta$  the limit does not exist. Consider  $\theta = \pi/4$ .

$$f'(0) = \lim_{\Delta r \rightarrow 0} \frac{e^{r-4}}{\Delta r e^{i\pi/4}} = \infty$$

Because the limit does not exist, the function is not differentiable at  $z = 0$ . Recall that satisfying the Cauchy-Riemann equations is a necessary, but not a sufficient condition for differentiability.

### Solution 8.8

1. We find the Cauchy-Riemann equations for

$$f(z) = R(r, \theta) e^{i\Theta(r, \theta)}.$$

From Exercise 8.3 we know that the complex derivative in the polar coordinate directions is

$$\frac{d}{dz} = e^{-i\theta} \frac{\partial}{\partial r} = -\frac{i}{r} e^{-i\theta} \frac{\partial}{\partial \theta}.$$

We equate the derivatives in the two directions.

$$\begin{aligned} e^{-i\theta} \frac{\partial}{\partial r} [R e^{i\Theta}] &= -\frac{i}{r} e^{-i\theta} \frac{\partial}{\partial \theta} [R e^{i\Theta}] \\ (R_r + iR\Theta_r) e^{i\Theta} &= -\frac{i}{r} (R_\theta + iR\Theta_\theta) e^{i\Theta} \end{aligned}$$

We divide by  $e^{i\Theta}$  and equate the real and imaginary components to obtain the Cauchy-Riemann equations.

$$R_r = \frac{R}{r} \Theta_\theta, \quad \frac{1}{r} R_\theta = -R\Theta_r$$

2. We find the Cauchy-Riemann equations for

$$f(z) = R(x, y) e^{i\Theta(x, y)}.$$

We equate the derivatives in the  $x$  and  $y$  directions.

$$\begin{aligned}\frac{\partial}{\partial x} [R e^{i\Theta}] &= -i \frac{\partial}{\partial y} [R e^{i\Theta}] \\ (R_x + iR\Theta_y) e^{i\Theta} &= -i (R_x + iR\Theta_y) e^{i\Theta}\end{aligned}$$

We divide by  $e^{i\Theta}$  and equate the real and imaginary components to obtain the Cauchy-Riemann equations.

$$R_x = R\Theta_y, \quad R_y = -R\Theta_x$$

### Solution 8.9

1. A necessary condition for analyticity in an open set is that the Cauchy-Riemann equations are satisfied in that set. We write  $e^{\bar{z}}$  in Cartesian form.

$$e^{\bar{z}} = e^{x-iy} = e^x \cos y - i e^x \sin y.$$

Now we determine where  $u = e^x \cos y$  and  $v = -e^x \sin y$  satisfy the Cauchy-Riemann equations.

$$\begin{aligned}u_x &= v_y, & u_y &= -v_x \\ e^x \cos y &= -e^x \cos y, & -e^x \sin y &= e^x \sin y \\ \cos y &= 0, & \sin y &= 0 \\ y &= \frac{\pi}{2} + \pi m, & y &= \pi n\end{aligned}$$

Thus we see that the Cauchy-Riemann equations are not satisfied anywhere.  $e^{\bar{z}}$  is nowhere analytic.

2. Since  $f(z) = u + iv$  is analytic,  $u$  and  $v$  satisfy the Cauchy-Riemann equations and their first partial derivatives are continuous.

$$\overline{f(z)} = \overline{f(\bar{z})} = \overline{u(x, -y) + iv(x, -y)} = u(x, -y) - iv(x, -y)$$

We define  $\overline{f}(z) \equiv \mu(x, y) + \nu(x, y) = u(x, -y) - v(x, y)$ . Now we see if  $\mu$  and  $\nu$  satisfy the Cauchy-Riemann equations.

$$\begin{aligned} \mu_x &= \nu_y, & \mu_y &= -\nu_x \\ (u(x, -y))_x &= (-v(x, -y))_y, & (u(x, -y))_y &= -(-v(x, -y))_x \\ u_x(x, -y) &= v_y(x, -y), & -u_y(x, -y) &= v_x(x, -y) \\ u_x &= v_y, & u_y &= -v_x \end{aligned}$$

Thus we see that the Cauchy-Riemann equations for  $\mu$  and  $\nu$  are satisfied if and only if the Cauchy-Riemann equations for  $u$  and  $v$  are satisfied. The continuity of the first partial derivatives of  $u$  and  $v$  implies the same of  $\mu$  and  $\nu$ . Thus  $\overline{f}(z)$  is analytic.

### Solution 8.10

- The necessary condition for a function  $f(z) = u + v$  to be differentiable at a point is that the Cauchy-Riemann equations hold and the first partial derivatives of  $u$  and  $v$  are continuous at that point.

(a)

$$f(z) = x^3 + y^3 + i0$$

The Cauchy-Riemann equations are

$$\begin{aligned} u_x &= v_y & \text{and} & & u_y &= -v_x \\ 3x^2 &= 0 & \text{and} & & 3y^2 &= 0 \\ x &= 0 & \text{and} & & y &= 0 \end{aligned}$$

The first partial derivatives are continuous. Thus we see that the function is differentiable only at the point  $z = 0$ .

(b)

$$f(z) = \frac{x-1}{(x-1)^2 + y^2} - i \frac{y}{(x-1)^2 + y^2}$$



The Cauchy-Riemann equations are

$$u_x = v_y \quad \text{and} \quad u_y = -v_x$$

$$\frac{-(x-1)^2 + y^2}{((x-1)^2 + y^2)^2} = \frac{-(x-1)^2 + y^2}{((x-1)^2 + y^2)^2} \quad \text{and} \quad \frac{2(x-1)y}{((x-1)^2 + y^2)^2} = \frac{2(x-1)y}{((x-1)^2 + y^2)^2}$$

The Cauchy-Riemann equations are each identities. The first partial derivatives are continuous everywhere except the point  $x = 1, y = 0$ . Thus the function is differentiable everywhere except  $z = 1$ .

2. (a) The function is not differentiable in any open set. Thus the function is nowhere analytic.
- (b) The function is differentiable everywhere except  $z = 1$ . Thus the function is analytic everywhere except  $z = 1$ .
3. (a) First we determine if the function is harmonic.

$$v = x^2 - y^2$$

$$v_{xx} + v_{yy} = 0$$

$$2 - 2 = 0$$

The function is harmonic in the complex plane and this is the imaginary part of some analytic function. By inspection, we see that this function is

$$iz^2 + c = -2xy + c + i(x^2 - y^2),$$

where  $c$  is a real constant. We can also find the function by solving the Cauchy-Riemann equations.

$$u_x = v_y \quad \text{and} \quad u_y = -v_x$$

$$u_x = -2y \quad \text{and} \quad u_y = -2x$$

We integrate the first equation.

$$u = -2xy + g(y)$$

Here  $g(y)$  is a function of integration. We substitute this into the second Cauchy-Riemann equation to determine  $g(y)$ .

$$\begin{aligned}
 u_y &= -2x \\
 -2x + g'(y) &= -2x \\
 g'(y) &= 0 \\
 g(y) &= c \\
 u &= -2xy + c \\
 f(z) &= -2xy + c + i(x^2 - y^2) \\
 f(z) &= iz^2 + c
 \end{aligned}$$

(b) First we determine if the function is harmonic.

$$\begin{aligned}
 v &= 3x^2y \\
 v_{xx} + v_{yy} &= 6y
 \end{aligned}$$

The function is not harmonic. It is not the imaginary part of some analytic function.

### Solution 8.11

We write the real and imaginary parts of  $f(z) = u + iv$ .

$$u = \begin{cases} \frac{x^{4/3}y^{5/3}}{x^2+y^2} & \text{for } z \neq 0, \\ 0 & \text{for } z = 0. \end{cases}, \quad v = \begin{cases} \frac{x^{5/3}y^{4/3}}{x^2+y^2} & \text{for } z \neq 0, \\ 0 & \text{for } z = 0. \end{cases}$$

The Cauchy-Riemann equations are

$$u_x = v_y, \quad u_y = -v_x.$$

We calculate the partial derivatives of  $u$  and  $v$  at the point  $x = y = 0$  using the definition of differentiation.

$$\begin{aligned} u_x(0,0) &= \lim_{\Delta x \rightarrow 0} \frac{u(\Delta x, 0) - u(0, 0)}{\Delta x} = \lim_{\Delta x \rightarrow 0} \frac{0 - 0}{\Delta x} = 0 \\ v_x(0,0) &= \lim_{\Delta x \rightarrow 0} \frac{v(\Delta x, 0) - v(0, 0)}{\Delta x} = \lim_{\Delta x \rightarrow 0} \frac{0 - 0}{\Delta x} = 0 \\ u_y(0,0) &= \lim_{\Delta y \rightarrow 0} \frac{u(0, \Delta y) - u(0, 0)}{\Delta y} = \lim_{\Delta y \rightarrow 0} \frac{0 - 0}{\Delta y} = 0 \\ v_y(0,0) &= \lim_{\Delta y \rightarrow 0} \frac{v(0, \Delta y) - v(0, 0)}{\Delta y} = \lim_{\Delta y \rightarrow 0} \frac{0 - 0}{\Delta y} = 0 \end{aligned}$$

Since  $u_x(0,0) = u_y(0,0) = v_x(0,0) = v_y(0,0) = 0$  the Cauchy-Riemann equations are satisfied.

$f(z)$  is not analytic at the point  $z = 0$ . We show this by calculating the derivative there.

$$f'(0) = \lim_{\Delta z \rightarrow 0} \frac{f(\Delta z) - f(0)}{\Delta z} = \lim_{\Delta z \rightarrow 0} \frac{f(\Delta z)}{\Delta z}$$

We let  $\Delta z = \Delta r e^{i\theta}$ , that is, we approach the origin at an angle of  $\theta$ . Then  $x = \Delta r \cos \theta$  and  $y = \Delta r \sin \theta$ .

$$\begin{aligned} f'(0) &= \lim_{\Delta r \rightarrow 0} \frac{f(\Delta r e^{i\theta})}{\Delta r e^{i\theta}} \\ &= \lim_{\Delta r \rightarrow 0} \frac{\frac{\Delta r^{4/3} \cos^{4/3} \theta \Delta r^{5/3} \sin^{5/3} \theta + i \Delta r^{5/3} \cos^{5/3} \theta \Delta r^{4/3} \sin^{4/3} \theta}{\Delta r^2}}{\Delta r e^{i\theta}} \\ &= \lim_{\Delta r \rightarrow 0} \frac{\cos^{4/3} \theta \sin^{5/3} \theta + i \cos^{5/3} \theta \sin^{4/3} \theta}{e^{i\theta}} \end{aligned}$$

The value of the limit depends on  $\theta$  and is not a constant. Thus this limit does not exist. The function is not differentiable at  $z = 0$ .

### Solution 8.12

$$u = \begin{cases} \frac{x^3 - y^3}{x^2 + y^2} & \text{for } z \neq 0, \\ 0 & \text{for } z = 0. \end{cases}, \quad v = \begin{cases} \frac{x^3 + y^3}{x^2 + y^2} & \text{for } z \neq 0, \\ 0 & \text{for } z = 0. \end{cases}$$

The Cauchy-Riemann equations are

$$u_x = v_y, \quad u_y = -v_x.$$

The partial derivatives of  $u$  and  $v$  at the point  $x = y = 0$  are,

$$\begin{aligned} u_x(0, 0) &= \lim_{\Delta x \rightarrow 0} \frac{u(\Delta x, 0) - u(0, 0)}{\Delta x} \\ &= \lim_{\Delta x \rightarrow 0} \frac{\Delta x - 0}{\Delta x} \\ &= 1, \end{aligned}$$

$$\begin{aligned} v_x(0, 0) &= \lim_{\Delta x \rightarrow 0} \frac{v(\Delta x, 0) - v(0, 0)}{\Delta x} \\ &= \lim_{\Delta x \rightarrow 0} \frac{\Delta x - 0}{\Delta x} \\ &= 1, \end{aligned}$$

$$\begin{aligned} u_y(0, 0) &= \lim_{\Delta y \rightarrow 0} \frac{u(0, \Delta y) - u(0, 0)}{\Delta y} \\ &= \lim_{\Delta y \rightarrow 0} \frac{-\Delta y - 0}{\Delta y} \\ &= -1, \end{aligned}$$

$$\begin{aligned} v_y(0, 0) &= \lim_{\Delta y \rightarrow 0} \frac{v(0, \Delta y) - v(0, 0)}{\Delta y} \\ &= \lim_{\Delta y \rightarrow 0} \frac{\Delta y - 0}{\Delta y} \\ &= 1. \end{aligned}$$

We see that the Cauchy-Riemann equations are satisfied at  $x = y = 0$

$f(z)$  is not analytic at the point  $z = 0$ . We show this by calculating the derivative.

$$f'(0) = \lim_{\Delta z \rightarrow 0} \frac{f(\Delta z) - f(0)}{\Delta z} = \lim_{\Delta z \rightarrow 0} \frac{f(\Delta z)}{\Delta z}$$

Let  $\Delta z = \Delta r e^{i\theta}$ , that is, we approach the origin at an angle of  $\theta$ . Then  $x = \Delta r \cos \theta$  and  $y = \Delta r \sin \theta$ .

$$\begin{aligned} f'(0) &= \lim_{\Delta r \rightarrow 0} \frac{f(\Delta r e^{i\theta})}{\Delta r e^{i\theta}} \\ &= \lim_{\Delta r \rightarrow 0} \frac{(1+i)\Delta r^3 \cos^3 \theta - (1-i)\Delta r^3 \sin^3 \theta}{\Delta r^2 \Delta r e^{i\theta}} \\ &= \lim_{\Delta r \rightarrow 0} \frac{(1+i)\cos^3 \theta - (1-i)\sin^3 \theta}{e^{i\theta}} \end{aligned}$$

The value of the limit depends on  $\theta$  and is not a constant. Thus this limit does not exist. The function is not differentiable at  $z = 0$ . Recall that satisfying the Cauchy-Riemann equations is a necessary, but not a sufficient condition for differentiability.

### Solution 8.13

We show that the logarithm  $\log z = \phi(r, \theta) = \text{Log } r + i\theta$  satisfies the Cauchy-Riemann equations.

$$\begin{aligned} \phi_r &= -\frac{i}{r} \phi_\theta \\ \frac{1}{r} &= -\frac{i}{r} i \\ \frac{1}{r} &= \frac{1}{r} \end{aligned}$$

Since the logarithm satisfies the Cauchy-Riemann equations and the first partial derivatives are continuous for  $z \neq 0$ , the logarithm is analytic for  $z \neq 0$ .

Now we compute the derivative.

$$\begin{aligned}\frac{d}{dz} \log z &= e^{-i\theta} \frac{\partial}{\partial r} (\text{Log } r + i\theta) \\ &= e^{-i\theta} \frac{1}{r} \\ &= \frac{1}{z}\end{aligned}$$

### Solution 8.14

The complex derivative in the coordinate directions is

$$\frac{d}{dz} = e^{-i\theta} \frac{\partial}{\partial r} = -\frac{i}{r} e^{-i\theta} \frac{\partial}{\partial \theta}.$$

We substitute  $f = u + iv$  into this identity to obtain the Cauchy-Riemann equation in polar coordinates.

$$\begin{aligned}e^{-i\theta} \frac{\partial f}{\partial r} &= -\frac{i}{r} e^{-i\theta} \frac{\partial f}{\partial \theta} \\ \frac{\partial f}{\partial r} &= -\frac{i}{r} \frac{\partial f}{\partial \theta} \\ u_r + iv_r &= -\frac{i}{r} (u_\theta + iv_\theta)\end{aligned}$$

We equate the real and imaginary parts.

$$\begin{aligned}u_r &= \frac{1}{r} v_\theta, & v_r &= -\frac{1}{r} u_\theta \\ u_r &= \frac{1}{r} v_\theta, & u_\theta &= -rv_r\end{aligned}$$

### Solution 8.15

Since  $w$  is analytic,  $u$  and  $v$  satisfy the Cauchy-Riemann equations,

$$u_x = v_y \quad \text{and} \quad u_y = -v_x.$$

Using the chain rule we can write the derivatives with respect to  $x$  and  $y$  in terms of  $u$  and  $v$ .

$$\begin{aligned}\frac{\partial}{\partial x} &= u_x \frac{\partial}{\partial u} + v_x \frac{\partial}{\partial v} \\ \frac{\partial}{\partial y} &= u_y \frac{\partial}{\partial u} + v_y \frac{\partial}{\partial v}\end{aligned}$$

Now we examine  $\phi_x - i\phi_y$ .

$$\begin{aligned}\phi_x - i\phi_y &= u_x \Phi_u + v_x \Phi_v - i(u_y \Phi_u + v_y \Phi_v) \\ \phi_x - i\phi_y &= (u_x - iu_y) \Phi_u + (v_x - iv_y) \Phi_v \\ \phi_x - i\phi_y &= (u_x - iu_y) \Phi_u - i(v_y + iw_x) \Phi_v\end{aligned}$$

We use the Cauchy-Riemann equations to write  $u_y$  and  $v_y$  in terms of  $u_x$  and  $v_x$ .

$$\phi_x - i\phi_y = (u_x + iw_x) \Phi_u - i(u_x + iw_x) \Phi_v$$

Recall that  $w' = u_x + iw_x = v_y - iu_y$ .

$$\phi_x - i\phi_y = \frac{dw}{dz} (\Phi_u - i\Phi_v)$$

Thus we see that,

$$\frac{\partial \Phi}{\partial u} - i \frac{\partial \Phi}{\partial v} = \left( \frac{dw}{dz} \right)^{-1} \left( \frac{\partial \phi}{\partial x} - i \frac{\partial \phi}{\partial y} \right).$$

We write this in operator notation.

$$\frac{\partial}{\partial u} - i \frac{\partial}{\partial v} = \left( \frac{dw}{dz} \right)^{-1} \left( \frac{\partial}{\partial x} - i \frac{\partial}{\partial y} \right)$$

The complex conjugate of this relation is

$$\frac{\partial}{\partial u} + \iota \frac{\partial}{\partial v} = \left( \frac{\overline{dw}}{dz} \right)^{-1} \left( \frac{\partial}{\partial x} + \iota \frac{\partial}{\partial y} \right)$$

Now we apply both these operators to  $\Phi = \phi$ .

$$\left( \frac{\partial}{\partial u} + \iota \frac{\partial}{\partial v} \right) \left( \frac{\partial}{\partial u} - \iota \frac{\partial}{\partial v} \right) \Phi = \left( \frac{\overline{dw}}{dz} \right)^{-1} \left( \frac{\partial}{\partial x} + \iota \frac{\partial}{\partial y} \right) \left( \frac{dw}{dz} \right)^{-1} \left( \frac{\partial}{\partial x} - \iota \frac{\partial}{\partial y} \right) \phi$$

$$\begin{aligned} & \left( \frac{\partial^2}{\partial u^2} + \iota \frac{\partial^2}{\partial u \partial v} - \iota \frac{\partial^2}{\partial v \partial u} + \frac{\partial^2}{\partial v^2} \right) \Phi \\ &= \left( \frac{\overline{dw}}{dz} \right)^{-1} \left[ \left( \left( \frac{\partial}{\partial x} + \iota \frac{\partial}{\partial y} \right) \left( \frac{dw}{dz} \right)^{-1} \right) \left( \frac{\partial}{\partial x} - \iota \frac{\partial}{\partial y} \right) + \left( \frac{dw}{dz} \right)^{-1} \left( \frac{\partial}{\partial x} + \iota \frac{\partial}{\partial y} \right) \left( \frac{\partial}{\partial x} - \iota \frac{\partial}{\partial y} \right) \right] \phi \end{aligned}$$

$(w')^{-1}$  is an analytic function. Recall that for analytic functions  $f$ ,  $f' = f_x = -\iota f_y$ . So that  $f_x + \iota f_y = 0$ .

$$\begin{aligned} \frac{\partial^2 \Phi}{\partial u^2} + \frac{\partial^2 \Phi}{\partial v^2} &= \left( \frac{\overline{dw}}{dz} \right)^{-1} \left[ \left( \frac{dw}{dz} \right)^{-1} \left( \frac{\partial^2}{\partial x^2} + \frac{\partial^2}{\partial y^2} \right) \right] \phi \\ \frac{\partial^2 \Phi}{\partial u^2} + \frac{\partial^2 \Phi}{\partial v^2} &= \left| \frac{dw}{dz} \right|^{-2} \left( \frac{\partial^2 \phi}{\partial x^2} + \frac{\partial^2 \phi}{\partial y^2} \right) \end{aligned}$$

### Solution 8.16

1. We consider

$$f(z) = \log |z| + \iota \arg(z) = \log r + \iota \theta.$$

The Cauchy-Riemann equations in polar coordinates are

$$u_r = \frac{1}{r} v_\theta, \quad u_\theta = -r v_r.$$



We calculate the derivatives.

$$\begin{aligned}u_r &= \frac{1}{r}, & \frac{1}{r}v_\theta &= \frac{1}{r} \\u_\theta &= 0, & -rv_r &= 0\end{aligned}$$

Since the Cauchy-Riemann equations are satisfied and the partial derivatives are continuous,  $f(z)$  is analytic in  $|z| > 0$ ,  $|\arg(z)| < \pi$ . The complex derivative in terms of polar coordinates is

$$\frac{d}{dz} = e^{-i\theta} \frac{\partial}{\partial r} = -\frac{i}{r} e^{-i\theta} \frac{\partial}{\partial \theta}.$$

We use this to differentiate  $f(z)$ .

$$\frac{df}{dz} = e^{-i\theta} \frac{\partial}{\partial r} [\log r + i\theta] = e^{-i\theta} \frac{1}{r} = \frac{1}{z}$$

2. Next we consider

$$f(z) = \sqrt{|z|} e^{i \arg(z)/2} = \sqrt{r} e^{i\theta/2}.$$

The Cauchy-Riemann equations for polar coordinates and the polar form  $f(z) = R(r, \theta) e^{i\Theta(r, \theta)}$  are

$$R_r = \frac{R}{r} \Theta_\theta, \quad \frac{1}{r} R_\theta = -R \Theta_r.$$

We calculate the derivatives for  $R = \sqrt{r}$ ,  $\Theta = \theta/2$ .

$$\begin{aligned}R_r &= \frac{1}{2\sqrt{r}}, & \frac{R}{r} \Theta_\theta &= \frac{1}{2\sqrt{r}} \\ \frac{1}{r} R_\theta &= 0, & -R \Theta_r &= 0\end{aligned}$$

Since the Cauchy-Riemann equations are satisfied and the partial derivatives are continuous,  $f(z)$  is analytic in  $|z| > 0$ ,  $|\arg(z)| < \pi$ . The complex derivative in terms of polar coordinates is

$$\frac{d}{dz} = e^{-i\theta} \frac{\partial}{\partial r} = -\frac{i}{r} e^{-i\theta} \frac{\partial}{\partial \theta}.$$

We use this to differentiate  $f(z)$ .

$$\frac{df}{dz} = e^{-i\theta} \frac{\partial}{\partial r} [\sqrt{r} e^{i\theta/2}] = \frac{1}{2 e^{i\theta/2} \sqrt{r}} = \frac{1}{2\sqrt{z}}$$

### Solution 8.17

1. We consider the function

$$u = x \operatorname{Log} r - y \arctan(x, y) = r \cos \theta \operatorname{Log} r - r \theta \sin \theta$$

We compute the Laplacian.

$$\begin{aligned} \Delta u &= \frac{1}{r} \frac{\partial}{\partial r} \left( r \frac{\partial u}{\partial r} \right) + \frac{1}{r^2} \frac{\partial^2 u}{\partial \theta^2} \\ &= \frac{1}{r} \frac{\partial}{\partial r} (\cos \theta (r + r \operatorname{Log} r) - \theta \sin \theta) + \frac{1}{r^2} (r(\theta \sin \theta - 2 \cos \theta) - r \cos \theta \operatorname{Log} r) \\ &= \frac{1}{r} (2 \cos \theta + \cos \theta \operatorname{Log} r - \theta \sin \theta) + \frac{1}{r} (\theta \sin \theta - 2 \cos \theta - \cos \theta \operatorname{Log} r) \\ &= 0 \end{aligned}$$

The function  $u$  is harmonic. We find the harmonic conjugate  $v$  by solving the Cauchy-Riemann equations.

$$\begin{aligned} v_r &= -\frac{1}{r} u_\theta, & v_\theta &= r u_r \\ v_r &= \sin \theta (1 + \operatorname{Log} r) + \theta \cos \theta, & v_\theta &= r (\cos \theta (1 + \operatorname{Log} r) - \theta \sin \theta) \end{aligned}$$

We integrate the first equation with respect to  $r$  to determine  $v$  to within the constant of integration  $g(\theta)$ .

$$v = r(\sin \theta \operatorname{Log} r + \theta \cos \theta) + g(\theta)$$

We differentiate this expression with respect to  $\theta$ .

$$v_\theta = r (\cos \theta (1 + \operatorname{Log} r) - \theta \sin \theta) + g'(\theta)$$

We compare this to the second Cauchy-Riemann equation to see that  $g'(\theta) = 0$ . Thus  $g(\theta) = c$ . We have determined the harmonic conjugate.

$$v = r(\sin \theta \operatorname{Log} r + \theta \cos \theta) + c$$

The corresponding analytic function is

$$f(z) = r \cos \theta \operatorname{Log} r - r\theta \sin \theta + i(r \sin \theta \operatorname{Log} r + r\theta \cos \theta + c).$$

On the positive real axis, ( $\theta = 0$ ), the function has the value

$$f(z = r) = r \operatorname{Log} r + ic.$$

We use analytic continuation to determine the function in the complex plane.

$$f(z) = z \log z + ic$$

2. We consider the function

$$u = \operatorname{Arg}(z) = \theta.$$

We compute the Laplacian.

$$\Delta u = \frac{1}{r} \frac{\partial}{\partial r} \left( r \frac{\partial u}{\partial r} \right) + \frac{1}{r^2} \frac{\partial^2 u}{\partial \theta^2} = 0$$

The function  $u$  is harmonic. We find the harmonic conjugate  $v$  by solving the Cauchy-Riemann equations.

$$\begin{aligned} v_r &= -\frac{1}{r} u_\theta, & v_\theta &= r u_r \\ v_r &= -\frac{1}{r}, & v_\theta &= 0 \end{aligned}$$

We integrate the first equation with respect to  $r$  to determine  $v$  to within the constant of integration  $g(\theta)$ .

$$v = -\operatorname{Log} r + g(\theta)$$

We differentiate this expression with respect to  $\theta$ .

$$v_\theta = g'(\theta)$$

We compare this to the second Cauchy-Riemann equation to see that  $g'(\theta) = 0$ . Thus  $g(\theta) = c$ . We have determined the harmonic conjugate.

$$v = -\operatorname{Log} r + c$$

The corresponding analytic function is

$$f(z) = \theta - i \operatorname{Log} r + ic$$

On the positive real axis, ( $\theta = 0$ ), the function has the value

$$f(z = r) = -i \operatorname{Log} r + ic$$

We use analytic continuation to determine the function in the complex plane.

$$f(z) = -i \log z + ic$$

3. We consider the function

$$u = r^n \cos(n\theta)$$

We compute the Laplacian.

$$\begin{aligned} \Delta u &= \frac{1}{r} \frac{\partial}{\partial r} \left( r \frac{\partial u}{\partial r} \right) + \frac{1}{r^2} \frac{\partial^2 u}{\partial \theta^2} \\ &= \frac{1}{r} \frac{\partial}{\partial r} (nr^n \cos(n\theta)) - n^2 r^{n-2} \cos(n\theta) \\ &= n^2 r^{n-2} \cos(n\theta) - n^2 r^{n-2} \cos(n\theta) \\ &= 0 \end{aligned}$$

The function  $u$  is harmonic. We find the harmonic conjugate  $v$  by solving the Cauchy-Riemann equations.

$$\begin{aligned}v_r &= -\frac{1}{r}u_\theta, & v_\theta &= ru_r \\v_r &= nr^{n-1}\sin(n\theta), & v_\theta &= nr^n\cos(n\theta)\end{aligned}$$

We integrate the first equation with respect to  $r$  to determine  $v$  to within the constant of integration  $g(\theta)$ .

$$v = r^n \sin(n\theta) + g(\theta)$$

We differentiate this expression with respect to  $\theta$ .

$$v_\theta = nr^n \cos(n\theta) + g'(\theta)$$

We compare this to the second Cauchy-Riemann equation to see that  $g'(\theta) = 0$ . Thus  $g(\theta) = c$ . We have determined the harmonic conjugate.

$$v = r^n \sin(n\theta) + c$$

The corresponding analytic function is

$$f(z) = r^n \cos(n\theta) + ir^n \sin(n\theta) + ic$$

On the positive real axis, ( $\theta = 0$ ), the function has the value

$$f(z = r) = r^n + ic$$

We use analytic continuation to determine the function in the complex plane.

$$f(z) = z^n$$

4. We consider the function

$$u = \frac{y}{r^2} = \frac{\sin \theta}{r}$$

We compute the Laplacian.

$$\begin{aligned}\Delta u &= \frac{1}{r} \frac{\partial}{\partial r} \left( r \frac{\partial u}{\partial r} \right) + \frac{1}{r^2} \frac{\partial^2 u}{\partial \theta^2} \\ &= \frac{1}{r} \frac{\partial}{\partial r} \left( -\frac{\sin \theta}{r} \right) - \frac{\sin \theta}{r^3} \\ &= \frac{\sin \theta}{r^3} - \frac{\sin \theta}{r^3} \\ &= 0\end{aligned}$$

The function  $u$  is harmonic. We find the harmonic conjugate  $v$  by solving the Cauchy-Riemann equations.

$$\begin{aligned}v_r &= -\frac{1}{r}u_\theta, & v_\theta &= ru_r \\ v_r &= -\frac{\cos \theta}{r^2}, & v_\theta &= -\frac{\sin \theta}{r}\end{aligned}$$

We integrate the first equation with respect to  $r$  to determine  $v$  to within the constant of integration  $g(\theta)$ .

$$v = \frac{\cos \theta}{r} + g(\theta)$$

We differentiate this expression with respect to  $\theta$ .

$$v_\theta = -\frac{\sin \theta}{r} + g'(\theta)$$

We compare this to the second Cauchy-Riemann equation to see that  $g'(\theta) = 0$ . Thus  $g(\theta) = c$ . We have determined the harmonic conjugate.

$$v = \frac{\cos \theta}{r} + c$$

The corresponding analytic function is

$$f(z) = \frac{\sin \theta}{r} + i \frac{\cos \theta}{r} + ic$$

On the positive real axis, ( $\theta = 0$ ), the function has the value

$$f(z = r) = \frac{i}{r} + ic.$$

We use analytic continuation to determine the function in the complex plane.

$$f(z) = \frac{i}{z} + ic$$

### Solution 8.18

1. We calculate the first partial derivatives of  $u = (x - y)^2$  and  $v = 2(x + y)$ .

$$u_x = 2(x - y)$$

$$u_y = 2(y - x)$$

$$v_x = 2$$

$$v_y = 2$$

We substitute these expressions into the Cauchy-Riemann equations.

$$\begin{aligned}u_x &= v_y, & u_y &= -v_x \\2(x - y) &= 2, & 2(y - x) &= -2 \\x - y &= 1, & y - x &= -1 \\y &= x - 1\end{aligned}$$

Since the Cauchy-Riemann equations are satisfied along the line  $y = x - 1$  and the partial derivatives are continuous, the function  $f(z)$  is differentiable there. Since the function is not differentiable in a neighborhood of any point, it is nowhere analytic.

2. We calculate the first partial derivatives of  $u$  and  $v$ .

$$u_x = 2 e^{x^2-y^2} (x \cos(2xy) - y \sin(2xy))$$

$$u_y = -2 e^{x^2-y^2} (y \cos(2xy) + x \sin(2xy))$$

$$v_x = 2 e^{x^2-y^2} (y \cos(2xy) + x \sin(2xy))$$

$$v_y = 2 e^{x^2-y^2} (x \cos(2xy) - y \sin(2xy))$$

Since the Cauchy-Riemann equations,  $u_x = v_y$  and  $u_y = -v_x$ , are satisfied everywhere and the partial derivatives are continuous,  $f(z)$  is everywhere differentiable. Since  $f(z)$  is differentiable in a neighborhood of every point, it is analytic in the complex plane. ( $f(z)$  is entire.)

Now to evaluate the derivative. The complex derivative is the derivative in any direction. We choose the  $x$  direction.

$$f'(z) = u_x + v_x$$

$$f'(z) = 2 e^{x^2-y^2} (x \cos(2xy) - y \sin(2xy)) + 2 e^{x^2-y^2} (y \cos(2xy) + x \sin(2xy))$$

$$f'(z) = 2 e^{x^2-y^2} ((x + iy) \cos(2xy) + (-y + ix) \sin(2xy))$$

Finding the derivative is easier if we first write  $f(z)$  in terms of the complex variable  $z$  and use complex differentiation.

$$f(z) = e^{x^2-y^2} (\cos(2x, y) + i \sin(2xy))$$

$$f(z) = e^{x^2-y^2} e^{i2xy}$$

$$f(z) = e^{(x+iy)^2}$$

$$f(z) = e^{z^2}$$

$$f'(z) = 2z e^{z^2}$$



### Solution 8.19

1. Assume that the Cauchy-Riemann equations in Cartesian coordinates

$$u_x = v_y, \quad u_y = -v_x$$

are satisfied and these partial derivatives are continuous at a point  $z$ . We write the derivatives in polar coordinates in terms of derivatives in Cartesian coordinates to verify the Cauchy-Riemann equations in polar coordinates. First we calculate the derivatives.

$$\begin{aligned}x &= r \cos \theta, & y &= r \sin \theta \\w_r &= \frac{\partial x}{\partial r} w_x + \frac{\partial y}{\partial r} w_y = \cos \theta w_x + \sin \theta w_y \\w_\theta &= \frac{\partial x}{\partial \theta} w_x + \frac{\partial y}{\partial \theta} w_y = -r \sin \theta w_x + r \cos \theta w_y\end{aligned}$$

Then we verify the Cauchy-Riemann equations in polar coordinates.

$$\begin{aligned}u_r &= \cos \theta u_x + \sin \theta u_y \\&= \cos \theta v_y - \sin \theta v_x \\&= \frac{1}{r} v_\theta\end{aligned}$$

$$\begin{aligned}\frac{1}{r} u_\theta &= -\sin \theta u_x + \cos \theta u_y \\&= -\sin \theta v_y - \cos \theta v_x \\&= -v_r\end{aligned}$$

This proves that the Cauchy-Riemann equations in Cartesian coordinates hold only if the Cauchy-Riemann equations in polar coordinates hold. (Given that the partial derivatives are continuous.) Next we prove the converse.

Assume that the Cauchy-Riemann equations in polar coordinates

$$u_r = \frac{1}{r} v_\theta, \quad \frac{1}{r} u_\theta = -v_r$$

are satisfied and these partial derivatives are continuous at a point  $z$ . We write the derivatives in Cartesian coordinates in terms of derivatives in polar coordinates to verify the Cauchy-Riemann equations in Cartesian coordinates. First we calculate the derivatives.

$$r = \sqrt{x^2 + y^2}, \quad \theta = \arctan(x, y)$$

$$w_x = \frac{\partial r}{\partial x} w_r + \frac{\partial \theta}{\partial x} w_\theta = \frac{x}{r} w_r - \frac{y}{r^2} w_\theta$$

$$w_y = \frac{\partial r}{\partial y} w_r + \frac{\partial \theta}{\partial y} w_\theta = \frac{y}{r} w_r + \frac{x}{r^2} w_\theta$$

Then we verify the Cauchy-Riemann equations in Cartesian coordinates.

$$u_x = \frac{x}{r} u_r - \frac{y}{r^2} u_\theta$$

$$= \frac{x}{r^2} v_\theta + \frac{y}{r} v_r$$

$$= u_y$$

$$u_y = \frac{y}{r} u_r + \frac{x}{r^2} u_\theta$$

$$= \frac{y}{r^2} v_\theta - \frac{x}{r} v_r$$

$$= -u_x$$

This proves that the Cauchy-Riemann equations in polar coordinates hold only if the Cauchy-Riemann equations in Cartesian coordinates hold. We have demonstrated the equivalence of the two forms.

2. We verify that  $\log z$  is analytic for  $r > 0$  and  $-\pi < \theta < \pi$  using the polar form of the Cauchy-Riemann equations.

$$\text{Log } z = \ln r + i\theta$$

$$u_r = \frac{1}{r} v_\theta, \quad \frac{1}{r} u_\theta = -v_r$$

$$\frac{1}{r} = \frac{1}{r} 1, \quad \frac{1}{r} 0 = -0$$

Since the Cauchy-Riemann equations are satisfied and the partial derivatives are continuous for  $r > 0$ ,  $\log z$  is analytic there. We calculate the value of the derivative using the polar differentiation formulas.

$$\begin{aligned}\frac{d}{dz} \operatorname{Log} z &= e^{-i\theta} \frac{\partial}{\partial r} (\ln r + i\theta) = e^{-i\theta} \frac{1}{r} = \frac{1}{z} \\ \frac{d}{dz} \operatorname{Log} z &= \frac{-i}{z} \frac{\partial}{\partial \theta} (\ln r + i\theta) = \frac{-i}{z} i = \frac{1}{z}\end{aligned}$$

3. Let  $\{x_i\}$  denote rectangular coordinates in two dimensions and let  $\{\xi_i\}$  be an orthogonal coordinate system. The *distance metric coefficients*  $h_i$  are defined

$$h_i = \sqrt{\left(\frac{\partial x_1}{\partial \xi_i}\right)^2 + \left(\frac{\partial x_2}{\partial \xi_i}\right)^2}.$$

The Laplacian is

$$\nabla^2 u = \frac{1}{h_1 h_2} \left( \frac{\partial}{\partial \xi_1} \left( \frac{h_2}{h_1} \frac{\partial u}{\partial \xi_1} \right) + \frac{\partial}{\partial \xi_2} \left( \frac{h_1}{h_2} \frac{\partial u}{\partial \xi_2} \right) \right).$$

First we calculate the distance metric coefficients in polar coordinates.

$$\begin{aligned}h_r &= \sqrt{\left(\frac{\partial x}{\partial r}\right)^2 + \left(\frac{\partial y}{\partial r}\right)^2} = \sqrt{\cos^2 \theta + \sin^2 \theta} = 1 \\ h_\theta &= \sqrt{\left(\frac{\partial x}{\partial \theta}\right)^2 + \left(\frac{\partial y}{\partial \theta}\right)^2} = \sqrt{r^2 \sin^2 \theta + r^2 \cos^2 \theta} = r\end{aligned}$$

Then we find the Laplacian.

$$\nabla^2 \phi = \frac{1}{r} \left( \frac{\partial}{\partial r} (r \phi_r) + \frac{\partial}{\partial \theta} \left( \frac{1}{r} \phi_\theta \right) \right)$$

In polar coordinates, Laplace's equation is

$$\phi_{rr} + \frac{1}{r} \phi_r + \frac{1}{r^2} \phi_{\theta\theta} = 0.$$

**Solution 8.20**

1. We compute the Laplacian of  $u(x, y) = x^3 - y^3$ .

$$\nabla^2 u = 6x - 6y$$

Since  $u$  is not harmonic, it is not the real part of an analytic function.

2. We compute the Laplacian of  $u(x, y) = \sinh x \cos y + x$ .

$$\nabla^2 u = \sinh x \cos y - \sinh x \cos y = 0$$

Since  $u$  is harmonic, it is the real part of an analytic function. We determine  $v$  by solving the Cauchy-Riemann equations.

$$\begin{aligned} v_x &= -u_y, & v_y &= u_x \\ v_x &= \sinh x \sin y, & v_y &= \cosh x \cos y + 1 \end{aligned}$$

We integrate the first equation to determine  $v$  up to an arbitrary additive function of  $y$ .

$$v = \cosh x \sin y + g(y)$$

We substitute this into the second Cauchy-Riemann equation. This will determine  $v$  up to an additive constant.

$$\begin{aligned} v_y &= \cosh x \cos y + 1 \\ \cosh x \cos y + g'(y) &= \cosh x \cos y + 1 \\ g'(y) &= 1 \\ g(y) &= y + a \\ v &= \cosh x \sin y + y + a \\ f(z) &= \sinh x \cos y + x + i(\cosh x \sin y + y + a) \end{aligned}$$

Here  $a$  is a real constant. We write the function in terms of  $z$ .

$$f(z) = \sinh z + z + ia$$

3. We compute the Laplacian of  $u(r, \theta) = r^n \cos(n\theta)$ .

$$\nabla^2 u = n(n-1)r^{n-2} \cos(n\theta) + nr^{n-2} \cos(n\theta) - n^2 r^{n-2} \cos(n\theta) = 0$$

Since  $u$  is harmonic, it is the real part of an analytic function. We determine  $v$  by solving the Cauchy-Riemann equations.

$$\begin{aligned} v_r &= -\frac{1}{r}u_\theta, & v_\theta &= ru_r \\ v_r &= nr^{n-1} \sin(n\theta), & v_\theta &= nr^n \cos(n\theta) \end{aligned}$$

We integrate the first equation to determine  $v$  up to an arbitrary additive function of  $\theta$ .

$$v = r^n \sin(n\theta) + g(\theta)$$

We substitute this into the second Cauchy-Riemann equation. This will determine  $v$  up to an additive constant.

$$\begin{aligned} v_\theta &= nr^n \cos(n\theta) \\ nr^n \cos(n\theta) + g'(\theta) &= nr^n \cos(n\theta) \\ g'(\theta) &= 0 \\ g(\theta) &= a \\ v &= r^n \sin(n\theta) + a \\ f(z) &= r^n \cos(n\theta) + i(r^n \sin(n\theta) + a) \end{aligned}$$

Here  $a$  is a real constant. We write the function in terms of  $z$ .

$$f(z) = z^n + ia$$

### Solution 8.21

1. We find the velocity potential  $\phi$  and stream function  $\psi$ .

$$\begin{aligned} \Phi(z) &= \log z + i \log z \\ \Phi(z) &= \ln r + i\theta + i(\ln r + i\theta) \\ \phi &= \ln r - \theta, & \psi &= \ln r + \theta \end{aligned}$$

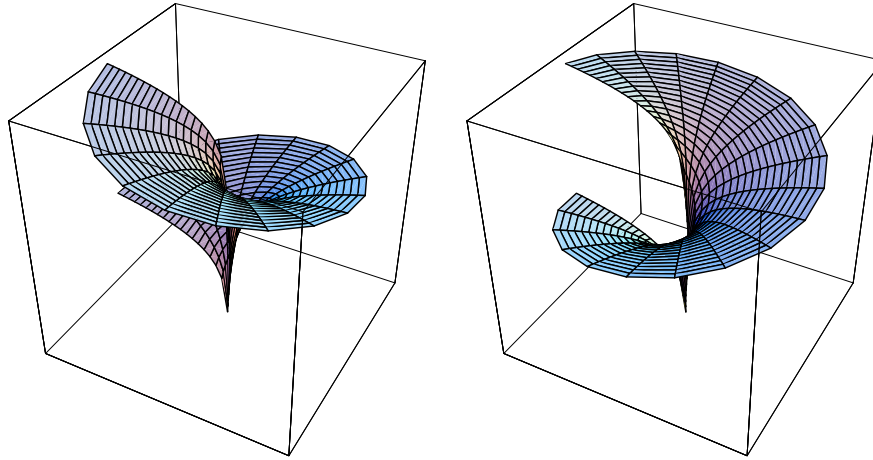

Figure 8.7: The velocity potential  $\phi$  and stream function  $\psi$  for  $\Phi(z) = \log z + i \log z$ .

A branch of these are plotted in Figure 8.7.

Next we find the stream lines,  $\psi = c$ .

$$\begin{aligned} \ln r + \theta &= c \\ r &= e^{c-\theta} \end{aligned}$$

These are spirals which go counter-clockwise as we follow them to the origin. See Figure 8.8. Next we find the velocity field.

$$\begin{aligned} \mathbf{v} &= \nabla \phi \\ \mathbf{v} &= \phi_r \hat{\mathbf{r}} + \frac{\phi_\theta}{r} \hat{\boldsymbol{\theta}} \\ \mathbf{v} &= \frac{\hat{\mathbf{r}}}{r} - \frac{\hat{\boldsymbol{\theta}}}{r} \end{aligned}$$

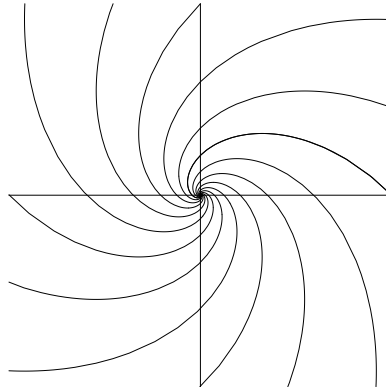

Figure 8.8: Streamlines for  $\psi = \ln r + \theta$ .

The velocity field is shown in the first plot of Figure 8.9. We see that the fluid flows out from the origin along the spiral paths of the streamlines. The second plot shows the direction of the velocity field.

2. We find the velocity potential  $\phi$  and stream function  $\psi$ .

$$\begin{aligned}\Phi(z) &= \log(z - 1) + \log(z + 1) \\ \Phi(z) &= \ln |z - 1| + i \arg(z - 1) + \ln |z + 1| + i \arg(z + 1) \\ \phi &= \ln |z^2 - 1|, \quad \psi = \arg(z - 1) + \arg(z + 1)\end{aligned}$$

The velocity potential and a branch of the stream function are plotted in Figure 8.10.

The stream lines,  $\arg(z - 1) + \arg(z + 1) = c$ , are plotted in Figure 8.11.

Next we find the velocity field.

$$\begin{aligned}\mathbf{v} &= \nabla \phi \\ \mathbf{v} &= \frac{2x(x^2 + y^2 - 1)}{x^4 + 2x^2(y^2 - 1) + (y^2 + 1)^2} \hat{\mathbf{x}} + \frac{2y(x^2 + y^2 + 1)}{x^4 + 2x^2(y^2 - 1) + (y^2 + 1)^2} \hat{\mathbf{y}}\end{aligned}$$

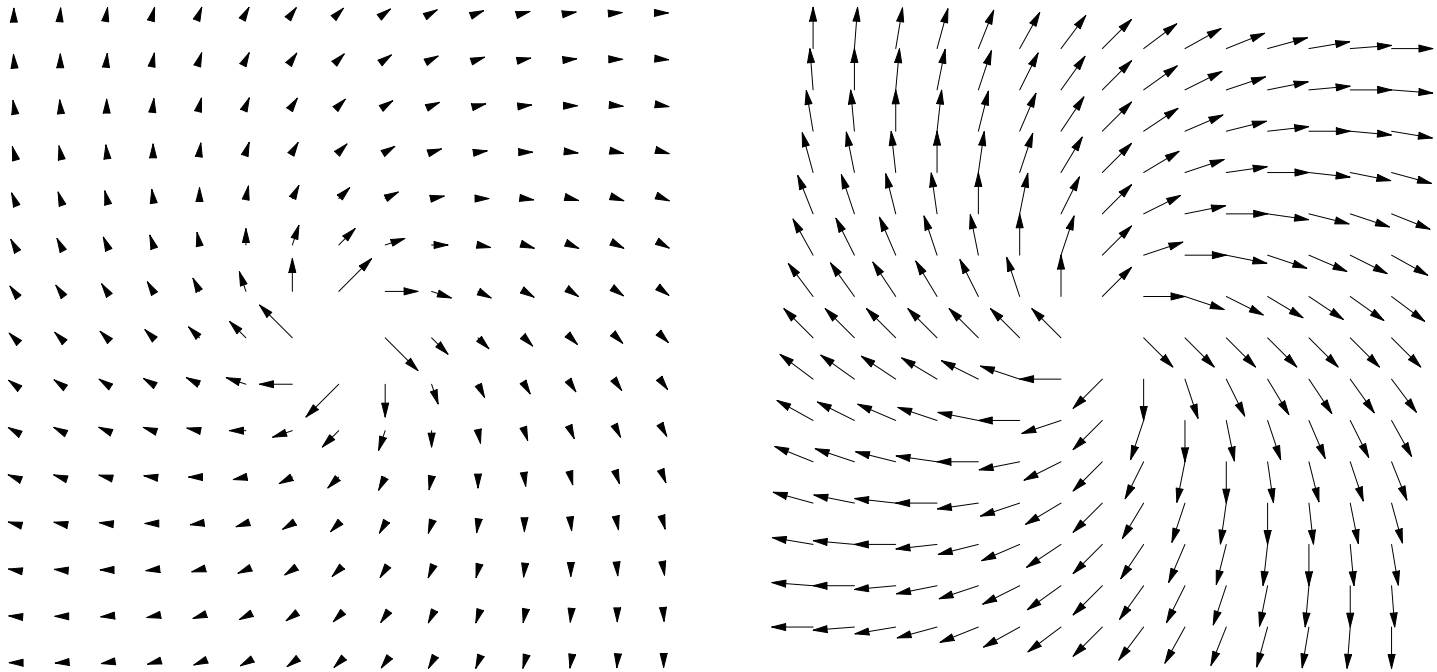

Figure 8.9: Velocity field and velocity direction field for  $\phi = \ln r - \theta$ .

The velocity field is shown in the first plot of Figure 8.12. The fluid is flowing out of sources at  $z = \pm 1$ . The second plot shows the direction of the velocity field.

### Solution 8.22

- (a) We factor the denominator to see that there are first order poles at  $z = \pm i$ .

$$\frac{z}{z^2 + 1} = \frac{z}{(z - i)(z + i)}$$



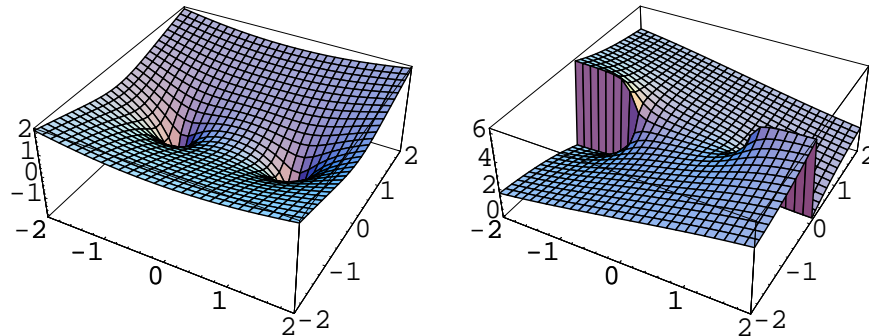

Figure 8.10: The velocity potential  $\phi$  and stream function  $\psi$  for  $\Phi(z) = \log(z - 1) + \log(z + 1)$ .

Since the function behaves like  $1/z$  at infinity, it is analytic there.

- (b) The denominator of  $1/\sin z$  has first order zeros at  $z = n\pi$ ,  $n \in \mathbb{Z}$ . Thus the function has first order poles at these locations. Now we examine the point at infinity with the change of variables  $z = 1/\zeta$ .

$$\frac{1}{\sin z} = \frac{1}{\sin(1/\zeta)} = \frac{i2}{e^{i/\zeta} - e^{-i/\zeta}}$$

We see that the point at infinity is a singularity of the function. Since the denominator grows exponentially, there is no multiplicative factor of  $\zeta^n$  that will make the function analytic at  $\zeta = 0$ . We conclude that the point at infinity is an essential singularity. Since there is no deleted neighborhood of the point at infinity that does contain first order poles at the locations  $z = n\pi$ , the point at infinity is a non-isolated singularity.

- (c)

$$\log(1 + z^2) = \log(z + i) + \log(z - i)$$

There are branch points at  $z = \pm i$ . Since the argument of the logarithm is unbounded as  $z \rightarrow \infty$  there is a branch point at infinity as well. Branch points are non-isolated singularities.

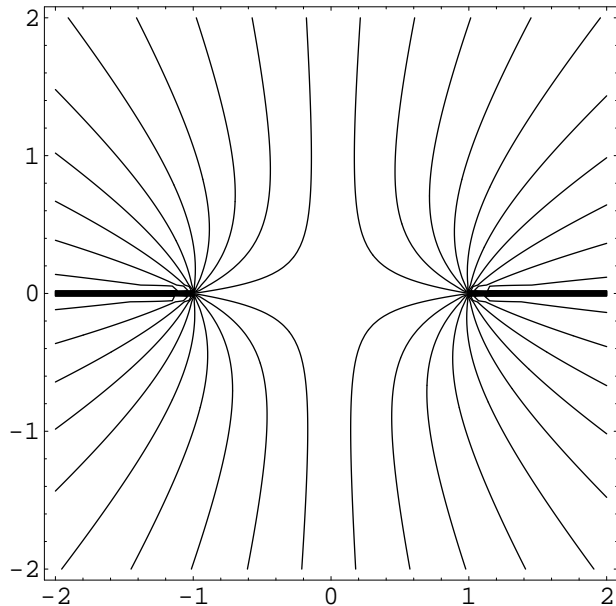

Figure 8.11: Streamlines for  $\psi = \arg(z - 1) + \arg(z + 1)$ .

(d)

$$z \sin(1/z) = \frac{1}{2} z (e^{i/z} + e^{-i/z})$$

The point  $z = 0$  is a singularity. Since the function grows exponentially at  $z = 0$ . There is no multiplicative factor of  $z^n$  that will make the function analytic. Thus  $z = 0$  is an essential singularity.

There are no other singularities in the finite complex plane. We examine the point at infinity.

$$z \sin\left(\frac{1}{z}\right) = \frac{1}{\zeta} \sin \zeta$$

The point at infinity is a singularity. We take the limit  $\zeta \rightarrow 0$  to demonstrate that it is a removable

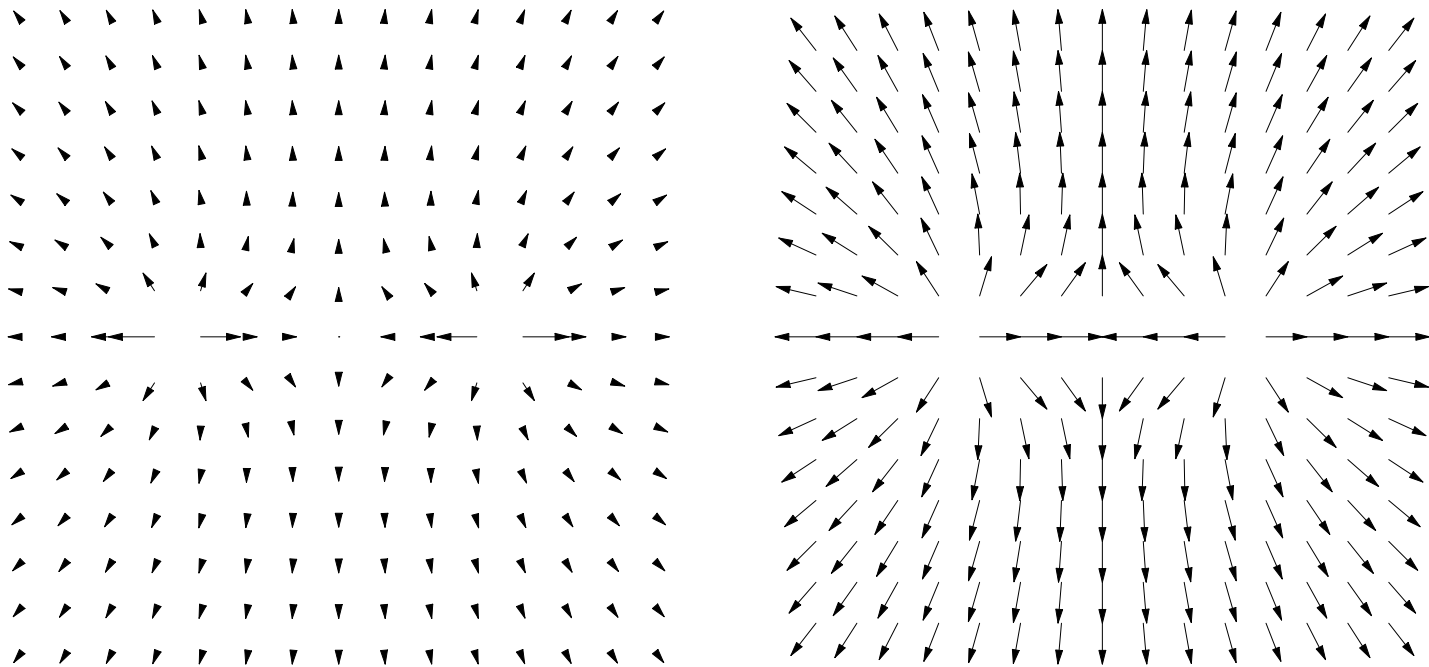

Figure 8.12: Velocity field and velocity direction field for  $\phi = \ln |z^2 - 1|$ .

singularity.

$$\lim_{\zeta \rightarrow 0} \frac{\sin \zeta}{\zeta} = \lim_{\zeta \rightarrow 0} \frac{\cos \zeta}{1} = 1$$

(e)

$$\frac{\tan^{-1}(z)}{z \sinh^2(\pi z)} = \frac{i \log \left( \frac{i+z}{i-z} \right)}{2z \sinh^2(\pi z)}$$

There are branch points at  $z = \pm i$  due to the logarithm. These are non-isolated singularities. Note that  $\sinh(z)$  has first order zeros at  $z = n\pi$ ,  $n \in \mathbb{Z}$ . The arctangent has a first order zero at  $z = 0$ . Thus there is a second order pole at  $z = 0$ . There are second order poles at  $z = n$ ,  $n \in \mathbb{Z} \setminus \{0\}$  due to the hyperbolic sine. Since the hyperbolic sine has an essential singularity at infinity, the function has an essential singularity at infinity as well. The point at infinity is a non-isolated singularity because there is no neighborhood of infinity that does not contain second order poles.

2. (a)  $(z - i)e^{1/(z-1)}$  has a simple zero at  $z = i$  and an isolated essential singularity at  $z = 1$ .

(b)

$$\frac{\sin(z - 3)}{(z - 3)(z + i)^6}$$

has a removable singularity at  $z = 3$ , a pole of order 6 at  $z = -i$  and an essential singularity at  $z_\infty$ .

# Chapter 9

## Analytic Continuation

For every complex problem, there is a solution that is simple, neat, and wrong.

- H. L. Mencken

### 9.1 Analytic Continuation

Suppose there is a function,  $f_1(z)$  that is analytic in the domain  $D_1$  and another analytic function,  $f_2(z)$  that is analytic in the domain  $D_2$ . (See Figure 9.1.)

If the two domains overlap and  $f_1(z) = f_2(z)$  in the overlap region  $D_1 \cap D_2$ , then  $f_2(z)$  is called an *analytic continuation* of  $f_1(z)$ . This is an appropriate name since  $f_2(z)$  continues the definition of  $f_1(z)$  outside of its original domain of definition  $D_1$ . We can define a function  $f(z)$  that is analytic in the union of the domains  $D_1 \cup D_2$ . On the domain  $D_1$  we have  $f(z) = f_1(z)$  and  $f(z) = f_2(z)$  on  $D_2$ .  $f_1(z)$  and  $f_2(z)$  are called *function elements*. There is an analytic continuation even if the two domains only share an arc and not a two dimensional region.

With more overlapping domains  $D_3, D_4, \dots$  we could perhaps extend  $f_1(z)$  to more of the complex plane. Sometimes it is impossible to extend a function beyond the boundary of a domain. This is known as a *natural boundary*. If a

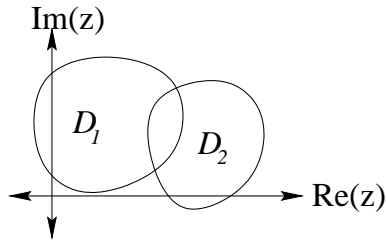

Figure 9.1: Overlapping Domains

function  $f_1(z)$  is analytically continued to a domain  $D_n$  along two different paths, (See Figure 9.2.), then the two analytic continuations are identical as long as the paths do not enclose a branch point of the function. This is the *uniqueness theorem of analytic continuation*.

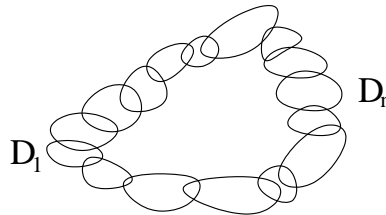

Figure 9.2: Two Paths of Analytic Continuation

Consider an analytic function  $f(z)$  defined in the domain  $D$ . Suppose that  $f(z) = 0$  on the arc  $AB$ , (see Figure 9.3.) Then  $f(z) = 0$  in all of  $D$ .

Consider a point  $\zeta$  on  $AB$ . The Taylor series expansion of  $f(z)$  about the point  $z = \zeta$  converges in a circle  $C$  at

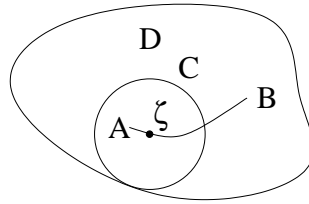

Figure 9.3: Domain Containing Arc Along Which  $f(z)$  Vanishes

least up to the boundary of  $D$ . The derivative of  $f(z)$  at the point  $z = \zeta$  is

$$f'(\zeta) = \lim_{\Delta z \rightarrow 0} \frac{f(\zeta + \Delta z) - f(\zeta)}{\Delta z}$$

If  $\Delta z$  is in the direction of the arc, then  $f'(\zeta)$  vanishes as well as all higher derivatives,  $f'(\zeta) = f''(\zeta) = f'''(\zeta) = \cdots = 0$ . Thus we see that  $f(z) = 0$  inside  $C$ . By taking Taylor series expansions about points on  $AB$  or inside of  $C$  we see that  $f(z) = 0$  in  $D$ .

**Result 9.1.1** Let  $f_1(z)$  and  $f_2(z)$  be analytic functions defined in  $D$ . If  $f_1(z) = f_2(z)$  for the points in a region or on an arc in  $D$ , then  $f_1(z) = f_2(z)$  for all points in  $D$ .

To prove Result 9.1.1, we define the analytic function  $g(z) = f_1(z) - f_2(z)$ . Since  $g(z)$  vanishes in the region or on the arc, then  $g(z) = 0$  and hence  $f_1(z) = f_2(z)$  for all points in  $D$ .

**Result 9.1.2** Consider analytic functions  $f_1(z)$  and  $f_2(z)$  defined on the domains  $D_1$  and  $D_2$ , respectively. Suppose that  $D_1 \cap D_2$  is a region or an arc and that  $f_1(z) = f_2(z)$  for all  $z \in D_1 \cap D_2$ . (See Figure 9.4.) Then the function

$$f(z) = \begin{cases} f_1(z) & \text{for } z \in D_1, \\ f_2(z) & \text{for } z \in D_2, \end{cases}$$

is analytic in  $D_1 \cup D_2$ .

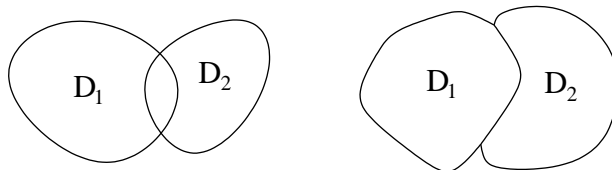

Figure 9.4: Domains that Intersect in a Region or an Arc

Result 9.1.2 follows directly from Result 9.1.1.

## 9.2 Analytic Continuation of Sums

**Example 9.2.1** Consider the function

$$f_1(z) = \sum_{n=0}^{\infty} z^n.$$

The sum converges uniformly for  $D_1 = |z| \leq r < 1$ . Since the derivative also converges in this domain, the function is analytic there.



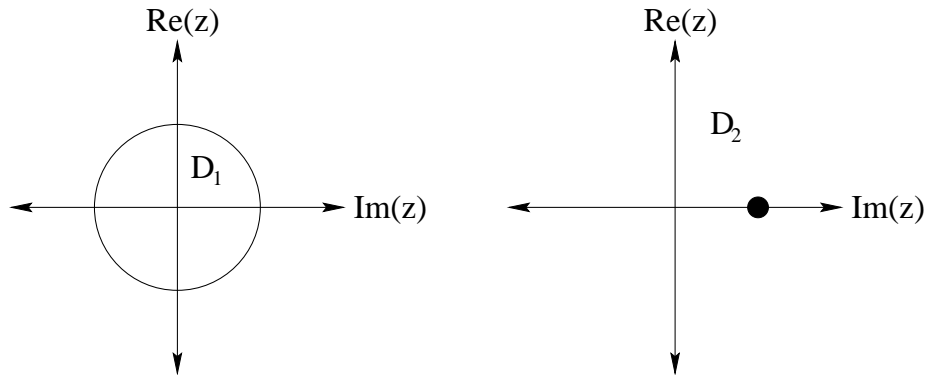

Figure 9.5: Domain of Convergence for  $\sum_{n=0}^{\infty} z^n$ .

Now consider the function

$$f_2(z) = \frac{1}{1-z}.$$

This function is analytic everywhere except the point  $z = 1$ . On the domain  $D_1$ ,

$$f_2(z) = \frac{1}{1-z} = \sum_{n=0}^{\infty} z^n = f_1(z)$$

Analytic continuation tells us that there is a function that is analytic on the union of the two domains. Here, the domain is the entire  $z$  plane except the point  $z = 1$  and the function is

$$f(z) = \frac{1}{1-z}.$$

$\frac{1}{1-z}$  is said to be an analytic continuation of  $\sum_{n=0}^{\infty} z^n$ .

## 9.3 Analytic Functions Defined in Terms of Real Variables

**Result 9.3.1** An analytic function,  $u(x, y) + v(x, y)$  can be written in terms of a function of a complex variable,  $f(z) = u(x, y) + v(x, y)$ .

Result 9.3.1 is proved in Exercise 9.1.

### Example 9.3.1

$$f(z) = \cosh y \sin x (x e^x \cos y - y e^x \sin y) - \cos x \sinh y (y e^x \cos y + x e^x \sin y) \\ + i [\cosh y \sin x (y e^x \cos y + x e^x \sin y) + \cos x \sinh y (x e^x \cos y - y e^x \sin y)]$$

is an analytic function. Express  $f(z)$  in terms of  $z$ .

On the real line,  $y = 0$ ,  $f(z)$  is

$$f(z = x) = x e^x \sin x$$

(Recall that  $\cos(0) = \cosh(0) = 1$  and  $\sin(0) = \sinh(0) = 0$ .)

The analytic continuation of  $f(z)$  into the complex plane is

$$f(z) = z e^z \sin z.$$

Alternatively, for  $x = 0$  we have

$$f(z = iy) = y \sinh y (\cos y - i \sin y).$$

The analytic continuation from the imaginary axis to the complex plane is

$$f(z) = -iz \sinh(-iz) (\cos(-iz) - i \sin(-iz)) \\ = iz \sinh(iz) (\cos(iz) + i \sin(iz)) \\ = z \sin z e^z.$$

**Example 9.3.2** Consider  $u = e^{-x}(x \sin y - y \cos y)$ . Find  $v$  such that  $f(z) = u + v$  is analytic.

From the Cauchy-Riemann equations,

$$\begin{aligned}\frac{\partial v}{\partial y} &= \frac{\partial u}{\partial x} = e^{-x} \sin y - x e^{-x} \sin y + y e^{-x} \cos y \\ \frac{\partial v}{\partial x} &= -\frac{\partial u}{\partial y} = e^{-x} \cos y - x e^{-x} \cos y - y e^{-x} \sin y\end{aligned}$$

Integrate the first equation with respect to  $y$ .

$$\begin{aligned}v &= -e^{-x} \cos y + x e^{-x} \cos y + e^{-x}(y \sin y + \cos y) + F(x) \\ &= y e^{-x} \sin y + x e^{-x} \cos y + F(x)\end{aligned}$$

$F(x)$  is an arbitrary function of  $x$ . Substitute this expression for  $v$  into the equation for  $\partial v/\partial x$ .

$$-y e^{-x} \sin y - x e^{-x} \cos y + e^{-x} \cos y + F'(x) = -y e^{-x} \sin y - x e^{-x} \cos y + e^{-x} \cos y$$

Thus  $F'(x) = 0$  and  $F(x) = c$ .

$$v = e^{-x}(y \sin y + x \cos y) + c$$

**Example 9.3.3** Find  $f(z)$  in the previous example. (Up to the additive constant.)

**Method 1**

$$\begin{aligned}f(z) &= u + v \\ &= e^{-x}(x \sin y - y \cos y) + i e^{-x}(y \sin y + x \cos y) \\ &= e^{-x} \left\{ x \left( \frac{e^{iy} - e^{-iy}}{i2} \right) - y \left( \frac{e^{iy} + e^{-iy}}{2} \right) \right\} + i e^{-x} \left\{ y \left( \frac{e^{iy} - e^{-iy}}{i2} \right) + x \left( \frac{e^{iy} + e^{-iy}}{2} \right) \right\} \\ &= i(x + iy) e^{-(x+iy)} \\ &= iz e^{-z}\end{aligned}$$

**Method 2**  $f(z) = f(x + iy) = u(x, y) + w(x, y)$  is an analytic function.

On the real axis,  $y = 0$ ,  $f(z)$  is

$$\begin{aligned} f(z = x) &= u(x, 0) + w(x, 0) \\ &= e^{-x}(x \sin 0 - 0 \cos 0) + i e^{-x}(0 \sin 0 + x \cos 0) \\ &= ix e^{-x} \end{aligned}$$

Suppose there is an analytic continuation of  $f(z)$  into the complex plane. If such a continuation,  $f(z)$ , exists, then it must be equal to  $f(z = x)$  on the real axis. An obvious choice for the analytic continuation is

$$f(z) = u(z, 0) + w(z, 0)$$

since this is clearly equal to  $u(x, 0) + w(x, 0)$  when  $z$  is real. Thus we obtain

$$f(z) = iz e^{-z}$$

**Example 9.3.4** Consider  $f(z) = u(x, y) + w(x, y)$ . Show that  $f'(z) = u_x(z, 0) - w_y(z, 0)$ .

$$\begin{aligned} f'(z) &= u_x + w_x \\ &= u_x - w_y \end{aligned}$$

$f'(z)$  is an analytic function. On the real axis,  $z = x$ ,  $f'(z)$  is

$$f'(z = x) = u_x(x, 0) - w_y(x, 0)$$

Now  $f'(z = x)$  is defined on the real line. An analytic continuation of  $f'(z = x)$  into the complex plane is

$$\boxed{f'(z) = u_x(z, 0) - w_y(z, 0).}$$

**Example 9.3.5** Again consider the problem of finding  $f(z)$  given that  $u(x, y) = e^{-x}(x \sin y - y \cos y)$ . Now we can use the result of the previous example to do this problem.

$$\begin{aligned} u_x(x, y) &= \frac{\partial u}{\partial x} = e^{-x} \sin y - x e^{-x} \sin y + y e^{-x} \cos y \\ u_y(x, y) &= \frac{\partial u}{\partial y} = x e^{-x} \cos y + y e^{-x} \sin y - e^{-x} \cos y \end{aligned}$$

$$\begin{aligned}
 f'(z) &= u_x(z, 0) - v u_y(z, 0) \\
 &= 0 - i(z e^{-z} - e^{-z}) \\
 &= i(-z e^{-z} + e^{-z})
 \end{aligned}$$

Integration yields the result

$$f(z) = iz e^{-z} + c$$

**Example 9.3.6** Find  $f(z)$  given that

$$\begin{aligned}
 u(x, y) &= \cos x \cosh^2 y \sin x + \cos x \sin x \sinh^2 y \\
 v(x, y) &= \cos^2 x \cosh y \sinh y - \cosh y \sin^2 x \sinh y
 \end{aligned}$$

$f(z) = u(x, y) + v(x, y)$  is an analytic function. On the real line,  $f(z)$  is

$$\begin{aligned}
 f(z = x) &= u(x, 0) + v(x, 0) \\
 &= \cos x \cosh^2 0 \sin x + \cos x \sin x \sinh^2 0 + i(\cos^2 x \cosh 0 \sinh 0 - \cosh 0 \sin^2 x \sinh 0) \\
 &= \cos x \sin x
 \end{aligned}$$

Now we know the definition of  $f(z)$  on the real line. We would like to find an analytic continuation of  $f(z)$  into the complex plane. An obvious choice for  $f(z)$  is

$$f(z) = \cos z \sin z$$

Using trig identities we can write this as

$$f(z) = \frac{\sin(2z)}{2}.$$

**Example 9.3.7** Find  $f(z)$  given only that

$$u(x, y) = \cos x \cosh^2 y \sin x + \cos x \sin x \sinh^2 y.$$

Recall that

$$\begin{aligned}f'(z) &= u_x + w_x \\ &= u_x - w_y\end{aligned}$$

Differentiating  $u(x, y)$ ,

$$\begin{aligned}u_x &= \cos^2 x \cosh^2 y - \cosh^2 y \sin^2 x + \cos^2 x \sinh^2 y - \sin^2 x \sinh^2 y \\ u_y &= 4 \cos x \cosh y \sin x \sinh y\end{aligned}$$

$f'(z)$  is an analytic function. On the real axis,  $f'(z)$  is

$$f'(z = x) = \cos^2 x - \sin^2 x$$

Using trig identities we can write this as

$$f'(z = x) = \cos(2x)$$

Now we find an analytic continuation of  $f'(z = x)$  into the complex plane.

$$f'(z) = \cos(2z)$$

Integration yields the result

$$f(z) = \frac{\sin(2z)}{2} + c$$

### 9.3.1 Polar Coordinates

**Example 9.3.8** *Is*

$$u(r, \theta) = r(\log r \cos \theta - \theta \sin \theta)$$

*the real part of an analytic function?*

The Laplacian in polar coordinates is

$$\Delta\phi = \frac{1}{r} \frac{\partial}{\partial r} \left( r \frac{\partial\phi}{\partial r} \right) + \frac{1}{r^2} \frac{\partial^2\phi}{\partial\theta^2}.$$

We calculate the partial derivatives of  $u$ .

$$\begin{aligned}\frac{\partial u}{\partial r} &= \cos\theta + \log r \cos\theta - \theta \sin\theta \\ r \frac{\partial u}{\partial r} &= r \cos\theta + r \log r \cos\theta - r\theta \sin\theta \\ \frac{\partial}{\partial r} \left( r \frac{\partial u}{\partial r} \right) &= 2 \cos\theta + \log r \cos\theta - \theta \sin\theta \\ \frac{1}{r} \frac{\partial}{\partial r} \left( r \frac{\partial u}{\partial r} \right) &= \frac{1}{r} (2 \cos\theta + \log r \cos\theta - \theta \sin\theta) \\ \frac{\partial u}{\partial\theta} &= -r (\theta \cos\theta + \sin\theta + \log r \sin\theta) \\ \frac{\partial^2 u}{\partial\theta^2} &= r (-2 \cos\theta - \log r \cos\theta + \theta \sin\theta) \\ \frac{1}{r^2} \frac{\partial^2 u}{\partial\theta^2} &= \frac{1}{r} (-2 \cos\theta - \log r \cos\theta + \theta \sin\theta)\end{aligned}$$

From the above we see that

$$\Delta u = \frac{1}{r} \frac{\partial}{\partial r} \left( r \frac{\partial u}{\partial r} \right) + \frac{1}{r^2} \frac{\partial^2 u}{\partial\theta^2} = 0.$$

Therefore  $u$  is harmonic and is the real part of some analytic function.

**Example 9.3.9** Find an analytic function  $f(z)$  whose real part is

$$u(r, \theta) = r (\log r \cos\theta - \theta \sin\theta).$$

Let  $f(z) = u(r, \theta) + w(r, \theta)$ . The Cauchy-Riemann equations are

$$u_r = \frac{v_\theta}{r}, \quad u_\theta = -rv_r.$$

Using the partial derivatives in the above example, we obtain two partial differential equations for  $v(r, \theta)$ .

$$\begin{aligned} v_r &= -\frac{u_\theta}{r} = \theta \cos \theta + \sin \theta + \log r \sin \theta \\ v_\theta &= rv_r = r(\cos \theta + \log r \cos \theta - \theta \sin \theta) \end{aligned}$$

Integrating the equation for  $v_\theta$  yields

$$v = r(\theta \cos \theta + \log r \sin \theta) + F(r)$$

where  $F(r)$  is a constant of integration.

Substituting our expression for  $v$  into the equation for  $v_r$  yields

$$\begin{aligned} \theta \cos \theta + \log r \sin \theta + \sin \theta + F'(r) &= \theta \cos \theta + \sin \theta + \log r \sin \theta \\ F'(r) &= 0 \\ F(r) &= \text{const} \end{aligned}$$

Thus we see that

$$\begin{aligned} f(z) &= u + w \\ &= r(\log r \cos \theta - \theta \sin \theta) + ir(\theta \cos \theta + \log r \sin \theta) + \text{const} \end{aligned}$$

$f(z)$  is an analytic function. On the line  $\theta = 0$ ,  $f(z)$  is

$$\begin{aligned} f(z = r) &= r(\log r) + ir(0) + \text{const} \\ &= r \log r + \text{const} \end{aligned}$$

The analytic continuation into the complex plane is

$$\boxed{f(z) = z \log z + \text{const}}$$



**Example 9.3.10** Find the formula in polar coordinates that is analogous to

$$f'(z) = u_x(z, 0) - iu_y(z, 0).$$

We know that

$$\frac{df}{dz} = e^{-i\theta} \frac{\partial f}{\partial r}.$$

If  $f(z) = u(r, \theta) + iw(r, \theta)$  then

$$\frac{df}{dz} = e^{-i\theta} (u_r + iw_r)$$

From the Cauchy-Riemann equations, we have  $v_r = -u_\theta/r$ .

$$\frac{df}{dz} = e^{-i\theta} \left( u_r - i \frac{u_\theta}{r} \right)$$

$f'(z)$  is an analytic function. On the line  $\theta = 0$ ,  $f'(z)$  is

$$f'(z = r) = u_r(r, 0) - i \frac{u_\theta(r, 0)}{r}$$

The analytic continuation of  $f'(z)$  into the complex plane is

$$f'(z) = u_r(z, 0) - i \frac{u_\theta(z, 0)}{r}.$$

**Example 9.3.11** Find an analytic function  $f(z)$  whose real part is

$$u(r, \theta) = r (\log r \cos \theta - \theta \sin \theta).$$

$$u_r(r, \theta) = (\log r \cos \theta - \theta \sin \theta) + \cos \theta$$

$$u_\theta(r, \theta) = r (-\log r \sin \theta - \sin \theta - \theta \cos \theta)$$

$$\begin{aligned} f'(z) &= u_r(z, 0) - \frac{i}{r} u_\theta(z, 0) \\ &= \log z + 1 \end{aligned}$$

Integrating  $f'(z)$  yields

$$f(z) = z \log z + ic.$$

### 9.3.2 Analytic Functions Defined in Terms of Their Real or Imaginary Parts

Consider an analytic function:  $f(z) = u(x, y) + v(x, y)$ . We differentiate this expression.

$$f'(z) = u_x(x, y) + v_x(x, y)$$

We apply the Cauchy-Riemann equation  $v_x = -u_y$ .

$$f'(z) = u_x(x, y) - v u_y(x, y). \quad (9.1)$$

Now consider the function of a complex variable,  $g(\zeta)$ :

$$g(\zeta) = u_x(x, \zeta) - v u_y(x, \zeta) = u_x(x, \xi + v\psi) - v u_y(x, \xi + v\psi).$$

This function is analytic where  $f(\zeta)$  is analytic. To show this we first verify that the derivatives in the  $\xi$  and  $\psi$  directions are equal.

$$\begin{aligned} \frac{\partial}{\partial \xi} g(\zeta) &= u_{xy}(x, \xi + v\psi) - v u_{yy}(x, \xi + v\psi) \\ -i \frac{\partial}{\partial \psi} g(\zeta) &= -i (v u_{xy}(x, \xi + v\psi) + u_{yy}(x, \xi + v\psi)) = u_{xy}(x, \xi + v\psi) - v u_{yy}(x, \xi + v\psi) \end{aligned}$$

Since these partial derivatives are equal and continuous,  $g(\zeta)$  is analytic. We evaluate the function  $g(\zeta)$  at  $\zeta = -ix$ . (Substitute  $y = -ix$  into Equation 9.1.)

$$f'(2x) = u_x(x, -ix) - v u_y(x, -ix)$$

We make a change of variables to solve for  $f'(x)$ .

$$f'(x) = u_x\left(\frac{x}{2}, -i\frac{x}{2}\right) - v u_y\left(\frac{x}{2}, -i\frac{x}{2}\right).$$

If the expression is non-singular, then this defines the analytic function,  $f'(z)$ , on the real axis. The analytic continuation to the complex plane is

$$f'(z) = u_x\left(\frac{z}{2}, -i\frac{z}{2}\right) - v u_y\left(\frac{z}{2}, -i\frac{z}{2}\right).$$

Note that  $\frac{d}{dz}2u(z/2, -iz/2) = u_x(z/2, -iz/2) - v u_y(z/2, -iz/2)$ . We integrate the equation to obtain:

$$f(z) = 2u\left(\frac{z}{2}, -i\frac{z}{2}\right) + c.$$

We know that the real part of an analytic function determines that function to within an additive constant. Assuming that the above expression is non-singular, we have found a formula for writing an analytic function in terms of its real part. With the same method, we can find how to write an analytic function in terms of its imaginary part,  $v$ .

We can also derive formulas if  $u$  and  $v$  are expressed in polar coordinates:

$$f(z) = u(r, \theta) + v(r, \theta).$$

**Result 9.3.2** If  $f(z) = u(x, y) + w(x, y)$  is analytic and the expressions are non-singular, then

$$f(z) = 2u\left(\frac{z}{2}, -i\frac{z}{2}\right) + \text{const} \quad (9.2)$$

$$f(z) = i2v\left(\frac{z}{2}, -i\frac{z}{2}\right) + \text{const.} \quad (9.3)$$

If  $f(z) = u(r, \theta) + w(r, \theta)$  is analytic and the expressions are non-singular, then

$$f(z) = 2u\left(z^{1/2}, -\frac{i}{2}\log z\right) + \text{const} \quad (9.4)$$

$$f(z) = i2v\left(z^{1/2}, -\frac{i}{2}\log z\right) + \text{const.} \quad (9.5)$$

**Example 9.3.12** Consider the problem of finding  $f(z)$  given that  $u(x, y) = e^{-x}(x \sin y - y \cos y)$ .

$$\begin{aligned} f(z) &= 2u\left(\frac{z}{2}, -i\frac{z}{2}\right) \\ &= 2e^{-z/2}\left(\frac{z}{2}\sin\left(-i\frac{z}{2}\right) + i\frac{z}{2}\cos\left(-i\frac{z}{2}\right)\right) + c \\ &= iz e^{-z/2}\left(i\sin\left(i\frac{z}{2}\right) + \cos\left(-i\frac{z}{2}\right)\right) + c \\ &= iz e^{-z/2}\left(e^{-z/2}\right) + c \\ &= iz e^{-z} + c \end{aligned}$$

**Example 9.3.13** Consider

$$\text{Log } z = \frac{1}{2}\text{Log}(x^2 + y^2) + i\text{Arctan}(x, y).$$

We try to construct the analytic function from its real part using Equation 9.2.

$$\begin{aligned} f(z) &= 2u\left(\frac{z}{2}, -i\frac{z}{2}\right) + c \\ &= 2\frac{1}{2}\operatorname{Log}\left(\left(\frac{z}{2}\right)^2 + \left(-i\frac{z}{2}\right)^2\right) + c \\ &= \operatorname{Log}(0) + c \end{aligned}$$

We obtain a singular expression, so the method fails.

**Example 9.3.14** Again consider the logarithm, this time written in terms of polar coordinates.

$$\operatorname{Log} z = \operatorname{Log} r + i\theta$$

We try to construct the analytic function from its real part using Equation 9.4.

$$\begin{aligned} f(z) &= 2u\left(z^{1/2}, -i\frac{i}{2}\log z\right) + c \\ &= 2\operatorname{Log}\left(z^{1/2}\right) + c \\ &= \operatorname{Log} z + c \end{aligned}$$

With this method we recover the analytic function.

## 9.4 Exercises

### Exercise 9.1

Consider two functions,  $f(x, y)$  and  $g(x, y)$ . They are said to be functionally dependent if there is a an  $h(g)$  such that

$$f(x, y) = h(g(x, y)).$$

$f$  and  $g$  will be functionally dependent if and only if their Jacobian vanishes.

If  $f$  and  $g$  are functionally dependent, then the derivatives of  $f$  are

$$\begin{aligned}f_x &= h'(g)g_x \\f_y &= h'(g)g_y.\end{aligned}$$

Thus we have

$$\frac{\partial(f, g)}{\partial(x, y)} = \begin{vmatrix} f_x & f_y \\ g_x & g_y \end{vmatrix} = f_x g_y - f_y g_x = h'(g)g_x g_y - h'(g)g_y g_x = 0.$$

If the Jacobian of  $f$  and  $g$  vanishes, then

$$f_x g_y - f_y g_x = 0.$$

This is a first order partial differential equation for  $f$  that has the general solution

$$f(x, y) = h(g(x, y)).$$

Prove that an analytic function  $u(x, y) + v(x, y)$  can be written in terms of a function of a complex variable,  $f(z) = u(x, y) + v(x, y)$ .

### Exercise 9.2

Which of the following functions are the real part of an analytic function? For those that are, find the harmonic conjugate,  $v(x, y)$ , and find the analytic function  $f(z) = u(x, y) + v(x, y)$  as a function of  $z$ .

1.  $x^3 - 3xy^2 - 2xy + y$
2.  $e^x \sinh y$

3.  $e^x (\sin x \cos y \cosh y - \cos x \sin y \sinh y)$

**Exercise 9.3**

For an analytic function,  $f(z) = u(r, \theta) + iv(r, \theta)$  prove that under suitable restrictions:

$$f(z) = 2u \left( z^{1/2}, -\frac{i}{2} \log z \right) + \text{const.}$$

## 9.5 Hints

### Hint 9.1

Show that  $u(x, y) + w(x, y)$  is functionally dependent on  $x + iy$  so that you can write  $f(z) = f(x + iy) = u(x, y) + w(x, y)$ .

### Hint 9.2

### Hint 9.3

Check out the derivation of Equation 9.2.



## 9.6 Solutions

### Solution 9.1

$u(x, y) + v(x, y)$  is functionally dependent on  $z = x + iy$  if and only if

$$\frac{\partial(u + v, x + iy)}{\partial(x, y)} = 0.$$

$$\begin{aligned}\frac{\partial(u + v, x + iy)}{\partial(x, y)} &= \begin{vmatrix} u_x + v_x & u_y + v_y \\ 1 & i \end{vmatrix} \\ &= -v_x - u_y + i(u_x - v_y)\end{aligned}$$

Since  $u$  and  $v$  satisfy the Cauchy-Riemann equations, this vanishes.

$$= 0$$

Thus we see that  $u(x, y) + v(x, y)$  is functionally dependent on  $x + iy$  so we can write

$$f(z) = f(x + iy) = u(x, y) + v(x, y).$$

### Solution 9.2

1. Consider  $u(x, y) = x^3 - 3xy^2 - 2xy + y$ . The Laplacian of this function is

$$\begin{aligned}\Delta u &\equiv u_{xx} + u_{yy} \\ &= 6x - 6x \\ &= 0\end{aligned}$$

Since the function is harmonic, it is the real part of an analytic function. Clearly the analytic function is of the form,

$$az^3 + bz^2 + cz + id,$$

with  $a$ ,  $b$  and  $c$  complex-valued constants and  $d$  a real constant. Substituting  $z = x + iy$  and expanding products yields,

$$a(x^3 + i3x^2y - 3xy^2 - iy^3) + b(x^2 + i2xy - y^2) + c(x + iy) + id.$$

By inspection, we see that the analytic function is

$$f(z) = z^3 + iz^2 - iz + id.$$

The harmonic conjugate of  $u$  is the imaginary part of  $f(z)$ ,

$$v(x, y) = 3x^2y - y^3 + x^2 - y^2 - x + d.$$

We can also do this problem with analytic continuation. The derivatives of  $u$  are

$$\begin{aligned}u_x &= 3x^2 - 3y^2 - 2y, \\u_y &= -6xy - 2x + 1.\end{aligned}$$

The derivative of  $f(z)$  is

$$f'(z) = u_x - iu_y = 3x^2 - 2y^2 - 2y + i(6xy - 2x + 1).$$

On the real axis we have

$$f'(z = x) = 3x^2 - i2x + i.$$

Using analytic continuation, we see that

$$f'(z) = 3z^2 - i2z + i.$$

Integration yields

$$f(z) = z^3 - iz^2 + iz + \text{const}$$

2. Consider  $u(x, y) = e^x \sinh y$ . The Laplacian of this function is

$$\begin{aligned}\Delta u &= e^x \sinh y + e^x \sinh y \\ &= 2e^x \sinh y.\end{aligned}$$

Since the function is not harmonic, it is not the real part of an analytic function.

3. Consider  $u(x, y) = e^x(\sin x \cos y \cosh y - \cos x \sin y \sinh y)$ . The Laplacian of the function is

$$\begin{aligned}\Delta u &= \frac{\partial}{\partial x} (e^x (\sin x \cos y \cosh y - \cos x \sin y \sinh y + \cos x \cos y \cosh y + \sin x \sin y \sinh y)) \\ &\quad + \frac{\partial}{\partial y} (e^x (-\sin x \sin y \cosh y - \cos x \cos y \sinh y + \sin x \cos y \sinh y - \cos x \sin y \cosh y)) \\ &= 2e^x (\cos x \cos y \cosh y + \sin x \sin y \sinh y) - 2e^x (\cos x \cos y \cosh y + \sin x \sin y \sinh y) \\ &= 0.\end{aligned}$$

Thus  $u$  is the real part of an analytic function. The derivative of the analytic function is

$$f'(z) = u_x + v_x = u_x - v u_y$$

From the derivatives of  $u$  we computed before, we have

$$\begin{aligned}f(z) &= (e^x (\sin x \cos y \cosh y - \cos x \sin y \sinh y + \cos x \cos y \cosh y + \sin x \sin y \sinh y)) \\ &\quad - i (e^x (-\sin x \sin y \cosh y - \cos x \cos y \sinh y + \sin x \cos y \sinh y - \cos x \sin y \cosh y))\end{aligned}$$

Along the real axis,  $f'(z)$  has the value,

$$f'(z = x) = e^x (\sin x + \cos x).$$

By analytic continuation,  $f'(z)$  is

$$f'(z) = e^z (\sin z + \cos z)$$

We obtain  $f(z)$  by integrating.

$$f(z) = e^z \sin z + \text{const.}$$

$u$  is the real part of the analytic function

$$f(z) = e^z \sin z + ic,$$

where  $c$  is a real constant. We find the harmonic conjugate of  $u$  by taking the imaginary part of  $f$ .

$$f(z) = e^x(\cos y + i \sin y)(\sin x \cosh y + i \cos x \sinh y) + ic$$

$$v(x, y) = e^x \sin x \sin y \cosh y + \cos x \cos y \sinh y + c$$

### Solution 9.3

We consider the analytic function:  $f(z) = u(r, \theta) + w(r, \theta)$ . Recall that the complex derivative in terms of polar coordinates is

$$\frac{d}{dz} = e^{-i\theta} \frac{\partial}{\partial r} = -\frac{i}{r} e^{-i\theta} \frac{\partial}{\partial \theta}.$$

The Cauchy-Riemann equations are

$$u_r = \frac{1}{r} v_\theta, \quad v_r = -\frac{1}{r} u_\theta.$$

We differentiate  $f(z)$  and use the partial derivative in  $r$  for the right side.

$$f'(z) = e^{-i\theta} (u_r + i v_r)$$

We use the Cauchy-Riemann equations to right  $f'(z)$  in terms of the derivatives of  $u$ .

$$f'(z) = e^{-i\theta} \left( u_r - i \frac{1}{r} u_\theta \right) \tag{9.6}$$

Now consider the function of a complex variable,  $g(\zeta)$ :

$$g(\zeta) = e^{-i\zeta} \left( u_r(r, \zeta) - i \frac{1}{r} u_\theta(r, \zeta) \right) = e^{\psi - i\xi} \left( u_r(r, \xi + i\psi) - i \frac{1}{r} u_\theta(r, \xi + i\psi) \right)$$

This function is analytic where  $f(\zeta)$  is analytic. It is a simple calculus exercise to show that the complex derivative in the  $\xi$  direction,  $\frac{\partial}{\partial \xi}$ , and the complex derivative in the  $\psi$  direction,  $-i\frac{\partial}{\partial \psi}$ , are equal. Since these partial derivatives are equal and continuous,  $g(\zeta)$  is analytic. We evaluate the function  $g(\zeta)$  at  $\zeta = -i \log r$ . (Substitute  $\theta = -i \log r$  into Equation 9.6.)

$$f'(r e^{i(-i \log r)}) = e^{-i(-i \log r)} \left( u_r(r, -i \log r) - i \frac{1}{r} u_\theta(r, -i \log r) \right)$$

$$r f'(r^2) = u_r(r, -i \log r) - i \frac{1}{r} u_\theta(r, -i \log r)$$

If the expression is non-singular, then it defines the analytic function,  $f'(z)$ , on a curve. The analytic continuation to the complex plane is

$$z f'(z^2) = u_r(z, -i \log z) - i \frac{1}{z} u_\theta(z, -i \log z).$$

We integrate to obtain an expression for  $f(z^2)$ .

$$\frac{1}{2} f(z^2) = u(z, -i \log z) + \text{const}$$

We make a change of variables and solve for  $f(z)$ .

$$f(z) = 2u\left(z^{1/2}, -\frac{i}{2} \log z\right) + \text{const.}$$

Assuming that the above expression is non-singular, we have found a formula for writing the analytic function in terms of its real part,  $u(r, \theta)$ . With the same method, we can find how to write an analytic function in terms of its imaginary part,  $v(r, \theta)$ .

# Chapter 10

## Contour Integration and the Cauchy-Goursat Theorem

Between two evils, I always pick the one I never tried before.

- Mae West

### 10.1 Line Integrals

In this section we will recall the definition of a line integral in the Cartesian plane. In the next section we will use this to define the contour integral in the complex plane.

**Limit Sum Definition.** First we develop a limit sum definition of a line integral. Consider a curve  $C$  in the Cartesian plane joining the points  $(a_0, b_0)$  and  $(a_1, b_1)$ . We partition the curve into  $n$  segments with the points  $(x_0, y_0), \dots, (x_n, y_n)$  where the first and last points are at the endpoints of the curve. We define the differences,  $\Delta x_k = x_{k+1} - x_k$  and  $\Delta y_k = y_{k+1} - y_k$ , and let  $(\xi_k, \psi_k)$  be points on the curve between  $(x_k, y_k)$  and  $(x_{k+1}, y_{k+1})$ . This is shown pictorially in Figure 10.1.

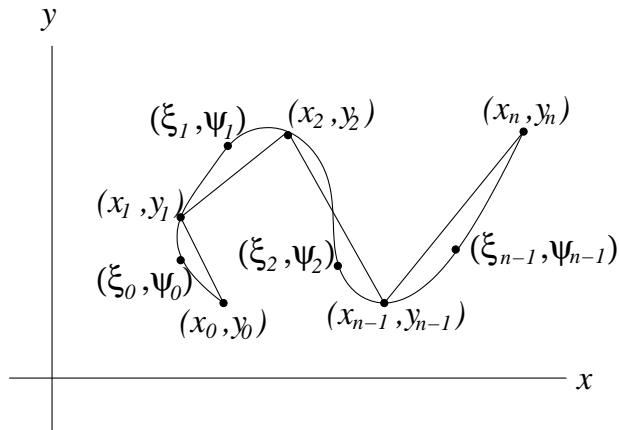

Figure 10.1: A curve in the Cartesian plane.

Consider the sum

$$\sum_{k=0}^{n-1} (P(\xi_k, \psi_k) \Delta x_k + Q(\xi_k, \psi_k) \Delta y_k),$$

where  $P$  and  $Q$  are continuous functions on the curve. ( $P$  and  $Q$  may be complex-valued.) In the limit as each of the  $\Delta x_k$  and  $\Delta y_k$  approach zero the value of the sum, (if the limit exists), is denoted by

$$\int_C P(x, y) dx + Q(x, y) dy.$$

This is a *line integral* along the curve  $C$ . The value of the line integral depends on the functions  $P(x, y)$  and  $Q(x, y)$ , the endpoints of the curve and the curve  $C$ . We can also write a line integral in vector notation.

$$\int_C \mathbf{f}(\mathbf{x}) \cdot d\mathbf{x}$$

Here  $\mathbf{x} = (x, y)$  and  $\mathbf{f}(\mathbf{x}) = (P(x, y), Q(x, y))$ .

**Evaluating Line Integrals with Parameterization.** Let the curve  $C$  be parametrized by  $x = x(t)$ ,  $y = y(t)$  for  $t_0 \leq t \leq t_1$ . Then the differentials on the curve are  $dx = x'(t) dt$  and  $dy = y'(t) dt$ . Using the parameterization we can evaluate a line integral in terms of a definite integral.

$$\int_C P(x, y) dx + Q(x, y) dy = \int_{t_0}^{t_1} (P(x(t), y(t))x'(t) + Q(x(t), y(t))y'(t)) dt$$

**Example 10.1.1** Consider the line integral

$$\int_C x^2 dx + (x + y) dy,$$

where  $C$  is the semi-circle from  $(1, 0)$  to  $(-1, 0)$  in the upper half plane. We parameterize the curve with  $x = \cos t$ ,  $y = \sin t$  for  $0 \leq t \leq \pi$ .

$$\begin{aligned} \int_C x^2 dx + (x + y) dy &= \int_0^\pi (\cos^2 t(-\sin t) + (\cos t + \sin t) \cos t) dt \\ &= \frac{\pi}{2} - \frac{2}{3} \end{aligned}$$

## 10.2 Contour Integrals

**Limit Sum Definition.** We develop a limit sum definition for contour integrals. It will be analogous to the definition for line integrals except that the notation is cleaner in complex variables. Consider a contour  $C$  in the complex plane joining the points  $c_0$  and  $c_1$ . We partition the contour into  $n$  segments with the points  $z_0, \dots, z_n$  where the first and last points are at the endpoints of the contour. We define the differences  $\Delta z_k = z_{k+1} - z_k$  and let  $\zeta_k$  be points on the contour between  $z_k$  and  $z_{k+1}$ . Consider the sum

$$\sum_{k=0}^{n-1} f(\zeta_k) \Delta z_k,$$



where  $f$  is a continuous function on the contour. In the limit as each of the  $\Delta z_k$  approach zero the value of the sum, (if the limit exists), is denoted by

$$\int_C f(z) dz.$$

This is a *contour integral* along  $C$ .

We can write a contour integral in terms of a line integral. Let  $f(z) = \phi(x, y)$ . ( $\phi : \mathbb{R}^2 \mapsto \mathbb{C}$ .)

$$\begin{aligned} \int_C f(z) dz &= \int_C \phi(x, y)(dx + i dy) \\ \int_C f(z) dz &= \int_C (\phi(x, y) dx + i\phi(x, y) dy) \end{aligned} \quad (10.1)$$

Further, we can write a contour integral in terms of two real-valued line integrals. Let  $f(z) = u(x, y) + v(x, y)i$ .

$$\begin{aligned} \int_C f(z) dz &= \int_C (u(x, y) + v(x, y)i)(dx + i dy) \\ \int_C f(z) dz &= \int_C (u(x, y) dx - v(x, y) dy) + i \int_C (v(x, y) dx + u(x, y) dy) \end{aligned} \quad (10.2)$$

**Evaluation.** Let the contour  $C$  be parametrized by  $z = z(t)$  for  $t_0 \leq t \leq t_1$ . Then the differential on the contour is  $dz = z'(t) dt$ . Using the parameterization we can evaluate a contour integral in terms of a definite integral.

$$\int_C f(z) dz = \int_{t_0}^{t_1} f(z(t))z'(t) dt$$

**Example 10.2.1** Let  $C$  be the positively oriented unit circle about the origin in the complex plane. Evaluate:

1.  $\int_C z dz$
2.  $\int_C \frac{1}{z} dz$
3.  $\int_C \frac{1}{z} |dz|$

In each case we parameterize the contour and then do the integral.

1.

$$z = e^{i\theta}, \quad dz = i e^{i\theta} d\theta$$

$$\begin{aligned} \int_C z dz &= \int_0^{2\pi} e^{i\theta} i e^{i\theta} d\theta \\ &= \left[ \frac{1}{2} e^{i2\theta} \right]_0^{2\pi} \\ &= \left( \frac{1}{2} e^{i4\pi} - \frac{1}{2} e^{i0} \right) \\ &= 0 \end{aligned}$$

2.

$$\int_C \frac{1}{z} dz = \int_0^{2\pi} \frac{1}{e^{i\theta}} i e^{i\theta} d\theta = i \int_0^{2\pi} d\theta = i2\pi$$

3.

$$|dz| = |i e^{i\theta} d\theta| = |i e^{i\theta}| |d\theta| = |d\theta|$$

Since  $d\theta$  is positive in this case,  $|d\theta| = d\theta$ .

$$\int_C \frac{1}{z} |dz| = \int_0^{2\pi} \frac{1}{e^{i\theta}} d\theta = [i e^{-i\theta}]_0^{2\pi} = 0$$

### 10.2.1 Maximum Modulus Integral Bound

The absolute value of a real integral obeys the inequality

$$\left| \int_a^b f(x) dx \right| \leq \int_a^b |f(x)| |dx| \leq (b - a) \max_{a \leq x \leq b} |f(x)|.$$

Now we prove the analogous result for the modulus of a contour integral.

$$\begin{aligned}
 \left| \int_C f(z) \, dz \right| &= \left| \lim_{\Delta z \rightarrow 0} \sum_{k=0}^{n-1} f(\zeta_k) \Delta z_k \right| \\
 &\leq \lim_{\Delta z \rightarrow 0} \sum_{k=0}^{n-1} |f(\zeta_k)| |\Delta z_k| \\
 &= \int_C |f(z)| \, |dz| \\
 &\leq \int_C \left( \max_{z \in C} |f(z)| \right) |dz| \\
 &= \left( \max_{z \in C} |f(z)| \right) \int_C |dz| \\
 &= \left( \max_{z \in C} |f(z)| \right) \times (\text{length of } C)
 \end{aligned}$$

**Result 10.2.1 Maximum Modulus Integral Bound.**

$$\left| \int_C f(z) \, dz \right| \leq \int_C |f(z)| \, |dz| \leq \left( \max_{z \in C} |f(z)| \right) (\text{length of } C)$$

### 10.3 The Cauchy-Goursat Theorem

Let  $f(z)$  be analytic in a compact, closed, connected domain  $D$ . We consider the integral of  $f(z)$  on the boundary of the domain.

$$\int_{\partial D} f(z) \, dz = \int_{\partial D} \psi(x, y)(dx + i \, dy) = \int_{\partial D} \psi \, dx + i\psi \, dy$$

Recall Green's Theorem.

$$\int_{\partial D} P dx + Q dy = \int_D (Q_x - P_y) dx dy$$

If we assume that  $f'(z)$  is continuous, we can apply Green's Theorem to the integral of  $f(z)$  on  $\partial D$ .

$$\int_{\partial D} f(z) dz = \int_{\partial D} \psi dx + v\psi dy = \int_D (v\psi_x - \psi_y) dx dy$$

Since  $f(z)$  is analytic, it satisfies the Cauchy-Riemann equation  $\psi_x = -v\psi_y$ . The integrand in the area integral,  $v\psi_x - \psi_y$ , is zero. Thus the contour integral vanishes.

$$\int_{\partial D} f(z) dz = 0$$

This is known as *Cauchy's Theorem*. The assumption that  $f'(z)$  is continuous is not necessary, but it makes the proof much simpler because we can use Green's Theorem. If we remove this restriction the result is known as the *Cauchy-Goursat Theorem*. The proof of this result is omitted.

**Result 10.3.1 The Cauchy-Goursat Theorem.** If  $f(z)$  is analytic in a compact, closed, connected domain  $D$  then the integral of  $f(z)$  on the boundary of the domain vanishes.

$$\oint_{\partial D} f(z) dz = \sum_k \oint_{C_k} f(z) dz = 0$$

Here the set of contours  $\{C_k\}$  make up the positively oriented boundary  $\partial D$  of the domain  $D$ .

As a special case of the Cauchy-Goursat theorem we can consider a simply-connected region. For this the boundary is a Jordan curve. We can state the theorem in terms of this curve instead of referring to the boundary.

**Result 10.3.2 The Cauchy-Goursat Theorem for Jordan Curves.** If  $f(z)$  is analytic inside and on a simple, closed contour  $C$ , then

$$\oint_C f(z) dz = 0$$

**Example 10.3.1** Let  $C$  be the unit circle about the origin with positive orientation. In Example 10.2.1 we calculated that

$$\int_C z dz = 0$$

Now we can evaluate the integral without parameterizing the curve. We simply note that the integrand is analytic inside and on the circle, which is simple and closed. By the Cauchy-Goursat Theorem, the integral vanishes.

We cannot apply the Cauchy-Goursat theorem to evaluate

$$\int_C \frac{1}{z} dz = i2\pi$$

as the integrand is not analytic at  $z = 0$ .

**Example 10.3.2** Consider the domain  $D = \{z \mid |z| > 1\}$ . The boundary of the domain is the unit circle with negative orientation.  $f(z) = 1/z$  is analytic on  $D$  and its boundary. However  $\int_{\partial D} f(z) dz$  does not vanish and we cannot apply the Cauchy-Goursat Theorem. This is because the domain is not compact.

## 10.4 Contour Deformation

**Path Independence.** Consider a function  $f(z)$  that is analytic on a simply connected domain a contour  $C$  in that domain with end points  $a$  and  $b$ . The contour integral  $\int_C f(z) dz$  is independent of the path connecting the end points and can be denoted  $\int_a^b f(z) dz$ . This result is a direct consequence of the Cauchy-Goursat Theorem. Let  $C_1$  and  $C_2$  be two different paths connecting the points. Let  $-C_2$  denote the second contour with the opposite orientation. Let

$C$  be the contour which is the union of  $C_1$  and  $-C_2$ . By the Cauchy-Goursat theorem, the integral along this contour vanishes.

$$\int_C f(z) dz = \int_{C_1} f(z) dz + \int_{-C_2} f(z) dz = 0$$

This implies that the integrals along  $C_1$  and  $C_2$  are equal.

$$\int_{C_1} f(z) dz = \int_{C_2} f(z) dz$$

Thus contour integrals on simply connected domains are independent of path. This result does not hold for multiply connected domains.

**Result 10.4.1 Path Independence.** Let  $f(z)$  be analytic on a simply connected domain. For points  $a$  and  $b$  in the domain, the contour integral,

$$\int_a^b f(z) dz$$

is independent of the path connecting the points.

**Deforming Contours.** Consider two simple, closed, positively oriented contours,  $C_1$  and  $C_2$ . Let  $C_2$  lie completely within  $C_1$ . If  $f(z)$  is analytic on and between  $C_1$  and  $C_2$  then the integrals of  $f(z)$  along  $C_1$  and  $C_2$  are equal.

$$\int_{C_1} f(z) dz = \int_{C_2} f(z) dz$$

Again, this is a direct consequence of the Cauchy-Goursat Theorem. Let  $D$  be the domain on and between  $C_1$  and  $C_2$ . By the Cauchy-Goursat Theorem the integral along the boundary of  $D$  vanishes.

$$\int_{C_1} f(z) dz + \int_{-C_2} f(z) dz = 0$$

$$\int_{C_1} f(z) dz = \int_{C_2} f(z) dz$$

By following this line of reasoning, we see that we can deform a contour  $C$  without changing the value of  $\int_C f(z) dz$  as long as we stay on the domain where  $f(z)$  is analytic.

**Result 10.4.2 Contour Deformation.** Let  $f(z)$  be analytic on a domain  $D$ . If a set of closed contours  $\{C_m\}$  can be continuously deformed on the domain  $D$  to a set of contours  $\{\Gamma_n\}$  then the integrals along  $\{C_m\}$  and  $\{\Gamma_n\}$  are equal.

$$\int_{\{C_m\}} f(z) dz = \int_{\{\Gamma_n\}} f(z) dz$$

## 10.5 Morera's Theorem.

The converse of the Cauchy-Goursat theorem is Morera's Theorem. If the integrals of a continuous function  $f(z)$  vanish along all possible simple, closed contours in a domain, then  $f(z)$  is analytic on that domain. To prove Morera's Theorem we will assume that first partial derivatives of  $f(z) = u(x, y) + w(x, y)$  are continuous, although the result can be derived without this restriction. Let the simple, closed contour  $C$  be the boundary of  $D$  which is contained in

the domain  $\Omega$ .

$$\begin{aligned}
 \oint_C f(z) dz &= \oint_C (u + iv)(dx + i dy) \\
 &= \oint_C u dx - v dy + i \oint_C v dx + u dy \\
 &= \int_D (-v_x - u_y) dx dy + i \int_D (u_x - v_y) dx dy \\
 &= 0
 \end{aligned}$$

Since the two integrands are continuous and vanish for all  $C$  in  $\Omega$ , we conclude that the integrands are identically zero. This implies that the Cauchy-Riemann equations,

$$u_x = v_y, \quad u_y = -v_x,$$

are satisfied.  $f(z)$  is analytic in  $\Omega$ .

The converse of the Cauchy-Goursat theorem is Morera's Theorem. If the integrals of a continuous function  $f(z)$  vanish along all possible simple, closed contours in a domain, then  $f(z)$  is analytic on that domain. To prove Morera's Theorem we will assume that first partial derivatives of  $f(z) = \phi(x, y)$  are continuous, although the result can be derived without this restriction. Let the simple, closed contour  $C$  be the boundary of  $D$  which is contained in the domain  $\Omega$ .

$$\begin{aligned}
 \oint_C f(z) dz &= \oint_C (\phi dx + i\phi dy) \\
 &= \int_D (i\phi_x - \phi_y) dx dy \\
 &= 0
 \end{aligned}$$

Since the integrand,  $i\phi_x - \phi_y$  is continuous and vanishes for all  $C$  in  $\Omega$ , we conclude that the integrand is identically zero. This implies that the Cauchy-Riemann equation,

$$\phi_x = -i\phi_y,$$



is satisfied. We conclude that  $f(z)$  is analytic in  $\Omega$ .

**Result 10.5.1 Morera's Theorem.** If  $f(z)$  is continuous in a simply connected domain  $\Omega$  and

$$\oint_C f(z) dz = 0$$

for all possible simple, closed contours  $C$  in the domain, then  $f(z)$  is analytic in  $\Omega$ .

## 10.6 Indefinite Integrals

Consider a function  $f(z)$  which is analytic in a domain  $D$ . An *anti-derivative* or *indefinite integral* (or simply *integral*) is a function  $F(z)$  which satisfies  $F'(z) = f(z)$ . This integral exists and is unique up to an additive constant. Note that if the domain is not connected, then the additive constants in each connected component are independent. The indefinite integrals are denoted:

$$\int f(z) dz = F(z) + c.$$

We will prove existence later by writing an indefinite integral as a contour integral. We briefly consider uniqueness of the indefinite integral here. Let  $F(z)$  and  $G(z)$  be integrals of  $f(z)$ . Then  $F'(z) - G'(z) = f(z) - f(z) = 0$ . Although we do not prove it, it certainly makes sense that  $F(z) - G(z)$  is a constant on each connected component of the domain. Indefinite integrals are unique up to an additive constant.

Integrals of analytic functions have all the nice properties of integrals of functions of a real variable. All the formulas from integral tables, including things like integration by parts, carry over directly.

## 10.7 Fundamental Theorem of Calculus via Primitives

### 10.7.1 Line Integrals and Primitives

Here we review some concepts from vector calculus. Analogous to an integral in functions of a single variable is a *primitive* in functions of several variables. Consider a function  $f(x)$ .  $F(x)$  is an integral of  $f(x)$  if and only if  $dF = f dx$ . Now we move to functions of  $x$  and  $y$ . Let  $P(x, y)$  and  $Q(x, y)$  be defined on a simply connected domain. A primitive  $\Phi$  satisfies

$$d\Phi = P dx + Q dy.$$

A necessary and sufficient condition for the existence of a primitive is that  $P_y = Q_x$ . The definite integral can be evaluated in terms of the primitive.

$$\int_{(a,b)}^{(c,d)} P dx + Q dy = \Phi(c, d) - \Phi(a, b)$$

### 10.7.2 Contour Integrals

Now consider integral along the contour  $C$  of the function  $f(z) = \phi(x, y)$ .

$$\int_C f(z) dz = \int_C (\phi dx + \imath\phi dy)$$

A primitive  $\Phi$  of  $\phi dx + \imath\phi dy$  exists if and only if  $\phi_y = \imath\phi_x$ . We recognize this as the Cauchy-Riemann equation,  $\phi_x = -\imath\phi_y$ . Thus a primitive exists if and only if  $f(z)$  is analytic. If so, then

$$d\Phi = \phi dx + \imath\phi dy.$$

How do we find the primitive  $\Phi$  that satisfies  $\Phi_x = \phi$  and  $\Phi_y = \imath\phi$ ? Note that choosing  $\Psi(x, y) = F(z)$  where  $F(z)$  is an anti-derivative of  $f(z)$ ,  $F'(z) = f(z)$ , does the trick. We express the complex derivative as partial derivatives in the coordinate directions to show this.

$$F'(z) = f(z) = \psi(x, y), \quad F'(z) = \Phi_x = -\imath\Phi_y$$

From this we see that  $\Phi_x = \phi$  and  $\Phi_y = \iota\phi$  so  $\Phi(x, y) = F(z)$  is a primitive. Since we can evaluate the line integral of  $(\phi dx + \iota\phi dy)$ ,

$$\int_{(a,b)}^{(c,d)} (\phi dx + \iota\phi dy) = \Phi(c, d) - \Phi(a, b),$$

We can evaluate a definite integral of  $f$  in terms of its indefinite integral,  $F$ .

$$\int_a^b f(z) dz = F(b) - F(a)$$

This is the *Fundamental Theorem of Calculus* for functions of a complex variable.

## 10.8 Fundamental Theorem of Calculus via Complex Calculus

**Result 10.8.1 Constructing an Indefinite Integral.** If  $f(z)$  is analytic in a simply connected domain  $D$  and  $a$  is a point in the domain, then

$$F(z) = \int_a^z f(\zeta) d\zeta$$

is analytic in  $D$  and is an indefinite integral of  $f(z)$ , ( $F'(z) = f(z)$ ).

Now we consider anti-derivatives and definite integrals without using vector calculus. From real variables we know that we can construct an integral of  $f(x)$  with a definite integral.

$$F(x) = \int_a^x f(\xi) d\xi$$

Now we will prove the analogous property for functions of a complex variable.

$$F(z) = \int_a^z f(\zeta) d\zeta$$

Let  $f(z)$  be analytic in a simply connected domain  $D$  and let  $a$  be a point in the domain. To show that  $F(z) = \int_a^z f(\zeta) d\zeta$  is an integral of  $f(z)$ , we apply the limit definition of differentiation.

$$\begin{aligned} F'(z) &= \lim_{\Delta z \rightarrow 0} \frac{F(z + \Delta z) - F(z)}{\Delta z} \\ &= \lim_{\Delta z \rightarrow 0} \frac{1}{\Delta z} \left( \int_a^{z+\Delta z} f(\zeta) d\zeta - \int_a^z f(\zeta) d\zeta \right) \\ &= \lim_{\Delta z \rightarrow 0} \frac{1}{\Delta z} \int_z^{z+\Delta z} f(\zeta) d\zeta \end{aligned}$$

The integral is independent of path. We choose a straight line connecting  $z$  and  $z + \Delta z$ . We add and subtract  $\Delta z f(z) = \int_z^{z+\Delta z} f(z) d\zeta$  from the expression for  $F'(z)$ .

$$\begin{aligned} F'(z) &= \lim_{\Delta z \rightarrow 0} \frac{1}{\Delta z} \left( \Delta z f(z) + \int_z^{z+\Delta z} (f(\zeta) - f(z)) d\zeta \right) \\ &= f(z) + \lim_{\Delta z \rightarrow 0} \frac{1}{\Delta z} \int_z^{z+\Delta z} (f(\zeta) - f(z)) d\zeta \end{aligned}$$

Since  $f(z)$  is analytic, it is certainly continuous. This means that

$$\lim_{\zeta \rightarrow z} f(\zeta) = f(z).$$

The limit term vanishes as a result of this continuity.

$$\begin{aligned} \lim_{\Delta z \rightarrow 0} \left| \frac{1}{\Delta z} \int_z^{z+\Delta z} (f(\zeta) - f(z)) d\zeta \right| &\leq \lim_{\Delta z \rightarrow 0} \frac{1}{|\Delta z|} |\Delta z| \max_{\zeta \in [z, z+\Delta z]} |f(\zeta) - f(z)| \\ &= \lim_{\Delta z \rightarrow 0} \max_{\zeta \in [z, z+\Delta z]} |f(\zeta) - f(z)| \\ &= 0 \end{aligned}$$

Thus  $F'(z) = f(z)$ .

This result demonstrates the existence of the indefinite integral. We will use this to prove the Fundamental Theorem of Calculus for functions of a complex variable.

**Result 10.8.2 Fundamental Theorem of Calculus.** If  $f(z)$  is analytic in a simply connected domain  $D$  then

$$\int_a^b f(z) dz = F(b) - F(a)$$

where  $F(z)$  is any indefinite integral of  $f(z)$ .

From Result 10.8.1 we know that

$$\int_a^b f(z) dz = F(b) + c.$$

(Here we are considering  $b$  to be a variable.) The case  $b = a$  determines the constant.

$$\begin{aligned} \int_a^a f(z) dz &= F(a) + c = 0 \\ c &= -F(a) \end{aligned}$$

This proves the Fundamental Theorem of Calculus for functions of a complex variable.

**Example 10.8.1** Consider the integral

$$\int_C \frac{1}{z-a} dz$$

where  $C$  is any closed contour that goes around the point  $z = a$  once in the positive direction. We use the Fundamental Theorem of Calculus to evaluate the integral. We start at a point on the contour  $z - a = r e^{i\theta}$ . When we traverse the contour once in the positive direction we end at the point  $z - a = r e^{i(\theta+2\pi)}$ .

$$\begin{aligned} \int_C \frac{1}{z-a} dz &= [\log(z-a)]_{z-a=r e^{i\theta}}^{z-a=r e^{i(\theta+2\pi)}} \\ &= \text{Log } r + i(\theta + 2\pi) - (\text{Log } r + i\theta) \\ &= i2\pi \end{aligned}$$

## 10.9 Exercises

### Exercise 10.1

$C$  is the arc corresponding to the unit semi-circle,  $|z| = 1$ ,  $\Im(z) \geq 0$ , directed from  $z = -1$  to  $z = 1$ . Evaluate

1.  $\int_C z^2 dz$

2.  $\int_C |z^2| dz$

3.  $\int_C z^2 |dz|$

4.  $\int_C |z^2| |dz|$

Hint, Solution

### Exercise 10.2

Evaluate

$$\int_{-\infty}^{\infty} e^{-(ax^2+bx)} dx,$$

where  $a, b \in \mathbb{C}$  and  $\Re(a) > 0$ . Use the fact that

$$\int_{-\infty}^{\infty} e^{-x^2} dx = \sqrt{\pi}.$$

Hint, Solution

### Exercise 10.3

Evaluate

$$2 \int_0^{\infty} e^{-ax^2} \cos(\omega x) dx, \quad \text{and} \quad 2 \int_0^{\infty} x e^{-ax^2} \sin(\omega x) dx,$$

where  $\Re(a) > 0$  and  $\omega \in \mathbb{R}$ .

**Hint, Solution**

### Exercise 10.4

Use an admissible parameterization to evaluate

$$\int_C (z - z_0)^n dz, \quad n \in \mathbb{Z}$$

for the following cases:

1.  $C$  is the circle  $|z - z_0| = 1$  traversed in the counterclockwise direction.
2.  $C$  is the circle  $|z - z_0 - i2| = 1$  traversed in the counterclockwise direction.
3.  $z_0 = 0$ ,  $n = -1$  and  $C$  is the closed contour defined by the polar equation

$$r = 2 - \sin^2\left(\frac{\theta}{4}\right)$$

Is this result compatible with the results of part (a)?

**Hint, Solution**

### Exercise 10.5

1. Use bounding arguments to show that

$$\lim_{R \rightarrow \infty} \int_{C_R} \frac{z + \operatorname{Log} z}{z^3 + 1} dz = 0$$

where  $C_R$  is the positive closed contour  $|z| = R$ .

2. Place a bound on

$$\left| \int_C \operatorname{Log} z dz \right|$$

where  $C$  is the arc of the circle  $|z| = 2$  from  $-i2$  to  $i2$ .

3. Deduce that

$$\left| \int_C \frac{z^2 - 1}{z^2 + 1} dz \right| \leq \pi r \frac{R^2 + 1}{R^2 - 1}$$

where  $C$  is a semicircle of radius  $R > 1$  centered at the origin.

Hint, Solution

### Exercise 10.6

Let  $C$  denote the entire positively oriented boundary of the half disk  $0 \leq r \leq 1$ ,  $0 \leq \theta \leq \pi$  in the upper half plane. Consider the branch

$$f(z) = \sqrt{r} e^{i\theta/2}, \quad -\frac{\pi}{2} < \theta < \frac{3\pi}{2}$$

of the multi-valued function  $z^{1/2}$ . Show by separate parametric evaluation of the semi-circle and the two radii constituting the boundary that

$$\int_C f(z) dz = 0.$$

Does the Cauchy-Goursat theorem apply here?

Hint, Solution

### Exercise 10.7

Evaluate the following contour integrals using anti-derivatives and justify your approach for each.

1.

$$\int_C (iz^3 + z^{-3}) dz,$$

where  $C$  is the line segment from  $z_1 = 1 + i$  to  $z_2 = i$ .

2.

$$\int_C \sin^2 z \cos z dz$$

where  $C$  is a right-handed spiral from  $z_1 = \pi$  to  $z_2 = i\pi$ .



3.

$$\int_C z^i dz = \frac{1 + e^{-\pi}}{2}(1 - i)$$

with

$$z^i = e^{i \operatorname{Log} z}, \quad -\pi < \operatorname{Arg} z < \pi.$$

$C$  joins  $z_1 = -1$  and  $z_2 = 1$ , lying above the real axis except at the end points. (Hint: redefine  $z^i$  so that it remains unchanged above the real axis and is defined continuously on the real axis.)

Hint, Solution

## 10.10 Hints

### Hint 10.1

### Hint 10.2

Let  $C$  be the parallelogram in the complex plane with corners at  $\pm R$  and  $\pm R + b/(2a)$ . Consider the integral of  $e^{-az^2}$  on this contour. Take the limit as  $R \rightarrow \infty$ .

### Hint 10.3

Extend the range of integration to  $(-\infty \dots \infty)$ . Use  $e^{i\omega x} = \cos(\omega x) + i \sin(\omega x)$  and the result of Exercise 10.2.

### Hint 10.4

### Hint 10.5

### Hint 10.6

### Hint 10.7

## 10.11 Solutions

### Solution 10.1

We parameterize the path with  $z = e^{i\theta}$ , with  $\theta$  ranging from  $\pi$  to 0.

$$\begin{aligned} dz &= i e^{i\theta} d\theta \\ |dz| &= |i e^{i\theta} d\theta| = |d\theta| = -d\theta \end{aligned}$$

1.

$$\begin{aligned} \int_C z^2 dz &= \int_{\pi}^0 e^{i2\theta} i e^{i\theta} d\theta \\ &= \int_{\pi}^0 i e^{i3\theta} d\theta \\ &= \left[ \frac{1}{3} e^{i3\theta} \right]_{\pi}^0 \\ &= \frac{1}{3} (e^{i0} - e^{i3\pi}) \\ &= \frac{1}{3} (1 - (-1)) \\ &= \frac{2}{3} \end{aligned}$$

2.

$$\begin{aligned}\int_C |z^2| dz &= \int_{\pi}^0 |e^{i2\theta}| i e^{i\theta} d\theta \\ &= \int_{\pi}^0 i e^{i\theta} d\theta \\ &= [e^{i\theta}]_{\pi}^0 \\ &= 1 - (-1) \\ &= 2\end{aligned}$$

3.

$$\begin{aligned}\int_C z^2 |dz| &= \int_{\pi}^0 e^{i2\theta} |i e^{i\theta} d\theta| \\ &= \int_{\pi}^0 -e^{i2\theta} d\theta \\ &= \left[ -\frac{i}{2} e^{i2\theta} \right]_{\pi}^0 \\ &= \frac{i}{2}(1 - 1) \\ &= 0\end{aligned}$$

4.

$$\begin{aligned}\int_C |z^2| |dz| &= \int_{\pi}^0 |e^{i2\theta}| |i e^{i\theta} d\theta| \\ &= \int_{\pi}^0 -d\theta \\ &= [-\theta]_{\pi}^0 \\ &= \pi\end{aligned}$$

## Solution 10.2

$$I = \int_{-\infty}^{\infty} e^{-(ax^2+bx)} dx$$

First we complete the square in the argument of the exponential.

$$I = e^{b^2/(4a)} \int_{-\infty}^{\infty} e^{-a(x+b/(2a))^2} dx$$

Consider the parallelogram in the complex plane with corners at  $\pm R$  and  $\pm R + b/(2a)$ . The integral of  $e^{-az^2}$  on this contour vanishes as it is an entire function. We relate the integral along one side of the parallelogram to the integrals along the other three sides.

$$\int_{-R+b/(2a)}^{R+b/(2a)} e^{-az^2} dz = \left( \int_{-R+b/(2a)}^{-R} + \int_{-R}^R + \int_R^{R+b/(2a)} \right) e^{-az^2} dz.$$

The first and third integrals on the right side vanish as  $R \rightarrow \infty$  because the integrand vanishes and the lengths of the paths of integration are finite. Taking the limit as  $R \rightarrow \infty$  we have,

$$\int_{-\infty+b/(2a)}^{\infty+b/(2a)} e^{-az^2} dz \equiv \int_{-\infty}^{\infty} e^{-a(x+b/(2a))^2} dx = \int_{-\infty}^{\infty} e^{-ax^2} dx.$$

Now we have

$$I = e^{b^2/(4a)} \int_{-\infty}^{\infty} e^{-ax^2} dx.$$

We make the change of variables  $\xi = \sqrt{a}x$ .

$$I = e^{b^2/(4a)} \frac{1}{\sqrt{a}} \int_{-\infty}^{\infty} e^{-\xi^2} d\xi$$

$$\boxed{\int_{-\infty}^{\infty} e^{-(ax^2+bx)} dx = \sqrt{\frac{\pi}{a}} e^{b^2/(4a)}}$$

### Solution 10.3

Consider

$$I = 2 \int_0^{\infty} e^{-ax^2} \cos(\omega x) \, dx.$$

Since the integrand is an even function,

$$I = \int_{-\infty}^{\infty} e^{-ax^2} \cos(\omega x) \, dx.$$

Since  $e^{-ax^2} \sin(\omega x)$  is an odd function,

$$I = \int_{-\infty}^{\infty} e^{-ax^2} e^{i\omega x} \, dx.$$

We evaluate this integral with the result of Exercise 10.2.

$$2 \int_0^{\infty} e^{-ax^2} \cos(\omega x) \, dx = \sqrt{\frac{\pi}{a}} e^{-\omega^2/(4a)}$$

Consider

$$I = 2 \int_0^{\infty} x e^{-ax^2} \sin(\omega x) \, dx.$$

Since the integrand is an even function,

$$I = \int_{-\infty}^{\infty} x e^{-ax^2} \sin(\omega x) \, dx.$$

Since  $x e^{-ax^2} \cos(\omega x)$  is an odd function,

$$I = -i \int_{-\infty}^{\infty} x e^{-ax^2} e^{i\omega x} \, dx.$$

We add a dash of integration by parts to get rid of the  $x$  factor.

$$I = -i \left[ -\frac{1}{2a} e^{-ax^2} e^{i\omega x} \right]_{-\infty}^{\infty} + i \int_{-\infty}^{\infty} \left( -\frac{1}{2a} e^{-ax^2} i\omega e^{i\omega x} \right) dx$$

$$I = \frac{\omega}{2a} \int_{-\infty}^{\infty} e^{-ax^2} e^{i\omega x} \, dx$$

$$2 \int_0^{\infty} x e^{-ax^2} \sin(\omega x) dx = \frac{\omega}{2a} \sqrt{\frac{\pi}{a}} e^{-\omega^2/(4a)}$$

### Solution 10.4

1. We parameterize the contour and do the integration.

$$z - z_0 = e^{i\theta}, \quad \theta \in [0 \dots 2\pi)$$

$$\begin{aligned} \int_C (z - z_0)^n dz &= \int_0^{2\pi} e^{in\theta} i e^{i\theta} d\theta \\ &= \begin{cases} \left[ \frac{e^{i(n+1)\theta}}{n+1} \right]_0^{2\pi} & \text{for } n \neq -1 \\ [i\theta]_0^{2\pi} & \text{for } n = -1 \end{cases} = \begin{cases} 0 & \text{for } n \neq -1 \\ i2\pi & \text{for } n = -1 \end{cases} \end{aligned}$$

2. We parameterize the contour and do the integration.

$$z - z_0 = i2 + e^{i\theta}, \quad \theta \in [0 \dots 2\pi)$$

$$\begin{aligned} \int_C (z - z_0)^n dz &= \int_0^{2\pi} (i2 + e^{i\theta})^n i e^{i\theta} d\theta \\ &= \begin{cases} \left[ \frac{(i2 + e^{i\theta})^{n+1}}{n+1} \right]_0^{2\pi} & \text{for } n \neq -1 \\ [\log(i2 + e^{i\theta})]_0^{2\pi} & \text{for } n = -1 \end{cases} = 0 \end{aligned}$$

3. We parameterize the contour and do the integration.

$$z = r e^{i\theta}, \quad r = 2 - \sin^2\left(\frac{\theta}{4}\right), \quad \theta \in [0 \dots 4\pi)$$

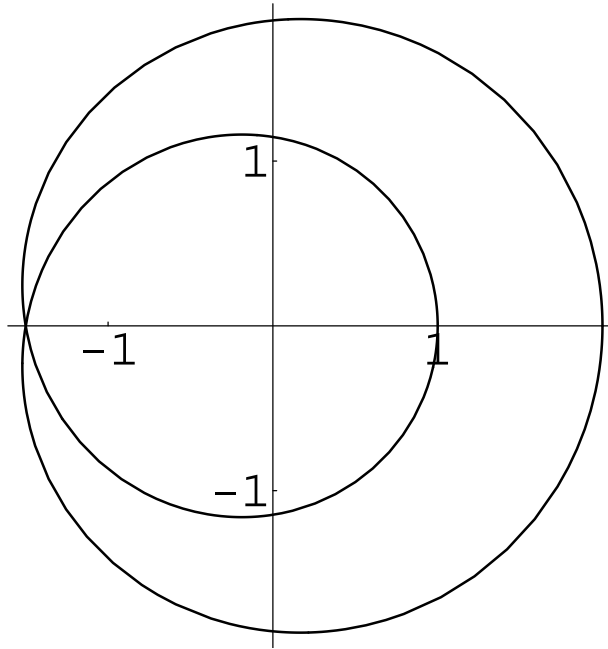

Figure 10.2: The contour:  $r = 2 - \sin^2\left(\frac{\theta}{4}\right)$ .

The contour encircles the origin twice. See Figure 10.2.

$$\begin{aligned}
 \int_C z^{-1} dz &= \int_0^{4\pi} \frac{1}{r(\theta) e^{i\theta}} (r'(\theta) + ir(\theta)) e^{i\theta} d\theta \\
 &= \int_0^{4\pi} \left( \frac{r'(\theta)}{r(\theta)} + i \right) d\theta \\
 &= [\log(r(\theta)) + i\theta]_0^{4\pi}
 \end{aligned}$$



Since  $r(\theta)$  does not vanish, the argument of  $r(\theta)$  does not change in traversing the contour and thus the logarithmic term has the same value at the beginning and end of the path.

$$\int_C z^{-1} dz = i4\pi$$

This answer is twice what we found in part (a) because the contour goes around the origin twice.

### Solution 10.5

1. We parameterize the contour with  $z = R e^{i\theta}$  and bound the modulus of the integral.

$$\begin{aligned} \left| \int_{C_R} \frac{z + \operatorname{Log} z}{z^3 + 1} dz \right| &\leq \int_{C_R} \left| \frac{z + \operatorname{Log} z}{z^3 + 1} \right| |dz| \\ &\leq \int_0^{2\pi} \frac{R + \ln R + \pi}{R^3 - 1} R d\theta \\ &= 2\pi r \frac{R + \ln R + \pi}{R^3 - 1} \end{aligned}$$

The upper bound on the modulus on the integral vanishes as  $R \rightarrow \infty$ .

$$\lim_{R \rightarrow \infty} 2\pi r \frac{R + \ln R + \pi}{R^3 - 1} = 0$$

We conclude that the integral vanishes as  $R \rightarrow \infty$ .

$$\lim_{R \rightarrow \infty} \int_{C_R} \frac{z + \operatorname{Log} z}{z^3 + 1} dz = 0$$

2. We parameterize the contour and bound the modulus of the integral.

$$z = 2 e^{i\theta}, \quad \theta \in [-\pi/2 \dots \pi/2]$$

$$\begin{aligned}
\left| \int_C \operatorname{Log} z \, dz \right| &\leq \int_C |\operatorname{Log} z| |dz| \\
&= \int_{-\pi/2}^{\pi/2} |\ln 2 + i\theta| 2 \, d\theta \\
&\leq 2 \int_{-\pi/2}^{\pi/2} (\ln 2 + |\theta|) \, d\theta \\
&= 4 \int_0^{\pi/2} (\ln 2 + \theta) \, d\theta \\
&= \frac{\pi}{2} (\pi + 4 \ln 2)
\end{aligned}$$

3. We parameterize the contour and bound the modulus of the integral.

$$z = R e^{i\theta}, \quad \theta \in [\theta_0 \dots \theta_0 + \pi]$$

$$\begin{aligned}
\left| \int_C \frac{z^2 - 1}{z^2 + 1} \, dz \right| &\leq \int_C \left| \frac{z^2 - 1}{z^2 + 1} \right| |dz| \\
&\leq \int_{\theta_0}^{\theta_0 + \pi} \left| \frac{R^2 e^{i2\theta} - 1}{R^2 e^{i2\theta} + 1} \right| |R \, d\theta| \\
&\leq R \int_{\theta_0}^{\theta_0 + \pi} \frac{R^2 + 1}{R^2 - 1} \, d\theta \\
&= \pi R \frac{R^2 + 1}{R^2 - 1}
\end{aligned}$$

**Solution 10.6**

$$\begin{aligned}
\int_C f(z) dz &= \int_0^1 \sqrt{r} dr + \int_0^\pi e^{i\theta/2} i e^{i\theta} d\theta + \int_1^0 i\sqrt{r} (-dr) \\
&= \frac{2}{3} + \left(-\frac{2}{3} - i\frac{2}{3}\right) + i\frac{2}{3} \\
&= 0
\end{aligned}$$

The Cauchy-Goursat theorem does not apply because the function is not analytic at  $z = 0$ , a point on the boundary.

**Solution 10.7**

1.

$$\begin{aligned}
\int_C (iz^3 + z^{-3}) dz &= \left[ \frac{iz^4}{4} - \frac{1}{2z^2} \right]_{1+i}^i \\
&= \frac{1}{2} + i
\end{aligned}$$

In this example, the anti-derivative is single-valued.

2.

$$\begin{aligned}
\int_C \sin^2 z \cos z dz &= \left[ \frac{\sin^3 z}{3} \right]_\pi^{i\pi} \\
&= \frac{1}{3} (\sin^3(i\pi) - \sin^3(\pi)) \\
&= -i \frac{\sinh^3(\pi)}{3}
\end{aligned}$$

Again the anti-derivative is single-valued.

3. We choose the branch of  $z^i$  with  $-\pi/2 < \arg(z) < 3\pi/2$ . This matches the principal value of  $z^i$  above the real axis and is defined continuously on the path of integration.

$$\begin{aligned}\int_C z^i dz &= \left[ \frac{z^{1+i}}{1+i} \right]_{e^{i\pi}}^{e^{i0}} \\ &= \left[ \frac{1-i}{2} e^{(1+i)\log z} \right]_{e^{i\pi}}^{e^{i0}} \\ &= \frac{1-i}{2} (e^0 - e^{(1+i)i\pi}) \\ &= \frac{1+e^{-\pi}}{2} (1-i)\end{aligned}$$

# Chapter 11

## Cauchy's Integral Formula

If I were founding a university I would begin with a smoking room; next a dormitory; and then a decent reading room and a library. After that, if I still had more money that I couldn't use, I would hire a professor and get some text books.

- Stephen Leacock

## 11.1 Cauchy's Integral Formula

**Result 11.1.1 Cauchy's Integral Formula.** If  $f(\zeta)$  is analytic in a compact, closed, connected domain  $D$  and  $z$  is a point in the interior of  $D$  then

$$f(z) = \frac{1}{i2\pi} \oint_{\partial D} \frac{f(\zeta)}{\zeta - z} d\zeta = \frac{1}{i2\pi} \sum_k \oint_{C_k} \frac{f(\zeta)}{\zeta - z} d\zeta. \quad (11.1)$$

Here the set of contours  $\{C_k\}$  make up the positively oriented boundary  $\partial D$  of the domain  $D$ . More generally, we have

$$f^{(n)}(z) = \frac{n!}{i2\pi} \oint_{\partial D} \frac{f(\zeta)}{(\zeta - z)^{n+1}} d\zeta = \frac{n!}{i2\pi} \sum_k \oint_{C_k} \frac{f(\zeta)}{(\zeta - z)^{n+1}} d\zeta. \quad (11.2)$$

Cauchy's Formula shows that the value of  $f(z)$  and all its derivatives in a domain are determined by the value of  $f(z)$  on the boundary of the domain. Consider the first formula of the result, Equation 11.1. We deform the contour to a circle of radius  $\delta$  about the point  $\zeta = z$ .

$$\begin{aligned} \oint_C \frac{f(\zeta)}{\zeta - z} d\zeta &= \oint_{C_\delta} \frac{f(\zeta)}{\zeta - z} d\zeta \\ &= \oint_{C_\delta} \frac{f(z)}{\zeta - z} d\zeta + \oint_{C_\delta} \frac{f(\zeta) - f(z)}{\zeta - z} d\zeta \end{aligned}$$

We use the result of Example 10.8.1 to evaluate the first integral.

$$\oint_C \frac{f(\zeta)}{\zeta - z} d\zeta = i2\pi f(z) + \oint_{C_\delta} \frac{f(\zeta) - f(z)}{\zeta - z} d\zeta$$

The remaining integral along  $C_\delta$  vanishes as  $\delta \rightarrow 0$  because  $f(\zeta)$  is continuous. We demonstrate this with the maximum modulus integral bound. The length of the path of integration is  $2\pi\delta$ .

$$\begin{aligned} \lim_{\delta \rightarrow 0} \left| \oint_{C_\delta} \frac{f(\zeta) - f(z)}{\zeta - z} d\zeta \right| &\leq \lim_{\delta \rightarrow 0} \left( (2\pi\delta) \frac{1}{\delta} \max_{|\zeta - z| = \delta} |f(\zeta) - f(z)| \right) \\ &\leq \lim_{\delta \rightarrow 0} \left( 2\pi \max_{|\zeta - z| = \delta} |f(\zeta) - f(z)| \right) \\ &= 0 \end{aligned}$$

This gives us the desired result.

$$f(z) = \frac{1}{i2\pi} \oint_C \frac{f(\zeta)}{\zeta - z} d\zeta$$

We derive the second formula, Equation 11.2, from the first by differentiating with respect to  $z$ . Note that the integral converges uniformly for  $z$  in any closed subset of the interior of  $C$ . Thus we can differentiate with respect to  $z$  and interchange the order of differentiation and integration.

$$\begin{aligned} f^{(n)}(z) &= \frac{1}{i2\pi} \frac{d^n}{dz^n} \oint_C \frac{f(\zeta)}{\zeta - z} d\zeta \\ &= \frac{1}{i2\pi} \oint_C \frac{d^n}{dz^n} \frac{f(\zeta)}{\zeta - z} d\zeta \\ &= \frac{n!}{i2\pi} \oint_C \frac{f(\zeta)}{(\zeta - z)^{n+1}} d\zeta \end{aligned}$$

**Example 11.1.1** Consider the following integrals where  $C$  is the positive contour on the unit circle. For the third integral, the point  $z = -1$  is removed from the contour.

1.  $\oint_C \sin(\cos(z^5)) dz$
2.  $\oint_C \frac{1}{(z-3)(3z-1)} dz$

$$3. \int_C \sqrt{z} dz$$

1. Since  $\sin(\cos(z^5))$  is an analytic function inside the unit circle,

$$\oint_C \sin(\cos(z^5)) dz = 0$$

2.  $\frac{1}{(z-3)(3z-1)}$  has singularities at  $z = 3$  and  $z = 1/3$ . Since  $z = 3$  is outside the contour, only the singularity at  $z = 1/3$  will contribute to the value of the integral. We will evaluate this integral using the Cauchy integral formula.

$$\oint_C \frac{1}{(z-3)(3z-1)} dz = i2\pi \left( \frac{1}{(1/3-3)3} \right) = -\frac{i\pi}{4}$$

3. Since the curve is not closed, we cannot apply the Cauchy integral formula. Note that  $\sqrt{z}$  is single-valued and analytic in the complex plane with a branch cut on the negative real axis. Thus we use the Fundamental Theorem of Calculus.

$$\begin{aligned} \int_C \sqrt{z} dz &= \left[ \frac{2}{3} \sqrt{z^3} \right]_{e^{-i\pi}}^{e^{i\pi}} \\ &= \frac{2}{3} (e^{i3\pi/2} - e^{-i3\pi/2}) \\ &= \frac{2}{3} (-i - i) \\ &= -i\frac{4}{3} \end{aligned}$$

**Cauchy's Inequality.** Suppose the  $f(\zeta)$  is analytic in the closed disk  $|\zeta - z| \leq r$ . By Cauchy's integral formula,

$$f^{(n)}(z) = \frac{n!}{i2\pi} \oint_C \frac{f(\zeta)}{(\zeta - z)^{n+1}} d\zeta,$$



where  $C$  is the circle of radius  $r$  centered about the point  $z$ . We use this to obtain an upper bound on the modulus of  $f^{(n)}(z)$ .

$$\begin{aligned} |f^{(n)}(z)| &= \frac{n!}{2\pi} \left| \oint_C \frac{f(\zeta)}{(\zeta - z)^{n+1}} d\zeta \right| \\ &\leq \frac{n!}{2\pi} 2\pi r \max_{|\zeta - z|=r} \left| \frac{f(\zeta)}{(\zeta - z)^{n+1}} \right| \\ &= \frac{n!}{r^n} \max_{|\zeta - z|=r} |f(\zeta)| \end{aligned}$$

**Result 11.1.2 Cauchy's Inequality.** If  $f(\zeta)$  is analytic in  $|\zeta - z| \leq r$  then

$$\left| f^{(n)}(z) \right| \leq \frac{n!M}{r^n}$$

where  $|f(\zeta)| \leq M$  for all  $|\zeta - z| = r$ .

**Liouville's Theorem.** Consider a function  $f(z)$  that is analytic and bounded, ( $|f(z)| \leq M$ ), in the complex plane. From Cauchy's inequality,

$$|f'(z)| \leq \frac{M}{r}$$

for any positive  $r$ . By taking  $r \rightarrow \infty$ , we see that  $f'(z)$  is identically zero for all  $z$ . Thus  $f(z)$  is a constant.

**Result 11.1.3 Liouville's Theorem.** If  $f(z)$  is analytic and  $|f(z)|$  is bounded in the complex plane then  $f(z)$  is a constant.

**The Fundamental Theorem of Algebra.** We will prove that every polynomial of degree  $n \geq 1$  has exactly  $n$  roots, counting multiplicities. First we demonstrate that each such polynomial has at least one root. Suppose that an

$n^{\text{th}}$  degree polynomial  $p(z)$  has no roots. Let the lower bound on the modulus of  $p(z)$  be  $0 < m \leq |p(z)|$ . The function  $f(z) = 1/p(z)$  is analytic, ( $f'(z) = p'(z)/p^2(z)$ ), and bounded, ( $|f(z)| \leq 1/m$ ), in the extended complex plane. Using Liouville's theorem we conclude that  $f(z)$  and hence  $p(z)$  are constants, which yields a contradiction. Therefore every such polynomial  $p(z)$  must have at least one root.

Now we show that we can factor the root out of the polynomial. Let

$$p(z) = \sum_{k=0}^n p_k z^k.$$

We note that

$$(z^n - c^n) = (z - c) \sum_{k=0}^{n-1} c^{n-1-k} z^k.$$

Suppose that the  $n^{\text{th}}$  degree polynomial  $p(z)$  has a root at  $z = c$ .

$$\begin{aligned} p(z) &= p(z) - p(c) \\ &= \sum_{k=0}^n p_k z^k - \sum_{k=0}^n p_k c^k \\ &= \sum_{k=0}^n p_k (z^k - c^k) \\ &= \sum_{k=0}^n p_k (z - c) \sum_{j=0}^{k-1} c^{k-1-j} z^j \\ &= (z - c)q(z) \end{aligned}$$

Here  $q(z)$  is a polynomial of degree  $n - 1$ . By induction, we see that  $p(z)$  has exactly  $n$  roots.

**Result 11.1.4 Fundamental Theorem of Algebra.** Every polynomial of degree  $n \geq 1$  has exactly  $n$  roots, counting multiplicities.

**Gauss' Mean Value Theorem.** Let  $f(\zeta)$  be analytic in  $|\zeta - z| \leq r$ . By Cauchy's integral formula,

$$f(z) = \frac{1}{i2\pi} \oint_C \frac{f(\zeta)}{\zeta - z} d\zeta,$$

where  $C$  is the circle  $|\zeta - z| = r$ . We parameterize the contour with  $\zeta = z + r e^{i\theta}$ .

$$f(z) = \frac{1}{i2\pi} \int_0^{2\pi} \frac{f(z + r e^{i\theta})}{r e^{i\theta}} i r e^{i\theta} d\theta$$

Writing this in the form,

$$f(z) = \frac{1}{2\pi r} \int_0^{2\pi} f(z + r e^{i\theta}) r d\theta,$$

we see that  $f(z)$  is the average value of  $f(\zeta)$  on the circle of radius  $r$  about the point  $z$ .

**Result 11.1.5 Gauss' Average Value Theorem.** If  $f(\zeta)$  is analytic in  $|\zeta - z| \leq r$  then

$$f(z) = \frac{1}{2\pi} \int_0^{2\pi} f(z + r e^{i\theta}) d\theta.$$

That is,  $f(z)$  is equal to its average value on a circle of radius  $r$  about the point  $z$ .

**Extremum Modulus Theorem.** Let  $f(z)$  be analytic in closed, connected domain,  $D$ . The extreme values of the modulus of the function must occur on the boundary. If  $|f(z)|$  has an interior extrema, then the function is a constant. We will show this with proof by contradiction. Assume that  $|f(z)|$  has an interior maxima at the point  $z = c$ . This means that there exists a neighborhood of the point  $z = c$  for which  $|f(z)| \leq |f(c)|$ . Choose an  $\epsilon$  so that the set  $|z - c| \leq \epsilon$  lies inside this neighborhood. First we use Gauss' mean value theorem.

$$f(c) = \frac{1}{2\pi} \int_0^{2\pi} f(c + \epsilon e^{i\theta}) d\theta$$

We get an upper bound on  $|f(c)|$  with the maximum modulus integral bound.

$$|f(c)| \leq \frac{1}{2\pi} \int_0^{2\pi} |f(c + \epsilon e^{i\theta})| d\theta$$

Since  $z = c$  is a maxima of  $|f(z)|$  we can get a lower bound on  $|f(c)|$ .

$$|f(c)| \geq \frac{1}{2\pi} \int_0^{2\pi} |f(c + \epsilon e^{i\theta})| d\theta$$

If  $|f(z)| < |f(c)|$  for any point on  $|z - c| = \epsilon$ , then the continuity of  $f(z)$  implies that  $|f(z)| < |f(c)|$  in a neighborhood of that point which would make the value of the integral of  $|f(z)|$  strictly less than  $|f(c)|$ . Thus we conclude that  $|f(z)| = |f(c)|$  for all  $|z - c| = \epsilon$ . Since we can repeat the above procedure for any circle of radius smaller than  $\epsilon$ ,  $|f(z)| = |f(c)|$  for all  $|z - c| \leq \epsilon$ , i.e. all the points in the disk of radius  $\epsilon$  about  $z = c$  are also maxima. By recursively repeating this procedure points in this disk, we see that  $|f(z)| = |f(c)|$  for all  $z \in D$ . This implies that  $f(z)$  is a constant in the domain. By reversing the inequalities in the above method we see that the minimum modulus of  $f(z)$  must also occur on the boundary.

**Result 11.1.6 Extremum Modulus Theorem.** Let  $f(z)$  be analytic in a closed, connected domain,  $D$ . The extreme values of the modulus of the function must occur on the boundary. If  $|f(z)|$  has an interior extrema, then the function is a constant.

## 11.2 The Argument Theorem

**Result 11.2.1 The Argument Theorem.** Let  $f(z)$  be analytic inside and on  $C$  except for isolated poles inside the contour. Let  $f(z)$  be nonzero on  $C$ .

$$\frac{1}{i2\pi} \int_C \frac{f'(z)}{f(z)} dz = N - P$$

Here  $N$  is the number of zeros and  $P$  the number of poles, counting multiplicities, of  $f(z)$  inside  $C$ .

First we will simplify the problem and consider a function  $f(z)$  that has one zero or one pole. Let  $f(z)$  be analytic and nonzero inside and on  $A$  except for a zero of order  $n$  at  $z = a$ . Then we can write  $f(z) = (z - a)^n g(z)$  where  $g(z)$  is analytic and nonzero inside and on  $A$ . The integral of  $\frac{f'(z)}{f(z)}$  along  $A$  is

$$\begin{aligned} \frac{1}{i2\pi} \int_A \frac{f'(z)}{f(z)} dz &= \frac{1}{i2\pi} \int_A \frac{d}{dz} (\log(f(z))) dz \\ &= \frac{1}{i2\pi} \int_A \frac{d}{dz} (\log((z - a)^n) + \log(g(z))) dz \\ &= \frac{1}{i2\pi} \int_A \frac{d}{dz} (\log((z - a)^n)) dz \\ &= \frac{1}{i2\pi} \int_A \frac{n}{z - a} dz \\ &= n \end{aligned}$$

Now let  $f(z)$  be analytic and nonzero inside and on  $B$  except for a pole of order  $p$  at  $z = b$ . Then we can write  $f(z) = \frac{g(z)}{(z-b)^p}$  where  $g(z)$  is analytic and nonzero inside and on  $B$ . The integral of  $\frac{f'(z)}{f(z)}$  along  $B$  is

$$\begin{aligned} \frac{1}{i2\pi} \int_B \frac{f'(z)}{f(z)} dz &= \frac{1}{i2\pi} \int_B \frac{d}{dz} (\log(f(z))) dz \\ &= \frac{1}{i2\pi} \int_B \frac{d}{dz} (\log((z-b)^{-p}) + \log(g(z))) dz \\ &= \frac{1}{i2\pi} \int_B \frac{d}{dz} (\log((z-b)^{-p}) +) dz \\ &= \frac{1}{i2\pi} \int_B \frac{-p}{z-b} dz \\ &= -p \end{aligned}$$

Now consider a function  $f(z)$  that is analytic inside and on the contour  $C$  except for isolated poles at the points  $b_1, \dots, b_p$ . Let  $f(z)$  be nonzero except at the isolated points  $a_1, \dots, a_n$ . Let the contours  $A_k$ ,  $k = 1, \dots, n$ , be simple, positive contours which contain the zero at  $a_k$  but no other poles or zeros of  $f(z)$ . Likewise, let the contours  $B_k$ ,  $k = 1, \dots, p$  be simple, positive contours which contain the pole at  $b_k$  but no other poles or zeros of  $f(z)$ . (See Figure 11.1.) By deforming the contour we obtain

$$\int_C \frac{f'(z)}{f(z)} dz = \sum_{j=1}^n \int_{A_j} \frac{f'(z)}{f(z)} dz + \sum_{k=1}^p \int_{B_k} \frac{f'(z)}{f(z)} dz.$$

From this we obtain Result 11.2.1.

## 11.3 Rouché's Theorem

**Result 11.3.1 Rouché's Theorem.** Let  $f(z)$  and  $g(z)$  be analytic inside and on a simple, closed contour  $C$ . If  $|f(z)| > |g(z)|$  on  $C$  then  $f(z)$  and  $f(z) + g(z)$  have the same number of zeros inside  $C$  and no zeros on  $C$ .

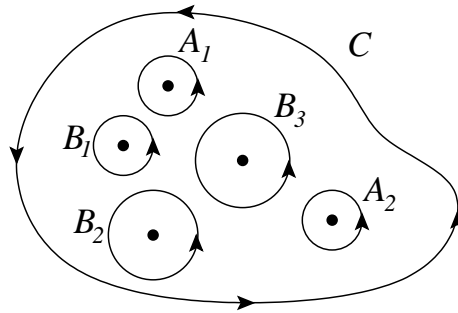

Figure 11.1: Deforming the contour  $C$ .

First note that since  $|f(z)| > |g(z)|$  on  $C$ ,  $f(z)$  is nonzero on  $C$ . The inequality implies that  $|f(z) + g(z)| > 0$  on  $C$  so  $f(z) + g(z)$  has no zeros on  $C$ . We will count the number of zeros of  $f(z)$  and  $g(z)$  using the Argument Theorem, (Result 11.2.1). The number of zeros  $N$  of  $f(z)$  inside the contour is

$$N = \frac{1}{i2\pi} \oint_C \frac{f'(z)}{f(z)} dz.$$

Now consider the number of zeros  $M$  of  $f(z) + g(z)$ . We introduce the function  $h(z) = g(z)/f(z)$ .

$$\begin{aligned} M &= \frac{1}{i2\pi} \oint_C \frac{f'(z) + g'(z)}{f(z) + g(z)} dz \\ &= \frac{1}{i2\pi} \oint_C \frac{f'(z) + f'(z)h(z) + f(z)h'(z)}{f(z) + f(z)h(z)} dz \\ &= \frac{1}{i2\pi} \oint_C \frac{f'(z)}{f(z)} dz + \frac{1}{i2\pi} \oint_C \frac{h'(z)}{1 + h(z)} dz \\ &= N + \frac{1}{i2\pi} [\log(1 + h(z))]_C \\ &= N \end{aligned}$$

(Note that since  $|h(z)| < 1$  on  $C$ ,  $\Re(1 + h(z)) > 0$  on  $C$  and the value of  $\log(1 + h(z))$  does not change in traversing the contour.) This demonstrates that  $f(z)$  and  $f(z) + g(z)$  have the same number of zeros inside  $C$  and proves the result.



## 11.4 Exercises

### Exercise 11.1

What is

$$(\arg(\sin z))|_C$$

where  $C$  is the unit circle?

### Exercise 11.2

Let  $C$  be the circle of radius 2 centered about the origin and oriented in the positive direction. Evaluate the following integrals:

1.  $\oint_C \frac{\sin z}{z^2+5} dz$

2.  $\oint_C \frac{z}{z^2+1} dz$

3.  $\oint_C \frac{z^2+1}{z} dz$

### Exercise 11.3

Let  $f(z)$  be analytic and bounded (i.e.  $|f(z)| < M$ ) for  $|z| > R$ , but not necessarily analytic for  $|z| \leq R$ . Let the points  $\alpha$  and  $\beta$  lie inside the circle  $|z| = R$ . Evaluate

$$\oint_C \frac{f(z)}{(z-\alpha)(z-\beta)} dz$$

where  $C$  is any closed contour outside  $|z| = R$ , containing the circle  $|z| = R$ . [Hint: consider the circle at infinity] Now suppose that in addition  $f(z)$  is analytic everywhere. Deduce that  $f(\alpha) = f(\beta)$ .

### Exercise 11.4

Using Rouché's theorem show that all the roots of the equation  $p(z) = z^6 - 5z^2 + 10 = 0$  lie in the annulus  $1 < |z| < 2$ .

### Exercise 11.5

Evaluate as a function of  $t$

$$\omega = \frac{1}{i2\pi} \oint_C \frac{e^{zt}}{z^2(z^2+a^2)} dz,$$

where  $C$  is any positively oriented contour surrounding the circle  $|z| = a$ .

### Exercise 11.6

Consider  $C_1$ , (the positively oriented circle  $|z| = 4$ ), and  $C_2$ , (the positively oriented boundary of the square whose sides lie along the lines  $x = \pm 1$ ,  $y = \pm 1$ ). Explain why

$$\int_{C_1} f(z) dz = \int_{C_2} f(z) dz$$

for the functions

1.  $f(z) = \frac{1}{3z^2 + 1}$
2.  $f(z) = \frac{z}{1 - e^z}$

### Exercise 11.7

Show that if  $f(z)$  is of the form

$$f(z) = \frac{\alpha_k}{z^k} + \frac{\alpha_{k-1}}{z^{k-1}} + \cdots + \frac{\alpha_1}{z} + g(z), \quad k \geq 1$$

where  $g$  is analytic inside and on  $C$ , (the positive circle  $|z| = 1$ ), then

$$\int_C f(z) dz = i2\pi\alpha_1.$$

### Exercise 11.8

Show that if  $f(z)$  is analytic within and on a simple closed contour  $C$  and  $z_0$  is not on  $C$  then

$$\int_C \frac{f'(z)}{z - z_0} dz = \int_C \frac{f(z)}{(z - z_0)^2} dz.$$

Note that  $z_0$  may be either inside or outside of  $C$ .

**Exercise 11.9**

If  $C$  is the positive circle  $z = e^{i\theta}$  show that for any real constant  $a$ ,

$$\int_C \frac{e^{az}}{z} dz = i2\pi$$

and hence

$$\int_0^\pi e^{a \cos \theta} \cos(a \sin \theta) d\theta = \pi.$$

**Exercise 11.10**

Use Cauchy-Goursat, the generalized Cauchy integral formula, and suitable extensions to multiply-connected domains to evaluate the following integrals. Be sure to justify your approach in each case.

1.

$$\int_C \frac{z}{z^3 - 9} dz$$

where  $C$  is the positively oriented rectangle whose sides lie along  $x = \pm 5$ ,  $y = \pm 3$ .

2.

$$\int_C \frac{\sin z}{z^2(z - 4)} dz,$$

where  $C$  is the positively oriented circle  $|z| = 2$ .

3.

$$\int_C \frac{(z^3 + z + i) \sin z}{z^4 + iz^3} dz,$$

where  $C$  is the positively oriented circle  $|z| = \pi$ .

4.

$$\int_C \frac{e^{zt}}{z^2(z + 1)} dz$$

where  $C$  is any positive simple closed contour surrounding  $|z| = 1$ .

**Exercise 11.11**

Use Liouville's theorem to prove the following:

1. If  $f(z)$  is entire with  $\Re(f(z)) \leq M$  for all  $z$  then  $f(z)$  is constant.
2. If  $f(z)$  is entire with  $|f^{(5)}(z)| \leq M$  for all  $z$  then  $f(z)$  is a polynomial of degree at most five.

**Exercise 11.12**

Find all functions  $f(z)$  analytic in the domain  $D : |z| < R$  that satisfy  $f(0) = e^i$  and  $|f(z)| \leq 1$  for all  $z$  in  $D$ .

**Exercise 11.13**

Let  $f(z) = \sum_{k=0}^{\infty} k^4 \left(\frac{z}{4}\right)^k$  and evaluate the following contour integrals, providing justification in each case:

1.  $\int_C \cos(iz)f(z) dz$   $C$  is the positive circle  $|z - 1| = 1$ .
2.  $\int_C \frac{f(z)}{z^3} dz$   $C$  is the positive circle  $|z| = \pi$ .

## 11.5 Hints

### Hint 11.1

Use the argument theorem.

### Hint 11.2

### Hint 11.3

To evaluate the integral, consider the circle at infinity.

### Hint 11.4

### Hint 11.5

### Hint 11.6

### Hint 11.7

### Hint 11.8

### Hint 11.9

### Hint 11.10

**Hint 11.11**

**Hint 11.12**

**Hint 11.13**

## 11.6 Solutions

### Solution 11.1

Let  $f(z)$  be analytic inside and on the contour  $C$ . Let  $f(z)$  be nonzero on the contour. The argument theorem states that

$$\frac{1}{i2\pi} \int_C \frac{f'(z)}{f(z)} dz = N - P,$$

where  $N$  is the number of zeros and  $P$  is the number of poles, (counting multiplicities), of  $f(z)$  inside  $C$ . The theorem is aptly named, as

$$\begin{aligned} \frac{1}{i2\pi} \int_C \frac{f'(z)}{f(z)} dz &= \frac{1}{i2\pi} [\log(f(z))]_C \\ &= \frac{1}{i2\pi} [\log |f(z)| + i \arg(f(z))]_C \\ &= \frac{1}{2\pi} [\arg(f(z))]_C. \end{aligned}$$

Thus we could write the argument theorem as

$$\frac{1}{i2\pi} \int_C \frac{f'(z)}{f(z)} dz = \frac{1}{2\pi} [\arg(f(z))]_C = N - P.$$

Since  $\sin z$  has a single zero and no poles inside the unit circle, we have

$$\begin{aligned} \frac{1}{2\pi} \arg(\sin(z))|_C &= 1 - 0 \\ \arg(\sin(z))|_C &= 2\pi \end{aligned}$$

### Solution 11.2

1. Since the integrand  $\frac{\sin z}{z^2+5}$  is analytic inside and on the contour, (the only singularities are at  $z = \pm i\sqrt{5}$  and at infinity), the integral is zero by Cauchy's Theorem.

2. First we expand the integrand in partial fractions.

$$\frac{z}{z^2 + 1} = \frac{a}{z - i} + \frac{b}{z + i}$$

$$a = \frac{z}{z + i} \Big|_{z=i} = \frac{1}{2}, \quad b = \frac{z}{z - i} \Big|_{z=-i} = \frac{1}{2}$$

Now we can do the integral with Cauchy's formula.

$$\begin{aligned} \int_C \frac{z}{z^2 + 1} dz &= \int_C \frac{1/2}{z - i} dz + \int_C \frac{1/2}{z + i} dz \\ &= \frac{1}{2} i 2\pi + \frac{1}{2} i 2\pi \\ &= i 2\pi \end{aligned}$$

3.

$$\begin{aligned} \int_C \frac{z^2 + 1}{z} dz &= \int_C \left( z + \frac{1}{z} \right) dz \\ &= \int_C z dz + \int_C \frac{1}{z} dz \\ &= 0 + i 2\pi \\ &= i 2\pi \end{aligned}$$

### Solution 11.3

Let  $C$  be the circle of radius  $r$ , ( $r > R$ ), centered at the origin. We get an upper bound on the integral with the Maximum Modulus Integral Bound, (Result 10.2.1).

$$\left| \oint_C \frac{f(z)}{(z - \alpha)(z - \beta)} dz \right| \leq 2\pi r \max_{|z|=r} \left| \frac{f(z)}{(z - \alpha)(z - \beta)} \right| \leq 2\pi r \frac{M}{(r - |\alpha|)(r - |\beta|)}$$



By taking the limit as  $r \rightarrow \infty$  we see that the modulus of the integral is bounded above by zero. Thus the integral vanishes.

Now we assume that  $f(z)$  is analytic and evaluate the integral with Cauchy's Integral Formula. (We assume that  $\alpha \neq \beta$ .)

$$\begin{aligned} \oint_C \frac{f(z)}{(z-\alpha)(z-\beta)} dz &= 0 \\ \oint_C \frac{f(z)}{(z-\alpha)(\alpha-\beta)} dz + \oint_C \frac{f(z)}{(\beta-\alpha)(z-\beta)} dz &= 0 \\ i2\pi \frac{f(\alpha)}{\alpha-\beta} + i2\pi \frac{f(\beta)}{\beta-\alpha} &= 0 \\ f(\alpha) &= f(\beta) \end{aligned}$$

#### Solution 11.4

Consider the circle  $|z| = 2$ . On this circle:

$$\begin{aligned} |z^6| &= 64 \\ |-5z^2 + 10| &\leq |-5z^2| + |10| = 30 \end{aligned}$$

Since  $|z^6| < |-5z^2 + 10|$  on  $|z| = 2$ ,  $p(z)$  has the same number of roots as  $z^6$  in  $|z| < 2$ .  $p(z)$  has 6 roots in  $|z| < 2$ .

Consider the circle  $|z| = 1$ . On this circle:

$$\begin{aligned} |10| &= 10 \\ |z^6 - 5z^2| &\leq |z^6| + |-5z^2| = 6 \end{aligned}$$

Since  $|z^6 - 5z^2| < |10|$  on  $|z| = 1$ ,  $p(z)$  has the same number of roots as 10 in  $|z| < 1$ .  $p(z)$  has no roots in  $|z| < 1$ .

On the unit circle,

$$|p(z)| \geq |10| - |z^6| - |5z^2| = 4.$$

Thus  $p(z)$  has no roots on the unit circle.

We conclude that  $p(z)$  has exactly 6 roots in  $1 < |z| < 2$ .

### Solution 11.5

We evaluate the integral with Cauchy's Integral Formula.

$$\begin{aligned}\omega &= \frac{1}{i2\pi} \oint_C \frac{e^{zt}}{z^2(z^2 + a^2)} dz \\ \omega &= \frac{1}{i2\pi} \oint_C \left( \frac{e^{zt}}{a^2 z^2} + \frac{i e^{zt}}{2a^3(z - ia)} - \frac{i e^{zt}}{2a^3(z + ia)} \right) dz \\ \omega &= \left[ \frac{d}{dz} \frac{e^{zt}}{a^2} \right]_{z=0} + \frac{i e^{iat}}{2a^3} - \frac{i e^{-iat}}{2a^3} \\ \omega &= \frac{t}{a^2} - \frac{\sin(at)}{a^3} \\ \omega &= \frac{at - \sin(at)}{a^3}\end{aligned}$$

### Solution 11.6

1. We factor the denominator of the integrand.

$$\frac{1}{3z^2 + 1} = \frac{1}{3(z - i\sqrt{3}/3)(z + i\sqrt{3}/3)}$$

There are two first order poles which could contribute to the value of an integral on a closed path. Both poles lie inside both contours. See Figure 11.2. We see that  $C_1$  can be continuously deformed to  $C_2$  on the domain where the integrand is analytic. Thus the integrals have the same value.

2. We consider the integrand

$$\frac{z}{1 - e^z}.$$

Since  $e^z = 1$  has the solutions  $z = i2\pi n$  for  $n \in \mathbb{Z}$ , the integrand has singularities at these points. There is a removable singularity at  $z = 0$  and first order poles at  $z = i2\pi n$  for  $n \in \mathbb{Z} \setminus \{0\}$ . Each contour contains only the singularity at  $z = 0$ . See Figure 11.3. We see that  $C_1$  can be continuously deformed to  $C_2$  on the domain where the integrand is analytic. Thus the integrals have the same value.

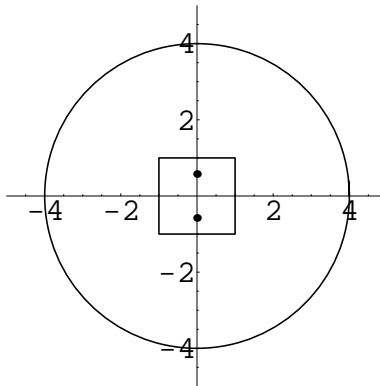

Figure 11.2: The contours and the singularities of  $\frac{1}{3z^2+1}$ .

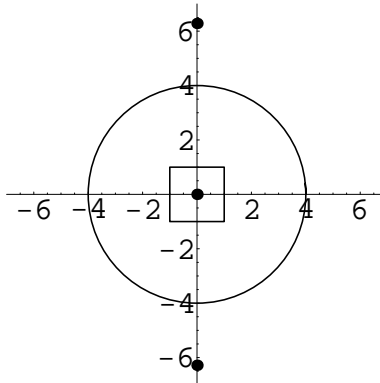

Figure 11.3: The contours and the singularities of  $\frac{z}{1-e^z}$ .

**Solution 11.7**

First we write the integral of  $f(z)$  as a sum of integrals.

$$\begin{aligned}\int_C f(z) dz &= \int_C \left( \frac{\alpha_k}{z^k} + \frac{\alpha_{k-1}}{z^{k-1}} + \cdots + \frac{\alpha_1}{z} + g(z) \right) dz \\ &= \int_C \frac{\alpha_k}{z^k} dz + \int_C \frac{\alpha_{k-1}}{z^{k-1}} dz + \cdots + \int_C \frac{\alpha_1}{z} dz + \int_C g(z) dz\end{aligned}$$

The integral of  $g(z)$  vanishes by the Cauchy-Goursat theorem. We evaluate the integral of  $\alpha_1/z$  with Cauchy's integral formula.

$$\int_C \frac{\alpha_1}{z} dz = i2\pi\alpha_1$$

We evaluate the remaining  $\alpha_n/z^n$  terms with anti-derivatives. Each of these integrals vanish.

$$\begin{aligned}\int_C f(z) dz &= \int_C \frac{\alpha_k}{z^k} dz + \int_C \frac{\alpha_{k-1}}{z^{k-1}} dz + \cdots + \int_C \frac{\alpha_1}{z} dz + \int_C g(z) dz \\ &= \left[ -\frac{\alpha_k}{(k-1)z^{k-1}} \right]_C + \cdots + \left[ -\frac{\alpha_2}{z} \right]_C + i2\pi\alpha_1 \\ &= i2\pi\alpha_1\end{aligned}$$

**Solution 11.8**

We evaluate the integrals with the Cauchy integral formula. ( $z_0$  is required to not be on  $C$  so the integrals exist.)

$$\int_C \frac{f'(z)}{z - z_0} dz = \begin{cases} i2\pi f'(z_0) & \text{if } z_0 \text{ is inside } C \\ 0 & \text{if } z_0 \text{ is outside } C \end{cases}$$

$$\int_C \frac{f(z)}{(z - z_0)^2} dz = \begin{cases} \frac{i2\pi}{1!} f'(z_0) & \text{if } z_0 \text{ is inside } C \\ 0 & \text{if } z_0 \text{ is outside } C \end{cases}$$

Thus we see that the integrals are equal.

### Solution 11.9

First we evaluate the integral using the Cauchy Integral Formula.

$$\int_C \frac{e^{az}}{z} dz = [e^{az}]_{z=0} = i2\pi$$

Next we parameterize the path of integration. We use the periodicity of the cosine and sine to simplify the integral.

$$\begin{aligned}\int_C \frac{e^{az}}{z} dz &= i2\pi \\ \int_0^{2\pi} \frac{e^{ae^{i\theta}}}{e^{i\theta}} i e^{i\theta} d\theta &= i2\pi \\ \int_0^{2\pi} e^{a(\cos\theta + i\sin\theta)} d\theta &= 2\pi \\ \int_0^{2\pi} e^{a\cos\theta} (\cos(\sin\theta) + i\sin(\sin\theta)) d\theta &= 2\pi \\ \int_0^{2\pi} e^{a\cos\theta} \cos(\sin\theta) d\theta &= 2\pi \\ \int_0^{\pi} e^{a\cos\theta} \cos(\sin\theta) d\theta &= \pi\end{aligned}$$

### Solution 11.10

1. We factor the integrand to see that there are singularities at the cube roots of 9.

$$\frac{z}{z^3 - 9} = \frac{z}{(z - \sqrt[3]{9})(z - \sqrt[3]{9}e^{i2\pi/3})(z - \sqrt[3]{9}e^{-i2\pi/3})}$$

Let  $C_1$ ,  $C_2$  and  $C_3$  be contours around  $z = \sqrt[3]{9}$ ,  $z = \sqrt[3]{9}e^{i2\pi/3}$  and  $z = \sqrt[3]{9}e^{-i2\pi/3}$ . See Figure 11.4. Let  $D$  be the domain between  $C$ ,  $C_1$  and  $C_2$ , i.e. the boundary of  $D$  is the union of  $C$ ,  $-C_1$  and  $-C_2$ . Since the integrand is analytic in  $D$ , the integral along the boundary of  $D$  vanishes.

$$\int_{\partial D} \frac{z}{z^3 - 9} dz = \int_C \frac{z}{z^3 - 9} dz + \int_{-C_1} \frac{z}{z^3 - 9} dz + \int_{-C_2} \frac{z}{z^3 - 9} dz + \int_{-C_3} \frac{z}{z^3 - 9} dz = 0$$

From this we see that the integral along  $C$  is equal to the sum of the integrals along  $C_1$ ,  $C_2$  and  $C_3$ . (We could also see this by deforming  $C$  onto  $C_1$ ,  $C_2$  and  $C_3$ .)

$$\int_C \frac{z}{z^3 - 9} dz = \int_{C_1} \frac{z}{z^3 - 9} dz + \int_{C_2} \frac{z}{z^3 - 9} dz + \int_{C_3} \frac{z}{z^3 - 9} dz$$

We use the Cauchy Integral Formula to evaluate the integrals along  $C_1$ ,  $C_2$  and  $C_3$ .

$$\begin{aligned} \int_C \frac{z}{z^3 - 9} dz &= \int_{C_1} \frac{z}{(z - \sqrt[3]{9})(z - \sqrt[3]{9}e^{i2\pi/3})(z - \sqrt[3]{9}e^{-i2\pi/3})} dz \\ &\quad + \int_{C_2} \frac{z}{(z - \sqrt[3]{9})(z - \sqrt[3]{9}e^{i2\pi/3})(z - \sqrt[3]{9}e^{-i2\pi/3})} dz \\ &\quad + \int_{C_3} \frac{z}{(z - \sqrt[3]{9})(z - \sqrt[3]{9}e^{i2\pi/3})(z - \sqrt[3]{9}e^{-i2\pi/3})} dz \\ &= i2\pi \left[ \frac{z}{(z - \sqrt[3]{9}e^{i2\pi/3})(z - \sqrt[3]{9}e^{-i2\pi/3})} \right]_{z=\sqrt[3]{9}} \\ &\quad + i2\pi \left[ \frac{z}{(z - \sqrt[3]{9})(z - \sqrt[3]{9}e^{-i2\pi/3})} \right]_{z=\sqrt[3]{9}e^{i2\pi/3}} \\ &\quad + i2\pi \left[ \frac{z}{(z - \sqrt[3]{9})(z - \sqrt[3]{9}e^{i2\pi/3})} \right]_{z=\sqrt[3]{9}e^{-i2\pi/3}} \\ &= i2\pi 3^{-5/3} (1 - e^{i\pi/3} + e^{i2\pi/3}) \\ &= 0 \end{aligned}$$

2. The integrand has singularities at  $z = 0$  and  $z = 4$ . Only the singularity at  $z = 0$  lies inside the contour. We use

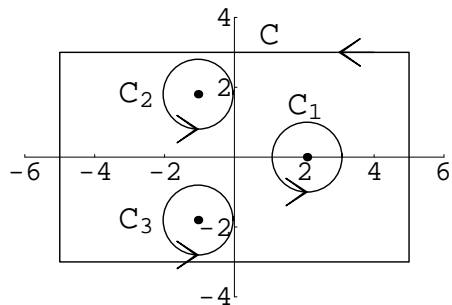

Figure 11.4: The contours for  $\frac{z}{z^3-9}$ .

the Cauchy Integral Formula to evaluate the integral.

$$\begin{aligned}
 \int_C \frac{\sin z}{z^2(z-4)} dz &= i2\pi \left[ \frac{d \sin z}{dz z-4} \right]_{z=0} \\
 &= i2\pi \left[ \frac{\cos z}{z-4} - \frac{\sin z}{(z-4)^2} \right]_{z=0} \\
 &= -\frac{i\pi}{2}
 \end{aligned}$$

3. We factor the integrand to see that there are singularities at  $z = 0$  and  $z = -i$ .

$$\int_C \frac{(z^3 + z + i) \sin z}{z^4 + iz^3} dz = \int_C \frac{(z^3 + z + i) \sin z}{z^3(z+i)} dz$$

Let  $C_1$  and  $C_2$  be contours around  $z = 0$  and  $z = -i$ . See Figure 11.5. Let  $D$  be the domain between  $C$ ,  $C_1$  and  $C_2$ , i.e. the boundary of  $D$  is the union of  $C$ ,  $-C_1$  and  $-C_2$ . Since the integrand is analytic in  $D$ , the integral along the boundary of  $D$  vanishes.

$$\int_{\partial D} = \int_C + \int_{-C_1} + \int_{-C_2} = 0$$

From this we see that the integral along  $C$  is equal to the sum of the integrals along  $C_1$  and  $C_2$ . (We could also see this by deforming  $C$  onto  $C_1$  and  $C_2$ .)

$$\int_C = \int_{C_1} + \int_{C_2}$$

We use the Cauchy Integral Formula to evaluate the integrals along  $C_1$  and  $C_2$ .

$$\begin{aligned} \int_C \frac{(z^3 + z + i) \sin z}{z^4 + iz^3} dz &= \int_{C_1} \frac{(z^3 + z + i) \sin z}{z^3(z + i)} dz + \int_{C_2} \frac{(z^3 + z + i) \sin z}{z^3(z + i)} dz \\ &= i2\pi \left[ \frac{(z^3 + z + i) \sin z}{z^3} \right]_{z=-i} + \frac{i2\pi}{2!} \left[ \frac{d^2}{dz^2} \frac{(z^3 + z + i) \sin z}{z + i} \right]_{z=0} \\ &= i2\pi(-i \sinh(1)) + i\pi \left[ 2 \left( \frac{3z^2 + 1}{z + i} - \frac{z^3 + z + i}{(z + i)^2} \right) \cos z \right. \\ &\quad \left. + \left( \frac{6z}{z + i} - \frac{2(3z^2 + 1)}{(z + i)^2} + \frac{2(z^3 + z + i)}{(z + i)^3} - \frac{z^3 + z + i}{z + i} \right) \sin z \right]_{z=0} \\ &= 2\pi \sinh(1) \end{aligned}$$

4. We consider the integral

$$\int_C \frac{e^{zt}}{z^2(z + 1)} dz.$$

There are singularities at  $z = 0$  and  $z = -1$ .

Let  $C_1$  and  $C_2$  be contours around  $z = 0$  and  $z = -1$ . See Figure 11.6. We deform  $C$  onto  $C_1$  and  $C_2$ .

$$\int_C = \int_{C_1} + \int_{C_2}$$



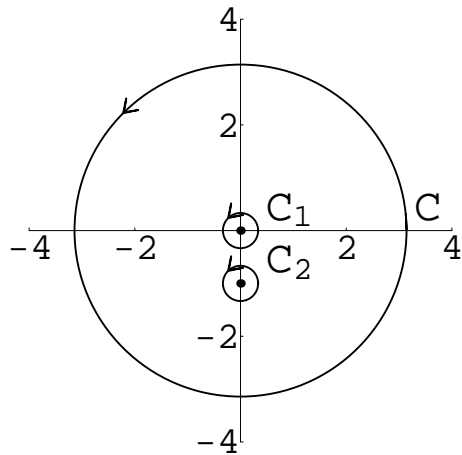

Figure 11.5: The contours for  $\frac{(z^3+z+i)\sin z}{z^4+iz^3}$ .

We use the Cauchy Integral Formula to evaluate the integrals along  $C_1$  and  $C_2$ .

$$\begin{aligned}
 \int_C \frac{e^{zt}}{z^2(z+1)} dz &= \int_{C_1} \frac{e^{zt}}{z^2(z+1)} dz + \int_{C_2} \frac{e^{zt}}{z^2(z+1)} dz \\
 &= i2\pi \left[ \frac{e^{zt}}{z^2} \right]_{z=-1} + i2\pi \left[ \frac{d}{dz} \frac{e^{zt}}{(z+1)} \right]_{z=0} \\
 &= i2\pi e^{-t} + i2\pi \left[ \frac{t e^{zt}}{(z+1)} - \frac{e^{zt}}{(z+1)^2} \right]_{z=0} \\
 &= i2\pi(e^{-t} + t - 1)
 \end{aligned}$$

### Solution 11.11

Liouville's Theorem states that if  $f(z)$  is analytic and bounded in the complex plane then  $f(z)$  is a constant.

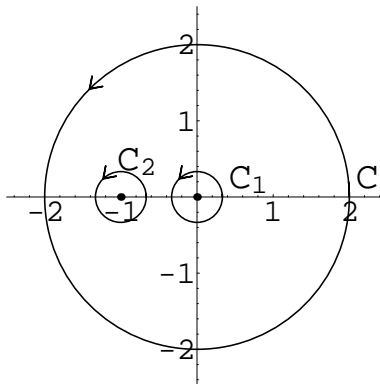

Figure 11.6: The contours for  $\frac{e^{zt}}{z^2(z+1)}$ .

1. Since  $f(z)$  is analytic,  $e^{f(z)}$  is analytic. The modulus of  $e^{f(z)}$  is bounded.

$$|e^{f(z)}| = e^{\Re(f(z))} \leq e^M$$

By Liouville's Theorem we conclude that  $e^{f(z)}$  is constant and hence  $f(z)$  is constant.

2. We know that  $f(z)$  is entire and  $|f^{(5)}(z)|$  is bounded in the complex plane. Since  $f(z)$  is analytic, so is  $f^{(5)}(z)$ . We apply Liouville's Theorem to  $f^{(5)}(z)$  to conclude that it is a constant. Then we integrate to determine the form of  $f(z)$ .

$$f(z) = c_5 z^5 + c_4 z^4 + c_3 z^3 + c_2 z^2 + c_1 z + c_0$$

Here  $c_5$  is the value of  $f^{(5)}(z)$  and  $c_4$  through  $c_0$  are constants of integration. We see that  $f(z)$  is a polynomial of degree at most five.

### Solution 11.12

For this problem we will use the Extremum Modulus Theorem: Let  $f(z)$  be analytic in a closed, connected domain,  $D$ . The extreme values of the modulus of the function must occur on the boundary. If  $|f(z)|$  has an interior extrema, then the function is a constant.

Since  $|f(z)|$  has an interior extrema,  $|f(0)| = |e^z| = 1$ , we conclude that  $f(z)$  is a constant on  $D$ . Since we know the value at  $z = 0$ , we know that  $f(z) = e^z$ .

### Solution 11.13

First we determine the radius of convergence of the series with the ratio test.

$$\begin{aligned} R &= \lim_{k \rightarrow \infty} \left| \frac{k^4/4^k}{(k+1)^4/4^{k+1}} \right| \\ &= 4 \lim_{k \rightarrow \infty} \frac{k^4}{(k+1)^4} \\ &= 4 \lim_{k \rightarrow \infty} \frac{24}{24} \\ &= 4 \end{aligned}$$

The series converges absolutely for  $|z| < 4$ .

1. Since the integrand is analytic inside and on the contour of integration, the integral vanishes by Cauchy's Theorem.
- 2.

$$\begin{aligned} \int_C \frac{f(z)}{z^3} dz &= \int_C \sum_{k=0}^{\infty} k^4 \left(\frac{z}{4}\right)^k \frac{1}{z^3} dz \\ &= \int_C \sum_{k=1}^{\infty} \frac{k^4}{4^k} z^{k-3} dz \\ &= \int_C \sum_{k=-2}^{\infty} \frac{(k+3)^4}{4^{k+3}} z^k dz \\ &= \int_C \frac{1}{4z^2} dz + \int_C \frac{1}{z} dz + \int_C \sum_{k=0}^{\infty} \frac{(k+3)^4}{4^{k+3}} z^k dz \end{aligned}$$

We can parameterize the first integral to show that it vanishes. The second integral has the value  $i2\pi$  by the Cauchy-Goursat Theorem. The third integral vanishes by Cauchy's Theorem as the integrand is analytic inside and on the contour.

$$\int_C \frac{f(z)}{z^3} dz = i2\pi$$

# Chapter 12

## Series and Convergence

You are not thinking. You are merely being logical.

- Neils Bohr

### 12.1 Series of Constants

#### 12.1.1 Definitions

**Convergence of Sequences.** The infinite sequence  $\{a_n\}_{n=0}^{\infty} \equiv a_0, a_1, a_2, \dots$  is said to converge if

$$\lim_{n \rightarrow \infty} a_n = a$$

for some constant  $a$ . If the limit does not exist, then the sequence diverges. Recall the definition of the limit in the above formula: For any  $\epsilon > 0$  there exists an  $N \in \mathbb{Z}$  such that  $|a - a_n| < \epsilon$  for all  $n > N$ .

**Example 12.1.1** *The sequence  $\{\sin(n)\}$  is divergent. The sequence is bounded above and below, but boundedness does not imply convergence.*

**Cauchy Convergence Criterion.** Note that there is something a little fishy about the above definition. We should be able to say if a sequence converges without first finding the constant to which it converges. We fix this problem with the *Cauchy convergence criterion*. A sequence  $\{a_n\}$  converges if and only if for any  $\epsilon > 0$  there exists an  $N$  such that  $|a_n - a_m| < \epsilon$  for all  $n, m > N$ . The Cauchy convergence criterion is equivalent to the definition we had before. For some problems it is handier to use. Now we don't need to know the limit of a sequence to show that it converges.

**Convergence of Series.** The series  $\sum_{n=1}^{\infty} a_n$  converges if the sequence of *partial sums*,  $S_N = \sum_{n=0}^{N-1} a_n$ , converges. That is,

$$\lim_{N \rightarrow \infty} S_N = \lim_{N \rightarrow \infty} \sum_{n=0}^{N-1} a_n = \text{constant}.$$

If the limit does not exist, then the series diverges. A necessary condition for the convergence of a series is that

$$\lim_{n \rightarrow \infty} a_n = 0.$$

(See Exercise 12.1.) Otherwise the sequence of partial sums would not converge.

**Example 12.1.2** The series  $\sum_{n=0}^{\infty} (-1)^n = 1 - 1 + 1 - 1 + \dots$  is divergent because the sequence of partial sums,  $\{S_N\} = 1, 0, 1, 0, 1, 0, \dots$  is divergent.

**Tail of a Series.** An infinite series,  $\sum_{n=0}^{\infty} a_n$ , converges or diverges with its tail. That is, for fixed  $N$ ,  $\sum_{n=0}^{\infty} a_n$  converges if and only if  $\sum_{n=N}^{\infty} a_n$  converges. This is because the sum of the first  $N$  terms of a series is just a number. Adding or subtracting a number to a series does not change its convergence.

**Absolute Convergence.** The series  $\sum_{n=0}^{\infty} a_n$  converges absolutely if  $\sum_{n=0}^{\infty} |a_n|$  converges. Absolute convergence implies convergence. If a series is convergent, but not absolutely convergent, then it is said to be *conditionally convergent*.

The terms of an absolutely convergent series can be rearranged in any order and the series will still converge to the same sum. This is not true of conditionally convergent series. Rearranging the terms of a conditionally convergent

series may change the sum. In fact, the terms of a conditionally convergent series may be rearranged to obtain any desired sum.

**Example 12.1.3** *The alternating harmonic series,*

$$1 - \frac{1}{2} + \frac{1}{3} - \frac{1}{4} + \cdots,$$

*converges, (Exercise 12.4). Since*

$$1 + \frac{1}{2} + \frac{1}{3} + \frac{1}{4} + \cdots$$

*diverges, (Exercise 12.5), the alternating harmonic series is not absolutely convergent. Thus the terms can be rearranged to obtain any sum, (Exercise 12.6).*

**Finite Series and Residuals.** Consider the series  $f(z) = \sum_{n=0}^{\infty} a_n(z)$ . We will denote the sum of the first  $N$  terms in the series as

$$S_N(z) = \sum_{n=0}^{N-1} a_n(z).$$

We will denote the *residual* after  $N$  terms as

$$R_N(z) \equiv f(z) - S_N(z) = \sum_{n=N}^{\infty} a_n(z).$$

## 12.1.2 Special Series

**Geometric Series.** One of the most important series in mathematics is the *geometric series*,<sup>1</sup>

$$\sum_{n=0}^{\infty} z^n = 1 + z + z^2 + z^3 + \cdots .$$

---

<sup>1</sup> The series is so named because the terms grow or decay geometrically. Each term in the series is a constant times the previous term.

The series clearly diverges for  $|z| \geq 1$  since the terms do not vanish as  $n \rightarrow \infty$ . Consider the partial sum,  $S_N(z) \equiv \sum_{n=0}^{N-1} z^n$ , for  $|z| < 1$ .

$$\begin{aligned}(1-z)S_N(z) &= (1-z) \sum_{n=0}^{N-1} z^n \\ &= \sum_{n=0}^{N-1} z^n - \sum_{n=1}^N z^n \\ &= (1+z+\cdots+z^{N-1}) - (z+z^2+\cdots+z^N) \\ &= 1-z^N\end{aligned}$$

$$\sum_{n=0}^{N-1} z^n = \frac{1-z^N}{1-z} \rightarrow \frac{1}{1-z} \quad \text{as } N \rightarrow \infty.$$

The limit of the partial sums is  $\frac{1}{1-z}$ .

$$\sum_{n=0}^{\infty} z^n = \frac{1}{1-z} \quad \text{for } |z| < 1$$

**Harmonic Series.** Another important series is the *harmonic series*,

$$\sum_{n=1}^{\infty} \frac{1}{n^\alpha} = 1 + \frac{1}{2^\alpha} + \frac{1}{3^\alpha} + \cdots.$$

The series is absolutely convergent for  $\Re(\alpha) > 1$  and absolutely divergent for  $\Re(\alpha) \leq 1$ , (see the Exercise 12.8). The *Riemann zeta function*  $\zeta(\alpha)$  is defined as the sum of the harmonic series.

$$\zeta(\alpha) = \sum_{n=1}^{\infty} \frac{1}{n^\alpha}$$



The *alternating harmonic series* is

$$\sum_{n=1}^{\infty} \frac{(-1)^{n+1}}{n^{\alpha}} = 1 - \frac{1}{2^{\alpha}} + \frac{1}{3^{\alpha}} - \frac{1}{4^{\alpha}} + \cdots .$$

Again, the series is absolutely convergent for  $\Re(\alpha) > 1$  and absolutely divergent for  $\Re(\alpha) \leq 1$ .

### 12.1.3 Convergence Tests

The Comparison Test.

**Result 12.1.1** The series of positive terms  $\sum a_n$  converges if there exists a convergent series  $\sum b_n$  such that  $a_n \leq b_n$  for all  $n$ . Similarly,  $\sum a_n$  diverges if there exists a divergent series  $\sum b_n$  such that  $a_n \geq b_n$  for all  $n$ .

**Example 12.1.4** Consider the series

$$\sum_{n=1}^{\infty} \frac{1}{2^{n^2}} .$$

We can rewrite this as

$$\sum_{\substack{n=1 \\ n \text{ a perfect square}}}^{\infty} \frac{1}{2^n} .$$

Then by comparing this series to the geometric series,

$$\sum_{n=1}^{\infty} \frac{1}{2^n} = 1,$$

we see that it is convergent.

## Integral Test.

**Result 12.1.2** If the coefficients  $a_n$  of a series  $\sum_{n=0}^{\infty} a_n$  are monotonically decreasing and can be extended to a monotonically decreasing function of the continuous variable  $x$ ,

$$a(x) = a_n \quad \text{for } x \in \mathbb{Z}^{0+},$$

then the series converges or diverges with the integral

$$\int_0^{\infty} a(x) \, dx.$$

**Example 12.1.5** Consider the series  $\sum_{n=1}^{\infty} \frac{1}{n^2}$ . Define the functions  $s_l(x)$  and  $s_r(x)$ , (left and right),

$$s_l(x) = \frac{1}{(\lceil x \rceil)^2}, \quad s_r(x) = \frac{1}{(\lfloor x \rfloor)^2}.$$

Recall that  $\lfloor x \rfloor$  is the greatest integer function, the greatest integer which is less than or equal to  $x$ .  $\lceil x \rceil$  is the least integer function, the least integer greater than or equal to  $x$ . We can express the series as integrals of these functions.

$$\sum_{n=1}^{\infty} \frac{1}{n^2} = \int_0^{\infty} s_l(x) \, dx = \int_1^{\infty} s_r(x) \, dx$$

In Figure 12.1 these functions are plotted against  $y = 1/x^2$ . From the graph, it is clear that we can obtain a lower and

upper bound for the series.

$$\int_1^{\infty} \frac{1}{x^2} dx \leq \sum_{n=1}^{\infty} \frac{1}{n^2} \leq 1 + \int_1^{\infty} \frac{1}{x^2} dx$$

$$1 \leq \sum_{n=1}^{\infty} \frac{1}{n^2} \leq 2$$



Figure 12.1: Upper and Lower bounds to  $\sum_{n=1}^{\infty} 1/n^2$ .

In general, we have

$$\int_m^{\infty} a(x) dx \leq \sum_{n=m}^{\infty} a_n \leq a_m + \int_m^{\infty} a(x) dx.$$

Thus we see that the sum converges or diverges with the integral.

### The Ratio Test.

**Result 12.1.3** The series  $\sum a_n$  converges absolutely if

$$\lim_{n \rightarrow \infty} \left| \frac{a_{n+1}}{a_n} \right| < 1.$$

If the limit is greater than unity, then the series diverges. If the limit is unity, the test fails.

If the limit is greater than unity, then the terms are eventually increasing with  $n$ . Since the terms do not vanish, the sum is divergent. If the limit is less than unity, then there exists some  $N$  such that

$$\left| \frac{a_{n+1}}{a_n} \right| \leq r < 1 \quad \text{for all } n \geq N.$$

From this we can show that  $\sum_{n=0}^{\infty} a_n$  is absolutely convergent by comparing it to the geometric series.

$$\begin{aligned} \sum_{n=N}^{\infty} |a_n| &\leq |a_N| \sum_{n=0}^{\infty} r^n \\ &= |a_N| \frac{1}{1-r} \end{aligned}$$

**Example 12.1.6** Consider the series,

$$\sum_{n=1}^{\infty} \frac{e^n}{n!}.$$

We apply the ratio test to test for absolute convergence.

$$\begin{aligned} \lim_{n \rightarrow \infty} \left| \frac{a_{n+1}}{a_n} \right| &= \lim_{n \rightarrow \infty} \frac{e^{n+1} n!}{e^n (n+1)!} \\ &= \lim_{n \rightarrow \infty} \frac{e}{n+1} \\ &= 0 \end{aligned}$$

The series is absolutely convergent.

**Example 12.1.7** Consider the series,

$$\sum_{n=1}^{\infty} \frac{1}{n^2},$$

which we know to be absolutely convergent. We apply the ratio test.

$$\begin{aligned}\lim_{n \rightarrow \infty} \left| \frac{a_{n+1}}{a_n} \right| &= \lim_{n \rightarrow \infty} \frac{1/(n+1)^2}{1/n^2} \\ &= \lim_{n \rightarrow \infty} \frac{n^2}{n^2 + 2n + 1} \\ &= \lim_{n \rightarrow \infty} \frac{1}{1 + 2/n + 1/n^2} \\ &= 1\end{aligned}$$

The test fails to predict the absolute convergence of the series.

### The Root Test.

**Result 12.1.4** The series  $\sum a_n$  converges absolutely if

$$\lim_{n \rightarrow \infty} |a_n|^{1/n} < 1.$$

If the limit is greater than unity, then the series diverges. If the limit is unity, the test fails. More generally, we can test that

$$\limsup |a_n|^{1/n} < 1.$$

If the limit is greater than unity, then the terms in the series do not vanish as  $n \rightarrow \infty$ . This implies that the sum does not converge. If the limit is less than unity, then there exists some  $N$  such that

$$|a_n|^{1/n} \leq r < 1 \quad \text{for all } n \geq N.$$

We bound the tail of the series of  $|a_n|$ .

$$\begin{aligned}\sum_{n=N}^{\infty} |a_n| &= \sum_{n=N}^{\infty} (|a_n|^{1/n})^n \\ &\leq \sum_{n=N}^{\infty} r^n \\ &= \frac{r^N}{1-r}\end{aligned}$$

$\sum_{n=0}^{\infty} a_n$  is absolutely convergent.

**Example 12.1.8** Consider the series

$$\sum_{n=0}^{\infty} n^a b^n,$$

where  $a$  and  $b$  are real constants. We use the root test to check for absolute convergence.

$$\begin{aligned}\lim_{n \rightarrow \infty} |n^a b^n|^{1/n} &< 1 \\ |b| \lim_{n \rightarrow \infty} n^{a/n} &< 1 \\ |b| \exp\left(\lim_{n \rightarrow \infty} \frac{1 \ln n}{n}\right) &< 1 \\ |b| e^0 &< 1 \\ |b| &< 1\end{aligned}$$

Thus we see that the series converges absolutely for  $|b| < 1$ . Note that the value of  $a$  does not affect the absolute convergence.

**Example 12.1.9** Consider the absolutely convergent series,

$$\sum_{n=1}^{\infty} \frac{1}{n^2}.$$

We apply the root test.

$$\begin{aligned}\lim_{n \rightarrow \infty} |a_n|^{1/n} &= \lim_{n \rightarrow \infty} \left| \frac{1}{n^2} \right|^{1/n} \\ &= \lim_{n \rightarrow \infty} n^{-2/n} \\ &= \lim_{n \rightarrow \infty} e^{-\frac{2}{n} \ln n} \\ &= e^0 \\ &= 1\end{aligned}$$

It fails to predict the convergence of the series.

## Raabe's Test

**Result 12.1.5** The series  $\sum a_n$  converges absolutely if

$$\lim_{n \rightarrow \infty} n \left( 1 - \left| \frac{a_{n+1}}{a_n} \right| \right) > 1.$$

If the limit is less than unity, then the series diverges or converges conditionally. If the limit is unity, the test fails.

**Result 12.1.6** Consider the series  $\sum a_n$ . If

$$\frac{a_{n+1}}{a_n} = 1 - \frac{L}{n} + \frac{b_n}{n^2}$$

where  $b_n$  is bounded then the series converges absolutely if  $L > 1$ . Otherwise the series diverges or converges conditionally.

## 12.2 Uniform Convergence

**Continuous Functions.** A function  $f(z)$  is continuous in a closed domain if, given any  $\epsilon > 0$ , there exists a  $\delta > 0$  such that  $|f(z) - f(\zeta)| < \epsilon$  for all  $|z - \zeta| < \delta$  in the domain.

An equivalent definition is that  $f(z)$  is continuous in a closed domain if

$$\lim_{\zeta \rightarrow z} f(\zeta) = f(z)$$

for all  $z$  in the domain.

**Convergence.** Consider a series in which the terms are functions of  $z$ ,  $\sum_{n=0}^{\infty} a_n(z)$ . The series is convergent in a domain if the series converges for each point  $z$  in the domain. We can then define the function  $f(z) = \sum_{n=0}^{\infty} a_n(z)$ . We can state the convergence criterion as: For any given  $\epsilon > 0$  there exists a function  $N(z)$  such that

$$|f(z) - S_{N(z)}(z)| = \left| f(z) - \sum_{n=0}^{N(z)-1} a_n(z) \right| < \epsilon$$

for all  $z$  in the domain. Note that the rate of convergence, i.e. the number of terms,  $N(z)$  required for the absolute error to be less than  $\epsilon$ , is a function of  $z$ .



**Uniform Convergence.** Consider a series  $\sum_{n=0}^{\infty} a_n(z)$  that is convergent in some domain. If the rate of convergence is independent of  $z$  then the series is said to be uniformly convergent. Stating this a little more mathematically, the series is uniformly convergent in the domain if for any given  $\epsilon > 0$  there exists an  $N$ , independent of  $z$ , such that

$$|f(z) - S_N(z)| = \left| f(z) - \sum_{n=1}^N a_n(z) \right| < \epsilon$$

for all  $z$  in the domain.

## 12.2.1 Tests for Uniform Convergence

**Weierstrass M-test.** The Weierstrass M-test is useful in determining if a series is uniformly convergent. The series  $\sum_{n=0}^{\infty} a_n(z)$  is uniformly and absolutely convergent in a domain if there exists a convergent series of positive terms  $\sum_{n=0}^{\infty} M_n$  such that  $|a_n(z)| \leq M_n$  for all  $z$  in the domain. This condition first implies that the series is absolutely convergent for all  $z$  in the domain. The condition  $|a_n(z)| \leq M_n$  also ensures that the rate of convergence is independent of  $z$ , which is the criterion for uniform convergence.

Note that absolute convergence and uniform convergence are independent. A series of functions may be absolutely convergent without being uniformly convergent or vice versa. The Weierstrass M-test is a sufficient but not a necessary condition for uniform convergence. The Weierstrass M-test can succeed only if the series is uniformly and absolutely convergent.

**Example 12.2.1** *The series*

$$f(x) = \sum_{n=1}^{\infty} \frac{\sin x}{n(n+1)}$$

*is uniformly and absolutely convergent for all real  $x$  because  $|\frac{\sin x}{n(n+1)}| < \frac{1}{n^2}$  and  $\sum_{n=1}^{\infty} \frac{1}{n^2}$  converges.*

**Dirichlet Test.** Consider a sequence of monotone decreasing, positive constants  $c_n$  with limit zero. If all the partial sums of  $a_n(z)$  are bounded in some closed domain, that is

$$\left| \sum_{n=1}^N a_n(z) \right| < \text{constant}$$

for all  $N$ , then  $\sum_{n=1}^{\infty} c_n a_n(z)$  is uniformly convergent in that closed domain. Note that the Dirichlet test does not imply that the series is absolutely convergent.

**Example 12.2.2** Consider the series,

$$\sum_{n=1}^{\infty} \frac{\sin(nx)}{n}.$$

We cannot use the Weierstrass  $M$ -test to determine if the series is uniformly convergent on an interval. While it is easy to bound the terms with  $|\sin(nx)/n| \leq 1/n$ , the sum

$$\sum_{n=1}^{\infty} \frac{1}{n}$$

does not converge. Thus we will try the Dirichlet test. Consider the sum  $\sum_{n=1}^{N-1} \sin(nx)$ . This sum can be evaluated in closed form. (See Exercise 12.9.)

$$\sum_{n=1}^{N-1} \sin(nx) = \begin{cases} 0 & \text{for } x = 2\pi k \\ \frac{\cos(x/2) - \cos((N-1/2)x)}{2 \sin(x/2)} & \text{for } x \neq 2\pi k \end{cases}$$

The partial sums have infinite discontinuities at  $x = 2\pi k$ ,  $k \in \mathbb{Z}$ . The partial sums are bounded on any closed interval that does not contain an integer multiple of  $2\pi$ . By the Dirichlet test, the sum  $\sum_{n=1}^{\infty} \frac{\sin(nx)}{n}$  is uniformly convergent on any such closed interval. The series may not be uniformly convergent in neighborhoods of  $x = 2k\pi$ .

## 12.2.2 Uniform Convergence and Continuous Functions.

Consider a series  $f(z) = \sum_{n=1}^{\infty} a_n(z)$  that is uniformly convergent in some domain and whose terms  $a_n(z)$  are continuous functions. Since the series is uniformly convergent, for any given  $\epsilon > 0$  there exists an  $N$  such that  $|R_N| < \epsilon$  for all  $z$  in the domain.

Since the finite sum  $S_N$  is continuous, for that  $\epsilon$  there exists a  $\delta > 0$  such that  $|S_N(z) - S_N(\zeta)| < \epsilon$  for all  $\zeta$  in the domain satisfying  $|z - \zeta| < \delta$ .

We combine these two results to show that  $f(z)$  is continuous.

$$\begin{aligned} |f(z) - f(\zeta)| &= |S_N(z) + R_N(z) - S_N(\zeta) - R_N(\zeta)| \\ &\leq |S_N(z) - S_N(\zeta)| + |R_N(z)| + |R_N(\zeta)| \\ &< 3\epsilon \quad \text{for } |z - \zeta| < \delta \end{aligned}$$

**Result 12.2.1** A uniformly convergent series of continuous terms represents a continuous function.

**Example 12.2.3** Again consider  $\sum_{n=1}^{\infty} \frac{\sin(nx)}{n}$ . In Example 12.2.2 we showed that the convergence is uniform in any closed interval that does not contain an integer multiple of  $2\pi$ . In Figure 12.2 is a plot of the first 10 and then 50 terms in the series and finally the function to which the series converges. We see that the function has jump discontinuities at  $x = 2k\pi$  and is continuous on any closed interval not containing one of those points.

## 12.3 Uniformly Convergent Power Series

**Power Series.** Power series are series of the form

$$\sum_{n=0}^{\infty} a_n(z - z_0)^n.$$

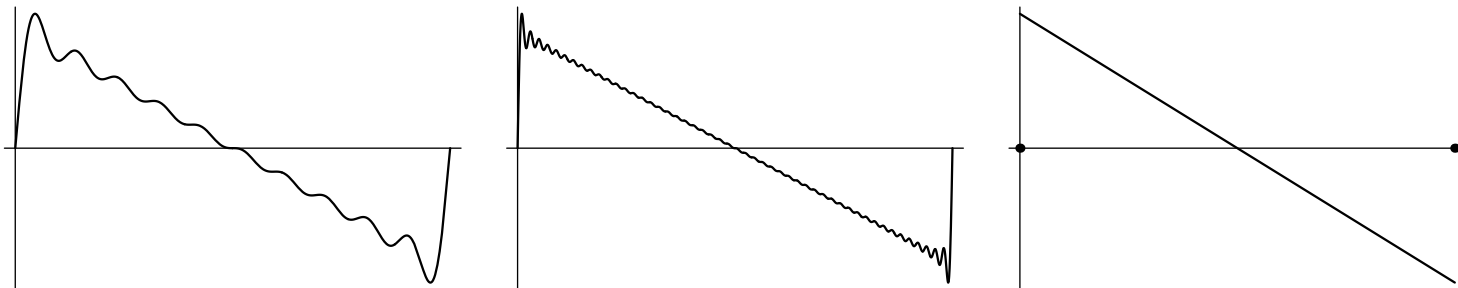

Figure 12.2: Ten, Fifty and all the Terms of  $\sum_{n=1}^{\infty} \frac{\sin(nx)}{n}$ .

**Domain of Convergence of a Power Series** Consider the series  $\sum_{n=0}^{\infty} a_n z^n$ . Let the series converge at some point  $z_0$ . Then  $|a_n z_0^n|$  is bounded by some constant  $A$  for all  $n$ , so

$$|a_n z^n| = |a_n z_0^n| \left| \frac{z}{z_0} \right|^n < A \left| \frac{z}{z_0} \right|^n$$

This comparison test shows that the series converges absolutely for all  $z$  satisfying  $|z| < |z_0|$ .

Suppose that the series diverges at some point  $z_1$ . Then the series could not converge for any  $|z| > |z_1|$  since this would imply convergence at  $z_1$ . Thus there exists some circle in the  $z$  plane such that the power series converges absolutely inside the circle and diverges outside the circle.

**Result 12.3.1** The domain of convergence of a power series is a circle in the complex plane.

**Radius of Convergence of Power Series.** Consider a power series

$$f(z) = \sum_{n=0}^{\infty} a_n z^n$$

Applying the ratio test, we see that the series converges if

$$\lim_{n \rightarrow \infty} \frac{|a_{n+1}z^{n+1}|}{|a_n z^n|} < l$$

$$\lim_{n \rightarrow \infty} \frac{|a_{n+1}|}{|a_n|} |z| < 1$$

$$|z| < \lim_{n \rightarrow \infty} \frac{|a_n|}{|a_{n+1}|}$$

**Result 12.3.2 Ratio formula.** The radius of convergence of the power series

$$\sum_{n=0}^{\infty} a_n z^n$$

is

$$R = \lim_{n \rightarrow \infty} \frac{|a_n|}{|a_{n+1}|}$$

when the limit exists.

**Result 12.3.3 Cauchy-Hadamard formula.** The radius of convergence of the power series:

$$\sum_{n=0}^{\infty} a_n z^n$$

is

$$R = \frac{1}{\limsup \sqrt[n]{|a_n|}}.$$

**Absolute Convergence of Power Series.** Consider a power series

$$f(z) = \sum_{n=0}^{\infty} a_n z^n$$

that converges for  $z = z_0$ . Let  $M$  be the value of the greatest term,  $a_n z_0^n$ . Consider any point  $z$  such that  $|z| < |z_0|$ . We can bound the residual of  $\sum_{n=0}^{\infty} |a_n z^n|$ ,

$$\begin{aligned} R_N(z) &= \sum_{n=N}^{\infty} |a_n z^n| \\ &= \sum_{n=N}^{\infty} \left| \frac{a_n z^n}{a_n z_0^n} \right| |a_n z_0^n| \\ &\leq M \sum_{n=N}^{\infty} \left| \frac{z}{z_0} \right|^n \end{aligned}$$

Since  $|z/z_0| < 1$ , this is a convergent geometric series.

$$\begin{aligned} &= M \left| \frac{z}{z_0} \right|^N \frac{1}{1 - |z/z_0|} \\ &\rightarrow 0 \quad \text{as } N \rightarrow \infty \end{aligned}$$

Thus the power series is absolutely convergent for  $|z| < |z_0|$ .

**Result 12.3.4** If the power series  $\sum_{n=0}^{\infty} a_n z^n$  converges for  $z = z_0$ , then the series converges absolutely for  $|z| < |z_0|$ .

**Example 12.3.1** Find the radii of convergence of the following series.

$$1. \sum_{n=1}^{\infty} nz^n$$

$$2. \sum_{n=1}^{\infty} n!z^n$$

$$3. \sum_{n=1}^{\infty} n!z^{n!}$$

1. We apply the ratio test to determine the radius of convergence.

$$R = \lim_{n \rightarrow \infty} \left| \frac{a_n}{a_{n+1}} \right| = \lim_{n \rightarrow \infty} \frac{n}{n+1} = 1$$

The series converges absolutely for  $|z| < 1$ .

2. We apply the ratio test to the series.

$$\begin{aligned} R &= \lim_{n \rightarrow \infty} \left| \frac{n!}{(n+1)!} \right| \\ &= \lim_{n \rightarrow \infty} \frac{1}{n+1} \\ &= 0 \end{aligned}$$

The series has a vanishing radius of convergence. It converges only for  $z = 0$ .

3. Again we apply the ratio test to determine the radius of convergence.

$$\begin{aligned} \lim_{n \rightarrow \infty} \left| \frac{(n+1)!z^{(n+1)!}}{n!z^{n!}} \right| &< 1 \\ \lim_{n \rightarrow \infty} (n+1)|z|^{(n+1)!-n!} &< 1 \\ \lim_{n \rightarrow \infty} (n+1)|z|^{(n)n!} &< 1 \\ \lim_{n \rightarrow \infty} (\ln(n+1) + (n)n! \ln|z|) &< 0 \\ \ln|z| &< \lim_{n \rightarrow \infty} \frac{-\ln(n+1)}{(n)n!} \\ \ln|z| &< 0 \\ |z| &< 1 \end{aligned}$$

The series converges absolutely for  $|z| < 1$ .

Alternatively we could determine the radius of convergence of the series with the comparison test.

$$\sum_{n=1}^{\infty} |n!z^{n!}| \leq \sum_{n=1}^{\infty} |nz^n|$$

$\sum_{n=1}^{\infty} nz^n$  has a radius of convergence of 1. Thus the series must have a radius of convergence of at least 1. Note that if  $|z| > 1$  then the terms in the series do not vanish as  $n \rightarrow \infty$ . Thus the series must diverge for all  $|z| \geq 1$ . Again we see that the radius of convergence is 1.

**Uniform Convergence of Power Series.** Consider a power series  $\sum_{n=0}^{\infty} a_n z^n$  that converges in the disk  $|z| < r_0$ . The sum converges absolutely for  $z$  in the closed disk,  $|z| \leq r < r_0$ . Since  $|a_n z^n| \leq |a_n r^n|$  and  $\sum_{n=0}^{\infty} |a_n r^n|$  converges, the power series is uniformly convergent in  $|z| \leq r < r_0$ .

**Result 12.3.5** If the power series  $\sum_{n=0}^{\infty} a_n z^n$  converges for  $|z| < r_0$  then the series converges uniformly for  $|z| \leq r < r_0$ .



**Example 12.3.2 Convergence and Uniform Convergence.** Consider the series

$$\log(1 - z) = - \sum_{n=1}^{\infty} \frac{z^n}{n}.$$

This series converges for  $|z| \leq 1, z \neq 1$ . Is the series uniformly convergent in this domain? The residual after  $N$  terms  $R_N$  is

$$R_N(z) = \sum_{n=N+1}^{\infty} \frac{z^n}{n}.$$

We can get a lower bound on the absolute value of the residual for real, positive  $z$ .

$$\begin{aligned} |R_N(x)| &= \sum_{n=N+1}^{\infty} \frac{x^n}{n} \\ &\leq \int_{N+1}^{\infty} \frac{x^\alpha}{\alpha} d\alpha \\ &= -\text{Ei}((N+1) \ln x) \end{aligned}$$

The exponential integral function,  $\text{Ei}(z)$ , is defined

$$\text{Ei}(z) = - \int_{-z}^{\infty} \frac{e^{-t}}{t} dt.$$

The exponential integral function is plotted in Figure 12.3. Since  $\text{Ei}(z)$  diverges as  $z \rightarrow 0$ , by choosing  $x$  sufficiently close to 1 the residual can be made arbitrarily large. Thus this series is not uniformly convergent in the domain  $|z| \leq 1, z \neq 1$ . The series is uniformly convergent for  $|z| \leq r < 1$ .

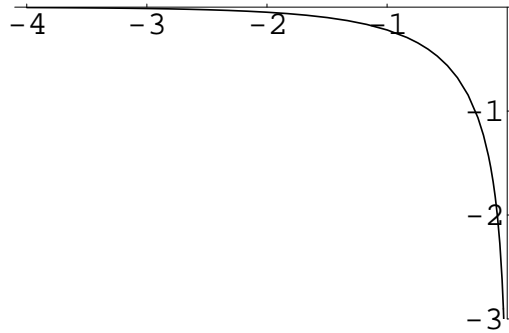

Figure 12.3: The Exponential Integral Function.

**Analyticity.** Recall that a sufficient condition for the analyticity of a function  $f(z)$  in a domain is that  $\oint_C f(z) dz = 0$  for all simple, closed contours in the domain.

Consider a power series  $f(z) = \sum_{n=0}^{\infty} a_n z^n$  that is uniformly convergent in  $|z| \leq r$ . If  $C$  is any simple, closed contour in the domain then  $\oint_C f(z) dz$  exists. Expanding  $f(z)$  into a finite series and a residual,

$$\oint_C f(z) dz = \oint_C (S_N(z) + R_N(z)) dz.$$

Since the series is uniformly convergent, for any given  $\epsilon > 0$  there exists an  $N_\epsilon$  such that  $|R_{N_\epsilon}| < \epsilon$  for all  $z$  in  $|z| \leq r$ . Let  $L$  be the length of the contour  $C$ .

$$\left| \oint_C R_{N_\epsilon}(z) dz \right| \leq L\epsilon \rightarrow 0 \quad \text{as } N_\epsilon \rightarrow \infty$$

$$\begin{aligned}
\oint_C f(z) dz &= \lim_{N \rightarrow \infty} \oint_C \left( \sum_{n=0}^{N-1} a_n z^n + R_N(z) \right) dz \\
&= \oint_C \sum_{n=0}^{\infty} a_n z^n \\
&= \sum_{n=0}^{\infty} a_n \oint_C z^n dz \\
&= 0
\end{aligned}$$

Thus  $f(z)$  is analytic for  $|z| < r$ .

**Result 12.3.6** A power series is analytic in its domain of uniform convergence.

## 12.4 Integration and Differentiation of Power Series

Consider a power series  $f(z) = \sum_{n=0}^{\infty} a_n z^n$  that is convergent in the disk  $|z| < r_0$ . Let  $C$  be any contour of finite length  $L$  lying entirely within the closed domain  $|z| \leq r < r_0$ . The integral of  $f(z)$  along  $C$  is

$$\int_C f(z) dz = \int_C (S_N(z) + R_N(z)) dz.$$

Since the series is uniformly convergent in the closed disk, for any given  $\epsilon > 0$ , there exists an  $N_\epsilon$  such that

$$|R_{N_\epsilon}(z)| < \epsilon \quad \text{for all } |z| \leq r.$$

We bound the absolute value of the integral of  $R_{N_\epsilon}(z)$ .

$$\begin{aligned}
\left| \int_C R_{N_\epsilon}(z) dz \right| &\leq \int_C |R_{N_\epsilon}(z)| dz \\
&< \epsilon L \\
&\rightarrow 0 \quad \text{as } N_\epsilon \rightarrow \infty
\end{aligned}$$

Thus

$$\begin{aligned}\int_C f(z) dz &= \lim_{N \rightarrow \infty} \int_C \sum_{n=0}^N a_n z^n dz \\ &= \lim_{N \rightarrow \infty} \sum_{n=0}^N a_n \int_C z^n dz \\ &= \sum_{n=0}^{\infty} a_n \int_C z^n dz\end{aligned}$$

**Result 12.4.1** If  $C$  is a contour lying in the domain of uniform convergence of the power series  $\sum_{n=0}^{\infty} a_n z^n$  then

$$\int_C \sum_{n=0}^{\infty} a_n z^n dz = \sum_{n=0}^{\infty} a_n \int_C z^n dz.$$

In the domain of uniform convergence of a series we can interchange the order of summation and a limit process. That is,

$$\lim_{z \rightarrow z_0} \sum_{n=0}^{\infty} a_n(z) = \sum_{n=0}^{\infty} \lim_{z \rightarrow z_0} a_n(z).$$

We can do this because the rate of convergence does not depend on  $z$ . Since differentiation is a limit process,

$$\frac{d}{dz} f(z) = \lim_{h \rightarrow 0} \frac{f(z+h) - f(z)}{h},$$

we would expect that we could differentiate a uniformly convergent series.

Since we showed that a uniformly convergent power series is equal to an analytic function, we can differentiate a power series in its domain of uniform convergence.

**Result 12.4.2** Power series can be differentiated in their domain of uniform convergence.

$$\frac{d}{dz} \sum_{n=0}^{\infty} a_n z^n = \sum_{n=0}^{\infty} (n+1) a_{n+1} z^n.$$

**Example 12.4.1 Differentiating a Series.** Consider the series from Example 12.3.2.

$$\log(1-z) = - \sum_{n=1}^{\infty} \frac{z^n}{n}$$

We differentiate this to obtain the geometric series.

$$\begin{aligned} -\frac{1}{1-z} &= - \sum_{n=1}^{\infty} z^{n-1} \\ \frac{1}{1-z} &= \sum_{n=0}^{\infty} z^n \end{aligned}$$

The geometric series is convergent for  $|z| < 1$  and uniformly convergent for  $|z| \leq r < 1$ . Note that the domain of convergence is different than the series for  $\log(1-z)$ . The geometric series does not converge for  $|z| = 1, z \neq 1$ . However, the domain of uniform convergence has remained the same.

## 12.5 Taylor Series

**Result 12.5.1 Taylor's Theorem.** Let  $f(z)$  be a function that is single-valued and analytic in  $|z - z_0| < R$ . For all  $z$  in this open disk,  $f(z)$  has the convergent Taylor series

$$f(z) = \sum_{n=0}^{\infty} \frac{f^{(n)}(z_0)}{n!} (z - z_0)^n. \quad (12.1)$$

We can also write this as

$$f(z) = \sum_{n=0}^{\infty} a_n (z - z_0)^n, \quad a_n = \frac{f^{(n)}(z_0)}{n!} = \frac{1}{i2\pi} \oint_C \frac{f(z)}{(z - z_0)^{n+1}} dz, \quad (12.2)$$

where  $C$  is a simple, positive, closed contour in  $0 < |z - z_0| < R$  that goes once around the point  $z_0$ .

**Proof of Taylor's Theorem.** Let's see why Result 12.5.1 is true. Consider a function  $f(z)$  that is analytic in  $|z| < R$ . (Considering  $z_0 \neq 0$  is only trivially more general as we can introduce the change of variables  $\zeta = z - z_0$ .) According to Cauchy's Integral Formula, (Result ??),

$$f(z) = \frac{1}{i2\pi} \oint_C \frac{f(\zeta)}{\zeta - z} d\zeta, \quad (12.3)$$

where  $C$  is a positive, simple, closed contour in  $0 < |\zeta - z| < R$  that goes once around  $z$ . We take this contour to be the circle about the origin of radius  $r$  where  $|z| < r < R$ . (See Figure 12.4.)

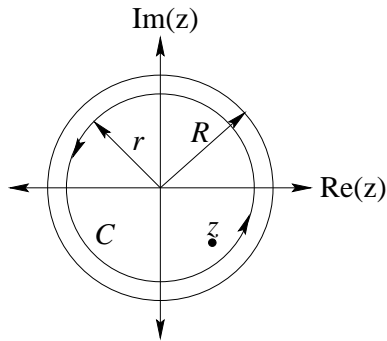

Figure 12.4: Graph of Domain of Convergence and Contour of Integration.

We expand  $\frac{1}{\zeta - z}$  in a geometric series,

$$\begin{aligned} \frac{1}{\zeta - z} &= \frac{1/\zeta}{1 - z/\zeta} \\ &= \frac{1}{\zeta} \sum_{n=0}^{\infty} \left(\frac{z}{\zeta}\right)^n, \quad \text{for } |z| < |\zeta| \\ &= \sum_{n=0}^{\infty} \frac{z^n}{\zeta^{n+1}}, \quad \text{for } |z| < |\zeta| \end{aligned}$$

We substitute this series into Equation 12.3.

$$f(z) = \frac{1}{i2\pi} \oint_C \left( \sum_{n=0}^{\infty} \frac{f(\zeta) z^n}{\zeta^{n+1}} \right) d\zeta$$

The series converges uniformly so we can interchange integration and summation.

$$= \sum_{n=0}^{\infty} \frac{z^n}{i2\pi} \oint_C \frac{f(\zeta)}{\zeta^{n+1}} d\zeta$$

Now we have derived Equation 12.2. To obtain Equation 12.1, we apply Cauchy's Integral Formula.

$$= \sum_{n=0}^{\infty} \frac{f^{(n)}(0)}{n!} z^n$$

There is a table of some commonly encountered Taylor series in Appendix H.

**Example 12.5.1** Consider the Taylor series expansion of  $1/(1-z)$  about  $z=0$ . Previously, we showed that this function is the sum of the geometric series  $\sum_{n=0}^{\infty} z^n$  and we used the ratio test to show that the series converged absolutely for  $|z| < 1$ . Now we find the series using Taylor's theorem. Since the nearest singularity of the function is at  $z=1$ , the radius of convergence of the series is 1. The coefficients in the series are

$$\begin{aligned} a_n &= \frac{1}{n!} \left[ \frac{d^n}{dz^n} \frac{1}{1-z} \right]_{z=0} \\ &= \frac{1}{n!} \left[ \frac{n!}{(1-z)^n} \right]_{z=0} \\ &= 1 \end{aligned}$$

Thus we have

$$\frac{1}{1-z} = \sum_{n=0}^{\infty} z^n, \quad \text{for } |z| < 1.$$



## 12.5.1 Newton's Binomial Formula.

**Result 12.5.2** For all  $|z| < 1$ ,  $a$  complex:

$$(1+z)^a = 1 + \binom{a}{1}z + \binom{a}{2}z^2 + \binom{a}{3}z^3 + \dots$$

where

$$\binom{a}{r} = \frac{a(a-1)(a-2)\cdots(a-r+1)}{r!}.$$

If  $a$  is complex, then the expansion is of the principle branch of  $(1+z)^a$ . We define

$$\binom{r}{0} = 1, \quad \binom{0}{r} = 0, \quad \text{for } r \neq 0, \quad \binom{0}{0} = 1.$$

**Example 12.5.2** Evaluate  $\lim_{n \rightarrow \infty} (1 + 1/n)^n$ .

First we expand  $(1 + 1/n)^n$  using Newton's binomial formula.

$$\begin{aligned} \lim_{n \rightarrow \infty} \left(1 + \frac{1}{n}\right)^n &= \lim_{n \rightarrow \infty} \left(1 + \binom{n}{1}\frac{1}{n} + \binom{n}{2}\frac{1}{n^2} + \binom{n}{3}\frac{1}{n^3} + \dots\right) \\ &= \lim_{n \rightarrow \infty} \left(1 + 1 + \frac{n(n-1)}{2!n^2} + \frac{n(n-1)(n-2)}{3!n^3} + \dots\right) \\ &= \left(1 + 1 + \frac{1}{2!} + \frac{1}{3!} + \dots\right) \end{aligned}$$

We recognize this as the Taylor series expansion of  $e^1$ .

$$= e$$

We can also evaluate the limit using L'Hospital's rule.

$$\begin{aligned}\ln\left(\lim_{x\rightarrow\infty}\left(1+\frac{1}{x}\right)^x\right) &= \lim_{x\rightarrow\infty}\ln\left(\left(1+\frac{1}{x}\right)^x\right) \\ &= \lim_{x\rightarrow\infty}x\ln\left(1+\frac{1}{x}\right) \\ &= \lim_{x\rightarrow\infty}\frac{\ln(1+1/x)}{1/x} \\ &= \lim_{x\rightarrow\infty}\frac{\frac{-1/x^2}{1+1/x}}{-1/x^2} \\ &= 1\end{aligned}$$

$$\lim_{x\rightarrow\infty}\left(1+\frac{1}{x}\right)^x = e$$

**Example 12.5.3** Find the Taylor series expansion of  $1/(1+z)$  about  $z=0$ .

For  $|z| < 1$ ,

$$\begin{aligned}\frac{1}{1+z} &= 1 + \binom{-1}{1}z + \binom{-1}{2}z^2 + \binom{-1}{3}z^3 + \dots \\ &= 1 + (-1)^1z + (-1)^2z^2 + (-1)^3z^3 + \dots \\ &= 1 - z + z^2 - z^3 + \dots\end{aligned}$$

**Example 12.5.4** Find the first few terms in the Taylor series expansion of

$$\frac{1}{\sqrt{z^2+5z+6}}$$

about the origin.

We factor the denominator and then apply Newton's binomial formula.

$$\begin{aligned}
 \frac{1}{\sqrt{z^2 + 5z + 6}} &= \frac{1}{\sqrt{z+3}} \frac{1}{\sqrt{z+2}} \\
 &= \frac{1}{\sqrt{3}\sqrt{1+z/3}} \frac{1}{\sqrt{2}\sqrt{1+z/2}} \\
 &= \frac{1}{\sqrt{6}} \left( 1 + \binom{-1/2}{1} \frac{z}{3} + \binom{-1/2}{2} \left(\frac{z}{3}\right)^2 + \dots \right) \left( 1 + \binom{-1/2}{1} \frac{z}{2} + \binom{-1/2}{2} \left(\frac{z}{2}\right)^2 + \dots \right) \\
 &= \frac{1}{\sqrt{6}} \left( 1 - \frac{z}{6} + \frac{z^2}{24} + \dots \right) \left( 1 - \frac{z}{4} + \frac{3z^2}{32} + \dots \right) \\
 &= \frac{1}{\sqrt{6}} \left( 1 - \frac{5}{12}z + \frac{17}{96}z^2 + \dots \right)
 \end{aligned}$$

## 12.6 Laurent Series

**Result 12.6.1** Let  $f(z)$  be single-valued and analytic in the annulus  $R_1 < |z - z_0| < R_2$ . For points in the annulus, the function has the convergent Laurent series

$$f(z) = \sum_{n=-\infty}^{\infty} a_n z^n,$$

where

$$a_n = \frac{1}{i2\pi} \oint_C \frac{f(z)}{(z - z_0)^{n+1}} dz$$

and  $C$  is a positively oriented, closed contour around  $z_0$  lying in the annulus.

To derive this result, consider a function  $f(\zeta)$  that is analytic in the annulus  $R_1 < |\zeta| < R_2$ . Consider any point  $z$

in the annulus. Let  $C_1$  be a circle of radius  $r_1$  with  $R_1 < r_1 < |z|$ . Let  $C_2$  be a circle of radius  $r_2$  with  $|z| < r_2 < R_2$ . Let  $C_z$  be a circle around  $z$ , lying entirely between  $C_1$  and  $C_2$ . (See Figure 12.5 for an illustration.)

Consider the integral of  $\frac{f(\zeta)}{\zeta-z}$  around the  $C_2$  contour. Since the the only singularities of  $\frac{f(\zeta)}{\zeta-z}$  occur at  $\zeta = z$  and at points outside the annulus,

$$\oint_{C_2} \frac{f(\zeta)}{\zeta-z} d\zeta = \oint_{C_z} \frac{f(\zeta)}{\zeta-z} d\zeta + \oint_{C_1} \frac{f(\zeta)}{\zeta-z} d\zeta.$$

By Cauchy's Integral Formula, the integral around  $C_z$  is

$$\oint_{C_z} \frac{f(\zeta)}{\zeta-z} d\zeta = i2\pi f(z).$$

This gives us an expression for  $f(z)$ .

$$f(z) = \frac{1}{i2\pi} \oint_{C_2} \frac{f(\zeta)}{\zeta-z} d\zeta - \frac{1}{i2\pi} \oint_{C_1} \frac{f(\zeta)}{\zeta-z} d\zeta \quad (12.4)$$

On the  $C_2$  contour,  $|z| < |\zeta|$ . Thus

$$\begin{aligned} \frac{1}{\zeta-z} &= \frac{1/\zeta}{1-z/\zeta} \\ &= \frac{1}{\zeta} \sum_{n=0}^{\infty} \left(\frac{z}{\zeta}\right)^n, \quad \text{for } |z| < |\zeta| \\ &= \sum_{n=0}^{\infty} \frac{z^n}{\zeta^{n+1}}, \quad \text{for } |z| < |\zeta| \end{aligned}$$

On the  $C_1$  contour,  $|\zeta| < |z|$ . Thus

$$\begin{aligned} -\frac{1}{\zeta - z} &= \frac{1/z}{1 - \zeta/z} \\ &= \frac{1}{z} \sum_{n=0}^{\infty} \left(\frac{\zeta}{z}\right)^n, \quad \text{for } |\zeta| < |z| \\ &= \sum_{n=0}^{\infty} \frac{\zeta^n}{z^{n+1}}, \quad \text{for } |\zeta| < |z| \\ &= \sum_{n=-\infty}^{-1} \frac{z^n}{\zeta^{n+1}}, \quad \text{for } |\zeta| < |z| \end{aligned}$$

We substitute these geometric series into Equation 12.4.

$$f(z) = \frac{1}{i2\pi} \oint_{C_2} \left( \sum_{n=0}^{\infty} \frac{f(\zeta)z^n}{\zeta^{n+1}} \right) d\zeta + \frac{1}{i2\pi} \oint_{C_1} \left( \sum_{n=-\infty}^{-1} \frac{f(\zeta)z^n}{\zeta^{n+1}} \right) d\zeta$$

Since the sums converge uniformly, we can interchange the order of integration and summation.

$$f(z) = \frac{1}{i2\pi} \sum_{n=0}^{\infty} \oint_{C_2} \frac{f(\zeta)z^n}{\zeta^{n+1}} d\zeta + \frac{1}{i2\pi} \sum_{n=-\infty}^{-1} \oint_{C_1} \frac{f(\zeta)z^n}{\zeta^{n+1}} d\zeta$$

Since the only singularities of the integrands lie outside of the annulus, the  $C_1$  and  $C_2$  contours can be deformed to any positive, closed contour  $C$  that lies in the annulus and encloses the origin. (See Figure 12.5.) Finally, we combine the two integrals to obtain the desired result.

$$f(z) = \sum_{n=-\infty}^{\infty} \frac{1}{i2\pi} \left( \oint_C \frac{f(\zeta)}{\zeta^{n+1}} d\zeta \right) z^n$$

For the case of arbitrary  $z_0$ , simply make the transformation  $z \rightarrow z - z_0$ .

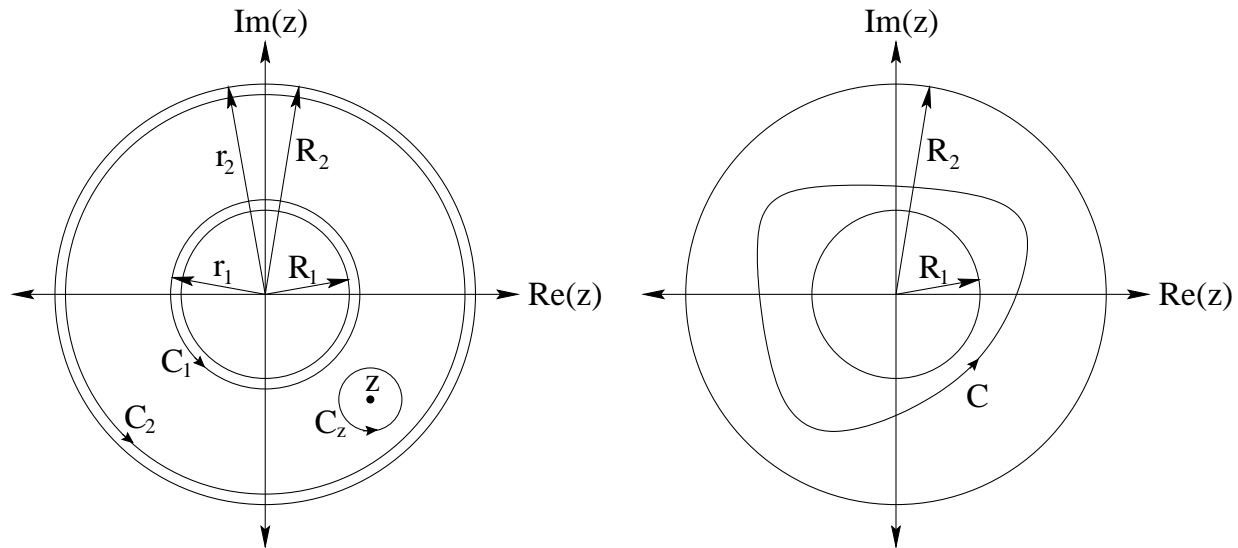

Figure 12.5: Contours for a Laurent Expansion in an Annulus.

**Example 12.6.1** Find the Laurent series expansions of  $1/(1+z)$ .

For  $|z| < 1$ ,

$$\begin{aligned}
 \frac{1}{1+z} &= 1 + \binom{-1}{1}z + \binom{-1}{2}z^2 + \binom{-1}{3}z^3 + \dots \\
 &= 1 + (-1)^1z + (-1)^2z^2 + (-1)^3z^3 + \dots \\
 &= 1 - z + z^2 - z^3 + \dots
 \end{aligned}$$

For  $|z| > 1$ ,

$$\begin{aligned}\frac{1}{1+z} &= \frac{1/z}{1+1/z} \\ &= \frac{1}{z} \left( 1 + \binom{-1}{1} z^{-1} + \binom{-1}{2} z^{-2} + \dots \right) \\ &= z^{-1} - z^{-2} + z^{-3} - \dots\end{aligned}$$

## 12.7 Exercises

### 12.7.1 Series of Constants

#### Exercise 12.1

Show that if  $\sum a_n$  converges then  $\lim_{n \rightarrow \infty} a_n = 0$ . That is,  $\lim_{n \rightarrow \infty} a_n = 0$  is a necessary condition for the convergence of the series.

**Hint, Solution**

#### Exercise 12.2

Answer the following questions *true* or *false*. Justify your answers.

1. There exists a sequence which converges to both 1 and  $-1$ .
2. There exists a sequence  $\{a_n\}$  such that  $a_n > 1$  for all  $n$  and  $\lim_{n \rightarrow \infty} a_n = 1$ .
3. There exists a divergent geometric series whose terms converge.
4. There exists a sequence whose even terms are greater than 1, whose odd terms are less than 1 and that converges to 1.
5. There exists a divergent series of non-negative terms,  $\sum_{n=0}^{\infty} a_n$ , such that  $a_n < (1/2)^n$ .
6. There exists a convergent sequence,  $\{a_n\}$ , such that  $\lim_{n \rightarrow \infty} (a_{n+1} - a_n) \neq 0$ .
7. There exists a divergent sequence,  $\{a_n\}$ , such that  $\lim_{n \rightarrow \infty} |a_n| = 2$ .
8. There exists divergent series,  $\sum a_n$  and  $\sum b_n$ , such that  $\sum (a_n + b_n)$  is convergent.
9. There exists 2 different series of nonzero terms that have the same sum.
10. There exists a series of nonzero terms that converges to zero.
11. There exists a series with an infinite number of non-real terms which converges to a real number.



12. There exists a convergent series  $\sum a_n$  with  $\lim_{n \rightarrow \infty} |a_{n+1}/a_n| = 1$ .
13. There exists a divergent series  $\sum a_n$  with  $\lim_{n \rightarrow \infty} |a_{n+1}/a_n| = 1$ .
14. There exists a convergent series  $\sum a_n$  with  $\lim_{n \rightarrow \infty} \sqrt[n]{|a_n|} = 1$ .
15. There exists a divergent series  $\sum a_n$  with  $\lim_{n \rightarrow \infty} \sqrt[n]{|a_n|} = 1$ .
16. There exists a convergent series of non-negative terms,  $\sum a_n$ , for which  $\sum a_n^2$  diverges.
17. There exists a convergent series of non-negative terms,  $\sum a_n$ , for which  $\sum \sqrt{a_n}$  diverges.
18. There exists a convergent series,  $\sum a_n$ , for which  $\sum |a_n|$  diverges.
19. There exists a power series  $\sum a_n(z - z_0)^n$  which converges for  $z = 0$  and  $z = 3$  but diverges for  $z = 2$ .
20. There exists a power series  $\sum a_n(z - z_0)^n$  which converges for  $z = 0$  and  $z = i2$  but diverges for  $z = 2$ .

**Hint, Solution**

### Exercise 12.3

Determine if the following series converge.

$$1. \sum_{n=2}^{\infty} \frac{1}{n \ln(n)}$$

$$2. \sum_{n=2}^{\infty} \frac{1}{\ln(n^n)}$$

$$3. \sum_{n=2}^{\infty} \ln \sqrt[n]{\ln n}$$

$$4. \sum_{n=10}^{\infty} \frac{1}{n(\ln n)(\ln(\ln n))}$$

$$5. \sum_{n=1}^{\infty} \frac{\ln(2^n)}{\ln(3^n) + 1}$$

$$6. \sum_{n=0}^{\infty} \frac{1}{\ln(n + 20)}$$

$$7. \sum_{n=0}^{\infty} \frac{4^n + 1}{3^n - 2}$$

$$8. \sum_{n=0}^{\infty} (\text{Log}_{\pi} 2)^n$$

$$9. \sum_{n=2}^{\infty} \frac{n^2 - 1}{n^4 - 1}$$

$$10. \sum_{n=2}^{\infty} \frac{n^2}{(\ln n)^n}$$

$$11. \sum_{n=2}^{\infty} (-1)^n \ln\left(\frac{1}{n}\right)$$

$$12. \sum_{n=2}^{\infty} \frac{(n!)^2}{(2n)!}$$

$$13. \sum_{n=2}^{\infty} \frac{3^n + 4^n + 5}{5^n - 4^n - 3}$$

14. 
$$\sum_{n=2}^{\infty} \frac{n!}{(\ln n)^n}$$

15. 
$$\sum_{n=2}^{\infty} \frac{e^n}{\ln(n!)}$$

16. 
$$\sum_{n=1}^{\infty} \frac{(n!)^2}{(n^2)!}$$

17. 
$$\sum_{n=1}^{\infty} \frac{n^8 + 4n^4 + 8}{3n^9 - n^5 + 9n}$$

18. 
$$\sum_{n=1}^{\infty} \left( \frac{1}{n} - \frac{1}{n+1} \right)$$

19. 
$$\sum_{n=1}^{\infty} \frac{\cos(n\pi)}{n}$$

20. 
$$\sum_{n=2}^{\infty} \frac{\ln n}{n^{11/10}}$$

Hint, Solution

### Exercise 12.4 (mathematica/fcv/series/constants.nb)

Show that the alternating harmonic series,

$$\sum_{n=1}^{\infty} \frac{(-1)^{n+1}}{n} = 1 - \frac{1}{2} + \frac{1}{3} - \frac{1}{4} + \cdots,$$

is convergent.

Hint, Solution

**Exercise 12.5 (mathematica/fcv/series/constants.nb)**

Show that the series

$$\sum_{n=1}^{\infty} \frac{1}{n}$$

is divergent with the Cauchy convergence criterion.

**Hint, Solution**

**Exercise 12.6**

The alternating harmonic series has the sum:

$$\sum_{n=1}^{\infty} \frac{(-1)^n}{n} = \ln(2).$$

Show that the terms in this series can be rearranged to sum to  $\pi$ .

**Hint, Solution**

**Exercise 12.7 (mathematica/fcv/series/constants.nb)**

Is the series,

$$\sum_{n=1}^{\infty} \frac{n!}{n^n},$$

convergent?

**Hint, Solution**

**Exercise 12.8**

Show that the harmonic series,

$$\sum_{n=1}^{\infty} \frac{1}{n^\alpha} = 1 + \frac{1}{2^\alpha} + \frac{1}{3^\alpha} + \dots,$$

converges for  $\alpha > 1$  and diverges for  $\alpha \leq 1$ .

**Hint, Solution**

**Exercise 12.9**Evaluate  $\sum_{n=1}^{N-1} \sin(nx)$ .**Hint, Solution****Exercise 12.10**

Evaluate

$$\sum_{k=1}^n k z^k \quad \text{and} \quad \sum_{k=1}^n k^2 z^k$$

for  $z \neq 1$ .**Hint, Solution****Exercise 12.11**

Which of the following series converge? Find the sum of those that do.

1.  $\frac{1}{2} + \frac{1}{6} + \frac{1}{12} + \frac{1}{20} + \dots$

2.  $1 + (-1) + 1 + (-1) + \dots$

3.  $\sum_{n=1}^{\infty} \frac{1}{2^{n-1}} \frac{1}{3^n} \frac{1}{5^{n+1}}$

**Hint, Solution****Exercise 12.12**

Evaluate the following sum.

$$\sum_{k_1=0}^{\infty} \sum_{k_2=k_1}^{\infty} \dots \sum_{k_n=k_{n-1}}^{\infty} \frac{1}{2^{k_n}}$$

**Hint, Solution**

## 12.7.2 Uniform Convergence

## 12.7.3 Uniformly Convergent Power Series

### Exercise 12.13

Determine the domain of convergence of the following series.

$$1. \sum_{n=0}^{\infty} \frac{z^n}{(z+3)^n}$$

$$2. \sum_{n=2}^{\infty} \frac{\operatorname{Log} z}{\ln n}$$

$$3. \sum_{n=1}^{\infty} \frac{z}{n}$$

$$4. \sum_{n=1}^{\infty} \frac{(z+2)^2}{n^2}$$

$$5. \sum_{n=1}^{\infty} \frac{(z-e)^n}{n^n}$$

$$6. \sum_{n=1}^{\infty} \frac{z^{2n}}{2^{nz}}$$

$$7. \sum_{n=0}^{\infty} \frac{z^{n!}}{(n!)^2}$$

$$8. \sum_{n=0}^{\infty} \frac{z^{\ln(n!)}}{n!}$$

$$9. \sum_{n=0}^{\infty} \frac{(z - \pi)^{2n+1} n^{\pi}}{n!}$$

$$10. \sum_{n=0}^{\infty} \frac{\ln n}{z^n}$$

Hint, Solution

### Exercise 12.14

Find the circle of convergence of the following series.

$$1. z + (\alpha - \beta) \frac{z^2}{2!} + (\alpha - \beta)(\alpha - 2\beta) \frac{z^3}{3!} + (\alpha - \beta)(\alpha - 2\beta)(\alpha - 3\beta) \frac{z^4}{4!} + \dots$$

$$2. \sum_{n=1}^{\infty} \frac{n}{2^n} (z - i)^n$$

$$3. \sum_{n=1}^{\infty} n^n z^n$$

$$4. \sum_{n=1}^{\infty} \frac{n!}{n^n} z^n$$

$$5. \sum_{n=1}^{\infty} (3 + (-1)^n)^n z^n$$

$$6. \sum_{n=1}^{\infty} (n + \alpha^n) z^n \quad (|\alpha| > 1)$$

Hint, Solution

### Exercise 12.15

Find the circle of convergence of the following series:

$$1. \sum_{k=0}^{\infty} k z^k$$

$$2. \sum_{k=1}^{\infty} k^k z^k$$

$$3. \sum_{k=1}^{\infty} \frac{k!}{k^k} z^k$$

$$4. \sum_{k=0}^{\infty} (z + i5)^{2k} (k + 1)^2$$

$$5. \sum_{k=0}^{\infty} (k + 2^k) z^k$$

Hint, Solution

## 12.7.4 Integration and Differentiation of Power Series

### Exercise 12.16

Using the geometric series, show that

$$\frac{1}{(1-z)^2} = \sum_{n=0}^{\infty} (n+1)z^n, \quad \text{for } |z| < 1,$$

and

$$\log(1-z) = -\sum_{n=1}^{\infty} \frac{z^n}{n}, \quad \text{for } |z| < 1.$$



Hint, Solution

## 12.7.5 Taylor Series

### Exercise 12.17

Find the Taylor series of  $\frac{1}{1+z^2}$  about the  $z = 0$ . Determine the radius of convergence of the Taylor series from the singularities of the function. Determine the radius of convergence with the ratio test.

Hint, Solution

### Exercise 12.18

Use two methods to find the Taylor series expansion of  $\log(1+z)$  about  $z = 0$  and determine the circle of convergence. First directly apply Taylor's theorem, then differentiate a geometric series.

Hint, Solution

### Exercise 12.19

Let  $f(z) = (1+z)^\alpha$  be the branch for which  $f(0) = 1$ . Find its Taylor series expansion about  $z = 0$ . What is the radius of convergence of the series? ( $\alpha$  is an arbitrary complex number.)

Hint, Solution

### Exercise 12.20

Find the Taylor series expansions about the point  $z = 1$  for the following functions. What are the radii of convergence?

1.  $\frac{1}{z}$
2.  $\text{Log } z$
3.  $\frac{1}{z^2}$
4.  $z \text{Log } z - z$

Hint, Solution

**Exercise 12.21**

Find the Taylor series expansion about the point  $z = 0$  for  $e^z$ . What is the radius of convergence? Use this to find the Taylor series expansions of  $\cos z$  and  $\sin z$  about  $z = 0$ .

[Hint, Solution](#)

**Exercise 12.22**

Find the Taylor series expansion about the point  $z = \pi$  for the cosine and sine.

[Hint, Solution](#)

**Exercise 12.23**

Sum the following series.

1. 
$$\sum_{n=0}^{\infty} \frac{(\ln 2)^n}{n!}$$

2. 
$$\sum_{n=0}^{\infty} \frac{(n+1)(n+2)}{2^n}$$

3. 
$$\sum_{n=0}^{\infty} \frac{(-1)^n}{n!}$$

4. 
$$\sum_{n=0}^{\infty} \frac{(-1)^n \pi^{2n+1}}{(2n+1)!}$$

5. 
$$\sum_{n=0}^{\infty} \frac{(-1)^n \pi^{2n}}{(2n)!}$$

6. 
$$\sum_{n=0}^{\infty} \frac{(-\pi)^n}{(2n)!}$$

[Hint, Solution](#)

### Exercise 12.24

1. Find the first three terms in the following Taylor series and state the convergence properties for the following.

(a)  $e^{-z}$  around  $z_0 = 0$

(b)  $\frac{1+z}{1-z}$  around  $z_0 = i$

(c)  $\frac{e^z}{z-1}$  around  $z_0 = 0$

It may be convenient to use the Cauchy product of two Taylor series.

2. Consider a function  $f(z)$  analytic for  $|z - z_0| < R$ . Show that the series obtained by differentiating the Taylor series for  $f(z)$  termwise is actually the Taylor series for  $f'(z)$  and hence argue that this series converges uniformly to  $f'(z)$  for  $|z - z_0| \leq \rho < R$ .

3. Find the Taylor series for

$$\frac{1}{(1-z)^3}$$

by appropriate differentiation of the geometric series and state the radius of convergence.

4. Consider the branch of  $f(z) = (z+1)^i$  corresponding to  $f(0) = 1$ . Find the Taylor series expansion about  $z_0 = 0$  and state the radius of convergence.

Hint, Solution

## 12.7.6 Laurent Series

### Exercise 12.25

Find the Laurent series about  $z = 0$  of  $1/(z-i)$  for  $|z| < 1$  and  $|z| > 1$ .

Hint, Solution

**Exercise 12.26**

Obtain the Laurent expansion of

$$f(z) = \frac{1}{(z+1)(z+2)}$$

centered on  $z = 0$  for the three regions:

1.  $|z| < 1$
2.  $1 < |z| < 2$
3.  $2 < |z|$

**Hint, Solution**

**Exercise 12.27**

By comparing the Laurent expansion of  $(z + 1/z)^m$ ,  $m \in \mathbb{Z}^+$ , with the binomial expansion of this quantity, show that

$$\int_0^{2\pi} (\cos \theta)^m \cos(n\theta) \, d\theta = \begin{cases} \frac{\pi}{2^{m-1}} \binom{m}{(m-n)/2} & -m \leq n \leq m \text{ and } m-n \text{ even} \\ 0 & \text{otherwise} \end{cases}$$

**Hint, Solution**

**Exercise 12.28**

The function  $f(z)$  is analytic in the entire  $z$ -plane, including  $\infty$ , except at the point  $z = i/2$ , where it has a simple pole, and at  $z = 2$ , where it has a pole of order 2. In addition

$$\oint_{|z|=1} f(z) \, dz = i2\pi, \quad \oint_{|z|=3} f(z) \, dz = 0, \quad \oint_{|z|=3} (z-1)f(z) \, dz = 0.$$

Find  $f(z)$  and its complete Laurent expansion about  $z = 0$ .

**Hint, Solution**

**Exercise 12.29**

Let  $f(z) = \sum_{k=1}^{\infty} k^3 \left(\frac{z}{3}\right)^k$ . Compute each of the following, giving justification in each case. The contours are circles of radius one about the origin.

1.  $\int_{|z|=1} e^{2z} f(z) dz$

2.  $\int_{|z|=1} \frac{f(z)}{z^4} dz$

3.  $\int_{|z|=1} \frac{f(z) e^z}{z^2} dz$

**Hint, Solution**

**Exercise 12.30**

1. Expand  $f(z) = \frac{1}{z(1-z)}$  in Laurent series that converge in the following domains:

(a)  $0 < |z| < 1$

(b)  $|z| > 1$

(c)  $|z + 1| > 2$

2. Without determining the series, specify the region of convergence for a Laurent series representing  $f(z) = 1/(z^4 + 4)$  in powers of  $z - 1$  that converges at  $z = i$ .

**Hint, Solution**

## 12.8 Hints

### Hint 12.1

Use the Cauchy convergence criterion for series. In particular, consider  $|S_{N+1} - S_N|$ .

### Hint 12.2

CONTINUE

### Hint 12.3

1.

$$\sum_{n=2}^{\infty} \frac{1}{n \ln(n)}$$

Use the integral test.

2.

$$\sum_{n=2}^{\infty} \frac{1}{\ln(n^n)}$$

Simplify the summand.

3.

$$\sum_{n=2}^{\infty} \ln \sqrt[n]{\ln n}$$

Simplify the summand. Use the comparison test.

4.

$$\sum_{n=10}^{\infty} \frac{1}{n(\ln n)(\ln(\ln n))}$$

Use the integral test.

5.

$$\sum_{n=1}^{\infty} \frac{\ln(2^n)}{\ln(3^n) + 1}$$

Show that the terms in the sum do not vanish as  $n \rightarrow \infty$

6.

$$\sum_{n=0}^{\infty} \frac{1}{\ln(n+20)}$$

Shift the indices.

7.

$$\sum_{n=0}^{\infty} \frac{4^n + 1}{3^n - 2}$$

Show that the terms in the sum do not vanish as  $n \rightarrow \infty$

8.

$$\sum_{n=0}^{\infty} (\text{Log}_{\pi} 2)^n$$

This is a geometric series.

9.

$$\sum_{n=2}^{\infty} \frac{n^2 - 1}{n^4 - 1}$$

Simplify the integrand. Use the comparison test.

10.

$$\sum_{n=2}^{\infty} \frac{n^2}{(\ln n)^n}$$

Compare to a geometric series.

11.

$$\sum_{n=2}^{\infty} (-1)^n \ln \left( \frac{1}{n} \right)$$

Group pairs of consecutive terms to obtain a series of positive terms.

12.

$$\sum_{n=2}^{\infty} \frac{(n!)^2}{(2n)!}$$

Use the comparison test.

13.

$$\sum_{n=2}^{\infty} \frac{3^n + 4^n + 5}{5^n - 4^n - 3}$$

Use the root test.

14.

$$\sum_{n=2}^{\infty} \frac{n!}{(\ln n)^n}$$

Show that the terms do not vanish as  $n \rightarrow \infty$ .

15.

$$\sum_{n=2}^{\infty} \frac{e^n}{\ln(n!)}$$

Show that the terms do not vanish as  $n \rightarrow \infty$ .

16.

$$\sum_{n=1}^{\infty} \frac{(n!)^2}{(n^2)!}$$

Apply the ratio test.



17.

$$\sum_{n=1}^{\infty} \frac{n^8 + 4n^4 + 8}{3n^9 - n^5 + 9n}$$

Use the comparison test.

18.

$$\sum_{n=1}^{\infty} \left( \frac{1}{n} - \frac{1}{n+1} \right)$$

Use the comparison test.

19.

$$\sum_{n=1}^{\infty} \frac{\cos(n\pi)}{n}$$

Simplify the integrand.

20.

$$\sum_{n=2}^{\infty} \frac{\ln n}{n^{11/10}}$$

Use the integral test.

**Hint 12.4**

Group the terms.

$$\begin{aligned} 1 - \frac{1}{2} &= \frac{1}{2} \\ \frac{1}{3} - \frac{1}{4} &= \frac{1}{12} \\ \frac{1}{5} - \frac{1}{6} &= \frac{1}{30} \\ \dots \end{aligned}$$

**Hint 12.5**

Show that

$$|S_{2n} - S_n| > \frac{1}{2}.$$

**Hint 12.6**

The alternating harmonic series is conditionally convergent. Let  $\{a_n\}$  and  $\{b_n\}$  be the positive and negative terms in the sum, respectively, ordered in decreasing magnitude. Note that both  $\sum_{n=1}^{\infty} a_n$  and  $\sum_{n=1}^{\infty} b_n$  are divergent. Devise a method for alternately taking terms from  $\{a_n\}$  and  $\{b_n\}$ .

**Hint 12.7**

Use the ratio test.

**Hint 12.8**

Use the integral test.

**Hint 12.9**

Note that  $\sin(nx) = \Im(e^{inx})$ . This substitute will yield a finite geometric series.

**Hint 12.10**

Let  $S_n$  be the sum. Consider  $S_n - zS_n$ . Use the finite geometric sum.

**Hint 12.11**

1. The summand is a rational function. Find the first few partial sums.
- 2.
3. This a geometric series.

**Hint 12.12**

CONTINUE

**Hint 12.13**

CONTINUE

1. 
$$\sum_{n=0}^{\infty} \frac{z^n}{(z+3)^n}$$

2. 
$$\sum_{n=2}^{\infty} \frac{\operatorname{Log} z}{\ln n}$$

3. 
$$\sum_{n=1}^{\infty} \frac{z}{n}$$

4. 
$$\sum_{n=1}^{\infty} \frac{(z+2)^2}{n^2}$$

5. 
$$\sum_{n=1}^{\infty} \frac{(z-e)^n}{n^n}$$

6. 
$$\sum_{n=1}^{\infty} \frac{z^{2n}}{2^{nz}}$$

7. 
$$\sum_{n=0}^{\infty} \frac{z^{n!}}{(n!)^2}$$

8. 
$$\sum_{n=0}^{\infty} \frac{z^{\ln(n!)}}{n!}$$

9. 
$$\sum_{n=0}^{\infty} \frac{(z-\pi)^{2n+1} n^\pi}{n!}$$

10.  $\sum_{n=0}^{\infty} \frac{\ln n}{z^n}$

**Hint 12.14**

**Hint 12.15**  
CONTINUE

**Hint 12.16**  
Differentiate the geometric series. Integrate the geometric series.

**Hint 12.17**  
The Taylor series is a geometric series.

**Hint 12.18**

**Hint 12.19**

**Hint 12.20**

1.

$$\frac{1}{z} = \frac{1}{1 + (z - 1)}$$

The right side is the sum of a geometric series.

2. Integrate the series for  $1/z$ .
3. Differentiate the series for  $1/z$ .
4. Integrate the series for  $\text{Log } z$ .

**Hint 12.21**

Evaluate the derivatives of  $e^z$  at  $z = 0$ . Use **Taylor's Theorem**.

Write the cosine and sine in terms of the exponential function.

**Hint 12.22**

$$\cos z = -\cos(z - \pi)$$

$$\sin z = -\sin(z - \pi)$$

**Hint 12.23**

CONTINUE

**Hint 12.24**

CONTINUE

**Hint 12.25****Hint 12.26****Hint 12.27****Hint 12.28****Hint 12.29****Hint 12.30**

CONTINUE

## 12.9 Solutions

### Solution 12.1

$\sum_{n=0}^{\infty} a_n$  converges only if the partial sums,  $S_n$ , are a Cauchy sequence.

$$\forall \epsilon > 0 \exists N \text{ s.t. } m, n > N \Rightarrow |S_m - S_n| < \epsilon,$$

In particular, we can consider  $m = n + 1$ .

$$\forall \epsilon > 0 \exists N \text{ s.t. } n > N \Rightarrow |S_{n+1} - S_n| < \epsilon$$

Now we note that  $S_{n+1} - S_n = a_n$ .

$$\forall \epsilon > 0 \exists N \text{ s.t. } n > N \Rightarrow |a_n| < \epsilon$$

This is exactly the Cauchy convergence criterion for the sequence  $\{a_n\}$ . Thus we see that  $\lim_{n \rightarrow \infty} a_n = 0$  is a necessary condition for the convergence of the series  $\sum_{n=0}^{\infty} a_n$ .

### Solution 12.2

CONTINUE

### Solution 12.3

1.

$$\sum_{n=2}^{\infty} \frac{1}{n \ln(n)}$$

Since this is a series of positive, monotone decreasing terms, the sum converges or diverges with the integral,

$$\int_2^{\infty} \frac{1}{x \ln x} dx = \int_{\ln 2}^{\infty} \frac{1}{\xi} d\xi$$

Since the integral diverges, the series also diverges.

2.

$$\sum_{n=2}^{\infty} \frac{1}{\ln(n^n)} = \sum_{n=2}^{\infty} \frac{1}{n \ln(n)}$$

The sum converges.

3.

$$\sum_{n=2}^{\infty} \ln \sqrt[n]{\ln n} = \sum_{n=2}^{\infty} \frac{1}{n} \ln(\ln n) \geq \sum_{n=2}^{\infty} \frac{1}{n}$$

The sum is divergent by the comparison test.

4.

$$\sum_{n=10}^{\infty} \frac{1}{n(\ln n)(\ln(\ln n))}$$

Since this is a series of positive, monotone decreasing terms, the sum converges or diverges with the integral,

$$\int_{10}^{\infty} \frac{1}{x \ln x \ln(\ln x)} dx = \int_{\ln(10)}^{\infty} \frac{1}{y \ln y} dy = \int_{\ln(\ln(10))}^{\infty} \frac{1}{z} dz$$

Since the integral diverges, the series also diverges.

5.

$$\sum_{n=1}^{\infty} \frac{\ln(2^n)}{\ln(3^n) + 1} = \sum_{n=1}^{\infty} \frac{n \ln 2}{n \ln 3 + 1} = \sum_{n=1}^{\infty} \frac{\ln 2}{\ln 3 + 1/n}$$

Since the terms in the sum do not vanish as  $n \rightarrow \infty$ , the series is divergent.

6.

$$\sum_{n=0}^{\infty} \frac{1}{\ln(n+20)} = \sum_{n=20}^{\infty} \frac{1}{\ln n}$$

The series diverges.

7.

$$\sum_{n=0}^{\infty} \frac{4^n + 1}{3^n - 2}$$

Since the terms in the sum do not vanish as  $n \rightarrow \infty$ , the series is divergent.

8.

$$\sum_{n=0}^{\infty} (\text{Log}_{\pi} 2)^n$$

This is a geometric series. Since  $|\text{Log}_{\pi} 2| < 1$ , the series converges.

9.

$$\sum_{n=2}^{\infty} \frac{n^2 - 1}{n^4 - 1} = \sum_{n=2}^{\infty} \frac{1}{n^2 + 1} < \sum_{n=2}^{\infty} \frac{1}{n^2}$$

The series converges by comparison to the harmonic series.

10.

$$\sum_{n=2}^{\infty} \frac{n^2}{(\ln n)^n} = \sum_{n=2}^{\infty} \left( \frac{n^{2/n}}{\ln n} \right)^n$$

Since  $n^{2/n} \rightarrow 1$  as  $n \rightarrow \infty$ ,  $n^{2/n}/\ln n \rightarrow 0$  as  $n \rightarrow \infty$ . The series converges by comparison to a geometric series.

11. We group pairs of consecutive terms to obtain a series of positive terms.

$$\sum_{n=2}^{\infty} (-1)^n \ln \left( \frac{1}{n} \right) = \sum_{n=1}^{\infty} \left( \ln \left( \frac{1}{2n} \right) - \ln \left( \frac{1}{2n+1} \right) \right) = \sum_{n=1}^{\infty} \ln \left( \frac{2n+1}{2n} \right)$$

The series on the right side diverges because the terms do not vanish as  $n \rightarrow \infty$ .

12.

$$\sum_{n=2}^{\infty} \frac{(n!)^2}{(2n)!} = \sum_{n=2}^{\infty} \frac{(1)(2) \cdots n}{(n+1)(n+2) \cdots (2n)} < \sum_{n=2}^{\infty} \frac{1}{2^n}$$

The series converges by comparison with a geometric series.



13.

$$\sum_{n=2}^{\infty} \frac{3^n + 4^n + 5}{5^n - 4^n - 3}$$

We use the root test to check for convergence.

$$\begin{aligned} \lim_{n \rightarrow \infty} |a_n|^{1/n} &= \lim_{n \rightarrow \infty} \left| \frac{3^n + 4^n + 5}{5^n - 4^n - 3} \right|^{1/n} \\ &= \lim_{n \rightarrow \infty} \frac{4}{5} \left| \frac{(3/4)^n + 1 + 5/4^n}{1 - (4/5)^n - 3/5^n} \right|^{1/n} \\ &= \frac{4}{5} \\ &< 1 \end{aligned}$$

We see that the series is absolutely convergent.

14. We will use the comparison test.

$$\sum_{n=2}^{\infty} \frac{n!}{(\ln n)^n} > \sum_{n=2}^{\infty} \frac{(n/2)^{n/2}}{(\ln n)^n} = \sum_{n=2}^{\infty} \left( \frac{\sqrt{n/2}}{\ln n} \right)^n$$

Since the terms in the series on the right side do not vanish as  $n \rightarrow \infty$ , the series is divergent.

15. We will use the comparison test.

$$\sum_{n=2}^{\infty} \frac{e^n}{\ln(n!)} > \sum_{n=2}^{\infty} \frac{e^n}{\ln(n^n)} = \sum_{n=2}^{\infty} \frac{e^n}{n \ln(n)}$$

Since the terms in the series on the right side do not vanish as  $n \rightarrow \infty$ , the series is divergent.

16.

$$\sum_{n=1}^{\infty} \frac{(n!)^2}{(n^2)!}$$

We apply the ratio test.

$$\begin{aligned} \lim_{n \rightarrow \infty} \left| \frac{a_{n+1}}{a_n} \right| &= \lim_{n \rightarrow \infty} \left| \frac{((n+1)!)^2 (n^2)!}{((n+1)^2)! (n!)^2} \right| \\ &= \lim_{n \rightarrow \infty} \left| \frac{(n+1)^2}{((n+1)^2 - n^2)!} \right| \\ &= \lim_{n \rightarrow \infty} \left| \frac{(n+1)^2}{(2n+1)!} \right| \\ &= 0 \end{aligned}$$

The series is convergent.

17.

$$\begin{aligned} \sum_{n=1}^{\infty} \frac{n^8 + 4n^4 + 8}{3n^9 - n^5 + 9n} &= \sum_{n=1}^{\infty} \frac{1}{n} \frac{1 + 4n^{-4} + 8n^{-8}}{3 - n^{-4} + 9n^{-8}} \\ &> \frac{1}{4} \sum_{n=1}^{\infty} \frac{1}{n} \end{aligned}$$

We see that the series is divergent by comparison to the harmonic series.

18.

$$\sum_{n=1}^{\infty} \left( \frac{1}{n} - \frac{1}{n+1} \right) = \sum_{n=1}^{\infty} \frac{1}{n^2 + n} < \sum_{n=1}^{\infty} \frac{1}{n^2}$$

The series converges by the comparison test.

19.

$$\sum_{n=1}^{\infty} \frac{\cos(n\pi)}{n} = \sum_{n=1}^{\infty} \frac{(-1)^n}{n}$$

We recognize this as the alternating harmonic series, which is conditionally convergent.

20.

$$\sum_{n=2}^{\infty} \frac{\ln n}{n^{11/10}}$$

Since this is a series of positive, monotone decreasing terms, the sum converges or diverges with the integral,

$$\int_2^{\infty} \frac{\ln x}{x^{11/10}} dx = \int_{\ln 2}^{\infty} y e^{-y/10} dy$$

Since the integral is convergent, so is the series.

### Solution 12.4

$$\begin{aligned} \sum_{n=1}^{\infty} \frac{(-1)^{n+1}}{n} &= \sum_{n=1}^{\infty} \left( \frac{1}{2n-1} - \frac{1}{2n} \right) \\ &= \sum_{n=1}^{\infty} \frac{1}{(2n-1)(2n)} \\ &< \sum_{n=1}^{\infty} \frac{1}{(2n-1)^2} \\ &< \frac{1}{2} \sum_{n=1}^{\infty} \frac{1}{n^2} \\ &= \frac{\pi^2}{12} \end{aligned}$$

Thus the series is convergent.

### Solution 12.5

Since

$$\begin{aligned} |S_{2n} - S_n| &= \left| \sum_{j=n}^{2n-1} \frac{1}{j} \right| \\ &\geq \sum_{j=n}^{2n-1} \frac{1}{2n-1} \\ &= \frac{n}{2n-1} \\ &> \frac{1}{2} \end{aligned}$$

the series does not satisfy the Cauchy convergence criterion.

### Solution 12.6

The alternating harmonic series is conditionally convergent. That is, the sum is convergent but not absolutely convergent. Let  $\{a_n\}$  and  $\{b_n\}$  be the positive and negative terms in the sum, respectively, ordered in decreasing magnitude. Note that both  $\sum_{n=1}^{\infty} a_n$  and  $\sum_{n=1}^{\infty} b_n$  are divergent. Otherwise the alternating harmonic series would be absolutely convergent.

To sum the terms in the series to  $\pi$  we repeat the following two steps indefinitely:

1. Take terms from  $\{a_n\}$  until the sum is greater than  $\pi$ .
2. Take terms from  $\{b_n\}$  until the sum is less than  $\pi$ .

Each of these steps can always be accomplished because the sums,  $\sum_{n=1}^{\infty} a_n$  and  $\sum_{n=1}^{\infty} b_n$  are both divergent. Hence the tails of the series are divergent. No matter how many terms we take, the remaining terms in each series are divergent. In each step a finite, nonzero number of terms from the respective series is taken. Thus all the terms will be used. Since the terms in each series vanish as  $n \rightarrow \infty$ , the running sum converges to  $\pi$ .

**Solution 12.7**

Applying the ratio test,

$$\begin{aligned} \lim_{n \rightarrow \infty} \left| \frac{a_{n+1}}{a_n} \right| &= \lim_{n \rightarrow \infty} \frac{(n+1)!n^n}{n!(n+1)^{(n+1)}} \\ &= \lim_{n \rightarrow \infty} \frac{n^n}{(n+1)^n} \\ &= \lim_{n \rightarrow \infty} \left( \frac{n}{n+1} \right)^n \\ &= \frac{1}{e} \\ &< 1, \end{aligned}$$

we see that the series is absolutely convergent.

**Solution 12.8**

The harmonic series,

$$\sum_{n=1}^{\infty} \frac{1}{n^\alpha} = 1 + \frac{1}{2^\alpha} + \frac{1}{3^\alpha} + \cdots,$$

converges or diverges absolutely with the integral,

$$\int_1^{\infty} \frac{1}{|x^\alpha|} dx = \int_1^{\infty} \frac{1}{x^{\Re(\alpha)}} dx = \begin{cases} [\ln x]_1^{\infty} & \text{for } \Re(\alpha) = 1, \\ \left[ \frac{x^{1-\Re(\alpha)}}{1-\Re(\alpha)} \right]_1^{\infty} & \text{for } \Re(\alpha) \neq 1. \end{cases}$$

The integral converges only for  $\Re(\alpha) > 1$ . Thus the harmonic series converges absolutely for  $\Re(\alpha) > 1$  and diverges absolutely for  $\Re(\alpha) \leq 1$ .

## Solution 12.9

$$\begin{aligned}
 \sum_{n=1}^{N-1} \sin(nx) &= \sum_{n=0}^{N-1} \sin(nx) \\
 &= \sum_{n=0}^{N-1} \Im(e^{inx}) \\
 &= \Im \left( \sum_{n=0}^{N-1} (e^{ix})^n \right) \\
 &= \begin{cases} \Im(N) & \text{for } x = 2\pi k \\ \Im \left( \frac{1-e^{inx}}{1-e^{ix}} \right) & \text{for } x \neq 2\pi k \end{cases} \\
 &= \begin{cases} 0 & \text{for } x = 2\pi k \\ \Im \left( \frac{e^{-ix/2} - e^{i(N-1/2)x}}{e^{-ix/2} - e^{ix/2}} \right) & \text{for } x \neq 2\pi k \end{cases} \\
 &= \begin{cases} 0 & \text{for } x = 2\pi k \\ \Im \left( \frac{e^{-ix/2} - e^{i(N-1/2)x}}{-i2 \sin(x/2)} \right) & \text{for } x \neq 2\pi k \end{cases} \\
 &= \begin{cases} 0 & \text{for } x = 2\pi k \\ \Re \left( \frac{e^{-ix/2} - e^{i(N-1/2)x}}{2 \sin(x/2)} \right) & \text{for } x \neq 2\pi k \end{cases}
 \end{aligned}$$

$  \sum_{n=1}^{N-1} \sin(nx) = \begin{cases} 0 & \text{for } x = 2\pi k \\ \frac{\cos(x/2) - \cos((N-1/2)x)}{2 \sin(x/2)} & \text{for } x \neq 2\pi k \end{cases}  $
--

**Solution 12.10**

Let

$$S_n = \sum_{k=1}^n kz^k.$$

$$\begin{aligned} S_n - zS_n &= \sum_{k=1}^n kz^k - \sum_{k=1}^n kz^{k+1} \\ &= \sum_{k=1}^n kz^k - \sum_{k=2}^{n+1} (k-1)z^k \\ &= \sum_{k=1}^n z^k - nz^{n+1} \\ &= \frac{z - z^{n+1}}{1 - z} - nz^{n+1} \end{aligned}$$

$$\boxed{\sum_{k=1}^n kz^k = \frac{z(1 - (n+1)z^n + nz^{n+1})}{(1 - z)^2}}$$

Let

$$S_n = \sum_{k=1}^n k^2 z^k.$$

$$\begin{aligned} S_n - zS_n &= \sum_{k=1}^n (k^2 - (k-1)^2)z^k - n^2 z^{n+1} \\ &= 2 \sum_{k=1}^n kz^k - \sum_{k=1}^n z^k - n^2 z^{n+1} \\ &= 2 \frac{z(1 - (n+1)z^n + nz^{n+1})}{(1 - z)^2} - \frac{z - z^{n+1}}{1 - z} - n^2 z^{n+1} \end{aligned}$$

$$\sum_{k=1}^n k^2 z^k = \frac{z(1+z - z^n(1+z + n(n(z-1) - 2)(z-1)))}{(1-z)^3}$$

### Solution 12.11

1.

$$\sum_{n=1}^{\infty} a_n = \frac{1}{2} + \frac{1}{6} + \frac{1}{12} + \frac{1}{20} + \dots$$

We conjecture that the terms in the sum are rational functions of summation index. That is,  $a_n = 1/p(n)$  where  $p(n)$  is a polynomial. We use divided differences to determine the order of the polynomial.

$$\begin{array}{cccc} 2 & 6 & 12 & 20 \\ & 4 & 6 & 8 \\ & & 2 & 2 \end{array}$$

We see that the polynomial is second order.  $p(n) = an^2 + bn + c$ . We solve for the coefficients.

$$a + b + c = 2$$

$$4a + 2b + c = 6$$

$$9a + 3b + c = 12$$

$$p(n) = n^2 + n$$

We examine the first few partial sums.

$$S_1 = \frac{1}{2}$$

$$S_2 = \frac{2}{3}$$

$$S_3 = \frac{3}{4}$$

$$S_4 = \frac{4}{5}$$



We conjecture that  $S_n = n/(n+1)$ . We prove this with induction. The base case is  $n = 1$ .  $S_1 = 1/(1+1) = 1/2$ . Now we assume the induction hypothesis and calculate  $S_{n+1}$ .

$$\begin{aligned} S_{n+1} &= S_n + a_{n+1} \\ &= \frac{n}{n+1} + \frac{1}{(n+1)^2 + (n+1)} \\ &= \frac{n+1}{n+2} \end{aligned}$$

This proves the induction hypothesis. We calculate the limit of the partial sums to evaluate the series.

$$\sum_{n=1}^{\infty} \frac{1}{n^2 + n} = \lim_{n \rightarrow \infty} \frac{n}{n+1}$$

$$\sum_{n=1}^{\infty} \frac{1}{n^2 + n} = 1$$

2.

$$\sum_{n=0}^{\infty} (-1)^n = 1 + (-1) + 1 + (-1) + \dots$$

Since the terms in the series do not vanish as  $n \rightarrow \infty$ , the series is divergent.

3. We can directly sum this geometric series.

$$\sum_{n=1}^{\infty} \frac{1}{2^{n-1}} \frac{1}{3^n} \frac{1}{5^{n+1}} = \frac{1}{75} \frac{1}{1 - 1/30} = \frac{2}{145}$$

CONTINUE

**Solution 12.12**

The innermost sum is a geometric series.

$$\sum_{k_n=k_{n-1}}^{\infty} \frac{1}{2^{k_n}} = \frac{1}{2^{k_{n-1}}} \frac{1}{1 - 1/2} = 2^{1-k_{n-1}}$$

This gives us a relationship between  $n$  nested sums and  $n - 1$  nested sums.

$$\sum_{k_1=0}^{\infty} \sum_{k_2=k_1}^{\infty} \cdots \sum_{k_n=k_{n-1}}^{\infty} \frac{1}{2^{k_n}} = 2 \sum_{k_1=0}^{\infty} \sum_{k_2=k_1}^{\infty} \cdots \sum_{k_{n-1}=k_{n-2}}^{\infty} \frac{1}{2^{k_{n-1}}}$$

We evaluate the  $n$  nested sums by induction.

$$\boxed{\sum_{k_1=0}^{\infty} \sum_{k_2=k_1}^{\infty} \cdots \sum_{k_n=k_{n-1}}^{\infty} \frac{1}{2^{k_n}} = 2^n}$$

**Solution 12.13**

CONTINUE.

$$1. \sum_{n=0}^{\infty} \frac{z^n}{(z+3)^n}$$

$$2. \sum_{n=2}^{\infty} \frac{\text{Log } z}{\ln n}$$

$$3. \sum_{n=1}^{\infty} \frac{z}{n}$$

$$4. \sum_{n=1}^{\infty} \frac{(z+2)^2}{n^2}$$

$$5. \sum_{n=1}^{\infty} \frac{(z - e)^n}{n^n}$$

$$6. \sum_{n=1}^{\infty} \frac{z^{2n}}{2^{nz}}$$

$$7. \sum_{n=0}^{\infty} \frac{z^{n!}}{(n!)^2}$$

$$8. \sum_{n=0}^{\infty} \frac{z^{\ln(n!)}}{n!}$$

$$9. \sum_{n=0}^{\infty} \frac{(z - \pi)^{2n+1} n^\pi}{n!}$$

$$10. \sum_{n=0}^{\infty} \frac{\ln n}{z^n}$$

### Solution 12.14

1. We assume that  $\beta \neq 0$ . We determine the radius of convergence with the ratio test.

$$\begin{aligned} R &= \lim_{n \rightarrow \infty} \left| \frac{a_n}{a_{n+1}} \right| \\ &= \lim_{n \rightarrow \infty} \left| \frac{(\alpha - \beta) \cdots (\alpha - (n-1)\beta)/n!}{(\alpha - \beta) \cdots (\alpha - n\beta)/(n+1)!} \right| \\ &= \lim_{n \rightarrow \infty} \left| \frac{n+1}{\alpha - n\beta} \right| \\ &= \frac{1}{|\beta|} \end{aligned}$$

The series converges absolutely for  $|z| < 1/|\beta|$ .

2. By the ratio test formula, the radius of absolute convergence is

$$\begin{aligned} R &= \lim_{n \rightarrow \infty} \left| \frac{n/2^n}{(n+1)/2^{n+1}} \right| \\ &= 2 \lim_{n \rightarrow \infty} \left| \frac{n}{n+1} \right| \\ &= 2 \end{aligned}$$

By the root test formula, the radius of absolute convergence is

$$\begin{aligned} R &= \frac{1}{\lim_{n \rightarrow \infty} \sqrt[n]{|n/2^n|}} \\ &= \frac{2}{\lim_{n \rightarrow \infty} \sqrt[n]{n}} \\ &= 2 \end{aligned}$$

The series converges absolutely for  $|z - i| < 2$ .

3. We determine the radius of convergence with the **Cauchy-Hadamard formula**.

$$\begin{aligned} R &= \frac{1}{\limsup \sqrt[n]{|a_n|}} \\ &= \frac{1}{\limsup \sqrt[n]{|n^n|}} \\ &= \frac{1}{\limsup n} \\ &= 0 \end{aligned}$$

The series converges only for  $z = 0$ .

4. By the ratio test formula, the radius of absolute convergence is

$$\begin{aligned} R &= \lim_{n \rightarrow \infty} \left| \frac{n!/n^n}{(n+1)!/(n+1)^{n+1}} \right| \\ &= \lim_{n \rightarrow \infty} \left| \frac{(n+1)^n}{n^n} \right| \\ &= \lim_{n \rightarrow \infty} \left( \frac{n+1}{n} \right)^n \\ &= \exp \left( \lim_{n \rightarrow \infty} \ln \left( \left( \frac{n+1}{n} \right)^n \right) \right) \\ &= \exp \left( \lim_{n \rightarrow \infty} n \ln \left( \frac{n+1}{n} \right) \right) \\ &= \exp \left( \lim_{n \rightarrow \infty} \frac{\ln(n+1) - \ln(n)}{1/n} \right) \\ &= \exp \left( \lim_{n \rightarrow \infty} \frac{1/(n+1) - 1/n}{-1/n^2} \right) \\ &= \exp \left( \lim_{n \rightarrow \infty} \frac{n}{n+1} \right) \\ &= e^1 \end{aligned}$$

The series converges absolutely in the circle,  $|z| < e$ .

5. By the **Cauchy-Hadamard formula**, the radius of absolute convergence is

$$\begin{aligned} R &= \frac{1}{\limsup \sqrt[n]{|(3 + (-1)^n)^n|}} \\ &= \frac{1}{\limsup (3 + (-1)^n)} \\ &= \frac{1}{4} \end{aligned}$$

Thus the series converges absolutely for  $|z| < 1/4$ .

6. By the **Cauchy-Hadamard formula**, the radius of absolute convergence is

$$\begin{aligned} R &= \frac{1}{\limsup \sqrt[n]{|n + \alpha^n|}} \\ &= \frac{1}{\limsup |\alpha| \sqrt[n]{|1 + n/\alpha^n|}} \\ &= \frac{1}{|\alpha|} \end{aligned}$$

Thus the sum converges absolutely for  $|z| < 1/|\alpha|$ .

### Solution 12.15

1.

$$\sum_{k=0}^{\infty} k z^k$$

We determine the radius of convergence with the ratio formula.

$$\begin{aligned} R &= \lim_{k \rightarrow \infty} \left| \frac{k}{k+1} \right| \\ &= \lim_{k \rightarrow \infty} \frac{1}{1} \\ &= 1 \end{aligned}$$

The series converges absolutely for  $|z| < 1$ .

2.

$$\sum_{k=1}^{\infty} k^k z^k$$

We determine the radius of convergence with the Cauchy-Hadamard formula.

$$\begin{aligned} R &= \frac{1}{\limsup \sqrt[k]{|k^k|}} \\ &= \frac{1}{\limsup k} \\ &= 0 \end{aligned}$$

The series converges only for  $z = 0$ .

3.

$$\sum_{k=1}^{\infty} \frac{k!}{k^k} z^k$$

We determine the radius of convergence with the ratio formula.

$$\begin{aligned} R &= \lim_{k \rightarrow \infty} \left| \frac{k!/k^k}{(k+1)!/(k+1)^{(k+1)}} \right| \\ &= \lim_{k \rightarrow \infty} \frac{(k+1)^k}{k^k} \\ &= \exp \left( \lim_{k \rightarrow \infty} k \ln \left( \frac{k+1}{k} \right) \right) \\ &= \exp \left( \lim_{k \rightarrow \infty} \frac{\ln(k+1) - \ln(k)}{1/k} \right) \\ &= \exp \left( \lim_{k \rightarrow \infty} \frac{1/(k+1) - 1/k}{-1/k^2} \right) \\ &= \exp \left( \lim_{k \rightarrow \infty} \frac{k}{k+1} \right) \\ &= \exp(1) \\ &= e \end{aligned}$$

The series converges absolutely for  $|z| < e$ .

4.

$$\sum_{k=0}^{\infty} (z + i5)^{2k} (k + 1)^2$$

We use the ratio formula to determine the domain of convergence.

$$\begin{aligned} \lim_{k \rightarrow \infty} \left| \frac{(z + i5)^{2(k+1)} (k + 2)^2}{(z + i5)^{2k} (k + 1)^2} \right| &< 1 \\ |z + i5|^2 \lim_{k \rightarrow \infty} \left| \frac{(k + 2)^2}{(k + 1)^2} \right| &< 1 \\ |z + i5|^2 \lim_{k \rightarrow \infty} \frac{2(k + 2)}{2(k + 1)} &< 1 \\ |z + i5|^2 \lim_{k \rightarrow \infty} \frac{2}{2} &< 1 \\ |z + i5|^2 &< 1 \end{aligned}$$

5.

$$\sum_{k=0}^{\infty} (k + 2^k) z^k$$

We determine the radius of convergence with the Cauchy-Hadamard formula.

$$\begin{aligned} R &= \frac{1}{\limsup \sqrt[k]{|k + 2^k|}} \\ &= \frac{1}{\limsup 2 \sqrt[k]{|1 + k/2^k|}} \\ &= \frac{1}{2} \end{aligned}$$

The series converges for  $|z| < 1/2$ .



**Solution 12.16**

The geometric series is

$$\frac{1}{1-z} = \sum_{n=0}^{\infty} z^n.$$

This series is uniformly convergent in the domain,  $|z| \leq r < 1$ . Differentiating this equation yields,

$$\begin{aligned} \frac{1}{(1-z)^2} &= \sum_{n=1}^{\infty} n z^{n-1} \\ &= \sum_{n=0}^{\infty} (n+1) z^n \quad \text{for } |z| < 1. \end{aligned}$$

Integrating the geometric series yields

$$\begin{aligned} -\log(1-z) &= \sum_{n=0}^{\infty} \frac{z^{n+1}}{n+1} \\ \log(1-z) &= -\sum_{n=1}^{\infty} \frac{z^n}{n}, \quad \text{for } |z| < 1. \end{aligned}$$

**Solution 12.17**

$$\frac{1}{1+z^2} = \sum_{n=0}^{\infty} (-z^2)^n = \sum_{n=0}^{\infty} (-1)^n z^{2n}$$

The function  $\frac{1}{1+z^2} = \frac{1}{(1-iz)(1+iz)}$  has singularities at  $z = \pm i$ . Thus the radius of convergence is 1. Now we use the ratio

test to corroborate that the radius of convergence is 1.

$$\begin{aligned}\lim_{n \rightarrow \infty} \left| \frac{a_{n+1}(z)}{a_n(z)} \right| &< 1 \\ \lim_{n \rightarrow \infty} \left| \frac{(-1)^{n+1} z^{2(n+1)}}{(-1)^n z^{2n}} \right| &< 1 \\ \lim_{n \rightarrow \infty} |z^2| &< 1 \\ |z| &< 1\end{aligned}$$

## Solution 12.18

### Method 1.

$$\begin{aligned}\log(1+z) &= [\log(1+z)]_{z=0} + \left[ \frac{d}{dz} \log(1+z) \right]_{z=0} \frac{z}{1!} + \left[ \frac{d^2}{dz^2} \log(1+z) \right]_{z=0} \frac{z^2}{2!} + \cdots \\ &= 0 + \left[ \frac{1}{1+z} \right]_{z=0} \frac{z}{1!} + \left[ \frac{-1}{(1+z)^2} \right]_{z=0} \frac{z^2}{2!} + \left[ \frac{2}{(1+z)^3} \right]_{z=0} \frac{z^3}{3!} + \cdots \\ &= z - \frac{z^2}{2} + \frac{z^3}{3} - \frac{z^4}{4} + \cdots \\ &= \sum_{n=1}^{\infty} (-1)^{n+1} \frac{z^n}{n}\end{aligned}$$

Since the nearest singularity of  $\log(1+z)$  is at  $z = -1$ , the radius of convergence is 1.

**Method 2.** We know the geometric series converges for  $|z| < 1$ .

$$\frac{1}{1+z} = \sum_{n=0}^{\infty} (-1)^n z^n$$

We integrate this equation to get the series for  $\log(1+z)$  in the domain  $|z| < 1$ .

$$\log(1+z) = \sum_{n=0}^{\infty} (-1)^n \frac{z^{n+1}}{n+1} = \sum_{n=1}^{\infty} (-1)^{n+1} \frac{z^n}{n}$$

We calculate the radius of convergence with the ratio test.

$$R = \lim_{n \rightarrow \infty} \left| \frac{a_n}{a_{n+1}} \right| = \lim_{n \rightarrow \infty} \left| \frac{-(n+1)}{n} \right| = 1$$

Thus the series converges absolutely for  $|z| < 1$ .

### Solution 12.19

The Taylor series expansion of  $f(z)$  about  $z = 0$  is

$$f(z) = \sum_{n=0}^{\infty} \frac{f^{(n)}(0)}{n!} z^n.$$

The derivatives of  $f(z)$  are

$$f^{(n)}(z) = \left( \prod_{k=0}^{n-1} (\alpha - k) \right) (1+z)^{\alpha-n}.$$

Thus  $f^{(n)}(0)$  is

$$f^{(n)}(0) = \prod_{k=0}^{n-1} (\alpha - k).$$

If  $\alpha = m$  is a non-negative integer, then only the first  $m + 1$  terms are nonzero. The Taylor series is a polynomial and the series has an infinite radius of convergence.

$$(1+z)^m = \sum_{n=0}^m \frac{\prod_{k=0}^{n-1} (\alpha - k)}{n!} z^n$$

If  $\alpha$  is not a non-negative integer, then all of the terms in the series are non-zero.

$$(1+z)^\alpha = \sum_{n=0}^{\infty} \frac{\prod_{k=0}^{n-1} (\alpha - k)}{n!} z^n$$

The radius of convergence of the series is the distance to the nearest singularity of  $(1+z)^\alpha$ . This occurs at  $z = -1$ . Thus the series converges for  $|z| < 1$ . We can corroborate this with the ratio test. The radius of convergence is

$$R = \lim_{n \rightarrow \infty} \left| \frac{(\prod_{k=0}^{n-1} (\alpha - k)) / n!}{(\prod_{k=0}^n (\alpha - k)) / (n+1)!} \right| = \lim_{n \rightarrow \infty} \left| \frac{n+1}{\alpha - n} \right| = 1.$$

If we use the binomial coefficient, we can write the series in a compact form.

$$\binom{\alpha}{n} \equiv \frac{\prod_{k=0}^{n-1} (\alpha - k)}{n!}$$

$$(1+z)^\alpha = \sum_{n=0}^{\infty} \binom{\alpha}{n} z^n$$

### Solution 12.20

1. We find the series for  $1/z$  by writing it in terms of  $z - 1$  and using the geometric series.

$$\frac{1}{z} = \frac{1}{1 + (z - 1)}$$

$$\frac{1}{z} = \sum_{n=0}^{\infty} (-1)^n (z - 1)^n \quad \text{for } |z - 1| < 1$$

Since the nearest singularity is at  $z = 0$ , the radius of convergence is 1. The series converges absolutely for  $|z - 1| < 1$ . We could also determine the radius of convergence with the **Cauchy-Hadamard formula**.

$$\begin{aligned} R &= \frac{1}{\limsup \sqrt[n]{|a_n|}} \\ &= \frac{1}{\limsup \sqrt[n]{|(-1)^n|}} \\ &= 1 \end{aligned}$$

2. We integrate  $1/\zeta$  from 1 to  $z$  for in the circle  $|z - 1| < 1$ .

$$\int_1^z \frac{1}{\zeta} d\zeta = [\text{Log } \zeta]_1^z = \text{Log } z$$

The series we derived for  $1/z$  is uniformly convergent for  $|z - 1| \leq r < 1$ . We can integrate the series in this domain.

$$\begin{aligned} \text{Log } z &= \int_1^z \sum_{n=0}^{\infty} (-1)^n (\zeta - 1)^n d\zeta \\ &= \sum_{n=0}^{\infty} (-1)^n \int_1^z (\zeta - 1)^n d\zeta \\ &= \sum_{n=0}^{\infty} (-1)^n \frac{(z - 1)^{n+1}}{n + 1} \end{aligned}$$

$$\boxed{\text{Log } z = \sum_{n=1}^{\infty} \frac{(-1)^{n-1} (z - 1)^n}{n} \quad \text{for } |z - 1| < 1}$$

3. The series we derived for  $1/z$  is uniformly convergent for  $|z - 1| \leq r < 1$ . We can differentiate the series in this domain.

$$\begin{aligned} \frac{1}{z^2} &= -\frac{d}{dz} \frac{1}{z} \\ &= -\frac{d}{dz} \sum_{n=0}^{\infty} (-1)^n (z - 1)^n \\ &= \sum_{n=1}^{\infty} (-1)^{n+1} n (z - 1)^{n-1} \end{aligned}$$

$$\frac{1}{z^2} = \sum_{n=0}^{\infty} (-1)^n (n+1) (z-1)^n \quad \text{for } |z-1| < 1$$

4. We integrate  $\text{Log } \zeta$  from 1 to  $z$  for in the circle  $|z-1| < 1$ .

$$\int_1^z \text{Log } \zeta \, d\zeta = [\zeta \text{Log } \zeta - \zeta]_1^z = z \text{Log } z - z + 1$$

The series we derived for  $\text{Log } z$  is uniformly convergent for  $|z-1| \leq r < 1$ . We can integrate the series in this domain.

$$\begin{aligned} z \text{Log } z - z &= -1 + \int_1^z \text{Log } \zeta \, d\zeta \\ &= -1 + \int_1^z \sum_{n=1}^{\infty} \frac{(-1)^{n-1} (\zeta-1)^n}{n} \, d\zeta \\ &= -1 + \sum_{n=1}^{\infty} \frac{(-1)^{n-1} (z-1)^{n+1}}{n(n+1)} \end{aligned}$$

$$z \text{Log } z - z = -1 + \sum_{n=2}^{\infty} \frac{(-1)^n (z-1)^n}{n(n-1)} \quad \text{for } |z-1| < 1$$

### Solution 12.21

We evaluate the derivatives of  $e^z$  at  $z = 0$ . Then we use **Taylor's Theorem**.

$$\begin{aligned} \frac{d^n}{dz^n} e^z &= e^z \\ \frac{d^n}{dz^n} e^z &= e^z \Big|_{z=0} = 1 \end{aligned}$$

$$e^z = \sum_{n=0}^{\infty} \frac{z^n}{n!}$$

Since the exponential function has no singularities in the finite complex plane, the radius of convergence is infinite.

We find the Taylor series for the cosine and sine by writing them in terms of the exponential function.

$$\begin{aligned}\cos z &= \frac{e^{iz} + e^{-iz}}{2} \\ &= \frac{1}{2} \left( \sum_{n=0}^{\infty} \frac{(iz)^n}{n!} + \sum_{n=0}^{\infty} \frac{(-iz)^n}{n!} \right) \\ &= \sum_{\substack{n=0 \\ \text{even } n}}^{\infty} \frac{(iz)^n}{n!}\end{aligned}$$

$$\cos z = \sum_{n=0}^{\infty} \frac{(-1)^n z^{2n}}{(2n)!}$$

$$\begin{aligned}\sin z &= \frac{e^{iz} - e^{-iz}}{i2} \\ &= \frac{1}{i2} \left( \sum_{n=0}^{\infty} \frac{(iz)^n}{n!} - \sum_{n=0}^{\infty} \frac{(-iz)^n}{n!} \right) \\ &= -i \sum_{\substack{n=0 \\ \text{odd } n}}^{\infty} \frac{(iz)^n}{n!}\end{aligned}$$

$$\sin z = \sum_{n=0}^{\infty} \frac{(-1)^n z^{2n+1}}{(2n+1)!}$$

**Solution 12.22**

$$\begin{aligned}\cos z &= -\cos(z - \pi) \\ &= -\sum_{n=0}^{\infty} \frac{(-1)^n (z - \pi)^{2n}}{(2n)!} \\ &= \sum_{n=0}^{\infty} \frac{(-1)^{n+1} (z - \pi)^{2n}}{(2n)!}\end{aligned}$$

$$\begin{aligned}\sin z &= -\sin(z - \pi) \\ &= -\sum_{n=0}^{\infty} \frac{(-1)^n (z - \pi)^{2n+1}}{(2n+1)!} \\ &= \sum_{n=0}^{\infty} \frac{(-1)^{n+1} (z - \pi)^{2n+1}}{(2n+1)!}\end{aligned}$$

**Solution 12.23**

CONTINUE

**Solution 12.24**

1. (a)

$$f(z) = e^{-z}$$

$$f(0) = 1$$

$$f'(0) = -1$$

$$f''(0) = 1$$

$$e^{-z} = 1 - z + \frac{z^2}{2} + \mathcal{O}(z^3)$$

Since  $e^{-z}$  is entire, the Taylor series converges in the complex plane.



(b)

$$\begin{aligned}f(z) &= \frac{1+z}{1-z}, & f(i) &= i \\f'(z) &= \frac{2}{(1-z)^2}, & f'(i) &= i \\f''(z) &= \frac{4}{(1-z)^3}, & f''(i) &= -1+i\end{aligned}$$

$$\frac{1+z}{1-z} = i + i(z-i) + \frac{-1+i}{2}(z-i)^2 + \mathcal{O}((z-i)^3)$$

Since the nearest singularity, (at  $z = 1$ ), is a distance of  $\sqrt{2}$  from  $z_0 = i$ , the radius of convergence is  $\sqrt{2}$ . The series converges absolutely for  $|z - i| < \sqrt{2}$ .

(c)

$$\begin{aligned}\frac{e^z}{z-1} &= -\left(1+z+\frac{z^2}{2}+\mathcal{O}(z^3)\right)(1+z+z^2+\mathcal{O}(z^3)) \\&= -1-2z-\frac{5}{2}z^2+\mathcal{O}(z^3)\end{aligned}$$

Since the nearest singularity, (at  $z = 1$ ), is a distance of 1 from  $z_0 = 0$ , the radius of convergence is 1. The series converges absolutely for  $|z| < 1$ .

2. Since  $f(z)$  is analytic in  $|z - z_0| < R$ , its Taylor series converges absolutely on this domain.

$$f(z) = \sum_{n=0}^{\infty} \frac{f^{(n)}(z_0)z^n}{n!}$$

The Taylor series converges uniformly on any closed sub-domain of  $|z - z_0| < R$ . We consider the sub-domain

$|z - z_0| \leq \rho < R$ . On the domain of uniform convergence we can interchange differentiation and summation.

$$f'(z) = \frac{d}{dz} \sum_{n=0}^{\infty} \frac{f^{(n)}(z_0)z^n}{n!}$$

$$f'(z) = \sum_{n=1}^{\infty} \frac{n f^{(n)}(z_0)z^{n-1}}{n!}$$

$$f'(z) = \sum_{n=0}^{\infty} \frac{f^{(n+1)}(z_0)z^n}{n!}$$

Note that this is the Taylor series that we could obtain directly for  $f'(z)$ . Since  $f(z)$  is analytic on  $|z - z_0| < R$  so is  $f'(z)$ .

$$f'(z) = \sum_{n=0}^{\infty} \frac{f^{(n+1)}(z_0)z^n}{n!}$$

3.

$$\begin{aligned} \frac{1}{(1-z)^3} &= \frac{d^2}{dz^2} \frac{1}{2} \frac{1}{1-z} \\ &= \frac{1}{2} \frac{d^2}{dz^2} \sum_{n=0}^{\infty} z^n \\ &= \frac{1}{2} \sum_{n=2}^{\infty} n(n-1)z^{n-2} \\ &= \frac{1}{2} \sum_{n=0}^{\infty} (n+2)(n+1)z^n \end{aligned}$$

The radius of convergence is 1, which is the distance to the nearest singularity at  $z = 1$ .

4. The Taylor series expansion of  $f(z)$  about  $z = 0$  is

$$f(z) = \sum_{n=0}^{\infty} \frac{f^{(n)}(0)}{n!} z^n.$$

We compute the derivatives of  $f(z)$ .

$$f^{(n)}(z) = \left( \prod_{k=0}^{n-1} (\iota - k) \right) (1+z)^{\iota-n}.$$

Now we determine the coefficients in the series.

$$f^{(n)}(0) = \prod_{k=0}^{n-1} (\iota - k)$$

$$(1+z)^\iota = \sum_{n=0}^{\infty} \frac{\prod_{k=0}^{n-1} (\iota - k)}{n!} z^n$$

The radius of convergence of the series is the distance to the nearest singularity of  $(1+z)^\iota$ . This occurs at  $z = -1$ . Thus the series converges for  $|z| < 1$ . We can corroborate this with the ratio test. We compute the radius of convergence.

$$R = \lim_{n \rightarrow \infty} \left| \frac{(\prod_{k=0}^{n-1} (\iota - k)) / n!}{(\prod_{k=0}^n (\iota - k)) / (n+1)!} \right| = \lim_{n \rightarrow \infty} \left| \frac{n+1}{\iota - n} \right| = 1$$

If we use the binomial coefficient,

$$\binom{\alpha}{n} \equiv \frac{\prod_{k=0}^{n-1} (\alpha - k)}{n!},$$

then we can write the series in a compact form.

$$(1+z)^\iota = \sum_{n=0}^{\infty} \binom{\iota}{n} z^n$$

**Solution 12.25**

For  $|z| < 1$ :

$$\begin{aligned}\frac{1}{z-i} &= \frac{i}{1+iz} \\ &= i \sum_{n=0}^{\infty} (-iz)^n\end{aligned}$$

(Note that  $|z| < 1 \Leftrightarrow |-iz| < 1$ .)

For  $|z| > 1$ :

$$\frac{1}{z-i} = \frac{1}{z} \frac{1}{1-i/z}$$

(Note that  $|z| > 1 \Leftrightarrow |-i/z| < 1$ .)

$$\begin{aligned}&= \frac{1}{z} \sum_{n=0}^{\infty} \left(\frac{i}{z}\right)^n \\ &= \frac{1}{z} \sum_{n=-\infty}^0 i^{-n} z^n \\ &= \sum_{n=-\infty}^0 (-i)^n z^{n-1} \\ &= \sum_{n=-\infty}^{-1} (-i)^{n+1} z^n\end{aligned}$$

**Solution 12.26**

We expand the function in partial fractions.

$$f(z) = \frac{1}{(z+1)(z+2)} = \frac{1}{z+1} - \frac{1}{z+2}$$

The Taylor series about  $z = 0$  for  $1/(z + 1)$  is

$$\begin{aligned}\frac{1}{1+z} &= \frac{1}{1-(-z)} \\ &= \sum_{n=0}^{\infty} (-z)^n, \quad \text{for } |z| < 1 \\ &= \sum_{n=0}^{\infty} (-1)^n z^n, \quad \text{for } |z| < 1\end{aligned}$$

The series about  $z = \infty$  for  $1/(z + 1)$  is

$$\begin{aligned}\frac{1}{1+z} &= \frac{1/z}{1+1/z} \\ &= \frac{1}{z} \sum_{n=0}^{\infty} (-1/z)^n, \quad \text{for } |1/z| < 1 \\ &= \sum_{n=0}^{\infty} (-1)^n z^{-n-1}, \quad \text{for } |z| > 1 \\ &= \sum_{n=-\infty}^{-1} (-1)^{n+1} z^n, \quad \text{for } |z| > 1\end{aligned}$$

The Taylor series about  $z = 0$  for  $1/(z + 2)$  is

$$\begin{aligned}\frac{1}{2+z} &= \frac{1/2}{1+z/2} \\ &= \frac{1}{2} \sum_{n=0}^{\infty} (-z/2)^n, \quad \text{for } |z/2| < 1 \\ &= \sum_{n=0}^{\infty} \frac{(-1)^n}{2^{n+1}} z^n, \quad \text{for } |z| < 2\end{aligned}$$

The series about  $z = \infty$  for  $1/(z + 2)$  is

$$\begin{aligned}\frac{1}{2+z} &= \frac{1/z}{1+2/z} \\ &= \frac{1}{z} \sum_{n=0}^{\infty} (-2/z)^n, \quad \text{for } |2/z| < 1 \\ &= \sum_{n=0}^{\infty} (-1)^n 2^n z^{-n-1}, \quad \text{for } |z| > 2 \\ &= \sum_{n=-\infty}^{-1} \frac{(-1)^{n+1}}{2^{n+1}} z^n, \quad \text{for } |z| > 2\end{aligned}$$

To find the expansions in the three regions, we just choose the appropriate series.

1.

$$\begin{aligned}f(z) &= \frac{1}{1+z} - \frac{1}{2+z} \\ &= \sum_{n=0}^{\infty} (-1)^n z^n - \sum_{n=0}^{\infty} \frac{(-1)^n}{2^{n+1}} z^n, \quad \text{for } |z| < 1 \\ &= \sum_{n=0}^{\infty} (-1)^n \left(1 - \frac{1}{2^{n+1}}\right) z^n, \quad \text{for } |z| < 1\end{aligned}$$

$$f(z) = \sum_{n=0}^{\infty} (-1)^n \frac{2^{n+1} - 1}{2^{n+1}} z^n, \quad \text{for } |z| < 1$$

2.

$$f(z) = \frac{1}{1+z} - \frac{1}{2+z}$$

$$f(z) = \sum_{n=-\infty}^{-1} (-1)^{n+1} z^n - \sum_{n=0}^{\infty} \frac{(-1)^n}{2^{n+1}} z^n, \quad \text{for } 1 < |z| < 2$$

3.

$$\begin{aligned} f(z) &= \frac{1}{1+z} - \frac{1}{2+z} \\ &= \sum_{n=-\infty}^{-1} (-1)^{n+1} z^n - \sum_{n=-\infty}^{-1} \frac{(-1)^{n+1}}{2^{n+1}} z^n, \quad \text{for } 2 < |z| \end{aligned}$$

$$f(z) = \sum_{n=-\infty}^{-1} (-1)^{n+1} \frac{2^{n+1} - 1}{2^{n+1}} z^n, \quad \text{for } 2 < |z|$$

### Solution 12.27

**Laurent Series.** We assume that  $m$  is a non-negative integer and that  $n$  is an integer. The Laurent series about the point  $z = 0$  of

$$f(z) = \left(z + \frac{1}{z}\right)^m$$

is

$$f(z) = \sum_{n=-\infty}^{\infty} a_n z^n$$

where

$$a_n = \frac{1}{i2\pi} \oint_C \frac{f(z)}{z^{n+1}} dz$$

and  $C$  is a contour going around the origin once in the positive direction. We manipulate the coefficient integral into the desired form.

$$\begin{aligned}
 a_n &= \frac{1}{i2\pi} \oint_C \frac{(z + 1/z)^m}{z^{n+1}} dz \\
 &= \frac{1}{i2\pi} \int_0^{2\pi} \frac{(e^{i\theta} + e^{-i\theta})^m}{e^{i(n+1)\theta}} i e^{i\theta} d\theta \\
 &= \frac{1}{2\pi} \int_0^{2\pi} 2^m \cos^m \theta e^{-m\theta} d\theta \\
 &= \frac{2^{m-1}}{\pi} \int_0^{2\pi} \cos^m \theta (\cos(n\theta) - i \sin(n\theta)) d\theta
 \end{aligned}$$

Note that  $\cos^m \theta$  is even and  $\sin(n\theta)$  is odd about  $\theta = \pi$ .

$$= \frac{2^{m-1}}{\pi} \int_0^{2\pi} \cos^m \theta \cos(n\theta) d\theta$$

**Binomial Series.** Now we find the binomial series expansion of  $f(z)$ .

$$\begin{aligned}
 \left(z + \frac{1}{z}\right)^m &= \sum_{n=0}^m \binom{m}{n} z^{m-n} \left(\frac{1}{z}\right)^n \\
 &= \sum_{n=0}^m \binom{m}{n} z^{m-2n} \\
 &= \sum_{\substack{n=-m \\ m-n \text{ even}}}^m \binom{m}{(m-n)/2} z^n
 \end{aligned}$$



The coefficients in the series  $f(z) = \sum_{n=-\infty}^{\infty} a_n z^n$  are

$$a_n = \begin{cases} \binom{m}{(m-n)/2} & -m \leq n \leq m \text{ and } m - n \text{ even} \\ 0 & \text{otherwise} \end{cases}$$

By equating the coefficients found by the two methods, we evaluate the desired integral.

$$\int_0^{2\pi} (\cos \theta)^m \cos(n\theta) d\theta = \begin{cases} \frac{\pi}{2^{m-1}} \binom{m}{(m-n)/2} & -m \leq n \leq m \text{ and } m - n \text{ even} \\ 0 & \text{otherwise} \end{cases}$$

### Solution 12.28

First we write  $f(z)$  in the form

$$f(z) = \frac{g(z)}{(z - i/2)(z - 2)^2}.$$

$g(z)$  is an entire function which grows no faster than  $z^3$  at infinity. By expanding  $g(z)$  in a Taylor series about the origin, we see that it is a polynomial of degree no greater than 3.

$$f(z) = \frac{\alpha z^3 + \beta z^2 + \gamma z + \delta}{(z - i/2)(z - 2)^2}$$

Since  $f(z)$  is a rational function we expand it in partial fractions to obtain a form that is convenient to integrate.

$$f(z) = \frac{a}{z - i/2} + \frac{b}{z - 2} + \frac{c}{(z - 2)^2} + d$$

We use the value of the integrals of  $f(z)$  to determine the constants,  $a$ ,  $b$ ,  $c$  and  $d$ .

$$\oint_{|z|=1} \left( \frac{a}{z - i/2} + \frac{b}{z - 2} + \frac{c}{(z - 2)^2} + d \right) dz = i2\pi$$

$$i2\pi a = i2\pi$$

$$a = 1$$

$$\oint_{|z|=3} \left( \frac{1}{z - i/2} + \frac{b}{z - 2} + \frac{c}{(z - 2)^2} + d \right) dz = 0$$

$$i2\pi(1 + b) = 0$$

$$b = -1$$

Note that by applying the second constraint, we can change the third constraint to

$$\oint_{|z|=3} z f(z) dz = 0.$$

$$\oint_{|z|=3} z \left( \frac{1}{z - i/2} - \frac{1}{z - 2} + \frac{c}{(z - 2)^2} + d \right) dz = 0$$

$$\oint_{|z|=3} \left( \frac{(z - i/2) + i/2}{z - i/2} - \frac{(z - 2) + 2}{z - 2} + \frac{c(z - 2) + 2c}{(z - 2)^2} \right) dz = 0$$

$$i2\pi \left( \frac{i}{2} - 2 + c \right) = 0$$

$$c = 2 - \frac{i}{2}$$

Thus we see that the function is

$$f(z) = \frac{1}{z - i/2} - \frac{1}{z - 2} + \frac{2 - i/2}{(z - 2)^2} + d,$$

where  $d$  is an arbitrary constant. We can also write the function in the form:

$$f(z) = \frac{dz^3 + 15 - i8}{4(z - i/2)(z - 2)^2}.$$

**Complete Laurent Series.** We find the complete Laurent series about  $z = 0$  for each of the terms in the partial

fraction expansion of  $f(z)$ .

$$\begin{aligned}\frac{1}{z - i/2} &= \frac{i2}{1 + i2z} \\ &= i2 \sum_{n=0}^{\infty} (-i2z)^n, \quad \text{for } |-i2z| < 1 \\ &= - \sum_{n=0}^{\infty} (-i2)^{n+1} z^n, \quad \text{for } |z| < 1/2\end{aligned}$$

$$\begin{aligned}\frac{1}{z - i/2} &= \frac{1/z}{1 - i/(2z)} \\ &= \frac{1}{z} \sum_{n=0}^{\infty} \left(\frac{i}{2z}\right)^n, \quad \text{for } |i/(2z)| < 1 \\ &= \sum_{n=0}^{\infty} \left(\frac{i}{2}\right)^n z^{-n-1}, \quad \text{for } |z| < 2 \\ &= \sum_{n=-\infty}^{-1} \left(\frac{i}{2}\right)^{-n-1} z^n, \quad \text{for } |z| < 2 \\ &= \sum_{n=-\infty}^{-1} (-i2)^{n+1} z^n, \quad \text{for } |z| < 2\end{aligned}$$

$$\begin{aligned}
-\frac{1}{z-2} &= \frac{1/2}{1-z/2} \\
&= \frac{1}{2} \sum_{n=0}^{\infty} \left(\frac{z}{2}\right)^n, \quad \text{for } |z/2| < 1 \\
&= \sum_{n=0}^{\infty} \frac{z^n}{2^{n+1}}, \quad \text{for } |z| < 2
\end{aligned}$$

$$\begin{aligned}
-\frac{1}{z-2} &= -\frac{1/z}{1-2/z} \\
&= -\frac{1}{z} \sum_{n=0}^{\infty} \left(\frac{2}{z}\right)^n, \quad \text{for } |2/z| < 1 \\
&= -\sum_{n=0}^{\infty} 2^n z^{-n-1}, \quad \text{for } |z| > 2 \\
&= -\sum_{n=-\infty}^{-1} 2^{-n-1} z^n, \quad \text{for } |z| > 2
\end{aligned}$$

$$\begin{aligned}
\frac{2 - i/2}{(z - 2)^2} &= (2 - i/2) \frac{1}{4} (1 - z/2)^{-2} \\
&= \frac{4 - i}{8} \sum_{n=0}^{\infty} \binom{-2}{n} \left(-\frac{z}{2}\right)^n, \quad \text{for } |z/2| < 1 \\
&= \frac{4 - i}{8} \sum_{n=0}^{\infty} (-1)^n (n + 1) (-1)^n 2^{-n} z^n, \quad \text{for } |z| < 2 \\
&= \frac{4 - i}{8} \sum_{n=0}^{\infty} \frac{n + 1}{2^n} z^n, \quad \text{for } |z| < 2
\end{aligned}$$

$$\begin{aligned}
\frac{2 - i/2}{(z - 2)^2} &= \frac{2 - i/2}{z^2} \left(1 - \frac{2}{z}\right)^{-2} \\
&= \frac{2 - i/2}{z^2} \sum_{n=0}^{\infty} \binom{-2}{n} \left(-\frac{2}{z}\right)^n, \quad \text{for } |2/z| < 1 \\
&= (2 - i/2) \sum_{n=0}^{\infty} (-1)^n (n + 1) (-1)^n 2^n z^{-n-2}, \quad \text{for } |z| > 2 \\
&= (2 - i/2) \sum_{n=-\infty}^{-2} (-n - 1) 2^{-n-2} z^n, \quad \text{for } |z| > 2 \\
&= -(2 - i/2) \sum_{n=-\infty}^{-2} \frac{n + 1}{2^{n+2}} z^n, \quad \text{for } |z| > 2
\end{aligned}$$

We take the appropriate combination of these series to find the Laurent series expansions in the regions:  $|z| < 1/2$ ,

$1/2 < |z| < 2$  and  $2 < |z|$ . For  $|z| < 1/2$ , we have

$$f(z) = -\sum_{n=0}^{\infty} (-i2)^{n+1} z^n + \sum_{n=0}^{\infty} \frac{z^n}{2^{n+1}} + \frac{4-i}{8} \sum_{n=0}^{\infty} \frac{n+1}{2^n} z^n + d$$

$$f(z) = \sum_{n=0}^{\infty} \left( -(-i2)^{n+1} + \frac{1}{2^{n+1}} + \frac{4-i}{8} \frac{n+1}{2^n} \right) z^n + d$$

$$f(z) = \sum_{n=0}^{\infty} \left( -(-i2)^{n+1} + \frac{1}{2^{n+1}} \left( 1 + \frac{4-i}{4} (n+1) \right) \right) z^n + d, \quad \text{for } |z| < 1/2$$

For  $1/2 < |z| < 2$ , we have

$$f(z) = \sum_{n=-\infty}^{-1} (-i2)^{n+1} z^n + \sum_{n=0}^{\infty} \frac{z^n}{2^{n+1}} + \frac{4-i}{8} \sum_{n=0}^{\infty} \frac{n+1}{2^n} z^n + d$$

$$f(z) = \sum_{n=-\infty}^{-1} (-i2)^{n+1} z^n + \sum_{n=0}^{\infty} \left( \frac{1}{2^{n+1}} \left( 1 + \frac{4-i}{4} (n+1) \right) \right) z^n + d, \quad \text{for } 1/2 < |z| < 2$$

For  $2 < |z|$ , we have

$$f(z) = \sum_{n=-\infty}^{-1} (-i2)^{n+1} z^n - \sum_{n=-\infty}^{-1} 2^{-n-1} z^n - (2-i/2) \sum_{n=-\infty}^{-2} \frac{n+1}{2^{n+2}} z^n + d$$

$$f(z) = \sum_{n=-\infty}^{-2} \left( (-i2)^{n+1} - \frac{1}{2^{n+1}} (1 + (1-i/4)(n+1)) \right) z^n + d, \quad \text{for } 2 < |z|$$

### Solution 12.29

The radius of convergence of the series for  $f(z)$  is

$$R = \lim_{n \rightarrow \infty} \left| \frac{k^3/3^k}{(k+1)^3/3^{k+1}} \right| = 3 \lim_{n \rightarrow \infty} \left| \frac{k^3}{(k+1)^3} \right| = 3.$$

Thus  $f(z)$  is a function which is analytic inside the circle of radius 3.

1. The integrand is analytic. Thus by Cauchy's theorem the value of the integral is zero.

$$\oint_{|z|=1} e^{iz} f(z) dz = 0$$

2. We use Cauchy's integral formula to evaluate the integral.

$$\oint_{|z|=1} \frac{f(z)}{z^4} dz = \frac{i2\pi}{3!} f^{(3)}(0) = \frac{i2\pi}{3!} \frac{3!3^3}{3^3} = i2\pi$$

$$\oint_{|z|=1} \frac{f(z)}{z^4} dz = i2\pi$$

3. We use Cauchy's integral formula to evaluate the integral.

$$\oint_{|z|=1} \frac{f(z) e^z}{z^2} dz = \frac{i2\pi}{1!} \frac{d}{dz} (f(z) e^z) \Big|_{z=0} = i2\pi \frac{1!1^3}{3^1}$$

$$\oint_{|z|=1} \frac{f(z) e^z}{z^2} dz = \frac{i2\pi}{3}$$

### Solution 12.30

1. (a)

$$\begin{aligned} \frac{1}{z(1-z)} &= \frac{1}{z} + \frac{1}{1-z} \\ &= \frac{1}{z} + \sum_{n=0}^{\infty} z^n, \quad \text{for } 0 < |z| < 1 \\ &= \frac{1}{z} + \sum_{n=-1}^{\infty} z^n, \quad \text{for } 0 < |z| < 1 \end{aligned}$$

(b)

$$\begin{aligned}\frac{1}{z(1-z)} &= \frac{1}{z} + \frac{1}{1-z} \\ &= \frac{1}{z} - \frac{1}{z} \frac{1}{1-1/z} \\ &= \frac{1}{z} - \frac{1}{z} \sum_{n=0}^{\infty} \left(\frac{1}{z}\right)^n, \quad \text{for } |z| > 1 \\ &= -\frac{1}{z} \sum_{n=1}^{\infty} z^{-n}, \quad \text{for } |z| > 1 \\ &= -\sum_{n=-2}^{-\infty} z^n, \quad \text{for } |z| > 1\end{aligned}$$



(c)

$$\begin{aligned}\frac{1}{z(1-z)} &= \frac{1}{z} + \frac{1}{1-z} \\ &= \frac{1}{(z+1)-1} + \frac{1}{2-(z+1)} \\ &= \frac{1}{(z+1)} \frac{1}{1-1/(z+1)} - \frac{1}{(z+1)} \frac{1}{1-2/(z+1)}, \quad \text{for } |z+1| > 1 \text{ and } |z+1| > 2 \\ &= \frac{1}{(z+1)} \sum_{n=0}^{\infty} \frac{1}{(z+1)^n} - \frac{1}{(z+1)} \sum_{n=0}^{\infty} \frac{2^n}{(z+1)^n}, \quad \text{for } |z+1| > 1 \text{ and } |z+1| > 2 \\ &= \frac{1}{(z+1)} \sum_{n=0}^{\infty} \frac{1-2^n}{(z+1)^n}, \quad \text{for } |z+1| > 2 \\ &= \sum_{n=1}^{\infty} \frac{1-2^n}{(z+1)^{n+1}}, \quad \text{for } |z+1| > 2 \\ &= \sum_{n=-2}^{-\infty} (1-2^{-n-1})(z+1)^n, \quad \text{for } |z+1| > 2\end{aligned}$$

2. First we factor the denominator of  $f(z) = 1/(z^4 + 4)$ .

$$z^4 + 4 = (z - 1 - i)(z - 1 + i)(z + 1 - i)(z + 1 + i)$$

We look for an annulus about  $z = 1$  containing the point  $z = i$  where  $f(z)$  is analytic. The singularities at  $z = 1 \pm i$  are a distance of 1 from  $z = 1$ ; the singularities at  $z = -1 \pm i$  are at a distance of  $\sqrt{5}$ . Since  $f(z)$  is analytic in the domain  $1 < |z - 1| < \sqrt{5}$  there is a convergent Laurent series in that domain.

# Chapter 13

## The Residue Theorem

Man will occasionally stumble over the truth, but most of the time he will pick himself up and continue on.

- Winston Churchill

### 13.1 The Residue Theorem

We will find that many integrals on closed contours may be evaluated in terms of the *residues* of a function. We first define residues and then prove the Residue Theorem.

**Result 13.1.1 Residues.** Let  $f(z)$  be single-valued and analytic in a deleted neighborhood of  $z_0$ . Then  $f(z)$  has the Laurent series expansion

$$f(z) = \sum_{n=-\infty}^{\infty} a_n (z - z_0)^n,$$

The residue of  $f(z)$  at  $z = z_0$  is the coefficient of the  $\frac{1}{z - z_0}$  term:

$$\text{Res}(f(z), z_0) = a_{-1}.$$

The residue at a branch point or non-isolated singularity is undefined as the Laurent series does not exist. If  $f(z)$  has a pole of order  $n$  at  $z = z_0$  then we can use the Residue Formula:

$$\text{Res}(f(z), z_0) = \lim_{z \rightarrow z_0} \left( \frac{1}{(n-1)!} \frac{d^{n-1}}{dz^{n-1}} [(z - z_0)^n f(z)] \right).$$

See Exercise 13.4 for a proof of the Residue Formula.

**Example 13.1.1** In Example 8.4.5 we showed that  $f(z) = z/\sin z$  has first order poles at  $z = n\pi$ ,  $n \in \mathbb{Z} \setminus \{0\}$ . Now

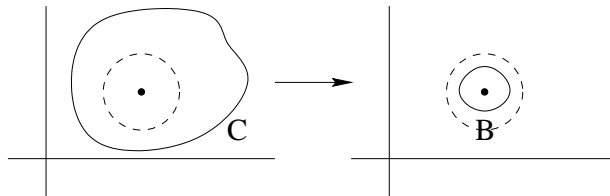

Figure 13.1: Deform the contour to lie in the deleted disk.

*we find the residues at these isolated singularities.*

$$\begin{aligned}
 \operatorname{Res}\left(\frac{z}{\sin z}, z = n\pi\right) &= \lim_{z \rightarrow n\pi} \left( (z - n\pi) \frac{z}{\sin z} \right) \\
 &= n\pi \lim_{z \rightarrow n\pi} \frac{z - n\pi}{\sin z} \\
 &= n\pi \lim_{z \rightarrow n\pi} \frac{1}{\cos z} \\
 &= n\pi \frac{1}{(-1)^n} \\
 &= (-1)^n n\pi
 \end{aligned}$$

**Residue Theorem.** We can evaluate many integrals in terms of the residues of a function. Suppose  $f(z)$  has only one singularity, (at  $z = z_0$ ), inside the simple, closed, positively oriented contour  $C$ .  $f(z)$  has a convergent Laurent series in some deleted disk about  $z_0$ . We deform  $C$  to lie in the disk. See Figure 13.1. We now evaluate  $\int_C f(z) dz$  by deforming the contour and using the Laurent series expansion of the function.

$$\begin{aligned}
\int_C f(z) dz &= \int_B f(z) dz \\
&= \int_B \sum_{n=-\infty}^{\infty} a_n (z - z_0)^n dz \\
&= \sum_{\substack{n=-\infty \\ n \neq -1}}^{\infty} a_n \left[ \frac{(z - z_0)^{n+1}}{n+1} \right]_{r e^{i\theta}}^{r e^{i(\theta+2\pi)}} + a_{-1} [\log(z - z_0)]_{r e^{i\theta}}^{r e^{i(\theta+2\pi)}} \\
&= a_{-1} i 2\pi
\end{aligned}$$

$$\int_C f(z) dz = i 2\pi \operatorname{Res}(f(z), z_0)$$

Now assume that  $f(z)$  has  $n$  singularities at  $\{z_1, \dots, z_n\}$ . We deform  $C$  to  $n$  contours  $C_1, \dots, C_n$  which enclose the singularities and lie in deleted disks about the singularities in which  $f(z)$  has convergent Laurent series. See Figure 13.2. We evaluate  $\int_C f(z) dz$  by deforming the contour.

$$\int_C f(z) dz = \sum_{k=1}^n \int_{C_k} f(z) dz = i 2\pi \sum_{k=1}^n \operatorname{Res}(f(z), z_k)$$

Now instead let  $f(z)$  be analytic *outside* and on  $C$  except for isolated singularities at  $\{\zeta_n\}$  in the domain outside  $C$  and perhaps an isolated singularity at infinity. Let  $a$  be any point in the interior of  $C$ . To evaluate  $\int_C f(z) dz$  we make the change of variables  $\zeta = 1/(z - a)$ . This maps the contour  $C$  to  $C'$ . (Note that  $C'$  is negatively oriented.) All the points outside  $C$  are mapped to points inside  $C'$  and vice versa. We can then evaluate the integral in terms of the singularities inside  $C'$ .

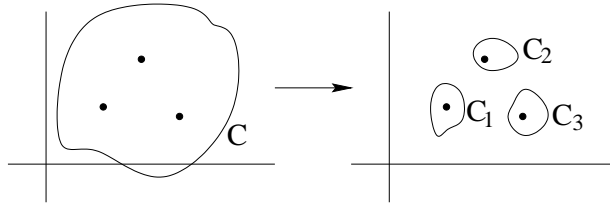

Figure 13.2: Deform the contour  $n$  contours which enclose the  $n$  singularities.

$$\begin{aligned}
 \oint_C f(z) dz &= \oint_{C'} f\left(\frac{1}{\zeta} + a\right) \frac{-1}{\zeta^2} d\zeta \\
 &= \oint_{-C'} \frac{1}{z^2} f\left(\frac{1}{z} + a\right) dz \\
 &= i2\pi \sum_n \operatorname{Res}\left(\frac{1}{z^2} f\left(\frac{1}{z} + a\right), \frac{1}{\zeta_n - a}\right) + i2\pi \operatorname{Res}\left(\frac{1}{z^2} f\left(\frac{1}{z} + a\right), 0\right).
 \end{aligned}$$

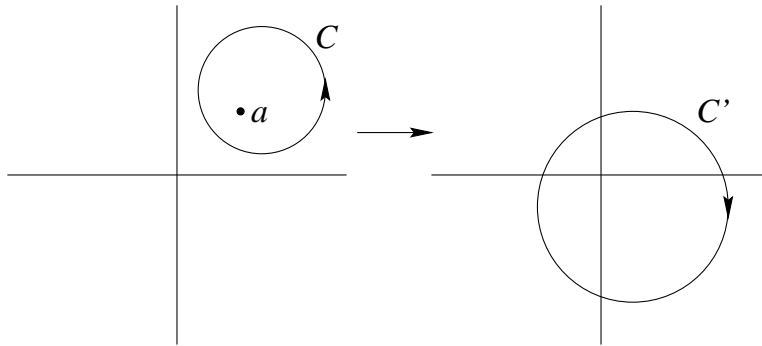

Figure 13.3: The change of variables  $\zeta = 1/(z - a)$ .

**Result 13.1.2 Residue Theorem.** If  $f(z)$  is analytic in a compact, closed, connected domain  $D$  except for isolated singularities at  $\{z_n\}$  in the interior of  $D$  then

$$\int_{\partial D} f(z) dz = \sum_k \oint_{C_k} f(z) dz = i2\pi \sum_n \text{Res}(f(z), z_n).$$

Here the set of contours  $\{C_k\}$  make up the positively oriented boundary  $\partial D$  of the domain  $D$ . If the boundary of the domain is a single contour  $C$  then the formula simplifies.

$$\oint_C f(z) dz = i2\pi \sum_n \text{Res}(f(z), z_n)$$

If instead  $f(z)$  is analytic outside and on  $C$  except for isolated singularities at  $\{\zeta_n\}$  in the domain outside  $C$  and perhaps an isolated singularity at infinity then

$$\oint_C f(z) dz = i2\pi \sum_n \text{Res} \left( \frac{1}{z^2} f \left( \frac{1}{z} + a \right), \frac{1}{\zeta_n - a} \right) + i2\pi \text{Res} \left( \frac{1}{z^2} f \left( \frac{1}{z} + a \right), 0 \right).$$

Here  $a$  is a any point in the interior of  $C$ .

**Example 13.1.2** Consider

$$\frac{1}{i2\pi} \int_C \frac{\sin z}{z(z-1)} dz$$

where  $C$  is the positively oriented circle of radius 2 centered at the origin. Since the integrand is single-valued with only isolated singularities, the Residue Theorem applies. The value of the integral is the sum of the residues from singularities inside the contour.

The only places that the integrand could have singularities are  $z = 0$  and  $z = 1$ . Since

$$\lim_{z \rightarrow 0} \frac{\sin z}{z} = \lim_{z \rightarrow 0} \frac{\cos z}{1} = 1,$$

there is a removable singularity at the point  $z = 0$ . There is no residue at this point.

Now we consider the point  $z = 1$ . Since  $\sin(z)/z$  is analytic and nonzero at  $z = 1$ , that point is a first order pole of the integrand. The residue there is

$$\text{Res} \left( \frac{\sin z}{z(z-1)}, z = 1 \right) = \lim_{z \rightarrow 1} (z-1) \frac{\sin z}{z(z-1)} = \sin(1).$$

There is only one singular point with a residue inside the path of integration. The residue at this point is  $\sin(1)$ . Thus the value of the integral is

$$\frac{1}{i2\pi} \int_C \frac{\sin z}{z(z-1)} dz = \sin(1)$$

**Example 13.1.3** Evaluate the integral

$$\int_C \frac{\cot z \coth z}{z^3} dz$$

where  $C$  is the unit circle about the origin in the positive direction.

The integrand is

$$\frac{\cot z \coth z}{z^3} = \frac{\cos z \cosh z}{z^3 \sin z \sinh z}$$



$\sin z$  has zeros at  $n\pi$ .  $\sinh z$  has zeros at  $in\pi$ . Thus the only pole inside the contour of integration is at  $z = 0$ . Since  $\sin z$  and  $\sinh z$  both have simple zeros at  $z = 0$ ,

$$\sin z = z + \mathcal{O}(z^3), \quad \sinh z = z + \mathcal{O}(z^3)$$

the integrand has a pole of order 5 at the origin. The residue at  $z = 0$  is

$$\begin{aligned} \lim_{z \rightarrow 0} \frac{1}{4!} \frac{d^4}{dz^4} \left( z^5 \frac{\cot z \coth z}{z^3} \right) &= \lim_{z \rightarrow 0} \frac{1}{4!} \frac{d^4}{dz^4} (z^2 \cot z \coth z) \\ &= \frac{1}{4!} \lim_{z \rightarrow 0} \left( 24 \cot(z) \coth(z) \csc(z)^2 - 32z \coth(z) \csc(z)^4 \right. \\ &\quad - 16z \cos(2z) \coth(z) \csc(z)^4 + 22z^2 \cot(z) \coth(z) \csc(z)^4 \\ &\quad + 2z^2 \cos(3z) \coth(z) \csc(z)^5 + 24 \cot(z) \coth(z) \operatorname{csch}(z)^2 \\ &\quad + 24 \csc(z)^2 \operatorname{csch}(z)^2 - 48z \cot(z) \csc(z)^2 \operatorname{csch}(z)^2 \\ &\quad - 48z \coth(z) \csc(z)^2 \operatorname{csch}(z)^2 + 24z^2 \cot(z) \coth(z) \csc(z)^2 \operatorname{csch}(z)^2 \\ &\quad + 16z^2 \csc(z)^4 \operatorname{csch}(z)^2 + 8z^2 \cos(2z) \csc(z)^4 \operatorname{csch}(z)^2 \\ &\quad - 32z \cot(z) \operatorname{csch}(z)^4 - 16z \cosh(2z) \cot(z) \operatorname{csch}(z)^4 \\ &\quad + 22z^2 \cot(z) \coth(z) \operatorname{csch}(z)^4 + 16z^2 \csc(z)^2 \operatorname{csch}(z)^4 \\ &\quad \left. + 8z^2 \cosh(2z) \csc(z)^2 \operatorname{csch}(z)^4 + 2z^2 \cosh(3z) \cot(z) \operatorname{csch}(z)^5 \right) \\ &= \frac{1}{4!} \left( -\frac{56}{15} \right) \\ &= -\frac{7}{45} \end{aligned}$$

Since taking the fourth derivative of  $z^2 \cot z \coth z$  really sucks, we would like a more elegant way of finding the residue. We expand the functions in the integrand in Taylor series about the origin.

$$\begin{aligned}
 \frac{\cos z \cosh z}{z^3 \sin z \sinh z} &= \frac{\left(1 - \frac{z^2}{2} + \frac{z^4}{24} - \dots\right) \left(1 + \frac{z^2}{2} + \frac{z^4}{24} + \dots\right)}{z^3 \left(z - \frac{z^3}{6} + \frac{z^5}{120} - \dots\right) \left(z + \frac{z^3}{6} + \frac{z^5}{120} + \dots\right)} \\
 &= \frac{1 - \frac{z^4}{6} + \dots}{z^3 \left(z^2 + z^6 \left(\frac{-1}{36} + \frac{1}{60}\right) + \dots\right)} \\
 &= \frac{1}{z^5} \frac{1 - \frac{z^4}{6} + \dots}{1 - \frac{z^4}{90} + \dots} \\
 &= \frac{1}{z^5} \left(1 - \frac{z^4}{6} + \dots\right) \left(1 + \frac{z^4}{90} + \dots\right) \\
 &= \frac{1}{z^5} \left(1 - \frac{7}{45} z^4 + \dots\right) \\
 &= \frac{1}{z^5} - \frac{7}{45} \frac{1}{z} + \dots
 \end{aligned}$$

Thus we see that the residue is  $-\frac{7}{45}$ . Now we can evaluate the integral.

$$\int_C \frac{\cot z \coth z}{z^3} dz = -i \frac{14}{45} \pi$$

## 13.2 Cauchy Principal Value for Real Integrals

### 13.2.1 The Cauchy Principal Value

First we recap improper integrals. If  $f(x)$  has a singularity at  $x_0 \in (a \dots b)$  then

$$\int_a^b f(x) dx \equiv \lim_{\epsilon \rightarrow 0^+} \int_a^{x_0 - \epsilon} f(x) dx + \lim_{\delta \rightarrow 0^+} \int_{x_0 + \delta}^b f(x) dx.$$

For integrals on  $(-\infty \dots \infty)$ ,

$$\int_{-\infty}^{\infty} f(x) \, dx \equiv \lim_{a \rightarrow -\infty, b \rightarrow \infty} \int_a^b f(x) \, dx.$$

**Example 13.2.1**  $\int_{-1}^1 \frac{1}{x} \, dx$  is divergent. We show this with the definition of improper integrals.

$$\begin{aligned} \int_{-1}^1 \frac{1}{x} \, dx &= \lim_{\epsilon \rightarrow 0^+} \int_{-1}^{-\epsilon} \frac{1}{x} \, dx + \lim_{\delta \rightarrow 0^+} \int_{\delta}^1 \frac{1}{x} \, dx \\ &= \lim_{\epsilon \rightarrow 0^+} [\ln |x|]_{-1}^{-\epsilon} + \lim_{\delta \rightarrow 0^+} [\ln |x|]_{\delta}^1 \\ &= \lim_{\epsilon \rightarrow 0^+} \ln \epsilon - \lim_{\delta \rightarrow 0^+} \ln \delta \end{aligned}$$

The integral diverges because  $\epsilon$  and  $\delta$  approach zero independently.

Since  $1/x$  is an odd function, it appears that the area under the curve is zero. Consider what would happen if  $\epsilon$  and  $\delta$  were not independent. If they approached zero symmetrically,  $\delta = \epsilon$ , then the value of the integral would be zero.

$$\lim_{\epsilon \rightarrow 0^+} \left( \int_{-1}^{-\epsilon} + \int_{\epsilon}^1 \right) \frac{1}{x} \, dx = \lim_{\epsilon \rightarrow 0^+} (\ln \epsilon - \ln \epsilon) = 0$$

We could make the integral have any value we pleased by choosing  $\delta = c\epsilon$ .<sup>1</sup>

$$\lim_{\epsilon \rightarrow 0^+} \left( \int_{-1}^{-\epsilon} + \int_{c\epsilon}^1 \right) \frac{1}{x} \, dx = \lim_{\epsilon \rightarrow 0^+} (\ln \epsilon - \ln(c\epsilon)) = -\ln c$$

We have seen it is reasonable that

$$\int_{-1}^1 \frac{1}{x} \, dx$$

has some meaning, and if we could evaluate the integral, the most reasonable value would be zero. The *Cauchy principal value* provides us with a way of evaluating such integrals. If  $f(x)$  is continuous on  $(a, b)$  except at the point  $x_0 \in (a, b)$

---

<sup>1</sup>This may remind you of conditionally convergent series. You can rearrange the terms to make the series sum to any number.

then the Cauchy principal value of the integral is defined

$$\int_a^b f(x) dx = \lim_{\epsilon \rightarrow 0^+} \left( \int_a^{x_0 - \epsilon} f(x) dx + \int_{x_0 + \epsilon}^b f(x) dx \right).$$

The Cauchy principal value is obtained by approaching the singularity symmetrically. The principal value of the integral may exist when the integral diverges. If the integral exists, it is equal to the principal value of the integral.

The Cauchy principal value of  $\int_{-1}^1 \frac{1}{x} dx$  is defined

$$\begin{aligned} \int_{-1}^1 \frac{1}{x} dx &\equiv \lim_{\epsilon \rightarrow 0^+} \left( \int_{-1}^{-\epsilon} \frac{1}{x} dx + \int_{\epsilon}^1 \frac{1}{x} dx \right) \\ &= \lim_{\epsilon \rightarrow 0^+} \left( [\log |x|]_{-1}^{-\epsilon} [\log |x|]_{\epsilon}^1 \right) \\ &= \lim_{\epsilon \rightarrow 0^+} (\log |-\epsilon| - \log |\epsilon|) \\ &= 0. \end{aligned}$$

(Another notation for the principal value of an integral is  $\text{PV} \int f(x) dx$ .) Since the limits of integration approach zero symmetrically, the two halves of the integral cancel. If the limits of integration approached zero independently, (the definition of the integral), then the two halves would both diverge.

**Example 13.2.2**  $\int_{-\infty}^{\infty} \frac{x}{x^2+1} dx$  is divergent. We show this with the definition of improper integrals.

$$\begin{aligned} \int_{-\infty}^{\infty} \frac{x}{x^2+1} dx &= \lim_{a \rightarrow -\infty, b \rightarrow \infty} \int_a^b \frac{x}{x^2+1} dx \\ &= \lim_{a \rightarrow -\infty, b \rightarrow \infty} \left[ \frac{1}{2} \ln(x^2+1) \right]_a^b \\ &= \frac{1}{2} \lim_{a \rightarrow -\infty, b \rightarrow \infty} \ln \left( \frac{b^2+1}{a^2+1} \right) \end{aligned}$$

The integral diverges because  $a$  and  $b$  approach infinity independently. Now consider what would happen if  $a$  and  $b$  were not independent. If they approached zero symmetrically,  $a = -b$ , then the value of the integral would be zero.

$$\frac{1}{2} \lim_{b \rightarrow \infty} \ln \left( \frac{b^2 + 1}{b^2 + 1} \right) = 0$$

We could make the integral have any value we pleased by choosing  $a = -cb$ .

We can assign a meaning to divergent integrals of the form  $\int_{-\infty}^{\infty} f(x) dx$  with the Cauchy principal value. The Cauchy principal value of the integral is defined

$$\int_{-\infty}^{\infty} f(x) dx = \lim_{a \rightarrow \infty} \int_{-a}^a f(x) dx.$$

The Cauchy principal value is obtained by approaching infinity symmetrically.

The Cauchy principal value of  $\int_{-\infty}^{\infty} \frac{x}{x^2+1} dx$  is defined

$$\begin{aligned} \int_{-\infty}^{\infty} \frac{x}{x^2+1} dx &= \lim_{a \rightarrow \infty} \int_{-a}^a \frac{x}{x^2+1} dx \\ &= \lim_{a \rightarrow \infty} \left[ \frac{1}{2} \ln(x^2+1) \right]_{-a}^a \\ &= 0. \end{aligned}$$

**Result 13.2.1 Cauchy Principal Value.** If  $f(x)$  is continuous on  $(a, b)$  except at the point  $x_0 \in (a, b)$  then the integral of  $f(x)$  is defined

$$\int_a^b f(x) dx = \lim_{\epsilon \rightarrow 0^+} \int_a^{x_0 - \epsilon} f(x) dx + \lim_{\delta \rightarrow 0^+} \int_{x_0 + \delta}^b f(x) dx.$$

The Cauchy principal value of the integral is defined

$$\int_a^b f(x) dx = \lim_{\epsilon \rightarrow 0^+} \left( \int_a^{x_0 - \epsilon} f(x) dx + \int_{x_0 + \epsilon}^b f(x) dx \right).$$

If  $f(x)$  is continuous on  $(-\infty, \infty)$  then the integral of  $f(x)$  is defined

$$\int_{-\infty}^{\infty} f(x) dx = \lim_{a \rightarrow -\infty, b \rightarrow \infty} \int_a^b f(x) dx.$$

The Cauchy principal value of the integral is defined

$$\int_{-\infty}^{\infty} f(x) dx = \lim_{a \rightarrow \infty} \int_{-a}^a f(x) dx.$$

The principal value of the integral may exist when the integral diverges. If the integral exists, it is equal to the principal value of the integral.

**Example 13.2.3** Clearly  $\int_{-\infty}^{\infty} x dx$  diverges, however the Cauchy principal value exists.

$$\int_{-\infty}^{\infty} x dx = \lim_{a \rightarrow \infty} \left[ \frac{x^2}{2} \right]_{-a}^a \quad a = 0$$

In general, if  $f(x)$  is an odd function with no singularities on the finite real axis then

$$\int_{-\infty}^{\infty} f(x) dx = 0.$$

## 13.3 Cauchy Principal Value for Contour Integrals

**Example 13.3.1** Consider the integral

$$\int_{C_r} \frac{1}{z-1} dz,$$

where  $C_r$  is the positively oriented circle of radius  $r$  and center at the origin. From the residue theorem, we know that the integral is

$$\int_{C_r} \frac{1}{z-1} dz = \begin{cases} 0 & \text{for } r < 1, \\ i2\pi & \text{for } r > 1. \end{cases}$$

When  $r = 1$ , the integral diverges, as there is a first order pole on the path of integration. However, the principal value of the integral exists.

$$\begin{aligned} \int_{C_r} \frac{1}{z-1} dz &= \lim_{\epsilon \rightarrow 0^+} \int_{\epsilon}^{2\pi-\epsilon} \frac{1}{e^{i\theta}-1} i e^{i\theta} d\theta \\ &= \lim_{\epsilon \rightarrow 0^+} [\log(e^{i\theta}-1)]_{\epsilon}^{2\pi-\epsilon} \end{aligned}$$

We choose the branch of the logarithm with a branch cut on the positive real axis and  $\arg \log z \in (0, 2\pi)$ .

$$\begin{aligned}
 &= \lim_{\epsilon \rightarrow 0^+} (\log(e^{i(2\pi-\epsilon)} - 1) - \log(e^{i\epsilon} - 1)) \\
 &= \lim_{\epsilon \rightarrow 0^+} (\log((1 - i\epsilon + O(\epsilon^2)) - 1) - \log((1 + i\epsilon + O(\epsilon^2)) - 1)) \\
 &= \lim_{\epsilon \rightarrow 0^+} (\log(-i\epsilon + O(\epsilon^2)) - \log(i\epsilon + O(\epsilon^2))) \\
 &= \lim_{\epsilon \rightarrow 0^+} (\text{Log}(\epsilon + O(\epsilon^2)) + i \arg(-i\epsilon + O(\epsilon^2)) - \text{Log}(\epsilon + O(\epsilon^2)) - i \arg(i\epsilon + O(\epsilon^2))) \\
 &= i\frac{3\pi}{2} - i\frac{\pi}{2} \\
 &= i\pi
 \end{aligned}$$

Thus we obtain

$$\oint_{C_r} \frac{1}{z-1} dz = \begin{cases} 0 & \text{for } r < 1, \\ i\pi & \text{for } r = 1, \\ i2\pi & \text{for } r > 1. \end{cases}$$

In the above example we evaluated the contour integral by parameterizing the contour. This approach is only feasible when the integrand is simple. We would like to use the residue theorem to more easily evaluate the principal value of the integral. But before we do that, we will need a preliminary result.

**Result 13.3.1** Let  $f(z)$  have a first order pole at  $z = z_0$  and let  $(z - z_0)f(z)$  be analytic in some neighborhood of  $z_0$ . Let the contour  $C_\epsilon$  be a circular arc from  $z_0 + \epsilon e^{i\alpha}$  to  $z_0 + \epsilon e^{i\beta}$ . (We assume that  $\beta > \alpha$  and  $\beta - \alpha < 2\pi$ .)

$$\lim_{\epsilon \rightarrow 0^+} \int_{C_\epsilon} f(z) dz = i(\beta - \alpha) \text{Res}(f(z), z_0)$$

The contour is shown in Figure 13.4. (See Exercise 13.9 for a proof of this result.)



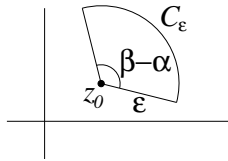

Figure 13.4: The  $C_\epsilon$  Contour

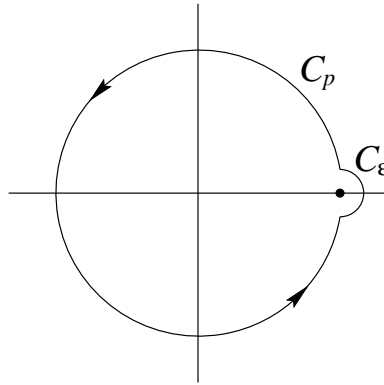

Figure 13.5: The indented contour.

**Example 13.3.2** Consider

$$\oint_C \frac{1}{z-1} dz$$

where  $C$  is the unit circle. Let  $C_p$  be the circular arc of radius 1 that starts and ends a distance of  $\epsilon$  from  $z = 1$ . Let  $C_\epsilon$  be the positive, circular arc of radius  $\epsilon$  with center at  $z = 1$  that joins the endpoints of  $C_p$ . Let  $C_i$ , be the union of  $C_p$  and  $C_\epsilon$ . ( $C_p$  stands for Principal value Contour;  $C_i$  stands for Indented Contour.)  $C_i$  is an indented contour that avoids the first order pole at  $z = 1$ . Figure 13.5 shows the three contours.

Note that the principal value of the integral is

$$\int_C \frac{1}{z-1} dz = \lim_{\epsilon \rightarrow 0^+} \int_{C_\epsilon} \frac{1}{z-1} dz.$$

We can calculate the integral along  $C_i$  with the residue theorem.

$$\int_{C_i} \frac{1}{z-1} dz = i2\pi$$

We can calculate the integral along  $C_\epsilon$  using Result 13.3.1. Note that as  $\epsilon \rightarrow 0^+$ , the contour becomes a semi-circle, a circular arc of  $\pi$  radians.

$$\lim_{\epsilon \rightarrow 0^+} \int_{C_\epsilon} \frac{1}{z-1} dz = i\pi \operatorname{Res} \left( \frac{1}{z-1}, 1 \right) = i\pi$$

Now we can write the principal value of the integral along  $C$  in terms of the two known integrals.

$$\begin{aligned} \int_C \frac{1}{z-1} dz &= \int_{C_i} \frac{1}{z-1} dz - \int_{C_\epsilon} \frac{1}{z-1} dz \\ &= i2\pi - i\pi \\ &= i\pi \end{aligned}$$

In the previous example, we formed an indented contour that included the first order pole. You can show that if we had indented the contour to exclude the pole, we would obtain the same result. (See Exercise 13.11.)

We can extend the residue theorem to principal values of integrals. (See Exercise 13.10.)

**Result 13.3.2 Residue Theorem for Principal Values.** Let  $f(z)$  be analytic inside and on a simple, closed, positive contour  $C$ , except for isolated singularities at  $z_1, \dots, z_m$  inside the contour and first order poles at  $\zeta_1, \dots, \zeta_n$  on the contour. Further, let the contour be  $C^1$  at the locations of these first order poles. (i.e., the contour does not have a corner at any of the first order poles.) Then the principal value of the integral of  $f(z)$  along  $C$  is

$$\oint_C f(z) dz = i2\pi \sum_{j=1}^m \text{Res}(f(z), z_j) + i\pi \sum_{j=1}^n \text{Res}(f(z), \zeta_j).$$

## 13.4 Integrals on the Real Axis

**Example 13.4.1** *We wish to evaluate the integral*

$$\int_{-\infty}^{\infty} \frac{1}{x^2 + 1} dx.$$

*We can evaluate this integral directly using calculus.*

$$\begin{aligned} \int_{-\infty}^{\infty} \frac{1}{x^2 + 1} dx &= [\arctan x]_{-\infty}^{\infty} \\ &= \pi \end{aligned}$$

*Now we will evaluate the integral using contour integration. Let  $C_R$  be the semicircular arc from  $R$  to  $-R$  in the upper half plane. Let  $C$  be the union of  $C_R$  and the interval  $[-R, R]$ .*

*We can evaluate the integral along  $C$  with the residue theorem. The integrand has first order poles at  $z = \pm i$ . For*

$R > 1$ , we have

$$\begin{aligned}\int_C \frac{1}{z^2 + 1} dz &= i2\pi \operatorname{Res} \left( \frac{1}{z^2 + 1}, i \right) \\ &= i2\pi \frac{1}{i2} \\ &= \pi.\end{aligned}$$

Now we examine the integral along  $C_R$ . We use the maximum modulus integral bound to show that the value of the integral vanishes as  $R \rightarrow \infty$ .

$$\begin{aligned}\left| \int_{C_R} \frac{1}{z^2 + 1} dz \right| &\leq \pi R \max_{z \in C_R} \left| \frac{1}{z^2 + 1} \right| \\ &= \pi R \frac{1}{R^2 - 1} \\ &\rightarrow 0 \quad \text{as } R \rightarrow \infty.\end{aligned}$$

Now we are prepared to evaluate the original real integral.

$$\begin{aligned}\int_C \frac{1}{z^2 + 1} dz &= \pi \\ \int_{-R}^R \frac{1}{x^2 + 1} dx + \int_{C_R} \frac{1}{z^2 + 1} dz &= \pi\end{aligned}$$

We take the limit as  $R \rightarrow \infty$ .

$$\boxed{\int_{-\infty}^{\infty} \frac{1}{x^2 + 1} dx = \pi}$$

We would get the same result by closing the path of integration in the lower half plane. Note that in this case the closed contour would be in the negative direction.

If you are really observant, you may have noticed that we did something a little funny in evaluating

$$\int_{-\infty}^{\infty} \frac{1}{x^2 + 1} dx.$$

The definition of this improper integral is

$$\int_{-\infty}^{\infty} \frac{1}{x^2 + 1} dx = \lim_{a \rightarrow +\infty} \int_{-a}^0 \frac{1}{x^2 + 1} dx + \lim_{b \rightarrow +\infty} \int_0^b \frac{1}{x^2 + 1} dx.$$

In the above example we instead computed

$$\lim_{R \rightarrow +\infty} \int_{-R}^R \frac{1}{x^2 + 1} dx.$$

Note that for some integrands, the former and latter are not the same. Consider the integral of  $\frac{x}{x^2+1}$ .

$$\begin{aligned} \int_{-\infty}^{\infty} \frac{x}{x^2 + 1} dx &= \lim_{a \rightarrow +\infty} \int_{-a}^0 \frac{x}{x^2 + 1} dx + \lim_{b \rightarrow +\infty} \int_0^b \frac{x}{x^2 + 1} dx \\ &= \lim_{a \rightarrow +\infty} \left( \frac{1}{2} \log |a^2 + 1| \right) + \lim_{b \rightarrow +\infty} \left( -\frac{1}{2} \log |b^2 + 1| \right) \end{aligned}$$

Note that the limits do not exist and hence the integral diverges. We get a different result if the limits of integration approach infinity symmetrically.

$$\begin{aligned} \lim_{R \rightarrow +\infty} \int_{-R}^R \frac{x}{x^2 + 1} dx &= \lim_{R \rightarrow +\infty} \left( \frac{1}{2} (\log |R^2 + 1| - \log |R^2 + 1|) \right) \\ &= 0 \end{aligned}$$

(Note that the integrand is an odd function, so the integral from  $-R$  to  $R$  is zero.) We call this the *principal value* of the integral and denote it by writing "PV" in front of the integral sign or putting a dash through the integral.

$$\text{PV} \int_{-\infty}^{\infty} f(x) dx \equiv \int_{-\infty}^{\infty} f(x) dx \equiv \lim_{R \rightarrow +\infty} \int_{-R}^R f(x) dx$$

The principal value of an integral may exist when the integral diverges. If the integral does converge, then it is equal to its principal value.

We can use the method of Example 13.4.1 to evaluate the principal value of integrals of functions that vanish fast enough at infinity.

**Result 13.4.1** Let  $f(z)$  be analytic except for isolated singularities, with only first order poles on the real axis. Let  $C_R$  be the semi-circle from  $R$  to  $-R$  in the upper half plane. If

$$\lim_{R \rightarrow \infty} \left( R \max_{z \in C_R} |f(z)| \right) = 0$$

then

$$\int_{-\infty}^{\infty} f(x) dx = i2\pi \sum_{k=1}^m \text{Res}(f(z), z_k) + i\pi \sum_{k=1}^n \text{Res}(f(z), x_k)$$

where  $z_1, \dots, z_m$  are the singularities of  $f(z)$  in the upper half plane and  $x_1, \dots, x_n$  are the first order poles on the real axis.

Now let  $C_R$  be the semi-circle from  $R$  to  $-R$  in the lower half plane. If

$$\lim_{R \rightarrow \infty} \left( R \max_{z \in C_R} |f(z)| \right) = 0$$

then

$$\int_{-\infty}^{\infty} f(x) dx = -i2\pi \sum_{k=1}^m \text{Res}(f(z), z_k) - i\pi \sum_{k=1}^n \text{Res}(f(z), x_k)$$

where  $z_1, \dots, z_m$  are the singularities of  $f(z)$  in the lower half plane and  $x_1, \dots, x_n$  are the first order poles on the real axis.

This result is proved in Exercise 13.13. Of course we can use this result to evaluate the integrals of the form

$$\int_0^{\infty} f(z) dz,$$

where  $f(x)$  is an even function.

## 13.5 Fourier Integrals

In order to do Fourier transforms, which are useful in solving differential equations, it is necessary to be able to calculate Fourier integrals. Fourier integrals have the form

$$\int_{-\infty}^{\infty} e^{i\omega x} f(x) dx.$$

We evaluate these integrals by closing the path of integration in the lower or upper half plane and using techniques of contour integration.

Consider the integral

$$\int_0^{\pi/2} e^{-R \sin \theta} d\theta.$$

Since  $2\theta/\pi \leq \sin \theta$  for  $0 \leq \theta \leq \pi/2$ ,

$$e^{-R \sin \theta} \leq e^{-R2\theta/\pi} \quad \text{for } 0 \leq \theta \leq \pi/2$$

$$\begin{aligned} \int_0^{\pi/2} e^{-R \sin \theta} d\theta &\leq \int_0^{\pi/2} e^{-R2\theta/\pi} d\theta \\ &= \left[ -\frac{\pi}{2R} e^{-R2\theta/\pi} \right]_0^{\pi/2} \\ &= -\frac{\pi}{2R} (e^{-R} - 1) \\ &\leq \frac{\pi}{2R} \\ &\rightarrow 0 \quad \text{as } R \rightarrow \infty \end{aligned}$$

We can use this to prove the following Result 13.5.1. (See Exercise 13.17.)

**Result 13.5.1 Jordan's Lemma.**

$$\int_0^\pi e^{-R \sin \theta} d\theta < \frac{\pi}{R}.$$

Suppose that  $f(z)$  vanishes as  $|z| \rightarrow \infty$ . If  $\omega$  is a (positive/negative) real number and  $C_R$  is a semi-circle of radius  $R$  in the (upper/lower) half plane then the integral

$$\int_{C_R} f(z) e^{i\omega z} dz$$

vanishes as  $R \rightarrow \infty$ .

We can use Jordan's Lemma and the Residue Theorem to evaluate many Fourier integrals. Consider  $\int_{-\infty}^{\infty} f(x) e^{i\omega x} dx$ , where  $\omega$  is a positive real number. Let  $f(z)$  be analytic except for isolated singularities, with only first order poles on the real axis. Let  $C$  be the contour from  $-R$  to  $R$  on the real axis and then back to  $-R$  along a semi-circle in the upper half plane. If  $R$  is large enough so that  $C$  encloses all the singularities of  $f(z)$  in the upper half plane then

$$\int_C f(z) e^{i\omega z} dz = i2\pi \sum_{k=1}^m \text{Res}(f(z) e^{i\omega z}, z_k) + i\pi \sum_{k=1}^n \text{Res}(f(z) e^{i\omega z}, x_k)$$

where  $z_1, \dots, z_m$  are the singularities of  $f(z)$  in the upper half plane and  $x_1, \dots, x_n$  are the first order poles on the real axis. If  $f(z)$  vanishes as  $|z| \rightarrow \infty$  then the integral on  $C_R$  vanishes as  $R \rightarrow \infty$  by Jordan's Lemma.

$$\int_{-\infty}^{\infty} f(x) e^{i\omega x} dx = i2\pi \sum_{k=1}^m \text{Res}(f(z) e^{i\omega z}, z_k) + i\pi \sum_{k=1}^n \text{Res}(f(z) e^{i\omega z}, x_k)$$

For negative  $\omega$  we close the path of integration in the lower half plane. Note that the contour is then in the negative direction.



**Result 13.5.2 Fourier Integrals.** Let  $f(z)$  be analytic except for isolated singularities, with only first order poles on the real axis. Suppose that  $f(z)$  vanishes as  $|z| \rightarrow \infty$ . If  $\omega$  is a positive real number then

$$\int_{-\infty}^{\infty} f(x) e^{i\omega x} dx = i2\pi \sum_{k=1}^m \operatorname{Res}(f(z) e^{i\omega z}, z_k) + i\pi \sum_{k=1}^n \operatorname{Res}(f(z) e^{i\omega z}, x_k)$$

where  $z_1, \dots, z_m$  are the singularities of  $f(z)$  in the upper half plane and  $x_1, \dots, x_n$  are the first order poles on the real axis. If  $\omega$  is a negative real number then

$$\int_{-\infty}^{\infty} f(x) e^{i\omega x} dx = -i2\pi \sum_{k=1}^m \operatorname{Res}(f(z) e^{i\omega z}, z_k) - i\pi \sum_{k=1}^n \operatorname{Res}(f(z) e^{i\omega z}, x_k)$$

where  $z_1, \dots, z_m$  are the singularities of  $f(z)$  in the lower half plane and  $x_1, \dots, x_n$  are the first order poles on the real axis.

## 13.6 Fourier Cosine and Sine Integrals

Fourier cosine and sine integrals have the form,

$$\int_0^{\infty} f(x) \cos(\omega x) dx \quad \text{and} \quad \int_0^{\infty} f(x) \sin(\omega x) dx.$$

If  $f(x)$  is even/odd then we can evaluate the cosine/sine integral with the method we developed for Fourier integrals.

Let  $f(z)$  be analytic except for isolated singularities, with only first order poles on the real axis. Suppose that  $f(x)$  is an even function and that  $f(z)$  vanishes as  $|z| \rightarrow \infty$ . We consider real  $\omega > 0$ .

$$\int_0^{\infty} f(x) \cos(\omega x) dx = \frac{1}{2} \int_{-\infty}^{\infty} f(x) \cos(\omega x) dx$$

Since  $f(x) \sin(\omega x)$  is an odd function,

$$\frac{1}{2} \int_{-\infty}^{\infty} f(x) \sin(\omega x) dx = 0.$$

Thus

$$\int_0^{\infty} f(x) \cos(\omega x) dx = \frac{1}{2} \int_{-\infty}^{\infty} f(x) e^{i\omega x} dx$$

Now we apply Result [13.5.2](#).

$$\int_0^{\infty} f(x) \cos(\omega x) dx = i\pi \sum_{k=1}^m \operatorname{Res}(f(z) e^{i\omega z}, z_k) + \frac{i\pi}{2} \sum_{k=1}^n \operatorname{Res}(f(z) e^{i\omega z}, x_k)$$

where  $z_1, \dots, z_m$  are the singularities of  $f(z)$  in the upper half plane and  $x_1, \dots, x_n$  are the first order poles on the real axis.

If  $f(x)$  is an odd function, we note that  $f(x) \cos(\omega x)$  is an odd function to obtain the analogous result for Fourier sine integrals.

**Result 13.6.1 Fourier Cosine and Sine Integrals.** Let  $f(z)$  be analytic except for isolated singularities, with only first order poles on the real axis. Suppose that  $f(x)$  is an even function and that  $f(z)$  vanishes as  $|z| \rightarrow \infty$ . We consider real  $\omega > 0$ .

$$\int_0^{\infty} f(x) \cos(\omega x) dx = i\pi \sum_{k=1}^m \operatorname{Res}(f(z) e^{i\omega z}, z_k) + \frac{i\pi}{2} \sum_{k=1}^n \operatorname{Res}(f(z) e^{i\omega z}, x_k)$$

where  $z_1, \dots, z_m$  are the singularities of  $f(z)$  in the upper half plane and  $x_1, \dots, x_n$  are the first order poles on the real axis. If  $f(x)$  is an odd function then,

$$\int_0^{\infty} f(x) \sin(\omega x) dx = \pi \sum_{k=1}^{\mu} \operatorname{Res}(f(z) e^{i\omega z}, \zeta_k) + \frac{\pi}{2} \sum_{k=1}^n \operatorname{Res}(f(z) e^{i\omega z}, x_k)$$

where  $\zeta_1, \dots, \zeta_{\mu}$  are the singularities of  $f(z)$  in the lower half plane and  $x_1, \dots, x_n$  are the first order poles on the real axis.

Now suppose that  $f(x)$  is neither even nor odd. We can evaluate integrals of the form:

$$\int_{-\infty}^{\infty} f(x) \cos(\omega x) dx \quad \text{and} \quad \int_{-\infty}^{\infty} f(x) \sin(\omega x) dx$$

by writing them in terms of Fourier integrals

$$\begin{aligned} \int_{-\infty}^{\infty} f(x) \cos(\omega x) dx &= \frac{1}{2} \int_{-\infty}^{\infty} f(x) e^{i\omega x} dx + \frac{1}{2} \int_{-\infty}^{\infty} f(x) e^{-i\omega x} dx \\ \int_{-\infty}^{\infty} f(x) \sin(\omega x) dx &= -\frac{i}{2} \int_{-\infty}^{\infty} f(x) e^{i\omega x} dx + \frac{i}{2} \int_{-\infty}^{\infty} f(x) e^{-i\omega x} dx \end{aligned}$$

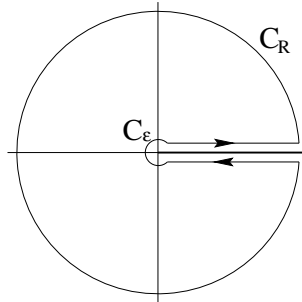

Figure 13.6:

## 13.7 Contour Integration and Branch Cuts

**Example 13.7.1** Consider

$$\int_0^{\infty} \frac{x^{-a}}{x+1} dx, \quad 0 < a < 1,$$

where  $x^{-a}$  denotes  $\exp(-a \ln(x))$ . We choose the branch of the function

$$f(z) = \frac{z^{-a}}{z+1} \quad |z| > 0, \quad 0 < \arg z < 2\pi$$

with a branch cut on the positive real axis.

Let  $C_\epsilon$  and  $C_R$  denote the circular arcs of radius  $\epsilon$  and  $R$  where  $\epsilon < 1 < R$ .  $C_\epsilon$  is negatively oriented;  $C_R$  is positively oriented. Consider the closed contour  $C$  that is traced by a point moving from  $C_\epsilon$  to  $C_R$  above the branch cut, next around  $C_R$ , then below the cut to  $C_\epsilon$ , and finally around  $C_\epsilon$ . (See Figure 13.6.)

We write  $f(z)$  in polar coordinates.

$$f(z) = \frac{\exp(-a \log z)}{z+1} = \frac{\exp(-a(\log r + i\theta))}{r e^{i\theta} + 1}$$

We evaluate the function above, ( $z = r e^{i0}$ ), and below, ( $z = r e^{i2\pi}$ ), the branch cut.

$$f(r e^{i0}) = \frac{\exp[-a(\log r + i0)]}{r + 1} = \frac{r^{-a}}{r + 1}$$

$$f(r e^{i2\pi}) = \frac{\exp[-a(\log r + i2\pi)]}{r + 1} = \frac{r^{-a} e^{-i2a\pi}}{r + 1}.$$

We use the residue theorem to evaluate the integral along  $C$ .

$$\oint_C f(z) dz = i2\pi \operatorname{Res}(f(z), -1)$$

$$\int_{\epsilon}^R \frac{r^{-a}}{r + 1} dr + \int_{C_R} f(z) dz - \int_{\epsilon}^R \frac{r^{-a} e^{-i2a\pi}}{r + 1} dr + \int_{C_{\epsilon}} f(z) dz = i2\pi \operatorname{Res}(f(z), -1)$$

The residue is

$$\operatorname{Res}(f(z), -1) = \exp(-a \log(-1)) = \exp(-a(\log 1 + i\pi)) = e^{-ia\pi}.$$

We bound the integrals along  $C_{\epsilon}$  and  $C_R$  with the maximum modulus integral bound.

$$\left| \int_{C_{\epsilon}} f(z) dz \right| \leq 2\pi\epsilon \frac{\epsilon^{-a}}{1 - \epsilon} = 2\pi \frac{\epsilon^{1-a}}{1 - \epsilon}$$

$$\left| \int_{C_R} f(z) dz \right| \leq 2\pi R \frac{R^{-a}}{R - 1} = 2\pi \frac{R^{1-a}}{R - 1}$$

Since  $0 < a < 1$ , the values of the integrals tend to zero as  $\epsilon \rightarrow 0$  and  $R \rightarrow \infty$ . Thus we have

$$\int_0^{\infty} \frac{r^{-a}}{r + 1} dr = i2\pi \frac{e^{-ia\pi}}{1 - e^{-i2a\pi}}$$

$$\int_0^{\infty} \frac{x^{-a}}{x + 1} dx = \frac{\pi}{\sin a\pi}$$

**Result 13.7.1 Integrals from Zero to Infinity.** Let  $f(z)$  be a single-valued analytic function with only isolated singularities and no singularities on the positive, real axis,  $[0, \infty)$ . Let  $a \notin \mathbb{Z}$ . If the integrals exist then,

$$\int_0^{\infty} f(x) dx = - \sum_{k=1}^n \operatorname{Res}(f(z) \log z, z_k),$$

$$\int_0^{\infty} x^a f(x) dx = \frac{i2\pi}{1 - e^{i2\pi a}} \sum_{k=1}^n \operatorname{Res}(z^a f(z), z_k),$$

$$\int_0^{\infty} f(x) \log x dx = -\frac{1}{2} \sum_{k=1}^n \operatorname{Res}(f(z) \log^2 z, z_k) + i\pi \sum_{k=1}^n \operatorname{Res}(f(z) \log z, z_k),$$

$$\begin{aligned} \int_0^{\infty} x^a f(x) \log x dx &= \frac{i2\pi}{1 - e^{i2\pi a}} \sum_{k=1}^n \operatorname{Res}(z^a f(z) \log z, z_k) \\ &\quad + \frac{\pi^2 a}{\sin^2(\pi a)} \sum_{k=1}^n \operatorname{Res}(z^a f(z), z_k), \end{aligned}$$

$$\int_0^{\infty} x^a f(x) \log^m x dx = \frac{\partial^m}{\partial a^m} \left( \frac{i2\pi}{1 - e^{i2\pi a}} \sum_{k=1}^n \operatorname{Res}(z^a f(z), z_k) \right),$$

where  $z_1, \dots, z_n$  are the singularities of  $f(z)$  and there is a branch cut on the positive real axis with  $0 < \arg(z) < 2\pi$ .

## 13.8 Exploiting Symmetry

We have already used symmetry of the integrand to evaluate certain integrals. For  $f(x)$  an even function we were able to evaluate  $\int_0^\infty f(x) dx$  by extending the range of integration from  $-\infty$  to  $\infty$ . For

$$\int_0^\infty x^\alpha f(x) dx$$

we put a branch cut on the positive real axis and noted that the value of the integrand below the branch cut is a constant multiple of the value of the function above the branch cut. This enabled us to evaluate the real integral with contour integration. In this section we will use other kinds of symmetry to evaluate integrals. We will discover that periodicity of the integrand will produce this symmetry.

### 13.8.1 Wedge Contours

We note that  $z^n = r^n e^{in\theta}$  is periodic in  $\theta$  with period  $2\pi/n$ . The real and imaginary parts of  $z^n$  are odd periodic in  $\theta$  with period  $\pi/n$ . This observation suggests that certain integrals on the positive real axis may be evaluated by closing the path of integration with a wedge contour.

**Example 13.8.1** Consider

$$\int_0^\infty \frac{1}{1+x^n} dx$$

where  $n \in \mathbb{N}$ ,  $n \geq 2$ . We can evaluate this integral using Result 13.7.1.

$$\begin{aligned}
 \int_0^\infty \frac{1}{1+x^n} dx &= - \sum_{k=0}^{n-1} \operatorname{Res} \left( \frac{\log z}{1+z^n}, e^{i\pi(1+2k)/n} \right) \\
 &= - \sum_{k=0}^{n-1} \lim_{z \rightarrow e^{i\pi(1+2k)/n}} \left( \frac{(z - e^{i\pi(1+2k)/n}) \log z}{1+z^n} \right) \\
 &= - \sum_{k=0}^{n-1} \lim_{z \rightarrow e^{i\pi(1+2k)/n}} \left( \frac{\log z + (z - e^{i\pi(1+2k)/n})/z}{nz^{n-1}} \right) \\
 &= - \sum_{k=0}^{n-1} \left( \frac{i\pi(1+2k)/n}{n e^{i\pi(1+2k)(n-1)/n}} \right) \\
 &= - \frac{i\pi}{n^2 e^{i\pi(n-1)/n}} \sum_{k=0}^{n-1} (1+2k) e^{i2\pi k/n} \\
 &= \frac{i2\pi e^{i\pi/n}}{n^2} \sum_{k=1}^{n-1} k e^{i2\pi k/n} \\
 &= \frac{i2\pi e^{i\pi/n}}{n^2} \frac{n}{e^{i2\pi/n} - 1} \\
 &= \frac{\pi}{n \sin(\pi/n)}
 \end{aligned}$$

This is a bit grungy. To find a spiffier way to evaluate the integral we note that if we write the integrand as a function of  $r$  and  $\theta$ , it is periodic in  $\theta$  with period  $2\pi/n$ .

$$\frac{1}{1+z^n} = \frac{1}{1+r^n e^{in\theta}}$$

The integrand along the rays  $\theta = 2\pi/n, 4\pi/n, 6\pi/n, \dots$  has the same value as the integrand on the real axis. Consider the contour  $C$  that is the boundary of the wedge  $0 < r < R$ ,  $0 < \theta < 2\pi/n$ . There is one singularity inside the



contour. We evaluate the residue there.

$$\begin{aligned}\operatorname{Res}\left(\frac{1}{1+z^n}, e^{i\pi/n}\right) &= \lim_{z \rightarrow e^{i\pi/n}} \frac{z - e^{i\pi/n}}{1+z^n} \\ &= \lim_{z \rightarrow e^{i\pi/n}} \frac{1}{nz^{n-1}} \\ &= -\frac{e^{i\pi/n}}{n}\end{aligned}$$

We evaluate the integral along  $C$  with the residue theorem.

$$\int_C \frac{1}{1+z^n} dz = \frac{-i2\pi e^{i\pi/n}}{n}$$

Let  $C_R$  be the circular arc. The integral along  $C_R$  vanishes as  $R \rightarrow \infty$ .

$$\begin{aligned}\left|\int_{C_R} \frac{1}{1+z^n} dz\right| &\leq \frac{2\pi R}{n} \max_{z \in C_R} \left|\frac{1}{1+z^n}\right| \\ &\leq \frac{2\pi R}{n} \frac{1}{R^n - 1} \\ &\rightarrow 0 \text{ as } R \rightarrow \infty\end{aligned}$$

We parametrize the contour to evaluate the desired integral.

$$\begin{aligned}\int_0^\infty \frac{1}{1+x^n} dx + \int_\infty^0 \frac{1}{1+x^n} e^{i2\pi/n} dx &= \frac{-i2\pi e^{i\pi/n}}{n} \\ \int_0^\infty \frac{1}{1+x^n} dx &= \frac{-i2\pi e^{i\pi/n}}{n(1 - e^{i2\pi/n})}\end{aligned}$$

$$\int_0^\infty \frac{1}{1+x^n} dx = \frac{\pi}{n \sin(\pi/n)}$$

## 13.8.2 Box Contours

Recall that  $e^z = e^{x+iy}$  is periodic in  $y$  with period  $2\pi$ . This implies that the hyperbolic trigonometric functions  $\cosh z$ ,  $\sinh z$  and  $\tanh z$  are periodic in  $y$  with period  $2\pi$  and odd periodic in  $y$  with period  $\pi$ . We can exploit this property to evaluate certain integrals on the real axis by closing the path of integration with a box contour.

**Example 13.8.2** Consider the integral

$$\begin{aligned}\int_{-\infty}^{\infty} \frac{1}{\cosh x} dx &= \left[ i \log \left( \tanh \left( \frac{i\pi}{4} + \frac{x}{2} \right) \right) \right]_{-\infty}^{\infty} \\ &= i \log(1) - i \log(-1) \\ &= \pi.\end{aligned}$$

We will evaluate this integral using contour integration. Note that

$$\cosh(x + i\pi) = \frac{e^{x+i\pi} + e^{-x-i\pi}}{2} = -\cosh(x).$$

Consider the box contour  $C$  that is the boundary of the region  $-R < x < R$ ,  $0 < y < \pi$ . The only singularity of the integrand inside the contour is a first order pole at  $z = i\pi/2$ . We evaluate the integral along  $C$  with the residue theorem.

$$\begin{aligned}\oint_C \frac{1}{\cosh z} dz &= i2\pi \operatorname{Res} \left( \frac{1}{\cosh z}, \frac{i\pi}{2} \right) \\ &= i2\pi \lim_{z \rightarrow i\pi/2} \frac{z - i\pi/2}{\cosh z} \\ &= i2\pi \lim_{z \rightarrow i\pi/2} \frac{1}{\sinh z} \\ &= 2\pi\end{aligned}$$

The integrals along the sides of the box vanish as  $R \rightarrow \infty$ .

$$\begin{aligned} \left| \int_{\pm R}^{\pm R+i\pi} \frac{1}{\cosh z} dz \right| &\leq \pi \max_{z \in [\pm R \dots \pm R+i\pi]} \left| \frac{1}{\cosh z} \right| \\ &\leq \pi \max_{y \in [0 \dots \pi]} \left| \frac{2}{e^{\pm R+iy} + e^{\mp R-iy}} \right| \\ &= \frac{2}{e^R - e^{-R}} \\ &\leq \frac{\pi}{\sinh R} \\ &\rightarrow 0 \text{ as } R \rightarrow \infty \end{aligned}$$

The value of the integrand on the top of the box is the negative of its value on the bottom. We take the limit as  $R \rightarrow \infty$ .

$$\int_{-\infty}^{\infty} \frac{1}{\cosh x} dx + \int_{\infty}^{-\infty} \frac{1}{-\cosh x} dx = 2\pi$$

$$\int_{-\infty}^{\infty} \frac{1}{\cosh x} dx = \pi$$

## 13.9 Definite Integrals Involving Sine and Cosine

**Example 13.9.1** For real-valued  $a$ , evaluate the integral:

$$f(a) = \int_0^{2\pi} \frac{d\theta}{1 + a \sin \theta}.$$

What is the value of the integral for complex-valued  $a$ .

**Real-Valued  $a$ .** For  $-1 < a < 1$ , the integrand is bounded, hence the integral exists. For  $|a| = 1$ , the integrand has a second order pole on the path of integration. For  $|a| > 1$  the integrand has two first order poles on the path of integration. The integral is divergent for these two cases. Thus we see that the integral exists for  $-1 < a < 1$ .

For  $a = 0$ , the value of the integral is  $2\pi$ . Now consider  $a \neq 0$ . We make the change of variables  $z = e^{i\theta}$ . The real integral from  $\theta = 0$  to  $\theta = 2\pi$  becomes a contour integral along the unit circle,  $|z| = 1$ . We write the sine, cosine and the differential in terms of  $z$ .

$$\sin \theta = \frac{z - z^{-1}}{i2}, \quad \cos \theta = \frac{z + z^{-1}}{2}, \quad dz = i e^{i\theta} d\theta, \quad d\theta = \frac{dz}{iz}$$

We write  $f(a)$  as an integral along  $C$ , the positively oriented unit circle  $|z| = 1$ .

$$f(a) = \oint_C \frac{1/(iz)}{1 + a(z - z^{-1})/(2i)} dz = \oint_C \frac{2/a}{z^2 + (i2/a)z - 1} dz$$

We factor the denominator of the integrand.

$$f(a) = \oint_C \frac{2/a}{(z - z_1)(z - z_2)} dz$$

$$z_1 = i \left( \frac{-1 + \sqrt{1 - a^2}}{a} \right), \quad z_2 = i \left( \frac{-1 - \sqrt{1 - a^2}}{a} \right)$$

Because  $|a| < 1$ , the second root is outside the unit circle.

$$|z_2| = \frac{1 + \sqrt{1 - a^2}}{|a|} > 1.$$

Since  $|z_1 z_2| = 1$ ,  $|z_1| < 1$ . Thus the pole at  $z_1$  is inside the contour and the pole at  $z_2$  is outside. We evaluate the contour integral with the residue theorem.

$$f(a) = \oint_C \frac{2/a}{z^2 + (i2/a)z - 1} dz$$

$$= i2\pi \frac{2/a}{z_1 - z_2}$$

$$= i2\pi \frac{1}{i\sqrt{1 - a^2}}$$

$$f(a) = \frac{2\pi}{\sqrt{1-a^2}}$$

**Complex-Valued  $a$ .** We note that the integral converges except for real-valued  $a$  satisfying  $|a| \geq 1$ . On any closed subset of  $\mathbb{C} \setminus \{a \in \mathbb{R} \mid |a| \geq 1\}$  the integral is uniformly convergent. Thus except for the values  $\{a \in \mathbb{R} \mid |a| \geq 1\}$ , we can differentiate the integral with respect to  $a$ .  $f(a)$  is analytic in the complex plane except for the set of points on the real axis:  $a \in (-\infty \dots -1]$  and  $a \in [1 \dots \infty)$ . The value of the analytic function  $f(a)$  on the real axis for the interval  $(-1 \dots 1)$  is

$$f(a) = \frac{2\pi}{\sqrt{1-a^2}}.$$

By analytic continuation we see that the value of  $f(a)$  in the complex plane is the branch of the function

$$f(a) = \frac{2\pi}{(1-a^2)^{1/2}}$$

where  $f(a)$  is positive, real-valued for  $a \in (-1 \dots 1)$  and there are branch cuts on the real axis on the intervals:  $(-\infty \dots -1]$  and  $[1 \dots \infty)$ .

**Result 13.9.1** For evaluating integrals of the form

$$\int_a^{a+2\pi} F(\sin \theta, \cos \theta) d\theta$$

it may be useful to make the change of variables  $z = e^{i\theta}$ . This gives us a contour integral along the unit circle about the origin. We can write the sine, cosine and differential in terms of  $z$ .

$$\sin \theta = \frac{z - z^{-1}}{i2}, \quad \cos \theta = \frac{z + z^{-1}}{2}, \quad d\theta = \frac{dz}{iz}$$

## 13.10 Infinite Sums

The function  $g(z) = \pi \cot(\pi z)$  has simple poles at  $z = n \in \mathbb{Z}$ . The residues at these points are all unity.

$$\begin{aligned} \operatorname{Res}(\pi \cot(\pi z), n) &= \lim_{z \rightarrow n} \frac{\pi(z-n) \cos(\pi z)}{\sin(\pi z)} \\ &= \lim_{z \rightarrow n} \frac{\pi \cos(\pi z) - \pi(z-n) \sin(\pi z)}{\pi \cos(\pi z)} \\ &= 1 \end{aligned}$$

Let  $C_n$  be the square contour with corners at  $z = (n + 1/2)(\pm 1 \pm i)$ . Recall that

$$\cos z = \cos x \cosh y - i \sin x \sinh y \quad \text{and} \quad \sin z = \sin x \cosh y + i \cos x \sinh y.$$

First we bound the modulus of  $\cot(z)$ .

$$\begin{aligned} |\cot(z)| &= \left| \frac{\cos x \cosh y - i \sin x \sinh y}{\sin x \cosh y + i \cos x \sinh y} \right| \\ &= \sqrt{\frac{\cos^2 x \cosh^2 y + \sin^2 x \sinh^2 y}{\sin^2 x \cosh^2 y + \cos^2 x \sinh^2 y}} \\ &\leq \sqrt{\frac{\cosh^2 y}{\sinh^2 y}} \\ &= |\coth(y)| \end{aligned}$$

The hyperbolic cotangent,  $\coth(y)$ , has a simple pole at  $y = 0$  and tends to  $\pm 1$  as  $y \rightarrow \pm\infty$ .

Along the top and bottom of  $C_n$ , ( $z = x \pm i(n + 1/2)$ ), we bound the modulus of  $g(z) = \pi \cot(\pi z)$ .

$$|\pi \cot(\pi z)| \leq \pi |\coth(\pi(n + 1/2))|$$

Along the left and right sides of  $C_n$ , ( $z = \pm(n + 1/2) + iy$ ), the modulus of the function is bounded by a constant.

$$\begin{aligned} |g(\pm(n + 1/2) + iy)| &= \left| \pi \frac{\cos(\pi(n + 1/2)) \cosh(\pi y) \mp i \sin(\pi(n + 1/2)) \sinh(\pi y)}{\sin(\pi(n + 1/2)) \cosh(\pi y) + i \cos(\pi(n + 1/2)) \sinh(\pi y)} \right| \\ &= |\mp i \pi \tanh(\pi y)| \\ &\leq \pi \end{aligned}$$

Thus the modulus of  $\pi \cot(\pi z)$  can be bounded by a constant  $M$  on  $C_n$ .

Let  $f(z)$  be analytic except for isolated singularities. Consider the integral,

$$\oint_{C_n} \pi \cot(\pi z) f(z) dz.$$

We use the maximum modulus integral bound.

$$\left| \oint_{C_n} \pi \cot(\pi z) f(z) dz \right| \leq (8n + 4)M \max_{z \in C_n} |f(z)|$$

Note that if

$$\lim_{|z| \rightarrow \infty} |zf(z)| = 0,$$

then

$$\lim_{n \rightarrow \infty} \oint_{C_n} \pi \cot(\pi z) f(z) dz = 0.$$

This implies that the sum of all residues of  $\pi \cot(\pi z) f(z)$  is zero. Suppose further that  $f(z)$  is analytic at  $z = n \in \mathbb{Z}$ . The residues of  $\pi \cot(\pi z) f(z)$  at  $z = n$  are  $f(n)$ . This means

$$\sum_{n=-\infty}^{\infty} f(n) = -(\text{sum of the residues of } \pi \cot(\pi z) f(z) \text{ at the poles of } f(z)).$$

**Result 13.10.1** If

$$\lim_{|z| \rightarrow \infty} |zf(z)| = 0,$$

then the sum of all the residues of  $\pi \cot(\pi z)f(z)$  is zero. If in addition  $f(z)$  is analytic at  $z = n \in \mathbb{Z}$  then

$$\sum_{n=-\infty}^{\infty} f(n) = -(\text{sum of the residues of } \pi \cot(\pi z)f(z) \text{ at the poles of } f(z)).$$

**Example 13.10.1** Consider the sum

$$\sum_{n=-\infty}^{\infty} \frac{1}{(n+a)^2}, \quad a \notin \mathbb{Z}.$$

By Result 13.10.1 with  $f(z) = 1/(z+a)^2$  we have

$$\begin{aligned} \sum_{n=-\infty}^{\infty} \frac{1}{(n+a)^2} &= -\operatorname{Res} \left( \pi \cot(\pi z) \frac{1}{(z+a)^2}, -a \right) \\ &= -\pi \lim_{z \rightarrow -a} \frac{d}{dz} \cot(\pi z) \\ &= -\pi \frac{-\pi \sin^2(\pi z) - \pi \cos^2(\pi z)}{\sin^2(\pi z)}. \end{aligned}$$

$$\boxed{\sum_{n=-\infty}^{\infty} \frac{1}{(n+a)^2} = \frac{\pi^2}{\sin^2(\pi a)}}$$

**Example 13.10.2** Derive  $\pi/4 = 1 - 1/3 + 1/5 - 1/7 + 1/9 - \dots$ .



Consider the integral

$$I_n = \frac{1}{i2\pi} \int_{C_n} \frac{dw}{w(w-z)\sin w}$$

where  $C_n$  is the square with corners at  $w = (n + 1/2)(\pm 1 \pm i)\pi$ ,  $n \in \mathbb{Z}^+$ . With the substitution  $w = x + iy$ ,

$$|\sin w|^2 = \sin^2 x + \sinh^2 y,$$

we see that  $|1/\sin w| \leq 1$  on  $C_n$ . Thus  $I_n \rightarrow 0$  as  $n \rightarrow \infty$ . We use the residue theorem and take the limit  $n \rightarrow \infty$ .

$$0 = \sum_{n=1}^{\infty} \left[ \frac{(-1)^n}{n\pi(n\pi - z)} + \frac{(-1)^n}{n\pi(n\pi + z)} \right] + \frac{1}{z \sin z} - \frac{1}{z^2}$$

$$\begin{aligned} \frac{1}{\sin z} &= \frac{1}{z} - 2z \sum_{n=1}^{\infty} \frac{(-1)^n}{n^2\pi^2 - z^2} \\ &= \frac{1}{z} - \sum_{n=1}^{\infty} \left[ \frac{(-1)^n}{n\pi - z} - \frac{(-1)^n}{n\pi + z} \right] \end{aligned}$$

We substitute  $z = \pi/2$  into the above expression to obtain

$$\pi/4 = 1 - 1/3 + 1/5 - 1/7 + 1/9 - \dots$$

## 13.11 Exercises

### The Residue Theorem

#### Exercise 13.1

Evaluate the following closed contour integrals using Cauchy's residue theorem.

1.  $\int_C \frac{dz}{z^2 - 1}$ , where  $C$  is the contour parameterized by  $r = 2 \cos(2\theta)$ ,  $0 \leq \theta \leq 2\pi$ .

2.  $\int_C \frac{e^{zz}}{z^2(z-2)(z+i5)} dz$ , where  $C$  is the positive circle  $|z| = 3$ .

3.  $\int_C e^{1/z} \sin(1/z) dz$ , where  $C$  is the positive circle  $|z| = 1$ .

**Hint, Solution**

#### Exercise 13.2

Derive Cauchy's integral formula from Cauchy's residue theorem.

**Hint, Solution**

#### Exercise 13.3

Calculate the residues of the following functions at each of the poles in the finite part of the plane.

1.  $\frac{1}{z^4 - a^4}$

2.  $\frac{\sin z}{z^2}$

3.  $\frac{1 + z^2}{z(z-1)^2}$

4.  $\frac{e^z}{z^2 + a^2}$

$$5. \frac{(1 - \cos z)^2}{z^7}$$

Hint, Solution

### Exercise 13.4

Let  $f(z)$  have a pole of order  $n$  at  $z = z_0$ . Prove the Residue Formula:

$$\text{Res}(f(z), z_0) = \lim_{z \rightarrow z_0} \left( \frac{1}{(n-1)!} \frac{d^{n-1}}{dz^{n-1}} [(z - z_0)^n f(z)] \right).$$

Hint, Solution

### Exercise 13.5

Consider the function

$$f(z) = \frac{z^4}{z^2 + 1}.$$

Classify the singularities of  $f(z)$  in the extended complex plane. Calculate the residue at each pole and at infinity. Find the Laurent series expansions and their domains of convergence about the points  $z = 0$ ,  $z = i$  and  $z = \infty$ .

Hint, Solution

### Exercise 13.6

Let  $P(z)$  be a polynomial none of whose roots lie on the closed contour  $\Gamma$ . Show that

$$\frac{1}{i2\pi} \int_{\Gamma} \frac{P'(z)}{P(z)} dz = \text{number of roots of } P(z) \text{ which lie inside } \Gamma.$$

where the roots are counted according to their multiplicity.

*Hint: From the fundamental theorem of algebra, it is always possible to factor  $P(z)$  in the form  $P(z) = (z - z_1)(z - z_2) \cdots (z - z_n)$ . Using this form of  $P(z)$  the integrand  $P'(z)/P(z)$  reduces to a very simple expression.*

Hint, Solution

### Exercise 13.7

Find the value of

$$\oint_C \frac{e^z}{(z - \pi) \tan z} dz$$

where  $C$  is the positively-oriented circle

1.  $|z| = 2$
2.  $|z| = 4$

Hint, Solution

## Cauchy Principal Value for Real Integrals

### Solution 13.1

Show that the integral

$$\int_{-1}^1 \frac{1}{x} dx.$$

is divergent. Evaluate the integral

$$\int_{-1}^1 \frac{1}{x - i\alpha} dx, \quad \alpha \in \mathbb{R}, \alpha \neq 0.$$

Evaluate

$$\lim_{\alpha \rightarrow 0^+} \int_{-1}^1 \frac{1}{x - i\alpha} dx$$

and

$$\lim_{\alpha \rightarrow 0^-} \int_{-1}^1 \frac{1}{x - i\alpha} dx.$$

The integral exists for  $\alpha$  arbitrarily close to zero, but diverges when  $\alpha = 0$ . Plot the real and imaginary part of the integrand. If one were to assign meaning to the integral for  $\alpha = 0$ , what would the value of the integral be?

### Exercise 13.8

Do the principal values of the following integrals exist?

1.  $\int_{-1}^1 \frac{1}{x^2} dx$ ,
2.  $\int_{-1}^1 \frac{1}{x^3} dx$ ,
3.  $\int_{-1}^1 \frac{f(x)}{x^3} dx$ .

Assume that  $f(x)$  is real analytic on the interval  $(-1, 1)$ .

**Hint, Solution**

## Cauchy Principal Value for Contour Integrals

### Exercise 13.9

Let  $f(z)$  have a first order pole at  $z = z_0$  and let  $(z - z_0)f(z)$  be analytic in some neighborhood of  $z_0$ . Let the contour  $C_\epsilon$  be a circular arc from  $z_0 + \epsilon e^{i\alpha}$  to  $z_0 + \epsilon e^{i\beta}$ . (Assume that  $\beta > \alpha$  and  $\beta - \alpha < 2\pi$ .) Show that

$$\lim_{\epsilon \rightarrow 0^+} \int_{C_\epsilon} f(z) dz = i(\beta - \alpha) \operatorname{Res}(f(z), z_0)$$

**Hint, Solution**

### Exercise 13.10

Let  $f(z)$  be analytic inside and on a simple, closed, positive contour  $C$ , except for isolated singularities at  $z_1, \dots, z_m$  inside the contour and first order poles at  $\zeta_1, \dots, \zeta_n$  on the contour. Further, let the contour be  $C^1$  at the locations of these first order poles. (i.e., the contour does not have a corner at any of the first order poles.) Show that the principal value of the integral of  $f(z)$  along  $C$  is

$$\oint_C f(z) dz = i2\pi \sum_{j=1}^m \operatorname{Res}(f(z), z_j) + i\pi \sum_{j=1}^n \operatorname{Res}(f(z), \zeta_j).$$

**Hint, Solution**

### Exercise 13.11

Let  $C$  be the unit circle. Evaluate

$$\oint_C \frac{1}{z-1} dz$$

by indenting the contour to exclude the first order pole at  $z = 1$ .

[Hint](#), [Solution](#)

## Integrals on the Real Axis

### Exercise 13.12

Evaluate the following improper integrals.

$$1. \int_0^{\infty} \frac{x^2}{(x^2+1)(x^2+4)} dx = \frac{\pi}{6}$$

$$2. \int_{-\infty}^{\infty} \frac{dx}{(x+b)^2+a^2}, \quad a > 0$$

[Hint](#), [Solution](#)

### Exercise 13.13

Prove Result [13.4.1](#).

[Hint](#), [Solution](#)

### Exercise 13.14

Evaluate

$$\int_{-\infty}^{\infty} \frac{2x}{x^2+x+1} dx.$$

[Hint](#), [Solution](#)

### Exercise 13.15

Use contour integration to evaluate the integrals

1.  $\int_{-\infty}^{\infty} \frac{dx}{1+x^4},$
2.  $\int_{-\infty}^{\infty} \frac{x^2 dx}{(1+x^2)^2},$
3.  $\int_{-\infty}^{\infty} \frac{\cos(x)}{1+x^2} dx.$

Hint, Solution

### Exercise 13.16

Evaluate by contour integration

$$\int_0^{\infty} \frac{x^6}{(x^4+1)^2} dx.$$

Hint, Solution

## Fourier Integrals

### Exercise 13.17

Suppose that  $f(z)$  vanishes as  $|z| \rightarrow \infty$ . If  $\omega$  is a (positive / negative) real number and  $C_R$  is a semi-circle of radius  $R$  in the (upper / lower) half plane then show that the integral

$$\int_{C_R} f(z) e^{i\omega z} dz$$

vanishes as  $R \rightarrow \infty$ .

Hint, Solution

### Exercise 13.18

Evaluate by contour integration

$$\int_{-\infty}^{\infty} \frac{\cos 2x}{x - i\pi} dx.$$

Hint, Solution

## Fourier Cosine and Sine Integrals

### Exercise 13.19

Evaluate

$$\int_{-\infty}^{\infty} \frac{\sin x}{x} dx.$$

Hint, Solution

### Exercise 13.20

Evaluate

$$\int_{-\infty}^{\infty} \frac{1 - \cos x}{x^2} dx.$$

Hint, Solution

### Exercise 13.21

Evaluate

$$\int_0^{\infty} \frac{\sin(\pi x)}{x(1-x^2)} dx.$$

Hint, Solution

## Contour Integration and Branch Cuts

### Exercise 13.22

Evaluate the following integrals.

$$1. \int_0^{\infty} \frac{\ln^2 x}{1+x^2} dx = \frac{\pi^3}{8}$$

$$2. \int_0^{\infty} \frac{\ln x}{1+x^2} dx = 0$$



Hint, Solution

### Exercise 13.23

By methods of contour integration find

$$\int_0^{\infty} \frac{dx}{x^2 + 5x + 6}$$

[ Recall the trick of considering  $\int_{\Gamma} f(z) \log z \, dz$  with a suitably chosen contour  $\Gamma$  and branch for  $\log z$ . ]

Hint, Solution

### Exercise 13.24

Show that

$$\int_0^{\infty} \frac{x^a}{(x+1)^2} dx = \frac{\pi a}{\sin(\pi a)} \quad \text{for } -1 < \Re(a) < 1.$$

From this derive that

$$\int_0^{\infty} \frac{\log x}{(x+1)^2} dx = 0, \quad \int_0^{\infty} \frac{\log^2 x}{(x+1)^2} dx = \frac{\pi^2}{3}.$$

Hint, Solution

### Exercise 13.25

Consider the integral

$$I(a) = \int_0^{\infty} \frac{x^a}{1+x^2} dx.$$

1. For what values of  $a$  does the integral exist?
2. Evaluate the integral. Show that

$$I(a) = \frac{\pi}{2 \cos(\pi a/2)}$$

3. Deduce from your answer in part (b) the results

$$\int_0^{\infty} \frac{\log x}{1+x^2} dx = 0, \quad \int_0^{\infty} \frac{\log^2 x}{1+x^2} dx = \frac{\pi^3}{8}.$$

You may assume that it is valid to differentiate under the integral sign.

**Hint, Solution**

### Exercise 13.26

Let  $f(z)$  be a single-valued analytic function with only isolated singularities and no singularities on the positive real axis,  $[0, \infty)$ . Give sufficient conditions on  $f(x)$  for absolute convergence of the integral

$$\int_0^{\infty} x^a f(x) dx.$$

Assume that  $a$  is not an integer. Evaluate the integral by considering the integral of  $z^a f(z)$  on a suitable contour. (Consider the branch of  $z^a$  on which  $1^a = 1$ .)

**Hint, Solution**

### Exercise 13.27

Using the solution to Exercise 13.26, evaluate

$$\int_0^{\infty} x^a f(x) \log x dx,$$

and

$$\int_0^{\infty} x^a f(x) \log^m x dx,$$

where  $m$  is a positive integer.

**Hint, Solution**

### Exercise 13.28

Using the solution to Exercise 13.26, evaluate

$$\int_0^{\infty} f(x) dx,$$

i.e. examine  $a = 0$ . The solution will suggest a way to evaluate the integral with contour integration. Do the contour integration to corroborate the value of  $\int_0^{\infty} f(x) dx$ .

**Hint, Solution**

### Exercise 13.29

Let  $f(z)$  be an analytic function with only isolated singularities and no singularities on the positive real axis,  $[0, \infty)$ . Give sufficient conditions on  $f(x)$  for absolute convergence of the integral

$$\int_0^{\infty} f(x) \log x \, dx$$

Evaluate the integral with contour integration.

**Hint, Solution**

### Exercise 13.30

For what values of  $a$  does the following integral exist?

$$\int_0^{\infty} \frac{x^a}{1+x^4} \, dx.$$

Evaluate the integral. (Consider the branch of  $x^a$  on which  $1^a = 1$ .)

**Hint, Solution**

### Exercise 13.31

By considering the integral of  $f(z) = z^{1/2} \log z / (z+1)^2$  on a suitable contour, show that

$$\int_0^{\infty} \frac{x^{1/2} \log x}{(x+1)^2} \, dx = \pi, \quad \int_0^{\infty} \frac{x^{1/2}}{(x+1)^2} \, dx = \frac{\pi}{2}.$$

**Hint, Solution**

## Exploiting Symmetry

### Exercise 13.32

Evaluate by contour integration, the principal value integral

$$I(a) = \int_{-\infty}^{\infty} \frac{e^{ax}}{e^x - e^{-x}} \, dx$$

for  $a$  real and  $|a| < 1$ . [Hint: Consider the contour that is the boundary of the box,  $-R < x < R$ ,  $0 < y < \pi$ , but indented around  $z = 0$  and  $z = i\pi$ .

Hint, Solution

### Exercise 13.33

Evaluate the following integrals.

1.  $\int_0^{\infty} \frac{dx}{(1+x^2)^2}$ ,

2.  $\int_0^{\infty} \frac{dx}{1+x^3}$ .

Hint, Solution

### Exercise 13.34

Find the value of the integral  $I$

$$I = \int_0^{\infty} \frac{dx}{1+x^6}$$

by considering the contour integral

$$\int_{\Gamma} \frac{dz}{1+z^6}$$

with an appropriately chosen contour  $\Gamma$ .

Hint, Solution

### Exercise 13.35

Let  $C$  be the boundary of the sector  $0 < r < R$ ,  $0 < \theta < \pi/4$ . By integrating  $e^{-z^2}$  on  $C$  and letting  $R \rightarrow \infty$  show that

$$\int_0^{\infty} \cos(x^2) dx = \int_0^{\infty} \sin(x^2) dx = \frac{1}{\sqrt{2}} \int_0^{\infty} e^{-x^2} dx.$$

Hint, Solution

**Exercise 13.36**

Evaluate

$$\int_{-\infty}^{\infty} \frac{x}{\sinh x} dx$$

using contour integration.

**Hint, Solution****Exercise 13.37**

Show that

$$\int_{-\infty}^{\infty} \frac{e^{ax}}{e^x + 1} dx = \frac{\pi}{\sin(\pi a)} \quad \text{for } 0 < a < 1.$$

Use this to derive that

$$\int_{-\infty}^{\infty} \frac{\cosh(bx)}{\cosh x} dx = \frac{\pi}{\cos(\pi b/2)} \quad \text{for } -1 < b < 1.$$

**Hint, Solution****Exercise 13.38**Using techniques of contour integration find for real  $a$  and  $b$ :

$$F(a, b) = \int_0^{\pi} \frac{d\theta}{(a + b \cos \theta)^2}$$

What are the restrictions on  $a$  and  $b$  if any? Can the result be applied for complex  $a$ ,  $b$ ? How?**Hint, Solution****Exercise 13.39**

Show that

$$\int_{-\infty}^{\infty} \frac{\cos x}{e^x + e^{-x}} dx = \frac{\pi}{e^{\pi/2} + e^{-\pi/2}}$$

[ Hint: Begin by considering the integral of  $e^{iz} / (e^z + e^{-z})$  around a rectangle with vertices:  $\pm R$ ,  $\pm R + i\pi$ .]**Hint, Solution**

## Definite Integrals Involving Sine and Cosine

### Exercise 13.40

Evaluate the following real integrals.

$$1. \int_{-\pi}^{\pi} \frac{d\theta}{1 + \sin^2 \theta} = \sqrt{2}\pi$$

$$2. \int_0^{\pi/2} \sin^4 \theta \, d\theta$$

Hint, Solution

### Exercise 13.41

Use contour integration to evaluate the integrals

$$1. \int_0^{2\pi} \frac{d\theta}{2 + \sin(\theta)},$$

$$2. \int_{-\pi}^{\pi} \frac{\cos(n\theta)}{1 - 2a \cos(\theta) + a^2} \, d\theta \quad \text{for } |a| < 1, \, n \in \mathbb{Z}^{0+}.$$

Hint, Solution

### Exercise 13.42

By integration around the unit circle, suitably indented, show that

$$\int_0^{\pi} \frac{\cos(n\theta)}{\cos \theta - \cos \alpha} \, d\theta = \pi \frac{\sin(n\alpha)}{\sin \alpha}.$$

Hint, Solution

### Exercise 13.43

Evaluate

$$\int_0^1 \frac{x^2}{(1+x^2)\sqrt{1-x^2}} dx.$$

Hint, Solution

## Infinite Sums

### Exercise 13.44

Evaluate

$$\sum_{n=1}^{\infty} \frac{1}{n^4}.$$

Hint, Solution

### Exercise 13.45

Sum the following series using contour integration:

$$\sum_{n=-\infty}^{\infty} \frac{1}{n^2 - \alpha^2}$$

Hint, Solution

## 13.12 Hints

### The Residue Theorem

**Hint 13.1**

**Hint 13.2**

**Hint 13.3**

**Hint 13.4**

Substitute the Laurent series into the formula and simplify.

**Hint 13.5**

Use that the sum of all residues of the function in the extended complex plane is zero in calculating the residue at infinity. To obtain the Laurent series expansion about  $z = i$ , write the function as a proper rational function, (numerator has a lower degree than the denominator) and expand in partial fractions.

**Hint 13.6**

**Hint 13.7**

### Cauchy Principal Value for Real Integrals

**Hint 13.8**



**Hint 13.9**

For the third part, does the integrand have a term that behaves like  $1/x^2$ ?

**Cauchy Principal Value for Contour Integrals****Hint 13.10**

Expand  $f(z)$  in a Laurent series. Only the first term will make a contribution to the integral in the limit as  $\epsilon \rightarrow 0^+$ .

**Hint 13.11**

Use the result of Exercise 13.9.

**Hint 13.12**

Look at Example 13.3.2.

**Integrals on the Real Axis****Hint 13.13****Hint 13.14**

Close the path of integration in the upper or lower half plane with a semi-circle. Use the maximum modulus integral bound, (Result 10.2.1), to show that the integral along the semi-circle vanishes.

**Hint 13.15**

Make the change of variables  $x = 1/\xi$ .

**Hint 13.16**

Use Result 13.4.1.

**Hint 13.17**

## Fourier Integrals

### Hint 13.18

Use

$$\int_0^\pi e^{-R \sin \theta} d\theta < \frac{\pi}{R}.$$

### Hint 13.19

## Fourier Cosine and Sine Integrals

### Hint 13.20

Consider the integral of  $\frac{e^{ix}}{ix}$ .

### Hint 13.21

Show that

$$\int_{-\infty}^{\infty} \frac{1 - \cos x}{x^2} dx = \int_{-\infty}^{\infty} \frac{1 - e^{ix}}{x^2} dx.$$

### Hint 13.22

Show that

$$\int_0^\infty \frac{\sin(\pi x)}{x(1-x^2)} dx = -\frac{i}{2} \int_{-\infty}^{\infty} \frac{e^{ix}}{x(1-x^2)} dx.$$

## Contour Integration and Branch Cuts

### Hint 13.23

Integrate a branch of  $\log^2 z / (1 + z^2)$  along the boundary of the domain  $\epsilon < r < R$ ,  $0 < \theta < \pi$ .

### Hint 13.24

**Hint 13.25**

Note that

$$\int_0^1 x^a dx$$

converges for  $\Re(a) > -1$ ; and

$$\int_1^\infty x^a dx$$

converges for  $\Re(a) < 1$ .

Consider  $f(z) = z^a/(z+1)^2$  with a branch cut along the positive real axis and the contour in Figure ?? in the limit as  $\rho \rightarrow 0$  and  $R \rightarrow \infty$ .

To derive the last two integrals, differentiate with respect to  $a$ .

**Hint 13.26****Hint 13.27**

Consider the integral of  $z^a f(z)$  on the contour in Figure ??.

**Hint 13.28**

Differentiate with respect to  $a$ .

**Hint 13.29**

Take the limit as  $a \rightarrow 0$ . Use L'Hospital's rule. To corroborate the result, consider the integral of  $f(z) \log z$  on an appropriate contour.

**Hint 13.30**

Consider the integral of  $f(z) \log^2 z$  on the contour in Figure ??.

**Hint 13.31**

Consider the integral of

$$f(z) = \frac{z^a}{1+z^4}$$

on the boundary of the region  $\epsilon < r < R$ ,  $0 < \theta < \pi/2$ . Take the limits as  $\epsilon \rightarrow 0$  and  $R \rightarrow \infty$ .

**Hint 13.32**

Consider the branch of  $f(z) = z^{1/2} \log z / (z+1)^2$  with a branch cut on the positive real axis and  $0 < \arg z < 2\pi$ . Integrate this function on the contour in Figure ??.

**Exploiting Symmetry****Hint 13.33****Hint 13.34**

For the second part, consider the integral along the boundary of the region,  $0 < r < R$ ,  $0 < \theta < 2\pi/3$ .

**Hint 13.35****Hint 13.36**

To show that the integral on the quarter-circle vanishes as  $R \rightarrow \infty$  establish the inequality,

$$\cos 2\theta \geq 1 - \frac{4}{\pi}\theta, \quad 0 \leq \theta \leq \frac{\pi}{4}.$$

**Hint 13.37**

Consider the box contour  $C$  this is the boundary of the rectangle,  $-R \leq x \leq R$ ,  $0 \leq y \leq \pi$ . The value of the integral is  $\pi^2/2$ .

**Hint 13.38**

Consider the rectangular contour with corners at  $\pm R$  and  $\pm R + i2\pi$ . Let  $R \rightarrow \infty$ .

**Hint 13.39**

**Hint 13.40**

## **Definite Integrals Involving Sine and Cosine**

**Hint 13.41**

**Hint 13.42**

**Hint 13.43**

**Hint 13.44**

Make the changes of variables  $x = \sin \xi$  and then  $z = e^{i\xi}$ .

## **Infinite Sums**

**Hint 13.45**

Use Result [13.10.1](#).

**Hint 13.46**

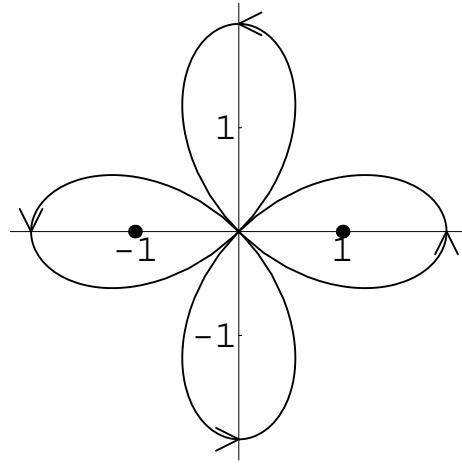

Figure 13.7: The contour  $r = 2 \cos(2\theta)$ .

## 13.13 Solutions

### The Residue Theorem

#### Solution 13.2

1. We consider

$$\int_C \frac{dz}{z^2 - 1}$$

where  $C$  is the contour parameterized by  $r = 2 \cos(2\theta)$ ,  $0 \leq \theta \leq 2\pi$ . (See Figure 13.7.) There are first order

poles at  $z = \pm 1$ . We evaluate the integral with Cauchy's residue theorem.

$$\begin{aligned}\int_C \frac{dz}{z^2 - 1} &= i2\pi \left( \operatorname{Res} \left( \frac{1}{z^2 - 1}, z = 1 \right) + \operatorname{Res} \left( \frac{1}{z^2 - 1}, z = -1 \right) \right) \\ &= i2\pi \left( \frac{1}{z + 1} \Big|_{z=1} + \frac{1}{z - 1} \Big|_{z=-1} \right) \\ &= 0\end{aligned}$$

2. We consider the integral

$$\int_C \frac{e^{iz}}{z^2(z-2)(z+i5)} dz,$$

where  $C$  is the positive circle  $|z| = 3$ . There is a second order pole at  $z = 0$ , and first order poles at  $z = 2$  and  $z = -i5$ . The poles at  $z = 0$  and  $z = 2$  lie inside the contour. We evaluate the integral with Cauchy's residue theorem.

$$\begin{aligned}\int_C \frac{e^{iz}}{z^2(z-2)(z+i5)} dz &= i2\pi \left( \operatorname{Res} \left( \frac{e^{iz}}{z^2(z-2)(z+i5)}, z = 0 \right) \right. \\ &\quad \left. + \operatorname{Res} \left( \frac{e^{iz}}{z^2(z-2)(z+i5)}, z = 2 \right) \right) \\ &= i2\pi \left( \frac{d}{dz} \frac{e^{iz}}{(z-2)(z+i5)} \Big|_{z=0} + \frac{e^{iz}}{z^2(z+i5)} \Big|_{z=2} \right) \\ &= i2\pi \left( \frac{d}{dz} \frac{e^{iz}}{(z-2)(z+i5)} \Big|_{z=0} + \frac{e^{iz}}{z^2(z+i5)} \Big|_{z=2} \right) \\ &= i2\pi \left( \frac{i(z^2 + (i7-2)z - 5 - i12)e^{iz}}{(z-2)^2(z+i5)^2} \Big|_{z=0} + \left( \frac{1}{58} - i\frac{5}{116} \right) e^{i2} \right) \\ &= i2\pi \left( -\frac{3}{25} + \frac{i}{20} + \left( \frac{1}{58} - i\frac{5}{116} \right) e^{i2} \right) \\ &= -\frac{\pi}{10} + \frac{5}{58}\pi \cos 2 - \frac{1}{29}\pi \sin 2 + i \left( -\frac{6\pi}{25} + \frac{1}{29}\pi \cos 2 + \frac{5}{58}\pi \sin 2 \right)\end{aligned}$$

3. We consider the integral

$$\int_C e^{1/z} \sin(1/z) dz$$

where  $C$  is the positive circle  $|z| = 1$ . There is an essential singularity at  $z = 0$ . We determine the residue there by expanding the integrand in a Laurent series.

$$\begin{aligned} e^{1/z} \sin(1/z) &= \left(1 + \frac{1}{z} + \mathcal{O}\left(\frac{1}{z^2}\right)\right) \left(\frac{1}{z} + \mathcal{O}\left(\frac{1}{z^3}\right)\right) \\ &= \frac{1}{z} + \mathcal{O}\left(\frac{1}{z^2}\right) \end{aligned}$$

The residue at  $z = 0$  is 1. We evaluate the integral with the residue theorem.

$$\int_C e^{1/z} \sin(1/z) dz = i2\pi$$

### Solution 13.3

If  $f(\zeta)$  is analytic in a compact, closed, connected domain  $D$  and  $z$  is a point in the interior of  $D$  then Cauchy's integral formula states

$$f^{(n)}(z) = \frac{n!}{i2\pi} \oint_{\partial D} \frac{f(\zeta)}{(\zeta - z)^{n+1}} d\zeta.$$

To corroborate this, we evaluate the integral with Cauchy's residue theorem. There is a pole of order  $n + 1$  at the point  $\zeta = z$ .

$$\begin{aligned} \frac{n!}{i2\pi} \oint_{\partial D} \frac{f(\zeta)}{(\zeta - z)^{n+1}} d\zeta &= \frac{n!}{i2\pi} \frac{i2\pi}{n!} \frac{d^n}{d\zeta^n} f(\zeta) \Big|_{\zeta=z} \\ &= f^{(n)}(z) \end{aligned}$$

### Solution 13.4

1.

$$\frac{1}{z^4 - a^4} = \frac{1}{(z - a)(z + a)(z - ia)(z + ia)}$$



There are first order poles at  $z = \pm a$  and  $z = \pm ia$ . We calculate the residues there.

$$\begin{aligned}\operatorname{Res}\left(\frac{1}{z^4 - a^4}, z = a\right) &= \frac{1}{(z + a)(z - ia)(z + ia)}\Big|_{z=a} = \frac{1}{4a^3} \\ \operatorname{Res}\left(\frac{1}{z^4 - a^4}, z = -a\right) &= \frac{1}{(z - a)(z - ia)(z + ia)}\Big|_{z=-a} = -\frac{1}{4a^3} \\ \operatorname{Res}\left(\frac{1}{z^4 - a^4}, z = ia\right) &= \frac{1}{(z - a)(z + a)(z + ia)}\Big|_{z=ia} = \frac{i}{4a^3} \\ \operatorname{Res}\left(\frac{1}{z^4 - a^4}, z = -ia\right) &= \frac{1}{(z - a)(z + a)(z - ia)}\Big|_{z=-ia} = -\frac{i}{4a^3}\end{aligned}$$

2.

$$\frac{\sin z}{z^2}$$

Since denominator has a second order zero at  $z = 0$  and the numerator has a first order zero there, the function has a first order pole at  $z = 0$ . We calculate the residue there.

$$\begin{aligned}\operatorname{Res}\left(\frac{\sin z}{z^2}, z = 0\right) &= \lim_{z \rightarrow 0} \frac{\sin z}{z} \\ &= \lim_{z \rightarrow 0} \frac{\cos z}{1} \\ &= 1\end{aligned}$$

3.

$$\frac{1 + z^2}{z(z - 1)^2}$$

There is a first order pole at  $z = 0$  and a second order pole at  $z = 1$ .

$$\operatorname{Res}\left(\frac{1 + z^2}{z(z - 1)^2}, z = 0\right) = \frac{1 + z^2}{(z - 1)^2}\Big|_{z=0} = 1$$

$$\begin{aligned}\operatorname{Res}\left(\frac{1+z^2}{z(z-1)^2}, z=1\right) &= \left.\frac{d}{dz}\frac{1+z^2}{z}\right|_{z=1} \\ &= \left.\left(1-\frac{1}{z^2}\right)\right|_{z=1} \\ &= 0\end{aligned}$$

4.  $e^z / (z^2 + a^2)$  has first order poles at  $z = \pm ia$ . We calculate the residues there.

$$\begin{aligned}\operatorname{Res}\left(\frac{e^z}{z^2+a^2}, z=ia\right) &= \left.\frac{e^z}{z+ia}\right|_{z=ia} = -\frac{ie^{ia}}{2a} \\ \operatorname{Res}\left(\frac{e^z}{z^2+a^2}, z=-ia\right) &= \left.\frac{e^z}{z-ia}\right|_{z=-ia} = \frac{ie^{-ia}}{2a}\end{aligned}$$

5. Since  $1 - \cos z$  has a second order zero at  $z = 0$ ,  $\frac{(1-\cos z)^2}{z^7}$  has a third order pole at that point. We find the residue by expanding the function in a Laurent series.

$$\begin{aligned}\frac{(1-\cos z)^2}{z^7} &= z^{-7}\left(1-\left(1-\frac{z^2}{2}+\frac{z^4}{24}+\mathcal{O}(z^6)\right)\right)^2 \\ &= z^{-7}\left(\frac{z^2}{2}-\frac{z^4}{24}+\mathcal{O}(z^6)\right)^2 \\ &= z^{-7}\left(\frac{z^4}{4}-\frac{z^6}{24}+\mathcal{O}(z^8)\right) \\ &= \frac{1}{4z^3}-\frac{1}{24z}+\mathcal{O}(z)\end{aligned}$$

The residue at  $z = 0$  is  $-1/24$ .

### Solution 13.5

Since  $f(z)$  has an isolated pole of order  $n$  at  $z = z_0$ , it has a Laurent series that is convergent in a deleted neighborhood about that point. We substitute this Laurent series into the Residue Formula to verify it.

$$\begin{aligned}\operatorname{Res}(f(z), z_0) &= \lim_{z \rightarrow z_0} \left( \frac{1}{(n-1)!} \frac{d^{n-1}}{dz^{n-1}} [(z - z_0)^n f(z)] \right) \\ &= \lim_{z \rightarrow z_0} \left( \frac{1}{(n-1)!} \frac{d^{n-1}}{dz^{n-1}} \left[ (z - z_0)^n \sum_{k=-n}^{\infty} a_k (z - z_0)^k \right] \right) \\ &= \lim_{z \rightarrow z_0} \left( \frac{1}{(n-1)!} \frac{d^{n-1}}{dz^{n-1}} \left[ \sum_{k=0}^{\infty} a_{k-n} (z - z_0)^k \right] \right) \\ &= \lim_{z \rightarrow z_0} \left( \frac{1}{(n-1)!} \sum_{k=n-1}^{\infty} a_{k-n} \frac{k!}{(k-n+1)!} (z - z_0)^{k-n+1} \right) \\ &= \lim_{z \rightarrow z_0} \left( \frac{1}{(n-1)!} \sum_{k=0}^{\infty} a_{k-1} \frac{(k+n-1)!}{k!} (z - z_0)^k \right) \\ &= \frac{1}{(n-1)!} a_{-1} \frac{(n-1)!}{0!} \\ &= a_{-1}\end{aligned}$$

This proves the Residue Formula.

### Solution 13.6

#### Classify Singularities.

$$f(z) = \frac{z^4}{z^2 + 1} = \frac{z^4}{(z - i)(z + i)}.$$

There are first order poles at  $z = \pm i$ . Since the function behaves like  $z^2$  at infinity, there is a second order pole there.

To see this more slowly, we can make the substitution  $z = 1/\zeta$  and examine the point  $\zeta = 0$ .

$$f\left(\frac{1}{\zeta}\right) = \frac{\zeta^{-4}}{\zeta^{-2} + 1} = \frac{1}{\zeta^2 + \zeta^4} = \frac{1}{\zeta^2(1 + \zeta^2)}$$

$f(1/\zeta)$  has a second order pole at  $\zeta = 0$ , which implies that  $f(z)$  has a second order pole at infinity.

**Residues.** The residues at  $z = \pm i$  are,

$$\operatorname{Res}\left(\frac{z^4}{z^2 + 1}, i\right) = \lim_{z \rightarrow i} \frac{z^4}{z + i} = -\frac{i}{2},$$

$$\operatorname{Res}\left(\frac{z^4}{z^2 + 1}, -i\right) = \lim_{z \rightarrow -i} \frac{z^4}{z - i} = \frac{i}{2}.$$

The residue at infinity is

$$\begin{aligned} \operatorname{Res}(f(z), \infty) &= \operatorname{Res}\left(\frac{-1}{\zeta^2} f\left(\frac{1}{\zeta}\right), \zeta = 0\right) \\ &= \operatorname{Res}\left(\frac{-1}{\zeta^2} \frac{\zeta^{-4}}{\zeta^2 + \zeta^4}, \zeta = 0\right) \\ &= \operatorname{Res}\left(-\frac{\zeta^{-4}}{1 + \zeta^2}, \zeta = 0\right) \end{aligned}$$

Here we could use the residue formula, but it's easier to find the Laurent expansion.

$$\begin{aligned} &= \operatorname{Res}\left(-\zeta^{-4} \sum_{n=0}^{\infty} (-1)^n \zeta^{2n}, \zeta = 0\right) \\ &= 0 \end{aligned}$$

We could also calculate the residue at infinity by recalling that the sum of all residues of this function in the extended complex plane is zero.

$$\frac{-i}{2} + \frac{i}{2} + \operatorname{Res}(f(z), \infty) = 0$$

$$\text{Res}(f(z), \infty) = 0$$

**Laurent Series about  $z = 0$ .** Since the nearest singularities are at  $z = \pm i$ , the Taylor series will converge in the disk  $|z| < 1$ .

$$\begin{aligned} \frac{z^4}{z^2 + 1} &= z^4 \frac{1}{1 - (-z)^2} \\ &= z^4 \sum_{n=0}^{\infty} (-z^2)^n \\ &= z^4 \sum_{n=0}^{\infty} (-1)^n z^{2n} \\ &= \sum_{n=2}^{\infty} (-1)^n z^{2n} \end{aligned}$$

This geometric series converges for  $|-z^2| < 1$ , or  $|z| < 1$ . The series expansion of the function is

$$\boxed{\frac{z^4}{z^2 + 1} = \sum_{n=2}^{\infty} (-1)^n z^{2n} \quad \text{for } |z| < 1}$$

**Laurent Series about  $z = i$ .** We expand  $f(z)$  in partial fractions. First we write the function as a proper rational function, (i.e. the numerator has lower degree than the denominator). By polynomial division, we see that

$$f(z) = z^2 - 1 + \frac{1}{z^2 + 1}.$$

Now we expand the last term in partial fractions.

$$f(z) = z^2 - 1 + \frac{-i/2}{z - i} + \frac{i/2}{z + i}$$

Since the nearest singularity is at  $z = -i$ , the Laurent series will converge in the annulus  $0 < |z - i| < 2$ .

$$\begin{aligned} z^2 - 1 &= ((z - i) + i)^2 - 1 \\ &= (z - i)^2 + i2(z - i) - 2 \end{aligned}$$

$$\begin{aligned} \frac{i/2}{z + i} &= \frac{i/2}{i2 + (z - i)} \\ &= \frac{1/4}{1 - i(z - i)/2} \\ &= \frac{1}{4} \sum_{n=0}^{\infty} \left( \frac{i(z - i)}{2} \right)^n \\ &= \frac{1}{4} \sum_{n=0}^{\infty} \frac{i^n}{2^n} (z - i)^n \end{aligned}$$

This geometric series converges for  $|i(z - i)/2| < 1$ , or  $|z - i| < 2$ . The series expansion of  $f(z)$  is

$$f(z) = \frac{-i/2}{z - i} - 2 + i2(z - i) + (z - i)^2 + \frac{1}{4} \sum_{n=0}^{\infty} \frac{i^n}{2^n} (z - i)^n.$$

$\frac{z^4}{z^2 + 1} = \frac{-i/2}{z - i} - 2 + i2(z - i) + (z - i)^2 + \frac{1}{4} \sum_{n=0}^{\infty} \frac{i^n}{2^n} (z - i)^n \quad \text{for }  z - i  < 2$
--

**Laurent Series about  $z = \infty$ .** Since the nearest singularities are at  $z = \pm i$ , the Laurent series will converge in

the annulus  $1 < |z| < \infty$ .

$$\begin{aligned}\frac{z^4}{z^2 + 1} &= \frac{z^2}{1 + 1/z^2} \\ &= z^2 \sum_{n=0}^{\infty} \left(-\frac{1}{z^2}\right)^n \\ &= \sum_{n=-\infty}^0 (-1)^n z^{2(n+1)} \\ &= \sum_{n=-\infty}^1 (-1)^{n+1} z^{2n}\end{aligned}$$

This geometric series converges for  $|-1/z^2| < 1$ , or  $|z| > 1$ . The series expansion of  $f(z)$  is

$$\boxed{\frac{z^4}{z^2 + 1} = \sum_{n=-\infty}^1 (-1)^{n+1} z^{2n} \quad \text{for } 1 < |z| < \infty}$$

### Solution 13.7

**Method 1: Residue Theorem.** We factor  $P(z)$ . Let  $m$  be the number of roots, counting multiplicities, that lie inside the contour  $\Gamma$ . We find a simple expression for  $P'(z)/P(z)$ .

$$\begin{aligned}P(z) &= c \prod_{k=1}^n (z - z_k) \\ P'(z) &= c \sum_{k=1}^n \prod_{\substack{j=1 \\ j \neq k}}^n (z - z_j)\end{aligned}$$

$$\begin{aligned}
\frac{P'(z)}{P(z)} &= \frac{c \sum_{k=1}^n \prod_{\substack{j=1 \\ j \neq k}}^n (z - z_j)}{c \prod_{k=1}^n (z - z_k)} \\
&= \sum_{k=1}^n \frac{\prod_{\substack{j=1 \\ j \neq k}}^n (z - z_j)}{\prod_{j=1}^n (z - z_j)} \\
&= \sum_{k=1}^n \frac{1}{z - z_k}
\end{aligned}$$

Now we do the integration using the residue theorem.

$$\begin{aligned}
\frac{1}{i2\pi} \int_{\Gamma} \frac{P'(z)}{P(z)} dz &= \frac{1}{i2\pi} \int_{\Gamma} \sum_{k=1}^n \frac{1}{z - z_k} dz \\
&= \sum_{k=1}^n \frac{1}{i2\pi} \int_{\Gamma} \frac{1}{z - z_k} dz \\
&= \sum_{\substack{z_k \\ \text{inside } \Gamma}} \frac{1}{i2\pi} \int_{\Gamma} \frac{1}{z - z_k} dz \\
&= \sum_{\substack{z_k \\ \text{inside } \Gamma}} 1 \\
&= m
\end{aligned}$$

**Method 2: Fundamental Theorem of Calculus.** We factor the polynomial,  $P(z) = c \prod_{k=1}^n (z - z_k)$ . Let  $m$  be



the number of roots, counting multiplicities, that lie inside the contour  $\Gamma$ .

$$\begin{aligned} \frac{1}{i2\pi} \int_{\Gamma} \frac{P'(z)}{P(z)} dz &= \frac{1}{i2\pi} [\log P(z)]_C \\ &= \frac{1}{i2\pi} \left[ \log \prod_{k=1}^n (z - z_k) \right]_C \\ &= \frac{1}{i2\pi} \left[ \sum_{k=1}^n \log(z - z_k) \right]_C \end{aligned}$$

The value of the logarithm changes by  $i2\pi$  for the terms in which  $z_k$  is inside the contour. Its value does not change for the terms in which  $z_k$  is outside the contour.

$$\begin{aligned} &= \frac{1}{i2\pi} \left[ \sum_{z_k \text{ inside } \Gamma} \log(z - z_k) \right]_C \\ &= \frac{1}{i2\pi} \sum_{z_k \text{ inside } \Gamma} i2\pi \\ &= m \end{aligned}$$

### Solution 13.8

1.

$$\oint_C \frac{e^z}{(z - \pi) \tan z} dz = \oint_C \frac{e^z \cos z}{(z - \pi) \sin z} dz$$

The integrand has first order poles at  $z = n\pi$ ,  $n \in \mathbb{Z}$ ,  $n \neq 1$  and a double pole at  $z = \pi$ . The only pole inside

the contour occurs at  $z = 0$ . We evaluate the integral with the residue theorem.

$$\begin{aligned}
 \oint_C \frac{e^z \cos z}{(z - \pi) \sin z} dz &= i2\pi \operatorname{Res} \left( \frac{e^z \cos z}{(z - \pi) \sin z}, z = 0 \right) \\
 &= i2\pi \lim_{z \rightarrow 0} z \frac{e^z \cos z}{(z - \pi) \sin z} \\
 &= -i2 \lim_{z \rightarrow 0} \frac{z}{\sin z} \\
 &= -i2 \lim_{z \rightarrow 0} \frac{1}{\cos z} \\
 &= -i2
 \end{aligned}$$

$$\boxed{\oint_C \frac{e^z}{(z - \pi) \tan z} dz = -i2}$$

2. The integrand has a first order poles at  $z = 0, -\pi$  and a second order pole at  $z = \pi$  inside the contour. The value of the integral is  $i2\pi$  times the sum of the residues at these points. From the previous part we know that residue at  $z = 0$ .

$$\operatorname{Res} \left( \frac{e^z \cos z}{(z - \pi) \sin z}, z = 0 \right) = -\frac{1}{\pi}$$

We find the residue at  $z = -\pi$  with the residue formula.

$$\begin{aligned}
 \operatorname{Res} \left( \frac{e^z \cos z}{(z - \pi) \sin z}, z = -\pi \right) &= \lim_{z \rightarrow -\pi} (z + \pi) \frac{e^z \cos z}{(z - \pi) \sin z} \\
 &= \frac{e^{-\pi}(-1)}{-2\pi} \lim_{z \rightarrow -\pi} \frac{z + \pi}{\sin z} \\
 &= \frac{e^{-\pi}}{2\pi} \lim_{z \rightarrow -\pi} \frac{1}{\cos z} \\
 &= -\frac{e^{-\pi}}{2\pi}
 \end{aligned}$$

We find the residue at  $z = \pi$  by finding the first few terms in the Laurent series of the integrand.

$$\begin{aligned}
 \frac{e^z \cos z}{(z - \pi) \sin z} &= \frac{(e^\pi + e^\pi(z - \pi) + \mathcal{O}((z - \pi)^2))(1 + \mathcal{O}((z - \pi)^2))}{(z - \pi)(-(z - \pi) + \mathcal{O}((z - \pi)^3))} \\
 &= \frac{-e^\pi - e^\pi(z - \pi) + \mathcal{O}((z - \pi)^2)}{-(z - \pi)^2 + \mathcal{O}((z - \pi)^4)} \\
 &= \frac{\frac{e^\pi}{(z - \pi)^2} + \frac{e^\pi}{z - \pi} + \mathcal{O}(1)}{1 + \mathcal{O}((z - \pi)^2)} \\
 &= \left( \frac{e^\pi}{(z - \pi)^2} + \frac{e^\pi}{z - \pi} + \mathcal{O}(1) \right) (1 + \mathcal{O}((z - \pi)^2)) \\
 &= \frac{e^\pi}{(z - \pi)^2} + \frac{e^\pi}{z - \pi} + \mathcal{O}(1)
 \end{aligned}$$

With this we see that

$$\operatorname{Res} \left( \frac{e^z \cos z}{(z - \pi) \sin z}, z = \pi \right) = e^\pi.$$

The integral is

$$\begin{aligned}
 \oint_C \frac{e^z \cos z}{(z - \pi) \sin z} dz &= i2\pi \left( \operatorname{Res} \left( \frac{e^z \cos z}{(z - \pi) \sin z}, z = -\pi \right) + \operatorname{Res} \left( \frac{e^z \cos z}{(z - \pi) \sin z}, z = 0 \right) \right. \\
 &\quad \left. + \operatorname{Res} \left( \frac{e^z \cos z}{(z - \pi) \sin z}, z = \pi \right) \right) \\
 &= i2\pi \left( -\frac{1}{\pi} - \frac{e^{-\pi}}{2\pi} + e^\pi \right)
 \end{aligned}$$

$$\boxed{\oint_C \frac{e^z}{(z - \pi) \tan z} dz = i(2\pi e^\pi - 2 - e^{-\pi})}$$

## Cauchy Principal Value for Real Integrals

### Solution 13.9

Consider the integral

$$\int_{-1}^1 \frac{1}{x} dx.$$

By the definition of improper integrals we have

$$\begin{aligned}\int_{-1}^1 \frac{1}{x} dx &= \lim_{\epsilon \rightarrow 0^+} \int_{-1}^{-\epsilon} \frac{1}{x} dx + \lim_{\delta \rightarrow 0^+} \int_{\delta}^1 \frac{1}{x} dx \\ &= \lim_{\epsilon \rightarrow 0^+} [\log |x|]_{-1}^{-\epsilon} + \lim_{\delta \rightarrow 0^+} [\log |x|]_{\delta}^1 \\ &= \lim_{\epsilon \rightarrow 0^+} \log \epsilon - \lim_{\delta \rightarrow 0^+} \log \delta\end{aligned}$$

This limit diverges. Thus the integral diverges.

Now consider the integral

$$\int_{-1}^1 \frac{1}{x - i\alpha} dx$$

where  $\alpha \in \mathbb{R}$ ,  $\alpha \neq 0$ . Since the integrand is bounded, the integral exists.

$$\begin{aligned}\int_{-1}^1 \frac{1}{x - i\alpha} dx &= \int_{-1}^1 \frac{x + i\alpha}{x^2 + \alpha^2} dx \\ &= \int_{-1}^1 \frac{i\alpha}{x^2 + \alpha^2} dx \\ &= i2 \int_0^1 \frac{\alpha}{x^2 + \alpha^2} dx \\ &= i2 \int_0^{1/\alpha} \frac{1}{\xi^2 + 1} d\xi \\ &= i2 [\arctan \xi]_0^{1/\alpha} \\ &= i2 \arctan \left( \frac{1}{\alpha} \right)\end{aligned}$$



Figure 13.8: The real and imaginary part of the integrand for several values of  $\alpha$ .

Note that the integral exists for all nonzero real  $\alpha$  and that

$$\lim_{\alpha \rightarrow 0^+} \int_{-1}^1 \frac{1}{x - i\alpha} dx = i\pi$$

and

$$\lim_{\alpha \rightarrow 0^-} \int_{-1}^1 \frac{1}{x - i\alpha} dx = -i\pi.$$

The integral exists for  $\alpha$  arbitrarily close to zero, but diverges when  $\alpha = 0$ . The real part of the integrand is an odd function with two humps that get thinner and taller with decreasing  $\alpha$ . The imaginary part of the integrand is an even function with a hump that gets thinner and taller with decreasing  $\alpha$ . (See Figure 13.8.)

$$\Re\left(\frac{1}{x - i\alpha}\right) = \frac{x}{x^2 + \alpha^2}, \quad \Im\left(\frac{1}{x - i\alpha}\right) = \frac{\alpha}{x^2 + \alpha^2}$$

Note that

$$\Re \int_0^1 \frac{1}{x - i\alpha} dx \rightarrow +\infty \text{ as } \alpha \rightarrow 0^+$$

and

$$\Re \int_{-1}^0 \frac{1}{x - i\alpha} dx \rightarrow -\infty \text{ as } \alpha \rightarrow 0^-.$$

However,

$$\lim_{\alpha \rightarrow 0} \Re \int_{-1}^1 \frac{1}{x - i\alpha} dx = 0$$

because the two integrals above cancel each other.

Now note that when  $\alpha = 0$ , the integrand is real. Of course the integral doesn't converge for this case, but if we could assign some value to

$$\int_{-1}^1 \frac{1}{x} dx$$

it would be a real number. Since

$$\lim_{\alpha \rightarrow 0} \int_{-1}^1 \Re \left[ \frac{1}{x - i\alpha} \right] dx = 0,$$

This number should be zero.

### Solution 13.10

1.

$$\begin{aligned} \int_{-1}^1 \frac{1}{x^2} dx &= \lim_{\epsilon \rightarrow 0^+} \left( \int_{-1}^{-\epsilon} \frac{1}{x^2} dx + \int_{\epsilon}^1 \frac{1}{x^2} dx \right) \\ &= \lim_{\epsilon \rightarrow 0^+} \left( \left[ -\frac{1}{x} \right]_{-1}^{-\epsilon} + \left[ -\frac{1}{x} \right]_{\epsilon}^1 \right) \\ &= \lim_{\epsilon \rightarrow 0^+} \left( \frac{1}{\epsilon} - 1 - 1 + \frac{1}{\epsilon} \right) \end{aligned}$$

The principal value of the integral does not exist.

2.

$$\begin{aligned} \int_{-1}^1 \frac{1}{x^3} dx &= \lim_{\epsilon \rightarrow 0^+} \left( \int_{-1}^{-\epsilon} \frac{1}{x^3} dx + \int_{\epsilon}^1 \frac{1}{x^3} dx \right) \\ &= \lim_{\epsilon \rightarrow 0^+} \left( \left[ -\frac{1}{2x^2} \right]_{-1}^{-\epsilon} + \left[ -\frac{1}{2x^2} \right]_{\epsilon}^1 \right) \\ &= \lim_{\epsilon \rightarrow 0^+} \left( -\frac{1}{2(-\epsilon)^2} + \frac{1}{2(-1)^2} - \frac{1}{2(1)^2} + \frac{1}{2\epsilon^2} \right) \\ &= 0 \end{aligned}$$

3. Since  $f(x)$  is real analytic,

$$f(x) = \sum_{n=1}^{\infty} f_n x^n \quad \text{for } x \in (-1, 1).$$

We can rewrite the integrand as

$$\frac{f(x)}{x^3} = \frac{f_0}{x^3} + \frac{f_1}{x^2} + \frac{f_2}{x} + \frac{f(x) - f_0 - f_1 x - f_2 x^2}{x^3}.$$

Note that the final term is real analytic on  $(-1, 1)$ . Thus the principal value of the integral exists if and only if  $f_2 = 0$ .

## Cauchy Principal Value for Contour Integrals

### Solution 13.11

We can write  $f(z)$  as

$$f(z) = \frac{f_0}{z - z_0} + \frac{(z - z_0)f(z) - f_0}{z - z_0}.$$

Note that the second term is analytic in a neighborhood of  $z_0$ . Thus it is bounded on the contour. Let  $M_\epsilon$  be the

maximum modulus of  $\frac{(z-z_0)f(z)-f_0}{z-z_0}$  on  $C_\epsilon$ . By using the maximum modulus integral bound, we have

$$\left| \int_{C_\epsilon} \frac{(z-z_0)f(z)-f_0}{z-z_0} dz \right| \leq (\beta-\alpha)\epsilon M_\epsilon$$

$$\rightarrow 0 \quad \text{as } \epsilon \rightarrow 0^+.$$

Thus we see that

$$\lim_{\epsilon \rightarrow 0^+} \int_{C_\epsilon} f(z) dz = \lim_{\epsilon \rightarrow 0^+} \int_{C_\epsilon} \frac{f_0}{z-z_0} dz.$$

We parameterize the path of integration with

$$z = z_0 + \epsilon e^{i\theta}, \quad \theta \in (\alpha, \beta).$$

Now we evaluate the integral.

$$\begin{aligned} \lim_{\epsilon \rightarrow 0^+} \int_{C_\epsilon} \frac{f_0}{z-z_0} dz &= \lim_{\epsilon \rightarrow 0^+} \int_\alpha^\beta \frac{f_0}{\epsilon e^{i\theta}} i\epsilon e^{i\theta} d\theta \\ &= \lim_{\epsilon \rightarrow 0^+} \int_\alpha^\beta i f_0 d\theta \\ &= i(\beta-\alpha)f_0 \\ &\equiv i(\beta-\alpha) \operatorname{Res}(f(z), z_0) \end{aligned}$$

This proves the result.

### Solution 13.12

Let  $C_i$  be the contour that is indented with circular arcs of radius  $\epsilon$  at each of the first order poles on  $C$  so as to enclose these poles. Let  $A_1, \dots, A_n$  be these circular arcs of radius  $\epsilon$  centered at the points  $\zeta_1, \dots, \zeta_n$ . Let  $C_p$  be the contour, (not necessarily connected), obtained by subtracting each of the  $A_j$ 's from  $C_i$ .

Since the curve is  $C^1$ , (or continuously differentiable), at each of the first order poles on  $C$ , the  $A_j$ 's becomes semi-circles as  $\epsilon \rightarrow 0^+$ . Thus

$$\int_{A_j} f(z) dz = i\pi \operatorname{Res}(f(z), \zeta_j) \quad \text{for } j = 1, \dots, n.$$



CONTINUE

Figure 13.9: The Indented Contour.

The principal value of the integral along  $C$  is

$$\begin{aligned} \int_C f(z) dz &= \lim_{\epsilon \rightarrow 0^+} \int_{C_p} f(z) dz \\ &= \lim_{\epsilon \rightarrow 0^+} \left( \int_{C_i} f(z) dz - \sum_{j=1}^n \int_{A_j} f(z) dz \right) \\ &= i2\pi \left( \sum_{j=1}^m \operatorname{Res}(f(z), z_j) + \sum_{j=1}^n \operatorname{Res}(f(z), \zeta_j) \right) - i\pi \sum_{j=1}^n \operatorname{Res}(f(z), \zeta_j) \end{aligned}$$

$$\int_C f(z) dz = i2\pi \sum_{j=1}^m \operatorname{Res}(f(z), z_j) + i\pi \sum_{j=1}^n \operatorname{Res}(f(z), \zeta_j).$$

**Solution 13.13**

Consider

$$\int_C \frac{1}{z-1} dz$$

where  $C$  is the unit circle. Let  $C_p$  be the circular arc of radius 1 that starts and ends a distance of  $\epsilon$  from  $z = 1$ . Let  $C_\epsilon$  be the negative, circular arc of radius  $\epsilon$  with center at  $z = 1$  that joins the endpoints of  $C_p$ . Let  $C_i$  be the union of  $C_p$  and  $C_\epsilon$ . ( $C_p$  stands for Principal value Contour;  $C_i$  stands for Indented Contour.)  $C_i$  is an indented contour that avoids the first order pole at  $z = 1$ . Figure 13.9 shows the three contours.

Note that the principal value of the integral is

$$\int_C \frac{1}{z-1} dz = \lim_{\epsilon \rightarrow 0^+} \int_{C_p} \frac{1}{z-1} dz.$$

We can calculate the integral along  $C_i$  with Cauchy's theorem. The integrand is analytic inside the contour.

$$\int_{C_i} \frac{1}{z-1} dz = 0$$

We can calculate the integral along  $C_\epsilon$  using Result 13.3.1. Note that as  $\epsilon \rightarrow 0^+$ , the contour becomes a semi-circle, a circular arc of  $\pi$  radians in the negative direction.

$$\lim_{\epsilon \rightarrow 0^+} \int_{C_\epsilon} \frac{1}{z-1} dz = -i\pi \operatorname{Res} \left( \frac{1}{z-1}, 1 \right) = -i\pi$$

Now we can write the principal value of the integral along  $C$  in terms of the two known integrals.

$$\begin{aligned} \int_C \frac{1}{z-1} dz &= \int_{C_i} \frac{1}{z-1} dz - \int_{C_\epsilon} \frac{1}{z-1} dz \\ &= 0 - (-i\pi) \\ &= i\pi \end{aligned}$$

## Integrals on the Real Axis

### Solution 13.14

1. First we note that the integrand is an even function and extend the domain of integration.

$$\int_0^\infty \frac{x^2}{(x^2+1)(x^2+4)} dx = \frac{1}{2} \int_{-\infty}^\infty \frac{x^2}{(x^2+1)(x^2+4)} dx$$

Next we close the path of integration in the upper half plane. Consider the integral along the boundary of the

domain  $0 < r < R$ ,  $0 < \theta < \pi$ .

$$\begin{aligned}
 \frac{1}{2} \int_C \frac{z^2}{(z^2 + 1)(z^2 + 4)} dz &= \frac{1}{2} \int_C \frac{z^2}{(z - i)(z + i)(z - i2)(z + i2)} dz \\
 &= i2\pi \frac{1}{2} \left( \operatorname{Res} \left( \frac{z^2}{(z^2 + 1)(z^2 + 4)}, z = i \right) \right. \\
 &\quad \left. + \operatorname{Res} \left( \frac{z^2}{(z^2 + 1)(z^2 + 4)}, z = i2 \right) \right) \\
 &= i\pi \left( \frac{z^2}{(z + i)(z^2 + 4)} \Big|_{z=i} + \frac{z^2}{(z^2 + 1)(z + i2)} \Big|_{z=i2} \right) \\
 &= i\pi \left( \frac{i}{6} - \frac{i}{3} \right) \\
 &= \frac{\pi}{6}
 \end{aligned}$$

Let  $C_R$  be the circular arc portion of the contour.  $\int_C = \int_{-R}^R + \int_{C_R}$ . We show that the integral along  $C_R$  vanishes as  $R \rightarrow \infty$  with the maximum modulus bound.

$$\begin{aligned}
 \left| \int_{C_R} \frac{z^2}{(z^2 + 1)(z^2 + 4)} dz \right| &\leq \pi R \max_{z \in C_R} \left| \frac{z^2}{(z^2 + 1)(z^2 + 4)} \right| \\
 &= \pi R \frac{R^2}{(R^2 - 1)(R^2 - 4)} \\
 &\rightarrow 0 \text{ as } R \rightarrow \infty
 \end{aligned}$$

We take the limit as  $R \rightarrow \infty$  to evaluate the integral along the real axis.

$$\begin{aligned}
 \lim_{R \rightarrow \infty} \frac{1}{2} \int_{-R}^R \frac{x^2}{(x^2 + 1)(x^2 + 4)} dx &= \frac{\pi}{6} \\
 \int_0^\infty \frac{x^2}{(x^2 + 1)(x^2 + 4)} dx &= \frac{\pi}{6}
 \end{aligned}$$

2. We close the path of integration in the upper half plane. Consider the integral along the boundary of the domain  $0 < r < R$ ,  $0 < \theta < \pi$ .

$$\begin{aligned} \int_C \frac{dz}{(z+b)^2 + a^2} &= \int_C \frac{dz}{(z+b-ia)(z+b+ia)} \\ &= i2\pi \operatorname{Res} \left( \frac{1}{(z+b-ia)(z+b+ia)}, z = -b+ia \right) \\ &= i2\pi \left. \frac{1}{z+b+ia} \right|_{z=-b+ia} \\ &= \frac{\pi}{a} \end{aligned}$$

Let  $C_R$  be the circular arc portion of the contour.  $\int_C = \int_{-R}^R + \int_{C_R}$ . We show that the integral along  $C_R$  vanishes as  $R \rightarrow \infty$  with the maximum modulus bound.

$$\begin{aligned} \left| \int_{C_R} \frac{dz}{(z+b)^2 + a^2} \right| &\leq \pi R \max_{z \in C_R} \left| \frac{1}{(z+b)^2 + a^2} \right| \\ &= \pi R \frac{1}{(R-b)^2 + a^2} \\ &\rightarrow 0 \text{ as } R \rightarrow \infty \end{aligned}$$

We take the limit as  $R \rightarrow \infty$  to evaluate the integral along the real axis.

$$\begin{aligned} \lim_{R \rightarrow \infty} \int_{-R}^R \frac{dx}{(x+b)^2 + a^2} &= \frac{\pi}{a} \\ \int_{-\infty}^{\infty} \frac{dx}{(x+b)^2 + a^2} &= \frac{\pi}{a} \end{aligned}$$

### Solution 13.15

Let  $C_R$  be the semicircular arc from  $R$  to  $-R$  in the upper half plane. Let  $C$  be the union of  $C_R$  and the interval

$[-R, R]$ . We can evaluate the principal value of the integral along  $C$  with Result 13.3.2.

$$\int_C f(x) dx = i2\pi \sum_{k=1}^m \operatorname{Res}(f(z), z_k) + i\pi \sum_{k=1}^n \operatorname{Res}(f(z), x_k)$$

We examine the integral along  $C_R$  as  $R \rightarrow \infty$ .

$$\left| \int_{C_R} f(z) dz \right| \leq \pi R \max_{z \in C_R} |f(z)| \\ \rightarrow 0 \quad \text{as } R \rightarrow \infty.$$

Now we are prepared to evaluate the real integral.

$$\begin{aligned} \int_{-\infty}^{\infty} f(x) dx &= \lim_{R \rightarrow \infty} \int_{-R}^R f(x) dx \\ &= \lim_{R \rightarrow \infty} \int_C f(z) dz \\ &= i2\pi \sum_{k=1}^m \operatorname{Res}(f(z), z_k) + i\pi \sum_{k=1}^n \operatorname{Res}(f(z), x_k) \end{aligned}$$

If we close the path of integration in the lower half plane, the contour will be in the negative direction.

$$\int_{-\infty}^{\infty} f(x) dx = -i2\pi \sum_{k=1}^m \operatorname{Res}(f(z), z_k) - i\pi \sum_{k=1}^n \operatorname{Res}(f(z), x_k)$$

### Solution 13.16

We consider

$$\int_{-\infty}^{\infty} \frac{2x}{x^2 + x + 1} dx.$$

With the change of variables  $x = 1/\xi$ , this becomes

$$\int_{-\infty}^{-\infty} \frac{2\xi^{-1}}{\xi^{-2} + \xi^{-1} + 1} \left( \frac{-1}{\xi^2} \right) d\xi,$$

$$\int_{-\infty}^{\infty} \frac{2\xi^{-1}}{\xi^2 + \xi + 1} d\xi$$

There are first order poles at  $\xi = 0$  and  $\xi = -1/2 \pm i\sqrt{3}/2$ . We close the path of integration in the upper half plane with a semi-circle. Since the integrand decays like  $\xi^{-3}$  the integrand along the semi-circle vanishes as the radius tends to infinity. The value of the integral is thus

$$i\pi \operatorname{Res} \left( \frac{2z^{-1}}{z^2 + z + 1}, z = 0 \right) + i2\pi \operatorname{Res} \left( \frac{2z^{-1}}{z^2 + z + 1}, z = -\frac{1}{2} + i\frac{\sqrt{3}}{2} \right)$$

$$i\pi \lim_{z \rightarrow 0} \left( \frac{2}{z^2 + z + 1} \right) + i2\pi \lim_{z \rightarrow (-1+i\sqrt{3})/2} \left( \frac{2z^{-1}}{z + (1+i\sqrt{3})/2} \right)$$

$$\boxed{\int_{-\infty}^{\infty} \frac{2x}{x^2 + x + 1} dx = -\frac{2\pi}{\sqrt{3}}}$$

### Solution 13.17

1. Consider

$$\int_{-\infty}^{\infty} \frac{1}{x^4 + 1} dx.$$

The integrand  $\frac{1}{z^4+1}$  is analytic on the real axis and has isolated singularities at the points

$$z = \{e^{i\pi/4}, e^{i3\pi/4}, e^{i5\pi/4}, e^{i7\pi/4}\}.$$

Let  $C_R$  be the semi-circle of radius  $R$  in the upper half plane. Since

$$\lim_{R \rightarrow \infty} \left( R \max_{z \in C_R} \left| \frac{1}{z^4 + 1} \right| \right) = \lim_{R \rightarrow \infty} \left( R \frac{1}{R^4 - 1} \right) = 0,$$

we can apply Result 13.4.1.

$$\int_{-\infty}^{\infty} \frac{1}{x^4 + 1} dx = i2\pi \left( \operatorname{Res} \left( \frac{1}{z^4 + 1}, e^{i\pi/4} \right) + \operatorname{Res} \left( \frac{1}{z^4 + 1}, e^{i3\pi/4} \right) \right)$$

The appropriate residues are,

$$\begin{aligned} \operatorname{Res} \left( \frac{1}{z^4 + 1}, e^{i\pi/4} \right) &= \lim_{z \rightarrow e^{i\pi/4}} \frac{z - e^{i\pi/4}}{z^4 + 1} \\ &= \lim_{z \rightarrow e^{i\pi/4}} \frac{1}{4z^3} \\ &= \frac{1}{4} e^{-i3\pi/4} \\ &= \frac{-1 - i}{4\sqrt{2}}, \end{aligned}$$

$$\begin{aligned} \operatorname{Res} \left( \frac{1}{z^4 + 1}, e^{i3\pi/4} \right) &= \frac{1}{4(e^{i3\pi/4})^3} \\ &= \frac{1}{4} e^{-i\pi/4} \\ &= \frac{1 - i}{4\sqrt{2}}, \end{aligned}$$

We evaluate the integral with the residue theorem.

$$\int_{-\infty}^{\infty} \frac{1}{x^4 + 1} dx = i2\pi \left( \frac{-1 - i}{4\sqrt{2}} + \frac{1 - i}{4\sqrt{2}} \right)$$

$$\boxed{\int_{-\infty}^{\infty} \frac{1}{x^4 + 1} dx = \frac{\pi}{\sqrt{2}}}$$

2. Now consider

$$\int_{-\infty}^{\infty} \frac{x^2}{(x^2 + 1)^2} dx.$$

The integrand is analytic on the real axis and has second order poles at  $z = \pm i$ . Since the integrand decays sufficiently fast at infinity,

$$\lim_{R \rightarrow \infty} \left( R \max_{z \in C_R} \left| \frac{z^2}{(z^2 + 1)^2} \right| \right) = \lim_{R \rightarrow \infty} \left( R \frac{R^2}{(R^2 - 1)^2} \right) = 0$$

we can apply Result 13.4.1.

$$\int_{-\infty}^{\infty} \frac{x^2}{(x^2 + 1)^2} dx = i2\pi \operatorname{Res} \left( \frac{z^2}{(z^2 + 1)^2}, z = i \right)$$

$$\begin{aligned} \operatorname{Res} \left( \frac{z^2}{(z^2 + 1)^2}, z = i \right) &= \lim_{z \rightarrow i} \frac{d}{dz} \left( (z - i)^2 \frac{z^2}{(z^2 + 1)^2} \right) \\ &= \lim_{z \rightarrow i} \frac{d}{dz} \left( \frac{z^2}{(z + i)^2} \right) \\ &= \lim_{z \rightarrow i} \left( \frac{(z + i)^2 2z - z^2 2(z + i)}{(z + i)^4} \right) \\ &= -\frac{i}{4} \end{aligned}$$

$$\boxed{\int_{-\infty}^{\infty} \frac{x^2}{(x^2 + 1)^2} dx = \frac{\pi}{2}}$$

3. Since

$$\frac{\sin(x)}{1 + x^2}$$



is an odd function,

$$\int_{-\infty}^{\infty} \frac{\cos(x)}{1+x^2} dx = \int_{-\infty}^{\infty} \frac{e^{ix}}{1+x^2} dx$$

Since  $e^{iz}/(1+z^2)$  is analytic except for simple poles at  $z = \pm i$  and the integrand decays sufficiently fast in the upper half plane,

$$\lim_{R \rightarrow \infty} \left( R \max_{z \in C_R} \left| \frac{e^{iz}}{1+z^2} \right| \right) = \lim_{R \rightarrow \infty} \left( R \frac{1}{R^2-1} \right) = 0$$

we can apply Result 13.4.1.

$$\begin{aligned} \int_{-\infty}^{\infty} \frac{e^{ix}}{1+x^2} dx &= i2\pi \operatorname{Res} \left( \frac{e^{iz}}{(z-i)(z+i)}, z=i \right) \\ &= i2\pi \frac{e^{-1}}{i2} \end{aligned}$$

$$\boxed{\int_{-\infty}^{\infty} \frac{\cos(x)}{1+x^2} dx = \frac{\pi}{e}}$$

### Solution 13.18

Consider the function

$$f(z) = \frac{z^6}{(z^4+1)^2}.$$

The value of the function on the imaginary axis:

$$\frac{-y^6}{(y^4+1)^2}$$

is a constant multiple of the value of the function on the real axis:

$$\frac{x^6}{(x^4+1)^2}.$$

Thus to evaluate the real integral we consider the path of integration,  $C$ , which starts at the origin, follows the real axis to  $R$ , follows a circular path to  $iR$  and then follows the imaginary axis back down to the origin.  $f(z)$  has second order poles at the fourth roots of  $-1$ :  $(\pm 1 \pm i)/\sqrt{2}$ . Of these only  $(1 + i)/\sqrt{2}$  lies inside the path of integration. We evaluate the contour integral with the Residue Theorem. For  $R > 1$ :

$$\begin{aligned}
 \int_C \frac{z^6}{(z^4 + 1)^2} dz &= i2\pi \operatorname{Res} \left( \frac{z^6}{(z^4 + 1)^2}, z = e^{i\pi/4} \right) \\
 &= i2\pi \lim_{z \rightarrow e^{i\pi/4}} \frac{d}{dz} \left( (z - e^{i\pi/4})^2 \frac{z^6}{(z^4 + 1)^2} \right) \\
 &= i2\pi \lim_{z \rightarrow e^{i\pi/4}} \frac{d}{dz} \left( \frac{z^6}{(z - e^{i3\pi/4})^2 (z - e^{i5\pi/4})^2 (z - e^{i7\pi/4})^2} \right) \\
 &= i2\pi \lim_{z \rightarrow e^{i\pi/4}} \left( \frac{z^6}{(z - e^{i3\pi/4})^2 (z - e^{i5\pi/4})^2 (z - e^{i7\pi/4})^2} \right. \\
 &\quad \left. \left( \frac{6}{z} - \frac{2}{z - e^{i3\pi/4}} - \frac{2}{z - e^{i5\pi/4}} - \frac{2}{z - e^{i7\pi/4}} \right) \right) \\
 &= i2\pi \frac{-i}{(2)(i4)(-2)} \left( \frac{6\sqrt{2}}{1+i} - \frac{2}{\sqrt{2}} - \frac{2\sqrt{2}}{2+i2} - \frac{2}{i\sqrt{2}} \right) \\
 &= i2\pi \frac{3}{32} (1-i)\sqrt{2} \\
 &= \frac{3\pi}{8\sqrt{2}} (1+i)
 \end{aligned}$$

The integral along the circular part of the contour,  $C_R$ , vanishes as  $R \rightarrow \infty$ . We demonstrate this with the maximum

modulus integral bound.

$$\begin{aligned} \left| \int_{C_R} \frac{z^6}{(z^4 + 1)^2} dz \right| &\leq \frac{\pi R}{4} \max_{z \in C_R} \left( \frac{z^6}{(z^4 + 1)^2} \right) \\ &= \frac{\pi R}{4} \frac{R^6}{(R^4 - 1)^2} \\ &\rightarrow 0 \text{ as } R \rightarrow \infty \end{aligned}$$

Taking the limit  $R \rightarrow \infty$ , we have:

$$\begin{aligned} \int_0^\infty \frac{x^6}{(x^4 + 1)^2} dx + \int_\infty^0 \frac{(iy)^6}{((iy)^4 + 1)^2} i dy &= \frac{3\pi}{8\sqrt{2}}(1 + i) \\ \int_0^\infty \frac{x^6}{(x^4 + 1)^2} dx + i \int_0^\infty \frac{y^6}{(y^4 + 1)^2} dy &= \frac{3\pi}{8\sqrt{2}}(1 + i) \\ (1 + i) \int_0^\infty \frac{x^6}{(x^4 + 1)^2} dx &= \frac{3\pi}{8\sqrt{2}}(1 + i) \\ \boxed{\int_0^\infty \frac{x^6}{(x^4 + 1)^2} dx = \frac{3\pi}{8\sqrt{2}}} \end{aligned}$$

## Fourier Integrals

### Solution 13.19

We know that

$$\int_0^\pi e^{-R \sin \theta} d\theta < \frac{\pi}{R}.$$

First take the case that  $\omega$  is positive and the semi-circle is in the upper half plane.

$$\begin{aligned}
 \left| \int_{C_R} f(z) e^{i\omega z} dz \right| &\leq \left| \int_{C_R} e^{i\omega z} dz \right| \max_{z \in C_R} |f(z)| \\
 &\leq \int_0^\pi \left| e^{i\omega R e^{i\theta}} R e^{i\theta} \right| d\theta \max_{z \in C_R} |f(z)| \\
 &= R \int_0^\pi \left| e^{-\omega R \sin \theta} \right| d\theta \max_{z \in C_R} |f(z)| \\
 &< R \frac{\pi}{\omega R} \max_{z \in C_R} |f(z)| \\
 &= \frac{\pi}{\omega} \max_{z \in C_R} |f(z)| \\
 &\rightarrow 0 \quad \text{as } R \rightarrow \infty
 \end{aligned}$$

The procedure is almost the same for negative  $\omega$ .

### Solution 13.20

First we write the integral in terms of Fourier integrals.

$$\int_{-\infty}^{\infty} \frac{\cos 2x}{x - i\pi} dx = \int_{-\infty}^{\infty} \frac{e^{i2x}}{2(x - i\pi)} dx + \int_{-\infty}^{\infty} \frac{e^{-i2x}}{2(x - i\pi)} dx$$

Note that  $\frac{1}{2(z - i\pi)}$  vanishes as  $|z| \rightarrow \infty$ . We close the former Fourier integral in the upper half plane and the latter in the lower half plane. There is a first order pole at  $z = i\pi$  in the upper half plane.

$$\begin{aligned}
 \int_{-\infty}^{\infty} \frac{e^{i2x}}{2(x - i\pi)} dx &= i2\pi \operatorname{Res} \left( \frac{e^{i2z}}{2(z - i\pi)}, z = i\pi \right) \\
 &= i2\pi \frac{e^{-2\pi}}{2}
 \end{aligned}$$

There are no singularities in the lower half plane.

$$\int_{-\infty}^{\infty} \frac{e^{-i2x}}{2(x - i\pi)} dx = 0$$

Thus the value of the original real integral is

$$\int_{-\infty}^{\infty} \frac{\cos 2x}{x - i\pi} dx = i\pi e^{-2\pi}$$

## Fourier Cosine and Sine Integrals

### Solution 13.21

We are considering the integral

$$\int_{-\infty}^{\infty} \frac{\sin x}{x} dx.$$

The integrand is an entire function. So it doesn't appear that the residue theorem would directly apply. Also the integrand is unbounded as  $x \rightarrow +i\infty$  and  $x \rightarrow -i\infty$ , so closing the integral in the upper or lower half plane is not directly applicable. In order to proceed, we must write the integrand in a different form. Note that

$$\int_{-\infty}^{\infty} \frac{\cos x}{x} dx = 0$$

since the integrand is odd and has only a first order pole at  $x = 0$ . Thus

$$\int_{-\infty}^{\infty} \frac{\sin x}{x} dx = \int_{-\infty}^{\infty} \frac{e^{ix}}{ix} dx.$$

Let  $C_R$  be the semicircular arc in the upper half plane from  $R$  to  $-R$ . Let  $C$  be the closed contour that is the union of  $C_R$  and the real interval  $[-R, R]$ . If we close the path of integration with a semicircular arc in the upper half plane, we have

$$\int_{-\infty}^{\infty} \frac{\sin x}{x} dx = \lim_{R \rightarrow \infty} \left( \int_C \frac{e^{iz}}{iz} dz - \int_{C_R} \frac{e^{iz}}{iz} dz \right),$$

provided that all the integrals exist.

The integral along  $C_R$  vanishes as  $R \rightarrow \infty$  by Jordan's lemma. By the residue theorem for principal values we have

$$\int \frac{e^{iz}}{iz} dz = i\pi \operatorname{Res} \left( \frac{e^{iz}}{iz}, 0 \right) = \pi.$$

Combining these results,

$$\boxed{\int_{-\infty}^{\infty} \frac{\sin x}{x} dx = \pi.}$$

### Solution 13.22

Note that  $(1 - \cos x)/x^2$  has a removable singularity at  $x = 0$ . The integral decays like  $\frac{1}{x^2}$  at infinity, so the integral exists. Since  $(\sin x)/x^2$  is an odd function with a simple pole at  $x = 0$ , the principal value of its integral vanishes.

$$\begin{aligned} \int_{-\infty}^{\infty} \frac{\sin x}{x^2} dx &= 0 \\ \int_{-\infty}^{\infty} \frac{1 - \cos x}{x^2} dx &= \int_{-\infty}^{\infty} \frac{1 - \cos x - i \sin x}{x^2} dx = \int_{-\infty}^{\infty} \frac{1 - e^{ix}}{x^2} dx \end{aligned}$$

Let  $C_R$  be the semi-circle of radius  $R$  in the upper half plane. Since

$$\lim_{R \rightarrow \infty} \left( R \max_{z \in C_R} \left| \frac{1 - e^{iz}}{z^2} \right| \right) = \lim_{R \rightarrow \infty} R \frac{2}{R^2} = 0$$

the integral along  $C_R$  vanishes as  $R \rightarrow \infty$ .

$$\int_{C_R} \frac{1 - e^{iz}}{z^2} dz \rightarrow 0 \text{ as } R \rightarrow \infty$$

We can apply Result 13.4.1.

$$\int_{-\infty}^{\infty} \frac{1 - e^{ix}}{x^2} dx = i\pi \operatorname{Res} \left( \frac{1 - e^{iz}}{z^2}, z = 0 \right) = i\pi \lim_{z \rightarrow 0} \frac{1 - e^{iz}}{z} = i\pi \lim_{z \rightarrow 0} \frac{-i e^{iz}}{1}$$

$$\boxed{\int_{-\infty}^{\infty} \frac{1 - \cos x}{x^2} dx = \pi}$$

**Solution 13.23**

Consider

$$\int_0^{\infty} \frac{\sin(\pi x)}{x(1-x^2)} dx.$$

Note that the integrand has removable singularities at the points  $x = 0, \pm 1$  and is an even function.

$$\int_0^{\infty} \frac{\sin(\pi x)}{x(1-x^2)} dx = \frac{1}{2} \int_{-\infty}^{\infty} \frac{\sin(\pi x)}{x(1-x^2)} dx.$$

Note that  $\frac{\cos(\pi x)}{x(1-x^2)}$  is an odd function with first order poles at  $x = 0, \pm 1$ .

$$\begin{aligned} \int_{-\infty}^{\infty} \frac{\cos(\pi x)}{x(1-x^2)} dx &= 0 \\ \int_0^{\infty} \frac{\sin(\pi x)}{x(1-x^2)} dx &= -\frac{i}{2} \int_{-\infty}^{\infty} \frac{e^{i\pi x}}{x(1-x^2)} dx. \end{aligned}$$

Let  $C_R$  be the semi-circle of radius  $R$  in the upper half plane. Since

$$\lim_{R \rightarrow \infty} \left( R \max_{z \in C_R} \left| \frac{e^{i\pi z}}{z(1-z^2)} \right| \right) = \lim_{R \rightarrow \infty} R \frac{1}{R(R^2-1)} = 0$$

the integral along  $C_R$  vanishes as  $R \rightarrow \infty$ .

$$\int_{C_R} \frac{e^{i\pi z}}{z(1-z^2)} dz \rightarrow 0 \text{ as } R \rightarrow \infty$$

We can apply Result 13.4.1.

$$\begin{aligned}
 -\frac{i}{2} \int_{-\infty}^{\infty} \frac{e^{i\pi x}}{x(1-x^2)} dx &= i\pi \frac{-i}{2} \left( \operatorname{Res} \left( \frac{e^{iz}}{z(1-z^2)}, z=0 \right) + \operatorname{Res} \left( \frac{e^{iz}}{z(1-z^2)}, z=1 \right) \right. \\
 &\quad \left. + \operatorname{Res} \left( \frac{e^{iz}}{z(1-z^2)}, z=-1 \right) \right) \\
 &= \frac{\pi}{2} \left( \lim_{z \rightarrow 0} \frac{e^{i\pi z}}{1-z^2} - \lim_{z \rightarrow 0} \frac{e^{i\pi z}}{z(1+z)} + \lim_{z \rightarrow 0} \frac{e^{i\pi z}}{z(1-z)} \right) \\
 &= \frac{\pi}{2} \left( 1 - \frac{-1}{2} + \frac{-1}{-2} \right)
 \end{aligned}$$

$$\boxed{\int_0^{\infty} \frac{\sin(\pi x)}{x(1-x^2)} dx = \pi}$$

## Contour Integration and Branch Cuts

### Solution 13.24

Let  $C$  be the boundary of the region  $\epsilon < r < R$ ,  $0 < \theta < \pi$ . Choose the branch of the logarithm with a branch cut on the negative imaginary axis and the angle range  $-\pi/2 < \theta < 3\pi/2$ . We consider the integral of  $\log^2 z / (1+z^2)$  on this contour.

$$\begin{aligned}
 \oint_C \frac{\log^2 z}{1+z^2} dz &= i2\pi \operatorname{Res} \left( \frac{\log^2 z}{1+z^2}, z=i \right) \\
 &= i2\pi \lim_{z \rightarrow i} \frac{\log^2 z}{z+i} \\
 &= i2\pi \frac{(i\pi/2)^2}{i2} \\
 &= -\frac{\pi^3}{4}
 \end{aligned}$$



Let  $C_R$  be the semi-circle from  $R$  to  $-R$  in the upper half plane. We show that the integral along  $C_R$  vanishes as  $R \rightarrow \infty$  with the maximum modulus integral bound.

$$\begin{aligned} \left| \int_{C_R} \frac{\log^2 z}{1+z^2} dz \right| &\leq \pi R \max_{z \in C_R} \left| \frac{\log^2 z}{1+z^2} \right| \\ &\leq \pi R \frac{\ln^2 R + 2\pi \ln R + \pi^2}{R^2 - 1} \\ &\rightarrow 0 \text{ as } R \rightarrow \infty \end{aligned}$$

Let  $C_\epsilon$  be the semi-circle from  $-\epsilon$  to  $\epsilon$  in the upper half plane. We show that the integral along  $C_\epsilon$  vanishes as  $\epsilon \rightarrow 0$  with the maximum modulus integral bound.

$$\begin{aligned} \left| \int_{C_\epsilon} \frac{\log^2 z}{1+z^2} dz \right| &\leq \pi \epsilon \max_{z \in C_\epsilon} \left| \frac{\log^2 z}{1+z^2} \right| \\ &\leq \pi \epsilon \frac{\ln^2 \epsilon - 2\pi \ln \epsilon + \pi^2}{1 - \epsilon^2} \\ &\rightarrow 0 \text{ as } \epsilon \rightarrow 0 \end{aligned}$$

Now we take the limit as  $\epsilon \rightarrow 0$  and  $R \rightarrow \infty$  for the integral along  $C$ .

$$\begin{aligned} \oint_C \frac{\log^2 z}{1+z^2} dz &= -\frac{\pi^3}{4} \\ \int_0^\infty \frac{\ln^2 r}{1+r^2} dr + \int_\infty^0 \frac{(\ln r + i\pi)^2}{1+r^2} dr &= -\frac{\pi^3}{4} \\ 2 \int_0^\infty \frac{\ln^2 x}{1+x^2} dx + i2\pi \int_0^\infty \frac{\ln x}{1+x^2} dx &= \pi^2 \int_0^\infty \frac{1}{1+x^2} dx - \frac{\pi^3}{4} \end{aligned} \tag{13.1}$$

We evaluate the integral of  $1/(1+x^2)$  by extending the path of integration to  $(-\infty \dots \infty)$  and closing the path of integration in the upper half plane. Since

$$\lim_{R \rightarrow \infty} \left( R \max_{z \in C_R} \left| \frac{1}{1+z^2} \right| \right) \leq \lim_{R \rightarrow \infty} \left( R \frac{1}{R^2 - 1} \right) = 0,$$

the integral of  $1/(1+z^2)$  along  $C_R$  vanishes as  $R \rightarrow \infty$ . We evaluate the integral with the Residue Theorem.

$$\begin{aligned} \pi^2 \int_0^\infty \frac{1}{1+x^2} dx &= \frac{\pi^2}{2} \int_{-\infty}^\infty \frac{1}{1+x^2} dx \\ &= \frac{\pi^2}{2} i 2\pi \operatorname{Res} \left( \frac{1}{1+z^2}, z = i \right) \\ &= i\pi^3 \lim_{z \rightarrow i} \frac{1}{z+i} \\ &= \frac{\pi^3}{2} \end{aligned}$$

Now we return to Equation 13.1.

$$2 \int_0^\infty \frac{\ln^2 x}{1+x^2} dx + i 2\pi \int_0^\infty \frac{\ln x}{1+x^2} dx = \frac{\pi^3}{4}$$

We equate the real and imaginary parts to solve for the desired integrals.

$$\boxed{\int_0^\infty \frac{\ln^2 x}{1+x^2} dx = \frac{\pi^3}{8}}$$

$$\boxed{\int_0^\infty \frac{\ln x}{1+x^2} dx = 0}$$

### Solution 13.25

We consider the branch of the function

$$f(z) = \frac{\log z}{z^2 + 5z + 6}$$

with a branch cut on the real axis and  $0 < \arg(z) < 2\pi$ .

Let  $C_\epsilon$  and  $C_R$  denote the circles of radius  $\epsilon$  and  $R$  where  $\epsilon < 1 < R$ .  $C_\epsilon$  is negatively oriented;  $C_R$  is positively oriented. Consider the closed contour,  $C$ , that is traced by a point moving from  $\epsilon$  to  $R$  above the branch cut, next around  $C_R$  back to  $R$ , then below the cut to  $\epsilon$ , and finally around  $C_\epsilon$  back to  $\epsilon$ . (See Figure 13.10.)

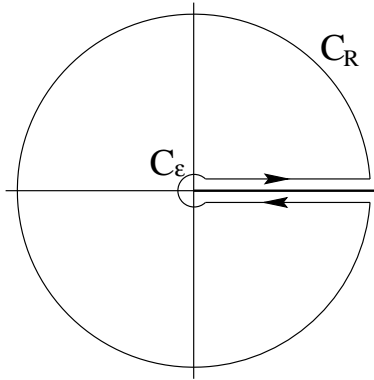

Figure 13.10: The path of integration.

We can evaluate the integral of  $f(z)$  along  $C$  with the residue theorem. For  $R > 3$ , there are first order poles inside the path of integration at  $z = -2$  and  $z = -3$ .

$$\begin{aligned}
 \int_C \frac{\log z}{z^2 + 5z + 6} dz &= i2\pi \left( \operatorname{Res} \left( \frac{\log z}{z^2 + 5z + 6}, z = -2 \right) + \operatorname{Res} \left( \frac{\log z}{z^2 + 5z + 6}, z = -3 \right) \right) \\
 &= i2\pi \left( \lim_{z \rightarrow -2} \frac{\log z}{z + 3} + \lim_{z \rightarrow -3} \frac{\log z}{z + 2} \right) \\
 &= i2\pi \left( \frac{\log(-2)}{1} + \frac{\log(-3)}{-1} \right) \\
 &= i2\pi (\log(2) + i\pi - \log(3) - i\pi) \\
 &= i2\pi \log \left( \frac{2}{3} \right)
 \end{aligned}$$

In the limit as  $\epsilon \rightarrow 0$ , the integral along  $C_\epsilon$  vanishes. We demonstrate this with the maximum modulus theorem.

$$\begin{aligned} \left| \int_{C_\epsilon} \frac{\log z}{z^2 + 5z + 6} dz \right| &\leq 2\pi\epsilon \max_{z \in C_\epsilon} \left| \frac{\log z}{z^2 + 5z + 6} \right| \\ &\leq 2\pi\epsilon \frac{2\pi - \log \epsilon}{6 - 5\epsilon - \epsilon^2} \\ &\rightarrow 0 \text{ as } \epsilon \rightarrow 0 \end{aligned}$$

In the limit as  $R \rightarrow \infty$ , the integral along  $C_R$  vanishes. We again demonstrate this with the maximum modulus theorem.

$$\begin{aligned} \left| \int_{C_R} \frac{\log z}{z^2 + 5z + 6} dz \right| &\leq 2\pi R \max_{z \in C_R} \left| \frac{\log z}{z^2 + 5z + 6} \right| \\ &\leq 2\pi R \frac{\log R + 2\pi}{R^2 - 5R - 6} \\ &\rightarrow 0 \text{ as } R \rightarrow \infty \end{aligned}$$

Taking the limit as  $\epsilon \rightarrow 0$  and  $R \rightarrow \infty$ , the integral along  $C$  is:

$$\begin{aligned} \int_C \frac{\log z}{z^2 + 5z + 6} dz &= \int_0^\infty \frac{\log x}{x^2 + 5x + 6} dx + \int_\infty^0 \frac{\log x + i2\pi}{x^2 + 5x + 6} dx \\ &= -i2\pi \int_0^\infty \frac{\log x}{x^2 + 5x + 6} dx \end{aligned}$$

Now we can evaluate the real integral.

$$\begin{aligned} -i2\pi \int_0^\infty \frac{\log x}{x^2 + 5x + 6} dx &= i2\pi \log \left( \frac{2}{3} \right) \\ \boxed{\int_0^\infty \frac{\log x}{x^2 + 5x + 6} dx} &= \log \left( \frac{3}{2} \right) \end{aligned}$$

**Solution 13.26**

We consider the integral

$$I(a) = \int_0^{\infty} \frac{x^a}{(x+1)^2} dx.$$

To examine convergence, we split the domain of integration.

$$\int_0^{\infty} \frac{x^a}{(x+1)^2} dx = \int_0^1 \frac{x^a}{(x+1)^2} dx + \int_1^{\infty} \frac{x^a}{(x+1)^2} dx$$

First we work with the integral on  $(0 \dots 1)$ .

$$\begin{aligned} \left| \int_0^1 \frac{x^a}{(x+1)^2} dx \right| &\leq \int_0^1 \left| \frac{x^a}{(x+1)^2} \right| |dx| \\ &= \int_0^1 \frac{x^{\Re(a)}}{(x+1)^2} dx \\ &\leq \int_0^1 x^{\Re(a)} dx \end{aligned}$$

This integral converges for  $\Re(a) > -1$ .

Next we work with the integral on  $(1 \dots \infty)$ .

$$\begin{aligned} \left| \int_1^{\infty} \frac{x^a}{(x+1)^2} dx \right| &\leq \int_1^{\infty} \left| \frac{x^a}{(x+1)^2} \right| |dx| \\ &= \int_1^{\infty} \frac{x^{\Re(a)}}{(x+1)^2} dx \\ &\leq \int_1^{\infty} x^{\Re(a)-2} dx \end{aligned}$$

This integral converges for  $\Re(a) < 1$ .

Thus we see that the integral defining  $I(a)$  converges in the strip,  $-1 < \Re(a) < 1$ . The integral converges uniformly in any closed subset of this domain. Uniform convergence means that we can differentiate the integral with respect to  $a$  and interchange the order of integration and differentiation.

$$I'(a) = \int_0^\infty \frac{x^a \log x}{(x+1)^2} dx$$

Thus we see that  $I(a)$  is analytic for  $-1 < \Re(a) < 1$ .

For  $-1 < \Re(a) < 1$  and  $a \neq 0$ ,  $z^a$  is multi-valued. Consider the branch of the function  $f(z) = z^a/(z+1)^2$  with a branch cut on the positive real axis and  $0 < \arg(z) < 2\pi$ . We integrate along the contour in Figure ??.

The integral on  $C_\epsilon$  vanishes as  $\epsilon \rightarrow 0$ . We show this with the maximum modulus integral bound. First we write  $z^a$  in modulus-argument form,  $z = \epsilon e^{i\theta}$ , where  $a = \alpha + i\beta$ .

$$\begin{aligned} z^a &= e^{a \log z} \\ &= e^{(\alpha+i\beta)(\ln \epsilon + i\theta)} \\ &= e^{\alpha \ln \epsilon - \beta\theta + i(\beta \ln \epsilon + \alpha\theta)} \\ &= \epsilon^\alpha e^{-\beta\theta} e^{i(\beta \ln \epsilon + \alpha\theta)} \end{aligned}$$

Now we bound the integral.

$$\begin{aligned} \left| \int_{C_\epsilon} \frac{z^a}{(z+1)^2} dz \right| &\leq 2\pi\epsilon \max_{z \in C_\epsilon} \left| \frac{z^a}{(z+1)^2} \right| \\ &\leq 2\pi\epsilon \frac{\epsilon^\alpha e^{2\pi|\beta|}}{(1-\epsilon)^2} \\ &\rightarrow 0 \text{ as } \epsilon \rightarrow 0 \end{aligned}$$

The integral on  $C_R$  vanishes as  $R \rightarrow \infty$ .

$$\begin{aligned} \left| \int_{C_R} \frac{z^a}{(z+1)^2} dz \right| &\leq 2\pi R \max_{z \in C_R} \left| \frac{z^a}{(z+1)^2} \right| \\ &\leq 2\pi R \frac{R^\alpha e^{2\pi|\beta|}}{(R-1)^2} \\ &\rightarrow 0 \text{ as } R \rightarrow \infty \end{aligned}$$

Above the branch cut, ( $z = r e^{i0}$ ), the integrand is

$$f(r e^{i0}) = \frac{r^a}{(r+1)^2}.$$

Below the branch cut, ( $z = r e^{i2\pi}$ ), we have,

$$f(r e^{i2\pi}) = \frac{e^{i2\pi a} r^a}{(r+1)^2}.$$

Now we use the residue theorem.

$$\begin{aligned} \int_0^\infty \frac{r^a}{(r+1)^2} dr + \int_\infty^0 \frac{e^{i2\pi a} r^a}{(r+1)^2} dr &= i2\pi \operatorname{Res} \left( \frac{z^a}{(z+1)^2}, -1 \right) \\ (1 - e^{i2\pi a}) \int_0^\infty \frac{r^a}{(r+1)^2} dr &= i2\pi \lim_{z \rightarrow -1} \frac{d}{dz} (z^a) \\ \int_0^\infty \frac{r^a}{(r+1)^2} dr &= i2\pi \frac{a e^{i\pi(a-1)}}{1 - e^{i2\pi a}} \\ \int_0^\infty \frac{r^a}{(r+1)^2} dr &= \frac{-i2\pi a}{e^{-i\pi a} - e^{i\pi a}} \\ \int_0^\infty \frac{x^a}{(x+1)^2} dx &= \frac{\pi a}{\sin(\pi a)} \quad \text{for } -1 < \Re(a) < 1, a \neq 0 \end{aligned}$$

The right side has a removable singularity at  $a = 0$ . We use analytic continuation to extend the answer to  $a = 0$ .

$$I(a) = \int_0^\infty \frac{x^a}{(x+1)^2} dx = \begin{cases} \frac{\pi a}{\sin(\pi a)} & \text{for } -1 < \Re(a) < 1, a \neq 0 \\ 1 & \text{for } a = 0 \end{cases}$$

We can derive the last two integrals by differentiating this formula with respect to  $a$  and taking the limit  $a \rightarrow 0$ .

$$I'(a) = \int_0^\infty \frac{x^a \log x}{(x+1)^2} dx, \quad I''(a) = \int_0^\infty \frac{x^a \log^2 x}{(x+1)^2} dx$$

$$I'(0) = \int_0^\infty \frac{\log x}{(x+1)^2} dx, \quad I''(0) = \int_0^\infty \frac{\log^2 x}{(x+1)^2} dx$$

We can find  $I'(0)$  and  $I''(0)$  either by differentiating the expression for  $I(a)$  or by finding the first few terms in the Taylor series expansion of  $I(a)$  about  $a = 0$ . The latter approach is a little easier.

$$I(a) = \sum_{n=0}^{\infty} \frac{I^{(n)}(0)}{n!} a^n$$

$$I(a) = \frac{\pi a}{\sin(\pi a)}$$

$$= \frac{\pi a}{\pi a - (\pi a)^3/6 + \mathcal{O}(a^5)}$$

$$= \frac{1}{1 - (\pi a)^2/6 + \mathcal{O}(a^4)}$$

$$= 1 + \frac{\pi^2 a^2}{6} + \mathcal{O}(a^4)$$

$$I'(0) = \int_0^\infty \frac{\log x}{(x+1)^2} dx = 0$$

$$I''(0) = \int_0^\infty \frac{\log^2 x}{(x+1)^2} dx = \frac{\pi^2}{3}$$



**Solution 13.27**

1. We consider the integral

$$I(a) = \int_0^{\infty} \frac{x^a}{1+x^2} dx.$$

To examine convergence, we split the domain of integration.

$$\int_0^{\infty} \frac{x^a}{1+x^2} dx = \int_0^1 \frac{x^a}{1+x^2} dx + \int_1^{\infty} \frac{x^a}{1+x^2} dx$$

First we work with the integral on  $(0 \dots 1)$ .

$$\begin{aligned} \left| \int_0^1 \frac{x^a}{1+x^2} dx \right| &\leq \int_0^1 \left| \frac{x^a}{1+x^2} \right| |dx| \\ &= \int_0^1 \frac{x^{\Re(a)}}{1+x^2} dx \\ &\leq \int_0^1 x^{\Re(a)} dx \end{aligned}$$

This integral converges for  $\Re(a) > -1$ .

Next we work with the integral on  $(1 \dots \infty)$ .

$$\begin{aligned} \left| \int_1^{\infty} \frac{x^a}{1+x^2} dx \right| &\leq \int_1^{\infty} \left| \frac{x^a}{1+x^2} \right| |dx| \\ &= \int_1^{\infty} \frac{x^{\Re(a)}}{1+x^2} dx \\ &\leq \int_1^{\infty} x^{\Re(a)-2} dx \end{aligned}$$

This integral converges for  $\Re(a) < 1$ .

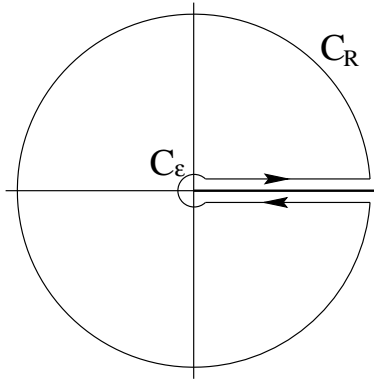

Figure 13.11:

Thus we see that the integral defining  $I(a)$  converges in the strip,  $-1 < \Re(a) < 1$ . The integral converges uniformly in any closed subset of this domain. Uniform convergence means that we can differentiate the integral with respect to  $a$  and interchange the order of integration and differentiation.

$$I'(a) = \int_0^{\infty} \frac{x^a \log x}{1+x^2} dx$$

Thus we see that  $I(a)$  is analytic for  $-1 < \Re(a) < 1$ .

- For  $-1 < \Re(a) < 1$  and  $a \neq 0$ ,  $z^a$  is multi-valued. Consider the branch of the function  $f(z) = z^a/(1+z^2)$  with a branch cut on the positive real axis and  $0 < \arg(z) < 2\pi$ . We integrate along the contour in Figure 13.11.

The integral on  $C_\rho$  vanishes as  $\rho \rightarrow 0$ . We show this with the maximum modulus integral bound. First we write

$z^a$  in modulus-argument form, where  $z = \rho e^{i\theta}$  and  $a = \alpha + i\beta$ .

$$\begin{aligned} z^a &= e^{a \log z} \\ &= e^{(\alpha+i\beta)(\log \rho+i\theta)} \\ &= e^{\alpha \log \rho - \beta\theta + i(\beta \log \rho + \alpha\theta)} \\ &= \rho^\alpha e^{-\beta\theta} e^{i(\beta \log \rho + \alpha\theta)} \end{aligned}$$

Now we bound the integral.

$$\begin{aligned} \left| \int_{C_\rho} \frac{z^a}{1+z^2} dz \right| &\leq 2\pi\rho \max_{z \in C_\rho} \left| \frac{z^a}{1+z^2} \right| \\ &\leq 2\pi\rho \frac{\rho^\alpha e^{2\pi|\beta|}}{1-\rho^2} \\ &\rightarrow 0 \text{ as } \rho \rightarrow 0 \end{aligned}$$

The integral on  $C_R$  vanishes as  $R \rightarrow \infty$ .

$$\begin{aligned} \left| \int_{C_R} \frac{z^a}{1+z^2} dz \right| &\leq 2\pi R \max_{z \in C_R} \left| \frac{z^a}{1+z^2} \right| \\ &\leq 2\pi R \frac{R^\alpha e^{2\pi|\beta|}}{R^2-1} \\ &\rightarrow 0 \text{ as } R \rightarrow \infty \end{aligned}$$

Above the branch cut, ( $z = r e^{i0}$ ), the integrand is

$$f(r e^{i0}) = \frac{r^a}{1+r^2}.$$

Below the branch cut, ( $z = r e^{i2\pi}$ ), we have,

$$f(r e^{i2\pi}) = \frac{e^{i2\pi a} r^a}{1 + r^2}.$$

Now we use the residue theorem.

$$\begin{aligned} \int_0^\infty \frac{r^a}{1+r^2} dr + \int_\infty^0 \frac{e^{i2\pi a} r^a}{1+r^2} dr &= i2\pi \left( \operatorname{Res} \left( \frac{z^a}{1+z^2}, i \right) + \operatorname{Res} \left( \frac{z^a}{1+z^2}, -i \right) \right) \\ (1 - e^{i2\pi a}) \int_0^\infty \frac{x^a}{1+x^2} dx &= i2\pi \left( \lim_{z \rightarrow i} \frac{z^a}{z+i} + \lim_{z \rightarrow -i} \frac{z^a}{z-i} \right) \\ (1 - e^{i2\pi a}) \int_0^\infty \frac{x^a}{1+x^2} dx &= i2\pi \left( \frac{e^{ia\pi/2}}{i2} + \frac{e^{i3\pi/2}}{-i2} \right) \\ \int_0^\infty \frac{x^a}{1+x^2} dx &= \pi \frac{e^{ia\pi/2} - e^{i3\pi/2}}{1 - e^{i2a\pi}} \\ \int_0^\infty \frac{x^a}{1+x^2} dx &= \pi \frac{e^{ia\pi/2}(1 - e^{ia\pi})}{(1 + e^{ia\pi})(1 - e^{ia\pi})} \\ \int_0^\infty \frac{x^a}{1+x^2} dx &= \frac{\pi}{e^{-ia\pi/2} + e^{ia\pi/2}} \\ \int_0^\infty \frac{x^a}{1+x^2} dx &= \frac{\pi}{2 \cos(\pi a/2)} \quad \text{for } -1 < \Re(a) < 1, a \neq 0 \end{aligned}$$

We use analytic continuation to extend the answer to  $a = 0$ .

$$I(a) = \int_0^\infty \frac{x^a}{1+x^2} dx = \frac{\pi}{2 \cos(\pi a/2)} \quad \text{for } -1 < \Re(a) < 1$$

3. We can derive the last two integrals by differentiating this formula with respect to  $a$  and taking the limit  $a \rightarrow 0$ .

$$I'(a) = \int_0^\infty \frac{x^a \log x}{1+x^2} dx, \quad I''(a) = \int_0^\infty \frac{x^a \log^2 x}{1+x^2} dx$$

$$I'(0) = \int_0^\infty \frac{\log x}{1+x^2} dx, \quad I''(0) = \int_0^\infty \frac{\log^2 x}{1+x^2} dx$$

We can find  $I'(0)$  and  $I''(0)$  either by differentiating the expression for  $I(a)$  or by finding the first few terms in the Taylor series expansion of  $I(a)$  about  $a = 0$ . The latter approach is a little easier.

$$I(a) = \sum_{n=0}^{\infty} \frac{I^{(n)}(0)}{n!} a^n$$

$$\begin{aligned} I(a) &= \frac{\pi}{2 \cos(\pi a/2)} \\ &= \frac{\pi}{2} \frac{1}{1 - (\pi a/2)^2/2 + \mathcal{O}(a^4)} \\ &= \frac{\pi}{2} (1 + (\pi a/2)^2/2 + \mathcal{O}(a^4)) \\ &= \frac{\pi}{2} + \frac{\pi^3/8}{2} a^2 + \mathcal{O}(a^4) \end{aligned}$$

$$I'(0) = \int_0^\infty \frac{\log x}{1+x^2} dx = 0$$

$$I''(0) = \int_0^\infty \frac{\log^2 x}{1+x^2} dx = \frac{\pi^3}{8}$$

### Solution 13.28

**Convergence.** If  $x^a f(x) \ll x^\alpha$  as  $x \rightarrow 0$  for some  $\alpha > -1$  then the integral

$$\int_0^1 x^a f(x) dx$$

will converge absolutely. If  $x^a f(x) \ll x^\beta$  as  $x \rightarrow \infty$  for some  $\beta < -1$  then the integral

$$\int_1^\infty x^a f(x)$$

will converge absolutely. These are sufficient conditions for the absolute convergence of

$$\int_0^\infty x^a f(x) dx.$$

**Contour Integration.** We put a branch cut on the positive real axis and choose  $0 < \arg(z) < 2\pi$ . We consider the integral of  $z^a f(z)$  on the contour in Figure ???. Let the singularities of  $f(z)$  occur at  $z_1, \dots, z_n$ . By the residue theorem,

$$\int_C z^a f(z) dz = i2\pi \sum_{k=1}^n \text{Res}(z^a f(z), z_k).$$

On the circle of radius  $\epsilon$ , the integrand is  $o(\epsilon^{-1})$ . Since the length of  $C_\epsilon$  is  $2\pi\epsilon$ , the integral on  $C_\epsilon$  vanishes as  $\epsilon \rightarrow 0$ . On the circle of radius  $R$ , the integrand is  $o(R^{-1})$ . Since the length of  $C_R$  is  $2\pi R$ , the integral on  $C_R$  vanishes as  $R \rightarrow \infty$ .

The value of the integrand below the branch cut,  $z = x e^{i2\pi}$ , is

$$f(x e^{i2\pi}) = x^a e^{i2\pi a} f(x)$$

In the limit as  $\epsilon \rightarrow 0$  and  $R \rightarrow \infty$  we have

$$\int_0^\infty x^a f(x) dx + \int_{-\infty}^0 x^a e^{i2\pi a} f(x) dx = i2\pi \sum_{k=1}^n \text{Res}(z^a f(z), z_k).$$

$$\int_0^{\infty} x^a f(x) dx = \frac{i2\pi}{1 - e^{i2\pi a}} \sum_{k=1}^n \operatorname{Res}(z^a f(z), z_k).$$

### Solution 13.29

In the interval of uniform convergence of the integral, we can differentiate the formula

$$\int_0^{\infty} x^a f(x) dx = \frac{i2\pi}{1 - e^{i2\pi a}} \sum_{k=1}^n \operatorname{Res}(z^a f(z), z_k),$$

with respect to  $a$  to obtain,

$$\int_0^{\infty} x^a f(x) \log x dx = \frac{i2\pi}{1 - e^{i2\pi a}} \sum_{k=1}^n \operatorname{Res}(z^a f(z) \log z, z_k), - \frac{4\pi^2 a e^{i2\pi a}}{(1 - e^{i2\pi a})^2} \sum_{k=1}^n \operatorname{Res}(z^a f(z), z_k).$$

$$\int_0^{\infty} x^a f(x) \log x dx = \frac{i2\pi}{1 - e^{i2\pi a}} \sum_{k=1}^n \operatorname{Res}(z^a f(z) \log z, z_k), + \frac{\pi^2 a}{\sin^2(\pi a)} \sum_{k=1}^n \operatorname{Res}(z^a f(z), z_k),$$

Differentiating the solution of Exercise 13.26  $m$  times with respect to  $a$  yields

$$\int_0^{\infty} x^a f(x) \log^m x dx = \frac{\partial^m}{\partial a^m} \left( \frac{i2\pi}{1 - e^{i2\pi a}} \sum_{k=1}^n \operatorname{Res}(z^a f(z), z_k) \right),$$

### Solution 13.30

Taking the limit as  $a \rightarrow 0 \in \mathbb{Z}$  in the solution of Exercise 13.26 yields

$$\int_0^{\infty} f(x) dx = i2\pi \lim_{a \rightarrow 0} \left( \frac{\sum_{k=1}^n \operatorname{Res}(z^a f(z), z_k)}{1 - e^{i2\pi a}} \right)$$

The numerator vanishes because the sum of all residues of  $z^n f(z)$  is zero. Thus we can use L'Hospital's rule.

$$\int_0^{\infty} f(x) dx = i2\pi \lim_{a \rightarrow 0} \left( \frac{\sum_{k=1}^n \operatorname{Res}(z^a f(z) \log z, z_k)}{-i2\pi e^{i2\pi a}} \right)$$

$$\int_0^{\infty} f(x) dx = - \sum_{k=1}^n \operatorname{Res}(f(z) \log z, z_k)$$

This suggests that we could have derived the result directly by considering the integral of  $f(z) \log z$  on the contour in Figure ???. We put a branch cut on the positive real axis and choose the branch  $\arg z = 0$ . Recall that we have assumed that  $f(z)$  has only isolated singularities and no singularities on the positive real axis,  $[0, \infty)$ . By the residue theorem,

$$\int_C f(z) \log z dz = i2\pi \sum_{k=1}^n \operatorname{Res}(f(z) \log z, z = z_k).$$

By assuming that  $f(z) \ll z^\alpha$  as  $z \rightarrow 0$  where  $\alpha > -1$  the integral on  $C_\epsilon$  will vanish as  $\epsilon \rightarrow 0$ . By assuming that  $f(z) \ll z^\beta$  as  $z \rightarrow \infty$  where  $\beta < -1$  the integral on  $C_R$  will vanish as  $R \rightarrow \infty$ . The value of the integrand below the branch cut,  $z = x e^{i2\pi}$  is  $f(x)(\log x + i2\pi)$ . Taking the limit as  $\epsilon \rightarrow 0$  and  $R \rightarrow \infty$ , we have

$$\int_0^{\infty} f(x) \log x dx + \int_{\infty}^0 f(x)(\log x + i2\pi) dx = i2\pi \sum_{k=1}^n \operatorname{Res}(f(z) \log z, z_k).$$

Thus we corroborate the result.

$$\int_0^{\infty} f(x) dx = - \sum_{k=1}^n \operatorname{Res}(f(z) \log z, z_k)$$

### Solution 13.31

Consider the integral of  $f(z) \log^2 z$  on the contour in Figure ??. We put a branch cut on the positive real axis and choose the branch  $0 < \arg z < 2\pi$ . Let  $z_1, \dots, z_n$  be the singularities of  $f(z)$ . By the residue theorem,

$$\int_C f(z) \log^2 z dz = i2\pi \sum_{k=1}^n \operatorname{Res}(f(z) \log^2 z, z_k).$$

If  $f(z) \ll z^\alpha$  as  $z \rightarrow 0$  for some  $\alpha > -1$  then the integral on  $C_\epsilon$  will vanish as  $\epsilon \rightarrow 0$ .  $f(z) \ll z^\beta$  as  $z \rightarrow \infty$  for some  $\beta < -1$  then the integral on  $C_R$  will vanish as  $R \rightarrow \infty$ . Below the branch cut the integrand is  $f(x)(\log x + i2\pi)^2$ .



Thus we have

$$\int_0^{\infty} f(x) \log^2 x \, dx + \int_{\infty}^0 f(x) (\log^2 x + i4\pi \log x - 4\pi^2) \, dx = i2\pi \sum_{k=1}^n \operatorname{Res}(f(z) \log^2 z, z_k).$$

$$-i4\pi \int_0^{\infty} f(x) \log x \, dx + 4\pi^2 \int_0^{\infty} f(x) \, dx = i2\pi \sum_{k=1}^n \operatorname{Res}(f(z) \log^2 z, z_k).$$

$$\boxed{\int_0^{\infty} f(x) \log x \, dx = -\frac{1}{2} \sum_{k=1}^n \operatorname{Res}(f(z) \log^2 z, z_k) + i\pi \sum_{k=1}^n \operatorname{Res}(f(z) \log z, z_k)}$$

### Solution 13.32

**Convergence.** We consider

$$\int_0^{\infty} \frac{x^a}{1+x^4} \, dx.$$

Since the integrand behaves like  $x^a$  near  $x = 0$  we must have  $\Re(a) > -1$ . Since the integrand behaves like  $x^{a-4}$  at infinity we must have  $\Re(a-4) < -1$ . The integral converges for  $-1 < \Re(a) < 3$ .

**Contour Integration.** The function

$$f(z) = \frac{z^a}{1+z^4}$$

has first order poles at  $z = (\pm 1 \pm i)/\sqrt{2}$  and a branch point at  $z = 0$ . We could evaluate the real integral by putting a branch cut on the positive real axis with  $0 < \arg(z) < 2\pi$  and integrating  $f(z)$  on the contour in Figure 13.12.

Integrating on this contour would work because the value of the integrand below the branch cut is a constant times the value of the integrand above the branch cut. After demonstrating that the integrals along  $C_\epsilon$  and  $C_R$  vanish in the limits as  $\epsilon \rightarrow 0$  and  $R \rightarrow \infty$  we would see that the value of the integral is a constant times the sum of the residues at the four poles. However, this is not the only, (and not the best), contour that can be used to evaluate the real integral. Consider the value of the integral on the line  $\arg(z) = \theta$ .

$$f(re^{i\theta}) = \frac{r^a e^{ia\theta}}{1+r^4 e^{i4\theta}}$$

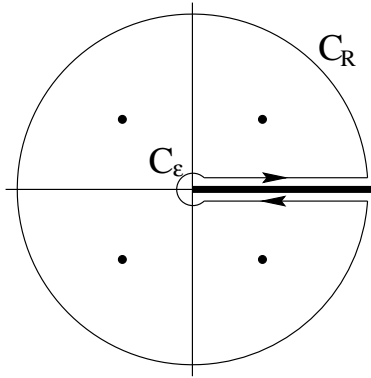

Figure 13.12: Possible path of integration for  $f(z) = \frac{z^a}{1+z^4}$

If  $\theta$  is a integer multiple of  $\pi/2$  then the integrand is a constant multiple of

$$f(x) = \frac{r^a}{1+r^4}.$$

Thus any of the contours in Figure 13.13 can be used to evaluate the real integral. The only difference is how many residues we have to calculate. Thus we choose the first contour in Figure 13.13. We put a branch cut on the negative real axis and choose the branch  $-\pi < \arg(z) < \pi$  to satisfy  $f(1) = 1$ .

We evaluate the integral along  $C$  with the Residue Theorem.

$$\int_C \frac{z^a}{1+z^4} dz = i2\pi \operatorname{Res} \left( \frac{z^a}{1+z^4}, z = \frac{1+i}{\sqrt{2}} \right)$$

Let  $a = \alpha + i\beta$  and  $z = r e^{i\theta}$ . Note that

$$|z^a| = |(r e^{i\theta})^{\alpha+i\beta}| = r^\alpha e^{-\beta\theta}.$$

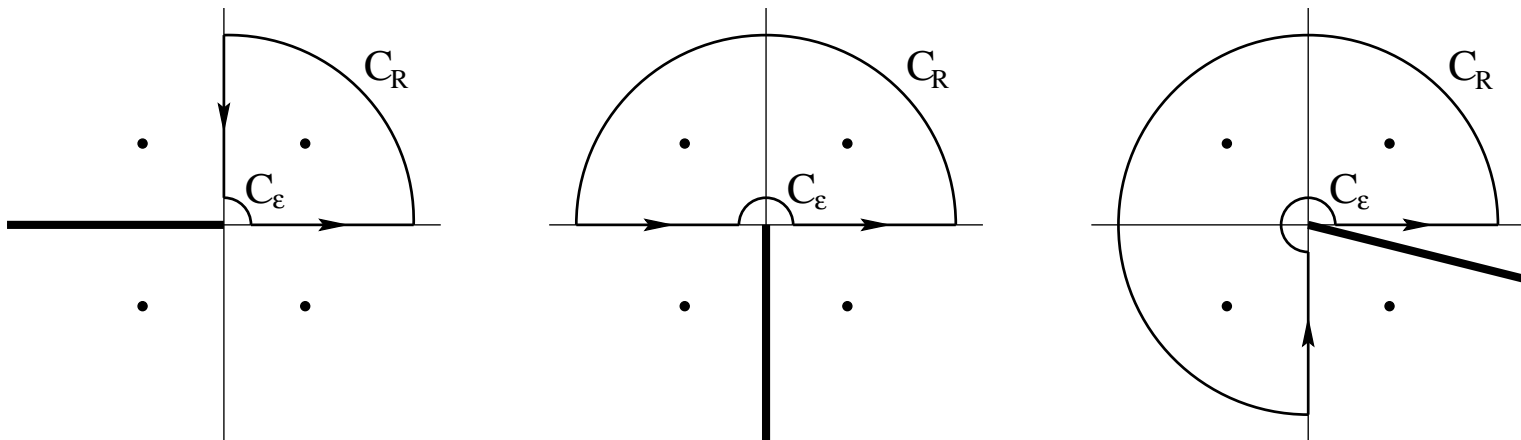

Figure 13.13: Possible Paths of Integration for  $f(z) = \frac{z^a}{1+z^4}$

The integral on  $C_\epsilon$  vanishes as  $\epsilon \rightarrow 0$ . We demonstrate this with the maximum modulus integral bound.

$$\begin{aligned} \left| \int_{C_\epsilon} \frac{z^a}{1+z^4} dz \right| &\leq \frac{\pi\epsilon}{2} \max_{z \in C_\epsilon} \left| \frac{z^a}{1+z^4} \right| \\ &\leq \frac{\pi\epsilon}{2} \frac{\epsilon^\alpha e^{\pi|\beta|/2}}{1-\epsilon^4} \\ &\rightarrow 0 \quad \text{as } \epsilon \rightarrow 0 \end{aligned}$$

The integral on  $C_R$  vanishes as  $R \rightarrow \infty$ .

$$\begin{aligned} \left| \int_{C_R} \frac{z^a}{1+z^4} dz \right| &\leq \frac{\pi R}{2} \max_{z \in C_R} \left| \frac{z^a}{1+z^4} \right| \\ &\leq \frac{\pi R}{2} \frac{R^\alpha e^{\pi|\beta|/2}}{R^4-1} \\ &\rightarrow 0 \quad \text{as } R \rightarrow \infty \end{aligned}$$

The value of the integrand on the positive imaginary axis,  $z = x e^{i\pi/2}$ , is

$$\frac{(x e^{i\pi/2})^a}{1 + (x e^{i\pi/2})^4} = \frac{x^a e^{i\pi a/2}}{1 + x^4}.$$

We take the limit as  $\epsilon \rightarrow 0$  and  $R \rightarrow \infty$ .

$$\begin{aligned} \int_0^\infty \frac{x^a}{1+x^4} dx + \int_\infty^0 \frac{x^a e^{i\pi a/2}}{1+x^4} e^{i\pi/2} dx &= i2\pi \operatorname{Res} \left( \frac{z^a}{1+z^4}, e^{i\pi/4} \right) \\ (1 - e^{i\pi(a+1)/2}) \int_0^\infty \frac{x^a}{1+x^4} dx &= i2\pi \lim_{z \rightarrow e^{i\pi/4}} \left( \frac{z^a(z - e^{i\pi/2})}{1+z^4} \right) \\ \int_0^\infty \frac{x^a}{1+x^4} dx &= \frac{i2\pi}{1 - e^{i\pi(a+1)/2}} \lim_{z \rightarrow e^{i\pi/4}} \left( \frac{az^a(z - e^{i\pi/2}) + z^a}{4z^3} \right) \\ \int_0^\infty \frac{x^a}{1+x^4} dx &= \frac{i2\pi}{1 - e^{i\pi(a+1)/2}} \frac{e^{i\pi a/4}}{4 e^{i3\pi/4}} \\ \int_0^\infty \frac{x^a}{1+x^4} dx &= \frac{-i\pi}{2(e^{-i\pi(a+1)/4} - e^{i\pi(a+1)/4})} \\ \boxed{\int_0^\infty \frac{x^a}{1+x^4} dx} &= \frac{\pi}{4} \operatorname{csc} \left( \frac{\pi(a+1)}{4} \right) \end{aligned}$$

### Solution 13.33

Consider the branch of  $f(z) = z^{1/2} \log z / (z+1)^2$  with a branch cut on the positive real axis and  $0 < \arg z < 2\pi$ . We integrate this function on the contour in Figure ??.

We use the maximum modulus integral bound to show that the integral on  $C_\rho$  vanishes as  $\rho \rightarrow 0$ .

$$\begin{aligned} \left| \int_{C_\rho} \frac{z^{1/2} \log z}{(z+1)^2} dz \right| &\leq 2\pi\rho \max_{C_\rho} \left| \frac{z^{1/2} \log z}{(z+1)^2} \right| \\ &= 2\pi\rho \frac{\rho^{1/2}(2\pi - \log \rho)}{(1-\rho)^2} \\ &\rightarrow 0 \text{ as } \rho \rightarrow 0 \end{aligned}$$

The integral on  $C_R$  vanishes as  $R \rightarrow \infty$ .

$$\begin{aligned} \left| \int_{C_R} \frac{z^{1/2} \log z}{(z+1)^2} dz \right| &\leq 2\pi R \max_{C_R} \left| \frac{z^{1/2} \log z}{(z+1)^2} \right| \\ &= 2\pi R \frac{R^{1/2}(\log R + 2\pi)}{(R-1)^2} \\ &\rightarrow 0 \text{ as } R \rightarrow \infty \end{aligned}$$

Above the branch cut, ( $z = x e^{i0}$ ), the integrand is,

$$f(x e^{i0}) = \frac{x^{1/2} \log x}{(x+1)^2}.$$

Below the branch cut, ( $z = x e^{i2\pi}$ ), we have,

$$f(x e^{i2\pi}) = \frac{-x^{1/2}(\log x + i\pi)}{(x+1)^2}.$$

Taking the limit as  $\rho \rightarrow 0$  and  $R \rightarrow \infty$ , the residue theorem gives us

$$\begin{aligned} \int_0^\infty \frac{x^{1/2} \log x}{(x+1)^2} dx + \int_\infty^0 \frac{-x^{1/2}(\log x + i2\pi)}{(x+1)^2} dx &= i2\pi \operatorname{Res} \left( \frac{z^{1/2} \log z}{(z+1)^2}, -1 \right). \\ 2 \int_0^\infty \frac{x^{1/2} \log x}{(x+1)^2} dx + i2\pi \int_0^\infty \frac{x^{1/2}}{(x+1)^2} dx &= i2\pi \lim_{z \rightarrow -1} \frac{d}{dz} (z^{1/2} \log z) \\ 2 \int_0^\infty \frac{x^{1/2} \log x}{(x+1)^2} dx + i2\pi \int_0^\infty \frac{x^{1/2}}{(x+1)^2} dx &= i2\pi \lim_{z \rightarrow -1} \left( \frac{1}{2} z^{-1/2} \log z + z^{1/2} \frac{1}{z} \right) \\ 2 \int_0^\infty \frac{x^{1/2} \log x}{(x+1)^2} dx + i2\pi \int_0^\infty \frac{x^{1/2}}{(x+1)^2} dx &= i2\pi \left( \frac{1}{2} (-i)(i\pi) - i \right) \end{aligned}$$

$$2 \int_0^\infty \frac{x^{1/2} \log x}{(x+1)^2} dx + i2\pi \int_0^\infty \frac{x^{1/2}}{(x+1)^2} dx = 2\pi + i\pi^2$$

Equating real and imaginary parts,

$$\boxed{\int_0^\infty \frac{x^{1/2} \log x}{(x+1)^2} dx = \pi, \quad \int_0^\infty \frac{x^{1/2}}{(x+1)^2} dx = \frac{\pi}{2}.}$$

## Exploiting Symmetry

### Solution 13.34

**Convergence.** The integrand,

$$\frac{e^{az}}{e^z - e^{-z}} = \frac{e^{az}}{2 \sinh(z)},$$

has first order poles at  $z = n\pi$ ,  $n \in \mathbb{Z}$ . To study convergence, we split the domain of integration.

$$\int_{-\infty}^\infty = \int_{-\infty}^{-1} + \int_{-1}^1 + \int_1^\infty$$

The principal value integral

$$\int_{-1}^1 \frac{e^{ax}}{e^x - e^{-x}} dx$$

exists for any  $a$  because the integrand has only a first order pole on the path of integration.

Now consider the integral on  $(1 \dots \infty)$ .

$$\begin{aligned} \left| \int_1^\infty \frac{e^{ax}}{e^x - e^{-x}} dx \right| &= \int_1^\infty \frac{e^{(a-1)x}}{1 - e^{-2x}} dx \\ &\leq \frac{1}{1 - e^{-2}} \int_1^\infty e^{(a-1)x} dx \end{aligned}$$

This integral converges for  $a - 1 < 0$ ;  $a < 1$ .

Finally consider the integral on  $(-\infty \dots -1)$ .

$$\begin{aligned} \left| \int_{-\infty}^{-1} \frac{e^{ax}}{e^x - e^{-x}} dx \right| &= \int_{-\infty}^{-1} \frac{e^{(a+1)x}}{1 - e^{2x}} dx \\ &\leq \frac{1}{1 - e^{-2}} \int_{-\infty}^{-1} e^{(a+1)x} dx \end{aligned}$$

This integral converges for  $a + 1 > 0$ ;  $a > -1$ .

Thus we see that the integral for  $I(a)$  converges for real  $a$ ,  $|a| < 1$ .

**Choice of Contour.** Consider the contour  $C$  that is the boundary of the region:  $-R < x < R$ ,  $0 < y < \pi$ . The integrand has no singularities inside the contour. There are first order poles on the contour at  $z = 0$  and  $z = i\pi$ . The value of the integral along the contour is  $i\pi$  times the sum of these two residues.

The integrals along the vertical sides of the contour vanish as  $R \rightarrow \infty$ .

$$\begin{aligned} \left| \int_R^{R+i\pi} \frac{e^{az}}{e^z - e^{-z}} dz \right| &\leq \pi \max_{z \in (R \dots R+i\pi)} \left| \frac{e^{az}}{e^z - e^{-z}} \right| \\ &\leq \pi \frac{e^{aR}}{e^R - e^{-R}} \\ &\rightarrow 0 \text{ as } R \rightarrow \infty \end{aligned}$$

$$\begin{aligned} \left| \int_{-R}^{-R+i\pi} \frac{e^{az}}{e^z - e^{-z}} dz \right| &\leq \pi \max_{z \in (-R \dots -R+i\pi)} \left| \frac{e^{az}}{e^z - e^{-z}} \right| \\ &\leq \pi \frac{e^{-aR}}{e^{-R} - e^R} \\ &\rightarrow 0 \text{ as } R \rightarrow \infty \end{aligned}$$

**Evaluating the Integral.** We take the limit as  $R \rightarrow \infty$  and apply the residue theorem.

$$\int_{-\infty}^{\infty} \frac{e^{ax}}{e^x - e^{-x}} dx + \int_{\infty+i\pi}^{-\infty+i\pi} \frac{e^{az}}{e^z - e^{-z}} dz = i\pi \operatorname{Res} \left( \frac{e^{az}}{e^z - e^{-z}}, z = 0 \right) + i\pi \operatorname{Res} \left( \frac{e^{az}}{e^z - e^{-z}}, z = i\pi \right)$$

$$\int_{-\infty}^{\infty} \frac{e^{ax}}{e^x - e^{-x}} dx + \int_{\infty}^{-\infty} \frac{e^{a(x+i\pi)}}{e^{x+i\pi} - e^{-x-i\pi}} dz = i\pi \lim_{z \rightarrow 0} \frac{z e^{az}}{2 \sinh(z)} + i\pi \lim_{z \rightarrow i\pi} \frac{(z - i\pi) e^{az}}{2 \sinh(z)}$$

$$(1 + e^{ia\pi}) \int_{-\infty}^{\infty} \frac{e^{ax}}{e^x - e^{-x}} dx = i\pi \lim_{z \rightarrow 0} \frac{e^{az} + az e^{az}}{2 \cosh(z)} + i\pi \lim_{z \rightarrow i\pi} \frac{e^{az} + a(z - i\pi) e^{az}}{2 \cosh(z)}$$

$$(1 + e^{ia\pi}) \int_{-\infty}^{\infty} \frac{e^{ax}}{e^x - e^{-x}} dx = i\pi \frac{1}{2} + i\pi \frac{e^{ia\pi}}{-2}$$

$$\int_{-\infty}^{\infty} \frac{e^{ax}}{e^x - e^{-x}} dx = \frac{i\pi(1 - e^{ia\pi})}{2(1 + e^{ia\pi})}$$

$$\int_{-\infty}^{\infty} \frac{e^{ax}}{e^x - e^{-x}} dx = \frac{\pi i(e^{-ia\pi/2} - e^{ia\pi/2})}{2(e^{ia\pi/2} + e^{-ia\pi/2})}$$

$$\boxed{\int_{-\infty}^{\infty} \frac{e^{ax}}{e^x - e^{-x}} dx = \frac{\pi}{2} \tan\left(\frac{a\pi}{2}\right)}$$

### Solution 13.35

1.

$$\int_0^{\infty} \frac{dx}{(1+x^2)^2} = \frac{1}{2} \int_{-\infty}^{\infty} \frac{dx}{(1+x^2)^2}$$

We apply Result 13.4.1 to the integral on the real axis. First we verify that the integrand vanishes fast enough in the upper half plane.

$$\lim_{R \rightarrow \infty} \left( R \max_{z \in C_R} \left| \frac{1}{(1+z^2)^2} \right| \right) = \lim_{R \rightarrow \infty} \left( R \frac{1}{(R^2 - 1)^2} \right) = 0$$



Then we evaluate the integral with the residue theorem.

$$\begin{aligned}
 \int_{-\infty}^{\infty} \frac{dx}{(1+x^2)^2} &= i2\pi \operatorname{Res} \left( \frac{1}{(1+z^2)^2}, z=i \right) \\
 &= i2\pi \operatorname{Res} \left( \frac{1}{(z-i)^2(z+i)^2}, z=i \right) \\
 &= i2\pi \lim_{z \rightarrow i} \frac{d}{dz} \frac{1}{(z+i)^2} \\
 &= i2\pi \lim_{z \rightarrow i} \frac{-2}{(z+i)^3} \\
 &= \frac{\pi}{2}
 \end{aligned}$$

$$\boxed{\int_0^{\infty} \frac{dx}{(1+x^2)^2} = \frac{\pi}{4}}$$

2. We wish to evaluate

$$\int_0^{\infty} \frac{dx}{x^3+1}.$$

Let the contour  $C$  be the boundary of the region  $0 < r < R$ ,  $0 < \theta < 2\pi/3$ . We factor the denominator of the integrand to see that the contour encloses the simple pole at  $e^{i\pi/3}$  for  $R > 1$ .

$$z^3 + 1 = (z - e^{i\pi/3})(z + 1)(z - e^{-i\pi/3})$$

We calculate the residue at that point.

$$\begin{aligned}
 \operatorname{Res}\left(\frac{1}{z^3+1}, z = e^{i\pi/3}\right) &= \lim_{z \rightarrow e^{i\pi/3}} \left( (z - e^{i\pi/3}) \frac{1}{z^3+1} \right) \\
 &= \lim_{z \rightarrow e^{i\pi/3}} \left( \frac{1}{(z+1)(z - e^{-i\pi/3})} \right) \\
 &= \frac{1}{(e^{i\pi/3}+1)(e^{i\pi/3} - e^{-i\pi/3})} \\
 &= -\frac{e^{i\pi/3}}{3}
 \end{aligned}$$

We use the residue theorem to evaluate the integral.

$$\oint_C \frac{dz}{z^3+1} = -\frac{i2\pi e^{i\pi/3}}{3}$$

Let  $C_R$  be the circular arc portion of the contour.

$$\begin{aligned}
 \int_C \frac{dz}{z^3+1} &= \int_0^R \frac{dx}{x^3+1} + \int_{C_R} \frac{dz}{z^3+1} - \int_0^R \frac{e^{i2\pi/3} dx}{x^3+1} \\
 &= (1 + e^{-i\pi/3}) \int_0^R \frac{dx}{x^3+1} + \int_{C_R} \frac{dz}{z^3+1}
 \end{aligned}$$

We show that the integral along  $C_R$  vanishes as  $R \rightarrow \infty$  with the maximum modulus integral bound.

$$\left| \int_{C_R} \frac{dz}{z^3+1} \right| \leq \frac{2\pi R}{3} \frac{1}{R^3-1} \rightarrow 0 \quad \text{as } R \rightarrow \infty$$

We take  $R \rightarrow \infty$  and solve for the desired integral.

$$\begin{aligned}
 (1 + e^{-i\pi/3}) \int_0^\infty \frac{dx}{x^3+1} &= -\frac{i2\pi e^{i\pi/3}}{3} \\
 \int_0^\infty \frac{dx}{x^3+1} &= \frac{2\pi}{3\sqrt{3}}
 \end{aligned}$$

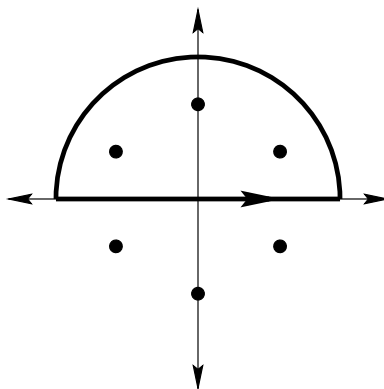

Figure 13.14: The semi-circle contour.

### Solution 13.36

**Method 1: Semi-Circle Contour.** We wish to evaluate the integral

$$I = \int_0^{\infty} \frac{dx}{1+x^6}.$$

We note that the integrand is an even function and express  $I$  as an integral over the whole real axis.

$$I = \frac{1}{2} \int_{-\infty}^{\infty} \frac{dx}{1+x^6}$$

Now we will evaluate the integral using contour integration. We close the path of integration in the upper half plane. Let  $\Gamma_R$  be the semicircular arc from  $R$  to  $-R$  in the upper half plane. Let  $\Gamma$  be the union of  $\Gamma_R$  and the interval  $[-R, R]$ . (See Figure 13.14.)

We can evaluate the integral along  $\Gamma$  with the residue theorem. The integrand has first order poles at  $z = e^{i\pi(1+2k)/6}$ ,

$k = 0, 1, 2, 3, 4, 5$ . Three of these poles are in the upper half plane. For  $R > 1$ , we have

$$\begin{aligned} \int_{\Gamma} \frac{1}{z^6 + 1} dz &= i2\pi \sum_{k=0}^2 \operatorname{Res} \left( \frac{1}{z^6 + 1}, e^{i\pi(1+2k)/6} \right) \\ &= i2\pi \sum_{k=0}^2 \lim_{z \rightarrow e^{i\pi(1+2k)/6}} \frac{z - e^{i\pi(1+2k)/6}}{z^6 + 1} \end{aligned}$$

Since the numerator and denominator vanish, we apply L'Hospital's rule.

$$\begin{aligned} &= i2\pi \sum_{k=0}^2 \lim_{z \rightarrow e^{i\pi(1+2k)/6}} \frac{1}{6z^5} \\ &= \frac{i\pi}{3} \sum_{k=0}^2 e^{-i\pi 5(1+2k)/6} \\ &= \frac{i\pi}{3} (e^{-i\pi 5/6} + e^{-i\pi 15/6} + e^{-i\pi 25/6}) \\ &= \frac{i\pi}{3} (e^{-i\pi 5/6} + e^{-i\pi/2} + e^{-i\pi/6}) \\ &= \frac{i\pi}{3} \left( \frac{-\sqrt{3} - i}{2} - i + \frac{\sqrt{3} - i}{2} \right) \\ &= \frac{2\pi}{3} \end{aligned}$$

Now we examine the integral along  $\Gamma_R$ . We use the maximum modulus integral bound to show that the value of the

integral vanishes as  $R \rightarrow \infty$ .

$$\begin{aligned} \left| \int_{\Gamma_R} \frac{1}{z^6 + 1} dz \right| &\leq \pi R \max_{z \in \Gamma_R} \left| \frac{1}{z^6 + 1} \right| \\ &= \pi R \frac{1}{R^6 - 1} \\ &\rightarrow 0 \quad \text{as } R \rightarrow \infty. \end{aligned}$$

Now we are prepared to evaluate the original real integral.

$$\begin{aligned} \int_{\Gamma} \frac{1}{z^6 + 1} dz &= \frac{2\pi}{3} \\ \int_{-R}^R \frac{1}{x^6 + 1} dx + \int_{\Gamma_R} \frac{1}{z^6 + 1} dz &= \frac{2\pi}{3} \end{aligned}$$

We take the limit as  $R \rightarrow \infty$ .

$$\begin{aligned} \int_{-\infty}^{\infty} \frac{1}{x^6 + 1} dx &= \frac{2\pi}{3} \\ \int_0^{\infty} \frac{1}{x^6 + 1} dx &= \frac{\pi}{3} \end{aligned}$$

We would get the same result by closing the path of integration in the lower half plane. Note that in this case the closed contour would be in the negative direction.

**Method 2: Wedge Contour.** Consider the contour  $\Gamma$ , which starts at the origin, goes to the point  $R$  along the real axis, then to the point  $R e^{i\pi/3}$  along a circle of radius  $R$  and then back to the origin along the ray  $\theta = \pi/3$ . (See Figure 13.15.)

We can evaluate the integral along  $\Gamma$  with the residue theorem. The integrand has one first order pole inside the

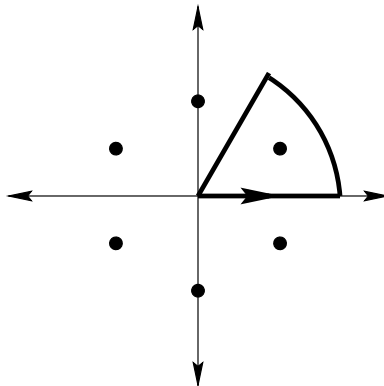

Figure 13.15: The wedge contour.

contour at  $z = e^{i\pi/6}$ . For  $R > 1$ , we have

$$\begin{aligned} \int_{\Gamma} \frac{1}{z^6 + 1} dz &= i2\pi \operatorname{Res} \left( \frac{1}{z^6 + 1}, e^{i\pi/6} \right) \\ &= i2\pi \lim_{z \rightarrow e^{i\pi/6}} \frac{z - e^{i\pi/6}}{z^6 + 1} \end{aligned}$$

Since the numerator and denominator vanish, we apply L'Hospital's rule.

$$\begin{aligned} &= i2\pi \lim_{z \rightarrow e^{i\pi/6}} \frac{1}{6z^5} \\ &= \frac{i\pi}{3} e^{-i\pi 5/6} \\ &= \frac{\pi}{3} e^{-i\pi/3} \end{aligned}$$

Now we examine the integral along the circular arc,  $\Gamma_R$ . We use the maximum modulus integral bound to show that

the value of the integral vanishes as  $R \rightarrow \infty$ .

$$\begin{aligned} \left| \int_{\Gamma_R} \frac{1}{z^6 + 1} dz \right| &\leq \frac{\pi R}{3} \max_{z \in \Gamma_R} \left| \frac{1}{z^6 + 1} \right| \\ &= \frac{\pi R}{3} \frac{1}{R^6 - 1} \\ &\rightarrow 0 \quad \text{as } R \rightarrow \infty. \end{aligned}$$

Now we are prepared to evaluate the original real integral.

$$\begin{aligned} \int_0^R \frac{1}{x^6 + 1} dx + \int_{\Gamma_R} \frac{1}{z^6 + 1} dz + \int_{R e^{i\pi/3}}^0 \frac{1}{z^6 + 1} dz &= \frac{\pi}{3} e^{-i\pi/3} \\ \int_0^R \frac{1}{x^6 + 1} dx + \int_{\Gamma_R} \frac{1}{z^6 + 1} dz + \int_R^0 \frac{1}{x^6 + 1} e^{i\pi/3} dx &= \frac{\pi}{3} e^{-i\pi/3} \end{aligned}$$

We take the limit as  $R \rightarrow \infty$ .

$$\begin{aligned} (1 - e^{i\pi/3}) \int_0^\infty \frac{1}{x^6 + 1} dx &= \frac{\pi}{3} e^{-i\pi/3} \\ \int_0^\infty \frac{1}{x^6 + 1} dx &= \frac{\pi}{3} \frac{e^{-i\pi/3}}{1 - e^{i\pi/3}} \\ \int_0^\infty \frac{1}{x^6 + 1} dx &= \frac{\pi}{3} \frac{(1 - i\sqrt{3})/2}{1 - (1 + i\sqrt{3})/2} \\ \int_0^\infty \frac{1}{x^6 + 1} dx &= \frac{\pi}{3} \end{aligned}$$

### Solution 13.37

First note that

$$\cos(2\theta) \geq 1 - \frac{4}{\pi}\theta, \quad 0 \leq \theta \leq \frac{\pi}{4}.$$

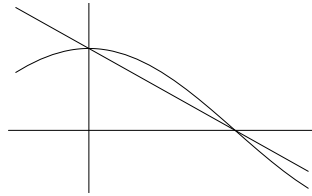

Figure 13.16:  $\cos(2\theta)$  and  $1 - \frac{4}{\pi}\theta$

These two functions are plotted in Figure 13.16. To prove this inequality analytically, note that the two functions are equal at the endpoints of the interval and that  $\cos(2\theta)$  is concave downward on the interval,

$$\frac{d^2}{d\theta^2} \cos(2\theta) = -4 \cos(2\theta) \leq 0 \quad \text{for } 0 \leq \theta \leq \frac{\pi}{4},$$

while  $1 - 4\theta/\pi$  is linear.

Let  $C_R$  be the quarter circle of radius  $R$  from  $\theta = 0$  to  $\theta = \pi/4$ . The integral along this contour vanishes as  $R \rightarrow \infty$ .

$$\begin{aligned} \left| \int_{C_R} e^{-z^2} dz \right| &\leq \int_0^{\pi/4} \left| e^{-(Re^{i\theta})^2} \right| |Ri e^{i\theta}| d\theta \\ &\leq \int_0^{\pi/4} R e^{-R^2 \cos(2\theta)} d\theta \\ &\leq \int_0^{\pi/4} R e^{-R^2(1-4\theta/\pi)} d\theta \\ &= \left[ R \frac{\pi}{4R^2} e^{-R^2(1-4\theta/\pi)} \right]_0^{\pi/4} \\ &= \frac{\pi}{4R} (1 - e^{-R^2}) \\ &\rightarrow 0 \text{ as } R \rightarrow \infty \end{aligned}$$



Let  $C$  be the boundary of the domain  $0 < r < R$ ,  $0 < \theta < \pi/4$ . Since the integrand is analytic inside  $C$  the integral along  $C$  is zero. Taking the limit as  $R \rightarrow \infty$ , the integral from  $r = 0$  to  $\infty$  along  $\theta = 0$  is equal to the integral from  $r = 0$  to  $\infty$  along  $\theta = \pi/4$ .

$$\int_0^\infty e^{-x^2} dx = \int_0^\infty e^{-\left(\frac{1+i}{\sqrt{2}}x\right)^2} \frac{1+i}{\sqrt{2}} dx$$

$$\int_0^\infty e^{-x^2} dx = \frac{1+i}{\sqrt{2}} \int_0^\infty e^{-ix^2} dx$$

$$\int_0^\infty e^{-x^2} dx = \frac{1+i}{\sqrt{2}} \int_0^\infty (\cos(x^2) - i \sin(x^2)) dx$$

$$\int_0^\infty e^{-x^2} dx = \frac{1}{\sqrt{2}} \left( \int_0^\infty \cos(x^2) dx + \int_0^\infty \sin(x^2) dx \right) + \frac{i}{\sqrt{2}} \left( \int_0^\infty \cos(x^2) dx - \int_0^\infty \sin(x^2) dx \right)$$

We equate the imaginary part of this equation to see that the integrals of  $\cos(x^2)$  and  $\sin(x^2)$  are equal.

$$\int_0^\infty \cos(x^2) dx = \int_0^\infty \sin(x^2) dx$$

The real part of the equation then gives us the desired identity.

$$\boxed{\int_0^\infty \cos(x^2) dx = \int_0^\infty \sin(x^2) dx = \frac{1}{\sqrt{2}} \int_0^\infty e^{-x^2} dx}$$

### Solution 13.38

Consider the box contour  $C$  that is the boundary of the rectangle  $-R \leq x \leq R$ ,  $0 \leq y \leq \pi$ . There is a removable

singularity at  $z = 0$  and a first order pole at  $z = i\pi$ . By the residue theorem,

$$\begin{aligned} \int_C \frac{z}{\sinh z} dz &= i\pi \operatorname{Res} \left( \frac{z}{\sinh z}, i\pi \right) \\ &= i\pi \lim_{z \rightarrow i\pi} \frac{z(z - i\pi)}{\sinh z} \\ &= i\pi \lim_{z \rightarrow i\pi} \frac{2z - i\pi}{\cosh z} \\ &= \pi^2 \end{aligned}$$

The integrals along the side of the box vanish as  $R \rightarrow \infty$ .

$$\begin{aligned} \left| \int_{\pm R}^{\pm R + i\pi} \frac{z}{\sinh z} dz \right| &\leq \pi \max_{z \in [\pm R, \pm R + i\pi]} \left| \frac{z}{\sinh z} \right| \\ &\leq \pi \frac{R + \pi}{\sinh R} \\ &\rightarrow 0 \text{ as } R \rightarrow \infty \end{aligned}$$

The value of the integrand on the top of the box is

$$\frac{x + i\pi}{\sinh(x + i\pi)} = -\frac{x + i\pi}{\sinh x}.$$

Taking the limit as  $R \rightarrow \infty$ ,

$$\int_{-\infty}^{\infty} \frac{x}{\sinh x} dx + \int_{-\infty}^{\infty} -\frac{x + i\pi}{\sinh x} dx = \pi^2.$$

Note that

$$\int_{-\infty}^{\infty} \frac{1}{\sinh x} dx = 0$$

as there is a first order pole at  $x = 0$  and the integrand is odd.

$$\boxed{\int_{-\infty}^{\infty} \frac{x}{\sinh x} dx = \frac{\pi^2}{2}}$$

### Solution 13.39

First we evaluate

$$\int_{-\infty}^{\infty} \frac{e^{ax}}{e^x + 1} dx.$$

Consider the rectangular contour in the positive direction with corners at  $\pm R$  and  $\pm R + i2\pi$ . With the maximum modulus integral bound we see that the integrals on the vertical sides of the contour vanish as  $R \rightarrow \infty$ .

$$\left| \int_R^{R+i2\pi} \frac{e^{az}}{e^z + 1} dz \right| \leq 2\pi \frac{e^{aR}}{e^R - 1} \rightarrow 0 \text{ as } R \rightarrow \infty$$
$$\left| \int_{-R+i2\pi}^{-R} \frac{e^{az}}{e^z + 1} dz \right| \leq 2\pi \frac{e^{-aR}}{1 - e^{-R}} \rightarrow 0 \text{ as } R \rightarrow \infty$$

In the limit as  $R$  tends to infinity, the integral on the rectangular contour is the sum of the integrals along the top and bottom sides.

$$\int_C \frac{e^{az}}{e^z + 1} dz = \int_{-\infty}^{\infty} \frac{e^{ax}}{e^x + 1} dx + \int_{\infty}^{-\infty} \frac{e^{a(x+i2\pi)}}{e^{x+i2\pi} + 1} dx$$
$$\int_C \frac{e^{az}}{e^z + 1} dz = (1 - e^{-i2a\pi}) \int_{-\infty}^{\infty} \frac{e^{ax}}{e^x + 1} dx$$

The only singularity of the integrand inside the contour is a first order pole at  $z = i\pi$ . We use the residue theorem to evaluate the integral.

$$\begin{aligned} \int_C \frac{e^{az}}{e^z + 1} dz &= i2\pi \operatorname{Res} \left( \frac{e^{az}}{e^z + 1}, i\pi \right) \\ &= i2\pi \lim_{z \rightarrow i\pi} \frac{(z - i\pi) e^{az}}{e^z + 1} \\ &= i2\pi \lim_{z \rightarrow i\pi} \frac{a(z - i\pi) e^{az} + e^{az}}{e^z} \\ &= -i2\pi e^{i a \pi} \end{aligned}$$

We equate the two results for the value of the contour integral.

$$(1 - e^{-i2a\pi}) \int_{-\infty}^{\infty} \frac{e^{ax}}{e^x + 1} dx = -i2\pi e^{ia\pi}$$

$$\int_{-\infty}^{\infty} \frac{e^{ax}}{e^x + 1} dx = \frac{i2\pi}{e^{ia\pi} - e^{-ia\pi}}$$

$$\int_{-\infty}^{\infty} \frac{e^{ax}}{e^x + 1} dx = \frac{\pi}{\sin(\pi a)}$$

Now we derive the value of,

$$\int_{-\infty}^{\infty} \frac{\cosh(bx)}{\cosh x} dx.$$

First make the change of variables  $x \rightarrow 2x$  in the previous result.

$$\int_{-\infty}^{\infty} \frac{e^{2ax}}{e^{2x} + 1} 2 dx = \frac{\pi}{\sin(\pi a)}$$

$$\int_{-\infty}^{\infty} \frac{e^{(2a-1)x}}{e^x + e^{-x}} dx = \frac{\pi}{\sin(\pi a)}$$

Now we set  $b = 2a - 1$ .

$$\int_{-\infty}^{\infty} \frac{e^{bx}}{\cosh x} dx = \frac{\pi}{\sin(\pi(b+1)/2)} = \frac{\pi}{\cos(\pi b/2)} \quad \text{for } -1 < b < 1$$

Since the cosine is an even function, we also have,

$$\int_{-\infty}^{\infty} \frac{e^{-bx}}{\cosh x} dx = \frac{\pi}{\cos(\pi b/2)} \quad \text{for } -1 < b < 1$$

Adding these two equations and dividing by 2 yields the desired result.

$$\int_{-\infty}^{\infty} \frac{\cosh(bx)}{\cosh x} dx = \frac{\pi}{\cos(\pi b/2)} \quad \text{for } -1 < b < 1$$

### Solution 13.40

**Real-Valued Parameters.** For  $b = 0$ , the integral has the value:  $\pi/a^2$ . If  $b$  is nonzero, then we can write the integral as

$$F(a, b) = \frac{1}{b^2} \int_0^\pi \frac{d\theta}{(a/b + \cos \theta)^2}.$$

We define the new parameter  $c = a/b$  and the function,

$$G(c) = b^2 F(a, b) = \int_0^\pi \frac{d\theta}{(c + \cos \theta)^2}.$$

If  $-1 \leq c \leq 1$  then the integrand has a double pole on the path of integration. The integral diverges. Otherwise the integral exists. To evaluate the integral, we extend the range of integration to  $(0..2\pi)$  and make the change of variables,  $z = e^{i\theta}$  to integrate along the unit circle in the complex plane.

$$G(c) = \frac{1}{2} \int_0^{2\pi} \frac{d\theta}{(c + \cos \theta)^2}$$

For this change of variables, we have,

$$\cos \theta = \frac{z + z^{-1}}{2}, \quad d\theta = \frac{dz}{iz}.$$

$$\begin{aligned} G(c) &= \frac{1}{2} \int_C \frac{dz/(iz)}{(c + (z + z^{-1})/2)^2} \\ &= -i2 \int_C \frac{z}{(2cz + z^2 + 1)^2} dz \\ &= -i2 \int_C \frac{z}{(z + c + \sqrt{c^2 - 1})^2 (z + c - \sqrt{c^2 - 1})^2} dz \end{aligned}$$

If  $c > 1$ , then  $-c - \sqrt{c^2 - 1}$  is outside the unit circle and  $-c + \sqrt{c^2 - 1}$  is inside the unit circle. The integrand has a second order pole inside the path of integration. We evaluate the integral with the residue theorem.

$$\begin{aligned}
 G(c) &= -i2i2\pi \operatorname{Res} \left( \frac{z}{(z + c + \sqrt{c^2 - 1})^2(z + c - \sqrt{c^2 - 1})^2}, z = -c + \sqrt{c^2 - 1} \right) \\
 &= 4\pi \lim_{z \rightarrow -c + \sqrt{c^2 - 1}} \frac{d}{dz} \frac{z}{(z + c + \sqrt{c^2 - 1})^2} \\
 &= 4\pi \lim_{z \rightarrow -c + \sqrt{c^2 - 1}} \left( \frac{1}{(z + c + \sqrt{c^2 - 1})^2} - \frac{2z}{(z + c + \sqrt{c^2 - 1})^3} \right) \\
 &= 4\pi \lim_{z \rightarrow -c + \sqrt{c^2 - 1}} \frac{c + \sqrt{c^2 - 1} - z}{(z + c + \sqrt{c^2 - 1})^3} \\
 &= 4\pi \frac{2c}{(2\sqrt{c^2 - 1})^3} \\
 &= \frac{\pi c}{\sqrt{(c^2 - 1)^3}}
 \end{aligned}$$

If  $c < 1$ , then  $-c - \sqrt{c^2 - 1}$  is inside the unit circle and  $-c + \sqrt{c^2 - 1}$  is outside the unit circle.

$$\begin{aligned}
 G(c) &= -i2i2\pi \operatorname{Res} \left( \frac{z}{(z + c + \sqrt{c^2 - 1})^2(z + c - \sqrt{c^2 - 1})^2}, z = -c - \sqrt{c^2 - 1} \right) \\
 &= 4\pi \lim_{z \rightarrow -c - \sqrt{c^2 - 1}} \frac{d}{dz} \frac{z}{(z + c - \sqrt{c^2 - 1})^2} \\
 &= 4\pi \lim_{z \rightarrow -c - \sqrt{c^2 - 1}} \left( \frac{1}{(z + c - \sqrt{c^2 - 1})^2} - \frac{2z}{(z + c - \sqrt{c^2 - 1})^3} \right) \\
 &= 4\pi \lim_{z \rightarrow -c - \sqrt{c^2 - 1}} \frac{c - \sqrt{c^2 - 1} - z}{(z + c - \sqrt{c^2 - 1})^3} \\
 &= 4\pi \frac{2c}{(-2\sqrt{c^2 - 1})^3} \\
 &= -\frac{\pi c}{\sqrt{(c^2 - 1)^3}}
 \end{aligned}$$

Thus we see that

$$G(c) \begin{cases} = \frac{\pi c}{\sqrt{(c^2 - 1)^3}} & \text{for } c > 1, \\ = -\frac{\pi c}{\sqrt{(c^2 - 1)^3}} & \text{for } c < 1, \\ \text{is divergent} & \text{for } -1 \leq c \leq 1. \end{cases}$$

In terms of  $F(a, b)$ , this is

$$F(a, b) \begin{cases} = \frac{a\pi}{\sqrt{(a^2 - b^2)^3}} & \text{for } a/b > 1, \\ = -\frac{a\pi}{\sqrt{(a^2 - b^2)^3}} & \text{for } a/b < 1, \\ \text{is divergent} & \text{for } -1 \leq a/b \leq 1. \end{cases}$$

**Complex-Valued Parameters.** Consider

$$G(c) = \int_0^\pi \frac{d\theta}{(c + \cos \theta)^2},$$

for complex  $c$ . Except for real-valued  $c$  between  $-1$  and  $1$ , the integral converges uniformly. We can interchange differentiation and integration. The derivative of  $G(c)$  is

$$\begin{aligned} G'(c) &= \frac{d}{dc} \int_0^\pi \frac{d\theta}{(c + \cos \theta)^2} \\ &= \int_0^\pi \frac{-2}{(c + \cos \theta)^3} d\theta \end{aligned}$$

Thus we see that  $G(c)$  is analytic in the complex plane with a cut on the real axis from  $-1$  to  $1$ . The value of the function on the positive real axis for  $c > 1$  is

$$G(c) = \frac{\pi c}{\sqrt{(c^2 - 1)^3}}.$$

We use analytic continuation to determine  $G(c)$  for complex  $c$ . By inspection we see that  $G(c)$  is the branch of

$$\frac{\pi c}{(c^2 - 1)^{3/2}},$$

with a branch cut on the real axis from  $-1$  to  $1$  and which is real-valued and positive for real  $c > 1$ . Using  $F(a, b) = G(c)/b^2$  we can determine  $F$  for complex-valued  $a$  and  $b$ .

### Solution 13.41

First note that

$$\int_{-\infty}^{\infty} \frac{\cos x}{e^x + e^{-x}} dx = \int_{-\infty}^{\infty} \frac{e^{ix}}{e^x + e^{-x}} dx$$

since  $\sin x/(e^x + e^{-x})$  is an odd function. For the function

$$f(z) = \frac{e^{iz}}{e^z + e^{-z}}$$

we have

$$f(x + i\pi) = \frac{e^{ix - \pi}}{e^{x+i\pi} + e^{-x-i\pi}} = -e^{-\pi} \frac{e^{ix}}{e^x + e^{-x}} = -e^{-\pi} f(x).$$



Thus we consider the integral

$$\int_C \frac{e^{iz}}{e^z + e^{-z}} dz$$

where  $C$  is the box contour with corners at  $\pm R$  and  $\pm R + i\pi$ . We can evaluate this integral with the residue theorem. We can write the integrand as

$$\frac{e^{iz}}{2 \cosh z}.$$

We see that the integrand has first order poles at  $z = i\pi(n + 1/2)$ . The only pole inside the path of integration is at  $z = i\pi/2$ .

$$\begin{aligned} \int_C \frac{e^{iz}}{e^z + e^{-z}} dz &= i2\pi \operatorname{Res} \left( \frac{e^{iz}}{e^z + e^{-z}}, z = \frac{i\pi}{2} \right) \\ &= i2\pi \lim_{z \rightarrow i\pi/2} \frac{(z - i\pi/2) e^{iz}}{e^z + e^{-z}} \\ &= i2\pi \lim_{z \rightarrow i\pi/2} \frac{e^{iz} + i(z - i\pi/2) e^{iz}}{e^z - e^{-z}} \\ &= i2\pi \frac{e^{-\pi/2}}{e^{i\pi/2} - e^{-i\pi/2}} \\ &= \pi e^{-\pi/2} \end{aligned}$$

The integrals along the vertical sides of the box vanish as  $R \rightarrow \infty$ .

$$\begin{aligned}
 \left| \int_{\pm R}^{\pm R+i\pi} \frac{e^{iz}}{e^z + e^{-z}} dz \right| &\leq \pi \max_{z \in [\pm R \dots \pm R+i\pi]} \left| \frac{e^{iz}}{e^z + e^{-z}} \right| \\
 &\leq \pi \max_{y \in [0 \dots \pi]} \left| \frac{1}{e^{R+iy} + e^{-R-iy}} \right| \\
 &\leq \pi \max_{y \in [0 \dots \pi]} \left| \frac{1}{e^R + e^{-R-iy}} \right| \\
 &= \pi \frac{1}{2 \sinh R} \\
 &\rightarrow 0 \text{ as } R \rightarrow \infty
 \end{aligned}$$

Taking the limit as  $R \rightarrow \infty$ , we have

$$\begin{aligned}
 \int_{-\infty}^{\infty} \frac{e^{ix}}{e^x + e^{-x}} dx + \int_{\infty+i\pi}^{-\infty+i\pi} \frac{e^{iz}}{e^z + e^{-z}} dz &= \pi e^{-\pi/2} \\
 (1 + e^{-\pi}) \int_{-\infty}^{\infty} \frac{e^{ix}}{e^x + e^{-x}} dx &= \pi e^{-\pi/2} \\
 \int_{-\infty}^{\infty} \frac{e^{ix}}{e^x + e^{-x}} dx &= \frac{\pi}{e^{\pi/2} + e^{-\pi/2}}
 \end{aligned}$$

Finally we have,

$$\boxed{\int_{-\infty}^{\infty} \frac{\cos x}{e^x + e^{-x}} dx = \frac{\pi}{e^{\pi/2} + e^{-\pi/2}}.}$$

## Definite Integrals Involving Sine and Cosine

### Solution 13.42

1. To evaluate the integral we make the change of variables  $z = e^{i\theta}$ . The path of integration in the complex plane

is the positively oriented unit circle.

$$\begin{aligned} \int_{-\pi}^{\pi} \frac{d\theta}{1 + \sin^2 \theta} &= \int_C \frac{1}{1 - (z - z^{-1})^2 / 4} \frac{dz}{iz} \\ &= \int_C \frac{i4z}{z^4 - 6z^2 + 1} dz \\ &= \int_C \frac{i4z}{(z - 1 - \sqrt{2})(z - 1 + \sqrt{2})(z + 1 - \sqrt{2})(z + 1 + \sqrt{2})} dz \end{aligned}$$

There are first order poles at  $z = \pm 1 \pm \sqrt{2}$ . The poles at  $z = -1 + \sqrt{2}$  and  $z = 1 - \sqrt{2}$  are inside the path of integration. We evaluate the integral with Cauchy's Residue Formula.

$$\begin{aligned} \int_C \frac{i4z}{z^4 - 6z^2 + 1} dz &= i2\pi \left( \operatorname{Res} \left( \frac{i4z}{z^4 - 6z^2 + 1}, z = -1 + \sqrt{2} \right) \right. \\ &\quad \left. + \operatorname{Res} \left( \frac{i4z}{z^4 - 6z^2 + 1}, z = 1 - \sqrt{2} \right) \right) \\ &= -8\pi \left( \frac{z}{(z - 1 - \sqrt{2})(z - 1 + \sqrt{2})(z + 1 + \sqrt{2})} \Big|_{z=-1+\sqrt{2}} \right. \\ &\quad \left. + \frac{z}{(z - 1 - \sqrt{2})(z + 1 - \sqrt{2})(z + 1 + \sqrt{2})} \Big|_{z=1-\sqrt{2}} \right) \\ &= -8\pi \left( -\frac{1}{8\sqrt{2}} - \frac{1}{8\sqrt{2}} \right) \\ &= \sqrt{2}\pi \end{aligned}$$

2. First we use symmetry to expand the domain of integration.

$$\int_0^{\pi/2} \sin^4 \theta d\theta = \frac{1}{4} \int_0^{2\pi} \sin^4 \theta d\theta$$

Next we make the change of variables  $z = e^{i\theta}$ . The path of integration in the complex plane is the positively oriented unit circle. We evaluate the integral with the residue theorem.

$$\begin{aligned}\frac{1}{4} \int_0^{2\pi} \sin^4 \theta \, d\theta &= \frac{1}{4} \int_C \frac{1}{16} \left(z - \frac{1}{z}\right)^4 \frac{dz}{iz} \\ &= \frac{1}{64} \int_C -i \frac{(z^2 - 1)^4}{z^5} \, dz \\ &= \frac{-i}{64} \int_C \left(z^3 - 4z + \frac{6}{z} - \frac{4}{z^3} + \frac{1}{z^5}\right) \, dz \\ &= i2\pi \frac{-i}{64} 6 \\ &= \frac{3\pi}{16}\end{aligned}$$

### Solution 13.43

1. Let  $C$  be the positively oriented unit circle about the origin. We parametrize this contour.

$$z = e^{i\theta}, \quad dz = ie^{i\theta} \, d\theta, \quad \theta \in (0 \dots 2\pi)$$

We write  $\sin \theta$  and the differential  $d\theta$  in terms of  $z$ . Then we evaluate the integral with the Residue theorem.

$$\begin{aligned}
 \int_0^{2\pi} \frac{1}{2 + \sin \theta} d\theta &= \oint_C \frac{1}{2 + (z - 1/z)/(i2)} \frac{dz}{iz} \\
 &= \oint_C \frac{2}{z^2 + i4z - 1} dz \\
 &= \oint_C \frac{2}{(z + i(2 + \sqrt{3}))(z + i(2 - \sqrt{3}))} dz \\
 &= i2\pi \operatorname{Res} \left( \left( (z + i(2 + \sqrt{3})) (z + i(2 - \sqrt{3})) \right), z = i(-2 + \sqrt{3}) \right) \\
 &= i2\pi \frac{2}{i2\sqrt{3}} \\
 &= \frac{2\pi}{\sqrt{3}}
 \end{aligned}$$

2. First consider the case  $a = 0$ .

$$\int_{-\pi}^{\pi} \cos(n\theta) d\theta = \begin{cases} 0 & \text{for } n \in \mathbb{Z}^+ \\ 2\pi & \text{for } n = 0 \end{cases}$$

Now we consider  $|a| < 1$ ,  $a \neq 0$ . Since

$$\frac{\sin(n\theta)}{1 - 2a \cos \theta + a^2}$$

is an even function,

$$\int_{-\pi}^{\pi} \frac{\cos(n\theta)}{1 - 2a \cos \theta + a^2} d\theta = \int_{-\pi}^{\pi} \frac{e^{in\theta}}{1 - 2a \cos \theta + a^2} d\theta$$

Let  $C$  be the positively oriented unit circle about the origin. We parametrize this contour.

$$z = e^{i\theta}, \quad dz = ie^{i\theta} d\theta, \quad \theta \in (-\pi \dots \pi)$$

We write the integrand and the differential  $d\theta$  in terms of  $z$ . Then we evaluate the integral with the Residue theorem.

$$\begin{aligned}
 \int_{-\pi}^{\pi} \frac{e^{in\theta}}{1 - 2a \cos \theta + a^2} d\theta &= \oint_C \frac{z^n}{1 - a(z + 1/z) + a^2} \frac{dz}{iz} \\
 &= -i \oint_C \frac{z^n}{-az^2 + (1 + a^2)z - a} dz \\
 &= \frac{i}{a} \oint_C \frac{z^n}{z^2 - (a + 1/a)z + 1} dz \\
 &= \frac{i}{a} \oint_C \frac{z^n}{(z - a)(z - 1/a)} dz \\
 &= i2\pi \frac{i}{a} \operatorname{Res} \left( \frac{z^n}{(z - a)(z - 1/a)}, z = a \right) \\
 &= -\frac{2\pi}{a} \frac{a^n}{a - 1/a} \\
 &= \frac{2\pi a^n}{1 - a^2}
 \end{aligned}$$

We write the value of the integral for  $|a| < 1$  and  $n \in \mathbb{Z}^{0+}$ .

$$\int_{-\pi}^{\pi} \frac{\cos(n\theta)}{1 - 2a \cos \theta + a^2} d\theta = \begin{cases} 2\pi & \text{for } a = 0, n = 0 \\ \frac{2\pi a^n}{1 - a^2} & \text{otherwise} \end{cases}$$

### Solution 13.44

**Convergence.** We consider the integral

$$I(\alpha) = \int_0^{\pi} \frac{\cos(n\theta)}{\cos \theta - \cos \alpha} d\theta = \pi \frac{\sin(n\alpha)}{\sin \alpha}.$$

We assume that  $\alpha$  is real-valued. If  $\alpha$  is an integer, then the integrand has a second order pole on the path of integration, the principal value of the integral does not exist. If  $\alpha$  is real, but not an integer, then the integrand has a first order pole on the path of integration. The integral diverges, but its principal value exists.

**Contour Integration.** We will evaluate the integral for real, non-integer  $\alpha$ .

$$\begin{aligned} I(\alpha) &= \int_0^\pi \frac{\cos(n\theta)}{\cos\theta - \cos\alpha} d\theta \\ &= \frac{1}{2} \int_0^{2\pi} \frac{\cos(n\theta)}{\cos\theta - \cos\alpha} d\theta \\ &= \frac{1}{2} \Re \int_0^{2\pi} \frac{e^{in\theta}}{\cos\theta - \cos\alpha} d\theta \end{aligned}$$

We make the change of variables:  $z = e^{i\theta}$ .

$$\begin{aligned} I(\alpha) &= \frac{1}{2} \Re \int_C \frac{z^n}{(z + 1/z)/2 - \cos\alpha} \frac{dz}{iz} \\ &= \Re \int_C \frac{-iz^n}{(z - e^{i\alpha})(z - e^{-i\alpha})} dz \end{aligned}$$

Now we use the residue theorem.

$$\begin{aligned} &= \Re \left( i\pi(-i) \left( \operatorname{Res} \left( \frac{z^n}{(z - e^{i\alpha})(z - e^{-i\alpha})}, z = e^{i\alpha} \right) \right. \right. \\ &\quad \left. \left. + \operatorname{Res} \left( \frac{z^n}{(z - e^{i\alpha})(z - e^{-i\alpha})}, z = e^{-i\alpha} \right) \right) \right) \\ &= \pi \Re \left( \lim_{z \rightarrow e^{i\alpha}} \frac{z^n}{z - e^{-i\alpha}} + \lim_{z \rightarrow e^{-i\alpha}} \frac{z^n}{z - e^{i\alpha}} \right) \\ &= \pi \Re \left( \frac{e^{in\alpha}}{e^{i\alpha} - e^{-i\alpha}} + \frac{e^{-in\alpha}}{e^{-i\alpha} - e^{i\alpha}} \right) \\ &= \pi \Re \left( \frac{e^{in\alpha} - e^{-in\alpha}}{e^{i\alpha} - e^{-i\alpha}} \right) \\ &= \pi \Re \left( \frac{\sin(n\alpha)}{\sin(\alpha)} \right) \end{aligned}$$

$$I(\alpha) = \int_0^\pi \frac{\cos(n\theta)}{\cos \theta - \cos \alpha} d\theta = \pi \frac{\sin(n\alpha)}{\sin \alpha}.$$

### Solution 13.45

Consider the integral

$$\int_0^1 \frac{x^2}{(1+x^2)\sqrt{1-x^2}} dx.$$

We make the change of variables  $x = \sin \xi$  to obtain,

$$\begin{aligned} \int_0^{\pi/2} \frac{\sin^2 \xi}{(1+\sin^2 \xi)\sqrt{1-\sin^2 \xi}} \cos \xi d\xi \\ \int_0^{\pi/2} \frac{\sin^2 \xi}{1+\sin^2 \xi} d\xi \\ \int_0^{\pi/2} \frac{1-\cos(2\xi)}{3-\cos(2\xi)} d\xi \\ \frac{1}{4} \int_0^{2\pi} \frac{1-\cos \xi}{3-\cos \xi} d\xi \end{aligned}$$

Now we make the change of variables  $z = e^{i\xi}$  to obtain a contour integral on the unit circle.

$$\begin{aligned} \frac{1}{4} \int_C \frac{1-(z+1/z)/2}{3-(z+1/z)/2} \left(\frac{-i}{z}\right) dz \\ \frac{-i}{4} \int_C \frac{(z-1)^2}{z(z-3+2\sqrt{2})(z-3-2\sqrt{2})} dz \end{aligned}$$

There are two first order poles inside the contour. The value of the integral is

$$i2\pi \frac{-i}{4} \left( \operatorname{Res} \left( \frac{(z-1)^2}{z(z-3+2\sqrt{2})(z-3-2\sqrt{2})}, 0 \right) + \operatorname{Res} \left( \frac{(z-1)^2}{z(z-3+2\sqrt{2})(z-3-2\sqrt{2})}, z=3-2\sqrt{2} \right) \right)$$



$$\frac{\pi}{2} \left( \lim_{z \rightarrow 0} \left( \frac{(z-1)^2}{(z-3+2\sqrt{2})(z-3-2\sqrt{2})} \right) + \lim_{z \rightarrow 3-2\sqrt{2}} \left( \frac{(z-1)^2}{z(z-3-2\sqrt{2})} \right) \right).$$

$$\boxed{\int_0^1 \frac{x^2}{(1+x^2)\sqrt{1-x^2}} dx = \frac{(2-\sqrt{2})\pi}{4}}$$

## Infinite Sums

### Solution 13.46

From Result 13.10.1 we see that the sum of the residues of  $\pi \cot(\pi z)/z^4$  is zero. This function has simple poles at nonzero integers  $z = n$  with residue  $1/n^4$ . There is a fifth order pole at  $z = 0$ . Finding the residue with the formula

$$\frac{1}{4!} \lim_{z \rightarrow 0} \frac{d^4}{dz^4} (\pi z \cot(\pi z))$$

would be a real pain. After doing the differentiation, we would have to apply L'Hospital's rule multiple times. A better way of finding the residue is with the Laurent series expansion of the function. Note that

$$\begin{aligned} \frac{1}{\sin(\pi z)} &= \frac{1}{\pi z - (\pi z)^3/6 + (\pi z)^5/120 - \dots} \\ &= \frac{1}{\pi z} \frac{1}{1 - (\pi z)^2/6 + (\pi z)^4/120 - \dots} \\ &= \frac{1}{\pi z} \left( 1 + \left( \frac{\pi^2}{6} z^2 - \frac{\pi^4}{120} z^4 + \dots \right) + \left( \frac{\pi^2}{6} z^2 - \frac{\pi^4}{120} z^4 + \dots \right)^2 + \dots \right). \end{aligned}$$

Now we find the  $z^{-1}$  term in the Laurent series expansion of  $\pi \cot(\pi z)/z^4$ .

$$\begin{aligned} \frac{\pi \cos(\pi z)}{z^4 \sin(\pi z)} &= \frac{\pi}{z^4} \left( 1 - \frac{\pi^2}{2} z^2 + \frac{\pi^4}{24} z^4 - \dots \right) \frac{1}{\pi z} \left( 1 + \left( \frac{\pi^2}{6} z^2 - \frac{\pi^4}{120} z^4 + \dots \right) + \left( \frac{\pi^2}{6} z^2 - \frac{\pi^4}{120} z^4 + \dots \right)^2 + \dots \right) \\ &= \frac{1}{z^5} \left( \dots + \left( -\frac{\pi^4}{120} + \frac{\pi^4}{36} - \frac{\pi^4}{12} + \frac{\pi^4}{24} \right) z^4 + \dots \right) \\ &= \dots - \frac{\pi^4}{45} \frac{1}{z} + \dots \end{aligned}$$

Thus the residue at  $z = 0$  is  $-\pi^4/45$ . Summing the residues,

$$\sum_{n=-\infty}^{-1} \frac{1}{n^4} - \frac{\pi^4}{45} + \sum_{n=1}^{\infty} \frac{1}{n^4} = 0.$$

$$\boxed{\sum_{n=1}^{\infty} \frac{1}{n^4} = \frac{\pi^4}{90}}$$

### Solution 13.47

For this problem we will use the following result: If

$$\lim_{|z| \rightarrow \infty} |zf(z)| = 0,$$

then the sum of all the residues of  $\pi \cot(\pi z)f(z)$  is zero. If in addition,  $f(z)$  is analytic at  $z = n \in \mathbb{Z}$  then

$$\sum_{n=-\infty}^{\infty} f(n) = -(\text{sum of the residues of } \pi \cot(\pi z)f(z) \text{ at the poles of } f(z)).$$

We assume that  $\alpha$  is not an integer, otherwise the sum is not defined. Consider  $f(z) = 1/(z^2 - \alpha^2)$ . Since

$$\lim_{|z| \rightarrow \infty} \left| z \frac{1}{z^2 - \alpha^2} \right| = 0,$$

and  $f(z)$  is analytic at  $z = n$ ,  $n \in \mathbb{Z}$ , we have

$$\sum_{n=-\infty}^{\infty} \frac{1}{n^2 - \alpha^2} = -(\text{sum of the residues of } \pi \cot(\pi z)f(z) \text{ at the poles of } f(z)).$$

$f(z)$  has first order poles at  $z = \pm\alpha$ .

$$\begin{aligned} \sum_{n=-\infty}^{\infty} \frac{1}{n^2 - \alpha^2} &= -\operatorname{Res}\left(\frac{\pi \cot(\pi z)}{z^2 - \alpha^2}, z = \alpha\right) - \operatorname{Res}\left(\frac{\pi \cot(\pi z)}{z^2 - \alpha^2}, z = -\alpha\right) \\ &= -\lim_{z \rightarrow \alpha} \frac{\pi \cot(\pi z)}{z + \alpha} - \lim_{z \rightarrow -\alpha} \frac{\pi \cot(\pi z)}{z - \alpha} \\ &= -\frac{\pi \cot(\pi\alpha)}{2\alpha} - \frac{\pi \cot(-\pi\alpha)}{-2\alpha} \end{aligned}$$

$$\boxed{\sum_{n=-\infty}^{\infty} \frac{1}{n^2 - \alpha^2} = -\frac{\pi \cot(\pi\alpha)}{\alpha}}$$

## Part IV

# Ordinary Differential Equations

# Chapter 14

## First Order Differential Equations

Don't show me your technique. Show me your heart.

-Tetsuyasu Uekuma

### 14.1 Notation

A *differential equation* is an equation involving a function, its derivatives, and independent variables. If there is only one independent variable, then it is an *ordinary differential equation*. Identities such as

$$\frac{d}{dx} (f^2(x)) = 2f(x)f'(x), \quad \text{and} \quad \frac{dy}{dx} \frac{dx}{dy} = 1$$

are not differential equations.

The *order* of a differential equation is the order of the highest derivative. The following equations for  $y(x)$  are first, second and third order, respectively.

- $y' = xy^2$

- $y'' + 3xy' + 2y = x^2$
- $y''' = y''y$

The *degree* of a differential equation is the highest power of the highest derivative in the equation. The following equations are first, second and third degree, respectively.

- $y' - 3y^2 = \sin x$
- $(y'')^2 + 2x \cos y = e^x$
- $(y')^3 + y^5 = 0$

An equation is said to be *linear* if it is linear in the dependent variable.

- $y'' \cos x + x^2y = 0$  is a linear differential equation.
- $y' + xy^2 = 0$  is a nonlinear differential equation.

A differential equation is *homogeneous* if it has no terms that are functions of the independent variable alone. Thus an *inhomogeneous* equation is one in which there are terms that are functions of the independent variables alone.

- $y'' + xy + y = 0$  is a homogeneous equation.
- $y' + y + x^2 = 0$  is an inhomogeneous equation.

A first order differential equation may be written in terms of differentials. Recall that for the function  $y(x)$  the differential  $dy$  is defined  $dy = y'(x) dx$ . Thus the differential equations

$$y' = x^2y \quad \text{and} \quad y' + xy^2 = \sin(x)$$

can be denoted:

$$dy = x^2y dx \quad \text{and} \quad dy + xy^2 dx = \sin(x) dx.$$

A *solution* of a differential equation is a function which when substituted into the equation yields an identity. For example,  $y = x \ln |x|$  is a solution of

$$y' - \frac{y}{x} = 1.$$

We verify this by substituting it into the differential equation.

$$\ln |x| + 1 - \ln |x| = 1$$

We can also verify that  $y = ce^x$  is a solution of  $y'' - y = 0$  for any value of the parameter  $c$ .

$$ce^x - ce^x = 0$$

## 14.2 Example Problems

In this section we will discuss physical and geometrical problems that lead to first order differential equations.

### 14.2.1 Growth and Decay

**Example 14.2.1** Consider a culture of bacteria in which each bacterium divides once per hour. Let  $n(t) \in \mathcal{N}$  denote the population, let  $t$  denote the time in hours and let  $n_0$  be the population at time  $t = 0$ . The population doubles every hour. Thus for integer  $t$ , the population is  $n_0 2^t$ . Figure 14.1 shows two possible populations when there is initially a single bacterium. In the first plot, each of the bacteria divide at times  $t = m$  for  $m \in \mathcal{N}$ . In the second plot, they divide at times  $t = m - 1/2$ . For both plots the population is  $2^t$  for integer  $t$ .

We model this problem by considering a continuous population  $y(t) \in \mathcal{R}$  which approximates the discrete population. In Figure 14.2 we first show the population when there is initially 8 bacteria. The divisions of bacteria is spread out over each one second interval. For integer  $t$ , the populations is  $8 \cdot 2^t$ . Next we show the population with a plot of the continuous function  $y(t) = 8 \cdot 2^t$ . We see that  $y(t)$  is a reasonable approximation of the discrete population.

In the discrete problem, the growth of the population is proportional to its number; the population doubles every hour. For the continuous problem, we assume that this is true for  $y(t)$ . We write this as an equation:

$$y'(t) = \alpha y(t).$$

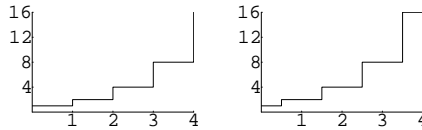

Figure 14.1: The population of bacteria.

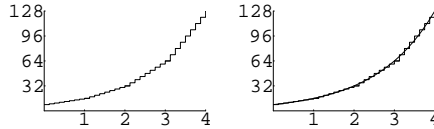

Figure 14.2: The discrete population of bacteria and a continuous population approximation.

That is, the rate of change  $y'(t)$  in the population is proportional to the population  $y(t)$ , (with constant of proportionality  $\alpha$ ). We specify the population at time  $t = 0$  with the initial condition:  $y(0) = n_0$ . Note that  $y(t) = n_0 e^{\alpha t}$  satisfies the problem:

$$y'(t) = \alpha y(t), \quad y(0) = n_0.$$

For our bacteria example,  $\alpha = \ln 2$ .

**Result 14.2.1** A quantity  $y(t)$  whose growth or decay is proportional to  $y(t)$  is modelled by the problem:

$$y'(t) = \alpha y(t), \quad y(t_0) = y_0.$$

Here we assume that the quantity is known at time  $t = t_0$ .  $e^\alpha$  is the factor by which the quantity grows/decays in unit time. The solution of this problem is  $y(t) = y_0 e^{\alpha(t-t_0)}$ .



## 14.3 One Parameter Families of Functions

Consider the equation:

$$F(x, y(x), c) = 0, \quad (14.1)$$

which implicitly defines a one-parameter family of functions  $y(x; c)$ . Here  $y$  is a function of the variable  $x$  and the parameter  $c$ . For simplicity, we will write  $y(x)$  and not explicitly show the parameter dependence.

**Example 14.3.1** *The equation  $y = cx$  defines family of lines with slope  $c$ , passing through the origin. The equation  $x^2 + y^2 = c^2$  defines circles of radius  $c$ , centered at the origin.*

*Consider a **chicken** dropped from a height  $h$ . The elevation  $y$  of the chicken at time  $t$  after its release is  $y(t) = h - gt^2$ , where  $g$  is the acceleration due to gravity. This is family of functions for the parameter  $h$ .*

It turns out that the general solution of any first order differential equation is a one-parameter family of functions. This is not easy to prove. However, it is easy to verify the converse. We differentiate Equation 14.1 with respect to  $x$ .

$$F_x + F_y y' = 0$$

(We assume that  $F$  has a non-trivial dependence on  $y$ , that is  $F_y \neq 0$ .) This gives us two equations involving the independent variable  $x$ , the dependent variable  $y(x)$  and its derivative and the parameter  $c$ . If we algebraically eliminate  $c$  between the two equations, the eliminant will be a first order differential equation for  $y(x)$ . Thus we see that every one-parameter family of functions  $y(x)$  satisfies a first order differential equation. This  $y(x)$  is the *primitive* of the differential equation. Later we will discuss why  $y(x)$  is the *general solution* of the differential equation.

**Example 14.3.2** *Consider the family of circles of radius  $c$  centered about the origin.*

$$x^2 + y^2 = c^2$$

*Differentiating this yields:*

$$2x + 2yy' = 0.$$

*It is trivial to eliminate the parameter and obtain a differential equation for the family of circles.*

$$x + yy' = 0$$

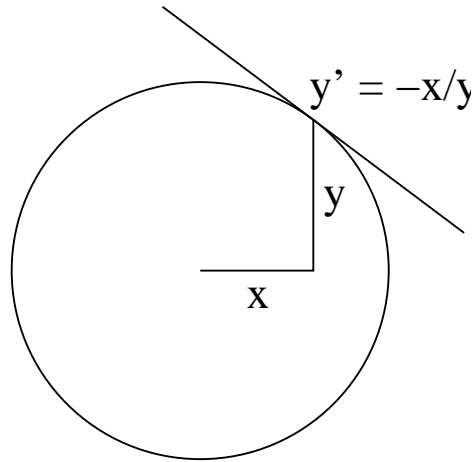

Figure 14.3: A circle and its tangent.

We can see the geometric meaning in this equation by writing it in the form:

$$y' = -\frac{x}{y}.$$

For a point on the circle, the slope of the tangent  $y'$  is the negative of the cotangent of the angle  $x/y$ . (See Figure 14.3.)

**Example 14.3.3** Consider the one-parameter family of functions:

$$y(x) = f(x) + cg(x),$$

where  $f(x)$  and  $g(x)$  are known functions. The derivative is

$$y' = f' + cg'.$$

We eliminate the parameter.

$$gy' - g'y = gf' - g'f$$
$$y' - \frac{g'}{g}y = f' - \frac{g'f}{g}$$

Thus we see that  $y(x) = f(x) + cg(x)$  satisfies a first order linear differential equation. Later we will prove the converse: the general solution of a first order linear differential equation has the form:  $y(x) = f(x) + cg(x)$ .

We have shown that every one-parameter family of functions satisfies a first order differential equation. We do not prove it here, but the converse is true as well.

**Result 14.3.1** Every first order differential equation has a one-parameter family of solutions  $y(x)$  defined by an equation of the form:

$$F(x, y(x); c) = 0.$$

This  $y(x)$  is called the *general solution*. If the equation is linear then the general solution expresses the totality of solutions of the differential equation. If the equation is nonlinear, there may be other special *singular solutions*, which do not depend on a parameter.

This is strictly an existence result. It does not say that the general solution of a first order differential equation can be determined by some method, it just says that it exists. There is no method for solving the general first order differential equation. However, there are some special forms that are soluble. We will devote the rest of this chapter to studying these forms.

## 14.4 Integrable Forms

In this section we will introduce a few forms of differential equations that we may solve through integration.

## 14.4.1 Separable Equations

Any differential equation that can be written in the form

$$P(x) + Q(y)y' = 0$$

is a *separable equation*, (because the dependent and independent variables are separated). We can obtain an implicit solution by integrating with respect to  $x$ .

$$\int P(x) dx + \int Q(y) \frac{dy}{dx} dx = c$$
$$\int P(x) dx + \int Q(y) dy = c$$

**Result 14.4.1** The separable equation  $P(x) + Q(y)y' = 0$  may be solved by integrating with respect to  $x$ . The general solution is

$$\int P(x) dx + \int Q(y) dy = c.$$

**Example 14.4.1** Consider the differential equation  $y' = xy^2$ . We separate the dependent and independent variables

and integrate to find the solution.

$$\begin{aligned}\frac{dy}{dx} &= xy^2 \\ y^{-2} dy &= x dx \\ \int y^{-2} dy &= \int x dx + c \\ -y^{-1} &= \frac{x^2}{2} + c \\ \boxed{y} &= -\frac{1}{x^2/2 + c}\end{aligned}$$

**Example 14.4.2** The equation  $y' = y - y^2$  is separable.

$$\frac{y'}{y - y^2} = 1$$

We expand in partial fractions and integrate.

$$\begin{aligned}\left(\frac{1}{y} - \frac{1}{y-1}\right) y' &= 1 \\ \ln|y| - \ln|y-1| &= x + c\end{aligned}$$

We have an implicit equation for  $y(x)$ . Now we solve for  $y(x)$ .

$$\ln \left| \frac{y}{y-1} \right| = x + c$$

$$\left| \frac{y}{y-1} \right| = e^{x+c}$$

$$\frac{y}{y-1} = \pm e^{x+c}$$

$$\frac{y}{y-1} = c e^x$$

$$y = \frac{c e^x}{c e^x - 1}$$

$$y = \frac{1}{1 + c e^x}$$

## 14.4.2 Exact Equations

Any first order ordinary differential equation of the first degree can be written as the total differential equation,

$$P(x, y) dx + Q(x, y) dy = 0.$$

If this equation can be integrated directly, that is if there is a primitive,  $u(x, y)$ , such that

$$du = P dx + Q dy,$$

then this equation is called *exact*. The (implicit) solution of the differential equation is

$$u(x, y) = c,$$

where  $c$  is an arbitrary constant. Since the differential of a function,  $u(x, y)$ , is

$$du \equiv \frac{\partial u}{\partial x} dx + \frac{\partial u}{\partial y} dy,$$

$P$  and  $Q$  are the partial derivatives of  $u$ :

$$P(x, y) = \frac{\partial u}{\partial x}, \quad Q(x, y) = \frac{\partial u}{\partial y}.$$

In an alternate notation, the differential equation

$$P(x, y) + Q(x, y) \frac{dy}{dx} = 0, \tag{14.2}$$

is exact if there is a primitive  $u(x, y)$  such that

$$\frac{du}{dx} \equiv \frac{\partial u}{\partial x} + \frac{\partial u}{\partial y} \frac{dy}{dx} = P(x, y) + Q(x, y) \frac{dy}{dx}.$$

The solution of the differential equation is  $u(x, y) = c$ .

### Example 14.4.3

$$x + y \frac{dy}{dx} = 0$$

is an exact differential equation since

$$\frac{d}{dx} \left( \frac{1}{2}(x^2 + y^2) \right) = x + y \frac{dy}{dx}.$$

The solution of the differential equation is

$$\frac{1}{2}(x^2 + y^2) = c.$$

**Example 14.4.4** , Let  $f(x)$  and  $g(x)$  be known functions.

$$g(x)y' + g'(x)y = f(x)$$

is an exact differential equation since

$$\frac{d}{dx} (g(x)y(x)) = gy' + g'y.$$

The solution of the differential equation is

$$g(x)y(x) = \int f(x) dx + c$$
$$y(x) = \frac{1}{g(x)} \int f(x) dx + \frac{c}{g(x)}.$$

**A necessary condition for exactness.** The solution of the exact equation  $P + Qy' = 0$  is  $u = c$  where  $u$  is the primitive of the equation,  $\frac{du}{dx} = P + Qy'$ . At present the only method we have for determining the primitive is guessing. This is fine for simple equations, but for more difficult cases we would like a method more concrete than divine inspiration. As a first step toward this goal we determine a criterion for determining if an equation is exact.

Consider the exact equation,

$$P + Qy' = 0,$$

with primitive  $u$ , where we assume that the functions  $P$  and  $Q$  are continuously differentiable. Since the mixed partial derivatives of  $u$  are equal,

$$\frac{\partial^2 u}{\partial x \partial y} = \frac{\partial^2 u}{\partial y \partial x},$$

a necessary condition for exactness is

$$\frac{\partial P}{\partial y} = \frac{\partial Q}{\partial x}.$$

**A sufficient condition for exactness.** This necessary condition for exactness is also a sufficient condition. We demonstrate this by deriving the general solution of (14.2). Assume that  $P + Qy' = 0$  is not necessarily exact, but satisfies the condition  $P_y = Q_x$ . If the equation has a primitive,

$$\frac{du}{dx} \equiv \frac{\partial u}{\partial x} + \frac{\partial u}{\partial y} \frac{dy}{dx} = P(x, y) + Q(x, y) \frac{dy}{dx},$$

then it satisfies

$$\frac{\partial u}{\partial x} = P, \quad \frac{\partial u}{\partial y} = Q. \tag{14.3}$$



Integrating the first equation of (14.3), we see that the primitive has the form

$$u(x, y) = \int_{x_0}^x P(\xi, y) d\xi + f(y),$$

for some  $f(y)$ . Now we substitute this form into the second equation of (14.3).

$$\begin{aligned} \frac{\partial u}{\partial y} &= Q(x, y) \\ \int_{x_0}^x P_y(\xi, y) d\xi + f'(y) &= Q(x, y) \end{aligned}$$

Now we use the condition  $P_y = Q_x$ .

$$\begin{aligned} \int_{x_0}^x Q_x(\xi, y) d\xi + f'(y) &= Q(x, y) \\ Q(x, y) - Q(x_0, y) + f'(y) &= Q(x, y) \\ f'(y) &= Q(x_0, y) \\ f(y) &= \int_{y_0}^y Q(x_0, \psi) d\psi \end{aligned}$$

Thus we see that

$$u = \int_{x_0}^x P(\xi, y) d\xi + \int_{y_0}^y Q(x_0, \psi) d\psi$$

is a primitive of the derivative; the equation is exact. The solution of the differential equation is

$$\int_{x_0}^x P(\xi, y) d\xi + \int_{y_0}^y Q(x_0, \psi) d\psi = c.$$

Even though there are three arbitrary constants:  $x_0$ ,  $y_0$  and  $c$ , the solution is a one-parameter family. This is because changing  $x_0$  or  $y_0$  only changes the left side by an additive constant.

**Result 14.4.2** Any first order differential equation of the first degree can be written in the form

$$P(x, y) + Q(x, y) \frac{dy}{dx} = 0.$$

This equation is exact if and only if

$$P_y = Q_x.$$

In this case the solution of the differential equation is given by

$$\int_{x_0}^x P(\xi, y) d\xi + \int_{y_0}^y Q(x_0, \psi) d\psi = c.$$

### Exercise 14.1

Solve the following differential equations by inspection. That is, group terms into exact derivatives and then integrate.  $f(x)$  and  $g(x)$  are known functions.

1.  $\frac{y'(x)}{y(x)} = f(x)$
2.  $y^\alpha(x)y'(x) = f(x)$
3.  $\frac{y'}{\cos x} + y \frac{\tan x}{\cos x} = \cos x$

Hint, Solution

### 14.4.3 Homogeneous Coefficient Equations

Homogeneous coefficient, first order differential equations form another class of soluble equations. We will find that a change of dependent variable will make such equations separable or we can determine an integrating factor that will make such equations exact. First we define homogeneous functions.

**Euler's Theorem on Homogeneous Functions.** The function  $F(x, y)$  is *homogeneous of degree  $n$*  if

$$F(\lambda x, \lambda y) = \lambda^n F(x, y).$$

From this definition we see that

$$F(x, y) = x^n F\left(1, \frac{y}{x}\right).$$

(Just formally substitute  $1/x$  for  $\lambda$ .) For example,

$$xy^2, \quad \frac{x^2y + 2y^3}{x + y}, \quad x \cos(y/x)$$

are homogeneous functions of orders 3, 2 and 1, respectively.

Euler's theorem for a homogeneous function of order  $n$  is:

$$xF_x + yF_y = nF.$$

To prove this, we define  $\xi = \lambda x$ ,  $\psi = \lambda y$ . From the definition of homogeneous functions, we have

$$F(\xi, \psi) = \lambda^n F(x, y).$$

We differentiate this equation with respect to  $\lambda$ .

$$\begin{aligned} \frac{\partial F(\xi, \psi)}{\partial \xi} \frac{\partial \xi}{\partial \lambda} + \frac{\partial F(\xi, \psi)}{\partial \psi} \frac{\partial \psi}{\partial \lambda} &= n\lambda^{n-1} F(x, y) \\ xF_\xi + yF_\psi &= n\lambda^{n-1} F(x, y) \end{aligned}$$

Setting  $\lambda = 1$ , (and hence  $\xi = x$ ,  $\psi = y$ ), proves Euler's theorem.

**Result 14.4.3 Euler's Theorem on Homogeneous Functions.** If  $F(x, y)$  is a homogeneous function of degree  $n$ , then

$$xF_x + yF_y = nF.$$

**Homogeneous Coefficient Differential Equations.** If the coefficient functions  $P(x, y)$  and  $Q(x, y)$  are homogeneous of degree  $n$  then the differential equation,

$$P(x, y) + Q(x, y) \frac{dy}{dx} = 0, \quad (14.4)$$

is called a *homogeneous coefficient equation*. They are often referred to simply as *homogeneous equations*.

**Transformation to a Separable Equation.** We can write the homogeneous equation in the form,

$$\begin{aligned} x^n P\left(1, \frac{y}{x}\right) + x^n Q\left(1, \frac{y}{x}\right) \frac{dy}{dx} &= 0, \\ P\left(1, \frac{y}{x}\right) + Q\left(1, \frac{y}{x}\right) \frac{dy}{dx} &= 0. \end{aligned}$$

This suggests the change of dependent variable  $u(x) = \frac{y(x)}{x}$ .

$$P(1, u) + Q(1, u) \left(u + x \frac{du}{dx}\right) = 0$$

This equation is separable.

$$\begin{aligned} P(1, u) + uQ(1, u) + xQ(1, u) \frac{du}{dx} &= 0 \\ \frac{1}{x} + \frac{Q(1, u)}{P(1, u) + uQ(1, u)} \frac{du}{dx} &= 0 \\ \ln|x| + \int \frac{1}{u + P(1, u)/Q(1, u)} du &= c \end{aligned}$$

By substituting  $\ln|c|$  for  $c$ , we can write this in a simpler form.

$$\int \frac{1}{u + P(1, u)/Q(1, u)} du = \ln \left| \frac{c}{x} \right|.$$

**Integrating Factor.** One can show that

$$\mu(x, y) = \frac{1}{xP(x, y) + yQ(x, y)}$$

is an integrating factor for the Equation 14.4. The proof of this is left as an exercise for the reader. (See Exercise 14.2.)

**Result 14.4.4 Homogeneous Coefficient Differential Equations.** If  $P(x, y)$  and  $Q(x, y)$  are homogeneous functions of degree  $n$ , then the equation

$$P(x, y) + Q(x, y) \frac{dy}{dx} = 0$$

is made separable by the change of independent variable  $u(x) = \frac{y(x)}{x}$ . The solution is determined by

$$\int \frac{1}{u + P(1, u)/Q(1, u)} du = \ln \left| \frac{c}{x} \right|.$$

Alternatively, the homogeneous equation can be made exact with the integrating factor

$$\mu(x, y) = \frac{1}{xP(x, y) + yQ(x, y)}.$$

**Example 14.4.5** Consider the homogeneous coefficient equation

$$x^2 - y^2 + xy \frac{dy}{dx} = 0.$$

The solution for  $u(x) = y(x)/x$  is determined by

$$\int \frac{1}{u + \frac{1-u^2}{u}} du = \ln \left| \frac{c}{x} \right|$$
$$\int u du = \ln \left| \frac{c}{x} \right|$$
$$\frac{1}{2}u^2 = \ln \left| \frac{c}{x} \right|$$
$$u = \pm \sqrt{2 \ln |c/x|}$$

Thus the solution of the differential equation is

$$y = \pm x \sqrt{2 \ln |c/x|}$$

## Exercise 14.2

Show that

$$\mu(x, y) = \frac{1}{xP(x, y) + yQ(x, y)}$$

is an integrating factor for the homogeneous equation,

$$P(x, y) + Q(x, y) \frac{dy}{dx} = 0.$$

Hint, Solution

## Exercise 14.3 (mathematica/ode/first\_order/exact.nb)

Find the general solution of the equation

$$\frac{dy}{dt} = 2\frac{y}{t} + \left(\frac{y}{t}\right)^2.$$

Hint, Solution

## 14.5 The First Order, Linear Differential Equation

### 14.5.1 Homogeneous Equations

The first order, linear, homogeneous equation has the form

$$\frac{dy}{dx} + p(x)y = 0.$$

Note that if we can find one solution, then any constant times that solution also satisfies the equation. In fact, all the solutions of this equation differ only by multiplicative constants. We can solve any equation of this type because it is separable.

$$\begin{aligned}\frac{y'}{y} &= -p(x) \\ \ln |y| &= - \int p(x) dx + c \\ y &= \pm e^{-\int p(x) dx + c} \\ y &= c e^{-\int p(x) dx}\end{aligned}$$

**Result 14.5.1 First Order, Linear Homogeneous Differential Equations.** The first order, linear, homogeneous differential equation,

$$\frac{dy}{dx} + p(x)y = 0,$$

has the solution

$$y = c e^{-\int p(x) dx}. \quad (14.5)$$

The solutions differ by multiplicative constants.

**Example 14.5.1** Consider the equation

$$\frac{dy}{dx} + \frac{1}{x}y = 0.$$

We use Equation 14.5 to determine the solution.

$$y(x) = c e^{-\int 1/x \, dx}, \quad \text{for } x \neq 0$$

$$y(x) = c e^{-\ln|x|}$$

$$y(x) = \frac{c}{|x|}$$

$$\boxed{y(x) = \frac{c}{x}}$$

## 14.5.2 Inhomogeneous Equations

The first order, linear, inhomogeneous differential equation has the form

$$\frac{dy}{dx} + p(x)y = f(x). \tag{14.6}$$

This equation is not separable. Note that it is similar to the exact equation we solved in Example 14.4.4,

$$g(x)y'(x) + g'(x)y(x) = f(x).$$

To solve Equation 14.6, we multiply by an *integrating factor*. Multiplying a differential equation by its integrating factor changes it to an exact equation. Multiplying Equation 14.6 by the function,  $I(x)$ , yields,

$$I(x)\frac{dy}{dx} + p(x)I(x)y = f(x)I(x).$$

In order that  $I(x)$  be an integrating factor, it must satisfy

$$\frac{d}{dx}I(x) = p(x)I(x).$$



This is a first order, linear, homogeneous equation with the solution

$$I(x) = c e^{\int p(x) dx}.$$

This is an integrating factor for any constant  $c$ . For simplicity we will choose  $c = 1$ .

To solve Equation 14.6 we multiply by the integrating factor and integrate. Let  $P(x) = \int p(x) dx$ .

$$\begin{aligned} e^{P(x)} \frac{dy}{dx} + p(x) e^{P(x)} y &= e^{P(x)} f(x) \\ \frac{d}{dx} (e^{P(x)} y) &= e^{P(x)} f(x) \\ y &= e^{-P(x)} \int e^{P(x)} f(x) dx + c e^{-P(x)} \\ y &\equiv y_p + c y_h \end{aligned}$$

Note that the *general solution* is the sum of a *particular solution*,  $y_p$ , that satisfies  $y' + p(x)y = f(x)$ , and an arbitrary constant times a *homogeneous solution*,  $y_h$ , that satisfies  $y' + p(x)y = 0$ .

**Example 14.5.2** Consider the differential equation

$$y' + \frac{1}{x}y = x^2, \quad x > 0.$$

First we find the integrating factor.

$$I(x) = \exp\left(\int \frac{1}{x} dx\right) = e^{\ln x} = x$$

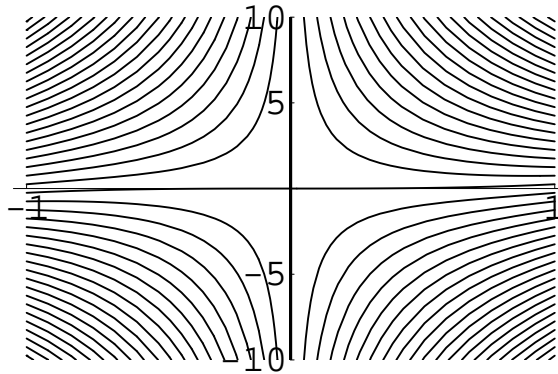

Figure 14.4: Solutions to  $y' + y/x = x^2$ .

We multiply by the integrating factor and integrate.

$$\begin{aligned}\frac{d}{dx}(xy) &= x^3 \\ xy &= \frac{1}{4}x^4 + c \\ \boxed{y} &= \frac{1}{4}x^3 + \frac{c}{x}.\end{aligned}$$

The particular and homogeneous solutions are

$$y_p = \frac{1}{4}x^3 \quad \text{and} \quad y_h = \frac{1}{x}.$$

Note that the general solution to the differential equation is a one-parameter family of functions. The general solution is plotted in Figure 14.4 for various values of  $c$ .

### Exercise 14.4 (mathematica/ode/first\_order/linear.nb)

Solve the differential equation

$$y' - \frac{1}{x}y = x^\alpha, \quad x > 0.$$

Hint, Solution

### 14.5.3 Variation of Parameters.

We could also have found the particular solution with the method of variation of parameters. Although we can solve first order equations without this method, it will become important in the study of higher order inhomogeneous equations. We begin by assuming that the particular solution has the form  $y_p = u(x)y_h(x)$  where  $u(x)$  is an unknown function. We substitute this into the differential equation.

$$\begin{aligned}\frac{d}{dx}y_p + p(x)y_p &= f(x) \\ \frac{d}{dx}(uy_h) + p(x)uy_h &= f(x) \\ u'y_h + u(y_h' + p(x)y_h) &= f(x)\end{aligned}$$

Since  $y_h$  is a homogeneous solution,  $y_h' + p(x)y_h = 0$ .

$$\begin{aligned}u' &= \frac{f(x)}{y_h} \\ u &= \int \frac{f(x)}{y_h(x)} dx\end{aligned}$$

Recall that the homogeneous solution is  $y_h = e^{-P(x)}$ .

$$u = \int e^{P(x)} f(x) dx$$

Thus the particular solution is

$$y_p = e^{-P(x)} \int e^{P(x)} f(x) dx.$$

## 14.6 Initial Conditions

In physical problems involving first order differential equations, the solution satisfies both the differential equation and a constraint which we call the *initial condition*. Consider a first order linear differential equation subject to the initial condition  $y(x_0) = y_0$ . The general solution is

$$y = y_p + cy_h = e^{-P(x)} \int e^{P(x)} f(x) dx + c e^{-P(x)}.$$

For the moment, we will assume that this problem is *well-posed*. A problem is well-posed if there is a unique solution to the differential equation that satisfies the constraint(s). Recall that  $\int e^{P(x)} f(x) dx$  denotes any integral of  $e^{P(x)} f(x)$ . For convenience, we choose  $\int_{x_0}^x e^{P(\xi)} f(\xi) d\xi$ . The initial condition requires that

$$y(x_0) = y_0 = e^{-P(x_0)} \int_{x_0}^{x_0} e^{P(\xi)} f(\xi) d\xi + c e^{-P(x_0)} = c e^{-P(x_0)}.$$

Thus  $c = y_0 e^{P(x_0)}$ . The solution subject to the initial condition is

$$y = e^{-P(x)} \int_{x_0}^x e^{P(\xi)} f(\xi) d\xi + y_0 e^{P(x_0) - P(x)}.$$

**Example 14.6.1** Consider the problem

$$y' + (\cos x)y = x, \quad y(0) = 2.$$

From Result 14.6.1, the solution subject to the initial condition is

$$y = e^{-\sin x} \int_0^x \xi e^{\sin \xi} d\xi + 2 e^{-\sin x}.$$

## 14.6.1 Piecewise Continuous Coefficients and Inhomogeneities

If the coefficient function  $p(x)$  and the inhomogeneous term  $f(x)$  in the first order linear differential equation

$$\frac{dy}{dx} + p(x)y = f(x)$$

are continuous, then the solution is continuous and has a continuous first derivative. To see this, we note that the solution

$$y = e^{-P(x)} \int e^{P(x)} f(x) dx + c e^{-P(x)}$$

is continuous since the integral of a piecewise continuous function is continuous. The first derivative of the solution can be found directly from the differential equation.

$$y' = -p(x)y + f(x)$$

Since  $p(x)$ ,  $y$ , and  $f(x)$  are continuous,  $y'$  is continuous.

If  $p(x)$  or  $f(x)$  is only piecewise continuous, then the solution will be continuous since the integral of a piecewise continuous function is continuous. The first derivative of the solution will be piecewise continuous.

**Example 14.6.2** Consider the problem

$$y' - y = H(x - 1), \quad y(0) = 1,$$

where  $H(x)$  is the Heaviside function.

$$H(x) = \begin{cases} 1 & \text{for } x > 0, \\ 0 & \text{for } x < 0. \end{cases}$$

To solve this problem, we divide it into two equations on separate domains.

$$\begin{aligned} y_1' - y_1 &= 0, & y_1(0) &= 1, & \text{for } x < 1 \\ y_2' - y_2 &= 1, & y_2(1) &= y_1(1), & \text{for } x > 1 \end{aligned}$$

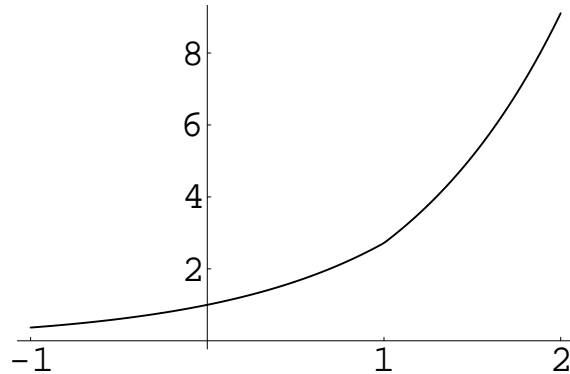

Figure 14.5: Solution to  $y' - y = H(x - 1)$ .

With the condition  $y_2(1) = y_1(1)$  on the second equation, we demand that the solution be continuous. The solution to the first equation is  $y = e^x$ . The solution for the second equation is

$$y = e^x \int_1^x e^{-\xi} d\xi + e^1 e^{x-1} = -1 + e^{x-1} + e^x.$$

Thus the solution over the whole domain is

$$y = \begin{cases} e^x & \text{for } x < 1, \\ (1 + e^{-1})e^x - 1 & \text{for } x > 1. \end{cases}$$

The solution is graphed in Figure 14.5.

**Example 14.6.3** Consider the problem,

$$y' + \text{sign}(x)y = 0, \quad y(1) = 1.$$

Recall that

$$\text{sign } x = \begin{cases} -1 & \text{for } x < 0 \\ 0 & \text{for } x = 0 \\ 1 & \text{for } x > 0. \end{cases}$$

Since  $\text{sign } x$  is piecewise defined, we solve the two problems,

$$\begin{aligned} y'_+ + y_+ &= 0, & y_+(1) &= 1, & \text{for } x > 0 \\ y'_- - y_- &= 0, & y_-(0) &= y_+(0), & \text{for } x < 0, \end{aligned}$$

and define the solution,  $y$ , to be

$$y(x) = \begin{cases} y_+(x), & \text{for } x \geq 0, \\ y_-(x), & \text{for } x \leq 0. \end{cases}$$

The initial condition for  $y_-$  demands that the solution be continuous.

Solving the two problems for positive and negative  $x$ , we obtain

$$y(x) = \begin{cases} e^{1-x}, & \text{for } x > 0, \\ e^{1+x}, & \text{for } x < 0. \end{cases}$$

This can be simplified to

$$\boxed{y(x) = e^{1-|x|}.}$$

This solution is graphed in Figure 14.6.

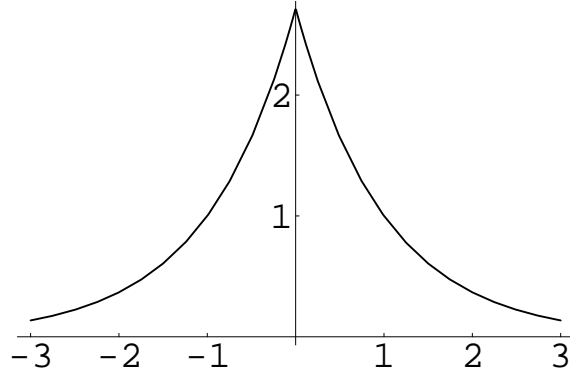

Figure 14.6: Solution to  $y' + \text{sign}(x)y = 0$ .

**Result 14.6.1 Existence, Uniqueness Theorem.** Let  $p(x)$  and  $f(x)$  be piecewise continuous on the interval  $[a, b]$  and let  $x_0 \in [a, b]$ . Consider the problem,

$$\frac{dy}{dx} + p(x)y = f(x), \quad y(x_0) = y_0.$$

The general solution of the differential equation is

$$y = e^{-P(x)} \int e^{P(x)} f(x) dx + c e^{-P(x)}.$$

The unique, continuous solution of the differential equation subject to the initial condition is

$$y = e^{-P(x)} \int_{x_0}^x e^{P(\xi)} f(\xi) d\xi + y_0 e^{P(x_0) - P(x)},$$

where  $P(x) = \int p(x) dx$ .



### Exercise 14.5 (mathematica/ode/first\_order/exact.nb)

Find the solutions of the following differential equations which satisfy the given initial conditions:

1.  $\frac{dy}{dx} + xy = x^{2n+1}$ ,  $y(1) = 1$ ,  $n \in \mathbb{Z}$
2.  $\frac{dy}{dx} - 2xy = 1$ ,  $y(0) = 1$

Hint, Solution

### Exercise 14.6 (mathematica/ode/first\_order/exact.nb)

Show that if  $\alpha > 0$  and  $\lambda > 0$ , then for any real  $\beta$ , every solution of

$$\frac{dy}{dx} + \alpha y(x) = \beta e^{-\lambda x}$$

satisfies  $\lim_{x \rightarrow +\infty} y(x) = 0$ . (The case  $\alpha = \lambda$  requires special treatment.) Find the solution for  $\beta = \lambda = 1$  which satisfies  $y(0) = 1$ . Sketch this solution for  $0 \leq x < \infty$  for several values of  $\alpha$ . In particular, show what happens when  $\alpha \rightarrow 0$  and  $\alpha \rightarrow \infty$ .

Hint, Solution

## 14.7 Well-Posed Problems

**Example 14.7.1** Consider the problem,

$$y' - \frac{1}{x}y = 0, \quad y(0) = 1.$$

The general solution is  $y = cx$ . Applying the initial condition demands that  $1 = c \cdot 0$ , which cannot be satisfied. The general solution for various values of  $c$  is plotted in Figure 14.7.

**Example 14.7.2** Consider the problem

$$y' - \frac{1}{x}y = -\frac{1}{x}, \quad y(0) = 1.$$

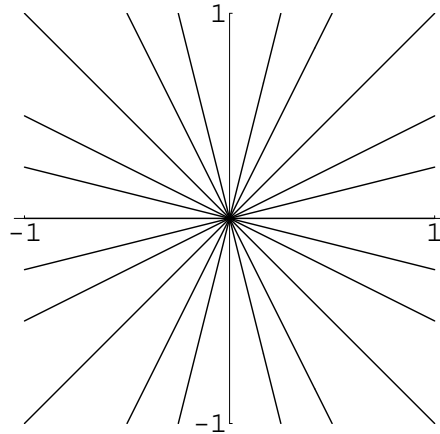

Figure 14.7: Solutions to  $y' - y/x = 0$ .

The general solution is

$$y = 1 + cx.$$

The initial condition is satisfied for any value of  $c$  so there are an infinite number of solutions.

**Example 14.7.3** Consider the problem

$$y' + \frac{1}{x}y = 0, \quad y(0) = 1.$$

The general solution is  $y = \frac{c}{x}$ . Depending on whether  $c$  is nonzero, the solution is either singular or zero at the origin and cannot satisfy the initial condition.

The above problems in which there were either no solutions or an infinite number of solutions are said to be *ill-posed*. If there is a unique solution that satisfies the initial condition, the problem is said to be *well-posed*. We should have suspected that we would run into trouble in the above examples as the initial condition was given at a singularity of the coefficient function,  $p(x) = 1/x$ .

Consider the problem,

$$y' + p(x)y = f(x), \quad y(x_0) = y_0.$$

We assume that  $f(x)$  bounded in a neighborhood of  $x = x_0$ . The differential equation has the general solution,

$$y = e^{-P(x)} \int e^{P(x)} f(x) dx + c e^{-P(x)}.$$

If the homogeneous solution,  $e^{-P(x)}$ , is nonzero and finite at  $x = x_0$ , then there is a unique value of  $c$  for which the initial condition is satisfied. If the homogeneous solution vanishes at  $x = x_0$  then either the initial condition cannot be satisfied or the initial condition is satisfied for all values of  $c$ . The homogeneous solution can vanish or be infinite only if  $P(x) \rightarrow \pm\infty$  as  $x \rightarrow x_0$ . This can occur only if the coefficient function,  $p(x)$ , is unbounded at that point.

**Result 14.7.1** If the initial condition is given where the homogeneous solution to a first order, linear differential equation is zero or infinite then the problem may be ill-posed. This may occur only if the coefficient function,  $p(x)$ , is unbounded at that point.

## 14.8 Equations in the Complex Plane

### 14.8.1 Ordinary Points

Consider the first order homogeneous equation

$$\frac{dw}{dz} + p(z)w = 0,$$

where  $p(z)$ , a function of a complex variable, is analytic in some domain  $D$ . The integrating factor,

$$I(z) = \exp \left( \int p(z) dz \right),$$

is an analytic function in that domain. As with the case of real variables, multiplying by the integrating factor and integrating yields the solution,

$$w(z) = c \exp \left( - \int p(z) dz \right).$$

We see that the solution is analytic in  $D$ .

**Example 14.8.1** *It does not make sense to pose the equation*

$$\frac{dw}{dz} + |z|w = 0.$$

*For the solution to exist,  $w$  and hence  $w'(z)$  must be analytic. Since  $p(z) = |z|$  is not analytic anywhere in the complex plane, the equation has no solution.*

Any point at which  $p(z)$  is analytic is called an *ordinary point* of the differential equation. Since the solution is analytic we can expand it in a Taylor series about an ordinary point. The radius of convergence of the series will be at least the distance to the nearest singularity of  $p(z)$  in the complex plane.

**Example 14.8.2** *Consider the equation*

$$\frac{dw}{dz} - \frac{1}{1-z}w = 0.$$

*The general solution is  $w = \frac{c}{1-z}$ . Expanding this solution about the origin,*

$$w = \frac{c}{1-z} = c \sum_{n=0}^{\infty} z^n.$$

*The radius of convergence of the series is,*

$$R = \lim_{n \rightarrow \infty} \left| \frac{a_n}{a_{n+1}} \right| = 1,$$

*which is the distance from the origin to the nearest singularity of  $p(z) = \frac{1}{1-z}$ .*

We do not need to solve the differential equation to find the Taylor series expansion of the homogeneous solution. We could substitute a general Taylor series expansion into the differential equation and solve for the coefficients. Since we can always solve first order equations, this method is of limited usefulness. However, when we consider higher order equations in which we cannot solve the equations exactly, this will become an important method.

**Example 14.8.3** Again consider the equation

$$\frac{dw}{dz} - \frac{1}{1-z}w = 0.$$

Since we know that the solution has a Taylor series expansion about  $z = 0$ , we substitute  $w = \sum_{n=0}^{\infty} a_n z^n$  into the differential equation.

$$\begin{aligned} (1-z) \frac{d}{dz} \sum_{n=0}^{\infty} a_n z^n - \sum_{n=0}^{\infty} a_n z^n &= 0 \\ \sum_{n=1}^{\infty} n a_n z^{n-1} - \sum_{n=1}^{\infty} n a_n z^n - \sum_{n=0}^{\infty} a_n z^n &= 0 \\ \sum_{n=0}^{\infty} (n+1) a_{n+1} z^n - \sum_{n=0}^{\infty} n a_n z^n - \sum_{n=0}^{\infty} a_n z^n &= 0 \\ \sum_{n=0}^{\infty} ((n+1) a_{n+1} - (n+1) a_n) z^n &= 0. \end{aligned}$$

Now we equate powers of  $z$  to zero. For  $z^n$ , the equation is  $(n+1)a_{n+1} - (n+1)a_n = 0$ , or  $a_{n+1} = a_n$ . Thus we have that  $a_n = a_0$  for all  $n \geq 1$ . The solution is then

$$w = a_0 \sum_{n=0}^{\infty} z^n,$$

which is the result we obtained by expanding the solution in Example 14.8.2.

**Result 14.8.1** Consider the equation

$$\frac{dw}{dz} + p(z)w = 0.$$

If  $p(z)$  is analytic at  $z = z_0$  then  $z_0$  is called an ordinary point of the differential equation. The Taylor series expansion of the solution can be found by substituting  $w = \sum_{n=0}^{\infty} a_n(z - z_0)^n$  into the equation and equating powers of  $(z - z_0)$ . The radius of convergence of the series is at least the distance to the nearest singularity of  $p(z)$  in the complex plane.

### Exercise 14.7

Find the Taylor series expansion about the origin of the solution to

$$\frac{dw}{dz} + \frac{1}{1-z}w = 0$$

with the substitution  $w = \sum_{n=0}^{\infty} a_n z^n$ . What is the radius of convergence of the series? What is the distance to the nearest singularity of  $\frac{1}{1-z}$ ?

**Hint, Solution**

## 14.8.2 Regular Singular Points

If the coefficient function  $p(z)$  has a simple pole at  $z = z_0$  then  $z_0$  is a *regular singular point* of the first order differential equation.

**Example 14.8.4** Consider the equation

$$\frac{dw}{dz} + \frac{\alpha}{z}w = 0, \quad \alpha \neq 0.$$

This equation has a regular singular point at  $z = 0$ . The solution is  $w = cz^{-\alpha}$ . Depending on the value of  $\alpha$ , the solution can have three different kinds of behavior.

**$\alpha$  is a negative integer.** The solution is analytic in the finite complex plane.

**$\alpha$  is a positive integer** The solution has a pole at the origin.  $w$  is analytic in the annulus,  $0 < |z|$ .

**$\alpha$  is not an integer.**  $w$  has a branch point at  $z = 0$ . The solution is analytic in the cut annulus  $0 < |z| < \infty$ ,  $\theta_0 < \arg z < \theta_0 + 2\pi$ .

Consider the differential equation

$$\frac{dw}{dz} + p(z)w = 0,$$

where  $p(z)$  has a simple pole at the origin and is analytic in the annulus,  $0 < |z| < r$ , for some positive  $r$ . Recall that the solution is

$$\begin{aligned} w &= c \exp\left(-\int p(z) dz\right) \\ &= c \exp\left(-\int \frac{b_0}{z} + p(z) - \frac{b_0}{z} dz\right) \\ &= c \exp\left(-b_0 \log z - \int \frac{zp(z) - b_0}{z} dz\right) \\ &= cz^{-b_0} \exp\left(-\int \frac{zp(z) - b_0}{z} dz\right) \end{aligned}$$

The exponential factor has a removable singularity at  $z = 0$  and is analytic in  $|z| < r$ . We consider the following cases for the  $z^{-b_0}$  factor:

**$b_0$  is a negative integer.** Since  $z^{-b_0}$  is analytic at the origin, the solution to the differential equation is analytic in the circle  $|z| < r$ .

**$b_0$  is a positive integer.** The solution has a pole of order  $-b_0$  at the origin and is analytic in the annulus  $0 < |z| < r$ .

**$b_0$  is not an integer.** The solution has a branch point at the origin  $z$  and thus is not single-valued. The solution is analytic in the cut annulus  $0 < |z| < r$ ,  $\theta_0 < \arg z < \theta_0 + 2\pi$ .

Since the exponential factor has a convergent Taylor series in  $|z| < r$ , the solution can be expanded in a series of the form

$$w = z^{-b_0} \sum_{n=0}^{\infty} a_n z^n, \quad \text{where } a_0 \neq 0 \text{ and } b_0 = \lim_{z \rightarrow 0} z p(z).$$

In the case of a regular singular point at  $z = z_0$ , the series is

$$w = (z - z_0)^{-b_0} \sum_{n=0}^{\infty} a_n (z - z_0)^n, \quad \text{where } a_0 \neq 0 \text{ and } b_0 = \lim_{z \rightarrow z_0} (z - z_0) p(z).$$

Series of this form are known as *Frobenius series*. Since we can write the solution as

$$w = c(z - z_0)^{-b_0} \exp \left( - \int \left( p(z) - \frac{b_0}{z - z_0} \right) dz \right),$$

we see that the Frobenius expansion of the solution will have a radius of convergence at least the distance to the nearest singularity of  $p(z)$ .



**Result 14.8.2** Consider the equation,

$$\frac{dw}{dz} + p(z)w = 0,$$

where  $p(z)$  has a simple pole at  $z = z_0$ ,  $p(z)$  is analytic in some annulus,  $0 < |z - z_0| < r$ , and  $\lim_{z \rightarrow z_0} (z - z_0)p(z) = \beta$ . The solution to the differential equation has a Frobenius series expansion of the form

$$w = (z - z_0)^{-\beta} \sum_{n=0}^{\infty} a_n (z - z_0)^n, \quad a_0 \neq 0.$$

The radius of convergence of the expansion will be at least the distance to the nearest singularity of  $p(z)$ .

**Example 14.8.5** We will find the first two nonzero terms in the series solution about  $z = 0$  of the differential equation,

$$\frac{dw}{dz} + \frac{1}{\sin z} w = 0.$$

First we note that the coefficient function has a simple pole at  $z = 0$  and

$$\lim_{z \rightarrow 0} \frac{z}{\sin z} = \lim_{z \rightarrow 0} \frac{1}{\cos z} = 1.$$

Thus we look for a series solution of the form

$$w = z^{-1} \sum_{n=0}^{\infty} a_n z^n, \quad a_0 \neq 0.$$

The nearest singularities of  $1/\sin z$  in the complex plane are at  $z = \pm\pi$ . Thus the radius of convergence of the series will be at least  $\pi$ .

Substituting the first three terms of the expansion into the differential equation,

$$\frac{d}{dz}(a_0z^{-1} + a_1 + a_2z) + \frac{1}{\sin z}(a_0z^{-1} + a_1 + a_2z) = O(z).$$

Recall that the Taylor expansion of  $\sin z$  is  $\sin z = z - \frac{1}{6}z^3 + O(z^5)$ .

$$\begin{aligned} \left(z - \frac{z^3}{6} + O(z^5)\right) (-a_0z^{-2} + a_2) + (a_0z^{-1} + a_1 + a_2z) &= O(z^2) \\ -a_0z^{-1} + \left(a_2 + \frac{a_0}{6}\right)z + a_0z^{-1} + a_1 + a_2z &= O(z^2) \\ a_1 + \left(2a_2 + \frac{a_0}{6}\right)z &= O(z^2) \end{aligned}$$

$a_0$  is arbitrary. Equating powers of  $z$ ,

$$z^0 : \quad a_1 = 0.$$

$$z^1 : \quad 2a_2 + \frac{a_0}{6} = 0.$$

Thus the solution has the expansion,

$$w = a_0 \left( z^{-1} - \frac{z}{12} \right) + O(z^2).$$

In Figure 14.8 the exact solution is plotted in a solid line and the two term approximation is plotted in a dashed line. The two term approximation is very good near the point  $x = 0$ .

**Example 14.8.6** Find the first two nonzero terms in the series expansion about  $z = 0$  of the solution to

$$w' - i \frac{\cos z}{z} w = 0.$$

Since  $\frac{\cos z}{z}$  has a simple pole at  $z = 0$  and  $\lim_{z \rightarrow 0} -i \cos z = -i$  we see that the Frobenius series will have the form

$$w = z^i \sum_{n=0}^{\infty} a_n z^n, \quad a_0 \neq 0.$$

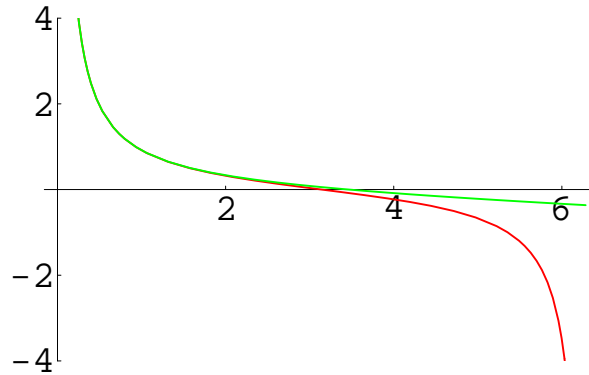

Figure 14.8: Plot of the exact solution and the two term approximation.

Recall that  $\cos z$  has the Taylor expansion  $\sum_{n=0}^{\infty} \frac{(-1)^n z^{2n}}{(2n)!}$ . Substituting the Frobenius expansion into the differential equation yields

$$z \left( iz^{i-1} \sum_{n=0}^{\infty} a_n z^n + z^i \sum_{n=0}^{\infty} n a_n z^{n-1} \right) - i \left( \sum_{n=0}^{\infty} \frac{(-1)^n z^{2n}}{(2n)!} \right) \left( z^i \sum_{n=0}^{\infty} a_n z^n \right) = 0$$

$$\sum_{n=0}^{\infty} (n+i) a_n z^n - i \left( \sum_{n=0}^{\infty} \frac{(-1)^n z^{2n}}{(2n)!} \right) \left( \sum_{n=0}^{\infty} a_n z^n \right) = 0.$$

Equating powers of  $z$ ,

$$z^0: \quad ia_0 - ia_0 = 0 \quad \rightarrow a_0 \text{ is arbitrary}$$

$$z^1: \quad (1+i)a_1 - ia_1 = 0 \quad \rightarrow a_1 = 0$$

$$z^2: \quad (2+i)a_2 - ia_2 + \frac{i}{2}a_0 = 0 \quad \rightarrow a_2 = -\frac{i}{4}a_0.$$

Thus the solution is

$$w = a_0 z^i \left( 1 - \frac{i}{4} z^2 + O(z^3) \right).$$

### 14.8.3 Irregular Singular Points

If a point is not an ordinary point or a regular singular point then it is called an *irregular singular point*. The following equations have irregular singular points at the origin.

- $w' + \sqrt{z}w = 0$
- $w' - z^{-2}w = 0$
- $w' + \exp(1/z)w = 0$

**Example 14.8.7** Consider the differential equation

$$\frac{dw}{dz} + \alpha z^\beta w = 0, \quad \alpha \neq 0, \quad \beta \neq -1, 0, 1, 2, \dots$$

This equation has an irregular singular point at the origin. Solving this equation,

$$\frac{d}{dz} \left( \exp \left( \int \alpha z^\beta dz \right) w \right) = 0$$

$$w = c \exp \left( -\frac{\alpha}{\beta+1} z^{\beta+1} \right) = c \sum_{n=0}^{\infty} \frac{(-1)^n}{n!} \left( \frac{\alpha}{\beta+1} \right)^n z^{(\beta+1)n}.$$

If  $\beta$  is not an integer, then the solution has a branch point at the origin. If  $\beta$  is an integer,  $\beta < -1$ , then the solution has an essential singularity at the origin. The solution cannot be expanded in a Frobenius series,  $w = z^\lambda \sum_{n=0}^{\infty} a_n z^n$ .

Although we will not show it, this result holds for any irregular singular point of the differential equation. We cannot approximate the solution near an irregular singular point using a Frobenius expansion.

Now would be a good time to summarize what we have discovered about solutions of first order differential equations in the complex plane.

**Result 14.8.3** Consider the first order differential equation

$$\frac{dw}{dz} + p(z)w = 0.$$

**Ordinary Points** If  $p(z)$  is analytic at  $z = z_0$  then  $z_0$  is an ordinary point of the differential equation. The solution can be expanded in the Taylor series  $w = \sum_{n=0}^{\infty} a_n(z - z_0)^n$ . The radius of convergence of the series is at least the distance to the nearest singularity of  $p(z)$  in the complex plane.

**Regular Singular Points** If  $p(z)$  has a simple pole at  $z = z_0$  and is analytic in some annulus  $0 < |z - z_0| < r$  then  $z_0$  is a regular singular point of the differential equation. The solution at  $z_0$  will either be analytic, have a pole, or have a branch point. The solution can be expanded in the Frobenius series  $w = (z - z_0)^{-\beta} \sum_{n=0}^{\infty} a_n(z - z_0)^n$  where  $a_0 \neq 0$  and  $\beta = \lim_{z \rightarrow z_0} (z - z_0)p(z)$ . The radius of convergence of the Frobenius series will be at least the distance to the nearest singularity of  $p(z)$ .

**Irregular Singular Points** If the point  $z = z_0$  is not an ordinary point or a regular singular point, then it is an irregular singular point of the differential equation. The solution cannot be expanded in a Frobenius series about that point.

## 14.8.4 The Point at Infinity

Now we consider the behavior of first order linear differential equations at the point at infinity. Recall from complex variables that the complex plane together with the point at infinity is called the extended complex plane. To study the behavior of a function  $f(z)$  at infinity, we make the transformation  $z = \frac{1}{\zeta}$  and study the behavior of  $f(1/\zeta)$  at  $\zeta = 0$ .

**Example 14.8.8** *Let's examine the behavior of  $\sin z$  at infinity. We make the substitution  $z = 1/\zeta$  and find the Laurent expansion about  $\zeta = 0$ .*

$$\sin(1/\zeta) = \sum_{n=0}^{\infty} \frac{(-1)^n}{(2n+1)! \zeta^{(2n+1)}}$$

*Since  $\sin(1/\zeta)$  has an essential singularity at  $\zeta = 0$ ,  $\sin z$  has an essential singularity at infinity.*

We use the same approach if we want to examine the behavior at infinity of a differential equation. Starting with the first order differential equation,

$$\frac{dw}{dz} + p(z)w = 0,$$

we make the substitution

$$z = \frac{1}{\zeta}, \quad \frac{d}{dz} = -\zeta^2 \frac{d}{d\zeta}, \quad w(z) = u(\zeta)$$

to obtain

$$\begin{aligned} -\zeta^2 \frac{du}{d\zeta} + p(1/\zeta)u &= 0 \\ \frac{du}{d\zeta} - \frac{p(1/\zeta)}{\zeta^2}u &= 0. \end{aligned}$$

**Result 14.8.4** The behavior at infinity of

$$\frac{dw}{dz} + p(z)w = 0$$

is the same as the behavior at  $\zeta = 0$  of

$$\frac{du}{d\zeta} - \frac{p(1/\zeta)}{\zeta^2}u = 0.$$

**Example 14.8.9** We classify the singular points of the equation

$$\frac{dw}{dz} + \frac{1}{z^2 + 9}w = 0.$$

We factor the denominator of the fraction to see that  $z = i3$  and  $z = -i3$  are regular singular points.

$$\frac{dw}{dz} + \frac{1}{(z - i3)(z + i3)}w = 0$$

We make the transformation  $z = 1/\zeta$  to examine the point at infinity.

$$\begin{aligned}\frac{du}{d\zeta} - \frac{1}{\zeta^2} \frac{1}{(1/\zeta)^2 + 9}u &= 0 \\ \frac{du}{d\zeta} - \frac{1}{9\zeta^2 + 1}u &= 0\end{aligned}$$

Since the equation for  $u$  has a ordinary point at  $\zeta = 0$ ,  $z = \infty$  is a ordinary point of the equation for  $w$ .

## 14.9 Additional Exercises

### Exact Equations

#### Exercise 14.8 (mathematica/ode/first\_order/exact.nb)

Find the general solution  $y = y(x)$  of the equations

$$1. \frac{dy}{dx} = \frac{x^2 + xy + y^2}{x^2},$$

$$2. (4y - 3x) dx + (y - 2x) dy = 0.$$

Hint, Solution

#### Exercise 14.9 (mathematica/ode/first\_order/exact.nb)

Determine whether or not the following equations can be made exact. If so find the corresponding general solution.

$$1. (3x^2 - 2xy + 2) dx + (6y^2 - x^2 + 3) dy = 0$$

$$2. \frac{dy}{dx} = -\frac{ax + by}{bx + cy}$$

Hint, Solution

#### Exercise 14.10 (mathematica/ode/first\_order/exact.nb)

Find the solutions of the following differential equations which satisfy the given initial condition. In each case determine the interval in which the solution is defined.

$$1. \frac{dy}{dx} = (1 - 2x)y^2, \quad y(0) = -1/6.$$

$$2. x dx + y e^{-x} dy = 0, \quad y(0) = 1.$$

Hint, Solution



### Exercise 14.11

Are the following equations exact? If so, solve them.

1.  $(4y - x)y' - (9x^2 + y - 1) = 0$

2.  $(2x - 2y)y' + (2x + 4y) = 0.$

[Hint](#), [Solution](#)

### Exercise 14.12 (mathematica/ode/first\_order/exact.nb)

Find all functions  $f(t)$  such that the differential equation

$$y^2 \sin t + yf(t)\frac{dy}{dt} = 0 \tag{14.7}$$

is exact. Solve the differential equation for these  $f(t)$ .

[Hint](#), [Solution](#)

## The First Order, Linear Differential Equation

### Exercise 14.13 (mathematica/ode/first\_order/linear.nb)

Solve the differential equation

$$y' + \frac{y}{\sin x} = 0.$$

[Hint](#), [Solution](#)

## Initial Conditions Well-Posed Problems

### Exercise 14.14

Find the solutions of

$$t\frac{dy}{dt} + Ay = 1 + t^2, \quad t > 0$$

which are bounded at  $t = 0$ . Consider all (real) values of  $A$ .

[Hint](#), [Solution](#)

## Equations in the Complex Plane

### Exercise 14.15

Classify the singular points of the following first order differential equations, (include the point at infinity).

1.  $w' + \frac{\sin z}{z}w = 0$

2.  $w' + \frac{1}{z-3}w = 0$

3.  $w' + z^{1/2}w = 0$

Hint, Solution

### Exercise 14.16

Consider the equation

$$w' + z^{-2}w = 0.$$

The point  $z = 0$  is an irregular singular point of the differential equation. Thus we know that we cannot expand the solution about  $z = 0$  in a Frobenius series. Try substituting the series solution

$$w = z^\lambda \sum_{n=0}^{\infty} a_n z^n, \quad a_0 \neq 0$$

into the differential equation anyway. What happens?

Hint, Solution

## 14.10 Hints

### Hint 14.1

1.  $\frac{d}{dx} \ln |u| = \frac{1}{u}$
2.  $\frac{d}{dx} u^c = u^{c-1} u'$

### Hint 14.2

### Hint 14.3

The equation is homogeneous. Make the change of variables  $u = y/t$ .

### Hint 14.4

Make sure you consider the case  $\alpha = 0$ .

### Hint 14.5

### Hint 14.6

### Hint 14.7

The radius of convergence of the series and the distance to the nearest singularity of  $\frac{1}{1-z}$  are not the same.

## Exact Equations

### Hint 14.8

- 1.
- 2.

**Hint 14.9**

1. The equation is exact. Determine the primitive  $u$  by solving the equations  $u_x = P$ ,  $u_y = Q$ .
2. The equation can be made exact.

**Hint 14.10**

1. This equation is separable. Integrate to get the general solution. Apply the initial condition to determine the constant of integration.
2. Ditto. You will have to numerically solve an equation to determine where the solution is defined.

**Hint 14.11****Hint 14.12****The First Order, Linear Differential Equation****Hint 14.13**

Look in the appendix for the integral of  $\csc x$ .

**Initial Conditions  
Well-Posed Problems****Hint 14.14****Equations in the Complex Plane****Hint 14.15**

**Hint 14.16**

Try to find the value of  $\lambda$  by substituting the series into the differential equation and equating powers of  $z$ .

## 14.11 Solutions

### Solution 14.1

1.

$$\frac{y'(x)}{y(x)} = f(x)$$

$$\frac{d}{dx} \ln |y(x)| = f(x)$$

$$\ln |y(x)| = \int f(x) dx + c$$

$$y(x) = \pm e^{\int f(x) dx + c}$$

$$\boxed{y(x) = c e^{\int f(x) dx}}$$

2.

$$y^\alpha(x) y'(x) = f(x)$$

$$\frac{y^{\alpha+1}(x)}{\alpha+1} = \int f(x) dx + c$$

$$\boxed{y(x) = \left( (\alpha+1) \int f(x) dx + a \right)^{1/(\alpha+1)}}$$

3.

$$\frac{y'}{\cos x} + y \frac{\tan x}{\cos x} = \cos x$$

$$\frac{d}{dx} \left( \frac{y}{\cos x} \right) = \cos x$$

$$\frac{y}{\cos x} = \sin x + c$$

$$\boxed{y(x) = \sin x \cos x + c \cos x}$$

### Solution 14.2

We consider the homogeneous equation,

$$P(x, y) + Q(x, y) \frac{dy}{dx} = 0.$$

That is, both  $P$  and  $Q$  are homogeneous of degree  $n$ . We hypothesize that multiplying by

$$\mu(x, y) = \frac{1}{xP(x, y) + yQ(x, y)}$$

will make the equation exact. To prove this we use the result that

$$M(x, y) + N(x, y) \frac{dy}{dx} = 0$$

is exact if and only if  $M_y = N_x$ .

$$\begin{aligned} M_y &= \frac{\partial}{\partial y} \left[ \frac{P}{xP + yQ} \right] \\ &= \frac{P_y(xP + yQ) - P(xP_y + Q + yQ_y)}{(xP + yQ)^2} \end{aligned}$$

$$\begin{aligned}
 N_x &= \frac{\partial}{\partial x} \left[ \frac{Q}{xP + yQ} \right] \\
 &= \frac{Q_x(xP + yQ) - Q(P + xP_x + yQ_x)}{(xP + yQ)^2}
 \end{aligned}$$

$$\begin{aligned}
 M_y &= N_x \\
 P_y(xP + yQ) - P(xP_y + Q + yQ_y) &= Q_x(xP + yQ) - Q(P + xP_x + yQ_x) \\
 yP_yQ - yPQ_y &= xPQ_x - xP_xQ \\
 xP_xQ + yP_yQ &= xPQ_x + yPQ_y \\
 (xP_x + yP_y)Q &= P(xQ_x + yQ_y)
 \end{aligned}$$

With Euler's theorem, this reduces to an identity.

$$nPQ = PnQ$$

Thus the equation is exact.  $\mu(x, y)$  is an integrating factor for the homogeneous equation.

### Solution 14.3

We note that this is a homogeneous differential equation. The coefficient of  $dy/dt$  and the inhomogeneity are homogeneous of degree zero.

$$\frac{dy}{dt} = 2 \left( \frac{y}{t} \right) + \left( \frac{y}{t} \right)^2.$$

We make the change of variables  $u = y/t$  to obtain a separable equation.

$$\begin{aligned}
 tu' + u &= 2u + u^2 \\
 \frac{u'}{u^2 + u} &= \frac{1}{t}
 \end{aligned}$$



Now we integrate to solve for  $u$ .

$$\begin{aligned}\frac{u'}{u(u+1)} &= \frac{1}{t} \\ \frac{u'}{u} - \frac{u'}{u+1} &= \frac{1}{t} \\ \ln|u| - \ln|u+1| &= \ln|t| + c \\ \ln\left|\frac{u}{u+1}\right| &= \ln|ct| \\ \frac{u}{u+1} &= \pm ct \\ \frac{u}{u+1} &= ct \\ u &= \frac{ct}{1-ct} \\ u &= \frac{t}{c-t} \\ \boxed{y = \frac{t^2}{c-t}}\end{aligned}$$

#### Solution 14.4

We consider

$$y' - \frac{1}{x}y = x^\alpha, \quad x > 0.$$

First we find the integrating factor.

$$I(x) = \exp\left(\int -\frac{1}{x} dx\right) = \exp(-\ln x) = \frac{1}{x}.$$

We multiply by the integrating factor and integrate.

$$\begin{aligned}\frac{1}{x}y' - \frac{1}{x^2}y &= x^{\alpha-1} \\ \frac{d}{dx} \left( \frac{1}{x}y \right) &= x^{\alpha-1} \\ \frac{1}{x}y &= \int x^{\alpha-1} dx + c \\ y &= x \int x^{\alpha-1} dx + cx\end{aligned}$$

$$y = \begin{cases} \frac{x^{\alpha+1}}{\alpha} + cx & \text{for } \alpha \neq 0, \\ x \ln x + cx & \text{for } \alpha = 0. \end{cases}$$

### Solution 14.5

1.

$$y' + xy = x^{2n+1}, \quad y(1) = 1, \quad n \in \mathbb{Z}$$

We find the integrating factor.

$$I(x) = e^{\int x dx} = e^{x^2/2}$$

We multiply by the integrating factor and integrate. Since the initial condition is given at  $x = 1$ , we will take the lower bound of integration to be that point.

$$\begin{aligned}\frac{d}{dx} \left( e^{x^2/2} y \right) &= x^{2n+1} e^{x^2/2} \\ y &= e^{-x^2/2} \int_1^x \xi^{2n+1} e^{\xi^2/2} d\xi + c e^{-x^2/2}\end{aligned}$$

We choose the constant of integration to satisfy the initial condition.

$$y = e^{-x^2/2} \int_1^x \xi^{2n+1} e^{\xi^2/2} d\xi + e^{(1-x^2)/2}$$

If  $n \geq 0$  then we can use integration by parts to write the integral as a sum of terms. If  $n < 0$  we can write the integral in terms of the exponential integral function. However, the integral form above is as nice as any other and we leave the answer in that form.

2.

$$\frac{dy}{dx} - 2xy(x) = 1, \quad y(0) = 1.$$

We determine the integrating factor and then integrate the equation.

$$\begin{aligned} I(x) &= e^{\int -2x dx} = e^{-x^2} \\ \frac{d}{dx} \left( e^{-x^2} y \right) &= e^{-x^2} \\ y &= e^{x^2} \int_0^x e^{-\xi^2} d\xi + c e^{x^2} \end{aligned}$$

We choose the constant of integration to satisfy the initial condition.

$$y = e^{x^2} \left( 1 + \int_0^x e^{-\xi^2} d\xi \right)$$

We can write the answer in terms of the *Error function*,

$$\operatorname{erf}(x) \equiv \frac{2}{\sqrt{\pi}} \int_0^x e^{-\xi^2} d\xi.$$

$$y = e^{x^2} \left( 1 + \frac{\sqrt{\pi}}{2} \operatorname{erf}(x) \right)$$

### Solution 14.6

We determine the integrating factor and then integrate the equation.

$$I(x) = e^{\int \alpha dx} = e^{\alpha x}$$
$$\frac{d}{dx} (e^{\alpha x} y) = \beta e^{(\alpha-\lambda)x}$$
$$y = \beta e^{-\alpha x} \int e^{(\alpha-\lambda)x} dx + c e^{-\alpha x}$$

First consider the case  $\alpha \neq \lambda$ .

$$y = \beta e^{-\alpha x} \frac{e^{(\alpha-\lambda)x}}{\alpha - \lambda} + c e^{-\alpha x}$$

$$y = \frac{\beta}{\alpha - \lambda} e^{-\lambda x} + c e^{-\alpha x}$$

Clearly the solution vanishes as  $x \rightarrow \infty$ .

Next consider  $\alpha = \lambda$ .

$$y = \beta e^{-\alpha x} x + c e^{-\alpha x}$$

$$y = (c + \beta x) e^{-\alpha x}$$

We use L'Hospital's rule to show that the solution vanishes as  $x \rightarrow \infty$ .

$$\lim_{x \rightarrow \infty} \frac{c + \beta x}{e^{\alpha x}} = \lim_{x \rightarrow \infty} \frac{\beta}{\alpha e^{\alpha x}} = 0$$

For  $\beta = \lambda = 1$ , the solution is

$$y = \begin{cases} \frac{1}{\alpha-1} e^{-x} + c e^{-\alpha x} & \text{for } \alpha \neq 1, \\ (c+x) e^{-x} & \text{for } \alpha = 1. \end{cases}$$

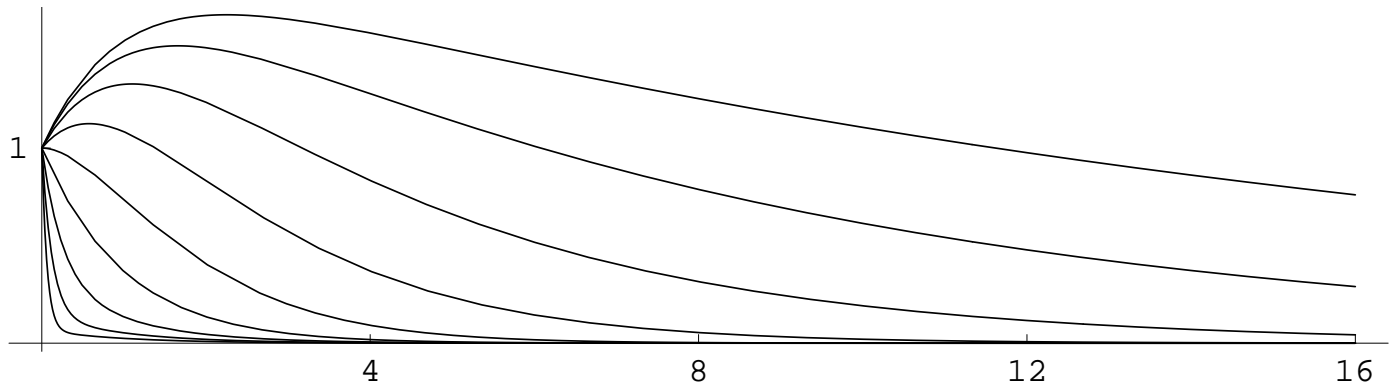

Figure 14.9: The Solution for a Range of  $\alpha$

The solution which satisfies the initial condition is

$$y = \begin{cases} \frac{1}{\alpha-1} (e^{-x} + (\alpha-2)e^{-\alpha x}) & \text{for } \alpha \neq 1, \\ (1+x)e^{-x} & \text{for } \alpha = 1. \end{cases}$$

In Figure 14.9 the solution is plotted for  $\alpha = 1/16, 1/8, \dots, 16$ .

Consider the solution in the limit as  $\alpha \rightarrow 0$ .

$$\begin{aligned} \lim_{\alpha \rightarrow 0} y(x) &= \lim_{\alpha \rightarrow 0} \frac{1}{\alpha-1} (e^{-x} + (\alpha-2)e^{-\alpha x}) \\ &= 2 - e^{-x} \end{aligned}$$

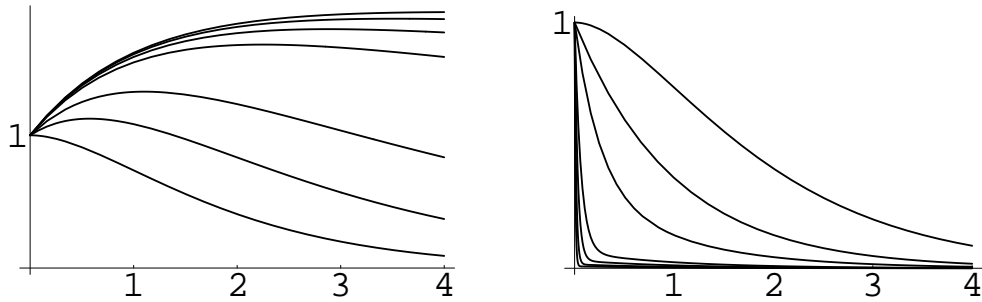

Figure 14.10: The Solution as  $\alpha \rightarrow 0$  and  $\alpha \rightarrow \infty$

In the limit as  $\alpha \rightarrow \infty$  we have,

$$\begin{aligned}
 \lim_{\alpha \rightarrow \infty} y(x) &= \lim_{\alpha \rightarrow \infty} \frac{1}{\alpha - 1} (e^{-x} + (\alpha - 2) e^{-\alpha x}) \\
 &= \lim_{\alpha \rightarrow \infty} \frac{\alpha - 2}{\alpha - 1} e^{-\alpha x} \\
 &= \begin{cases} 1 & \text{for } x = 0, \\ 0 & \text{for } x > 0. \end{cases}
 \end{aligned}$$

This behavior is shown in Figure 14.10. The first graph plots the solutions for  $\alpha = 1/128, 1/64, \dots, 1$ . The second graph plots the solutions for  $\alpha = 1, 2, \dots, 128$ .

**Solution 14.7**

We substitute  $w = \sum_{n=0}^{\infty} a_n z^n$  into the equation  $\frac{dw}{dz} + \frac{1}{1-z}w = 0$ .

$$\begin{aligned} \frac{d}{dz} \sum_{n=0}^{\infty} a_n z^n + \frac{1}{1-z} \sum_{n=0}^{\infty} a_n z^n &= 0 \\ (1-z) \sum_{n=1}^{\infty} n a_n z^{n-1} + \sum_{n=0}^{\infty} a_n z^n &= 0 \\ \sum_{n=0}^{\infty} (n+1) a_{n+1} z^n - \sum_{n=0}^{\infty} n a_n z^n + \sum_{n=0}^{\infty} a_n z^n &= 0 \\ \sum_{n=0}^{\infty} ((n+1) a_{n+1} - (n-1) a_n) z^n &= 0 \end{aligned}$$

Equating powers of  $z$  to zero, we obtain the relation,

$$a_{n+1} = \frac{n-1}{n+1} a_n.$$

$a_0$  is arbitrary. We can compute the rest of the coefficients from the recurrence relation.

$$\begin{aligned} a_1 &= \frac{-1}{1} a_0 = -a_0 \\ a_2 &= \frac{0}{2} a_1 = 0 \end{aligned}$$

We see that the coefficients are zero for  $n \geq 2$ . Thus the Taylor series expansion, (and the exact solution), is

$$w = a_0(1-z).$$

The radius of convergence of the series is infinite. The nearest singularity of  $\frac{1}{1-z}$  is at  $z = 1$ . Thus we see the radius of convergence can be greater than the distance to the nearest singularity of the coefficient function,  $p(z)$ .

## Exact Equations

### Solution 14.8

1.

$$\frac{dy}{dx} = \frac{x^2 + xy + y^2}{x^2}$$

Since the right side is a homogeneous function of order zero, this is a homogeneous differential equation. We make the change of variables  $u = y/x$  and then solve the differential equation for  $u$ .

$$\begin{aligned}xu' + u &= 1 + u + u^2 \\ \frac{du}{1 + u^2} &= \frac{dx}{x} \\ \arctan(u) &= \ln|x| + c \\ u &= \tan(\ln(|cx|)) \\ \boxed{y} &= \boxed{x \tan(\ln(|cx|))}\end{aligned}$$

2.

$$(4y - 3x) dx + (y - 2x) dy = 0$$

Since the coefficients are homogeneous functions of order one, this is a homogeneous differential equation. We



make the change of variables  $u = y/x$  and then solve the differential equation for  $u$ .

$$\begin{aligned} \left(4\frac{y}{x} - 3\right) dx + \left(\frac{y}{x} - 2\right) dy &= 0 \\ (4u - 3) dx + (u - 2)(u dx + x du) &= 0 \\ (u^2 + 2u - 3) dx + x(u - 2) du &= 0 \\ \frac{dx}{x} + \frac{u - 2}{(u + 3)(u - 1)} du &= 0 \\ \frac{dx}{x} + \left(\frac{5/4}{u + 3} - \frac{1/4}{u - 1}\right) du &= 0 \\ \ln(x) + \frac{5}{4} \ln(u + 3) - \frac{1}{4} \ln(u - 1) &= c \\ \frac{x^4(u + 3)^5}{u - 1} &= c \\ \frac{x^4(y/x + 3)^5}{y/x - 1} &= c \\ \boxed{\frac{(y + 3x)^5}{y - x} = c} \end{aligned}$$

### Solution 14.9

1.

$$(3x^2 - 2xy + 2) dx + (6y^2 - x^2 + 3) dy = 0$$

We check if this form of the equation,  $P dx + Q dy = 0$ , is exact.

$$P_y = -2x, \quad Q_x = -2x$$

Since  $P_y = Q_x$ , the equation is exact. Now we find the primitive  $u(x, y)$  which satisfies

$$du = (3x^2 - 2xy + 2) dx + (6y^2 - x^2 + 3) dy.$$

The primitive satisfies the partial differential equations

$$u_x = P, \quad u_y = Q. \quad (14.8)$$

We integrate the first equation of 14.8 to determine  $u$  up to a function of integration.

$$\begin{aligned} u_x &= 3x^2 - 2xy + 2 \\ u &= x^3 - x^2y + 2x + f(y) \end{aligned}$$

We substitute this into the second equation of 14.8 to determine the function of integration up to an additive constant.

$$\begin{aligned} -x^2 + f'(y) &= 6y^2 - x^2 + 3 \\ f'(y) &= 6y^2 + 3 \\ f(y) &= 2y^3 + 3y \end{aligned}$$

The solution of the differential equation is determined by the implicit equation  $u = c$ .

$$\boxed{x^3 - x^2y + 2x + 2y^3 + 3y = c}$$

2.

$$\begin{aligned} \frac{dy}{dx} &= -\frac{ax + by}{bx + cy} \\ (ax + by) dx + (bx + cy) dy &= 0 \end{aligned}$$

We check if this form of the equation,  $P dx + Q dy = 0$ , is exact.

$$P_y = b, \quad Q_x = b$$

Since  $P_y = Q_x$ , the equation is exact. Now we find the primitive  $u(x, y)$  which satisfies

$$du = (ax + by) dx + (bx + cy) dy$$

The primitive satisfies the partial differential equations

$$u_x = P, \quad u_y = Q. \quad (14.9)$$

We integrate the first equation of 14.9 to determine  $u$  up to a function of integration.

$$\begin{aligned} u_x &= ax + by \\ u &= \frac{1}{2}ax^2 + bxy + f(y) \end{aligned}$$

We substitute this into the second equation of 14.9 to determine the function of integration up to an additive constant.

$$\begin{aligned} bx + f'(y) &= bx + cy \\ f'(y) &= cy \\ f(y) &= \frac{1}{2}cy^2 \end{aligned}$$

The solution of the differential equation is determined by the implicit equation  $u = d$ .

$$\boxed{ax^2 + 2bxy + cy^2 = d}$$

### Solution 14.10

Note that since these equations are nonlinear, we cannot predict where the solutions will be defined from the equation alone.

1. This equation is separable. We integrate to get the general solution.

$$\begin{aligned} \frac{dy}{dx} &= (1 - 2x)y^2 \\ \frac{dy}{y^2} &= (1 - 2x) dx \\ -\frac{1}{y} &= x - x^2 + c \\ y &= \frac{1}{x^2 - x - c} \end{aligned}$$

Now we apply the initial condition.

$$y(0) = \frac{1}{-c} = -\frac{1}{6}$$

$$y = \frac{1}{x^2 - x - 6}$$

$$y = \frac{1}{(x+2)(x-3)}$$

The solution is defined on the interval  $(-2 \dots 3)$ .

2. This equation is separable. We integrate to get the general solution.

$$x \, dx + y e^{-x} \, dy = 0$$

$$x e^x \, dx + y \, dy = 0$$

$$(x-1) e^x + \frac{1}{2} y^2 = c$$

$$y = \sqrt{2(c + (1-x)e^x)}$$

We apply the initial condition to determine the constant of integration.

$$y(0) = \sqrt{2(c+1)} = 1$$

$$c = -\frac{1}{2}$$

$$y = \sqrt{2(1-x)e^x - 1}$$

The function  $2(1-x)e^x - 1$  is plotted in Figure 14.11. We see that the argument of the square root in the solution is non-negative only on an interval about the origin. Because  $2(1-x)e^x - 1 = 0$  is a mixed algebraic / transcendental equation, we cannot solve it analytically. The solution of the differential equation is defined on the interval  $(-1.67835 \dots 0.768039)$ .

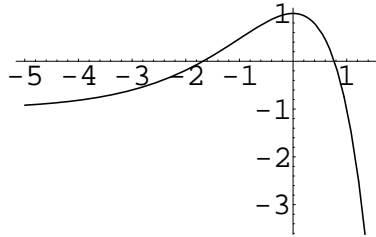

Figure 14.11: The function  $2(1-x)e^x - 1$ .

### Solution 14.11

1. We consider the differential equation,

$$(4y - x)y' - (9x^2 + y - 1) = 0.$$

$$P_y = \frac{\partial}{\partial y} (1 - y - 9x^2) = -1$$

$$Q_x = \frac{\partial}{\partial x} (4y - x) = -1$$

This equation is exact. It is simplest to solve the equation by rearranging terms to form exact derivatives.

$$4yy' - xy' - y + 1 - 9x^2 = 0$$

$$\frac{d}{dx} [2y^2 - xy] + 1 - 9x^2 = 0$$

$$2y^2 - xy + x - 3x^3 + c = 0$$

$$y = \frac{1}{4} \left( x \pm \sqrt{x^2 - 8(c + x - 3x^3)} \right)$$

2. We consider the differential equation,

$$(2x - 2y)y' + (2x + 4y) = 0.$$

$$P_y = \frac{\partial}{\partial y} (2x + 4y) = 4$$

$$Q_x = \frac{\partial}{\partial x} (2x - 2y) = 2$$

Since  $P_y \neq Q_x$ , this is not an exact equation.

### Solution 14.12

Recall that the differential equation

$$P(x, y) + Q(x, y)y' = 0$$

is exact if and only if  $P_y = Q_x$ . For Equation 14.7, this criterion is

$$2y \sin t = yf'(t)$$

$$f'(t) = 2 \sin t$$

$$f(t) = 2(a - \cos t).$$

In this case, the differential equation is

$$y^2 \sin t + 2yy'(a - \cos t) = 0.$$

We can integrate this exact equation by inspection.

$$\frac{d}{dt} (y^2(a - \cos t)) = 0$$

$$y^2(a - \cos t) = c$$

$$y = \pm \frac{c}{\sqrt{a - \cos t}}$$

## The First Order, Linear Differential Equation

### Solution 14.13

Consider the differential equation

$$y' + \frac{y}{\sin x} = 0.$$

We use Equation 14.5 to determine the solution.

$$y = c e^{\int -1/\sin x dx}$$

$$y = c e^{-\ln |\tan(x/2)|}$$

$$y = c \left| \cot \left( \frac{x}{2} \right) \right|$$

$$y = c \cot \left( \frac{x}{2} \right)$$

## Initial Conditions

## Well-Posed Problems

### Solution 14.14

First we write the differential equation in the standard form.

$$\frac{dy}{dt} + \frac{A}{t}y = \frac{1}{t} + t, \quad t > 0$$

We determine the integrating factor.

$$I(t) = e^{\int A/t dt} = e^{A \ln t} = t^A$$

We multiply the differential equation by the integrating factor and integrate.

$$\frac{dy}{dt} + \frac{A}{t}y = \frac{1}{t} + t$$

$$\frac{d}{dt} (t^A y) = t^{A-1} + t^{A+1}$$

$$t^A y = \begin{cases} \frac{t^A}{A} + \frac{t^{A+2}}{A+2} + c, & A \neq 0, -2 \\ \ln t + \frac{1}{2}t^2 + c, & A = 0 \\ -\frac{1}{2}t^{-2} + \ln t + c, & A = -2 \end{cases}$$

$$y = \begin{cases} \frac{1}{A} + \frac{t^2}{A+2} + ct^{-A}, & A \neq -2 \\ \ln t + \frac{1}{2}t^2 + c, & A = 0 \\ -\frac{1}{2} + t^2 \ln t + ct^2, & A = -2 \end{cases}$$

For positive  $A$ , the solution is bounded at the origin only for  $c = 0$ . For  $A = 0$ , there are no bounded solutions. For negative  $A$ , the solution is bounded there for any value of  $c$  and thus we have a one-parameter family of solutions.

In summary, the solutions which are bounded at the origin are:

$$y = \begin{cases} \frac{1}{A} + \frac{t^2}{A+2}, & A > 0 \\ \frac{1}{A} + \frac{t^2}{A+2} + ct^{-A}, & A < 0, A \neq -2 \\ -\frac{1}{2} + t^2 \ln t + ct^2, & A = -2 \end{cases}$$

## Equations in the Complex Plane

### Solution 14.15

1. Consider the equation  $w' + \frac{\sin z}{z}w = 0$ . The point  $z = 0$  is the only point we need to examine in the finite plane. Since  $\frac{\sin z}{z}$  has a removable singularity at  $z = 0$ , there are no singular points in the finite plane. The substitution  $z = \frac{1}{\zeta}$  yields the equation

$$u' - \frac{\sin(1/\zeta)}{\zeta}u = 0.$$



Since  $\frac{\sin(1/\zeta)}{\zeta}$  has an essential singularity at  $\zeta = 0$ , the point at infinity is an irregular singular point of the original differential equation.

2. Consider the equation  $w' + \frac{1}{z-3}w = 0$ . Since  $\frac{1}{z-3}$  has a simple pole at  $z = 3$ , the differential equation has a regular singular point there. Making the substitution  $z = 1/\zeta$ ,  $w(z) = u(\zeta)$

$$u' - \frac{1}{\zeta^2(1/\zeta - 3)}u = 0$$

$$u' - \frac{1}{\zeta(1 - 3\zeta)}u = 0.$$

Since this equation has a simple pole at  $\zeta = 0$ , the original equation has a regular singular point at infinity.

3. Consider the equation  $w' + z^{1/2}w = 0$ . There is an irregular singular point at  $z = 0$ . With the substitution  $z = 1/\zeta$ ,  $w(z) = u(\zeta)$ ,

$$u' - \frac{\zeta^{-1/2}}{\zeta^2}u = 0$$

$$u' - \zeta^{-5/2}u = 0.$$

We see that the point at infinity is also an irregular singular point of the original differential equation.

### Solution 14.16

We start with the equation

$$w' + z^{-2}w = 0.$$

Substituting  $w = z^\lambda \sum_{n=0}^{\infty} a_n z^n$ ,  $a_0 \neq 0$  yields

$$\begin{aligned} \frac{d}{dz} \left( z^\lambda \sum_{n=0}^{\infty} a_n z^n \right) + z^{-2} z^\lambda \sum_{n=0}^{\infty} a_n z^n &= 0 \\ \lambda z^{\lambda-1} \sum_{n=0}^{\infty} a_n z^n + z^\lambda \sum_{n=1}^{\infty} n a_n z^{n-1} + z^\lambda \sum_{n=0}^{\infty} a_n z^{n-2} &= 0 \end{aligned}$$

The lowest power of  $z$  in the expansion is  $z^{\lambda-2}$ . The coefficient of this term is  $a_0$ . Equating powers of  $z$  demands that  $a_0 = 0$  which contradicts our initial assumption that it was nonzero. Thus we cannot find a  $\lambda$  such that the solution can be expanded in the form,

$$w = z^\lambda \sum_{n=0}^{\infty} a_n z^n, \quad a_0 \neq 0.$$

## 14.12 Quiz

### Problem 14.1

What is the *general solution* of a first order differential equation?

**Solution**

### Problem 14.2

Write a statement about the functions  $P$  and  $Q$  to make the following statement correct.

The first order differential equation

$$P(x, y) + Q(x, y) \frac{dy}{dx} = 0$$

is exact if and only if \_\_\_\_\_. It is separable if \_\_\_\_\_.

**Solution**

### Problem 14.3

Derive the general solution of

$$\frac{dy}{dx} + p(x)y = f(x).$$

**Solution**

### Problem 14.4

Solve  $y' = y - y^2$ .

**Solution**

## 14.13 Quiz Solutions

### Solution 14.1

The general solution of a first order differential equation is a one-parameter family of functions which satisfies the equation.

### Solution 14.2

The first order differential equation

$$P(x, y) + Q(x, y) \frac{dy}{dx} = 0$$

is exact if and only if  $P_y = Q_x$ . It is separable if  $P = P(x)$  and  $Q = Q(y)$ .

### Solution 14.3

$$\frac{dy}{dx} + p(x)y = f(x)$$

We multiply by the integrating factor  $\mu(x) = \exp(P(x)) = \exp\left(\int p(x) dx\right)$ , and integrate.

$$\begin{aligned} \frac{dy}{dx} e^{P(x)} + p(x)y e^{P(x)} &= e^{P(x)} f(x) \\ \frac{d}{dx} (y e^{P(x)}) &= e^{P(x)} f(x) \\ y e^{P(x)} &= \int e^{P(x)} f(x) dx + c \\ y &= e^{-P(x)} \int e^{P(x)} f(x) dx + c e^{-P(x)} \end{aligned}$$

**Solution 14.4**

$y' = y - y^2$  is separable.

$$y' = y - y^2$$

$$\frac{y'}{y - y^2} = 1$$

$$\frac{y'}{y} - \frac{y'}{y - 1} = 1$$

$$\ln y - \ln(y - 1) = x + c$$

We do algebraic simplifications and rename the constant of integration to write the solution in a nice form.

$$\frac{y}{y - 1} = c e^x$$

$$y = (y - 1)c e^x$$

$$y = \frac{-c e^x}{1 - c e^x}$$

$$y = \frac{e^x}{e^x - c}$$

$$y = \frac{1}{1 - c e^{-x}}$$

# Chapter 15

## First Order Linear Systems of Differential Equations

We all agree that your theory is crazy, but is it crazy enough?

- Niels Bohr

### 15.1 Introduction

In this chapter we consider first order linear systems of differential equations. That is, we consider equations of the form,

$$\mathbf{x}'(t) = \mathbf{A}\mathbf{x}(t) + \mathbf{f}(t),$$
$$\mathbf{x}(t) = \begin{pmatrix} x_1(t) \\ \vdots \\ x_n(t) \end{pmatrix}, \quad \mathbf{A} = \begin{pmatrix} a_{11} & a_{12} & \dots & a_{1n} \\ a_{21} & a_{22} & \dots & a_{2n} \\ \vdots & \vdots & \ddots & \vdots \\ a_{n1} & a_{n2} & \dots & a_{nn} \end{pmatrix}.$$

Initially we will consider the homogeneous problem,  $\mathbf{x}'(t) = \mathbf{A}\mathbf{x}(t)$ . (Later we will find particular solutions with variation of parameters.) The best way to solve these equations is through the use of the matrix exponential. Unfortunately, using the matrix exponential requires knowledge of the Jordan canonical form and matrix functions. Fortunately, we can solve a certain class of problems using only the concepts of eigenvalues and eigenvectors of a matrix. We present this simple method in the next section. In the following section we will take a detour into matrix theory to cover Jordan canonical form and its applications. Then we will be able to solve the general case.

## 15.2 Using Eigenvalues and Eigenvectors to find Homogeneous Solutions

If you have forgotten what eigenvalues and eigenvectors are and how to compute them, go find a book on linear algebra and spend a few minutes re-aquainting yourself with the rudimentary material.

Recall that the single differential equation  $x'(t) = Ax$  has the general solution  $x = ce^{At}$ . Maybe the system of differential equations

$$\mathbf{x}'(t) = \mathbf{A}\mathbf{x}(t) \tag{15.1}$$

has similar solutions. Perhaps it has a solution of the form  $\mathbf{x}(t) = \mathbf{x}i e^{\lambda t}$  for some constant vector  $\mathbf{x}i$  and some value  $\lambda$ . Let's substitute this into the differential equation and see what happens.

$$\begin{aligned} \mathbf{x}'(t) &= \mathbf{A}\mathbf{x}(t) \\ \mathbf{x}i\lambda e^{\lambda t} &= \mathbf{A}\mathbf{x}i e^{\lambda t} \\ \mathbf{A}\mathbf{x}i &= \lambda\mathbf{x}i \end{aligned}$$

We see that if  $\lambda$  is an eigenvalue of  $\mathbf{A}$  with eigenvector  $\mathbf{x}i$  then  $\mathbf{x}(t) = \mathbf{x}i e^{\lambda t}$  satisfies the differential equation. Since the differential equation is linear,  $c\mathbf{x}i e^{\lambda t}$  is a solution.

Suppose that the  $n \times n$  matrix  $\mathbf{A}$  has the eigenvalues  $\{\lambda_k\}$  with a complete set of linearly independent eigenvectors  $\{\mathbf{x}i_k\}$ . Then each of  $\mathbf{x}i_k e^{\lambda_k t}$  is a homogeneous solution of Equation 15.1. We note that each of these solutions is

linearly independent. Without any kind of justification I will tell you that the general solution of the differential equation is a linear combination of these  $n$  linearly independent solutions.

**Result 15.2.1** Suppose that the  $n \times n$  matrix  $\mathbf{A}$  has the eigenvalues  $\{\lambda_k\}$  with a complete set of linearly independent eigenvectors  $\{\mathbf{x}i_k\}$ . The system of differential equations,

$$\mathbf{x}'(t) = \mathbf{A}\mathbf{x}(t),$$

has the general solution,

$$\mathbf{x}(t) = \sum_{k=1}^n c_k \mathbf{x}i_k e^{\lambda_k t}$$

**Example 15.2.1 (mathematica/ode/systems/systems.nb)** Find the solution of the following initial value problem. Describe the behavior of the solution as  $t \rightarrow \infty$ .

$$\mathbf{x}' = \mathbf{A}\mathbf{x} \equiv \begin{pmatrix} -2 & 1 \\ -5 & 4 \end{pmatrix} \mathbf{x}, \quad \mathbf{x}(0) = \mathbf{x}_0 \equiv \begin{pmatrix} 1 \\ 3 \end{pmatrix}$$

The matrix has the distinct eigenvalues  $\lambda_1 = -1$ ,  $\lambda_2 = 3$ . The corresponding eigenvectors are

$$\mathbf{x}_1 = \begin{pmatrix} 1 \\ 1 \end{pmatrix}, \quad \mathbf{x}_2 = \begin{pmatrix} 1 \\ 5 \end{pmatrix}.$$

The general solution of the system of differential equations is

$$\mathbf{x} = c_1 \begin{pmatrix} 1 \\ 1 \end{pmatrix} e^{-t} + c_2 \begin{pmatrix} 1 \\ 5 \end{pmatrix} e^{3t}.$$



We apply the initial condition to determine the constants.

$$\begin{pmatrix} 1 & 1 \\ 1 & 5 \end{pmatrix} \begin{pmatrix} c_1 \\ c_2 \end{pmatrix} = \begin{pmatrix} 1 \\ 3 \end{pmatrix}$$
$$c_1 = \frac{1}{2}, \quad c_2 = \frac{1}{2}$$

The solution subject to the initial condition is

$$\mathbf{x} = \frac{1}{2} \begin{pmatrix} 1 \\ 1 \end{pmatrix} e^{-t} + \frac{1}{2} \begin{pmatrix} 1 \\ 5 \end{pmatrix} e^{3t}$$

For large  $t$ , the solution looks like

$$\mathbf{x} \approx \frac{1}{2} \begin{pmatrix} 1 \\ 5 \end{pmatrix} e^{3t}.$$

Both coordinates tend to infinity.

Figure 15.1 shows some homogeneous solutions in the phase plane.

**Example 15.2.2 (mathematica/ode/systems/systems.nb)** Find the solution of the following initial value problem. Describe the behavior of the solution as  $t \rightarrow \infty$ .

$$\mathbf{x}' = \mathbf{A}\mathbf{x} \equiv \begin{pmatrix} 1 & 1 & 2 \\ 0 & 2 & 2 \\ -1 & 1 & 3 \end{pmatrix} \mathbf{x}, \quad \mathbf{x}(0) = \mathbf{x}_0 \equiv \begin{pmatrix} 2 \\ 0 \\ 1 \end{pmatrix}$$

The matrix has the distinct eigenvalues  $\lambda_1 = 1$ ,  $\lambda_2 = 2$ ,  $\lambda_3 = 3$ . The corresponding eigenvectors are

$$\mathbf{x}_1 = \begin{pmatrix} 0 \\ -2 \\ 1 \end{pmatrix}, \quad \mathbf{x}_2 = \begin{pmatrix} 1 \\ 1 \\ 0 \end{pmatrix}, \quad \mathbf{x}_3 = \begin{pmatrix} 2 \\ 2 \\ 1 \end{pmatrix}.$$

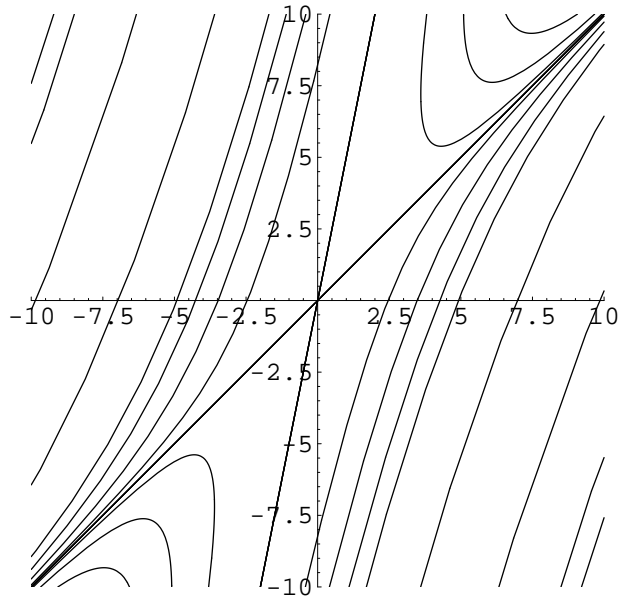

Figure 15.1: Homogeneous solutions in the phase plane.

*The general solution of the system of differential equations is*

$$\mathbf{x} = c_1 \begin{pmatrix} 0 \\ -2 \\ 1 \end{pmatrix} e^t + c_2 \begin{pmatrix} 1 \\ 1 \\ 0 \end{pmatrix} e^{2t} + c_3 \begin{pmatrix} 1 \\ 2 \\ 1 \end{pmatrix} e^{3t}.$$

We apply the initial condition to determine the constants.

$$\begin{pmatrix} 0 & 1 & 2 \\ -2 & 1 & 2 \\ 1 & 0 & 1 \end{pmatrix} \begin{pmatrix} c_1 \\ c_2 \\ c_3 \end{pmatrix} = \begin{pmatrix} 2 \\ 0 \\ 1 \end{pmatrix}$$
$$c_1 = 1, \quad c_2 = 2, \quad c_3 = 0$$

The solution subject to the initial condition is

$$\mathbf{x} = \begin{pmatrix} 0 \\ -2 \\ 1 \end{pmatrix} e^t + 2 \begin{pmatrix} 1 \\ 1 \\ 0 \end{pmatrix} e^{2t}.$$

As  $t \rightarrow \infty$ , all coordinates tend to infinity.

### Exercise 15.1 (mathematica/ode/systems/systems.nb)

Find the solution of the following initial value problem. Describe the behavior of the solution as  $t \rightarrow \infty$ .

$$\mathbf{x}' = \mathbf{A}\mathbf{x} \equiv \begin{pmatrix} 1 & -5 \\ 1 & -3 \end{pmatrix} \mathbf{x}, \quad \mathbf{x}(0) = \mathbf{x}_0 \equiv \begin{pmatrix} 1 \\ 1 \end{pmatrix}$$

Hint, Solution

### Exercise 15.2 (mathematica/ode/systems/systems.nb)

Find the solution of the following initial value problem. Describe the behavior of the solution as  $t \rightarrow \infty$ .

$$\mathbf{x}' = \mathbf{A}\mathbf{x} \equiv \begin{pmatrix} -3 & 0 & 2 \\ 1 & -1 & 0 \\ -2 & -1 & 0 \end{pmatrix} \mathbf{x}, \quad \mathbf{x}(0) = \mathbf{x}_0 \equiv \begin{pmatrix} 1 \\ 0 \\ 0 \end{pmatrix}$$

Hint, Solution

### Exercise 15.3

Use the matrix form of the method of variation of parameters to find the general solution of

$$\frac{d\mathbf{x}}{dt} = \begin{pmatrix} 4 & -2 \\ 8 & -4 \end{pmatrix} \mathbf{x} + \begin{pmatrix} t^{-3} \\ -t^{-2} \end{pmatrix}, \quad t > 0.$$

Hint, Solution

## 15.3 Matrices and Jordan Canonical Form

**Functions of Square Matrices.** Consider a function  $f(x)$  with a Taylor series.

$$f(x) = \sum_{n=0}^{\infty} \frac{f^{(n)}(0)}{n!} x^n$$

We can define the function to take square matrices as arguments. The function of the square matrix  $\mathbf{A}$  is defined in terms of the Taylor series.

$$f(\mathbf{A}) = \sum_{n=0}^{\infty} \frac{f^{(n)}(0)}{n!} \mathbf{A}^n$$

(Note that this definition is usually not the most convenient method for computing a function of a matrix. Use the Jordan canonical form for that.)

**Eigenvalues and Eigenvectors.** Consider a square matrix  $\mathbf{A}$ . A nonzero vector  $\mathbf{x}$  is an *eigenvector* of the matrix with *eigenvalue*  $\lambda$  if

$$\mathbf{A}\mathbf{x} = \lambda\mathbf{x}.$$

Note that we can write this equation as

$$(\mathbf{A} - \lambda\mathbf{I})\mathbf{x} = \mathbf{0}.$$

This equation has solutions for nonzero  $\mathbf{x}$  if and only if  $\mathbf{A} - \lambda\mathbf{I}$  is singular, ( $\det(\mathbf{A} - \lambda\mathbf{I}) = 0$ ). We define the *characteristic polynomial* of the matrix  $\chi(\lambda)$  as this determinant.

$$\chi(\lambda) = \det(\mathbf{A} - \lambda\mathbf{I})$$

The roots of the characteristic polynomial are the eigenvalues of the matrix. The eigenvectors of distinct eigenvalues are linearly independent. Thus if a matrix has distinct eigenvalues, the eigenvectors form a basis.

If  $\lambda$  is a root of  $\chi(\lambda)$  of multiplicity  $m$  then there are up to  $m$  linearly independent eigenvectors corresponding to that eigenvalue. That is, it has from 1 to  $m$  eigenvectors.

**Diagonalizing Matrices.** Consider an  $n \times n$  matrix  $\mathbf{A}$  that has a complete set of  $n$  linearly independent eigenvectors.  $\mathbf{A}$  may or may not have distinct eigenvalues. Consider the matrix  $\mathbf{S}$  with eigenvectors as columns.

$$\mathbf{S} = (\mathbf{x}_1 \quad \mathbf{x}_2 \quad \cdots \quad \mathbf{x}_n)$$

$\mathbf{A}$  is diagonalized by the similarity transformation:

$$\mathbf{\Lambda} = \mathbf{S}^{-1}\mathbf{A}\mathbf{S}.$$

$\mathbf{\Lambda}$  is a diagonal matrix with the eigenvalues of  $\mathbf{A}$  as the diagonal elements. Furthermore, the  $k^{\text{th}}$  diagonal element is  $\lambda_k$ , the eigenvalue corresponding to the the eigenvector,  $\mathbf{x}_k$ .

**Generalized Eigenvectors.** A vector  $\mathbf{x}_k$  is a *generalized eigenvector of rank  $k$*  if

$$(\mathbf{A} - \lambda\mathbf{I})^k \mathbf{x}_k = \mathbf{0} \quad \text{but} \quad (\mathbf{A} - \lambda\mathbf{I})^{k-1} \mathbf{x}_k \neq \mathbf{0}.$$

Eigenvectors are generalized eigenvectors of rank 1. An  $n \times n$  matrix has  $n$  linearly independent generalized eigenvectors. A *chain* of generalized eigenvectors generated by the rank  $m$  generalized eigenvector  $\mathbf{x}_m$  is the set:  $\{\mathbf{x}_1, \mathbf{x}_2, \dots, \mathbf{x}_m\}$ , where

$$\mathbf{x}_k = (\mathbf{A} - \lambda\mathbf{I})\mathbf{x}_{k+1}, \quad \text{for} \quad k = m - 1, \dots, 1.$$

**Computing Generalized Eigenvectors.** Let  $\lambda$  be an eigenvalue of multiplicity  $m$ . Let  $n$  be the smallest integer such that

$$\text{rank}(\text{nullspace}((A - \lambda I)^n)) = m.$$

Let  $N_k$  denote the number of eigenvalues of rank  $k$ . These have the value:

$$N_k = \text{rank}(\text{nullspace}((A - \lambda I)^k)) - \text{rank}(\text{nullspace}((A - \lambda I)^{k-1})).$$

One can compute the generalized eigenvectors of a matrix by looping through the following three steps until all the  $N_k$  are zero:

1. Select the largest  $k$  for which  $N_k$  is positive. Find a generalized eigenvector  $\mathbf{x}_k$  of rank  $k$  which is linearly independent of all the generalized eigenvectors found thus far.
2. From  $\mathbf{x}_k$  generate the chain of eigenvectors  $\{\mathbf{x}_1, \mathbf{x}_2, \dots, \mathbf{x}_k\}$ . Add this chain to the known generalized eigenvectors.
3. Decrement each positive  $N_k$  by one.

**Example 15.3.1** Consider the matrix

$$\mathbf{A} = \begin{pmatrix} 1 & 1 & 1 \\ 2 & 1 & -1 \\ -3 & 2 & 4 \end{pmatrix}.$$

The characteristic polynomial of the matrix is

$$\begin{aligned} \chi(\lambda) &= \begin{vmatrix} 1 - \lambda & 1 & 1 \\ 2 & 1 - \lambda & -1 \\ -3 & 2 & 4 - \lambda \end{vmatrix} \\ &= (1 - \lambda)^2(4 - \lambda) + 3 + 4 + 3(1 - \lambda) - 2(4 - \lambda) + 2(1 - \lambda) \\ &= -(\lambda - 2)^3. \end{aligned}$$

Thus we see that  $\lambda = 2$  is an eigenvalue of multiplicity 3.  $\mathbf{A} - 2\mathbf{I}$  is

$$\mathbf{A} - 2\mathbf{I} = \begin{pmatrix} -1 & 1 & 1 \\ 2 & -1 & -1 \\ -3 & 2 & 2 \end{pmatrix}$$

The rank of the nullspace space of  $\mathbf{A} - 2\mathbf{I}$  is less than 3.

$$(\mathbf{A} - 2\mathbf{I})^2 = \begin{pmatrix} 0 & 0 & 0 \\ -1 & 1 & 1 \\ 1 & -1 & -1 \end{pmatrix}$$

The rank of  $\text{nullspace}((\mathbf{A} - 2\mathbf{I})^2)$  is less than 3 as well, so we have to take one more step.

$$(\mathbf{A} - 2\mathbf{I})^3 = \begin{pmatrix} 0 & 0 & 0 \\ 0 & 0 & 0 \\ 0 & 0 & 0 \end{pmatrix}$$

The rank of  $\text{nullspace}((\mathbf{A} - 2\mathbf{I})^3)$  is 3. Thus there are generalized eigenvectors of ranks 1, 2 and 3. The generalized eigenvector of rank 3 satisfies:

$$\begin{aligned} (\mathbf{A} - 2\mathbf{I})^3 \mathbf{x}_3 &= \mathbf{0} \\ \begin{pmatrix} 0 & 0 & 0 \\ 0 & 0 & 0 \\ 0 & 0 & 0 \end{pmatrix} \mathbf{x}_3 &= \mathbf{0} \end{aligned}$$

We choose the solution

$$\mathbf{x}_3 = \begin{pmatrix} 1 \\ 0 \\ 0 \end{pmatrix}.$$

Now to compute the chain generated by  $\mathbf{x}_3$ .

$$\mathbf{x}_2 = (\mathbf{A} - 2\mathbf{I})\mathbf{x}_3 = \begin{pmatrix} -1 \\ 2 \\ -3 \end{pmatrix}$$
$$\mathbf{x}_1 = (\mathbf{A} - 2\mathbf{I})\mathbf{x}_2 = \begin{pmatrix} 0 \\ -1 \\ 1 \end{pmatrix}$$

Thus a set of generalized eigenvectors corresponding to the eigenvalue  $\lambda = 2$  are

$$\mathbf{x}_1 = \begin{pmatrix} 0 \\ -1 \\ 1 \end{pmatrix}, \quad \mathbf{x}_2 = \begin{pmatrix} -1 \\ 2 \\ -3 \end{pmatrix}, \quad \mathbf{x}_3 = \begin{pmatrix} 1 \\ 0 \\ 0 \end{pmatrix}.$$

**Jordan Block.** A Jordan block is a square matrix which has the constant,  $\lambda$ , on the diagonal and ones on the first super-diagonal:

$$\begin{pmatrix} \lambda & 1 & 0 & \cdots & 0 & 0 \\ 0 & \lambda & 1 & \cdots & 0 & 0 \\ 0 & 0 & \lambda & \ddots & 0 & 0 \\ \vdots & \vdots & \ddots & \ddots & \ddots & \vdots \\ 0 & 0 & 0 & \ddots & \lambda & 1 \\ 0 & 0 & 0 & \cdots & 0 & \lambda \end{pmatrix}$$



**Jordan Canonical Form.** A matrix  $\mathbf{J}$  is in Jordan canonical form if all the elements are zero except for Jordan blocks  $\mathbf{J}_k$  along the diagonal.

$$\mathbf{J} = \begin{pmatrix} \mathbf{J}_1 & \mathbf{0} & \cdots & \mathbf{0} & \mathbf{0} \\ \mathbf{0} & \mathbf{J}_2 & \ddots & \mathbf{0} & \mathbf{0} \\ \vdots & \ddots & \ddots & \ddots & \vdots \\ \mathbf{0} & \mathbf{0} & \ddots & \mathbf{J}_{n-1} & \mathbf{0} \\ \mathbf{0} & \mathbf{0} & \cdots & \mathbf{0} & \mathbf{J}_n \end{pmatrix}$$

The Jordan canonical form of a matrix is obtained with the similarity transformation:

$$\mathbf{J} = \mathbf{S}^{-1}\mathbf{A}\mathbf{S},$$

where  $\mathbf{S}$  is the matrix of the generalized eigenvectors of  $\mathbf{A}$  and the generalized eigenvectors are grouped in chains.

**Example 15.3.2** *Again consider the matrix*

$$\mathbf{A} = \begin{pmatrix} 1 & 1 & 1 \\ 2 & 1 & -1 \\ -3 & 2 & 4 \end{pmatrix}.$$

*Since  $\lambda = 2$  is an eigenvalue of multiplicity 3, the Jordan canonical form of the matrix is*

$$\mathbf{J} = \begin{pmatrix} 2 & 1 & 0 \\ 0 & 2 & 1 \\ 0 & 0 & 2 \end{pmatrix}.$$

*In Example 15.3.1 we found the generalized eigenvectors of  $\mathbf{A}$ . We define the matrix with generalized eigenvectors as columns:*

$$\mathbf{S} = \begin{pmatrix} 0 & -1 & 1 \\ -1 & 2 & 0 \\ 1 & -3 & 0 \end{pmatrix}.$$

We can verify that  $\mathbf{J} = \mathbf{S}^{-1}\mathbf{A}\mathbf{S}$ .

$$\begin{aligned}\mathbf{J} &= \mathbf{S}^{-1}\mathbf{A}\mathbf{S} \\ &= \begin{pmatrix} 0 & -3 & -2 \\ 0 & -1 & -1 \\ 1 & -1 & -1 \end{pmatrix} \begin{pmatrix} 1 & 1 & 1 \\ 2 & 1 & -1 \\ -3 & 2 & 4 \end{pmatrix} \begin{pmatrix} 0 & -1 & 1 \\ -1 & 2 & 0 \\ 1 & -3 & 0 \end{pmatrix} \\ &= \begin{pmatrix} 2 & 1 & 0 \\ 0 & 2 & 1 \\ 0 & 0 & 2 \end{pmatrix}\end{aligned}$$

**Functions of Matrices in Jordan Canonical Form.** The function of an  $n \times n$  Jordan block is the upper-triangular matrix:

$$f(\mathbf{J}_k) = \begin{pmatrix} f(\lambda) & \frac{f'(\lambda)}{1!} & \frac{f''(\lambda)}{2!} & \cdots & \frac{f^{(n-2)}(\lambda)}{(n-2)!} & \frac{f^{(n-1)}(\lambda)}{(n-1)!} \\ 0 & f(\lambda) & \frac{f'(\lambda)}{1!} & \cdots & \frac{f^{(n-3)}(\lambda)}{(n-3)!} & \frac{f^{(n-2)}(\lambda)}{(n-2)!} \\ 0 & 0 & f(\lambda) & \ddots & \frac{f^{(n-4)}(\lambda)}{(n-4)!} & \frac{f^{(n-3)}(\lambda)}{(n-3)!} \\ \vdots & \vdots & \ddots & \ddots & \ddots & \vdots \\ 0 & 0 & 0 & \ddots & f(\lambda) & \frac{f'(\lambda)}{1!} \\ 0 & 0 & 0 & \cdots & 0 & f(\lambda) \end{pmatrix}$$

The function of a matrix in Jordan canonical form is

$$f(\mathbf{J}) = \begin{pmatrix} f(\mathbf{J}_1) & \mathbf{0} & \cdots & \mathbf{0} & \mathbf{0} \\ \mathbf{0} & f(\mathbf{J}_2) & \ddots & \mathbf{0} & \mathbf{0} \\ \vdots & \ddots & \ddots & \ddots & \vdots \\ \mathbf{0} & \mathbf{0} & \ddots & f(\mathbf{J}_{n-1}) & \mathbf{0} \\ \mathbf{0} & \mathbf{0} & \cdots & \mathbf{0} & f(\mathbf{J}_n) \end{pmatrix}$$

The Jordan canonical form of a matrix satisfies:

$$f(\mathbf{J}) = \mathbf{S}^{-1}f(\mathbf{A})\mathbf{S},$$

where  $\mathbf{S}$  is the matrix of the generalized eigenvectors of  $\mathbf{A}$ . This gives us a convenient method for computing functions of matrices.

**Example 15.3.3** Consider the matrix exponential function  $e^{\mathbf{A}}$  for our old friend:

$$\mathbf{A} = \begin{pmatrix} 1 & 1 & 1 \\ 2 & 1 & -1 \\ -3 & 2 & 4 \end{pmatrix}.$$

In Example 15.3.2 we showed that the Jordan canonical form of the matrix is

$$\mathbf{J} = \begin{pmatrix} 2 & 1 & 0 \\ 0 & 2 & 1 \\ 0 & 0 & 2 \end{pmatrix}.$$

Since all the derivatives of  $e^\lambda$  are just  $e^\lambda$ , it is especially easy to compute  $e^{\mathbf{J}}$ .

$$e^{\mathbf{J}} = \begin{pmatrix} e^2 & e^2 & e^2/2 \\ 0 & e^2 & e^2 \\ 0 & 0 & e^2 \end{pmatrix}$$

We find  $e^{\mathbf{A}}$  with a similarity transformation of  $e^{\mathbf{J}}$ . We use the matrix of generalized eigenvectors found in Example 15.3.2.

$$e^{\mathbf{A}} = \mathbf{S} e^{\mathbf{J}} \mathbf{S}^{-1}$$

$$e^{\mathbf{A}} = \begin{pmatrix} 0 & -1 & 1 \\ -1 & 2 & 0 \\ 1 & -3 & 0 \end{pmatrix} \begin{pmatrix} e^2 & e^2 & e^2/2 \\ 0 & e^2 & e^2 \\ 0 & 0 & e^2 \end{pmatrix} \begin{pmatrix} 0 & -3 & -2 \\ 0 & -1 & -1 \\ 1 & -1 & -1 \end{pmatrix}$$

$$e^{\mathbf{A}} = \begin{pmatrix} 0 & 2 & 2 \\ 3 & 1 & -1 \\ -5 & 3 & 5 \end{pmatrix} \frac{e^2}{2}$$

## 15.4 Using the Matrix Exponential

The homogeneous differential equation

$$\mathbf{x}'(t) = \mathbf{A}\mathbf{x}(t)$$

has the solution

$$\mathbf{x}(t) = e^{\mathbf{A}t} \mathbf{c}$$

where  $\mathbf{c}$  is a vector of constants. The solution subject to the initial condition,  $\mathbf{x}(t_0) = \mathbf{x}_0$  is

$$\mathbf{x}(t) = e^{\mathbf{A}(t-t_0)} \mathbf{x}_0.$$

The homogeneous differential equation

$$\mathbf{x}'(t) = \frac{1}{t} \mathbf{A}\mathbf{x}(t)$$

has the solution

$$\mathbf{x}(t) = t^{\mathbf{A}} \mathbf{c} \equiv e^{\mathbf{A} \text{Log} t} \mathbf{c},$$

where  $\mathbf{c}$  is a vector of constants. The solution subject to the initial condition,  $\mathbf{x}(t_0) = \mathbf{x}_0$  is

$$\mathbf{x}(t) = \left( \frac{t}{t_0} \right)^{\mathbf{A}} \mathbf{x}_0 \equiv e^{\mathbf{A} \text{Log}(t/t_0)} \mathbf{x}_0.$$

The inhomogeneous problem

$$\mathbf{x}'(t) = \mathbf{A}\mathbf{x}(t) + \mathbf{f}(t), \quad \mathbf{x}(t_0) = \mathbf{x}_0$$

has the solution

$$\mathbf{x}(t) = e^{\mathbf{A}(t-t_0)} \mathbf{x}_0 + e^{\mathbf{A}t} \int_{t_0}^t e^{-\mathbf{A}\tau} \mathbf{f}(\tau) d\tau.$$

**Example 15.4.1** Consider the system

$$\frac{d\mathbf{x}}{dt} = \begin{pmatrix} 1 & 1 & 1 \\ 2 & 1 & -1 \\ -3 & 2 & 4 \end{pmatrix} \mathbf{x}.$$

The general solution of the system of differential equations is

$$\mathbf{x}(t) = e^{\mathbf{A}t} \mathbf{c}.$$

In Example 15.3.3 we found  $e^{\mathbf{A}}$ .  $\mathbf{A}t$  is just a constant times  $\mathbf{A}$ . The eigenvalues of  $\mathbf{A}t$  are  $\{\lambda_k t\}$  where  $\{\lambda_k\}$  are the eigenvalues of  $\mathbf{A}$ . The generalized eigenvectors of  $\mathbf{A}t$  are the same as those of  $\mathbf{A}$ .

Consider  $e^{\mathbf{J}t}$ . The derivatives of  $f(\lambda) = e^{\lambda t}$  are  $f'(\lambda) = t e^{\lambda t}$  and  $f''(\lambda) = t^2 e^{\lambda t}$ . Thus we have

$$e^{\mathbf{J}t} = \begin{pmatrix} e^{2t} & t e^{2t} & t^2 e^{2t}/2 \\ 0 & e^{2t} & t e^{2t} \\ 0 & 0 & e^{2t} \end{pmatrix}$$

$$e^{\mathbf{J}t} = \begin{pmatrix} 1 & t & t^2/2 \\ 0 & 1 & t \\ 0 & 0 & 1 \end{pmatrix} e^{2t}$$

We find  $e^{\mathbf{A}t}$  with a similarity transformation.

$$e^{\mathbf{A}t} = \mathbf{S} e^{\mathbf{J}t} \mathbf{S}^{-1}$$

$$e^{\mathbf{A}t} = \begin{pmatrix} 0 & -1 & 1 \\ -1 & 2 & 0 \\ 1 & -3 & 0 \end{pmatrix} \begin{pmatrix} 1 & t & t^2/2 \\ 0 & 1 & t \\ 0 & 0 & 1 \end{pmatrix} e^{2t} \begin{pmatrix} 0 & -3 & -2 \\ 0 & -1 & -1 \\ 1 & -1 & -1 \end{pmatrix}$$

$$e^{\mathbf{A}t} = \begin{pmatrix} 1-t & t & t \\ 2t-t^2/2 & 1-t+t^2/2 & -t+t^2/2 \\ -3t+t^2/2 & 2t-t^2/2 & 1+2t-t^2/2 \end{pmatrix} e^{2t}$$

The solution of the system of differential equations is

$$\mathbf{x}(t) = \left( c_1 \begin{pmatrix} 1-t \\ 2t-t^2/2 \\ -3t+t^2/2 \end{pmatrix} + c_2 \begin{pmatrix} t \\ 1-t+t^2/2 \\ 2t-t^2/2 \end{pmatrix} + c_3 \begin{pmatrix} t \\ -t+t^2/2 \\ 1+2t-t^2/2 \end{pmatrix} \right) e^{2t}$$

**Example 15.4.2** Consider the Euler equation system

$$\frac{d\mathbf{x}}{dt} = \frac{1}{t}\mathbf{A}\mathbf{x} \equiv \frac{1}{t} \begin{pmatrix} 1 & 0 \\ 1 & 1 \end{pmatrix} \mathbf{x}.$$

The solution is  $\mathbf{x}(t) = t^{\mathbf{A}}\mathbf{c}$ . Note that  $\mathbf{A}$  is almost in Jordan canonical form. It has a one on the sub-diagonal instead of the super-diagonal. It is clear that a function of  $\mathbf{A}$  is defined

$$f(\mathbf{A}) = \begin{pmatrix} f(1) & 0 \\ f'(1) & f(1) \end{pmatrix}.$$

The function  $f(\lambda) = t^\lambda$  has the derivative  $f'(\lambda) = t^\lambda \log t$ . Thus the solution of the system is

$$\mathbf{x}(t) = \begin{pmatrix} t & 0 \\ t \log t & t \end{pmatrix} \begin{pmatrix} c_1 \\ c_2 \end{pmatrix} = c_1 \begin{pmatrix} t \\ t \log t \end{pmatrix} + c_2 \begin{pmatrix} 0 \\ t \end{pmatrix}$$

**Example 15.4.3** Consider an inhomogeneous system of differential equations.

$$\frac{d\mathbf{x}}{dt} = \mathbf{A}\mathbf{x} + \mathbf{f}(t) \equiv \begin{pmatrix} 4 & -2 \\ 8 & -4 \end{pmatrix} \mathbf{x} + \begin{pmatrix} t^{-3} \\ -t^{-2} \end{pmatrix}, \quad t > 0.$$

The general solution is

$$\mathbf{x}(t) = e^{\mathbf{A}t} \mathbf{c} + e^{\mathbf{A}t} \int e^{-\mathbf{A}t} \mathbf{f}(t) dt.$$

First we find homogeneous solutions. The characteristic equation for the matrix is

$$\chi(\lambda) = \begin{vmatrix} 4 - \lambda & -2 \\ 8 & -4 - \lambda \end{vmatrix} = \lambda^2 = 0$$

$\lambda = 0$  is an eigenvalue of multiplicity 2. Thus the Jordan canonical form of the matrix is

$$\mathbf{J} = \begin{pmatrix} 0 & 1 \\ 0 & 0 \end{pmatrix}.$$

Since  $\text{rank}(\text{nullspace}(\mathbf{A} - 0\mathbf{I})) = 1$  there is only one eigenvector. A generalized eigenvector of rank 2 satisfies

$$\begin{aligned}(\mathbf{A} - 0\mathbf{I})^2 \mathbf{x}_2 &= \mathbf{0} \\ \begin{pmatrix} 0 & 0 \\ 0 & 0 \end{pmatrix} \mathbf{x}_2 &= \mathbf{0}\end{aligned}$$

We choose

$$\mathbf{x}_2 = \begin{pmatrix} 1 \\ 0 \end{pmatrix}$$

Now we generate the chain from  $\mathbf{x}_2$ .

$$\mathbf{x}_1 = (\mathbf{A} - 0\mathbf{I})\mathbf{x}_2 = \begin{pmatrix} 4 \\ 8 \end{pmatrix}$$

We define the matrix of generalized eigenvectors  $\mathbf{S}$ .

$$\mathbf{S} = \begin{pmatrix} 4 & 1 \\ 8 & 0 \end{pmatrix}$$

The derivative of  $f(\lambda) = e^{\lambda t}$  is  $f'(\lambda) = t e^{\lambda t}$ . Thus

$$e^{\mathbf{J}t} = \begin{pmatrix} 1 & t \\ 0 & 1 \end{pmatrix}$$

The homogeneous solution of the differential equation system is  $\mathbf{x}_h = e^{\mathbf{A}t} \mathbf{c}$  where

$$\begin{aligned}e^{\mathbf{A}t} &= \mathbf{S} e^{\mathbf{J}t} \mathbf{S}^{-1} \\ e^{\mathbf{A}t} &= \begin{pmatrix} 4 & 1 \\ 8 & 0 \end{pmatrix} \cdot \begin{pmatrix} 1 & t \\ 0 & 1 \end{pmatrix} \begin{pmatrix} 0 & 1/8 \\ 1 & -1/2 \end{pmatrix} \\ e^{\mathbf{A}t} &= \begin{pmatrix} 1 + 4t & -2t \\ 8t & 1 - 4t \end{pmatrix}\end{aligned}$$

The general solution of the inhomogeneous system of equations is

$$\mathbf{x}(t) = e^{\mathbf{A}t} \mathbf{c} + e^{\mathbf{A}t} \int e^{-\mathbf{A}t} f(t) dt$$

$$\mathbf{x}(t) = \begin{pmatrix} 1 + 4t & -2t \\ 8t & 1 - 4t \end{pmatrix} \mathbf{c} + \begin{pmatrix} 1 + 4t & -2t \\ 8t & 1 - 4t \end{pmatrix} \int \begin{pmatrix} 1 - 4t & 2t \\ -8t & 1 + 4t \end{pmatrix} \begin{pmatrix} t^{-3} \\ -t^{-2} \end{pmatrix} dt$$

$$\mathbf{x}(t) = c_1 \begin{pmatrix} 1 + 4t \\ 8t \end{pmatrix} + c_2 \begin{pmatrix} -2t \\ 1 - 4t \end{pmatrix} + \begin{pmatrix} 2 - 2 \text{Log } t + \frac{6}{t} - \frac{1}{2t^2} \\ 4 - 4 \text{Log } t + \frac{13}{t} \end{pmatrix}$$

We can tidy up the answer a little bit. First we take linear combinations of the homogeneous solutions to obtain a simpler form.

$$\mathbf{x}(t) = c_1 \begin{pmatrix} 1 \\ 2 \end{pmatrix} + c_2 \begin{pmatrix} 2t \\ 4t - 1 \end{pmatrix} + \begin{pmatrix} 2 - 2 \text{Log } t + \frac{6}{t} - \frac{1}{2t^2} \\ 4 - 4 \text{Log } t + \frac{13}{t} \end{pmatrix}$$

Then we subtract 2 times the first homogeneous solution from the particular solution.

$$\boxed{\mathbf{x}(t) = c_1 \begin{pmatrix} 1 \\ 2 \end{pmatrix} + c_2 \begin{pmatrix} 2t \\ 4t - 1 \end{pmatrix} + \begin{pmatrix} -2 \text{Log } t + \frac{6}{t} - \frac{1}{2t^2} \\ -4 \text{Log } t + \frac{13}{t} \end{pmatrix}}$$



## 15.5 Exercises

### Exercise 15.4 (mathematica/ode/systems/systems.nb)

Find the solution of the following initial value problem.

$$\mathbf{x}' = \mathbf{A}x \equiv \begin{pmatrix} -2 & 1 \\ -5 & 4 \end{pmatrix} \mathbf{x}, \quad \mathbf{x}(0) = \mathbf{x}_0 \equiv \begin{pmatrix} 1 \\ 3 \end{pmatrix}$$

Hint, Solution

### Exercise 15.5 (mathematica/ode/systems/systems.nb)

Find the solution of the following initial value problem.

$$\mathbf{x}' = \mathbf{A}x \equiv \begin{pmatrix} 1 & 1 & 2 \\ 0 & 2 & 2 \\ -1 & 1 & 3 \end{pmatrix} \mathbf{x}, \quad \mathbf{x}(0) = \mathbf{x}_0 \equiv \begin{pmatrix} 2 \\ 0 \\ 1 \end{pmatrix}$$

Hint, Solution

### Exercise 15.6 (mathematica/ode/systems/systems.nb)

Find the solution of the following initial value problem. Describe the behavior of the solution as  $t \rightarrow \infty$ .

$$\mathbf{x}' = \mathbf{A}x \equiv \begin{pmatrix} 1 & -5 \\ 1 & -3 \end{pmatrix} \mathbf{x}, \quad \mathbf{x}(0) = \mathbf{x}_0 \equiv \begin{pmatrix} 1 \\ 1 \end{pmatrix}$$

Hint, Solution

### Exercise 15.7 (mathematica/ode/systems/systems.nb)

Find the solution of the following initial value problem. Describe the behavior of the solution as  $t \rightarrow \infty$ .

$$\mathbf{x}' = \mathbf{A}x \equiv \begin{pmatrix} -3 & 0 & 2 \\ 1 & -1 & 0 \\ -2 & -1 & 0 \end{pmatrix} \mathbf{x}, \quad \mathbf{x}(0) = \mathbf{x}_0 \equiv \begin{pmatrix} 1 \\ 0 \\ 0 \end{pmatrix}$$

Hint, Solution

**Exercise 15.8 (mathematica/ode/systems/systems.nb)**

Find the solution of the following initial value problem. Describe the behavior of the solution as  $t \rightarrow \infty$ .

$$\mathbf{x}' = \mathbf{A}\mathbf{x} \equiv \begin{pmatrix} 1 & -4 \\ 4 & -7 \end{pmatrix} \mathbf{x}, \quad \mathbf{x}(0) = \mathbf{x}_0 \equiv \begin{pmatrix} 3 \\ 2 \end{pmatrix}$$

Hint, Solution

**Exercise 15.9 (mathematica/ode/systems/systems.nb)**

Find the solution of the following initial value problem. Describe the behavior of the solution as  $t \rightarrow \infty$ .

$$\mathbf{x}' = \mathbf{A}\mathbf{x} \equiv \begin{pmatrix} -1 & 0 & 0 \\ -4 & 1 & 0 \\ 3 & 6 & 2 \end{pmatrix} \mathbf{x}, \quad \mathbf{x}(0) = \mathbf{x}_0 \equiv \begin{pmatrix} -1 \\ 2 \\ -30 \end{pmatrix}$$

Hint, Solution

**Exercise 15.10**

1. Consider the system

$$\mathbf{x}' = \mathbf{A}\mathbf{x} = \begin{pmatrix} 1 & 1 & 1 \\ 2 & 1 & -1 \\ -3 & 2 & 4 \end{pmatrix} \mathbf{x}. \tag{15.2}$$

- (a) Show that  $\lambda = 2$  is an eigenvalue of multiplicity 3 of the coefficient matrix  $\mathbf{A}$ , and that there is only one corresponding eigenvector, namely

$$\mathbf{x}^{i(1)} = \begin{pmatrix} 0 \\ 1 \\ -1 \end{pmatrix}.$$

- (b) Using the information in part (i), write down one solution  $\mathbf{x}^{(1)}(t)$  of the system (15.2). There is no other solution of a purely exponential form  $\mathbf{x} = \mathbf{x}^i e^{\lambda t}$ .
- (c) To find a second solution use the form  $\mathbf{x} = \mathbf{x}^i t e^{2t} + \boldsymbol{\eta} e^{2t}$ , and find appropriate vectors  $\mathbf{x}^i$  and  $\boldsymbol{\eta}$ . This gives a solution of the system (15.2) which is independent of the one obtained in part (ii).

- (d) To find a third linearly independent solution use the form  $\mathbf{x} = \mathbf{x}i(t^2/2)e^{2t} + \boldsymbol{\eta}t e^{2t} + \boldsymbol{\zeta} e^{2t}$ . Show that  $\mathbf{x}i$ ,  $\boldsymbol{\eta}$  and  $\boldsymbol{\zeta}$  satisfy the equations

$$(\mathbf{A} - 2\mathbf{I})\mathbf{x}i = \mathbf{0}, \quad (\mathbf{A} - 2\mathbf{I})\boldsymbol{\eta} = \mathbf{x}i, \quad (\mathbf{A} - 2\mathbf{I})\boldsymbol{\zeta} = \boldsymbol{\eta}.$$

The first two equations can be taken to coincide with those obtained in part (iii). Solve the third equation, and write down a third independent solution of the system (15.2).

2. Consider the system

$$\mathbf{x}' = \mathbf{A}\mathbf{x} = \begin{pmatrix} 5 & -3 & -2 \\ 8 & -5 & -4 \\ -4 & 3 & 3 \end{pmatrix} \mathbf{x}. \quad (15.3)$$

- (a) Show that  $\lambda = 1$  is an eigenvalue of multiplicity 3 of the coefficient matrix  $\mathbf{A}$ , and that there are only two linearly independent eigenvectors, which we may take as

$$\mathbf{x}i^{(1)} = \begin{pmatrix} 1 \\ 0 \\ 2 \end{pmatrix}, \quad \mathbf{x}i^{(2)} = \begin{pmatrix} 0 \\ 2 \\ -3 \end{pmatrix}$$

Find two independent solutions of equation (15.3).

- (b) To find a third solution use the form  $\mathbf{x} = \mathbf{x}it e^t + \boldsymbol{\eta}e^t$ ; then show that  $\mathbf{x}i$  and  $\boldsymbol{\eta}$  must satisfy

$$(\mathbf{A} - \mathbf{I})\mathbf{x}i = \mathbf{0}, \quad (\mathbf{A} - \mathbf{I})\boldsymbol{\eta} = \mathbf{x}i.$$

Show that the most general solution of the first of these equations is  $\mathbf{x}i = c_1\mathbf{x}i_1 + c_2\mathbf{x}i_2$ , where  $c_1$  and  $c_2$  are arbitrary constants. Show that, in order to solve the second of these equations it is necessary to take  $c_1 = c_2$ . Obtain such a vector  $\boldsymbol{\eta}$ , and use it to obtain a third independent solution of the system (15.3).

Hint, Solution

**Exercise 15.11 (mathematica/ode/systems/systems.nb)**

Consider the system of ODE's

$$\frac{dx}{dt} = \mathbf{A}x, \quad x(0) = x_0$$

where  $\mathbf{A}$  is the constant  $3 \times 3$  matrix

$$\mathbf{A} = \begin{pmatrix} 1 & 1 & 1 \\ 2 & 1 & -1 \\ -8 & -5 & -3 \end{pmatrix}$$

1. Find the eigenvalues and associated eigenvectors of  $\mathbf{A}$ . [HINT: notice that  $\lambda = -1$  is a root of the characteristic polynomial of  $\mathbf{A}$ .]
2. Use the results from part (a) to construct  $e^{\mathbf{A}t}$  and therefore the solution to the initial value problem above.
3. Use the results of part (a) to find the general solution to

$$\frac{dx}{dt} = \frac{1}{t}\mathbf{A}x.$$

Hint, Solution

**Exercise 15.12 (mathematica/ode/systems/systems.nb)**

1. Find the general solution to

$$\frac{dx}{dt} = \mathbf{A}x$$

where

$$\mathbf{A} = \begin{pmatrix} 2 & 0 & 1 \\ 0 & 2 & 0 \\ 0 & 1 & 3 \end{pmatrix}$$

2. Solve

$$\frac{dx}{dt} = \mathbf{A}x + \mathbf{g}(t), \quad x(0) = \mathbf{0}$$

using  $\mathbf{A}$  from part (a).

Hint, Solution

### Exercise 15.13

Let  $\mathbf{A}$  be an  $n \times n$  matrix of constants. The system

$$\frac{d\mathbf{x}}{dt} = \frac{1}{t}\mathbf{A}\mathbf{x}, \quad (15.4)$$

is analogous to the Euler equation.

1. Verify that when  $\mathbf{A}$  is a  $2 \times 2$  constant matrix, elimination of (15.4) yields a second order Euler differential equation.
2. Now assume that  $\mathbf{A}$  is an  $n \times n$  matrix of constants. Show that this system, in analogy with the Euler equation has solutions of the form  $\mathbf{x} = \mathbf{a}t^\lambda$  where  $\mathbf{a}$  is a constant vector provided  $\mathbf{a}$  and  $\lambda$  satisfy certain conditions.
3. Based on your experience with the treatment of multiple roots in the solution of constant coefficient systems, what form will the general solution of (15.4) take if  $\lambda$  is a multiple eigenvalue in the eigenvalue problem derived in part (b)?
4. Verify your prediction by deriving the general solution for the system

$$\frac{d\mathbf{x}}{dt} = \frac{1}{t} \begin{pmatrix} 1 & 0 \\ 1 & 1 \end{pmatrix} \mathbf{x}.$$

Hint, Solution

## 15.6 Hints

**Hint 15.1**

**Hint 15.2**

**Hint 15.3**

**Hint 15.4**

**Hint 15.5**

**Hint 15.6**

**Hint 15.7**

**Hint 15.8**

**Hint 15.9**

**Hint 15.10**

**Hint 15.11**

**Hint 15.12**

**Hint 15.13**

## 15.7 Solutions

### Solution 15.1

We consider an initial value problem.

$$\mathbf{x}' = \mathbf{A}\mathbf{x} \equiv \begin{pmatrix} 1 & -5 \\ 1 & -3 \end{pmatrix} \mathbf{x}, \quad \mathbf{x}(0) = \mathbf{x}_0 \equiv \begin{pmatrix} 1 \\ 1 \end{pmatrix}$$

The matrix has the distinct eigenvalues  $\lambda_1 = -1 - i$ ,  $\lambda_2 = -1 + i$ . The corresponding eigenvectors are

$$\mathbf{x}_1 = \begin{pmatrix} 2 - i \\ 1 \end{pmatrix}, \quad \mathbf{x}_2 = \begin{pmatrix} 2 + i \\ 1 \end{pmatrix}.$$

The general solution of the system of differential equations is

$$\mathbf{x} = c_1 \begin{pmatrix} 2 - i \\ 1 \end{pmatrix} e^{(-1-i)t} + c_2 \begin{pmatrix} 2 + i \\ 1 \end{pmatrix} e^{(-1+i)t}.$$

We can take the real and imaginary parts of either of these solution to obtain real-valued solutions.

$$\begin{aligned} \begin{pmatrix} 2 + i \\ 1 \end{pmatrix} e^{(-1+i)t} &= \begin{pmatrix} 2 \cos(t) - \sin(t) \\ \cos(t) \end{pmatrix} e^{-t} + i \begin{pmatrix} \cos(t) + 2 \sin(t) \\ \sin(t) \end{pmatrix} e^{-t} \\ \mathbf{x} &= c_1 \begin{pmatrix} 2 \cos(t) - \sin(t) \\ \cos(t) \end{pmatrix} e^{-t} + c_2 \begin{pmatrix} \cos(t) + 2 \sin(t) \\ \sin(t) \end{pmatrix} e^{-t} \end{aligned}$$

We apply the initial condition to determine the constants.

$$\begin{pmatrix} 2 & 1 \\ 1 & 0 \end{pmatrix} \begin{pmatrix} c_1 \\ c_2 \end{pmatrix} = \begin{pmatrix} 1 \\ 1 \end{pmatrix}$$
$$c_1 = 1, \quad c_2 = -1$$

The solution subject to the initial condition is

$$\mathbf{x} = \begin{pmatrix} \cos(t) - 3 \sin(t) \\ \cos(t) - \sin(t) \end{pmatrix} e^{-t}.$$

Plotted in the phase plane, the solution spirals in to the origin as  $t$  increases. Both coordinates tend to zero as  $t \rightarrow \infty$ .



### Solution 15.2

We consider an initial value problem.

$$\mathbf{x}' = \mathbf{A}\mathbf{x} \equiv \begin{pmatrix} -3 & 0 & 2 \\ 1 & -1 & 0 \\ -2 & -1 & 0 \end{pmatrix} \mathbf{x}, \quad \mathbf{x}(0) = \mathbf{x}_0 \equiv \begin{pmatrix} 1 \\ 0 \\ 0 \end{pmatrix}$$

The matrix has the distinct eigenvalues  $\lambda_1 = -2$ ,  $\lambda_2 = -1 - i\sqrt{2}$ ,  $\lambda_3 = -1 + i\sqrt{2}$ . The corresponding eigenvectors are

$$\mathbf{x}_1 = \begin{pmatrix} 2 \\ -2 \\ 1 \end{pmatrix}, \quad \mathbf{x}_2 = \begin{pmatrix} 2 + i\sqrt{2} \\ -1 + i\sqrt{2} \\ 3 \end{pmatrix}, \quad \mathbf{x}_3 = \begin{pmatrix} 2 - i\sqrt{2} \\ -1 - i\sqrt{2} \\ 3 \end{pmatrix}.$$

The general solution of the system of differential equations is

$$\mathbf{x} = c_1 \begin{pmatrix} 2 \\ -2 \\ 1 \end{pmatrix} e^{-2t} + c_2 \begin{pmatrix} 2 + i\sqrt{2} \\ -1 + i\sqrt{2} \\ 3 \end{pmatrix} e^{(-1-i\sqrt{2})t} + c_3 \begin{pmatrix} 2 - i\sqrt{2} \\ -1 - i\sqrt{2} \\ 3 \end{pmatrix} e^{(-1+i\sqrt{2})t}.$$

We can take the real and imaginary parts of the second or third solution to obtain two real-valued solutions.

$$\begin{aligned} \begin{pmatrix} 2 + i\sqrt{2} \\ -1 + i\sqrt{2} \\ 3 \end{pmatrix} e^{(-1-i\sqrt{2})t} &= \begin{pmatrix} 2 \cos(\sqrt{2}t) + \sqrt{2} \sin(\sqrt{2}t) \\ -\cos(\sqrt{2}t) + \sqrt{2} \sin(\sqrt{2}t) \\ 3 \cos(\sqrt{2}t) \end{pmatrix} e^{-t} + i \begin{pmatrix} \sqrt{2} \cos(\sqrt{2}t) - 2 \sin(\sqrt{2}t) \\ \sqrt{2} \cos(\sqrt{2}t) + \sin(\sqrt{2}t) \\ -3 \sin(\sqrt{2}t) \end{pmatrix} e^{-t} \\ \mathbf{x} &= c_1 \begin{pmatrix} 2 \\ -2 \\ 1 \end{pmatrix} e^{-2t} + c_2 \begin{pmatrix} 2 \cos(\sqrt{2}t) + \sqrt{2} \sin(\sqrt{2}t) \\ -\cos(\sqrt{2}t) + \sqrt{2} \sin(\sqrt{2}t) \\ 3 \cos(\sqrt{2}t) \end{pmatrix} e^{-t} + c_3 \begin{pmatrix} \sqrt{2} \cos(\sqrt{2}t) - 2 \sin(\sqrt{2}t) \\ \sqrt{2} \cos(\sqrt{2}t) + \sin(\sqrt{2}t) \\ -3 \sin(\sqrt{2}t) \end{pmatrix} e^{-t} \end{aligned}$$

We apply the initial condition to determine the constants.

$$\begin{pmatrix} 2 & 2 & \sqrt{2} \\ -2 & -1 & \sqrt{2} \\ 1 & 3 & 0 \end{pmatrix} \begin{pmatrix} c_1 \\ c_2 \\ c_3 \end{pmatrix} = \begin{pmatrix} 1 \\ 0 \\ 0 \end{pmatrix}$$
$$c_1 = \frac{1}{3}, \quad c_2 = -\frac{1}{9}, \quad c_3 = \frac{5}{9\sqrt{2}}$$

The solution subject to the initial condition is

$$\mathbf{x} = \frac{1}{3} \begin{pmatrix} 2 \\ -2 \\ 1 \end{pmatrix} e^{-2t} + \frac{1}{6} \begin{pmatrix} 2 \cos(\sqrt{2}t) - 4\sqrt{2} \sin(\sqrt{2}t) \\ 4 \cos(\sqrt{2}t) + \sqrt{2} \sin(\sqrt{2}t) \\ -2 \cos(\sqrt{2}t) - 5\sqrt{2} \sin(\sqrt{2}t) \end{pmatrix} e^{-t}.$$

As  $t \rightarrow \infty$ , all coordinates tend to infinity. Plotted in the phase plane, the solution would spiral in to the origin.

### Solution 15.3

**Homogeneous Solution, Method 1.** We designate the inhomogeneous system of differential equations

$$\mathbf{x}' = \mathbf{A}\mathbf{x} + \mathbf{g}(t).$$

First we find homogeneous solutions. The characteristic equation for the matrix is

$$\chi(\lambda) = \begin{vmatrix} 4 - \lambda & -2 \\ 8 & -4 - \lambda \end{vmatrix} = \lambda^2 = 0$$

$\lambda = 0$  is an eigenvalue of multiplicity 2. The eigenvectors satisfy

$$\begin{pmatrix} 4 & -2 \\ 8 & -4 \end{pmatrix} \begin{pmatrix} \xi_1 \\ \xi_2 \end{pmatrix} = \begin{pmatrix} 0 \\ 0 \end{pmatrix}.$$

Thus we see that there is only one linearly independent eigenvector. We choose

$$\mathbf{x}_i = \begin{pmatrix} 1 \\ 2 \end{pmatrix}.$$

One homogeneous solution is then

$$\mathbf{x}_1 = \begin{pmatrix} 1 \\ 2 \end{pmatrix} e^{0t} = \begin{pmatrix} 1 \\ 2 \end{pmatrix}.$$

We look for a second homogeneous solution of the form

$$\mathbf{x}_2 = \mathbf{x}i t + \boldsymbol{\eta}.$$

We substitute this into the homogeneous equation.

$$\begin{aligned} \mathbf{x}'_2 &= \mathbf{A}\mathbf{x}_2 \\ \mathbf{x}i &= \mathbf{A}(\mathbf{x}i t + \boldsymbol{\eta}) \end{aligned}$$

We see that  $\mathbf{x}i$  and  $\boldsymbol{\eta}$  satisfy

$$\mathbf{A}\mathbf{x}i = 0, \quad \mathbf{A}\boldsymbol{\eta} = \mathbf{x}i.$$

We choose  $\mathbf{x}i$  to be the eigenvector that we found previously. The equation for  $\boldsymbol{\eta}$  is then

$$\begin{pmatrix} 4 & -2 \\ 8 & -4 \end{pmatrix} \begin{pmatrix} \eta_1 \\ \eta_2 \end{pmatrix} = \begin{pmatrix} 1 \\ 2 \end{pmatrix}.$$

$\boldsymbol{\eta}$  is determined up to an additive multiple of  $\mathbf{x}i$ . We choose

$$\boldsymbol{\eta} = \begin{pmatrix} 0 \\ -1/2 \end{pmatrix}.$$

Thus a second homogeneous solution is

$$\mathbf{x}_2 = \begin{pmatrix} 1 \\ 2 \end{pmatrix} t + \begin{pmatrix} 0 \\ -1/2 \end{pmatrix}.$$

The general homogeneous solution of the system is

$$\mathbf{x}_h = c_1 \begin{pmatrix} 1 \\ 2 \end{pmatrix} + c_2 \begin{pmatrix} t \\ 2t - 1/2 \end{pmatrix}$$

We can write this in matrix notation using the fundamental matrix  $\Psi(t)$ .

$$\mathbf{x}_h = \Psi(t)\mathbf{c} = \begin{pmatrix} 1 & t \\ 2 & 2t - 1/2 \end{pmatrix} \begin{pmatrix} c_1 \\ c_2 \end{pmatrix}$$

**Homogeneous Solution, Method 2.** The similarity transform  $\mathbf{c}^{-1}\mathbf{A}\mathbf{c}$  with

$$\mathbf{c} = \begin{pmatrix} 1 & 0 \\ 2 & -1/2 \end{pmatrix}$$

will convert the matrix

$$\mathbf{A} = \begin{pmatrix} 4 & -2 \\ 8 & -4 \end{pmatrix}$$

to Jordan canonical form. We make the change of variables,

$$\mathbf{y} = \begin{pmatrix} 1 & 0 \\ 2 & -1/2 \end{pmatrix} \mathbf{x}.$$

The homogeneous system becomes

$$\begin{aligned} \frac{d\mathbf{y}}{dt} &= \begin{pmatrix} 1 & 0 \\ 4 & -2 \end{pmatrix} \begin{pmatrix} 4 & -2 \\ 8 & -4 \end{pmatrix} \begin{pmatrix} 1 & 0 \\ 2 & -1/2 \end{pmatrix} \mathbf{y} \\ \begin{pmatrix} y_1' \\ y_2' \end{pmatrix} &= \begin{pmatrix} 0 & 1 \\ 0 & 0 \end{pmatrix} \begin{pmatrix} y_1 \\ y_2 \end{pmatrix} \end{aligned}$$

The equation for  $y_2$  is

$$\begin{aligned} y_2' &= 0. \\ y_2 &= c_2 \end{aligned}$$

The equation for  $y_1$  becomes

$$\begin{aligned} y_1' &= c_2. \\ y_1 &= c_1 + c_2 t \end{aligned}$$

The solution for  $\mathbf{y}$  is then

$$\mathbf{y} = c_1 \begin{pmatrix} 1 \\ 0 \end{pmatrix} + c_2 \begin{pmatrix} t \\ 1 \end{pmatrix}.$$

We multiply this by  $\mathbf{c}$  to obtain the homogeneous solution for  $\mathbf{x}$ .

$$\mathbf{x}_h = c_1 \begin{pmatrix} 1 \\ 2 \end{pmatrix} + c_2 \begin{pmatrix} t \\ 2t - 1/2 \end{pmatrix}$$

**Inhomogeneous Solution.** By the method of variation of parameters, a particular solution is

$$\begin{aligned} \mathbf{x}_p &= \mathbf{\Psi}(t) \int \mathbf{\Psi}^{-1}(t) \mathbf{g}(t) dt. \\ \mathbf{x}_p &= \begin{pmatrix} 1 & t \\ 2 & 2t - 1/2 \end{pmatrix} \int \begin{pmatrix} 1 - 4t & 2t \\ 4 & -2 \end{pmatrix} \begin{pmatrix} t^{-3} \\ -t^{-2} \end{pmatrix} dt \\ \mathbf{x}_p &= \begin{pmatrix} 1 & t \\ 2 & 2t - 1/2 \end{pmatrix} \int \begin{pmatrix} -2t^{-1} - 4t^{-2} + t^{-3} \\ 2t^{-2} + 4t^{-3} \end{pmatrix} dt \\ \mathbf{x}_p &= \begin{pmatrix} 1 & t \\ 2 & 2t - 1/2 \end{pmatrix} \begin{pmatrix} -2 \log t + 4t^{-1} - \frac{1}{2}t^{-2} \\ -2t^{-1} - 2t^{-2} \end{pmatrix} \\ \mathbf{x}_p &= \begin{pmatrix} -2 - 2 \log t + 2t^{-1} - \frac{1}{2}t^{-2} \\ -4 - 4 \log t + 5t^{-1} \end{pmatrix} \end{aligned}$$

By adding 2 times our first homogeneous solution, we obtain

$$\mathbf{x}_p = \begin{pmatrix} -2 \log t + 2t^{-1} - \frac{1}{2}t^{-2} \\ -4 \log t + 5t^{-1} \end{pmatrix}$$

The general solution of the system of differential equations is

$$\mathbf{x} = c_1 \begin{pmatrix} 1 \\ 2 \end{pmatrix} + c_2 \begin{pmatrix} t \\ 2t - 1/2 \end{pmatrix} + \begin{pmatrix} -2 \log t + 2t^{-1} - \frac{1}{2}t^{-2} \\ -4 \log t + 5t^{-1} \end{pmatrix}$$

**Solution 15.4**

We consider an initial value problem.

$$\mathbf{x}' = \mathbf{A}\mathbf{x} \equiv \begin{pmatrix} -2 & 1 \\ -5 & 4 \end{pmatrix} \mathbf{x}, \quad \mathbf{x}(0) = \mathbf{x}_0 \equiv \begin{pmatrix} 1 \\ 3 \end{pmatrix}$$

The Jordan canonical form of the matrix is

$$\mathbf{J} = \begin{pmatrix} -1 & 0 \\ 0 & 3 \end{pmatrix}.$$

The solution of the initial value problem is  $\mathbf{x} = e^{\mathbf{A}t} \mathbf{x}_0$ .

$$\begin{aligned} \mathbf{x} &= e^{\mathbf{A}t} \mathbf{x}_0 \\ &= \mathbf{S} e^{\mathbf{J}t} \mathbf{S}^{-1} \mathbf{x}_0 \\ &= \begin{pmatrix} 1 & 1 \\ 1 & 5 \end{pmatrix} \begin{pmatrix} e^{-t} & 0 \\ 0 & e^{3t} \end{pmatrix} \frac{1}{4} \begin{pmatrix} 5 & -1 \\ -1 & 1 \end{pmatrix} \begin{pmatrix} 1 \\ 3 \end{pmatrix} \\ &= \frac{1}{2} \begin{pmatrix} e^{-t} + e^{3t} \\ e^{-t} + 5e^{3t} \end{pmatrix} \end{aligned}$$

$$\mathbf{x} = \frac{1}{2} \begin{pmatrix} 1 \\ 1 \end{pmatrix} e^{-t} + \frac{1}{2} \begin{pmatrix} 1 \\ 5 \end{pmatrix} e^{3t}$$

**Solution 15.5**

We consider an initial value problem.

$$\mathbf{x}' = \mathbf{A}\mathbf{x} \equiv \begin{pmatrix} 1 & 1 & 2 \\ 0 & 2 & 2 \\ -1 & 1 & 3 \end{pmatrix} \mathbf{x}, \quad \mathbf{x}(0) = \mathbf{x}_0 \equiv \begin{pmatrix} 2 \\ 0 \\ 1 \end{pmatrix}$$

The Jordan canonical form of the matrix is

$$\mathbf{J} = \begin{pmatrix} 1 & 0 & 0 \\ 0 & 2 & 0 \\ 0 & 0 & 3 \end{pmatrix}.$$

The solution of the initial value problem is  $\mathbf{x} = e^{\mathbf{A}t} \mathbf{x}_0$ .

$$\begin{aligned}\mathbf{x} &= e^{\mathbf{A}t} \mathbf{x}_0 \\ &= \mathbf{S} e^{\mathbf{J}t} \mathbf{S}^{-1} \mathbf{x}_0 \\ &= \begin{pmatrix} 0 & 1 & 2 \\ -2 & 1 & 2 \\ 1 & 0 & 1 \end{pmatrix} \begin{pmatrix} e^t & 0 & 0 \\ 0 & e^{2t} & 0 \\ 0 & 0 & e^{3t} \end{pmatrix} \frac{1}{2} \begin{pmatrix} 1 & -1 & 0 \\ 4 & -2 & -4 \\ -1 & 1 & 2 \end{pmatrix} \begin{pmatrix} 2 \\ 0 \\ 1 \end{pmatrix} \\ &= \begin{pmatrix} 2e^{2t} \\ -2e^t + 2e^{2t} \\ e^t \end{pmatrix}\end{aligned}$$

$$\mathbf{x} = \begin{pmatrix} 0 \\ -2 \\ 1 \end{pmatrix} e^t + \begin{pmatrix} 2 \\ 2 \\ 0 \end{pmatrix} e^{2t}.$$

### Solution 15.6

We consider an initial value problem.

$$\mathbf{x}' = \mathbf{A}\mathbf{x} \equiv \begin{pmatrix} 1 & -5 \\ 1 & -3 \end{pmatrix} \mathbf{x}, \quad \mathbf{x}(0) = \mathbf{x}_0 \equiv \begin{pmatrix} 1 \\ 1 \end{pmatrix}$$

The Jordan canonical form of the matrix is

$$\mathbf{J} = \begin{pmatrix} -1 - i & 0 \\ 0 & -1 + i \end{pmatrix}.$$

The solution of the initial value problem is  $\mathbf{x} = e^{\mathbf{A}t} \mathbf{x}_0$ .

$$\begin{aligned} \mathbf{x} &= e^{\mathbf{A}t} \mathbf{x}_0 \\ &= \mathbf{S} e^{\mathbf{J}t} \mathbf{S}^{-1} \mathbf{x}_0 \\ &= \begin{pmatrix} 2 - i & 2 + i \\ 1 & 1 \end{pmatrix} \begin{pmatrix} e^{(-1-i)t} & 0 \\ 0 & e^{(-1+i)t} \end{pmatrix} \frac{1}{2} \begin{pmatrix} i & 1 - i2 \\ -i & 1 + i2 \end{pmatrix} \begin{pmatrix} 1 \\ 1 \end{pmatrix} \\ &= \begin{pmatrix} (\cos(t) - 3\sin(t)) e^{-t} \\ (\cos(t) - \sin(t)) e^{-t} \end{pmatrix} \end{aligned}$$

$$\mathbf{x} = \begin{pmatrix} 1 \\ 1 \end{pmatrix} e^{-t} \cos(t) - \begin{pmatrix} 3 \\ 1 \end{pmatrix} e^{-t} \sin(t)$$

### Solution 15.7

We consider an initial value problem.

$$\mathbf{x}' = \mathbf{A}\mathbf{x} \equiv \begin{pmatrix} -3 & 0 & 2 \\ 1 & -1 & 0 \\ -2 & -1 & 0 \end{pmatrix} \mathbf{x}, \quad \mathbf{x}(0) = \mathbf{x}_0 \equiv \begin{pmatrix} 1 \\ 0 \\ 0 \end{pmatrix}$$

The Jordan canonical form of the matrix is

$$\mathbf{J} = \begin{pmatrix} -2 & 0 & 0 \\ 0 & -1 - i\sqrt{2} & 0 \\ 0 & 0 & -1 + i\sqrt{2} \end{pmatrix}.$$



The solution of the initial value problem is  $\mathbf{x} = e^{\mathbf{A}t} \mathbf{x}_0$ .

$$\begin{aligned}
 \mathbf{x} &= e^{\mathbf{A}t} \mathbf{x}_0 \\
 &= \mathbf{S} e^{\mathbf{J}t} \mathbf{S}^{-1} \mathbf{x}_0 \\
 &= \frac{1}{3} \begin{pmatrix} 6 & 2 + i\sqrt{2} & 2 - i\sqrt{2} \\ -6 & -1 + i\sqrt{2} & -1 - i\sqrt{2} \\ 3 & 3 & 3 \end{pmatrix} \begin{pmatrix} e^{-2t} & 0 & 0 \\ 0 & e^{(-1-i\sqrt{2})t} & 0 \\ 0 & 0 & e^{(-1+i\sqrt{2})t} \end{pmatrix} \\
 &\quad \frac{1}{6} \begin{pmatrix} 2 & -2 & -2 \\ -1 - i5\sqrt{2}/2 & 1 - i2\sqrt{2} & 4 + i\sqrt{2} \\ -1 + i5\sqrt{2}/2 & 1 + i2\sqrt{2} & 4 - i\sqrt{2} \end{pmatrix} \begin{pmatrix} 1 \\ 0 \\ 0 \end{pmatrix}
 \end{aligned}$$

$$\mathbf{x} = \frac{1}{3} \begin{pmatrix} 2 \\ -2 \\ 1 \end{pmatrix} e^{-2t} + \frac{1}{6} \begin{pmatrix} 2 \cos(\sqrt{2}t) - 4\sqrt{2} \sin(\sqrt{2}t) \\ 4 \cos(\sqrt{2}t) + \sqrt{2} \sin(\sqrt{2}t) \\ -2 \cos(\sqrt{2}t) - 5\sqrt{2} \sin(\sqrt{2}t) \end{pmatrix} e^{-t}.$$

### Solution 15.8

We consider an initial value problem.

$$\mathbf{x}' = \mathbf{A}\mathbf{x} \equiv \begin{pmatrix} 1 & -4 \\ 4 & -7 \end{pmatrix} \mathbf{x}, \quad \mathbf{x}(0) = \mathbf{x}_0 \equiv \begin{pmatrix} 3 \\ 2 \end{pmatrix}$$

**Method 1. Find Homogeneous Solutions.** The matrix has the double eigenvalue  $\lambda_1 = \lambda_2 = -3$ . There is only

one corresponding eigenvector. We compute a chain of generalized eigenvectors.

$$(\mathbf{A} + 3\mathbf{I})^2 \mathbf{x}_2 = \mathbf{0}$$

$$\mathbf{0} \mathbf{x}_2 = \mathbf{0}$$

$$\mathbf{x}_2 = \begin{pmatrix} 1 \\ 0 \end{pmatrix}$$

$$(\mathbf{A} + 3\mathbf{I}) \mathbf{x}_2 = \mathbf{x}_1$$

$$\mathbf{x}_1 = \begin{pmatrix} 4 \\ 4 \end{pmatrix}$$

The general solution of the system of differential equations is

$$\mathbf{x} = c_1 \begin{pmatrix} 1 \\ 1 \end{pmatrix} e^{-3t} + c_2 \left( \begin{pmatrix} 4 \\ 4 \end{pmatrix} t + \begin{pmatrix} 1 \\ 0 \end{pmatrix} \right) e^{-3t}.$$

We apply the initial condition to determine the constants.

$$\begin{pmatrix} 1 & 1 \\ 1 & 0 \end{pmatrix} \begin{pmatrix} c_1 \\ c_2 \end{pmatrix} = \begin{pmatrix} 3 \\ 2 \end{pmatrix}$$

$$c_1 = 2, \quad c_2 = 1$$

The solution subject to the initial condition is

$$\mathbf{x} = \begin{pmatrix} 3 + 4t \\ 2 + 4t \end{pmatrix} e^{-3t}.$$

Both coordinates tend to zero as  $t \rightarrow \infty$ .

**Method 2. Use the Exponential Matrix.** The Jordan canonical form of the matrix is

$$\mathbf{J} = \begin{pmatrix} -3 & 1 \\ 0 & -3 \end{pmatrix}.$$

The solution of the initial value problem is  $\mathbf{x} = e^{\mathbf{A}t} \mathbf{x}_0$ .

$$\begin{aligned}\mathbf{x} &= e^{\mathbf{A}t} \mathbf{x}_0 \\ &= \mathbf{S} e^{\mathbf{J}t} \mathbf{S}^{-1} \mathbf{x}_0 \\ &= \begin{pmatrix} 1 & 1/4 \\ 1 & 0 \end{pmatrix} \begin{pmatrix} e^{-3t} & t e^{-3t} \\ 0 & e^{-3t} \end{pmatrix} \begin{pmatrix} 0 & 1 \\ 4 & -4 \end{pmatrix} \begin{pmatrix} 3 \\ 2 \end{pmatrix}\end{aligned}$$

$$\boxed{\mathbf{x} = \begin{pmatrix} 3 + 4t \\ 2 + 4t \end{pmatrix} e^{-3t} .}$$

### Solution 15.9

We consider an initial value problem.

$$\mathbf{x}' = \mathbf{A}\mathbf{x} \equiv \begin{pmatrix} -1 & 0 & 0 \\ -4 & 1 & 0 \\ 3 & 6 & 2 \end{pmatrix} \mathbf{x}, \quad \mathbf{x}(0) = \mathbf{x}_0 \equiv \begin{pmatrix} -1 \\ 2 \\ -30 \end{pmatrix}$$

**Method 1. Find Homogeneous Solutions.** The matrix has the distinct eigenvalues  $\lambda_1 = -1$ ,  $\lambda_2 = 1$ ,  $\lambda_3 = 2$ . The corresponding eigenvectors are

$$\mathbf{x}_1 = \begin{pmatrix} -1 \\ -2 \\ 5 \end{pmatrix}, \quad \mathbf{x}_2 = \begin{pmatrix} 0 \\ -1 \\ 6 \end{pmatrix}, \quad \mathbf{x}_3 = \begin{pmatrix} 0 \\ 0 \\ 1 \end{pmatrix} .$$

The general solution of the system of differential equations is

$$\mathbf{x} = c_1 \begin{pmatrix} -1 \\ -2 \\ 5 \end{pmatrix} e^{-t} + c_2 \begin{pmatrix} 0 \\ -1 \\ 6 \end{pmatrix} e^t + c_3 \begin{pmatrix} 0 \\ 0 \\ 1 \end{pmatrix} e^{2t} .$$

We apply the initial condition to determine the constants.

$$\begin{pmatrix} -1 & 0 & 0 \\ -2 & -1 & 0 \\ 5 & 6 & 1 \end{pmatrix} \begin{pmatrix} c_1 \\ c_2 \\ c_3 \end{pmatrix} = \begin{pmatrix} -1 \\ 2 \\ -30 \end{pmatrix}$$

$$c_1 = 1, \quad c_2 = -4, \quad c_3 = -11$$

The solution subject to the initial condition is

$$\mathbf{x} = \begin{pmatrix} -1 \\ -2 \\ 5 \end{pmatrix} e^{-t} - 4 \begin{pmatrix} 0 \\ -1 \\ 6 \end{pmatrix} e^t - 11 \begin{pmatrix} 0 \\ 0 \\ 1 \end{pmatrix} e^{2t}.$$

As  $t \rightarrow \infty$ , the first coordinate vanishes, the second coordinate tends to  $\infty$  and the third coordinate tends to  $-\infty$

**Method 2. Use the Exponential Matrix.** The Jordan canonical form of the matrix is

$$\mathbf{J} = \begin{pmatrix} -1 & 0 & 0 \\ 0 & 1 & 0 \\ 0 & 0 & 2 \end{pmatrix}.$$

The solution of the initial value problem is  $\mathbf{x} = e^{\mathbf{A}t} \mathbf{x}_0$ .

$$\begin{aligned} \mathbf{x} &= e^{\mathbf{A}t} \mathbf{x}_0 \\ &= \mathbf{S} e^{\mathbf{J}t} \mathbf{S}^{-1} \mathbf{x}_0 \\ &= \begin{pmatrix} -1 & 0 & 0 \\ -2 & -1 & 0 \\ 5 & 6 & 1 \end{pmatrix} \begin{pmatrix} e^{-t} & 0 & 0 \\ 0 & e^t & 0 \\ 0 & 0 & e^{2t} \end{pmatrix} \frac{1}{2} \begin{pmatrix} -1 & 0 & 0 \\ 2 & -1 & 0 \\ -7 & 6 & 1 \end{pmatrix} \begin{pmatrix} -1 \\ 2 \\ -30 \end{pmatrix} \end{aligned}$$

$$\mathbf{x} = \begin{pmatrix} -1 \\ -2 \\ 5 \end{pmatrix} e^{-t} - 4 \begin{pmatrix} 0 \\ -1 \\ 6 \end{pmatrix} e^t - 11 \begin{pmatrix} 0 \\ 0 \\ 1 \end{pmatrix} e^{2t}.$$

**Solution 15.10**

1. (a) We compute the eigenvalues of the matrix.

$$\chi(\lambda) = \begin{vmatrix} 1 - \lambda & 1 & 1 \\ 2 & 1 - \lambda & -1 \\ -3 & 2 & 4 - \lambda \end{vmatrix} = -\lambda^3 + 6\lambda^2 - 12\lambda + 8 = -(\lambda - 2)^3$$

$\lambda = 2$  is an eigenvalue of multiplicity 3. The rank of the null space of  $\mathbf{A} - 2\mathbf{I}$  is 1. (The first two rows are linearly independent, but the third is a linear combination of the first two.)

$$\mathbf{A} - 2\mathbf{I} = \begin{pmatrix} -1 & 1 & 1 \\ 2 & -1 & -1 \\ -3 & 2 & 2 \end{pmatrix}$$

Thus there is only one eigenvector.

$$\begin{pmatrix} -1 & 1 & 1 \\ 2 & -1 & -1 \\ -3 & 2 & 2 \end{pmatrix} \begin{pmatrix} \xi_1 \\ \xi_2 \\ \xi_3 \end{pmatrix} = \mathbf{0}$$

$$\mathbf{x}^{(1)} = \begin{pmatrix} 0 \\ 1 \\ -1 \end{pmatrix}$$

- (b) One solution of the system of differential equations is

$$\mathbf{x}^{(1)} = \begin{pmatrix} 0 \\ 1 \\ -1 \end{pmatrix} e^{2t}.$$

- (c) We substitute the form  $\mathbf{x} = \mathbf{x}i t e^{2t} + \boldsymbol{\eta} e^{2t}$  into the differential equation.

$$\mathbf{x}' = \mathbf{A}\mathbf{x}$$

$$\mathbf{x}i e^{2t} + 2\mathbf{x}i t e^{2t} + 2\boldsymbol{\eta} e^{2t} = \mathbf{A}\mathbf{x}i t e^{2t} + \mathbf{A}\boldsymbol{\eta} e^{2t}$$

$$(\mathbf{A} - 2\mathbf{I})\mathbf{x}i = \mathbf{0}, \quad (\mathbf{A} - 2\mathbf{I})\boldsymbol{\eta} = \mathbf{x}i$$

We already have a solution of the first equation, we need the generalized eigenvector  $\boldsymbol{\eta}$ . Note that  $\boldsymbol{\eta}$  is only determined up to a constant times  $\mathbf{x}_i$ . Thus we look for the solution whose second component vanishes to simplify the algebra.

$$\begin{aligned}
 (\mathbf{A} - 2\mathbf{I})\boldsymbol{\eta} &= \mathbf{x}_i \\
 \begin{pmatrix} -1 & 1 & 1 \\ 2 & -1 & -1 \\ -3 & 2 & 2 \end{pmatrix} \begin{pmatrix} \eta_1 \\ 0 \\ \eta_3 \end{pmatrix} &= \begin{pmatrix} 0 \\ 1 \\ -1 \end{pmatrix} \\
 -\eta_1 + \eta_3 &= 0, \quad 2\eta_1 - \eta_3 = 1, \quad -3\eta_1 + 2\eta_3 = -1 \\
 \boldsymbol{\eta} &= \begin{pmatrix} 1 \\ 0 \\ 1 \end{pmatrix}
 \end{aligned}$$

A second linearly independent solution is

$$\mathbf{x}^{(2)} = \begin{pmatrix} 0 \\ 1 \\ -1 \end{pmatrix} t e^{2t} + \begin{pmatrix} 1 \\ 0 \\ 1 \end{pmatrix} e^{2t}.$$

(d) To find a third solution we substitute the form  $\mathbf{x} = \mathbf{x}_i(t^2/2) e^{2t} + \boldsymbol{\eta} t e^{2t} + \boldsymbol{\zeta} e^{2t}$  into the differential equation.

$$\begin{aligned}
 \mathbf{x}' &= \mathbf{A}\mathbf{x} \\
 2\mathbf{x}_i(t^2/2) e^{2t} + (\mathbf{x}_i + 2\boldsymbol{\eta})t e^{2t} + (\boldsymbol{\eta} + 2\boldsymbol{\zeta}) e^{2t} &= \mathbf{A}\mathbf{x}_i(t^2/2) e^{2t} + \mathbf{A}\boldsymbol{\eta} t e^{2t} + \mathbf{A}\boldsymbol{\zeta} e^{2t} \\
 (\mathbf{A} - 2\mathbf{I})\mathbf{x}_i &= \mathbf{0}, \quad (\mathbf{A} - 2\mathbf{I})\boldsymbol{\eta} = \mathbf{x}_i, \quad (\mathbf{A} - 2\mathbf{I})\boldsymbol{\zeta} = \boldsymbol{\eta}
 \end{aligned}$$

We have already solved the first two equations, we need the generalized eigenvector  $\boldsymbol{\zeta}$ . Note that  $\boldsymbol{\zeta}$  is only determined up to a constant times  $\mathbf{x}_i$ . Thus we look for the solution whose second component vanishes to

simplify the algebra.

$$\begin{aligned}(\mathbf{A} - 2\mathbf{I})\boldsymbol{\zeta} &= \boldsymbol{\eta} \\ \begin{pmatrix} -1 & 1 & 1 \\ 2 & -1 & -1 \\ -3 & 2 & 2 \end{pmatrix} \begin{pmatrix} \zeta_1 \\ 0 \\ \zeta_3 \end{pmatrix} &= \begin{pmatrix} 1 \\ 0 \\ 1 \end{pmatrix} \\ -\zeta_1 + \zeta_3 &= 1, \quad 2\zeta_1 - \zeta_3 = 0, \quad -3\zeta_1 + 2\zeta_3 = 1 \\ \boldsymbol{\zeta} &= \begin{pmatrix} 1 \\ 0 \\ 2 \end{pmatrix}\end{aligned}$$

A third linearly independent solution is

$$\mathbf{x}^{(3)} = \begin{pmatrix} 0 \\ 1 \\ -1 \end{pmatrix} (t^2/2) e^{2t} + \begin{pmatrix} 1 \\ 0 \\ 1 \end{pmatrix} t e^{2t} + \begin{pmatrix} 1 \\ 0 \\ 2 \end{pmatrix} e^{2t}$$

2. (a) We compute the eigenvalues of the matrix.

$$\chi(\lambda) = \begin{vmatrix} 5 - \lambda & -3 & -2 \\ 8 & -5 - \lambda & -4 \\ -4 & 3 & 3 - \lambda \end{vmatrix} = -\lambda^3 + 3\lambda^2 - 3\lambda + 1 = -(\lambda - 1)^3$$

$\lambda = 1$  is an eigenvalue of multiplicity 3. The rank of the null space of  $\mathbf{A} - \mathbf{I}$  is 2. (The second and third rows are multiples of the first.)

$$\mathbf{A} - \mathbf{I} = \begin{pmatrix} 4 & -3 & -2 \\ 8 & -6 & -4 \\ -4 & 3 & 2 \end{pmatrix}$$

Thus there are two eigenvectors.

$$\begin{pmatrix} 4 & -3 & -2 \\ 8 & -6 & -4 \\ -4 & 3 & 2 \end{pmatrix} \begin{pmatrix} \xi_1 \\ \xi_2 \\ \xi_3 \end{pmatrix} = \mathbf{0}$$

$$\mathbf{x}^{i(1)} = \begin{pmatrix} 1 \\ 0 \\ 2 \end{pmatrix}, \quad \mathbf{x}^{i(2)} = \begin{pmatrix} 0 \\ 2 \\ -3 \end{pmatrix}$$

Two linearly independent solutions of the differential equation are

$$\mathbf{x}^{(1)} = \begin{pmatrix} 1 \\ 0 \\ 2 \end{pmatrix} e^t, \quad \mathbf{x}^{(2)} = \begin{pmatrix} 0 \\ 2 \\ -3 \end{pmatrix} e^t.$$

(b) We substitute the form  $\mathbf{x} = \mathbf{x}i t e^t + \boldsymbol{\eta} e^t$  into the differential equation.

$$\begin{aligned} \mathbf{x}' &= \mathbf{A}\mathbf{x} \\ \mathbf{x}i e^t + \mathbf{x}i t e^t + \boldsymbol{\eta} e^t &= \mathbf{A}\mathbf{x}i t e^t + \mathbf{A}\boldsymbol{\eta} e^t \\ (\mathbf{A} - \mathbf{I})\mathbf{x}i &= \mathbf{0}, \quad (\mathbf{A} - \mathbf{I})\boldsymbol{\eta} = \mathbf{x}i \end{aligned}$$

The general solution of the first equation is a linear combination of the two solutions we found in the previous part.

$$\mathbf{x}i = c_1 \mathbf{x}i_1 + c_2 \mathbf{x}i_2$$

Now we find the generalized eigenvector,  $\boldsymbol{\eta}$ . Note that  $\boldsymbol{\eta}$  is only determined up to a linear combination of  $\mathbf{x}i_1$  and  $\mathbf{x}i_2$ . Thus we can take the first two components of  $\boldsymbol{\eta}$  to be zero.

$$\begin{pmatrix} 4 & -3 & -2 \\ 8 & -6 & -4 \\ -4 & 3 & 2 \end{pmatrix} \begin{pmatrix} 0 \\ 0 \\ \eta_3 \end{pmatrix} = c_1 \begin{pmatrix} 1 \\ 0 \\ 2 \end{pmatrix} + c_2 \begin{pmatrix} 0 \\ 2 \\ -3 \end{pmatrix}$$

$$-2\eta_3 = c_1, \quad -4\eta_3 = 2c_2, \quad 2\eta_3 = 2c_1 - 3c_2$$

$$c_1 = c_2, \quad \eta_3 = -\frac{c_1}{2}$$



We see that we must take  $c_1 = c_2$  in order to obtain a solution. We choose  $c_1 = c_2 = 2$ . A third linearly independent solution of the differential equation is

$$\mathbf{x}^{(3)} = \begin{pmatrix} 2 \\ 4 \\ -2 \end{pmatrix} t e^t + \begin{pmatrix} 0 \\ 0 \\ -1 \end{pmatrix} e^t.$$

### Solution 15.11

1. The characteristic polynomial of the matrix is

$$\begin{aligned} \chi(\lambda) &= \begin{vmatrix} 1 - \lambda & 1 & 1 \\ 2 & 1 - \lambda & -1 \\ -8 & -5 & -3 - \lambda \end{vmatrix} \\ &= (1 - \lambda)^2(-3 - \lambda) + 8 - 10 - 5(1 - \lambda) - 2(-3 - \lambda) - 8(1 - \lambda) \\ &= -\lambda^3 - \lambda^2 + 4\lambda + 4 \\ &= -(\lambda + 2)(\lambda + 1)(\lambda - 2) \end{aligned}$$

Thus we see that the eigenvalues are  $\lambda = -2, -1, 2$ . The eigenvectors  $\mathbf{x}_i$  satisfy

$$(\mathbf{A} - \lambda\mathbf{I})\mathbf{x}_i = \mathbf{0}.$$

For  $\lambda = -2$ , we have

$$\begin{aligned} &(\mathbf{A} + 2\mathbf{I})\mathbf{x}_i = \mathbf{0}. \\ &\begin{pmatrix} 3 & 1 & 1 \\ 2 & 3 & -1 \\ -8 & -5 & -1 \end{pmatrix} \begin{pmatrix} \xi_1 \\ \xi_2 \\ \xi_3 \end{pmatrix} = \begin{pmatrix} 0 \\ 0 \\ 0 \end{pmatrix} \end{aligned}$$

If we take  $\xi_3 = 1$  then the first two rows give us the system,

$$\begin{pmatrix} 3 & 1 \\ 2 & 3 \end{pmatrix} \begin{pmatrix} \xi_1 \\ \xi_2 \end{pmatrix} = \begin{pmatrix} -1 \\ 1 \end{pmatrix}$$

which has the solution  $\xi_1 = -4/7$ ,  $\xi_2 = 5/7$ . For the first eigenvector we choose:

$$\mathbf{x}_i = \begin{pmatrix} -4 \\ 5 \\ 7 \end{pmatrix}$$

For  $\lambda = -1$ , we have

$$(\mathbf{A} + \mathbf{I})\mathbf{x}_i = \mathbf{0}.$$
$$\begin{pmatrix} 2 & 1 & 1 \\ 2 & 2 & -1 \\ -8 & -5 & -2 \end{pmatrix} \begin{pmatrix} \xi_1 \\ \xi_2 \\ \xi_3 \end{pmatrix} = \begin{pmatrix} 0 \\ 0 \\ 0 \end{pmatrix}$$

If we take  $\xi_3 = 1$  then the first two rows give us the system,

$$\begin{pmatrix} 2 & 1 \\ 2 & 2 \end{pmatrix} \begin{pmatrix} \xi_1 \\ \xi_2 \end{pmatrix} = \begin{pmatrix} -1 \\ 1 \end{pmatrix}$$

which has the solution  $\xi_1 = -3/2$ ,  $\xi_2 = 2$ . For the second eigenvector we choose:

$$\mathbf{x}_i = \begin{pmatrix} -3 \\ 4 \\ 2 \end{pmatrix}$$

For  $\lambda = 2$ , we have

$$(\mathbf{A} + \mathbf{I})\mathbf{x}_i = \mathbf{0}.$$
$$\begin{pmatrix} -1 & 1 & 1 \\ 2 & -1 & -1 \\ -8 & -5 & -5 \end{pmatrix} \begin{pmatrix} \xi_1 \\ \xi_2 \\ \xi_3 \end{pmatrix} = \begin{pmatrix} 0 \\ 0 \\ 0 \end{pmatrix}$$

If we take  $\xi_3 = 1$  then the first two rows give us the system,

$$\begin{pmatrix} -1 & 1 \\ 2 & -1 \end{pmatrix} \begin{pmatrix} \xi_1 \\ \xi_2 \end{pmatrix} = \begin{pmatrix} -1 \\ 1 \end{pmatrix}$$

which has the solution  $\xi_1 = 0$ ,  $\xi_2 = -1$ . For the third eigenvector we choose:

$$\mathbf{x}_i = \begin{pmatrix} 0 \\ -1 \\ 1 \end{pmatrix}$$

In summary, the eigenvalues and eigenvectors are

$$\lambda = \{-2, -1, 2\}, \quad \mathbf{x}_i = \left\{ \begin{pmatrix} -4 \\ 5 \\ 7 \end{pmatrix}, \begin{pmatrix} -3 \\ 4 \\ 2 \end{pmatrix}, \begin{pmatrix} 0 \\ -1 \\ 1 \end{pmatrix} \right\}$$

2. The matrix is diagonalized with the similarity transformation

$$\mathbf{J} = \mathbf{S}^{-1}\mathbf{A}\mathbf{S},$$

where  $\mathbf{S}$  is the matrix with eigenvectors as columns:

$$\mathbf{S} = \begin{pmatrix} -4 & -3 & 0 \\ 5 & 4 & -1 \\ 7 & 2 & 1 \end{pmatrix}$$

The matrix exponential,  $e^{\mathbf{A}t}$  is given by

$$e^{\mathbf{A}} = \begin{pmatrix} -4 & -3 & 0 \\ 5 & 4 & -1 \\ 7 & 2 & 1 \end{pmatrix} \begin{pmatrix} e^{-2t} & 0 & 0 \\ 0 & e^{-t} & 0 \\ 0 & 0 & e^{2t} \end{pmatrix} \frac{1}{12} \begin{pmatrix} 6 & 3 & 3 \\ -12 & -4 & -4 \\ -18 & -13 & -1 \end{pmatrix}.$$

$$e^{\mathbf{A}t} = \begin{pmatrix} -2e^{-2t} + 3e^{-t} & -e^{-2t} + e^{-t} & -e^{-2t} + e^{-t} \\ \frac{5e^{-2t} - 8e^{-t} + 3e^t}{2} & \frac{15e^{-2t} - 16e^{-t} + 13e^t}{12} & \frac{15e^{-2t} - 16e^{-t} + e^t}{12} \\ \frac{7e^{-2t} - 4e^{-t} - 3e^t}{2} & \frac{21e^{-2t} - 8e^{-t} - 13e^t}{12} & \frac{21e^{-2t} - 8e^{-t} - e^t}{12} \end{pmatrix}$$

The solution of the initial value problem is  $e^{\mathbf{A}t} \mathbf{x}_0$ .

3. The general solution of the Euler equation is

$$c_1 \begin{pmatrix} -4 \\ 5 \\ 7 \end{pmatrix} t^{-2} + c_2 \begin{pmatrix} -3 \\ 4 \\ 2 \end{pmatrix} t^{-1} + c_3 \begin{pmatrix} 0 \\ -1 \\ 1 \end{pmatrix} t^2.$$

We could also write the solution as

$$\mathbf{x} = t^{\mathbf{A}} \mathbf{c} \equiv e^{\mathbf{A} \log t} \mathbf{c},$$

### Solution 15.12

1. The characteristic polynomial of the matrix is

$$\begin{aligned} \chi(\lambda) &= \begin{vmatrix} 2 - \lambda & 0 & 1 \\ 0 & 2 - \lambda & 0 \\ 0 & 1 & 3 - \lambda \end{vmatrix} \\ &= (2 - \lambda)^2 (3 - \lambda) \end{aligned}$$

Thus we see that the eigenvalues are  $\lambda = 2, 2, 3$ . Consider

$$\mathbf{A} - 2\mathbf{I} = \begin{pmatrix} 0 & 0 & 1 \\ 0 & 0 & 0 \\ 0 & 1 & 3 \end{pmatrix}.$$

Since  $\text{rank}(\text{nullspace}(\mathbf{A} - 2\mathbf{I})) = 1$  there is one eigenvector and one generalized eigenvector of rank two for

$\lambda = 2$ . The generalized eigenvector of rank two satisfies

$$\begin{aligned}(\mathbf{A} - 2\mathbf{I})^2 \mathbf{x}i_2 &= \mathbf{0} \\ \begin{pmatrix} 0 & 1 & 1 \\ 0 & 0 & 0 \\ 0 & 1 & 1 \end{pmatrix} \mathbf{x}i_2 &= \mathbf{0}\end{aligned}$$

We choose the solution

$$\mathbf{x}i_2 = \begin{pmatrix} 0 \\ -1 \\ 1 \end{pmatrix}.$$

The eigenvector for  $\lambda = 2$  is

$$\mathbf{x}i_1 = (\mathbf{A} - 2\mathbf{I})\mathbf{x}i_2 = \begin{pmatrix} 1 \\ 0 \\ 0 \end{pmatrix}.$$

The eigenvector for  $\lambda = 3$  satisfies

$$\begin{aligned}(\mathbf{A} - 3\mathbf{I})^2 \mathbf{x}i &= \mathbf{0} \\ \begin{pmatrix} -1 & 0 & 1 \\ 0 & -1 & 0 \\ 0 & 1 & 0 \end{pmatrix} \mathbf{x}i &= \mathbf{0}\end{aligned}$$

We choose the solution

$$\mathbf{x}i = \begin{pmatrix} 1 \\ 0 \\ 1 \end{pmatrix}.$$

The eigenvalues and generalized eigenvectors are

$$\lambda = \{2, 2, 3\}, \quad \mathbf{x}i = \left\{ \begin{pmatrix} 1 \\ 0 \\ 0 \end{pmatrix}, \begin{pmatrix} 0 \\ -1 \\ 1 \end{pmatrix}, \begin{pmatrix} 1 \\ 0 \\ 1 \end{pmatrix} \right\}.$$

The matrix of eigenvectors and its inverse is

$$\mathbf{S} = \begin{pmatrix} 1 & 0 & 1 \\ 0 & -1 & 0 \\ 0 & 1 & 1 \end{pmatrix}, \quad \mathbf{S}^{-1} = \begin{pmatrix} 1 & -1 & -1 \\ 0 & -1 & 0 \\ 0 & 1 & 1 \end{pmatrix}.$$

The Jordan canonical form of the matrix, which satisfies  $\mathbf{J} = \mathbf{S}^{-1}\mathbf{A}\mathbf{S}$  is

$$\mathbf{J} = \begin{pmatrix} 2 & 1 & 0 \\ 0 & 2 & 0 \\ 0 & 0 & 3 \end{pmatrix}$$

Recall that the function of a Jordan block is:

$$f \left( \begin{pmatrix} \lambda & 1 & 0 & 0 \\ 0 & \lambda & 1 & 0 \\ 0 & 0 & \lambda & 1 \\ 0 & 0 & 0 & \lambda \end{pmatrix} \right) = \begin{pmatrix} f(\lambda) & \frac{f'(\lambda)}{1!} & \frac{f''(\lambda)}{2!} & \frac{f'''(\lambda)}{3!} \\ 0 & f(\lambda) & \frac{f'(\lambda)}{1!} & \frac{f''(\lambda)}{2!} \\ 0 & 0 & f(\lambda) & \frac{f'(\lambda)}{1!} \\ 0 & 0 & 0 & f(\lambda) \end{pmatrix},$$

and that the function of a matrix in Jordan canonical form is

$$f \left( \begin{pmatrix} \mathbf{J}_1 & \mathbf{0} & \mathbf{0} & \mathbf{0} \\ \mathbf{0} & \mathbf{J}_2 & \mathbf{0} & \mathbf{0} \\ \mathbf{0} & \mathbf{0} & \mathbf{J}_3 & \mathbf{0} \\ \mathbf{0} & \mathbf{0} & \mathbf{0} & \mathbf{J}_4 \end{pmatrix} \right) = \begin{pmatrix} f(\mathbf{J}_1) & \mathbf{0} & \mathbf{0} & \mathbf{0} \\ \mathbf{0} & f(\mathbf{J}_2) & \mathbf{0} & \mathbf{0} \\ \mathbf{0} & \mathbf{0} & f(\mathbf{J}_3) & \mathbf{0} \\ \mathbf{0} & \mathbf{0} & \mathbf{0} & f(\mathbf{J}_4) \end{pmatrix}.$$

We want to compute  $e^{\mathbf{J}t}$  so we consider the function  $f(\lambda) = e^{\lambda t}$ , which has the derivative  $f'(\lambda) = t e^{\lambda t}$ . Thus we see that

$$e^{\mathbf{J}t} = \begin{pmatrix} e^{2t} & t e^{2t} & 0 \\ 0 & e^{2t} & 0 \\ 0 & 0 & e^{3t} \end{pmatrix}$$

The exponential matrix is

$$e^{\mathbf{A}t} = \mathbf{S} e^{\mathbf{J}t} \mathbf{S}^{-1},$$

$$e^{\mathbf{A}t} = \begin{pmatrix} e^{2t} & -(1+t)e^{2t} + e^{3t} & -e^{2t} + e^{3t} \\ 0 & e^{2t} & 0 \\ 0 & -e^{2t} + e^{3t} & e^{3t} \end{pmatrix}.$$

The general solution of the homogeneous differential equation is

$$\mathbf{x} = e^{\mathbf{A}t} \mathbf{c}.$$

2. The solution of the inhomogeneous differential equation subject to the initial condition is

$$\mathbf{x} = e^{\mathbf{A}t} \mathbf{0} + e^{\mathbf{A}t} \int_0^t e^{-\mathbf{A}\tau} \mathbf{g}(\tau) d\tau$$

$$\mathbf{x} = e^{\mathbf{A}t} \int_0^t e^{-\mathbf{A}\tau} \mathbf{g}(\tau) d\tau$$

### Solution 15.13

1.

$$\frac{d\mathbf{x}}{dt} = \frac{1}{t} \mathbf{A} \mathbf{x}$$
$$t \begin{pmatrix} x'_1 \\ x'_2 \end{pmatrix} = \begin{pmatrix} a & b \\ c & d \end{pmatrix} \begin{pmatrix} x_1 \\ x_2 \end{pmatrix}$$

The first component of this equation is

$$tx'_1 = ax_1 + bx_2.$$

We differentiate and multiply by  $t$  to obtain a second order coupled equation for  $x_1$ . We use (15.4) to eliminate the dependence on  $x_2$ .

$$\begin{aligned}t^2 x_1'' + tx_1' &= atx_1' + btx_2' \\t^2 x_1'' + (1-a)tx_1' &= b(cx_1 + dx_2) \\t^2 x_1'' + (1-a)tx_1' - bcx_1 &= d(tx_1' - ax_1) \\t^2 x_1'' + (1-a-d)tx_1' + (ad-bc)x_1 &= 0\end{aligned}$$

Thus we see that  $x_1$  satisfies a second order, Euler equation. By symmetry we see that  $x_2$  satisfies,

$$t^2 x_2'' + (1-b-c)tx_2' + (bc-ad)x_2 = 0.$$

2. We substitute  $\mathbf{x} = \mathbf{a}t^\lambda$  into (15.4).

$$\begin{aligned}\lambda \mathbf{a}t^{\lambda-1} &= \frac{1}{t} \mathbf{A} \mathbf{a} t^\lambda \\ \mathbf{A} \mathbf{a} &= \lambda \mathbf{a}\end{aligned}$$

Thus we see that  $\mathbf{x} = \mathbf{a}t^\lambda$  is a solution if  $\lambda$  is an eigenvalue of  $\mathbf{A}$  with eigenvector  $\mathbf{a}$ .

3. Suppose that  $\lambda = \alpha$  is an eigenvalue of multiplicity 2. If  $\lambda = \alpha$  has two linearly independent eigenvectors,  $\mathbf{a}$  and  $\mathbf{b}$  then  $\mathbf{a}t^\alpha$  and  $\mathbf{b}t^\alpha$  are linearly independent solutions. If  $\lambda = \alpha$  has only one linearly independent eigenvector,  $\mathbf{a}$ , then  $\mathbf{a}t^\alpha$  is a solution. We look for a second solution of the form

$$\mathbf{x} = \mathbf{x}i t^\alpha \log t + \boldsymbol{\eta} t^\alpha.$$

Substituting this into the differential equation yields

$$\alpha \mathbf{x}i t^{\alpha-1} \log t + \mathbf{x}i t^{\alpha-1} + \alpha \boldsymbol{\eta} t^{\alpha-1} = \mathbf{A} \mathbf{x}i t^{\alpha-1} \log t + \mathbf{A} \boldsymbol{\eta} t^{\alpha-1}$$

We equate coefficients of  $t^{\alpha-1} \log t$  and  $t^{\alpha-1}$  to determine  $\mathbf{x}i$  and  $\boldsymbol{\eta}$ .

$$(\mathbf{A} - \alpha \mathbf{I}) \mathbf{x}i = \mathbf{0}, \quad (\mathbf{A} - \alpha \mathbf{I}) \boldsymbol{\eta} = \mathbf{x}i$$



These equations have solutions because  $\lambda = \alpha$  has generalized eigenvectors of first and second order.

Note that the change of independent variable  $\tau = \log t$ ,  $\mathbf{y}(\tau) = \mathbf{x}(t)$ , will transform (15.4) into a constant coefficient system.

$$\frac{d\mathbf{y}}{d\tau} = \mathbf{A}\mathbf{y}$$

Thus all the methods for solving constant coefficient systems carry over directly to solving (15.4). In the case of eigenvalues with multiplicity greater than one, we will have solutions of the form,

$$\mathbf{x}i t^\alpha, \quad \mathbf{x}i t^\alpha \log t + \boldsymbol{\eta} t^\alpha, \quad \mathbf{x}i t^\alpha (\log t)^2 + \boldsymbol{\eta} t^\alpha \log t + \boldsymbol{\zeta} t^\alpha, \quad \dots,$$

analogous to the form of the solutions for a constant coefficient system,

$$\mathbf{x}i e^{\alpha\tau}, \quad \mathbf{x}i\tau e^{\alpha\tau} + \boldsymbol{\eta} e^{\alpha\tau}, \quad \mathbf{x}i\tau^2 e^{\alpha\tau} + \boldsymbol{\eta}\tau e^{\alpha\tau} + \boldsymbol{\zeta} e^{\alpha\tau}, \quad \dots$$

4. **Method 1.** Now we consider

$$\frac{d\mathbf{x}}{dt} = \frac{1}{t} \begin{pmatrix} 1 & 0 \\ 1 & 1 \end{pmatrix} \mathbf{x}.$$

The characteristic polynomial of the matrix is

$$\chi(\lambda) = \begin{vmatrix} 1 - \lambda & 0 \\ 1 & 1 - \lambda \end{vmatrix} = (1 - \lambda)^2.$$

$\lambda = 1$  is an eigenvalue of multiplicity 2. The equation for the associated eigenvectors is

$$\begin{pmatrix} 0 & 0 \\ 1 & 0 \end{pmatrix} \begin{pmatrix} \xi_1 \\ \xi_2 \end{pmatrix} = \begin{pmatrix} 0 \\ 0 \end{pmatrix}.$$

There is only one linearly independent eigenvector, which we choose to be

$$\mathbf{a} = \begin{pmatrix} 0 \\ 1 \end{pmatrix}.$$

One solution of the differential equation is

$$\mathbf{x}_1 = \begin{pmatrix} 0 \\ 1 \end{pmatrix} t.$$

We look for a second solution of the form

$$\mathbf{x}_2 = \mathbf{a}t \log t + \boldsymbol{\eta}t.$$

$\boldsymbol{\eta}$  satisfies the equation

$$(\mathbf{A} - I)\boldsymbol{\eta} = \begin{pmatrix} 0 & 0 \\ 1 & 0 \end{pmatrix} \boldsymbol{\eta} = \begin{pmatrix} 0 \\ 1 \end{pmatrix}.$$

The solution is determined only up to an additive multiple of  $\mathbf{a}$ . We choose

$$\boldsymbol{\eta} = \begin{pmatrix} 1 \\ 0 \end{pmatrix}.$$

Thus a second linearly independent solution is

$$\mathbf{x}_2 = \begin{pmatrix} 0 \\ 1 \end{pmatrix} t \log t + \begin{pmatrix} 1 \\ 0 \end{pmatrix} t.$$

The general solution of the differential equation is

$$\mathbf{x} = c_1 \begin{pmatrix} 0 \\ 1 \end{pmatrix} t + c_2 \left( \begin{pmatrix} 0 \\ 1 \end{pmatrix} t \log t + \begin{pmatrix} 1 \\ 0 \end{pmatrix} t \right).$$

**Method 2.** Note that the matrix is lower triangular.

$$\begin{pmatrix} x_1' \\ x_2' \end{pmatrix} = \frac{1}{t} \begin{pmatrix} 1 & 0 \\ 1 & 1 \end{pmatrix} \begin{pmatrix} x_1 \\ x_2 \end{pmatrix} \quad (15.5)$$

We have an uncoupled equation for  $x_1$ .

$$\begin{aligned} x_1' &= \frac{1}{t}x_1 \\ x_1 &= c_1t \end{aligned}$$

By substituting the solution for  $x_1$  into (15.5), we obtain an uncoupled equation for  $x_2$ .

$$x_2' = \frac{1}{t}(c_1 t + x_2)$$

$$x_2' - \frac{1}{t}x_2 = c_1$$

$$\left(\frac{1}{t}x_2\right)' = \frac{c_1}{t}$$

$$\frac{1}{t}x_2 = c_1 \log t + c_2$$

$$x_2 = c_1 t \log t + c_2 t$$

Thus the solution of the system is

$$\mathbf{x} = \begin{pmatrix} c_1 t \\ c_1 t \log t + c_2 t \end{pmatrix},$$

$$\mathbf{x} = c_1 \begin{pmatrix} t \\ t \log t \end{pmatrix} + c_2 \begin{pmatrix} 0 \\ t \end{pmatrix},$$

which is equivalent to the solution we obtained previously.

# Chapter 16

## Theory of Linear Ordinary Differential Equations

A little partyin' is good for the soul.

-Matt Metz

### 16.1 Exact Equations

#### Exercise 16.1

Consider a second order, linear, homogeneous differential equation:

$$P(x)y'' + Q(x)y' + R(x)y = 0. \quad (16.1)$$

Show that  $P'' - Q' + R = 0$  is a necessary and sufficient condition for this equation to be exact.

[Hint](#), [Solution](#)

#### Exercise 16.2

Determine an equation for the integrating factor  $\mu(x)$  for Equation [16.1](#).

Hint, Solution

### Exercise 16.3

Show that

$$y'' + xy' + y = 0$$

is exact. Find the solution.

Hint, Solution

## 16.2 Nature of Solutions

**Result 16.2.1** Consider the  $n^{\text{th}}$  order ordinary differential equation of the form

$$L[y] = \frac{d^n y}{dx^n} + p_{n-1}(x) \frac{d^{n-1} y}{dx^{n-1}} + \cdots + p_1(x) \frac{dy}{dx} + p_0(x)y = f(x). \quad (16.2)$$

If the coefficient functions  $p_{n-1}(x), \dots, p_0(x)$  and the inhomogeneity  $f(x)$  are continuous on some interval  $a < x < b$  then the differential equation subject to the conditions,

$$y(x_0) = v_0, \quad y'(x_0) = v_1, \quad \dots \quad y^{(n-1)}(x_0) = v_{n-1}, \quad a < x_0 < b,$$

has a unique solution on the interval.

### Exercise 16.4

On what intervals do the following problems have unique solutions?

1.  $xy'' + 3y = x$

2.  $x(x-1)y'' + 3xy' + 4y = 2$

$$3. e^x y'' + x^2 y' + y = \tan x$$

Hint, Solution

**Linearity of the Operator.** The differential operator  $L$  is linear. To verify this,

$$\begin{aligned} L[cy] &= \frac{d^n}{dx^n}(cy) + p_{n-1}(x) \frac{d^{n-1}}{dx^{n-1}}(cy) + \cdots + p_1(x) \frac{d}{dx}(cy) + p_0(x)(cy) \\ &= c \frac{d^n}{dx^n} y + cp_{n-1}(x) \frac{d^{n-1}}{dx^{n-1}} y + \cdots + cp_1(x) \frac{d}{dx} y + cp_0(x)y \\ &= cL[y] \\ L[y_1 + y_2] &= \frac{d^n}{dx^n}(y_1 + y_2) + p_{n-1}(x) \frac{d^{n-1}}{dx^{n-1}}(y_1 + y_2) + \cdots + p_1(x) \frac{d}{dx}(y_1 + y_2) + p_0(x)(y_1 + y_2) \\ &= \frac{d^n}{dx^n}(y_1) + p_{n-1}(x) \frac{d^{n-1}}{dx^{n-1}}(y_1) + \cdots + p_1(x) \frac{d}{dx}(y_1) + p_0(x)(y_1) \\ &\quad + \frac{d^n}{dx^n}(y_2) + p_{n-1}(x) \frac{d^{n-1}}{dx^{n-1}}(y_2) + \cdots + p_1(x) \frac{d}{dx}(y_2) + p_0(x)(y_2) \\ &= L[y_1] + L[y_2]. \end{aligned}$$

**Homogeneous Solutions.** The general homogeneous equation has the form

$$L[y] = \frac{d^n y}{dx^n} + p_{n-1}(x) \frac{d^{n-1} y}{dx^{n-1}} + \cdots + p_1(x) \frac{dy}{dx} + p_0(x)y = 0.$$

From the linearity of  $L$ , we see that if  $y_1$  and  $y_2$  are solutions to the homogeneous equation then  $c_1 y_1 + c_2 y_2$  is also a solution, ( $L[c_1 y_1 + c_2 y_2] = 0$ ).

On any interval where the coefficient functions are continuous, the  $n^{\text{th}}$  order linear homogeneous equation has  $n$  linearly independent solutions,  $y_1, y_2, \dots, y_n$ . (We will study linear independence in Section 16.4.) The general solution to the homogeneous problem is then

$$y_h = c_1 y_1 + c_2 y_2 + \cdots + c_n y_n.$$

**Particular Solutions.** Any function,  $y_p$ , that satisfies the inhomogeneous equation,  $L[y_p] = f(x)$ , is called a particular solution or particular integral of the equation. Note that for linear differential equations the particular solution is not unique. If  $y_p$  is a particular solution then  $y_p + y_h$  is also a particular solution where  $y_h$  is any homogeneous solution.

The general solution to the problem  $L[y] = f(x)$  is the sum of a particular solution and a linear combination of the homogeneous solutions

$$y = y_p + c_1 y_1 + \cdots + c_n y_n.$$

**Example 16.2.1** Consider the differential equation

$$y'' - y' = 1.$$

You can verify that two homogeneous solutions are  $e^x$  and 1. A particular solution is  $-x$ . Thus the general solution is

$$y = -x + c_1 e^x + c_2.$$

### Exercise 16.5

Suppose you are able to find three linearly independent particular solutions  $u_1(x)$ ,  $u_2(x)$  and  $u_3(x)$  of the second order linear differential equation  $L[y] = f(x)$ . What is the general solution?

**Hint, Solution**

**Real-Valued Solutions.** If the coefficient function and the inhomogeneity in Equation 16.2 are real-valued, then the general solution can be written in terms of real-valued functions. Let  $y$  be any, homogeneous solution, (perhaps complex-valued). By taking the complex conjugate of the equation  $L[y] = 0$  we show that  $\bar{y}$  is a homogeneous solution as well.

$$\begin{aligned} L[y] &= 0 \\ \overline{L[y]} &= 0 \\ \overline{y^{(n)} + p_{n-1}y^{(n-1)} + \cdots + p_0 y} &= 0 \\ \bar{y}^{(n)} + p_{n-1}\bar{y}^{(n-1)} + \cdots + p_0\bar{y} &= 0 \\ L[\bar{y}] &= 0 \end{aligned}$$

For the same reason, if  $y_p$  is a particular solution, then  $\overline{y_p}$  is a particular solution as well.

Since the real and imaginary parts of a function  $y$  are linear combinations of  $y$  and  $\overline{y}$ ,

$$\Re(y) = \frac{y + \overline{y}}{2}, \quad \Im(y) = \frac{y - \overline{y}}{i2},$$

if  $y$  is a homogeneous solution then both  $\Re y$  and  $\Im(y)$  are homogeneous solutions. Likewise, if  $y_p$  is a particular solution then  $\Re(y_p)$  is a particular solution.

$$L[\Re(y_p)] = L\left[\frac{y_p + \overline{y_p}}{2}\right] = \frac{f}{2} + \frac{f}{2} = f$$

Thus we see that the homogeneous solution, the particular solution and the general solution of a linear differential equation with real-valued coefficients and inhomogeneity can be written in terms of real-valued functions.

**Result 16.2.2** The differential equation

$$L[y] = \frac{d^n y}{dx^n} + p_{n-1}(x) \frac{d^{n-1} y}{dx^{n-1}} + \cdots + p_1(x) \frac{dy}{dx} + p_0(x)y = f(x)$$

with continuous coefficients and inhomogeneity has a general solution of the form

$$y = y_p + c_1 y_1 + \cdots + c_n y_n$$

where  $y_p$  is a particular solution,  $L[y_p] = f$ , and the  $y_k$  are linearly independent homogeneous solutions,  $L[y_k] = 0$ . If the coefficient functions and inhomogeneity are real-valued, then the general solution can be written in terms of real-valued functions.



## 16.3 Transformation to a First Order System

Any linear differential equation can be put in the form of a system of first order differential equations. Consider

$$y^{(n)} + p_{n-1}y^{(n-1)} + \cdots + p_0y = f(x).$$

We introduce the functions,

$$y_1 = y, \quad y_2 = y', \quad \dots, \quad y_n = y^{(n-1)}.$$

The differential equation is equivalent to the system

$$\begin{aligned}y_1' &= y_2 \\y_2' &= y_3 \\&\vdots \\y_n' &= f(x) - p_{n-1}y_n - \cdots - p_0y_1.\end{aligned}$$

The first order system is more useful when numerically solving the differential equation.

**Example 16.3.1** Consider the differential equation

$$y'' + x^2y' + \cos x y = \sin x.$$

The corresponding system of first order equations is

$$\begin{aligned}y_1' &= y_2 \\y_2' &= \sin x - x^2y_2 - \cos x y_1.\end{aligned}$$

## 16.4 The Wronskian

### 16.4.1 Derivative of a Determinant.

Before investigating the Wronskian, we will need a preliminary result from matrix theory. Consider an  $n \times n$  matrix  $A$  whose elements  $a_{ij}(x)$  are functions of  $x$ . We will denote the determinant by  $\Delta[A(x)]$ . We then have the following theorem.

**Result 16.4.1** Let  $a_{ij}(x)$ , the elements of the matrix  $A$ , be differentiable functions of  $x$ . Then

$$\frac{d}{dx} \Delta[A(x)] = \sum_{k=1}^n \Delta_k[A(x)]$$

where  $\Delta_k[A(x)]$  is the determinant of the matrix  $A$  with the  $k^{\text{th}}$  row replaced by the derivative of the  $k^{\text{th}}$  row.

**Example 16.4.1** Consider the the matrix

$$A(x) = \begin{pmatrix} x & x^2 \\ x^2 & x^4 \end{pmatrix}$$

The determinant is  $x^5 - x^4$  thus the derivative of the determinant is  $5x^4 - 4x^3$ . To check the theorem,

$$\begin{aligned} \frac{d}{dx} \Delta[A(x)] &= \frac{d}{dx} \begin{vmatrix} x & x^2 \\ x^2 & x^4 \end{vmatrix} \\ &= \begin{vmatrix} 1 & 2x \\ x^2 & x^4 \end{vmatrix} + \begin{vmatrix} x & x^2 \\ 2x & 4x^3 \end{vmatrix} \\ &= x^4 - 2x^3 + 4x^4 - 2x^3 \\ &= 5x^4 - 4x^3. \end{aligned}$$

## 16.4.2 The Wronskian of a Set of Functions.

A set of functions  $\{y_1, y_2, \dots, y_n\}$  is linearly dependent on an interval if there are constants  $c_1, \dots, c_n$  not all zero such that

$$c_1 y_1 + c_2 y_2 + \dots + c_n y_n = 0 \tag{16.3}$$

identically on the interval. The set is linearly independent if all of the constants must be zero to satisfy  $c_1 y_1 + \dots + c_n y_n = 0$  on the interval.

Consider a set of functions  $\{y_1, y_2, \dots, y_n\}$  that are linearly dependent on a given interval and  $n - 1$  times differentiable. There are a set of constants, not all zero, that satisfy equation 16.3

Differentiating equation 16.3  $n - 1$  times gives the equations,

$$\begin{aligned} c_1 y_1' + c_2 y_2' + \dots + c_n y_n' &= 0 \\ c_1 y_1'' + c_2 y_2'' + \dots + c_n y_n'' &= 0 \\ &\dots \\ c_1 y_1^{(n-1)} + c_2 y_2^{(n-1)} + \dots + c_n y_n^{(n-1)} &= 0. \end{aligned}$$

We could write the problem to find the constants as

$$\begin{pmatrix} y_1 & y_2 & \dots & y_n \\ y_1' & y_2' & \dots & y_n' \\ y_1'' & y_2'' & \dots & y_n'' \\ \vdots & \vdots & \ddots & \dots \\ y_1^{(n-1)} & y_2^{(n-1)} & \dots & y_n^{(n-1)} \end{pmatrix} \begin{pmatrix} c_1 \\ c_2 \\ c_3 \\ \vdots \\ c_n \end{pmatrix} = 0$$

From linear algebra, we know that this equation has a solution for a nonzero constant vector only if the determinant of the matrix is zero. Here we define the **Wronskian**,  $W(x)$ , of a set of functions.

$$W(x) = \begin{vmatrix} y_1 & y_2 & \dots & y_n \\ y_1' & y_2' & \dots & y_n' \\ \vdots & \vdots & \ddots & \dots \\ y_1^{(n-1)} & y_2^{(n-1)} & \dots & y_n^{(n-1)} \end{vmatrix}$$

Thus if a set of functions is linearly dependent on an interval, then the Wronskian is identically zero on that interval. Alternatively, if the Wronskian is identically zero, then the above matrix equation has a solution for a nonzero constant vector. This implies that the the set of functions is linearly dependent.

**Result 16.4.2** The Wronskian of a set of functions vanishes identically over an interval if and only if the set of functions is linearly dependent on that interval. The Wronskian of a set of linearly independent functions does not vanish except possibly at isolated points.

**Example 16.4.2** Consider the set,  $\{x, x^2\}$ . The Wronskian is

$$\begin{aligned}W(x) &= \begin{vmatrix} x & x^2 \\ 1 & 2x \end{vmatrix} \\ &= 2x^2 - x^2 \\ &= x^2.\end{aligned}$$

Thus the functions are independent.

**Example 16.4.3** Consider the set  $\{\sin x, \cos x, e^{ix}\}$ . The Wronskian is

$$W(x) = \begin{vmatrix} \sin x & \cos x & e^{ix} \\ \cos x & -\sin x & i e^{ix} \\ -\sin x & -\cos x & -e^{ix} \end{vmatrix}.$$

Since the last row is a constant multiple of the first row, the determinant is zero. The functions are dependent. We could also see this with the identity  $e^{ix} = \cos x + i \sin x$ .

### 16.4.3 The Wronskian of the Solutions to a Differential Equation

Consider the  $n^{\text{th}}$  order linear homogeneous differential equation

$$y^{(n)} + p_{n-1}(x)y^{(n-1)} + \cdots + p_0(x)y = 0.$$

Let  $\{y_1, y_2, \dots, y_n\}$  be any set of  $n$  linearly independent solutions. Let  $Y(x)$  be the matrix such that  $W(x) = \Delta[Y(x)]$ . Now let's differentiate  $W(x)$ .

$$\begin{aligned}W'(x) &= \frac{d}{dx} \Delta[Y(x)] \\ &= \sum_{k=1}^n \Delta_k[Y(x)]\end{aligned}$$

We note that the all but the last term in this sum is zero. To see this, let's take a look at the first term.

$$\Delta_1[Y(x)] = \begin{vmatrix} y_1' & y_2' & \cdots & y_n' \\ y_1' & y_2' & \cdots & y_n' \\ \vdots & \vdots & \ddots & \vdots \\ y_1^{(n-1)} & y_2^{(n-1)} & \cdots & y_n^{(n-1)} \end{vmatrix}$$

The first two rows in the matrix are identical. Since the rows are dependent, the determinant is zero.

The last term in the sum is

$$\Delta_n[Y(x)] = \begin{vmatrix} y_1 & y_2 & \cdots & y_n \\ \vdots & \vdots & \ddots & \vdots \\ y_1^{(n-2)} & y_2^{(n-2)} & \cdots & y_n^{(n-2)} \\ y_1^{(n)} & y_2^{(n)} & \cdots & y_n^{(n)} \end{vmatrix}.$$

In the last row of this matrix we make the substitution  $y_i^{(n)} = -p_{n-1}(x)y_i^{(n-1)} - \cdots - p_0(x)y_i$ . Recalling that we can add a multiple of a row to another without changing the determinant, we add  $p_0(x)$  times the first row, and  $p_1(x)$  times the second row, etc., to the last row. Thus we have the determinant,

$$\begin{aligned} W'(x) &= \begin{vmatrix} y_1 & y_2 & \cdots & y_n \\ \vdots & \vdots & \ddots & \vdots \\ y_1^{(n-2)} & y_2^{(n-2)} & \cdots & y_n^{(n-2)} \\ -p_{n-1}(x)y_1^{(n-1)} & -p_{n-1}(x)y_2^{(n-1)} & \cdots & -p_{n-1}(x)y_n^{(n-1)} \end{vmatrix} \\ &= -p_{n-1}(x) \begin{vmatrix} y_1 & y_2 & \cdots & y_n \\ \vdots & \vdots & \ddots & \vdots \\ y_1^{(n-2)} & y_2^{(n-2)} & \cdots & y_n^{(n-2)} \\ y_1^{(n-1)} & y_2^{(n-1)} & \cdots & y_n^{(n-1)} \end{vmatrix} \\ &= -p_{n-1}(x)W(x) \end{aligned}$$

Thus the Wronskian satisfies the first order differential equation,

$$W'(x) = -p_{n-1}(x)W(x).$$

Solving this equation we get a result known as **Abel's formula**.

$$W(x) = c \exp\left(-\int p_{n-1}(x) dx\right)$$

Thus regardless of the particular set of solutions that we choose, we can compute their Wronskian up to a constant factor.

**Result 16.4.3** The Wronskian of any linearly independent set of solutions to the equation

$$y^{(n)} + p_{n-1}(x)y^{(n-1)} + \cdots + p_0(x)y = 0$$

is, (up to a multiplicative constant), given by

$$W(x) = \exp\left(-\int p_{n-1}(x) dx\right).$$

**Example 16.4.4** Consider the differential equation

$$y'' - 3y' + 2y = 0.$$

The Wronskian of the two independent solutions is

$$\begin{aligned} W(x) &= c \exp\left(-\int -3 dx\right) \\ &= c e^{3x}. \end{aligned}$$

For the choice of solutions  $\{e^x, e^{2x}\}$ , the Wronskian is

$$W(x) = \begin{vmatrix} e^x & e^{2x} \\ e^x & 2e^{2x} \end{vmatrix} = 2e^{3x} - e^{3x} = e^{3x}.$$

## 16.5 Well-Posed Problems

Consider the initial value problem for an  $n^{\text{th}}$  order linear differential equation.

$$\frac{d^n y}{dx^n} + p_{n-1}(x) \frac{d^{n-1} y}{dx^{n-1}} + \cdots + p_1(x) \frac{dy}{dx} + p_0(x)y = f(x)$$

$$y(x_0) = v_1, \quad y'(x_0) = v_2, \quad \dots, \quad y^{(n-1)}(x_0) = v_n$$

Since the general solution to the differential equation is a linear combination of the  $n$  homogeneous solutions plus the particular solution

$$y = y_p + c_1 y_1 + c_2 y_2 + \cdots + c_n y_n,$$

the problem to find the constants  $c_i$  can be written

$$\begin{pmatrix} y_1(x_0) & y_2(x_0) & \cdots & y_n(x_0) \\ y_1'(x_0) & y_2'(x_0) & \cdots & y_n'(x_0) \\ \vdots & \vdots & \ddots & \vdots \\ y_1^{(n-1)}(x_0) & y_2^{(n-1)}(x_0) & \cdots & y_n^{(n-1)}(x_0) \end{pmatrix} \begin{pmatrix} c_1 \\ c_2 \\ \vdots \\ c_n \end{pmatrix} + \begin{pmatrix} y_p(x_0) \\ y_p'(x_0) \\ \vdots \\ y_p^{(n-1)}(x_0) \end{pmatrix} = \begin{pmatrix} v_1 \\ v_2 \\ \vdots \\ v_n \end{pmatrix}.$$

From linear algebra we know that this system of equations has a unique solution only if the determinant of the matrix is nonzero. Note that the determinant of the matrix is just the Wronskian evaluated at  $x_0$ . Thus if the Wronskian vanishes at  $x_0$ , the initial value problem for the differential equation either has no solutions or infinitely many solutions. Such problems are said to be ill-posed. From Abel's formula for the Wronskian

$$W(x) = \exp\left(-\int p_{n-1}(x) dx\right),$$

we see that the only way the Wronskian can vanish is if the value of the integral goes to  $\infty$ .

**Example 16.5.1** Consider the initial value problem

$$y'' - \frac{2}{x}y' + \frac{2}{x^2}y = 0, \quad y(0) = y'(0) = 1.$$

*The Wronskian*

$$W(x) = \exp\left(-\int -\frac{2}{x} dx\right) = \exp(2 \log x) = x^2$$

*vanishes at  $x = 0$ . Thus this problem is not well-posed.*

*The general solution of the differential equation is*

$$y = c_1x + c_2x^2.$$

*We see that the general solution cannot satisfy the initial conditions. If instead we had the initial conditions  $y(0) = 0$ ,  $y'(0) = 1$ , then there would be an infinite number of solutions.*

**Example 16.5.2** *Consider the initial value problem*

$$y'' - \frac{2}{x^2}y = 0, \quad y(0) = y'(0) = 1.$$

*The Wronskian*

$$W(x) = \exp\left(-\int 0 dx\right) = 1$$

*does not vanish anywhere. However, this problem is not well-posed.*

*The general solution,*

$$y = c_1x^{-1} + c_2x^2,$$

*cannot satisfy the initial conditions. Thus we see that a non-vanishing Wronskian does not imply that the problem is well-posed.*



**Result 16.5.1** Consider the initial value problem

$$\frac{d^n y}{dx^n} + p_{n-1}(x) \frac{d^{n-1} y}{dx^{n-1}} + \cdots + p_1(x) \frac{dy}{dx} + p_0(x)y = 0$$

$$y(x_0) = v_1, \quad y'(x_0) = v_2, \quad \dots, \quad y^{(n-1)}(x_0) = v_n.$$

If the Wronskian

$$W(x) = \exp\left(-\int p_{n-1}(x) dx\right)$$

vanishes at  $x = x_0$  then the problem is ill-posed. The problem may be ill-posed even if the Wronskian does not vanish.

## 16.6 The Fundamental Set of Solutions

Consider a set of linearly independent solutions  $\{u_1, u_2, \dots, u_n\}$  to an  $n^{\text{th}}$  order linear homogeneous differential equation. This is called the **fundamental set of solutions at  $x_0$**  if they satisfy the relations

$$\begin{array}{cccc} u_1(x_0) = 1 & u_2(x_0) = 0 & \dots & u_n(x_0) = 0 \\ u_1'(x_0) = 0 & u_2'(x_0) = 1 & \dots & u_n'(x_0) = 0 \\ \vdots & \vdots & \ddots & \vdots \\ u_1^{(n-1)}(x_0) = 0 & u_2^{(n-1)}(x_0) = 0 & \dots & u_n^{(n-1)}(x_0) = 1 \end{array}$$

Knowing the fundamental set of solutions is handy because it makes the task of solving an initial value problem trivial. Say we are given the initial conditions,

$$y(x_0) = v_1, \quad y'(x_0) = v_2, \quad \dots, \quad y^{(n-1)}(x_0) = v_n.$$

If the  $u_i$ 's are a fundamental set then the solution that satisfies these constraints is just

$$y = v_1 u_1(x) + v_2 u_2(x) + \cdots + v_n u_n(x).$$

Of course in general, a set of solutions is not the fundamental set. If the Wronskian of the solutions is nonzero and finite we can generate a fundamental set of solutions that are linear combinations of our original set. Consider the case of a second order equation. Let  $\{y_1, y_2\}$  be two linearly independent solutions. We will generate the fundamental set of solutions,  $\{u_1, u_2\}$ .

$$\begin{pmatrix} u_1 \\ u_2 \end{pmatrix} = \begin{pmatrix} c_{11} & c_{12} \\ c_{21} & c_{22} \end{pmatrix} \begin{pmatrix} y_1 \\ y_2 \end{pmatrix}$$

For  $\{u_1, u_2\}$  to satisfy the relations that define a fundamental set, it must satisfy the matrix equation

$$\begin{pmatrix} u_1(x_0) & u_1'(x_0) \\ u_2(x_0) & u_2'(x_0) \end{pmatrix} = \begin{pmatrix} c_{11} & c_{12} \\ c_{21} & c_{22} \end{pmatrix} \begin{pmatrix} y_1(x_0) & y_1'(x_0) \\ y_2(x_0) & y_2'(x_0) \end{pmatrix} = \begin{pmatrix} 1 & 0 \\ 0 & 1 \end{pmatrix}$$

$$\begin{pmatrix} c_{11} & c_{12} \\ c_{21} & c_{22} \end{pmatrix} = \begin{pmatrix} y_1(x_0) & y_1'(x_0) \\ y_2(x_0) & y_2'(x_0) \end{pmatrix}^{-1}$$

If the Wronskian is non-zero and finite, we can solve for the constants,  $c_{ij}$ , and thus find the fundamental set of solutions. To generalize this result to an equation of order  $n$ , simply replace all the  $2 \times 2$  matrices and vectors of length 2 with  $n \times n$  matrices and vectors of length  $n$ . I presented the case of  $n = 2$  simply to save having to write out all the ellipses involved in the general case. (It also makes for easier reading.)

**Example 16.6.1** Two linearly independent solutions to the differential equation  $y'' + y = 0$  are  $y_1 = e^{ix}$  and  $y_2 = e^{-ix}$ .

$$\begin{pmatrix} y_1(0) & y_1'(0) \\ y_2(0) & y_2'(0) \end{pmatrix} = \begin{pmatrix} 1 & i \\ 1 & -i \end{pmatrix}$$

To find the fundamental set of solutions,  $\{u_1, u_2\}$ , at  $x = 0$  we solve the equation

$$\begin{pmatrix} c_{11} & c_{12} \\ c_{21} & c_{22} \end{pmatrix} = \begin{pmatrix} 1 & i \\ 1 & -i \end{pmatrix}^{-1}$$

$$\begin{pmatrix} c_{11} & c_{12} \\ c_{21} & c_{22} \end{pmatrix} = \frac{1}{i^2} \begin{pmatrix} i & i \\ 1 & -1 \end{pmatrix}$$

The fundamental set is

$$u_1 = \frac{e^{ix} + e^{-ix}}{2}, \quad u_2 = \frac{e^{ix} - e^{-ix}}{i2}.$$

Using trigonometric identities we can rewrite these as

$$u_1 = \cos x, \quad u_2 = \sin x.$$

**Result 16.6.1** The fundamental set of solutions at  $x = x_0$ ,  $\{u_1, u_2, \dots, u_n\}$ , to an  $n^{\text{th}}$  order linear differential equation, satisfy the relations

$$\begin{array}{ccccccc} u_1(x_0) = 1 & u_2(x_0) = 0 & \dots & u_n(x_0) = 0 & & & \\ u_1'(x_0) = 0 & u_2'(x_0) = 1 & \dots & u_n'(x_0) = 0 & & & \\ \vdots & \vdots & \ddots & \vdots & & & \\ u_1^{(n-1)}(x_0) = 0 & u_2^{(n-1)}(x_0) = 0 & \dots & u_n^{(n-1)}(x_0) = 1. & & & \end{array}$$

If the Wronskian of the solutions is nonzero and finite at the point  $x_0$  then you can generate the fundamental set of solutions from any linearly independent set of solutions.

### Exercise 16.6

Two solutions of  $y'' - y = 0$  are  $e^x$  and  $e^{-x}$ . Show that the solutions are independent. Find the fundamental set of solutions at  $x = 0$ .

**Hint, Solution**

## 16.7 Adjoint Equations

For the  $n^{\text{th}}$  order linear differential operator

$$L[y] = p_n \frac{d^n y}{dx^n} + p_{n-1} \frac{d^{n-1} y}{dx^{n-1}} + \dots + p_0 y$$

(where the  $p_j$  are complex-valued functions) we define the adjoint of  $L$

$$L^*[y] = (-1)^n \frac{d^n}{dx^n}(\overline{p_n}y) + (-1)^{n-1} \frac{d^{n-1}}{dx^{n-1}}(\overline{p_{n-1}}y) + \cdots + \overline{p_0}y.$$

Here  $\overline{f}$  denotes the complex conjugate of  $f$ .

**Example 16.7.1**

$$L[y] = xy'' + \frac{1}{x}y' + y$$

has the adjoint

$$\begin{aligned} L^*[y] &= \frac{d^2}{dx^2}[xy] - \frac{d}{dx} \left[ \frac{1}{x}y \right] + y \\ &= xy'' + 2y' - \frac{1}{x}y' + \frac{1}{x^2}y + y \\ &= xy'' + \left( 2 - \frac{1}{x} \right) y' + \left( 1 + \frac{1}{x^2} \right) y. \end{aligned}$$

Taking the adjoint of  $L^*$  yields

$$\begin{aligned} L^{**}[y] &= \frac{d^2}{dx^2}[xy] - \frac{d}{dx} \left[ \left( 2 - \frac{1}{x} \right) y \right] + \left( 1 + \frac{1}{x^2} \right) y \\ &= xy'' + 2y' - \left( 2 - \frac{1}{x} \right) y' - \left( \frac{1}{x^2} \right) y + \left( 1 + \frac{1}{x^2} \right) y \\ &= xy'' + \frac{1}{x}y' + y. \end{aligned}$$

Thus by taking the adjoint of  $L^*$ , we obtain the original operator.

In general,  $L^{**} = L$ .

Consider  $L[y] = p_n y^{(n)} + \cdots + p_0 y$ . If each of the  $p_k$  is  $k$  times continuously differentiable and  $u$  and  $v$  are  $n$  times continuously differentiable on some interval, then on that interval

$$\bar{v}L[u] - u\overline{L^*[v]} = \frac{d}{dx}B[u, v]$$

where  $B[u, v]$ , the **bilinear concomitant**, is the bilinear form

$$B[u, v] = \sum_{m=1}^n \sum_{\substack{j+k=m-1 \\ j \geq 0, k \geq 0}} (-1)^j u^{(k)} (p_m \bar{v})^{(j)}.$$

This equation is known as **Lagrange's identity**. If  $L$  is a second order operator then

$$\begin{aligned} \bar{v}L[u] - u\overline{L^*[v]} &= \frac{d}{dx} [up_1\bar{v} + u'p_2\bar{v} - u(p_2\bar{v})'] \\ &= u''p_2\bar{v} + u'p_1\bar{v} + u[-p_2\bar{v}'' + (-2p_2' + p_1)\bar{v}' + (-p_2'' + p_1')\bar{v}]. \end{aligned}$$

**Example 16.7.2** Verify Lagrange's identity for the second order operator,  $L[y] = p_2 y'' + p_1 y' + p_0 y$ .

$$\begin{aligned} \bar{v}L[u] - u\overline{L^*[v]} &= \bar{v}(p_2 u'' + p_1 u' + p_0 u) - u \overline{\left( \frac{d^2}{dx^2}(\bar{p}_2 v) - \frac{d}{dx}(\bar{p}_1 v) + \bar{p}_0 v \right)} \\ &= \bar{v}(p_2 u'' + p_1 u' + p_0 u) - u \overline{(\bar{p}_2 v'' + (2\bar{p}_2' - \bar{p}_1)v' + (\bar{p}_2'' - \bar{p}_1' + \bar{p}_0)v)} \\ &= u''p_2\bar{v} + u'p_1\bar{v} + u[-p_2\bar{v}'' + (-2p_2' + p_1)\bar{v}' + (-p_2'' + p_1')\bar{v}]. \end{aligned}$$

We will not verify Lagrange's identity for the general case.

Integrating Lagrange's identity on its interval of validity gives us **Green's formula**.

$$\int_a^b \left( \bar{v}L[u] - u\overline{L^*[v]} \right) dx = B[u, v] \Big|_{x=b} - B[u, v] \Big|_{x=a}$$

**Result 16.7.1** The adjoint of the operator

$$L[y] = p_n \frac{d^n y}{dx^n} + p_{n-1} \frac{d^{n-1} y}{dx^{n-1}} + \cdots + p_0 y$$

is defined

$$L^*[y] = (-1)^n \frac{d^n}{dx^n} (\overline{p_n y}) + (-1)^{n-1} \frac{d^{n-1}}{dx^{n-1}} (\overline{p_{n-1} y}) + \cdots + \overline{p_0 y}.$$

If each of the  $p_k$  is  $k$  times continuously differentiable and  $u$  and  $v$  are  $n$  times continuously differentiable, then Lagrange's identity states

$$\overline{v}L[u] - u\overline{L^*[v]} = \frac{d}{dx} B[u, v] = \frac{d}{dx} \sum_{m=1}^n \sum_{\substack{j+k=m-1 \\ j \geq 0, k \geq 0}} (-1)^j u^{(k)} (p_m \overline{v})^{(j)}.$$

Integrating Lagrange's identity on it's domain of validity yields Green's formula,

$$\int_a^b \left( \overline{v}L[u] - u\overline{L^*[v]} \right) dx = B[u, v] \Big|_{x=b} - B[u, v] \Big|_{x=a}.$$

## 16.8 Additional Exercises

**Exact Equations**

**Nature of Solutions**

**Transformation to a First Order System**

**The Wronskian**

**Well-Posed Problems**

**The Fundamental Set of Solutions**

**Adjoint Equations**

### Exercise 16.7

Find the adjoint of the Bessel equation of order  $\nu$ ,

$$x^2y'' + xy' + (x^2 - \nu^2)y = 0,$$

and the Legendre equation of order  $\alpha$ ,

$$(1 - x^2)y'' - 2xy' + \alpha(\alpha + 1)y = 0.$$

**Hint, Solution**

### Exercise 16.8

Find the adjoint of

$$x^2y'' - xy' + 3y = 0.$$

**Hint, Solution**

## 16.9 Hints

Hint 16.1

Hint 16.2

Hint 16.3

Hint 16.4

Hint 16.5

The difference of any two of the  $u_i$ 's is a homogeneous solution.

Hint 16.6

**Exact Equations**

**Nature of Solutions**

**Transformation to a First Order System**

**The Wronskian**

**Well-Posed Problems**

**The Fundamental Set of Solutions**

**Adjoint Equations**

Hint 16.7



## Hint 16.8

## 16.10 Solutions

### Solution 16.1

The second order, linear, homogeneous differential equation is

$$P(x)y'' + Q(x)y' + R(x)y = 0. \quad (16.4)$$

An exact equation can be written in the form:

$$\frac{d}{dx} [a(x)y' + b(x)y] = 0.$$

If Equation 16.4 is exact, then we can write it in the form:

$$\frac{d}{dx} [P(x)y' + f(x)y] = 0$$

for some function  $f(x)$ . We carry out the differentiation to write the equation in standard form:

$$P(x)y'' + (P'(x) + f(x))y' + f'(x)y = 0 \quad (16.5)$$

We equate the coefficients of Equations 16.4 and 16.5 to obtain a set of equations.

$$P'(x) + f(x) = Q(x), \quad f'(x) = R(x).$$

In order to eliminate  $f(x)$ , we differentiate the first equation and substitute in the expression for  $f'(x)$  from the second equation. This gives us a *necessary* condition for Equation 16.4 to be exact:

$$\boxed{P''(x) - Q'(x) + R(x) = 0} \quad (16.6)$$

Now we demonstrate that Equation 16.6 is a *sufficient* condition for exactness. Suppose that Equation 16.6 holds. Then we can replace  $R$  by  $Q' - P''$  in the differential equation.

$$Py'' + Qy' + (Q' - P'')y = 0$$

We recognize the right side as an exact differential.

$$(Py' + (Q - P')y)' = 0$$

Thus Equation 16.6 is a sufficient condition for exactness. We can integrate to reduce the problem to a first order differential equation.

$$Py' + (Q - P')y = c$$

### Solution 16.2

Suppose that there is an integrating factor  $\mu(x)$  that will make

$$P(x)y'' + Q(x)y' + R(x)y = 0$$

exact. We multiply by this integrating factor.

$$\mu(x)P(x)y'' + \mu(x)Q(x)y' + \mu(x)R(x)y = 0. \quad (16.7)$$

We apply the exactness condition from Exercise 16.1 to obtain a differential equation for the integrating factor.

$$\begin{aligned}(\mu P)'' - (\mu Q)' + \mu R &= 0 \\ \mu'' P + 2\mu' P' + \mu P'' - \mu' Q - \mu Q' + \mu R &= 0 \\ \boxed{P\mu'' + (2P' - Q)\mu' + (P'' - Q' + R)\mu} &= 0\end{aligned}$$

### Solution 16.3

We consider the differential equation,

$$y'' + xy' + y = 0.$$

Since

$$(1)'' - (x)' + 1 = 0$$

we see that this is an exact equation. We rearrange terms to form exact derivatives and then integrate.

$$(y')' + (xy)' = 0$$

$$y' + xy = c$$

$$\frac{d}{dx} [e^{x^2/2} y] = c e^{x^2/2}$$

$$y = c e^{-x^2/2} \int e^{x^2/2} dx + d e^{-x^2/2}$$

### Solution 16.4

Consider the initial value problem,

$$y'' + p(x)y' + q(x)y = f(x),$$
$$y(x_0) = y_0, \quad y'(x_0) = y_1.$$

If  $p(x)$ ,  $q(x)$  and  $f(x)$  are continuous on an interval  $(a \dots b)$  with  $x_0 \in (a \dots b)$ , then the problem has a unique solution on that interval.

1.

$$xy'' + 3y = x$$
$$y'' + \frac{3}{x}y = 1$$

Unique solutions exist on the intervals  $(-\infty \dots 0)$  and  $(0 \dots \infty)$ .

2.

$$x(x-1)y'' + 3xy' + 4y = 2$$
$$y'' + \frac{3}{x-1}y' + \frac{4}{x(x-1)}y = \frac{2}{x(x-1)}$$

Unique solutions exist on the intervals  $(-\infty \dots 0)$ ,  $(0 \dots 1)$  and  $(1 \dots \infty)$ .

3.

$$\begin{aligned}e^x y'' + x^2 y' + y &= \tan x \\ y'' + x^2 e^{-x} y' + e^{-x} y &= e^{-x} \tan x\end{aligned}$$

Unique solutions exist on the intervals  $\left(\frac{(2n-1)\pi}{2} \dots \frac{(2n+1)\pi}{2}\right)$  for  $n \in \mathbb{Z}$ .

### Solution 16.5

We know that the general solution is

$$y = y_p + c_1 y_1 + c_2 y_2,$$

where  $y_p$  is a particular solution and  $y_1$  and  $y_2$  are linearly independent homogeneous solutions. Since  $y_p$  can be any particular solution, we choose  $y_p = u_1$ . Now we need to find two homogeneous solutions. Since  $L[u_i] = f(x)$ ,  $L[u_1 - u_2] = L[u_2 - u_3] = 0$ . Finally, we note that since the  $u_i$ 's are linearly independent,  $y_1 = u_1 - u_2$  and  $y_2 = u_2 - u_3$  are linearly independent. Thus the general solution is

$$y = u_1 + c_1(u_1 - u_2) + c_2(u_2 - u_3).$$

### Solution 16.6

The Wronskian of the solutions is

$$W(x) = \begin{vmatrix} e^x & e^{-x} \\ e^x & -e^{-x} \end{vmatrix} = -2.$$

Since the Wronskian is nonzero, the solutions are independent.

The fundamental set of solutions,  $\{u_1, u_2\}$ , is a linear combination of  $e^x$  and  $e^{-x}$ .

$$\begin{pmatrix} u_1 \\ u_2 \end{pmatrix} = \begin{pmatrix} c_{11} & c_{12} \\ c_{21} & c_{22} \end{pmatrix} \begin{pmatrix} e^x \\ e^{-x} \end{pmatrix}$$

The coefficients are

$$\begin{aligned}\begin{pmatrix} c_{11} & c_{12} \\ c_{21} & c_{22} \end{pmatrix} &= \begin{pmatrix} e^0 & e^0 \\ e^{-0} & -e^{-0} \end{pmatrix}^{-1} \\ &= \begin{pmatrix} 1 & 1 \\ 1 & -1 \end{pmatrix}^{-1} \\ &= \frac{1}{-2} \begin{pmatrix} -1 & -1 \\ -1 & 1 \end{pmatrix} \\ &= \frac{1}{2} \begin{pmatrix} 1 & 1 \\ 1 & -1 \end{pmatrix}\end{aligned}$$

$$u_1 = \frac{1}{2}(e^x + e^{-x}), \quad u_2 = \frac{1}{2}(e^x - e^{-x}).$$

The fundamental set of solutions at  $x = 0$  is

$$\boxed{\{\cosh x, \sinh x\}}.$$

**Exact Equations**

**Nature of Solutions**

**Transformation to a First Order System**

**The Wronskian**

**Well-Posed Problems**

**The Fundamental Set of Solutions**

**Adjoint Equations**

**Solution 16.7**

1. The Bessel equation of order  $\nu$  is

$$x^2 y'' + xy' + (x^2 - \nu^2)y = 0.$$

The adjoint equation is

$$x^2\mu'' + (4x - x)\mu' + (2 - 1 + x^2 - \nu^2)\mu = 0$$

$$\boxed{x^2\mu'' + 3x\mu' + (1 + x^2 - \nu^2)\mu = 0.}$$

2. The Legendre equation of order  $\alpha$  is

$$(1 - x^2)y'' - 2xy' + \alpha(\alpha + 1)y = 0$$

The adjoint equation is

$$(1 - x^2)\mu'' + (-4x + 2x)\mu' + (-2 + 2 + \alpha(\alpha + 1))\mu = 0$$

$$\boxed{(1 - x^2)\mu'' - 2x\mu' + \alpha(\alpha + 1)\mu = 0}$$

### Solution 16.8

The adjoint of

$$x^2y'' - xy' + 3y = 0$$

is

$$\frac{d^2}{dx^2}(x^2y) + \frac{d}{dx}(xy) + 3y = 0$$

$$(x^2y'' + 4xy' + 2y) + (xy' + y) + 3y = 0$$

$$\boxed{x^2y'' + 5xy' + 6y = 0.}$$

## 16.11 Quiz

### Problem 16.1

What is the differential equation whose solution is the two parameter family of curves  $y = c_1 \sin(2x + c_2)$ ?

**Solution**



## 16.12 Quiz Solutions

### Solution 16.1

We take the first and second derivative of  $y = c_1 \sin(2x + c_2)$ .

$$y' = 2c_1 \cos(2x + c_2)$$

$$y'' = -4c_1 \sin(2x + c_2)$$

This gives us three equations involving  $x$ ,  $y$ ,  $y'$ ,  $y''$  and the parameters  $c_1$  and  $c_2$ . We eliminate the the parameters to obtain the differential equation. Clearly we have,

$$y'' + 4y = 0.$$

# Chapter 17

## Techniques for Linear Differential Equations

My new goal in life is to take the meaningless drivel out of human interaction.

-Dave Ozenne

The  $n^{\text{th}}$  order linear homogeneous differential equation can be written in the form:

$$y^{(n)} + a_{n-1}(x)y^{(n-1)} + \cdots + a_1(x)y' + a_0(x)y = 0.$$

In general it is not possible to solve second order and higher linear differential equations. In this chapter we will examine equations that have special forms which allow us to either reduce the order of the equation or solve it.

### 17.1 Constant Coefficient Equations

The  $n^{\text{th}}$  order constant coefficient differential equation has the form:

$$y^{(n)} + a_{n-1}y^{(n-1)} + \cdots + a_1y' + a_0y = 0.$$

We will find that solving a constant coefficient differential equation is no more difficult than finding the roots of a polynomial. For notational simplicity, we will first consider second order equations. Then we will apply the same techniques to higher order equations.

### 17.1.1 Second Order Equations

**Factoring the Differential Equation.** Consider the second order constant coefficient differential equation:

$$y'' + 2ay' + by = 0. \quad (17.1)$$

Just as we can factor a second degree polynomial:

$$\lambda^2 + 2a\lambda + b = (\lambda - \alpha)(\lambda - \beta), \alpha = -a + \sqrt{a^2 - b} \quad \text{and} \quad \beta = -a - \sqrt{a^2 - b},$$

we can factor Equation 17.1.

$$\left( \frac{d^2}{dx^2} + 2a \frac{d}{dx} + b \right) y = \left( \frac{d}{dx} - \alpha \right) \left( \frac{d}{dx} - \beta \right) y$$

Once we have factored the differential equation, we can solve it by solving a series of two first order differential equations.

We set  $u = \left( \frac{d}{dx} - \beta \right) y$  to obtain a first order equation:

$$\left( \frac{d}{dx} - \alpha \right) u = 0,$$

which has the solution:

$$u = c_1 e^{\alpha x}.$$

To find the solution of Equation 17.1, we solve

$$\left( \frac{d}{dx} - \beta \right) y = u = c_1 e^{\alpha x}.$$

We multiply by the integrating factor and integrate.

$$\begin{aligned}\frac{d}{dx} (e^{-\beta x} y) &= c_1 e^{(\alpha-\beta)x} \\ y &= c_1 e^{\beta x} \int e^{(\alpha-\beta)x} dx + c_2 e^{\beta x}\end{aligned}$$

We first consider the case that  $\alpha$  and  $\beta$  are distinct.

$$y = c_1 e^{\beta x} \frac{1}{\alpha - \beta} e^{(\alpha-\beta)x} + c_2 e^{\beta x}$$

We choose new constants to write the solution in a simpler form.

$$y = c_1 e^{\alpha x} + c_2 e^{\beta x}$$

Now we consider the case  $\alpha = \beta$ .

$$\begin{aligned}y &= c_1 e^{\alpha x} \int 1 dx + c_2 e^{\alpha x} \\ y &= c_1 x e^{\alpha x} + c_2 e^{\alpha x}\end{aligned}$$

The solution of Equation 17.1 is

$$y = \begin{cases} c_1 e^{\alpha x} + c_2 e^{\beta x}, & \alpha \neq \beta, \\ c_1 e^{\alpha x} + c_2 x e^{\alpha x}, & \alpha = \beta. \end{cases} \quad (17.2)$$

**Example 17.1.1** Consider the differential equation:  $y'' + y = 0$ . To obtain the general solution, we factor the equation and apply the result in Equation 17.2.

$$\begin{aligned}\left(\frac{d}{dx} - i\right) \left(\frac{d}{dx} + i\right) y &= 0 \\ y &= c_1 e^{ix} + c_2 e^{-ix}.\end{aligned}$$

**Example 17.1.2** Next we solve  $y'' = 0$ .

$$\begin{aligned}\left(\frac{d}{dx} - 0\right)\left(\frac{d}{dx} - 0\right)y &= 0 \\ y &= c_1 e^{0x} + c_2 x e^{0x} \\ y &= c_1 + c_2 x\end{aligned}$$

**Substituting the Form of the Solution into the Differential Equation.** Note that if we substitute  $y = e^{\lambda x}$  into the differential equation (17.1), we will obtain the quadratic polynomial (17.1.1) for  $\lambda$ .

$$\begin{aligned}y'' + 2ay' + by &= 0 \\ \lambda^2 e^{\lambda x} + 2a\lambda e^{\lambda x} + b e^{\lambda x} &= 0 \\ \lambda^2 + 2a\lambda + b &= 0\end{aligned}$$

This gives us a superficially different method for solving constant coefficient equations. We substitute  $y = e^{\lambda x}$  into the differential equation. Let  $\alpha$  and  $\beta$  be the roots of the quadratic in  $\lambda$ . If the roots are distinct, then the linearly independent solutions are  $y_1 = e^{\alpha x}$  and  $y_2 = e^{\beta x}$ . If the quadratic has a double root at  $\lambda = \alpha$ , then the linearly independent solutions are  $y_1 = e^{\alpha x}$  and  $y_2 = x e^{\alpha x}$ .

**Example 17.1.3** Consider the equation:

$$y'' - 3y' + 2y = 0.$$

The substitution  $y = e^{\lambda x}$  yields

$$\lambda^2 - 3\lambda + 2 = (\lambda - 1)(\lambda - 2) = 0.$$

Thus the solutions are  $e^x$  and  $e^{2x}$ .

**Example 17.1.4** Next consider the equation:

$$y'' - 2y' + 4y = 0.$$

The substitution  $y = e^{\lambda x}$  yields

$$\lambda^2 - 2\lambda + 4 = (\lambda - 2)^2 = 0.$$

Because the polynomial has a double root, the solutions are  $e^{2x}$  and  $x e^{2x}$ .

**Result 17.1.1** Consider the second order constant coefficient differential equation:

$$y'' + 2ay' + by = 0.$$

We can factor the differential equation into the form:

$$\left(\frac{d}{dx} - \alpha\right) \left(\frac{d}{dx} - \beta\right) y = 0,$$

which has the solution:

$$y = \begin{cases} c_1 e^{\alpha x} + c_2 e^{\beta x}, & \alpha \neq \beta, \\ c_1 e^{\alpha x} + c_2 x e^{\alpha x}, & \alpha = \beta. \end{cases}$$

We can also determine  $\alpha$  and  $\beta$  by substituting  $y = e^{\lambda x}$  into the differential equation and factoring the polynomial in  $\lambda$ .

**Shift Invariance.** Note that if  $u(x)$  is a solution of a constant coefficient equation, then  $u(x + c)$  is also a solution. This is useful in applying initial or boundary conditions.

**Example 17.1.5** Consider the problem

$$y'' - 3y' + 2y = 0, \quad y(0) = a, \quad y'(0) = b.$$

We know that the general solution is

$$y = c_1 e^x + c_2 e^{2x}.$$

Applying the initial conditions, we obtain the equations,

$$c_1 + c_2 = a, \quad c_1 + 2c_2 = b.$$

The solution is

$$y = (2a - b)e^x + (b - a)e^{2x}.$$

Now suppose we wish to solve the same differential equation with the boundary conditions  $y(1) = a$  and  $y'(1) = b$ . All we have to do is shift the solution to the right.

$$y = (2a - b)e^{x-1} + (b - a)e^{2(x-1)}.$$

## 17.1.2 Real-Valued Solutions

If the coefficients of the differential equation are real, then the solution can be written in terms of real-valued functions (Result 16.2.2). For a real root  $\lambda = \alpha$  of the polynomial in  $\lambda$ , the corresponding solution,  $y = e^{\alpha x}$ , is real-valued.

Now recall that the complex roots of a polynomial with real coefficients occur in complex conjugate pairs. Assume that  $\alpha \pm i\beta$  are roots of

$$\lambda^n + a_{n-1}\lambda^{n-1} + \cdots + a_1\lambda + a_0 = 0.$$

The corresponding solutions of the differential equation are  $e^{(\alpha+i\beta)x}$  and  $e^{(\alpha-i\beta)x}$ . Note that the linear combinations

$$\frac{e^{(\alpha+i\beta)x} + e^{(\alpha-i\beta)x}}{2} = e^{\alpha x} \cos(\beta x), \quad \frac{e^{(\alpha+i\beta)x} - e^{(\alpha-i\beta)x}}{i2} = e^{\alpha x} \sin(\beta x),$$

are real-valued solutions of the differential equation. We could also obtain real-valued solution by taking the real and imaginary parts of either  $e^{(\alpha+i\beta)x}$  or  $e^{(\alpha-i\beta)x}$ .

$$\Re(e^{(\alpha+i\beta)x}) = e^{\alpha x} \cos(\beta x), \quad \Im(e^{(\alpha+i\beta)x}) = e^{\alpha x} \sin(\beta x)$$

**Example 17.1.6** Consider the equation

$$y'' - 2y' + 2y = 0.$$

The substitution  $y = e^{\lambda x}$  yields

$$\lambda^2 - 2\lambda + 2 = (\lambda - 1 - i)(\lambda - 1 + i) = 0.$$

The linearly independent solutions are

$$e^{(1+i)x}, \quad \text{and} \quad e^{(1-i)x}.$$

We can write the general solution in terms of real functions.

$$y = c_1 e^x \cos x + c_2 e^x \sin x$$

### Exercise 17.1

Find the general solution of

$$y'' + 2ay' + by = 0$$

for  $a, b \in \mathbb{R}$ . There are three distinct forms of the solution depending on the sign of  $a^2 - b$ .

**Hint, Solution**

### Exercise 17.2

Find the **fundamental set of solutions** of

$$y'' + 2ay' + by = 0$$

at the point  $x = 0$ , for  $a, b \in \mathbb{R}$ . Use the general solutions obtained in Exercise 17.1.

**Hint, Solution**



**Result 17.1.2** . Consider the second order constant coefficient equation

$$y'' + 2ay' + by = 0.$$

The general solution of this differential equation is

$$y = \begin{cases} e^{-ax} \left( c_1 e^{\sqrt{a^2-b}x} + c_2 e^{-\sqrt{a^2-b}x} \right) & \text{if } a^2 > b, \\ e^{-ax} \left( c_1 \cos(\sqrt{b-a^2}x) + c_2 \sin(\sqrt{b-a^2}x) \right) & \text{if } a^2 < b, \\ e^{-ax}(c_1 + c_2x) & \text{if } a^2 = b. \end{cases}$$

The **fundamental set of solutions** at  $x = 0$  is

$$\begin{cases} \left\{ e^{-ax} \left( \cosh(\sqrt{a^2-b}x) + \frac{a}{\sqrt{a^2-b}} \sinh(\sqrt{a^2-b}x) \right), e^{-ax} \frac{1}{\sqrt{a^2-b}} \sinh(\sqrt{a^2-b}x) \right\} & \text{if } a^2 > b, \\ \left\{ e^{-ax} \left( \cos(\sqrt{b-a^2}x) + \frac{a}{\sqrt{b-a^2}} \sin(\sqrt{b-a^2}x) \right), e^{-ax} \frac{1}{\sqrt{b-a^2}} \sin(\sqrt{b-a^2}x) \right\} & \text{if } a^2 < b, \\ \{(1+ax)e^{-ax}, xe^{-ax}\} & \text{if } a^2 = b. \end{cases}$$

To obtain the **fundamental set of solutions** at the point  $x = \xi$ , substitute  $(x - \xi)$  for  $x$  in the above solutions.

### 17.1.3 Higher Order Equations

The constant coefficient equation of order  $n$  has the form

$$L[y] = y^{(n)} + a_{n-1}y^{(n-1)} + \cdots + a_1y' + a_0y = 0. \quad (17.3)$$

The substitution  $y = e^{\lambda x}$  will transform this differential equation into an algebraic equation.

$$\begin{aligned} L[e^{\lambda x}] &= \lambda^n e^{\lambda x} + a_{n-1} \lambda^{n-1} e^{\lambda x} + \cdots + a_1 \lambda e^{\lambda x} + a_0 e^{\lambda x} = 0 \\ (\lambda^n + a_{n-1} \lambda^{n-1} + \cdots + a_1 \lambda + a_0) e^{\lambda x} &= 0 \\ \lambda^n + a_{n-1} \lambda^{n-1} + \cdots + a_1 \lambda + a_0 &= 0 \end{aligned}$$

Assume that the roots of this equation,  $\lambda_1, \dots, \lambda_n$ , are distinct. Then the  $n$  linearly independent solutions of Equation 17.3 are

$$e^{\lambda_1 x}, \dots, e^{\lambda_n x}.$$

If the roots of the algebraic equation are not distinct then we will not obtain all the solutions of the differential equation. Suppose that  $\lambda_1 = \alpha$  is a double root. We substitute  $y = e^{\lambda x}$  into the differential equation.

$$L[e^{\lambda x}] = [(\lambda - \alpha)^2(\lambda - \lambda_3) \cdots (\lambda - \lambda_n)] e^{\lambda x} = 0$$

Setting  $\lambda = \alpha$  will make the left side of the equation zero. Thus  $y = e^{\alpha x}$  is a solution. Now we differentiate both sides of the equation with respect to  $\lambda$  and interchange the order of differentiation.

$$\frac{d}{d\lambda} L[e^{\lambda x}] = L \left[ \frac{d}{d\lambda} e^{\lambda x} \right] = L [x e^{\lambda x}]$$

Let  $p(\lambda) = (\lambda - \lambda_3) \cdots (\lambda - \lambda_n)$ . We calculate  $L [x e^{\lambda x}]$  by applying  $L$  and then differentiating with respect to  $\lambda$ .

$$\begin{aligned} L [x e^{\lambda x}] &= \frac{d}{d\lambda} L[e^{\lambda x}] \\ &= \frac{d}{d\lambda} [(\lambda - \alpha)^2(\lambda - \lambda_3) \cdots (\lambda - \lambda_n)] e^{\lambda x} \\ &= \frac{d}{d\lambda} [(\lambda - \alpha)^2 p(\lambda)] e^{\lambda x} \\ &= [2(\lambda - \alpha)p(\lambda) + (\lambda - \alpha)^2 p'(\lambda) + (\lambda - \alpha)^2 p(\lambda)x] e^{\lambda x} \\ &= (\lambda - \alpha) [2p(\lambda) + (\lambda - \alpha)p'(\lambda) + (\lambda - \alpha)p(\lambda)x] e^{\lambda x} \end{aligned}$$

Since setting  $\lambda = \alpha$  will make this expression zero,  $L[x e^{\alpha x}] = 0$ ,  $x e^{\alpha x}$  is a solution of Equation 17.3. You can verify that  $e^{\alpha x}$  and  $x e^{\alpha x}$  are linearly independent. Now we have generated all of the solutions for the differential equation.

If  $\lambda = \alpha$  is a root of multiplicity  $m$  then by repeatedly differentiating with respect to  $\lambda$  you can show that the corresponding solutions are

$$e^{\alpha x}, x e^{\alpha x}, x^2 e^{\alpha x}, \dots, x^{m-1} e^{\alpha x}.$$

**Example 17.1.7** Consider the equation

$$y''' - 3y' + 2y = 0.$$

The substitution  $y = e^{\lambda x}$  yields

$$\lambda^3 - 3\lambda + 2 = (\lambda - 1)^2(\lambda + 2) = 0.$$

Thus the general solution is

$$y = c_1 e^x + c_2 x e^x + c_3 e^{-2x}.$$

**Result 17.1.3** Consider the  $n^{\text{th}}$  order constant coefficient equation

$$\frac{d^n y}{dx^n} + a_{n-1} \frac{d^{n-1} y}{dx^{n-1}} + \dots + a_1 \frac{dy}{dx} + a_0 y = 0.$$

Let the factorization of the algebraic equation obtained with the substitution  $y = e^{\lambda x}$  be

$$(\lambda - \lambda_1)^{m_1} (\lambda - \lambda_2)^{m_2} \dots (\lambda - \lambda_p)^{m_p} = 0.$$

A set of linearly independent solutions is given by

$$\{e^{\lambda_1 x}, x e^{\lambda_1 x}, \dots, x^{m_1-1} e^{\lambda_1 x}, \dots, e^{\lambda_p x}, x e^{\lambda_p x}, \dots, x^{m_p-1} e^{\lambda_p x}\}.$$

If the coefficients of the differential equation are real, then we can find a real-valued set of solutions.

**Example 17.1.8** Consider the equation

$$\frac{d^4 y}{dx^4} + 2\frac{d^2 y}{dx^2} + y = 0.$$

The substitution  $y = e^{\lambda x}$  yields

$$\lambda^4 + 2\lambda^2 + 1 = (\lambda - i)^2(\lambda + i)^2 = 0.$$

Thus the linearly independent solutions are

$$e^{ix}, x e^{ix}, e^{-ix} \text{ and } x e^{-ix}.$$

Noting that

$$e^{ix} = \cos(x) + i \sin(x),$$

we can write the general solution in terms of sines and cosines.

$$y = c_1 \cos x + c_2 \sin x + c_3 x \cos x + c_4 x \sin x$$

## 17.2 Euler Equations

Consider the equation

$$L[y] = x^2 \frac{d^2 y}{dx^2} + ax \frac{dy}{dx} + by = 0, \quad x > 0.$$

Let's say, for example, that  $y$  has units of distance and  $x$  has units of time. Note that each term in the differential equation has the same dimension.

$$(\text{time})^2 \frac{(\text{distance})}{(\text{time})^2} = (\text{time}) \frac{(\text{distance})}{(\text{time})} = (\text{distance})$$

Thus this is a second order Euler, or equidimensional equation. We know that the first order Euler equation,  $xy' + ay = 0$ , has the solution  $y = cx^a$ . Thus for the second order equation we will try a solution of the form  $y = x^\lambda$ . The substitution

$y = x^\lambda$  will transform the differential equation into an algebraic equation.

$$\begin{aligned}L[x^\lambda] &= x^2 \frac{d^2}{dx^2}[x^\lambda] + ax \frac{d}{dx}[x^\lambda] + bx^\lambda = 0 \\ \lambda(\lambda - 1)x^\lambda + a\lambda x^\lambda + bx^\lambda &= 0 \\ \lambda(\lambda - 1) + a\lambda + b &= 0\end{aligned}$$

Factoring yields

$$(\lambda - \lambda_1)(\lambda - \lambda_2) = 0.$$

If the two roots,  $\lambda_1$  and  $\lambda_2$ , are distinct then the general solution is

$$y = c_1 x^{\lambda_1} + c_2 x^{\lambda_2}.$$

If the roots are not distinct,  $\lambda_1 = \lambda_2 = \lambda$ , then we only have the one solution,  $y = x^\lambda$ . To generate the other solution we use the same approach as for the constant coefficient equation. We substitute  $y = x^\lambda$  into the differential equation and differentiate with respect to  $\lambda$ .

$$\begin{aligned}\frac{d}{d\lambda}L[x^\lambda] &= L\left[\frac{d}{d\lambda}x^\lambda\right] \\ &= L[\ln x \ x^\lambda]\end{aligned}$$

Note that

$$\frac{d}{d\lambda}x^\lambda = \frac{d}{d\lambda}e^{\lambda \ln x} = \ln x \ e^{\lambda \ln x} = \ln x \ x^\lambda.$$

Now we apply  $L$  and then differentiate with respect to  $\lambda$ .

$$\begin{aligned}\frac{d}{d\lambda}L[x^\lambda] &= \frac{d}{d\lambda}(\lambda - \alpha)^2 x^\lambda \\ &= 2(\lambda - \alpha)x^\lambda + (\lambda - \alpha)^2 \ln x \ x^\lambda\end{aligned}$$

Equating these two results,

$$L[\ln x x^\lambda] = 2(\lambda - \alpha)x^\lambda + (\lambda - \alpha)^2 \ln x x^\lambda.$$

Setting  $\lambda = \alpha$  will make the right hand side zero. Thus  $y = \ln x x^\alpha$  is a solution.

If you are in the mood for a little algebra you can show by repeatedly differentiating with respect to  $\lambda$  that if  $\lambda = \alpha$  is a root of multiplicity  $m$  in an  $n^{\text{th}}$  order Euler equation then the associated solutions are

$$x^\alpha, \ln x x^\alpha, (\ln x)^2 x^\alpha, \dots, (\ln x)^{m-1} x^\alpha.$$

**Example 17.2.1** Consider the Euler equation

$$xy'' - y' + \frac{y}{x} = 0.$$

The substitution  $y = x^\lambda$  yields the algebraic equation

$$\lambda(\lambda - 1) - \lambda + 1 = (\lambda - 1)^2 = 0.$$

Thus the general solution is

$$y = c_1 x + c_2 x \ln x.$$

## 17.2.1 Real-Valued Solutions

If the coefficients of the Euler equation are real, then the solution can be written in terms of functions that are real-valued when  $x$  is real and positive, (Result 16.2.2). If  $\alpha \pm i\beta$  are the roots of

$$\lambda(\lambda - 1) + a\lambda + b = 0$$

then the corresponding solutions of the Euler equation are

$$x^{\alpha+i\beta} \quad \text{and} \quad x^{\alpha-i\beta}.$$

We can rewrite these as

$$x^\alpha e^{i\beta \ln x} \quad \text{and} \quad x^\alpha e^{-i\beta \ln x}.$$

Note that the linear combinations

$$\frac{x^\alpha e^{i\beta \ln x} + x^\alpha e^{-i\beta \ln x}}{2} = x^\alpha \cos(\beta \ln x), \quad \text{and} \quad \frac{x^\alpha e^{i\beta \ln x} - x^\alpha e^{-i\beta \ln x}}{i2} = x^\alpha \sin(\beta \ln x),$$

are real-valued solutions when  $x$  is real and positive. Equivalently, we could take the real and imaginary parts of either  $x^{\alpha+i\beta}$  or  $x^{\alpha-i\beta}$ .

$$\Re(x^\alpha e^{i\beta \ln x}) = x^\alpha \cos(\beta \ln x), \quad \Im(x^\alpha e^{i\beta \ln x}) = x^\alpha \sin(\beta \ln x)$$

**Result 17.2.1** Consider the second order Euler equation

$$x^2 y'' + (2a + 1)xy' + by = 0.$$

The general solution of this differential equation is

$$y = \begin{cases} x^{-a} (c_1 x^{\sqrt{a^2-b}} + c_2 x^{-\sqrt{a^2-b}}) & \text{if } a^2 > b, \\ x^{-a} (c_1 \cos(\sqrt{b-a^2} \ln x) + c_2 \sin(\sqrt{b-a^2} \ln x)) & \text{if } a^2 < b, \\ x^{-a} (c_1 + c_2 \ln x) & \text{if } a^2 = b. \end{cases}$$

The **fundamental set of solutions** at  $x = \xi$  is

$$y = \begin{cases} \left\{ \left( \frac{x}{\xi} \right)^{-a} \left( \cosh\left(\sqrt{a^2-b} \ln \frac{x}{\xi}\right) + \frac{a}{\sqrt{a^2-b}} \sinh\left(\sqrt{a^2-b} \ln \frac{x}{\xi}\right) \right), \right. \\ \left. \left( \frac{x}{\xi} \right)^{-a} \frac{\xi}{\sqrt{a^2-b}} \sinh\left(\sqrt{a^2-b} \ln \frac{x}{\xi}\right) \right\} & \text{if } a^2 > b, \\ \left\{ \left( \frac{x}{\xi} \right)^{-a} \left( \cos\left(\sqrt{b-a^2} \ln \frac{x}{\xi}\right) + \frac{a}{\sqrt{b-a^2}} \sin\left(\sqrt{b-a^2} \ln \frac{x}{\xi}\right) \right), \right. \\ \left. \left( \frac{x}{\xi} \right)^{-a} \frac{\xi}{\sqrt{b-a^2}} \sin\left(\sqrt{b-a^2} \ln \frac{x}{\xi}\right) \right\} & \text{if } a^2 < b, \\ \left\{ \left( \frac{x}{\xi} \right)^{-a} \left( 1 + a \ln \frac{x}{\xi} \right), \left( \frac{x}{\xi} \right)^{-a} \xi \ln \frac{x}{\xi} \right\} & \text{if } a^2 = b. \end{cases}$$

**Example 17.2.2** Consider the Euler equation

$$x^2 y'' - 3xy' + 13y = 0.$$

The substitution  $y = x^\lambda$  yields

$$\lambda(\lambda - 1) - 3\lambda + 13 = (\lambda - 2 - i3)(\lambda - 2 + i3) = 0.$$

The linearly independent solutions are

$$\{x^{2+i3}, x^{2-i3}\}.$$

We can put this in a more understandable form.

$$x^{2+i3} = x^2 e^{i3 \ln x} = x^2 \cos(3 \ln x) + i x^2 \sin(3 \ln x)$$

We can write the general solution in terms of real-valued functions.

$$y = c_1 x^2 \cos(3 \ln x) + c_2 x^2 \sin(3 \ln x)$$

**Result 17.2.2** Consider the  $n^{\text{th}}$  order Euler equation

$$x^n \frac{d^n y}{dx^n} + a_{n-1} x^{n-1} \frac{d^{n-1} y}{dx^{n-1}} + \cdots + a_1 x \frac{dy}{dx} + a_0 y = 0.$$

Let the factorization of the algebraic equation obtained with the substitution  $y = x^\lambda$  be

$$(\lambda - \lambda_1)^{m_1} (\lambda - \lambda_2)^{m_2} \cdots (\lambda - \lambda_p)^{m_p} = 0.$$

A set of linearly independent solutions is given by

$$\{x^{\lambda_1}, \ln x x^{\lambda_1}, \dots, (\ln x)^{m_1-1} x^{\lambda_1}, \dots, x^{\lambda_p}, \ln x x^{\lambda_p}, \dots, (\ln x)^{m_p-1} x^{\lambda_p}\}.$$

If the coefficients of the differential equation are real, then we can find a set of solutions that are real valued when  $x$  is real and positive.



## 17.3 Exact Equations

Exact equations have the form

$$\frac{d}{dx}F(x, y, y', y'', \dots) = f(x).$$

If you can write an equation in the form of an exact equation, you can integrate to reduce the order by one, (or solve the equation for first order). We will consider a few examples to illustrate the method.

**Example 17.3.1** Consider the equation

$$y'' + x^2y' + 2xy = 0.$$

We can rewrite this as

$$\frac{d}{dx}[y' + x^2y] = 0.$$

Integrating yields a first order inhomogeneous equation.

$$y' + x^2y = c_1$$

We multiply by the integrating factor  $I(x) = \exp(\int x^2 dx)$  to make this an exact equation.

$$\begin{aligned}\frac{d}{dx} \left( e^{x^3/3} y \right) &= c_1 e^{x^3/3} \\ e^{x^3/3} y &= c_1 \int e^{x^3/3} dx + c_2\end{aligned}$$

$$y = c_1 e^{-x^3/3} \int e^{x^3/3} dx + c_2 e^{-x^3/3}$$

**Result 17.3.1** If you can write a differential equation in the form

$$\frac{d}{dx}F(x, y, y', y'', \dots) = f(x),$$

then you can integrate to reduce the order of the equation.

$$F(x, y, y', y'', \dots) = \int f(x) dx + c$$

## 17.4 Equations Without Explicit Dependence on $y$

**Example 17.4.1** Consider the equation

$$y'' + \sqrt{x}y' = 0.$$

This is a second order equation for  $y$ , but note that it is a first order equation for  $y'$ . We can solve directly for  $y'$ .

$$\begin{aligned}\frac{d}{dx} \left( \exp \left( \frac{2}{3}x^{3/2} \right) y' \right) &= 0 \\ y' &= c_1 \exp \left( -\frac{2}{3}x^{3/2} \right)\end{aligned}$$

Now we just integrate to get the solution for  $y$ .

$$y = c_1 \int \exp \left( -\frac{2}{3}x^{3/2} \right) dx + c_2$$

**Result 17.4.1** If an  $n^{\text{th}}$  order equation does not explicitly depend on  $y$  then you can consider it as an equation of order  $n - 1$  for  $y'$ .

## 17.5 Reduction of Order

Consider the second order linear equation

$$L[y] \equiv y'' + p(x)y' + q(x)y = f(x).$$

Suppose that we know one homogeneous solution  $y_1$ . We make the substitution  $y = uy_1$  and use that  $L[y_1] = 0$ .

$$\begin{aligned}L[uy_1] &= 0u''y_1 + 2u'y_1' + uy_1'' + p(u'y_1 + uy_1') + quy_1 = 0 \\u''y_1 + u'(2y_1' + py_1) + u(y_1'' + py_1' + qy_1) &= 0 \\u''y_1 + u'(2y_1' + py_1) &= 0\end{aligned}$$

Thus we have reduced the problem to a first order equation for  $u'$ . An analogous result holds for higher order equations.

**Result 17.5.1** Consider the  $n^{\text{th}}$  order linear differential equation

$$y^{(n)} + p_{n-1}(x)y^{(n-1)} + \cdots + p_1(x)y' + p_0(x)y = f(x).$$

Let  $y_1$  be a solution of the homogeneous equation. The substitution  $y = uy_1$  will transform the problem into an  $(n - 1)^{\text{th}}$  order equation for  $u'$ . For the second order problem

$$y'' + p(x)y' + q(x)y = f(x)$$

this reduced equation is

$$u''y_1 + u'(2y_1' + py_1) = f(x).$$

**Example 17.5.1** Consider the equation

$$y'' + xy' - y = 0.$$

By inspection we see that  $y_1 = x$  is a solution. We would like to find another linearly independent solution. The substitution  $y = xu$  yields

$$xu'' + (2 + x^2)u' = 0$$

$$u'' + \left(\frac{2}{x} + x\right)u' = 0$$

The integrating factor is  $I(x) = \exp(2 \ln x + x^2/2) = x^2 \exp(x^2/2)$ .

$$\frac{d}{dx} \left( x^2 e^{x^2/2} u' \right) = 0$$

$$u' = c_1 x^{-2} e^{-x^2/2}$$

$$u = c_1 \int x^{-2} e^{-x^2/2} dx + c_2$$

$$y = c_1 x \int x^{-2} e^{-x^2/2} dx + c_2 x$$

Thus we see that a second solution is

$$y_2 = x \int x^{-2} e^{-x^2/2} dx.$$

## 17.6 \*Reduction of Order and the Adjoint Equation

Let  $L$  be the linear differential operator

$$L[y] = p_n \frac{d^n y}{dx^n} + p_{n-1} \frac{d^{n-1} y}{dx^{n-1}} + \cdots + p_0 y,$$

where each  $p_j$  is a  $j$  times continuously differentiable complex valued function. Recall that the adjoint of  $L$  is

$$L^*[y] = (-1)^n \frac{d^n}{dx^n} (\overline{p_n} y) + (-1)^{n-1} \frac{d^{n-1}}{dx^{n-1}} (\overline{p_{n-1}} y) + \cdots + \overline{p_0} y.$$

If  $u$  and  $v$  are  $n$  times continuously differentiable, then Lagrange's identity states

$$\bar{v}L[u] - u\overline{L^*[v]} = \frac{d}{dx}B[u, v],$$

where

$$B[u, v] = \sum_{m=1}^n \sum_{\substack{j+k=m-1 \\ j \geq 0, k \geq 0}} (-1)^j u^{(k)} (p_m \bar{v})^{(j)}.$$

For second order equations,

$$B[u, v] = up_1\bar{v} + u'p_2\bar{v} - u(p_2\bar{v})'.$$

(See Section 16.7.)

If we can find a solution to the homogeneous adjoint equation,  $L^*[y] = 0$ , then we can reduce the order of the equation  $L[y] = f(x)$ . Let  $\psi$  satisfy  $L^*[\psi] = 0$ . Substituting  $u = y$ ,  $v = \psi$  into Lagrange's identity yields

$$\begin{aligned} \bar{\psi}L[y] - y\overline{L^*[\psi]} &= \frac{d}{dx}B[y, \psi] \\ \bar{\psi}L[y] &= \frac{d}{dx}B[y, \psi]. \end{aligned}$$

The equation  $L[y] = f(x)$  is equivalent to the equation

$$\begin{aligned} \frac{d}{dx}B[y, \psi] &= \bar{\psi}f \\ B[y, \psi] &= \int \overline{\psi(x)}f(x) dx, \end{aligned}$$

which is a linear equation in  $y$  of order  $n - 1$ .

**Example 17.6.1** Consider the equation

$$L[y] = y'' - x^2y' - 2xy = 0.$$

**Method 1.** *Note that this is an exact equation.*

$$\frac{d}{dx}(y' - x^2y) = 0$$

$$y' - x^2y = c_1$$

$$\frac{d}{dx} \left( e^{-x^3/3} y \right) = c_1 e^{-x^3/3}$$

$$y = c_1 e^{x^3/3} \int e^{-x^3/3} dx + c_2 e^{x^3/3}$$

**Method 2.** *The adjoint equation is*

$$L^*[y] = y'' + x^2y' = 0.$$

*By inspection we see that  $\psi = (\text{constant})$  is a solution of the adjoint equation. To simplify the algebra we will choose  $\psi = 1$ . Thus the equation  $L[y] = 0$  is equivalent to*

$$B[y, 1] = c_1$$

$$y(-x^2) + \frac{d}{dx}[y](1) - y \frac{d}{dx}[1] = c_1$$

$$y' - x^2y = c_1.$$

*By using the adjoint equation to reduce the order we obtain the same solution as with Method 1.*

## 17.7 Additional Exercises

### Constant Coefficient Equations

#### Exercise 17.3 (mathematica/ode/techniques\_linear/constant.nb)

Find the solution of each one of the following initial value problems. Sketch the graph of the solution and describe its behavior as  $t$  increases.

1.  $6y'' - 5y' + y = 0$ ,  $y(0) = 4$ ,  $y'(0) = 0$
2.  $y'' - 2y' + 5y = 0$ ,  $y(\pi/2) = 0$ ,  $y'(\pi/2) = 2$
3.  $y'' + 4y' + 4y = 0$ ,  $y(-1) = 2$ ,  $y'(-1) = 1$

Hint, Solution

#### Exercise 17.4 (mathematica/ode/techniques\_linear/constant.nb)

Substitute  $y = e^{\lambda x}$  to find two linearly independent solutions to

$$y'' - 4y' + 13y = 0.$$

that are real-valued when  $x$  is real-valued.

Hint, Solution

#### Exercise 17.5 (mathematica/ode/techniques\_linear/constant.nb)

Find the general solution to

$$y''' - y'' + y' - y = 0.$$

Write the solution in terms of functions that are real-valued when  $x$  is real-valued.

Hint, Solution

#### Exercise 17.6

Substitute  $y = e^{\lambda x}$  to find the **fundamental set of solutions** at  $x = 0$  for each of the equations:

1.  $y'' + y = 0$ ,

$$2. y'' - y = 0,$$

$$3. y'' = 0.$$

What are the **fundamental set of solutions** at  $x = 1$  for each of these equations.

**Hint, Solution**

### Exercise 17.7

Consider a ball of mass  $m$  hanging by an ideal spring of spring constant  $k$ . The ball is suspended in a fluid which damps the motion. This resistance has a coefficient of friction,  $\mu$ . Find the differential equation for the displacement of the mass from its equilibrium position by balancing forces. Denote this displacement by  $y(t)$ . If the damping force is weak, the mass will have a decaying, oscillatory motion. If the damping force is strong, the mass will not oscillate. The displacement will decay to zero. The value of the damping which separates these two behaviors is called critical damping.

Find the solution which satisfies the initial conditions  $y(0) = 0$ ,  $y'(0) = 1$ . Use the solutions obtained in Exercise 17.2 or refer to Result 17.1.2.

Consider the case  $m = k = 1$ . Find the coefficient of friction for which the displacement of the mass decays most rapidly. Plot the displacement for strong, weak and critical damping.

**Hint, Solution**

### Exercise 17.8

Show that  $y = c \cos(x - \phi)$  is the general solution of  $y'' + y = 0$  where  $c$  and  $\phi$  are constants of integration. (It is not sufficient to show that  $y = c \cos(x - \phi)$  satisfies the differential equation.  $y = 0$  satisfies the differential equation, but is certainly not the general solution.) Find constants  $c$  and  $\phi$  such that  $y = \sin(x)$ .

Is  $y = c \cosh(x - \phi)$  the general solution of  $y'' - y = 0$ ? Are there constants  $c$  and  $\phi$  such that  $y = \sinh(x)$ ?

**Hint, Solution**

### Exercise 17.9 (mathematica/ode/techniques.linear/constant.nb)

Let  $y(t)$  be the solution of the initial-value problem

$$y'' + 5y' + 6y = 0; \quad y(0) = 1, \quad y'(0) = V.$$

For what values of  $V$  does  $y(t)$  remain nonnegative for all  $t > 0$ ?



Hint, Solution

**Exercise 17.10 (mathematica/ode/techniques\_linear/constant.nb)**

Find two linearly independent solutions of

$$y'' + \text{sign}(x)y = 0, \quad -\infty < x < \infty.$$

where  $\text{sign}(x) = \pm 1$  according as  $x$  is positive or negative. (The solution should be continuous and have a continuous first derivative.)

Hint, Solution

## Euler Equations

**Exercise 17.11**

Find the general solution of

$$x^2y'' + xy' + y = 0, \quad x > 0.$$

Hint, Solution

**Exercise 17.12**

Substitute  $y = x^\lambda$  to find the general solution of

$$x^2y'' - 2xy' + 2y = 0.$$

Hint, Solution

**Exercise 17.13 (mathematica/ode/techniques\_linear/constant.nb)**

Substitute  $y = x^\lambda$  to find the general solution of

$$xy''' + y'' + \frac{1}{x}y' = 0.$$

Write the solution in terms of functions that are real-valued when  $x$  is real-valued and positive.

Hint, Solution

**Exercise 17.14**

Find the general solution of

$$x^2y'' + (2a + 1)xy' + by = 0.$$

**Hint, Solution**

**Exercise 17.15**

Show that

$$y_1 = e^{ax}, \quad y_2 = \lim_{\alpha \rightarrow a} \frac{e^{\alpha x} - e^{-\alpha x}}{\alpha}$$

are linearly independent solutions of

$$y'' - a^2y = 0$$

for all values of  $a$ . It is common to abuse notation and write the second solution as

$$y_2 = \frac{e^{ax} - e^{-ax}}{a}$$

where the limit is taken if  $a = 0$ . Likewise show that

$$y_1 = x^a, \quad y_2 = \frac{x^a - x^{-a}}{a}$$

are linearly independent solutions of

$$x^2y'' + xy' - a^2y = 0$$

for all values of  $a$ .

**Hint, Solution**

**Exercise 17.16 (mathematica/ode/techniques\_linear/constant.nb)**

Find two linearly independent solutions (i.e., the general solution) of

$$(a) \ x^2y'' - 2xy' + 2y = 0, \quad (b) \ x^2y'' - 2y = 0, \quad (c) \ x^2y'' - xy' + y = 0.$$

**Hint, Solution**

## Exact Equations

### Exercise 17.17

Solve the differential equation

$$y'' + y' \sin x + y \cos x = 0.$$

Hint, Solution

## Equations Without Explicit Dependence on $y$ Reduction of Order

### Exercise 17.18

Consider

$$(1 - x^2)y'' - 2xy' + 2y = 0, \quad -1 < x < 1.$$

Verify that  $y = x$  is a solution. Find the general solution.

Hint, Solution

### Exercise 17.19

Consider the differential equation

$$y'' - \frac{x+1}{x}y' + \frac{1}{x}y = 0.$$

Since the coefficients sum to zero,  $(1 - \frac{x+1}{x} + \frac{1}{x} = 0)$ ,  $y = e^x$  is a solution. Find another linearly independent solution.

Hint, Solution

### Exercise 17.20

One solution of

$$(1 - 2x)y'' + 4xy' - 4y = 0$$

is  $y = x$ . Find the general solution.

Hint, Solution

**Exercise 17.21**

Find the general solution of

$$(x - 1)y'' - xy' + y = 0,$$

given that one solution is  $y = e^x$ . (you may assume  $x > 1$ )

**Hint, Solution**

**\*Reduction of Order and the Adjoint Equation**

## 17.8 Hints

### Hint 17.1

Substitute  $y = e^{\lambda x}$  into the differential equation.

### Hint 17.2

The **fundamental set of solutions** is a linear combination of the homogeneous solutions.

## Constant Coefficient Equations

### Hint 17.3

### Hint 17.4

### Hint 17.5

It is a constant coefficient equation.

### Hint 17.6

Use the fact that if  $u(x)$  is a solution of a constant coefficient equation, then  $u(x + c)$  is also a solution.

### Hint 17.7

The force on the mass due to the spring is  $-ky(t)$ . The frictional force is  $-\mu y'(t)$ .

Note that the initial conditions describe the second **fundamental solution** at  $t = 0$ .

Note that for large  $t$ ,  $t e^{\alpha t}$  is much smaller than  $e^{\beta t}$  if  $\alpha < \beta$ . (Prove this.)

### Hint 17.8

By definition, the general solution of a second order differential equation is a two parameter family of functions that satisfies the differential equation. The trigonometric identities in Appendix **M** may be useful.

**Hint 17.9**

**Hint 17.10**

## **Euler Equations**

**Hint 17.11**

**Hint 17.12**

**Hint 17.13**

**Hint 17.14**

Substitute  $y = x^\lambda$  into the differential equation. Consider the three cases:  $a^2 > b$ ,  $a^2 < b$  and  $a^2 = b$ .

**Hint 17.15**

**Hint 17.16**

## **Exact Equations**

**Hint 17.17**

It is an exact equation.

## **Equations Without Explicit Dependence on $y$**

## Reduction of Order

**Hint 17.18**

**Hint 17.19**

Use reduction of order to find the other solution.

**Hint 17.20**

Use reduction of order to find the other solution.

**Hint 17.21**

**\*Reduction of Order and the Adjoint Equation**

## 17.9 Solutions

### Solution 17.1

We substitute  $y = e^{\lambda x}$  into the differential equation.

$$y'' + 2ay' + by = 0$$

$$\lambda^2 + 2a\lambda + b = 0$$

$$\lambda = -a \pm \sqrt{a^2 - b}$$

If  $a^2 > b$  then the two roots are distinct and real. The general solution is

$$y = c_1 e^{(-a + \sqrt{a^2 - b})x} + c_2 e^{(-a - \sqrt{a^2 - b})x}.$$

If  $a^2 < b$  then the two roots are distinct and complex-valued. We can write them as

$$\lambda = -a \pm i\sqrt{b - a^2}.$$

The general solution is

$$y = c_1 e^{(-a + i\sqrt{b - a^2})x} + c_2 e^{(-a - i\sqrt{b - a^2})x}.$$

By taking the sum and difference of the two linearly independent solutions above, we can write the general solution as

$$y = c_1 e^{-ax} \cos(\sqrt{b - a^2} x) + c_2 e^{-ax} \sin(\sqrt{b - a^2} x).$$

If  $a^2 = b$  then the only root is  $\lambda = -a$ . The general solution in this case is then

$$y = c_1 e^{-ax} + c_2 x e^{-ax}.$$

In summary, the general solution is

$y = \begin{cases} e^{-ax} (c_1 e^{\sqrt{a^2 - b}x} + c_2 e^{-\sqrt{a^2 - b}x}) & \text{if } a^2 > b, \\ e^{-ax} (c_1 \cos(\sqrt{b - a^2} x) + c_2 \sin(\sqrt{b - a^2} x)) & \text{if } a^2 < b, \\ e^{-ax} (c_1 + c_2 x) & \text{if } a^2 = b. \end{cases}$
--



## Solution 17.2

First we note that the general solution can be written,

$$y = \begin{cases} e^{-ax} (c_1 \cosh(\sqrt{a^2 - b} x) + c_2 \sinh(\sqrt{a^2 - b} x)) & \text{if } a^2 > b, \\ e^{-ax} (c_1 \cos(\sqrt{b - a^2} x) + c_2 \sin(\sqrt{b - a^2} x)) & \text{if } a^2 < b, \\ e^{-ax} (c_1 + c_2 x) & \text{if } a^2 = b. \end{cases}$$

We first consider the case  $a^2 > b$ . The derivative is

$$y' = e^{-ax} \left( (-ac_1 + \sqrt{a^2 - b} c_2) \cosh(\sqrt{a^2 - b} x) + (-ac_2 + \sqrt{a^2 - b} c_1) \sinh(\sqrt{a^2 - b} x) \right).$$

The conditions,  $y_1(0) = 1$  and  $y_1'(0) = 0$ , for the first solution become,

$$\begin{aligned} c_1 &= 1, & -ac_1 + \sqrt{a^2 - b} c_2 &= 0, \\ c_1 &= 1, & c_2 &= \frac{a}{\sqrt{a^2 - b}}. \end{aligned}$$

The conditions,  $y_2(0) = 0$  and  $y_2'(0) = 1$ , for the second solution become,

$$\begin{aligned} c_1 &= 0, & -ac_1 + \sqrt{a^2 - b} c_2 &= 1, \\ c_1 &= 0, & c_2 &= \frac{1}{\sqrt{a^2 - b}}. \end{aligned}$$

The **fundamental set of solutions** is

$$\left\{ e^{-ax} \left( \cosh(\sqrt{a^2 - b} x) + \frac{a}{\sqrt{a^2 - b}} \sinh(\sqrt{a^2 - b} x) \right), e^{-ax} \frac{1}{\sqrt{a^2 - b}} \sinh(\sqrt{a^2 - b} x) \right\}.$$

Now consider the case  $a^2 < b$ . The derivative is

$$y' = e^{-ax} \left( (-ac_1 + \sqrt{b - a^2} c_2) \cos(\sqrt{b - a^2} x) + (-ac_2 - \sqrt{b - a^2} c_1) \sin(\sqrt{b - a^2} x) \right).$$

Clearly, the **fundamental set of solutions** is

$$\left\{ e^{-ax} \left( \cos(\sqrt{b-a^2}x) + \frac{a}{\sqrt{b-a^2}} \sin(\sqrt{b-a^2}x) \right), e^{-ax} \frac{1}{\sqrt{b-a^2}} \sin(\sqrt{b-a^2}x) \right\}.$$

Finally we consider the case  $a^2 = b$ . The derivative is

$$y' = e^{-ax}(-ac_1 + c_2 + -ac_2x).$$

The conditions,  $y_1(0) = 1$  and  $y_1'(0) = 0$ , for the first solution become,

$$\begin{aligned} c_1 &= 1, & -ac_1 + c_2 &= 0, \\ c_1 &= 1, & c_2 &= a. \end{aligned}$$

The conditions,  $y_2(0) = 0$  and  $y_2'(0) = 1$ , for the second solution become,

$$\begin{aligned} c_1 &= 0, & -ac_1 + c_2 &= 1, \\ c_1 &= 0, & c_2 &= 1. \end{aligned}$$

The **fundamental set of solutions** is

$$\{(1 + ax)e^{-ax}, xe^{-ax}\}.$$

In summary, the **fundamental set of solutions** at  $x = 0$  is

$\left\{ \begin{aligned} & \left\{ e^{-ax} \left( \cosh(\sqrt{a^2-b}x) + \frac{a}{\sqrt{a^2-b}} \sinh(\sqrt{a^2-b}x) \right), e^{-ax} \frac{1}{\sqrt{a^2-b}} \sinh(\sqrt{a^2-b}x) \right\} \\ & \left\{ e^{-ax} \left( \cos(\sqrt{b-a^2}x) + \frac{a}{\sqrt{b-a^2}} \sin(\sqrt{b-a^2}x) \right), e^{-ax} \frac{1}{\sqrt{b-a^2}} \sin(\sqrt{b-a^2}x) \right\} \\ & \{(1 + ax)e^{-ax}, xe^{-ax}\} \end{aligned} \right.$	$\begin{aligned} & \text{if } a^2 > b, \\ & \text{if } a^2 < b, \\ & \text{if } a^2 = b. \end{aligned}$
--	---

## Constant Coefficient Equations

### Solution 17.3

1. We consider the problem

$$6y'' - 5y' + y = 0, \quad y(0) = 4, \quad y'(0) = 0.$$

We make the substitution  $y = e^{\lambda x}$  in the differential equation.

$$\begin{aligned} 6\lambda^2 - 5\lambda + 1 &= 0 \\ (2\lambda - 1)(3\lambda - 1) &= 0 \\ \lambda &= \left\{ \frac{1}{3}, \frac{1}{2} \right\} \end{aligned}$$

The general solution of the differential equation is

$$y = c_1 e^{t/3} + c_2 e^{t/2}.$$

We apply the initial conditions to determine the constants.

$$\begin{aligned} c_1 + c_2 &= 4, & \frac{c_1}{3} + \frac{c_2}{2} &= 0 \\ c_1 &= 12, & c_2 &= -8 \end{aligned}$$

The solution subject to the initial conditions is

$$\boxed{y = 12e^{t/3} - 8e^{t/2}.$$

The solution is plotted in Figure 17.1. The solution tends to  $-\infty$  as  $t \rightarrow \infty$ .

2. We consider the problem

$$y'' - 2y' + 5y = 0, \quad y(\pi/2) = 0, \quad y'(\pi/2) = 2.$$

We make the substitution  $y = e^{\lambda x}$  in the differential equation.

$$\begin{aligned} \lambda^2 - 2\lambda + 5 &= 0 \\ \lambda &= 1 \pm \sqrt{1 - 5} \\ \lambda &= \{1 + i2, 1 - i2\} \end{aligned}$$

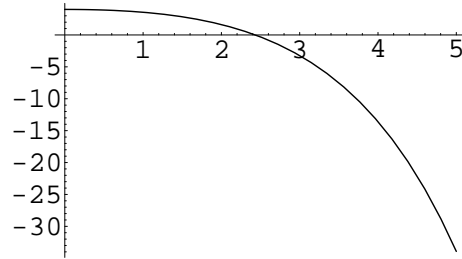

Figure 17.1: The solution of  $6y'' - 5y' + y = 0$ ,  $y(0) = 4$ ,  $y'(0) = 0$ .

The general solution of the differential equation is

$$y = c_1 e^t \cos(2t) + c_2 e^t \sin(2t).$$

We apply the initial conditions to determine the constants.

$$\begin{aligned} y(\pi/2) = 0 &\Rightarrow -c_1 e^{\pi/2} = 0 \Rightarrow c_1 = 0 \\ y'(\pi/2) = 2 &\Rightarrow -2c_2 e^{\pi/2} = 2 \Rightarrow c_2 = -e^{-\pi/2} \end{aligned}$$

The solution subject to the initial conditions is

$$y = -e^{t-\pi/2} \sin(2t).$$

The solution is plotted in Figure 17.2. The solution oscillates with an amplitude that tends to  $\infty$  as  $t \rightarrow \infty$ .

3. We consider the problem

$$y'' + 4y' + 4y = 0, \quad y(-1) = 2, \quad y'(-1) = 1.$$

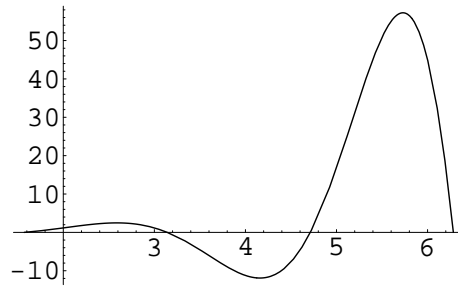

Figure 17.2: The solution of  $y'' - 2y' + 5y = 0$ ,  $y(\pi/2) = 0$ ,  $y'(\pi/2) = 2$ .

We make the substitution  $y = e^{\lambda x}$  in the differential equation.

$$\begin{aligned}\lambda^2 + 4\lambda + 4 &= 0 \\ (\lambda + 2)^2 &= 0 \\ \lambda &= -2\end{aligned}$$

The general solution of the differential equation is

$$y = c_1 e^{-2t} + c_2 t e^{-2t}.$$

We apply the initial conditions to determine the constants.

$$\begin{aligned}c_1 e^2 - c_2 e^2 &= 2, & -2c_1 e^2 + 3c_2 e^2 &= 1 \\ c_1 &= 7 e^{-2}, & c_2 &= 5 e^{-2}\end{aligned}$$

The solution subject to the initial conditions is

$$y = (7 + 5t) e^{-2(t+1)}$$

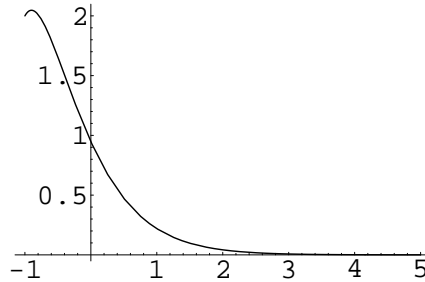

Figure 17.3: The solution of  $y'' + 4y' + 4y = 0$ ,  $y(-1) = 2$ ,  $y'(-1) = 1$ .

The solution is plotted in Figure 17.3. The solution vanishes as  $t \rightarrow \infty$ .

$$\lim_{t \rightarrow \infty} (7 + 5t) e^{-2(t+1)} = \lim_{t \rightarrow \infty} \frac{7 + 5t}{e^{2(t+1)}} = \lim_{t \rightarrow \infty} \frac{5}{2 e^{2(t+1)}} = 0$$

### Solution 17.4

$$y'' - 4y' + 13y = 0.$$

With the substitution  $y = e^{\lambda x}$  we obtain

$$\lambda^2 e^{\lambda x} - 4\lambda e^{\lambda x} + 13 e^{\lambda x} = 0$$

$$\lambda^2 - 4\lambda + 13 = 0$$

$$\lambda = 2 \pm 3i.$$

Thus two linearly independent solutions are

$$e^{(2+3i)x}, \quad \text{and} \quad e^{(2-3i)x}.$$

Noting that

$$e^{(2+3i)x} = e^{2x}[\cos(3x) + i \sin(3x)]$$
$$e^{(2-3i)x} = e^{2x}[\cos(3x) - i \sin(3x)],$$

we can write the two linearly independent solutions

$$y_1 = e^{2x} \cos(3x), \quad y_2 = e^{2x} \sin(3x).$$

### Solution 17.5

We note that

$$y''' - y'' + y' - y = 0$$

is a constant coefficient equation. The substitution,  $y = e^{\lambda x}$ , yields

$$\lambda^3 - \lambda^2 + \lambda - 1 = 0$$
$$(\lambda - 1)(\lambda - i)(\lambda + i) = 0.$$

The corresponding solutions are  $e^x$ ,  $e^{ix}$ , and  $e^{-ix}$ . We can write the general solution as

$$y = c_1 e^x + c_2 \cos x + c_3 \sin x.$$

### Solution 17.6

We start with the equation  $y'' + y = 0$ . We substitute  $y = e^{\lambda x}$  into the differential equation to obtain

$$\lambda^2 + 1 = 0, \quad \lambda = \pm i.$$

A linearly independent set of solutions is

$$\{e^{ix}, e^{-ix}\}.$$

The **fundamental set of solutions** has the form

$$y_1 = c_1 e^{ix} + c_2 e^{-ix},$$
$$y_2 = c_3 e^{ix} + c_4 e^{-ix}.$$

By applying the constraints

$$\begin{aligned}y_1(0) &= 1, & y_1'(0) &= 0, \\y_2(0) &= 0, & y_2'(0) &= 1,\end{aligned}$$

we obtain

$$\begin{aligned}y_1 &= \frac{e^{ix} + e^{-ix}}{2} = \cos x, \\y_2 &= \frac{e^{ix} - e^{-ix}}{i2} = \sin x.\end{aligned}$$

Now consider the equation  $y'' - y = 0$ . By substituting  $y = e^{\lambda x}$  we find that a set of solutions is

$$\{e^x, e^{-x}\}.$$

By taking linear combinations of these we see that another set of solutions is

$$\{\cosh x, \sinh x\}.$$

Note that this is the **fundamental set of solutions**.

Next consider  $y'' = 0$ . We can find the solutions by substituting  $y = e^{\lambda x}$  or by integrating the equation twice. The **fundamental set of solutions** as  $x = 0$  is

$$\{1, x\}.$$

Note that if  $u(x)$  is a solution of a constant coefficient differential equation, then  $u(x + c)$  is also a solution. Also note that if  $u(x)$  satisfies  $y(0) = a$ ,  $y'(0) = b$ , then  $u(x - x_0)$  satisfies  $y(x_0) = a$ ,  $y'(x_0) = b$ . Thus the **fundamental sets of solutions** at  $x = 1$  are

1.  $\{\cos(x - 1), \sin(x - 1)\}$ ,
2.  $\{\cosh(x - 1), \sinh(x - 1)\}$ ,
3.  $\{1, x - 1\}$ .



### Solution 17.7

Let  $y(t)$  denote the displacement of the mass from equilibrium. The forces on the mass are  $-ky(t)$  due to the spring and  $-\mu y'(t)$  due to friction. We equate the external forces to  $my''(t)$  to find the differential equation of the motion.

$$my'' = -ky - \mu y'$$
$$\boxed{y'' + \frac{\mu}{m}y' + \frac{k}{m}y = 0}$$

The solution which satisfies the initial conditions  $y(0) = 0$ ,  $y'(0) = 1$  is

$$y(t) = \begin{cases} e^{-\mu t/(2m)} \frac{2m}{\sqrt{\mu^2 - 4km}} \sinh\left(\sqrt{\mu^2 - 4km} t/(2m)\right) & \text{if } \mu^2 > km, \\ e^{-\mu t/(2m)} \frac{2m}{\sqrt{4km - \mu^2}} \sin\left(\sqrt{4km - \mu^2} t/(2m)\right) & \text{if } \mu^2 < km, \\ t e^{-\mu t/(2m)} & \text{if } \mu^2 = km. \end{cases}$$

We respectively call these cases: strongly damped, weakly damped and critically damped. In the case that  $m = k = 1$  the solution is

$$y(t) = \begin{cases} e^{-\mu t/2} \frac{2}{\sqrt{\mu^2 - 4}} \sinh\left(\sqrt{\mu^2 - 4} t/2\right) & \text{if } \mu > 2, \\ e^{-\mu t/2} \frac{2}{\sqrt{4 - \mu^2}} \sin\left(\sqrt{4 - \mu^2} t/2\right) & \text{if } \mu < 2, \\ t e^{-t} & \text{if } \mu = 2. \end{cases}$$

Note that when  $t$  is large,  $t e^{-t}$  is much smaller than  $e^{-\mu t/2}$  for  $\mu < 2$ . To prove this we examine the ratio of these functions as  $t \rightarrow \infty$ .

$$\begin{aligned} \lim_{t \rightarrow \infty} \frac{t e^{-t}}{e^{-\mu t/2}} &= \lim_{t \rightarrow \infty} \frac{t}{e^{(1-\mu/2)t}} \\ &= \lim_{t \rightarrow \infty} \frac{1}{(1 - \mu/2) e^{(1-\mu/2)t}} \\ &= 0 \end{aligned}$$

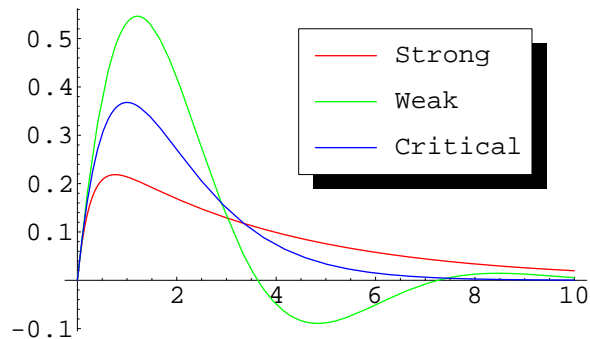

Figure 17.4: Strongly, weakly and critically damped solutions.

Using this result, we see that the critically damped solution decays faster than the weakly damped solution.

We can write the strongly damped solution as

$$e^{-\mu t/2} \frac{2}{\sqrt{\mu^2 - 4}} \left( e^{\sqrt{\mu^2 - 4}t/2} - e^{-\sqrt{\mu^2 - 4}t/2} \right).$$

For large  $t$ , the dominant factor is  $e^{(\sqrt{\mu^2 - 4} - \mu)t/2}$ . Note that for  $\mu > 2$ ,

$$\sqrt{\mu^2 - 4} = \sqrt{(\mu + 2)(\mu - 2)} > \mu - 2.$$

Therefore we have the bounds

$$-2 < \sqrt{\mu^2 - 4} - \mu < 0.$$

This shows that the critically damped solution decays faster than the strongly damped solution.  $\mu = 2$  gives the fastest decaying solution. Figure 17.4 shows the solution for  $\mu = 4$ ,  $\mu = 1$  and  $\mu = 2$ .

**Solution 17.8**

Clearly  $y = c \cos(x - \phi)$  satisfies the differential equation  $y'' + y = 0$ . Since it is a two-parameter family of functions, it must be the general solution.

Using a trigonometric identity we can rewrite the solution as

$$y = c \cos \phi \cos x + c \sin \phi \sin x.$$

Setting this equal to  $\sin x$  gives us the two equations

$$c \cos \phi = 0,$$

$$c \sin \phi = 1,$$

which has the solutions  $c = 1$ ,  $\phi = (2n + 1/2)\pi$ , and  $c = -1$ ,  $\phi = (2n - 1/2)\pi$ , for  $n \in \mathbb{Z}$ .

Clearly  $y = c \cosh(x - \phi)$  satisfies the differential equation  $y'' - y = 0$ . Since it is a two-parameter family of functions, it must be the general solution.

Using a trigonometric identity we can rewrite the solution as

$$y = c \cosh \phi \cosh x + c \sinh \phi \sinh x.$$

Setting this equal to  $\sinh x$  gives us the two equations

$$c \cosh \phi = 0,$$

$$c \sinh \phi = 1,$$

which has the solutions  $c = -i$ ,  $\phi = i(2n + 1/2)\pi$ , and  $c = i$ ,  $\phi = i(2n - 1/2)\pi$ , for  $n \in \mathbb{Z}$ .

**Solution 17.9**

We substitute  $y = e^{\lambda t}$  into the differential equation.

$$\lambda^2 e^{\lambda t} + 5\lambda e^{\lambda t} + 6e^{\lambda t} = 0$$

$$\lambda^2 + 5\lambda + 6 = 0$$

$$(\lambda + 2)(\lambda + 3) = 0$$

The general solution of the differential equation is

$$y = c_1 e^{-2t} + c_2 e^{-3t}.$$

The initial conditions give us the constraints:

$$\begin{aligned}c_1 + c_2 &= 1, \\ -2c_1 - 3c_2 &= V.\end{aligned}$$

The solution subject to the initial conditions is

$$y = (3 + V)e^{-2t} - (2 + V)e^{-3t}.$$

This solution will be non-negative for  $t > 0$  if  $V \geq -3$ .

### **Solution 17.10**

For negative  $x$ , the differential equation is

$$y'' - y = 0.$$

We substitute  $y = e^{\lambda x}$  into the differential equation to find the solutions.

$$\begin{aligned}\lambda^2 - 1 &= 0 \\ \lambda &= \pm 1 \\ y &= \{e^x, e^{-x}\}\end{aligned}$$

We can take linear combinations to write the solutions in terms of the hyperbolic sine and cosine.

$$y = \{\cosh(x), \sinh(x)\}$$

For positive  $x$ , the differential equation is

$$y'' + y = 0.$$

We substitute  $y = e^{\lambda x}$  into the differential equation to find the solutions.

$$\begin{aligned}\lambda^2 + 1 &= 0 \\ \lambda &= \pm i \\ y &= \{e^{ix}, e^{-ix}\}\end{aligned}$$

We can take linear combinations to write the solutions in terms of the sine and cosine.

$$y = \{\cos(x), \sin(x)\}$$

We will find the **fundamental set of solutions** at  $x = 0$ . That is, we will find a set of solutions,  $\{y_1, y_2\}$  that satisfy the conditions:

$$\begin{aligned}y_1(0) &= 1 & y_1'(0) &= 0 \\ y_2(0) &= 0 & y_2'(0) &= 1\end{aligned}$$

Clearly, these solutions are

$$y_1 = \begin{cases} \cosh(x) & x < 0 \\ \cos(x) & x \geq 0 \end{cases} \quad y_2 = \begin{cases} \sinh(x) & x < 0 \\ \sin(x) & x \geq 0 \end{cases}$$

## Euler Equations

### Solution 17.11

We consider an Euler equation,

$$x^2 y'' + xy' + y = 0, \quad x > 0.$$

We make the change of independent variable  $\xi = \ln x$ ,  $u(\xi) = y(x)$  to obtain

$$u'' + u = 0.$$

We make the substitution  $u(\xi) = e^{\lambda\xi}$ .

$$\begin{aligned}\lambda^2 + 1 &= 0 \\ \lambda &= \pm i\end{aligned}$$

A set of linearly independent solutions for  $u(\xi)$  is

$$\{e^{i\xi}, e^{-i\xi}\}.$$

Since

$$\cos \xi = \frac{e^{i\xi} + e^{-i\xi}}{2} \quad \text{and} \quad \sin \xi = \frac{e^{i\xi} - e^{-i\xi}}{i2},$$

another linearly independent set of solutions is

$$\{\cos \xi, \sin \xi\}.$$

The general solution for  $y(x)$  is

$$y(x) = c_1 \cos(\ln x) + c_2 \sin(\ln x).$$

### **Solution 17.12**

Consider the differential equation

$$x^2 y'' - 2xy' + 2y = 0.$$

With the substitution  $y = x^\lambda$  this equation becomes

$$\begin{aligned}\lambda(\lambda - 1) - 2\lambda + 2 &= 0 \\ \lambda^2 - 3\lambda + 2 &= 0 \\ \lambda &= 1, 2.\end{aligned}$$

The general solution is then

$$y = c_1 x + c_2 x^2.$$

**Solution 17.13**

We note that

$$xy''' + y'' + \frac{1}{x}y' = 0$$

is an Euler equation. The substitution  $y = x^\lambda$  yields

$$\begin{aligned}\lambda^3 - 3\lambda^2 + 2\lambda + \lambda^2 - \lambda + \lambda &= 0 \\ \lambda^3 - 2\lambda^2 + 2\lambda &= 0.\end{aligned}$$

The three roots of this algebraic equation are

$$\lambda = 0, \quad \lambda = 1 + i, \quad \lambda = 1 - i$$

The corresponding solutions to the differential equation are

$$\begin{array}{lll}y = x^0 & y = x^{1+i} & y = x^{1-i} \\ y = 1 & y = x e^{i \ln x} & y = x e^{-i \ln x}.\end{array}$$

We can write the general solution as

$$y = c_1 + c_2 x \cos(\ln x) + c_3 \sin(\ln x).$$

**Solution 17.14**

We substitute  $y = x^\lambda$  into the differential equation.

$$\begin{aligned}x^2 y'' + (2a + 1)xy' + by &= 0 \\ \lambda(\lambda - 1) + (2a + 1)\lambda + b &= 0 \\ \lambda^2 + 2a\lambda + b &= 0 \\ \lambda &= -a \pm \sqrt{a^2 - b}\end{aligned}$$

For  $a^2 > b$  then the general solution is

$$y = c_1 x^{-a+\sqrt{a^2-b}} + c_2 x^{-a-\sqrt{a^2-b}}.$$

For  $a^2 < b$ , then the general solution is

$$y = c_1 x^{-a+i\sqrt{b-a^2}} + c_2 x^{-a-i\sqrt{b-a^2}}.$$

By taking the sum and difference of these solutions, we can write the general solution as

$$y = c_1 x^{-a} \cos(\sqrt{b-a^2} \ln x) + c_2 x^{-a} \sin(\sqrt{b-a^2} \ln x).$$

For  $a^2 = b$ , the quadratic in lambda has a double root at  $\lambda = a$ . The general solution of the differential equation is

$$y = c_1 x^{-a} + c_2 x^{-a} \ln x.$$

In summary, the general solution is:

$y = \begin{cases} x^{-a} (c_1 x^{\sqrt{a^2-b}} + c_2 x^{-\sqrt{a^2-b}}) & \text{if } a^2 > b, \\ x^{-a} (c_1 \cos(\sqrt{b-a^2} \ln x) + c_2 \sin(\sqrt{b-a^2} \ln x)) & \text{if } a^2 < b, \\ x^{-a} (c_1 + c_2 \ln x) & \text{if } a^2 = b. \end{cases}$
---

### Solution 17.15

For  $a \neq 0$ , two linearly independent solutions of

$$y'' - a^2 y = 0$$

are

$$y_1 = e^{ax}, \quad y_2 = e^{-ax}.$$

For  $a = 0$ , we have

$$y_1 = e^{0x} = 1, \quad y_2 = x e^{0x} = x.$$



In this case the solution are defined by

$$y_1 = [e^{ax}]_{a=0}, \quad y_2 = \left[ \frac{d}{da} e^{ax} \right]_{a=0}.$$

By the definition of differentiation,  $f'(0)$  is

$$f'(0) = \lim_{a \rightarrow 0} \frac{f(a) - f(-a)}{2a}.$$

Thus the second solution in the case  $a = 0$  is

$$y_2 = \lim_{a \rightarrow 0} \frac{e^{ax} - e^{-ax}}{a}$$

Consider the solutions

$$y_1 = e^{ax}, \quad y_2 = \lim_{\alpha \rightarrow a} \frac{e^{\alpha x} - e^{-\alpha x}}{\alpha}.$$

Clearly  $y_1$  is a solution for all  $a$ . For  $a \neq 0$ ,  $y_2$  is a linear combination of  $e^{ax}$  and  $e^{-ax}$  and is thus a solution. Since the coefficient of  $e^{-ax}$  in this linear combination is non-zero, it is linearly independent to  $y_1$ . For  $a = 0$ ,  $y_2$  is one half the derivative of  $e^{ax}$  evaluated at  $a = 0$ . Thus it is a solution.

For  $a \neq 0$ , two linearly independent solutions of

$$x^2 y'' + xy' - a^2 y = 0$$

are

$$y_1 = x^a, \quad y_2 = x^{-a}.$$

For  $a = 0$ , we have

$$y_1 = [x^a]_{a=0} = 1, \quad y_2 = \left[ \frac{d}{da} x^a \right]_{a=0} = \ln x.$$

Consider the solutions

$$y_1 = x^a, \quad y_2 = \frac{x^a - x^{-a}}{a}$$

Clearly  $y_1$  is a solution for all  $a$ . For  $a \neq 0$ ,  $y_2$  is a linear combination of  $x^a$  and  $x^{-a}$  and is thus a solution. For  $a = 0$ ,  $y_2$  is one half the derivative of  $x^a$  evaluated at  $a = 0$ . Thus it is a solution.

**Solution 17.16**

1.

$$x^2y'' - 2xy' + 2y = 0$$

We substitute  $y = x^\lambda$  into the differential equation.

$$\lambda(\lambda - 1) - 2\lambda + 2 = 0$$

$$\lambda^2 - 3\lambda + 2 = 0$$

$$(\lambda - 1)(\lambda - 2) = 0$$

$$y = c_1x + c_2x^2$$

2.

$$x^2y'' - 2y = 0$$

We substitute  $y = x^\lambda$  into the differential equation.

$$\lambda(\lambda - 1) - 2 = 0$$

$$\lambda^2 - \lambda - 2 = 0$$

$$(\lambda + 1)(\lambda - 2) = 0$$

$$y = \frac{c_1}{x} + c_2x^2$$

3.

$$x^2y'' - xy' + y = 0$$

We substitute  $y = x^\lambda$  into the differential equation.

$$\lambda(\lambda - 1) - \lambda + 1 = 0$$

$$\lambda^2 - 2\lambda + 1 = 0$$

$$(\lambda - 1)^2 = 0$$

Since there is a double root, the solution is:

$$y = c_1x + c_2x \ln x.$$

## Exact Equations

### Solution 17.17

We note that

$$y'' + y' \sin x + y \cos x = 0$$

is an exact equation.

$$\frac{d}{dx}[y' + y \sin x] = 0$$

$$y' + y \sin x = c_1$$

$$\frac{d}{dx}[y e^{-\cos x}] = c_1 e^{-\cos x}$$

$$y = c_1 e^{\cos x} \int e^{-\cos x} dx + c_2 e^{\cos x}$$

## Equations Without Explicit Dependence on $y$ Reduction of Order

### Solution 17.18

$$(1 - x^2)y'' - 2xy' + 2y = 0, \quad -1 < x < 1$$

We substitute  $y = x$  into the differential equation to check that it is a solution.

$$(1 - x^2)(0) - 2x(1) + 2x = 0$$

We look for a second solution of the form  $y = xu$ . We substitute this into the differential equation and use the fact that  $x$  is a solution.

$$(1 - x^2)(xu'' + 2u') - 2x(xu' + u) + 2xu = 0$$

$$(1 - x^2)(xu'' + 2u') - 2x(xu') = 0$$

$$(1 - x^2)xu'' + (2 - 4x^2)u' = 0$$

$$\frac{u''}{u'} = \frac{2 - 4x^2}{x(x^2 - 1)}$$

$$\frac{u''}{u'} = -\frac{2}{x} + \frac{1}{1 - x} - \frac{1}{1 + x}$$

$$\ln(u') = -2 \ln(x) - \ln(1 - x) - \ln(1 + x) + \text{const}$$

$$\ln(u') = \ln\left(\frac{c}{x^2(1 - x)(1 + x)}\right)$$

$$u' = \frac{c}{x^2(1 - x)(1 + x)}$$

$$u' = c\left(\frac{1}{x^2} + \frac{1}{2(1 - x)} + \frac{1}{2(1 + x)}\right)$$

$$u = c\left(-\frac{1}{x} - \frac{1}{2} \ln(1 - x) + \frac{1}{2} \ln(1 + x)\right) + \text{const}$$

$$u = c\left(-\frac{1}{x} + \frac{1}{2} \ln\left(\frac{1 + x}{1 - x}\right)\right) + \text{const}$$

A second linearly independent solution is

$$y = -1 + \frac{x}{2} \ln\left(\frac{1 + x}{1 - x}\right).$$

**Solution 17.19**

We are given that  $y = e^x$  is a solution of

$$y'' - \frac{x+1}{x}y' + \frac{1}{x}y = 0.$$

To find another linearly independent solution, we will use reduction of order. Substituting

$$\begin{aligned} y &= u e^x \\ y' &= (u' + u) e^x \\ y'' &= (u'' + 2u' + u) e^x \end{aligned}$$

into the differential equation yields

$$u'' + 2u' + u - \frac{x+1}{x}(u' + u) + \frac{1}{x}u = 0.$$

$$u'' + \frac{x-1}{x}u' = 0$$

$$\frac{d}{dx} \left[ u' \exp \left( \int \left( 1 - \frac{1}{x} \right) dx \right) \right] = 0$$

$$u' e^{x-\ln x} = c_1$$

$$u' = c_1 x e^{-x}$$

$$u = c_1 \int x e^{-x} dx + c_2$$

$$u = c_1(x e^{-x} + e^{-x}) + c_2$$

$$y = c_1(x+1) + c_2 e^x$$

Thus a second linearly independent solution is

$$\boxed{y = x + 1.}$$

**Solution 17.20**

We are given that  $y = x$  is a solution of

$$(1 - 2x)y'' + 4xy' - 4y = 0.$$

To find another linearly independent solution, we will use reduction of order. Substituting

$$\begin{aligned}y &= xu \\y' &= xu' + u \\y'' &= xu'' + 2u'\end{aligned}$$

into the differential equation yields

$$(1 - 2x)(xu'' + 2u') + 4x(xu' + u) - 4xu = 0,$$

$$(1 - 2x)xu'' + (4x^2 - 4x + 2)u' = 0,$$

$$\frac{u''}{u'} = \frac{4x^2 - 4x + 2}{x(2x - 1)},$$

$$\frac{u''}{u'} = 2 - \frac{2}{x} + \frac{2}{2x - 1},$$

$$\ln(u') = 2x - 2 \ln x + \ln(2x - 1) + \text{const},$$

$$u' = c_1 \left( \frac{2}{x} - \frac{1}{x^2} \right) e^{2x},$$

$$u = c_1 \frac{1}{x} e^{2x} + c_2,$$

$$\boxed{y = c_1 e^{2x} + c_2 x.}$$

**Solution 17.21**

One solution of

$$(x - 1)y'' - xy' + y = 0,$$

is  $y_1 = e^x$ . We find a second solution with reduction of order. We make the substitution  $y_2 = u e^x$  in the differential equation. We determine  $u$  up to an additive constant.

$$(x - 1)(u'' + 2u' + u) e^x - x(u' + u) e^x + u e^x = 0$$

$$(x - 1)u'' + (x - 2)u' = 0$$

$$\frac{u''}{u'} = -\frac{x - 2}{x - 1} = -1 + \frac{1}{x - 1}$$

$$\ln |u'| = -x + \ln |x - 1| + c$$

$$u' = c(x - 1) e^{-x}$$

$$u = -cx e^{-x}$$

The second solution of the differential equation is  $y_2 = x$ .

## **\*Reduction of Order and the Adjoint Equation**

# Chapter 18

## Techniques for Nonlinear Differential Equations

In mathematics you don't understand things. You just get used to them.

- Johann von Neumann

### 18.1 Bernoulli Equations

Sometimes it is possible to solve a nonlinear equation by making a change of the dependent variable that converts it into a linear equation. One of the most important such equations is the *Bernoulli equation*

$$\frac{dy}{dt} + p(t)y = q(t)y^\alpha, \quad \alpha \neq 1.$$

The change of dependent variable  $u = y^{1-\alpha}$  will yield a first order linear equation for  $u$  which when solved will give us an implicit solution for  $y$ . (See Exercise 18.4.)



**Result 18.1.1** The Bernoulli equation  $y' + p(t)y = q(t)y^\alpha$ ,  $\alpha \neq 1$  can be transformed to the first order linear equation

$$\frac{du}{dt} + (1 - \alpha)p(t)u = (1 - \alpha)q(t)$$

with the change of variables  $u = y^{1-\alpha}$ .

**Example 18.1.1** Consider the Bernoulli equation

$$y' = \frac{2}{x}y + y^2.$$

First we divide by  $y^2$ .

$$y^{-2}y' = \frac{2}{x}y^{-1} + 1$$

We make the change of variable  $u = y^{-1}$ .

$$\begin{aligned} -u' &= \frac{2}{x}u + 1 \\ u' + \frac{2}{x}u &= -1 \end{aligned}$$

The integrating factor is  $I(x) = \exp\left(\int \frac{2}{x} dx\right) = x^2$ .

$$\begin{aligned}\frac{d}{dx}(x^2u) &= -x^2 \\ x^2u &= -\frac{1}{3}x^3 + c \\ u &= -\frac{1}{3}x + \frac{c}{x^2} \\ y &= \left(-\frac{1}{3}x + \frac{c}{x^2}\right)^{-1}\end{aligned}$$

Thus the solution for  $y$  is

$$y = \frac{3x^2}{c - x^2}.$$

## 18.2 Riccati Equations

**Factoring Second Order Operators.** Consider the second order linear equation

$$L[y] = \left[ \frac{d^2}{dx^2} + p(x) \frac{d}{dx} + q(x) \right] y = y'' + p(x)y' + q(x)y = f(x).$$

If we were able to factor the linear operator  $L$  into the form

$$L = \left[ \frac{d}{dx} + a(x) \right] \left[ \frac{d}{dx} + b(x) \right], \quad (18.1)$$

then we would be able to solve the differential equation. Factoring reduces the problem to a system of first order equations. We start with the factored equation

$$\left[ \frac{d}{dx} + a(x) \right] \left[ \frac{d}{dx} + b(x) \right] y = f(x).$$

We set  $u = \left[ \frac{d}{dx} + b(x) \right] y$  and solve the problem

$$\left[ \frac{d}{dx} + a(x) \right] u = f(x).$$

Then to obtain the solution we solve

$$\left[ \frac{d}{dx} + b(x) \right] y = u.$$

**Example 18.2.1** Consider the equation

$$y'' + \left( x - \frac{1}{x} \right) y' + \left( \frac{1}{x^2} - 1 \right) y = 0.$$

Let's say by some insight or just random luck we are able to see that this equation can be factored into

$$\left[ \frac{d}{dx} + x \right] \left[ \frac{d}{dx} - \frac{1}{x} \right] y = 0.$$

We first solve the equation

$$\begin{aligned} \left[ \frac{d}{dx} + x \right] u &= 0 \\ u' + xu &= 0 \\ \frac{d}{dx} \left( e^{x^2/2} u \right) &= 0 \\ u &= c_1 e^{-x^2/2} \end{aligned}$$

Then we solve for  $y$  with the equation

$$\left[ \frac{d}{dx} - \frac{1}{x} \right] y = u = c_1 e^{-x^2/2}.$$

$$y' - \frac{1}{x}y = c_1 e^{-x^2/2}$$

$$\frac{d}{dx} (x^{-1}y) = c_1 x^{-1} e^{-x^2/2}$$

$$y = c_1 x \int x^{-1} e^{-x^2/2} dx + c_2 x$$

If we were able to solve for  $a$  and  $b$  in Equation 18.1 in terms of  $p$  and  $q$  then we would be able to solve any second order differential equation. Equating the two operators,

$$\begin{aligned} \frac{d^2}{dx^2} + p \frac{d}{dx} + q &= \left[ \frac{d}{dx} + a \right] \left[ \frac{d}{dx} + b \right] \\ &= \frac{d^2}{dx^2} + (a+b) \frac{d}{dx} + (b' + ab). \end{aligned}$$

Thus we have the two equations

$$a + b = p, \quad \text{and} \quad b' + ab = q.$$

Eliminating  $a$ ,

$$b' + (p - b)b = q$$

$$b' = b^2 - pb + q$$

Now we have a nonlinear equation for  $b$  that is no easier to solve than the original second order linear equation.

**Riccati Equations.** Equations of the form

$$y' = a(x)y^2 + b(x)y + c(x)$$

are called Riccati equations. From the above derivation we see that for every second order differential equation there is a corresponding Riccati equation. Now we will show that the converse is true.

We make the substitution

$$y = -\frac{u'}{au}, \quad y' = -\frac{u''}{au} + \frac{(u')^2}{au^2} + \frac{a'u'}{a^2u},$$

in the Riccati equation.

$$\begin{aligned} y' &= ay^2 + by + c \\ -\frac{u''}{au} + \frac{(u')^2}{au^2} + \frac{a'u'}{a^2u} &= a\frac{(u')^2}{a^2u^2} - b\frac{u'}{au} + c \\ -\frac{u''}{au} + \frac{a'u'}{a^2u} + b\frac{u'}{au} - c &= 0 \\ u'' - \left(\frac{a'}{a} + b\right)u' + acu &= 0 \end{aligned}$$

Now we have a second order linear equation for  $u$ .

**Result 18.2.1** The substitution  $y = -\frac{u'}{au}$  transforms the Riccati equation

$$y' = a(x)y^2 + b(x)y + c(x)$$

into the second order linear equation

$$u'' - \left(\frac{a'}{a} + b\right)u' + acu = 0.$$

**Example 18.2.2** Consider the Riccati equation

$$y' = y^2 + \frac{1}{x}y + \frac{1}{x^2}.$$

With the substitution  $y = -\frac{u'}{u}$  we obtain

$$u'' - \frac{1}{x}u' + \frac{1}{x^2}u = 0.$$

This is an Euler equation. The substitution  $u = x^\lambda$  yields

$$\lambda(\lambda - 1) - \lambda + 1 = (\lambda - 1)^2 = 0.$$

Thus the general solution for  $u$  is

$$u = c_1x + c_2x \log x.$$

Since  $y = -\frac{u'}{u}$ ,

$$y = -\frac{c_1 + c_2(1 + \log x)}{c_1x + c_2x \log x}$$

$$y = -\frac{1 + c(1 + \log x)}{x + cx \log x}$$

## 18.3 Exchanging the Dependent and Independent Variables

Some differential equations can be put in a more elementary form by exchanging the dependent and independent variables. If the new equation can be solved, you will have an implicit solution for the initial equation. We will consider a few examples to illustrate the method.

**Example 18.3.1** Consider the equation

$$y' = \frac{1}{y^3 - xy^2}.$$

Instead of considering  $y$  to be a function of  $x$ , consider  $x$  to be a function of  $y$ . That is,  $x = x(y)$ ,  $x' = \frac{dx}{dy}$ .

$$\begin{aligned}\frac{dy}{dx} &= \frac{1}{y^3 - xy^2} \\ \frac{dx}{dy} &= y^3 - xy^2 \\ x' + y^2x &= y^3\end{aligned}$$

Now we have a first order equation for  $x$ .

$$\frac{d}{dy} \left( e^{y^3/3} x \right) = y^3 e^{y^3/3}$$

$$x = e^{-y^3/3} \int y^3 e^{y^3/3} dy + c e^{-y^3/3}$$

**Example 18.3.2** Consider the equation

$$y' = \frac{y}{y^2 + 2x}.$$

Interchanging the dependent and independent variables yields

$$\frac{1}{x'} = \frac{y}{y^2 + 2x}$$

$$x' = y + 2\frac{x}{y}$$

$$x' - 2\frac{x}{y} = y$$

$$\frac{d}{dy}(y^{-2}x) = y^{-1}$$

$$y^{-2}x = \log y + c$$

$$x = y^2 \log y + cy^2$$

**Result 18.3.1** Some differential equations can be put in a simpler form by exchanging the dependent and independent variables. Thus a differential equation for  $y(x)$  can be written as an equation for  $x(y)$ . Solving the equation for  $x(y)$  will give an implicit solution for  $y(x)$ .

## 18.4 Autonomous Equations

Autonomous equations have no explicit dependence on  $x$ . The following are examples.

- $y'' + 3y' - 2y = 0$
- $y'' = y + (y')^2$
- $y''' + y''y = 0$

The change of variables  $u(y) = y'$  reduces an  $n^{\text{th}}$  order autonomous equation in  $y$  to a non-autonomous equation of order  $n - 1$  in  $u(y)$ . Writing the derivatives of  $y$  in terms of  $u$ ,

$$\begin{aligned}y' &= u(y) \\y'' &= \frac{d}{dx}u(y) \\&= \frac{dy}{dx} \frac{d}{dy}u(y) \\&= y'u' \\&= u'u \\y''' &= (u''u + (u')^2)u.\end{aligned}$$

Thus we see that the equation for  $u(y)$  will have an order of one less than the original equation.

**Result 18.4.1** Consider an autonomous differential equation for  $y(x)$ , (autonomous equations have no explicit dependence on  $x$ .) The change of variables  $u(y) = y'$  reduces an  $n^{\text{th}}$  order autonomous equation in  $y$  to a non-autonomous equation of order  $n - 1$  in  $u(y)$ .



**Example 18.4.1** Consider the equation

$$y'' = y + (y')^2.$$

With the substitution  $u(y) = y'$ , the equation becomes

$$\begin{aligned}u'u &= y + u^2 \\u' &= u + yu^{-1}.\end{aligned}$$

We recognize this as a Bernoulli equation. The substitution  $v = u^2$  yields

$$\begin{aligned}\frac{1}{2}v' &= v + y \\v' - 2v &= 2y \\ \frac{d}{dy} (e^{-2y} v) &= 2y e^{-2y} \\v(y) &= c_1 e^{2y} + e^{2y} \int 2y e^{-2y} dy \\v(y) &= c_1 e^{2y} + e^{2y} \left( -y e^{-2y} + \int e^{-2y} dy \right) \\v(y) &= c_1 e^{2y} + e^{2y} \left( -y e^{-2y} - \frac{1}{2} e^{-2y} \right) \\v(y) &= c_1 e^{2y} - y - \frac{1}{2}.\end{aligned}$$

Now we solve for  $u$ .

$$\begin{aligned}u(y) &= \left( c_1 e^{2y} - y - \frac{1}{2} \right)^{1/2} \\ \frac{dy}{dx} &= \left( c_1 e^{2y} - y - \frac{1}{2} \right)^{1/2}\end{aligned}$$

This equation is separable.

$$dx = \frac{dy}{\left(c_1 e^{2y} - y - \frac{1}{2}\right)^{1/2}}$$

$$x + c_2 = \int \frac{1}{\left(c_1 e^{2y} - y - \frac{1}{2}\right)^{1/2}} dy$$

Thus we finally have arrived at an implicit solution for  $y(x)$ .

**Example 18.4.2** Consider the equation

$$y'' + y^3 = 0.$$

With the change of variables,  $u(y) = y'$ , the equation becomes

$$u'u + y^3 = 0.$$

This equation is separable.

$$u du = -y^3 dy$$

$$\frac{1}{2}u^2 = -\frac{1}{4}y^4 + c_1$$

$$u = \left(2c_1 - \frac{1}{2}y^4\right)^{1/2}$$

$$y' = \left(2c_1 - \frac{1}{2}y^4\right)^{1/2}$$

$$\frac{dy}{\left(2c_1 - \frac{1}{2}y^4\right)^{1/2}} = dx$$

Integrating gives us the implicit solution

$$\int \frac{1}{\left(2c_1 - \frac{1}{2}y^4\right)^{1/2}} dy = x + c_2.$$

## 18.5 \*Equidimensional-in- $x$ Equations

Differential equations that are invariant under the change of variables  $x = c\xi$  are said to be equidimensional-in- $x$ . For a familiar example from linear equations, we note that the Euler equation is equidimensional-in- $x$ . Writing the new derivatives under the change of variables,

$$x = c\xi, \quad \frac{d}{dx} = \frac{1}{c} \frac{d}{d\xi}, \quad \frac{d^2}{dx^2} = \frac{1}{c^2} \frac{d^2}{d\xi^2}, \quad \dots$$

**Example 18.5.1** Consider the Euler equation

$$y'' + \frac{2}{x}y' + \frac{3}{x^2}y = 0.$$

Under the change of variables,  $x = c\xi$ ,  $y(x) = u(\xi)$ , this equation becomes

$$\begin{aligned} \frac{1}{c^2}u'' + \frac{2}{c\xi} \frac{1}{c}u' + \frac{3}{c^2\xi^2}u &= 0 \\ u'' + \frac{2}{\xi}u' + \frac{3}{\xi^2}u &= 0. \end{aligned}$$

Thus this equation is invariant under the change of variables  $x = c\xi$ .

**Example 18.5.2** For a nonlinear example, consider the equation

$$y'' y' + \frac{y''}{x y} + \frac{y'}{x^2} = 0.$$

With the change of variables  $x = c\xi$ ,  $y(x) = u(\xi)$  the equation becomes

$$\begin{aligned} \frac{u''}{c^2} \frac{u'}{c} + \frac{u''}{c^3 \xi u} + \frac{u'}{c^3 \xi^2} &= 0 \\ u'' u' + \frac{u''}{\xi u} + \frac{u'}{\xi^2} &= 0. \end{aligned}$$

We see that this equation is also equidimensional-in- $x$ .

You may recall that the change of variables  $x = e^t$  reduces an Euler equation to a constant coefficient equation. To generalize this result to nonlinear equations we will see that the same change of variables reduces an equidimensional-in- $x$  equation to an autonomous equation.

Writing the derivatives with respect to  $x$  in terms of  $t$ ,

$$x = e^t, \quad \frac{d}{dx} = \frac{dt}{dx} \frac{d}{dt} = e^{-t} \frac{d}{dt}$$

$$x \frac{d}{dx} = \frac{d}{dt}$$

$$x^2 \frac{d^2}{dx^2} = x \frac{d}{dx} \left( x \frac{d}{dx} \right) - x \frac{d}{dx} = \frac{d^2}{dt^2} - \frac{d}{dt}.$$

**Example 18.5.3** Consider the equation in Example 18.5.2

$$y'' y' + \frac{y''}{x y} + \frac{y'}{x^2} = 0.$$

Applying the change of variables  $x = e^t$ ,  $y(x) = u(t)$  yields an autonomous equation for  $u(t)$ .

$$x^2 y'' x y' + \frac{x^2 y''}{y} + x y' = 0$$

$$(u'' - u')u' + \frac{u'' - u'}{u} + u' = 0$$

**Result 18.5.1** A differential equation that is invariant under the change of variables  $x = c\xi$  is equidimensional-in- $x$ . Such an equation can be reduced to autonomous equation of the same order with the change of variables,  $x = e^t$ .

## 18.6 \*Equidimensional-in-y Equations

A differential equation is said to be equidimensional-in- $y$  if it is invariant under the change of variables  $y(x) = cv(x)$ . Note that all linear homogeneous equations are equidimensional-in- $y$ .

**Example 18.6.1** Consider the linear equation

$$y'' + p(x)y' + q(x)y = 0.$$

With the change of variables  $y(x) = cv(x)$  the equation becomes

$$cv'' + p(x)cv' + q(x)cv = 0$$

$$v'' + p(x)v' + q(x)v = 0$$

Thus we see that the equation is invariant under the change of variables.

**Example 18.6.2** For a nonlinear example, consider the equation

$$y''y + (y')^2 - y^2 = 0.$$

Under the change of variables  $y(x) = cv(x)$  the equation becomes.

$$cv''cv + (cv')^2 - (cv)^2 = 0$$

$$v''v + (v')^2 - v^2 = 0.$$

Thus we see that this equation is also equidimensional-in- $y$ .

The change of variables  $y(x) = e^{u(x)}$  reduces an  $n^{\text{th}}$  order equidimensional-in- $y$  equation to an equation of order  $n - 1$  for  $u'$ . Writing the derivatives of  $e^{u(x)}$ ,

$$\frac{d}{dx} e^u = u' e^u$$

$$\frac{d^2}{dx^2} e^u = (u'' + (u')^2) e^u$$

$$\frac{d^3}{dx^3} e^u = (u''' + 3u''u' + (u')^3) e^u.$$

**Example 18.6.3** Consider the linear equation in Example 18.6.1

$$y'' + p(x)y' + q(x)y = 0.$$

Under the change of variables  $y(x) = e^{u(x)}$  the equation becomes

$$(u'' + (u')^2) e^u + p(x)u' e^u + q(x) e^u = 0$$

$$\boxed{u'' + (u')^2 + p(x)u' + q(x) = 0.}$$

Thus we have a Riccati equation for  $u'$ . This transformation might seem rather useless since linear equations are usually easier to work with than nonlinear equations, but it is often useful in determining the asymptotic behavior of the equation.

**Example 18.6.4** From Example 18.6.2 we have the equation

$$y''y + (y')^2 - y^2 = 0.$$

The change of variables  $y(x) = e^{u(x)}$  yields

$$(u'' + (u')^2) e^u e^u + (u' e^u)^2 - (e^u)^2 = 0$$

$$u'' + 2(u')^2 - 1 = 0$$

$$u'' = -2(u')^2 + 1$$

Now we have a Riccati equation for  $u'$ . We make the substitution  $u' = \frac{v'}{2v}$ .

$$\begin{aligned}\frac{v''}{2v} - \frac{(v')^2}{2v^2} &= -2\frac{(v')^2}{4v^2} + 1 \\ v'' - 2v &= 0 \\ v &= c_1 e^{\sqrt{2}x} + c_2 e^{-\sqrt{2}x} \\ u' &= 2\sqrt{2} \frac{c_1 e^{\sqrt{2}x} - c_2 e^{-\sqrt{2}x}}{c_1 e^{\sqrt{2}x} + c_2 e^{-\sqrt{2}x}} \\ u &= 2 \int \frac{c_1 \sqrt{2} e^{\sqrt{2}x} - c_2 \sqrt{2} e^{-\sqrt{2}x}}{c_1 e^{\sqrt{2}x} + c_2 e^{-\sqrt{2}x}} dx + c_3 \\ u &= 2 \log \left( c_1 e^{\sqrt{2}x} + c_2 e^{-\sqrt{2}x} \right) + c_3 \\ y &= \left( c_1 e^{\sqrt{2}x} + c_2 e^{-\sqrt{2}x} \right)^2 e^{c_3}\end{aligned}$$

The constants are redundant, the general solution is

$$y = \left( c_1 e^{\sqrt{2}x} + c_2 e^{-\sqrt{2}x} \right)^2$$

**Result 18.6.1** A differential equation is equidimensional-in- $y$  if it is invariant under the change of variables  $y(x) = cv(x)$ . An  $n^{\text{th}}$  order equidimensional-in- $y$  equation can be reduced to an equation of order  $n - 1$  in  $u'$  with the change of variables  $y(x) = e^{u(x)}$ .

## 18.7 \*Scale-Invariant Equations

**Result 18.7.1** An equation is scale invariant if it is invariant under the change of variables,  $x = c\xi$ ,  $y(x) = c^\alpha v(\xi)$ , for some value of  $\alpha$ . A scale-invariant equation can be transformed to an equidimensional-in- $x$  equation with the change of variables,  $y(x) = x^\alpha u(x)$ .

**Example 18.7.1** Consider the equation

$$y'' + x^2 y^2 = 0.$$

Under the change of variables  $x = c\xi$ ,  $y(x) = c^\alpha v(\xi)$  this equation becomes

$$\frac{c^\alpha}{c^2} v''(\xi) + c^2 x^2 c^{2\alpha} v^2(\xi) = 0.$$

Equating powers of  $c$  in the two terms yields  $\alpha = -4$ .

Introducing the change of variables  $y(x) = x^{-4} u(x)$  yields

$$\begin{aligned} \frac{d^2}{dx^2} [x^{-4} u(x)] + x^2 (x^{-4} u(x))^2 &= 0 \\ x^{-4} u'' - 8x^{-5} u' + 20x^{-6} u + x^{-6} u^2 &= 0 \end{aligned}$$

$$x^2 u'' - 8x u' + 20u + u^2 = 0.$$

We see that the equation for  $u$  is equidimensional-in- $x$ .



## 18.8 Exercises

### Exercise 18.1

1. Find the general solution and the singular solution of the Clairaut equation,

$$y = xp + p^2.$$

2. Show that the singular solution is the envelope of the general solution.

Hint, Solution

### Bernoulli Equations

#### Exercise 18.2 (mathematica/ode/techniques\_nonlinear/bernoulli.nb)

Consider the Bernoulli equation

$$\frac{dy}{dt} + p(t)y = q(t)y^\alpha.$$

1. Solve the Bernoulli equation for  $\alpha = 1$ .
2. Show that for  $\alpha \neq 1$  the substitution  $u = y^{1-\alpha}$  reduces Bernoulli's equation to a linear equation.
3. Find the general solution to the following equations.

$$t^2 \frac{dy}{dt} + 2ty - y^3 = 0, \quad t > 0$$

(a)

$$\frac{dy}{dx} + 2xy + y^2 = 0$$

(b)

Hint, Solution

### Exercise 18.3

Consider a population,  $y$ . Let the birth rate of the population be proportional to  $y$  with constant of proportionality 1. Let the death rate of the population be proportional to  $y^2$  with constant of proportionality  $1/1000$ . Assume that the population is large enough so that you can consider  $y$  to be continuous. What is the population as a function of time if the initial population is  $y_0$ ?

Hint, Solution

### Exercise 18.4

Show that the transformation  $u = y^{1-n}$  reduces the equation to a linear first order equation. Solve the equations

1.  $t^2 \frac{dy}{dt} + 2ty - y^3 = 0 \quad t > 0$

2.  $\frac{dy}{dt} = (\Gamma \cos t + T)y - y^3$ ,  $\Gamma$  and  $T$  are real constants. (From a fluid flow stability problem.)

Hint, Solution

## Riccati Equations

### Exercise 18.5

1. Consider the Riccati equation,

$$\frac{dy}{dx} = a(x)y^2 + b(x)y + c(x).$$

Substitute

$$y = y_p(x) + \frac{1}{u(x)}$$

into the Riccati equation, where  $y_p$  is some particular solution to obtain a first order linear differential equation for  $u$ .

2. Consider a Riccati equation,

$$y' = 1 + x^2 - 2xy + y^2.$$

Verify that  $y_p(x) = x$  is a particular solution. Make the substitution  $y = y_p + 1/u$  to find the general solution.

What would happen if you continued this method, taking the general solution for  $y_p$ ? Would you be able to find a more general solution?

3. The substitution

$$y = -\frac{u'}{au}$$

gives us the second order, linear, homogeneous differential equation,

$$u'' - \left(\frac{a'}{a} + b\right)u' + acu = 0.$$

The general solution for  $u$  has two constants of integration. However, the solution for  $y$  should only have one constant of integration as it satisfies a first order equation. Write  $y$  in terms of the solution for  $u$  and verify that  $y$  has only one constant of integration.

Hint, Solution

## Exchanging the Dependent and Independent Variables

### Exercise 18.6

Solve the differential equation

$$y' = \frac{\sqrt{y}}{xy + y}.$$

Hint, Solution

## Autonomous Equations

\*Equidimensional-in- $x$  Equations

\*Equidimensional-in- $y$  Equations

\*Scale-Invariant Equations

## 18.9 Hints

### Hint 18.1

### Bernoulli Equations

#### Hint 18.2

#### Hint 18.3

The differential equation governing the population is

$$\frac{dy}{dt} = y - \frac{y^2}{1000}, \quad y(0) = y_0.$$

This is a Bernoulli equation.

#### Hint 18.4

### Riccati Equations

#### Hint 18.5

### Exchanging the Dependent and Independent Variables

#### Hint 18.6

Exchange the dependent and independent variables.

### Autonomous Equations

#### \*Equidimensional-in-x Equations

- \*Equidimensional-in-y Equations
- \*Scale-Invariant Equations

## 18.10 Solutions

### Solution 18.1

We consider the Clairaut equation,

$$y = xp + p^2. \quad (18.2)$$

1. We differentiate Equation 18.2 with respect to  $x$  to obtain a second order differential equation.

$$\begin{aligned} y' &= y' + xy'' + 2y'y'' \\ y''(2y' + x) &= 0 \end{aligned}$$

Equating the first or second factor to zero will lead us to two distinct solutions.

$$y'' = 0 \quad \text{or} \quad y' = -\frac{x}{2}$$

If  $y'' = 0$  then  $y' \equiv p$  is a constant, (say  $y' = c$ ). From Equation 18.2 we see that the general solution is,

$$\boxed{y(x) = cx + c^2.} \quad (18.3)$$

Recall that the general solution of a first order differential equation has one constant of integration.

If  $y' = -x/2$  then  $y = -x^2/4 + \text{const.}$  We determine the constant by substituting the expression into Equation 18.2.

$$-\frac{x^2}{4} + c = x\left(-\frac{x}{2}\right) + \left(-\frac{x}{2}\right)^2$$

Thus we see that a singular solution of the Clairaut equation is

$$\boxed{y(x) = -\frac{1}{4}x^2.} \quad (18.4)$$

Recall that a singular solution of a first order nonlinear differential equation has no constant of integration.

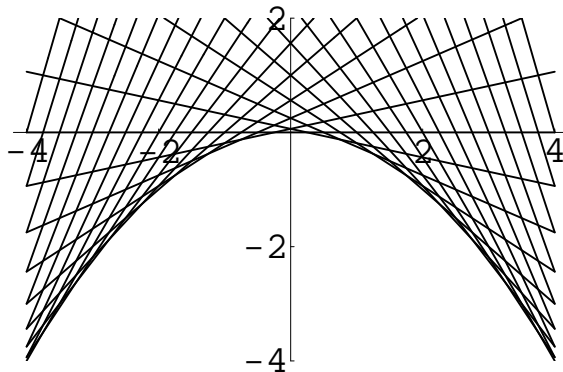

Figure 18.1: The Envelope of  $y = cx + c^2$ .

2. Equating the general and singular solutions,  $y(x)$ , and their derivatives,  $y'(x)$ , gives us the system of equations,

$$cx + c^2 = -\frac{1}{4}x^2, \quad c = -\frac{1}{2}x.$$

Since the first equation is satisfied for  $c = -x/2$ , we see that the solution  $y = cx + c^2$  is tangent to the solution  $y = -x^2/4$  at the point  $(-2c, -|c|)$ . The solution  $y = cx + c^2$  is plotted for  $c = \dots, -1/4, 0, 1/4, \dots$  in Figure 18.1.

The envelope of a one-parameter family  $F(x, y, c) = 0$  is given by the system of equations,

$$F(x, y, c) = 0, \quad F_c(x, y, c) = 0.$$

For the family of solutions  $y = cx + c^2$  these equations are

$$y = cx + c^2, \quad 0 = x + 2c.$$

Substituting the solution of the second equation,  $c = -x/2$ , into the first equation gives the envelope,

$$y = \left(-\frac{1}{2}x\right)x + \left(-\frac{1}{2}x\right)^2 = -\frac{1}{4}x^2.$$

Thus we see that the singular solution is the envelope of the general solution.

## Bernoulli Equations

### Solution 18.2

1.

$$\begin{aligned}\frac{dy}{dt} + p(t)y &= q(t)y \\ \frac{dy}{y} &= (q - p) dt \\ \ln y &= \int (q - p) dt + c \\ \boxed{y} &= c e^{\int (q-p) dt}\end{aligned}$$

2. We consider the Bernoulli equation,

$$\frac{dy}{dt} + p(t)y = q(t)y^\alpha, \quad \alpha \neq 1.$$

We divide by  $y^\alpha$ .

$$y^{-\alpha}y' + p(t)y^{1-\alpha} = q(t)$$

This suggests the change of dependent variable  $u = y^{1-\alpha}$ ,  $u' = (1 - \alpha)y^{-\alpha}y'$ .

$$\begin{aligned}\frac{1}{1 - \alpha} \frac{d}{dt} y^{1-\alpha} + p(t)y^{1-\alpha} &= q(t) \\ \frac{du}{dt} + (1 - \alpha)p(t)u &= (1 - \alpha)q(t)\end{aligned}$$

Thus we obtain a linear equation for  $u$  which when solved will give us an implicit solution for  $y$ .



3. (a)

$$t^2 \frac{dy}{dt} + 2ty - y^3 = 0, \quad t > 0$$

$$t^2 \frac{y'}{y^3} + 2t \frac{1}{y^2} = 1$$

We make the change of variables  $u = y^{-2}$ .

$$-\frac{1}{2}t^2 u' + 2tu = 1$$

$$u' - \frac{4}{t}u = -\frac{2}{t^2}$$

The integrating factor is

$$\mu = e^{\int(-4/t)dt} = e^{-4 \ln t} = t^{-4}.$$

We multiply by the integrating factor and integrate to obtain the solution.

$$\frac{d}{dt}(t^{-4}u) = -2t^{-6}$$

$$u = \frac{2}{5}t^{-1} + ct^4$$

$$y^{-2} = \frac{2}{5}t^{-1} + ct^4$$

$$y = \pm \frac{1}{\sqrt{\frac{2}{5}t^{-1} + ct^4}} \quad \boxed{y = \pm \frac{\sqrt{5t}}{\sqrt{2 + ct^5}}}$$

(b)

$$\frac{dy}{dx} + 2xy + y^2 = 0$$

$$\frac{y'}{y^2} + \frac{2x}{y} = -1$$

We make the change of variables  $u = y^{-1}$ .

$$u' - 2xu = 1$$

The integrating factor is

$$\mu = e^{\int (-2x) dx} = e^{-x^2}.$$

We multiply by the integrating factor and integrate to obtain the solution.

$$\frac{d}{dx} \left( e^{-x^2} u \right) = e^{-x^2}$$
$$u = e^{x^2} \int e^{-x^2} dx + c e^{x^2}$$

$$y = \frac{e^{-x^2}}{\int e^{-x^2} dx + c}$$

### Solution 18.3

The differential equation governing the population is

$$\frac{dy}{dt} = y - \frac{y^2}{1000}, \quad y(0) = y_0.$$

We recognize this as a Bernoulli equation. The substitution  $u(t) = 1/y(t)$  yields

$$-\frac{du}{dt} = u - \frac{1}{1000}, \quad u(0) = \frac{1}{y_0}.$$

$$u' + u = \frac{1}{1000}$$

$$u = \frac{1}{y_0} e^{-t} + \frac{e^{-t}}{1000} \int_0^t e^{\tau} d\tau$$

$$u = \frac{1}{1000} + \left( \frac{1}{y_0} - \frac{1}{1000} \right) e^{-t}$$

Solving for  $y(t)$ ,

$$y(t) = \left( \frac{1}{1000} + \left( \frac{1}{y_0} - \frac{1}{1000} \right) e^{-t} \right)^{-1}.$$

As a check, we see that as  $t \rightarrow \infty$ ,  $y(t) \rightarrow 1000$ , which is an equilibrium solution of the differential equation.

$$\frac{dy}{dt} = 0 = y - \frac{y^2}{1000} \rightarrow y = 1000.$$

### Solution 18.4

1.

$$\begin{aligned} t^2 \frac{dy}{dt} + 2ty - y^3 &= 0 \\ \frac{dy}{dt} + 2t^{-1}y &= t^{-2}y^3 \end{aligned}$$

We make the change of variables  $u(t) = y^{-2}(t)$ .

$$u' - 4t^{-1}u = -2t^{-2}$$

This gives us a first order, linear equation. The integrating factor is

$$I(t) = e^{\int -4t^{-1} dt} = e^{-4 \log t} = t^{-4}.$$

We multiply by the integrating factor and integrate.

$$\begin{aligned} \frac{d}{dt} (t^{-4}u) &= -2t^{-6} \\ t^{-4}u &= \frac{2}{5}t^{-5} + c \\ u &= \frac{2}{5}t^{-1} + ct^4 \end{aligned}$$

Finally we write the solution in terms of  $y(t)$ .

$$y(t) = \pm \frac{1}{\sqrt{\frac{2}{5}t^{-1} + ct^4}}$$

$$y(t) = \pm \frac{\sqrt{5t}}{\sqrt{2 + ct^5}}$$

2.

$$\frac{dy}{dt} - (\Gamma \cos t + T) y = -y^3$$

We make the change of variables  $u(t) = y^{-2}(t)$ .

$$u' + 2(\Gamma \cos t + T) u = 2$$

This gives us a first order, linear equation. The integrating factor is

$$I(t) = e^{\int 2(\Gamma \cos t + T) dt} = e^{2(\Gamma \sin t + Tt)}$$

We multiply by the integrating factor and integrate.

$$\begin{aligned} \frac{d}{dt} (e^{2(\Gamma \sin t + Tt)} u) &= 2 e^{2(\Gamma \sin t + Tt)} \\ u &= 2 e^{-2(\Gamma \sin t + Tt)} \left( \int e^{2(\Gamma \sin t + Tt)} dt + c \right) \end{aligned}$$

Finally we write the solution in terms of  $y(t)$ .

$$y = \pm \frac{e^{\Gamma \sin t + Tt}}{\sqrt{2 \left( \int e^{2(\Gamma \sin t + Tt)} dt + c \right)}}$$

## Riccati Equations

### Solution 18.5

We consider the Riccati equation,

$$\frac{dy}{dx} = a(x)y^2 + b(x)y + c(x). \quad (18.5)$$

1. We substitute

$$y = y_p(x) + \frac{1}{u(x)}$$

into the Riccati equation, where  $y_p$  is some particular solution.

$$\begin{aligned} y_p' - \frac{u'}{u^2} &= +a(x) \left( y_p^2 + 2\frac{y_p}{u} + \frac{1}{u^2} \right) + b(x) \left( y_p + \frac{1}{u} \right) + c(x) \\ -\frac{u'}{u^2} &= b(x)\frac{1}{u} + a(x) \left( 2\frac{y_p}{u} + \frac{1}{u^2} \right) \end{aligned}$$

$$\boxed{u' = -(b + 2ay_p)u - a}$$

We obtain a first order linear differential equation for  $u$  whose solution will contain one constant of integration.

2. We consider a Riccati equation,

$$y' = 1 + x^2 - 2xy + y^2. \quad (18.6)$$

We verify that  $y_p(x) = x$  is a solution.

$$1 = 1 + x^2 - 2xx + x^2$$

Substituting  $y = y_p + 1/u$  into Equation 18.6 yields,

$$u' = -(-2x + 2x)u - 1$$

$$u = -x + c$$

$$\boxed{y = x + \frac{1}{c - x}}$$

What would happen if we continued this method? Since  $y = x + \frac{1}{c-x}$  is a solution of the Riccati equation we can make the substitution,

$$y = x + \frac{1}{c-x} + \frac{1}{u(x)}, \quad (18.7)$$

which will lead to a solution for  $y$  which has two constants of integration. Then we could repeat the process, substituting the sum of that solution and  $1/u(x)$  into the Riccati equation to find a solution with three constants of integration. We know that the general solution of a first order, ordinary differential equation has only one constant of integration. Does this method for Riccati equations violate this theorem? There's only one way to find out. We substitute Equation 18.7 into the Riccati equation.

$$\begin{aligned} u' &= - \left( -2x + 2 \left( x + \frac{1}{c-x} \right) \right) u - 1 \\ u' &= - \frac{2}{c-x} u - 1 \\ u' + \frac{2}{c-x} u &= -1 \end{aligned}$$

The integrating factor is

$$I(x) = e^{2/(c-x)} = e^{-2 \log(c-x)} = \frac{1}{(c-x)^2}.$$

Upon multiplying by the integrating factor, the equation becomes exact.

$$\begin{aligned} \frac{d}{dx} \left( \frac{1}{(c-x)^2} u \right) &= - \frac{1}{(c-x)^2} \\ u &= (c-x)^2 \frac{-1}{c-x} + b(c-x)^2 \\ u &= x - c + b(c-x)^2 \end{aligned}$$

Thus the Riccati equation has the solution,

$$y = x + \frac{1}{c-x} + \frac{1}{x - c + b(c-x)^2}.$$

It appears that we we have found a solution that has two constants of integration, but appearances can be deceptive. We do a little algebraic simplification of the solution.

$$y = x + \frac{1}{c-x} + \frac{1}{(b(c-x)-1)(c-x)}$$

$$y = x + \frac{(b(c-x)-1)+1}{(b(c-x)-1)(c-x)}$$

$$y = x + \frac{b}{b(c-x)-1}$$

$$y = x + \frac{1}{(c-1/b)-x}$$

This is actually a solution, (namely the solution we had before), with one constant of integration, (namely  $c-1/b$ ). Thus we see that repeated applications of the procedure will not produce more general solutions.

3. The substitution

$$y = -\frac{u'}{au}$$

gives us the second order, linear, homogeneous differential equation,

$$u'' - \left(\frac{a'}{a} + b\right)u' + acu = 0.$$

The solution to this linear equation is a linear combination of two homogeneous solutions,  $u_1$  and  $u_2$ .

$$u = c_1u_1(x) + c_2u_2(x)$$

The solution of the Ricatti equation is then

$$y = -\frac{c_1u_1'(x) + c_2u_2'(x)}{a(x)(c_1u_1(x) + c_2u_2(x))}.$$

Since we can divide the numerator and denominator by either  $c_1$  or  $c_2$ , this answer has only one constant of integration, (namely  $c_1/c_2$  or  $c_2/c_1$ ).

## Exchanging the Dependent and Independent Variables

### Solution 18.6

Exchanging the dependent and independent variables in the differential equation,

$$y' = \frac{\sqrt{y}}{xy + y},$$

yields

$$x'(y) = y^{1/2}x + y^{1/2}.$$



This is a first order differential equation for  $x(y)$ .

$$x' - y^{1/2}x = y^{1/2}$$
$$\frac{d}{dy} \left[ x \exp \left( -\frac{2y^{3/2}}{3} \right) \right] = y^{1/2} \exp \left( -\frac{2y^{3/2}}{3} \right)$$
$$x \exp \left( -\frac{2y^{3/2}}{3} \right) = -\exp \left( -\frac{2y^{3/2}}{3} \right) + c_1$$

$$x = -1 + c_1 \exp \left( \frac{2y^{3/2}}{3} \right)$$

$$\frac{x+1}{c_1} = \exp \left( \frac{2y^{3/2}}{3} \right)$$

$$\log \left( \frac{x+1}{c_1} \right) = \frac{2}{3} y^{3/2}$$

$$y = \left( \frac{3}{2} \log \left( \frac{x+1}{c_1} \right) \right)^{2/3}$$

$$y = \left( c + \frac{3}{2} \log(x+1) \right)^{2/3}$$

## Autonomous Equations

\*Equidimensional-in-x Equations

\*Equidimensional-in-y Equations

\*Scale-Invariant Equations

# Chapter 19

## Transformations and Canonical Forms

Prize intensity more than extent. Excellence resides in quality not in quantity. The best is always few and rare - abundance lowers value. Even among men, the giants are usually really dwarfs. Some reckon books by the thickness, as if they were written to exercise the brawn more than the brain. Extent alone never rises above mediocrity; it is the misfortune of universal geniuses that in attempting to be at home everywhere are so nowhere. Intensity gives eminence and rises to the heroic in matters sublime.

-Balthasar Gracian

### 19.1 The Constant Coefficient Equation

The solution of any second order linear homogeneous differential equation can be written in terms of the solutions to either

$$y'' = 0, \quad \text{or} \quad y'' - y = 0$$

Consider the general equation

$$y'' + ay' + by = 0.$$

We can solve this differential equation by making the substitution  $y = e^{\lambda x}$ . This yields the algebraic equation

$$\lambda^2 + a\lambda + b = 0.$$

$$\lambda = \frac{1}{2} \left( -a \pm \sqrt{a^2 - 4b} \right)$$

There are two cases to consider. If  $a^2 \neq 4b$  then the solutions are

$$y_1 = e^{(-a + \sqrt{a^2 - 4b})x/2}, \quad y_2 = e^{(-a - \sqrt{a^2 - 4b})x/2}$$

If  $a^2 = 4b$  then we have

$$y_1 = e^{-ax/2}, \quad y_2 = x e^{-ax/2}$$

Note that regardless of the values of  $a$  and  $b$  the solutions are of the form

$$y = e^{-ax/2} u(x)$$

We would like to write the solutions to the general differential equation in terms of the solutions to simpler differential equations. We make the substitution

$$y = e^{\lambda x} u$$

The derivatives of  $y$  are

$$y' = e^{\lambda x} (u' + \lambda u)$$

$$y'' = e^{\lambda x} (u'' + 2\lambda u' + \lambda^2 u)$$

Substituting these into the differential equation yields

$$u'' + (2\lambda + a)u' + (\lambda^2 + a\lambda + b)u = 0$$

In order to get rid of the  $u'$  term we choose

$$\lambda = -\frac{a}{2}.$$

The equation is then

$$u'' + \left( b - \frac{a^2}{4} \right) u = 0.$$

There are now two cases to consider.

**Case 1.** If  $b = a^2/4$  then the differential equation is

$$u'' = 0$$

which has solutions 1 and  $x$ . The general solution for  $y$  is then

$$y = e^{-ax/2}(c_1 + c_2x).$$

**Case 2.** If  $b \neq a^2/4$  then the differential equation is

$$u'' - \left(\frac{a^2}{4} - b\right)u = 0.$$

We make the change variables

$$u(x) = v(\xi), \quad x = \mu\xi.$$

The derivatives in terms of  $\xi$  are

$$\begin{aligned}\frac{d}{dx} &= \frac{d\xi}{dx} \frac{d}{d\xi} = \frac{1}{\mu} \frac{d}{d\xi} \\ \frac{d^2}{dx^2} &= \frac{1}{\mu} \frac{d}{d\xi} \frac{1}{\mu} \frac{d}{d\xi} = \frac{1}{\mu^2} \frac{d^2}{d\xi^2}.\end{aligned}$$

The differential equation for  $v$  is

$$\begin{aligned}\frac{1}{\mu^2}v'' - \left(\frac{a^2}{4} - b\right)v &= 0 \\ v'' - \mu^2 \left(\frac{a^2}{4} - b\right)v &= 0\end{aligned}$$

We choose

$$\mu = \left(\frac{a^2}{4} - b\right)^{-1/2}$$

to obtain

$$v'' - v = 0$$

which has solutions  $e^{\pm\xi}$ . The solution for  $y$  is

$$y = e^{\lambda x} (c_1 e^{x/\mu} + c_2 e^{-x/\mu})$$

$$y = e^{-ax/2} (c_1 e^{\sqrt{a^2/4-b} x} + c_2 e^{-\sqrt{a^2/4-b} x})$$

## 19.2 Normal Form

### 19.2.1 Second Order Equations

Consider the second order equation

$$y'' + p(x)y' + q(x)y = 0. \tag{19.1}$$

Through a change of dependent variable, this equation can be transformed to

$$u'' + I(x)u = 0.$$

This is known as the **normal form** of (19.1). The function  $I(x)$  is known as the **invariant** of the equation.

Now to find the change of variables that will accomplish this transformation. We make the substitution  $y(x) = a(x)u(x)$  in (19.1).

$$au'' + 2a'u' + a''u + p(au' + a'u) + qau = 0$$

$$u'' + \left(2\frac{a'}{a} + p\right)u' + \left(\frac{a''}{a} + \frac{pa'}{a} + q\right)u = 0$$

To eliminate the  $u'$  term,  $a(x)$  must satisfy

$$2\frac{a'}{a} + p = 0$$

$$a' + \frac{1}{2}pa = 0$$

$$a = c \exp\left(-\frac{1}{2} \int p(x) dx\right).$$

For this choice of  $a$ , our differential equation for  $u$  becomes

$$u'' + \left(q - \frac{p^2}{4} - \frac{p'}{2}\right)u = 0.$$

Two differential equations having the same normal form are called **equivalent**.

**Result 19.2.1** The change of variables

$$y(x) = \exp\left(-\frac{1}{2} \int p(x) dx\right) u(x)$$

transforms the differential equation

$$y'' + p(x)y' + q(x)y = 0$$

into its normal form

$$u'' + I(x)u = 0$$

where the invariant of the equation,  $I(x)$ , is

$$I(x) = q - \frac{p^2}{4} - \frac{p'}{2}.$$

## 19.2.2 Higher Order Differential Equations

Consider the third order differential equation

$$y''' + p(x)y'' + q(x)y' + r(x)y = 0.$$

We can eliminate the  $y''$  term. Making the change of dependent variable

$$\begin{aligned}y &= u \exp\left(-\frac{1}{3} \int p(x) \, dx\right) \\y' &= \left[u' - \frac{1}{3}pu\right] \exp\left(-\frac{1}{3} \int p(x) \, dx\right) \\y'' &= \left[u'' - \frac{2}{3}pu' + \frac{1}{9}(p^2 - 3p')u\right] \exp\left(-\frac{1}{3} \int p(x) \, dx\right) \\y''' &= \left[u''' - pu'' + \frac{1}{3}(p^2 - 3p')u' + \frac{1}{27}(9p' - 9p'' - p^3)u\right] \exp\left(-\frac{1}{3} \int p(x) \, dx\right)\end{aligned}$$

yields the differential equation

$$u''' + \frac{1}{3}(3q - 3p' - p^2)u' + \frac{1}{27}(27r - 9pq - 9p'' + 2p^3)u = 0.$$

**Result 19.2.2** The change of variables

$$y(x) = \exp\left(-\frac{1}{n} \int p_{n-1}(x) \, dx\right) u(x)$$

transforms the differential equation

$$y^{(n)} + p_{n-1}(x)y^{(n-1)} + p_{n-2}(x)y^{(n-2)} + \cdots + p_0(x)y = 0$$

into the form

$$u^{(n)} + a_{n-2}(x)u^{(n-2)} + a_{n-3}(x)u^{(n-3)} + \cdots + a_0(x)u = 0.$$

## 19.3 Transformations of the Independent Variable

### 19.3.1 Transformation to the form $u'' + a(x)u = 0$

Consider the second order linear differential equation

$$y'' + p(x)y' + q(x)y = 0.$$

We make the change of independent variable

$$\xi = f(x), \quad u(\xi) = y(x).$$

The derivatives in terms of  $\xi$  are

$$\begin{aligned} \frac{d}{dx} &= \frac{d\xi}{dx} \frac{d}{d\xi} = f' \frac{d}{d\xi} \\ \frac{d^2}{dx^2} &= f' \frac{d}{d\xi} f' \frac{d}{d\xi} = (f')^2 \frac{d^2}{d\xi^2} + f'' \frac{d}{d\xi} \end{aligned}$$

The differential equation becomes

$$(f')^2 u'' + f'' u' + p f' u' + q u = 0.$$

In order to eliminate the  $u'$  term,  $f$  must satisfy

$$\begin{aligned} f'' + p f' &= 0 \\ f' &= \exp\left(-\int p(x) dx\right) \\ f &= \int \exp\left(-\int p(x) dx\right) dx. \end{aligned}$$

The differential equation for  $u$  is then

$$u'' + \frac{q}{(f')^2} u = 0$$



$$u''(\xi) + q(x) \exp\left(2 \int p(x) dx\right) u(\xi) = 0.$$

**Result 19.3.1** The change of variables

$$\xi = \int \exp\left(-\int p(x) dx\right) dx, \quad u(\xi) = y(x)$$

transforms the differential equation

$$y'' + p(x)y' + q(x)y = 0$$

into

$$u''(\xi) + q(x) \exp\left(2 \int p(x) dx\right) u(\xi) = 0.$$

## 19.3.2 Transformation to a Constant Coefficient Equation

Consider the second order linear differential equation

$$y'' + p(x)y' + q(x)y = 0.$$

With the change of independent variable

$$\xi = f(x), \quad u(\xi) = y(x),$$

the differential equation becomes

$$(f')^2 u'' + (f'' + pf')u' + qu = 0.$$

For this to be a constant coefficient equation we must have

$$(f')^2 = c_1 q, \quad \text{and} \quad f'' + pf' = c_2 q,$$

for some constants  $c_1$  and  $c_2$ . Solving the first condition,

$$f' = c\sqrt{q},$$
$$f = c \int \sqrt{q(x)} \, dx.$$

The second constraint becomes

$$\frac{f'' + pf'}{q} = \text{const}$$
$$\frac{\frac{1}{2}cq^{-1/2}q' + pcq^{1/2}}{q} = \text{const}$$
$$\frac{q' + 2pq}{q^{3/2}} = \text{const}.$$

**Result 19.3.2** Consider the differential equation

$$y'' + p(x)y' + q(x)y = 0.$$

If the expression

$$\frac{q' + 2pq}{q^{3/2}}$$

is a constant then the change of variables

$$\xi = c \int \sqrt{q(x)} \, dx, \quad u(\xi) = y(x),$$

will yield a constant coefficient differential equation. (Here  $c$  is an arbitrary constant.)

## 19.4 Integral Equations

**Volterra's Equations.** Volterra's integral equation of the first kind has the form

$$\int_a^x N(x, \xi) f(\xi) d\xi = f(x).$$

The Volterra equation of the second kind is

$$y(x) = f(x) + \lambda \int_a^x N(x, \xi) y(\xi) d\xi.$$

$N(x, \xi)$  is known as the kernel of the equation.

**Fredholm's Equations.** Fredholm's integral equations of the first and second kinds are

$$\int_a^b N(x, \xi) f(\xi) d\xi = f(x),$$

$$y(x) = f(x) + \lambda \int_a^b N(x, \xi) y(\xi) d\xi.$$

### 19.4.1 Initial Value Problems

Consider the initial value problem

$$y'' + p(x)y' + q(x)y = f(x), \quad y(a) = \alpha, \quad y'(a) = \beta.$$

Integrating this equation twice yields

$$\int_a^x \int_a^\eta y''(\xi) + p(\xi)y'(\xi) + q(\xi)y(\xi) d\xi d\eta = \int_a^x \int_a^\eta f(\xi) d\xi d\eta$$

$$\int_a^x (x - \xi)[y''(\xi) + p(\xi)y'(\xi) + q(\xi)y(\xi)] d\xi = \int_a^x (x - \xi)f(\xi) d\xi.$$

Now we use integration by parts.

$$\begin{aligned} & [(x - \xi)y'(\xi)]_a^x - \int_a^x -y'(\xi) d\xi + [(x - \xi)p(\xi)y(\xi)]_a^x - \int_a^x [(x - \xi)p'(\xi) - p(\xi)]y(\xi) d\xi \\ & + \int_a^x (x - \xi)q(\xi)y(\xi) d\xi = \int_a^x (x - \xi)f(\xi) d\xi. \end{aligned}$$

$$\begin{aligned} & - (x - a)y'(a) + y(x) - y(a) - (x - a)p(a)y(a) - \int_a^x [(x - \xi)p'(\xi) - p(\xi)]y(\xi) d\xi \\ & + \int_a^x (x - \xi)q(\xi)y(\xi) d\xi = \int_a^x (x - \xi)f(\xi) d\xi. \end{aligned}$$

We obtain a Volterra integral equation of the second kind for  $y(x)$ .

$$y(x) = \int_a^x (x - \xi)f(\xi) d\xi + (x - a)(\alpha p(a) + \beta) + \alpha + \int_a^x \{(x - \xi)[p'(\xi) - q(\xi)] - p(\xi)\}y(\xi) d\xi.$$

Note that the initial conditions for the differential equation are “built into” the Volterra equation. Setting  $x = a$  in the Volterra equation yields  $y(a) = \alpha$ . Differentiating the Volterra equation,

$$y'(x) = \int_a^x f(\xi) d\xi + (\alpha p(a) + \beta) - p(x)y(x) + \int_a^x [p'(\xi) - q(\xi)] - p(\xi)y(\xi) d\xi$$

and setting  $x = a$  yields

$$y'(a) = \alpha p(a) + \beta - p(a)\alpha = \beta.$$

(Recall from calculus that

$$\frac{d}{dx} \int_a^x g(x, \xi) d\xi = g(x, x) + \int_a^x \frac{\partial}{\partial x} [g(x, \xi)] d\xi.)$$

**Result 19.4.1** The initial value problem

$$y'' + p(x)y' + q(x)y = f(x), \quad y(a) = \alpha, \quad y'(a) = \beta.$$

is equivalent to the Volterra equation of the second kind

$$y(x) = F(x) + \int_a^x N(x, \xi)y(\xi) d\xi$$

where

$$F(x) = \int_a^x (x - \xi)f(\xi) d\xi + (x - a)(\alpha p(a) + \beta) + \alpha$$
$$N(x, \xi) = (x - \xi)[p'(\xi) - q(\xi)] - p(\xi).$$

## 19.4.2 Boundary Value Problems

Consider the boundary value problem

$$y'' = f(x), \quad y(a) = \alpha, \quad y(b) = \beta. \quad (19.2)$$

To obtain a problem with homogeneous boundary conditions, we make the change of variable

$$y(x) = u(x) + \alpha + \frac{\beta - \alpha}{b - a}(x - a)$$

to obtain the problem

$$u'' = f(x), \quad u(a) = u(b) = 0.$$

Now we will use Green's functions to write the solution as an integral. First we solve the problem

$$G'' = \delta(x - \xi), \quad G(a|\xi) = G(b|\xi) = 0.$$

The homogeneous solutions of the differential equation that satisfy the left and right boundary conditions are

$$c_1(x - a) \quad \text{and} \quad c_2(x - b).$$

Thus the Green's function has the form

$$G(x|\xi) = \begin{cases} c_1(x - a), & \text{for } x \leq \xi \\ c_2(x - b), & \text{for } x \geq \xi \end{cases}$$

Imposing continuity of  $G(x|\xi)$  at  $x = \xi$  and a unit jump of  $G(x|\xi)$  at  $x = \xi$ , we obtain

$$G(x|\xi) = \begin{cases} \frac{(x-a)(\xi-b)}{b-a}, & \text{for } x \leq \xi \\ \frac{(x-b)(\xi-a)}{b-a}, & \text{for } x \geq \xi \end{cases}$$

Thus the solution of the (19.2) is

$$y(x) = \alpha + \frac{\beta - \alpha}{b - a}(x - a) + \int_a^b G(x|\xi)f(\xi) \, d\xi.$$

Now consider the boundary value problem

$$y'' + p(x)y' + q(x)y = 0, \quad y(a) = \alpha, \quad y(b) = \beta.$$

From the above result we can see that the solution satisfies

$$y(x) = \alpha + \frac{\beta - \alpha}{b - a}(x - a) + \int_a^b G(x|\xi)[f(\xi) - p(\xi)y'(\xi) - q(\xi)y(\xi)] \, d\xi.$$

Using integration by parts, we can write

$$\begin{aligned} - \int_a^b G(x|\xi)p(\xi)y'(\xi) \, d\xi &= -[G(x|\xi)p(\xi)y(\xi)]_a^b + \int_a^b \left[ \frac{\partial G(x|\xi)}{\partial \xi} p(\xi) + G(x|\xi)p'(\xi) \right] y(\xi) \, d\xi \\ &= \int_a^b \left[ \frac{\partial G(x|\xi)}{\partial \xi} p(\xi) + G(x|\xi)p'(\xi) \right] y(\xi) \, d\xi. \end{aligned}$$

Substituting this into our expression for  $y(x)$ ,

$$y(x) = \alpha + \frac{\beta - \alpha}{b - a}(x - a) + \int_a^b G(x|\xi)f(\xi) d\xi + \int_a^b \left[ \frac{\partial G(x|\xi)}{\partial \xi} p(\xi) + G(x|\xi)[p'(\xi) - q(\xi)] \right] y(\xi) d\xi,$$

we obtain a Fredholm integral equation of the second kind.

**Result 19.4.2** The boundary value problem

$$y'' + p(x)y' + q(x)y = f(x), \quad y(a) = \alpha, \quad y(b) = \beta.$$

is equivalent to the Fredholm equation of the second kind

$$y(x) = F(x) + \int_a^b N(x, \xi)y(\xi) d\xi$$

where

$$F(x) = \alpha + \frac{\beta - \alpha}{b - a}(x - a) + \int_a^b G(x|\xi)f(\xi) d\xi,$$

$$N(x, \xi) = \int_a^b H(x|\xi)y(\xi) d\xi,$$

$$G(x|\xi) = \begin{cases} \frac{(x-a)(\xi-b)}{b-a}, & \text{for } x \leq \xi \\ \frac{(x-b)(\xi-a)}{b-a}, & \text{for } x \geq \xi, \end{cases}$$

$$H(x|\xi) = \begin{cases} \frac{(x-a)}{b-a}p(\xi) + \frac{(x-a)(\xi-b)}{b-a}[p'(\xi) - q(\xi)] & \text{for } x \leq \xi \\ \frac{(x-b)}{b-a}p(\xi) + \frac{(x-b)(\xi-a)}{b-a}[p'(\xi) - q(\xi)] & \text{for } x \geq \xi. \end{cases}$$

## 19.5 Exercises

### The Constant Coefficient Equation Normal Form

#### Exercise 19.1

Solve the differential equation

$$y'' + \left(2 + \frac{4}{3}x\right)y' + \frac{1}{9}(24 + 12x + 4x^2)y = 0.$$

Hint, Solution

### Transformations of the Independent Variable Integral Equations

#### Exercise 19.2

Show that the solution of the differential equation

$$y'' + 2(a + bx)y' + (c + dx + ex^2)y = 0$$

can be written in terms of one of the following canonical forms:

$$v'' + (\xi^2 + A)v = 0$$

$$v'' = \xi v$$

$$v'' + v = 0$$

$$v'' = 0.$$

Hint, Solution

#### Exercise 19.3

Show that the solution of the differential equation

$$y'' + 2\left(a + \frac{b}{x}\right)y' + \left(c + \frac{d}{x} + \frac{e}{x^2}\right)y = 0$$



can be written in terms of one of the following canonical forms:

$$v'' + \left(1 + \frac{A}{\xi} + \frac{B}{\xi^2}\right)v = 0$$

$$v'' + \left(\frac{1}{\xi} + \frac{A}{\xi^2}\right)v = 0$$

$$v'' + \frac{A}{\xi^2}v = 0$$

**Hint, Solution**

### Exercise 19.4

Show that the second order Euler equation

$$x^2 \frac{d^2y}{dx^2} + a_1x \frac{dy}{dx} + a_0y = 0$$

can be transformed to a constant coefficient equation.

**Hint, Solution**

### Exercise 19.5

Solve Bessel's equation of order  $1/2$ ,

$$y'' + \frac{1}{x}y' + \left(1 - \frac{1}{4x^2}\right)y = 0.$$

**Hint, Solution**

## 19.6 Hints

### The Constant Coefficient Equation Normal Form

#### Hint 19.1

Transform the equation to normal form.

### Transformations of the Independent Variable Integral Equations

#### Hint 19.2

Transform the equation to normal form and then apply the scale transformation  $x = \lambda\xi + \mu$ .

#### Hint 19.3

Transform the equation to normal form and then apply the scale transformation  $x = \lambda\xi$ .

#### Hint 19.4

Make the change of variables  $x = e^t$ ,  $y(x) = u(t)$ . Write the derivatives with respect to  $x$  in terms of  $t$ .

$$\begin{aligned}x &= e^t \\dx &= e^t dt \\ \frac{d}{dx} &= e^{-t} \frac{d}{dt} \\ x \frac{d}{dx} &= \frac{d}{dt}\end{aligned}$$

#### Hint 19.5

Transform the equation to normal form.

## 19.7 Solutions

### The Constant Coefficient Equation Normal Form

#### Solution 19.1

$$y'' + \left(2 + \frac{4}{3}x\right) y' + \frac{1}{9} (24 + 12x + 4x^2) y = 0$$

To transform the equation to normal form we make the substitution

$$\begin{aligned} y &= \exp\left(-\frac{1}{2} \int \left(2 + \frac{4}{3}x\right) dx\right) u \\ &= e^{-x-x^2/3} u \end{aligned}$$

The invariant of the equation is

$$\begin{aligned} I(x) &= \frac{1}{9} (24 + 12x + 4x^2) - \frac{1}{4} \left(2 + \frac{4}{3}x\right)^2 - \frac{1}{2} \frac{d}{dx} \left(2 + \frac{4}{3}x\right) \\ &= 1. \end{aligned}$$

The normal form of the differential equation is then

$$u'' + u = 0$$

which has the general solution

$$u = c_1 \cos x + c_2 \sin x$$

Thus the equation for  $y$  has the general solution

$$\boxed{y = c_1 e^{-x-x^2/3} \cos x + c_2 e^{-x-x^2/3} \sin x.}$$

## Transformations of the Independent Variable

### Integral Equations

#### Solution 19.2

The substitution that will transform the equation to normal form is

$$\begin{aligned}y &= \exp\left(-\frac{1}{2} \int 2(a + bx) \, dx\right) u \\ &= e^{-ax - bx^2/2} u.\end{aligned}$$

The invariant of the equation is

$$\begin{aligned}I(x) &= c + dx + ex^2 - \frac{1}{4}(2(a + bx))^2 - \frac{1}{2} \frac{d}{dx}(2(a + bx)) \\ &= c - b - a^2 + (d - 2ab)x + (e - b^2)x^2 \\ &\equiv \alpha + \beta x + \gamma x^2\end{aligned}$$

The normal form of the differential equation is

$$u'' + (\alpha + \beta x + \gamma x^2)u = 0$$

We consider the following cases:

$$\gamma = 0.$$

$$\beta = 0.$$

$\alpha = 0$ . We immediately have the equation

$$u'' = 0.$$

$\alpha \neq 0$ . With the change of variables

$$v(\xi) = u(x), \quad x = \alpha^{-1/2}\xi,$$

we obtain

$$v'' + v = 0.$$

$\beta \neq 0$ . We have the equation

$$y'' + (\alpha + \beta x)y = 0.$$

The scale transformation  $x = \lambda\xi + \mu$  yields

$$v'' + \lambda^2(\alpha + \beta(\lambda\xi + \mu))y = 0$$

$$v'' = [\beta\lambda^3\xi + \lambda^2(\beta\mu + \alpha)]v.$$

Choosing

$$\lambda = (-\beta)^{-1/3}, \quad \mu = -\frac{\alpha}{\beta}$$

yields the differential equation

$$v'' = \xi v.$$

$\gamma \neq 0$ . The scale transformation  $x = \lambda\xi + \mu$  yields

$$v'' + \lambda^2[\alpha + \beta(\lambda\xi + \mu) + \gamma(\lambda\xi + \mu)^2]v = 0$$

$$v'' + \lambda^2[\alpha + \beta\mu + \gamma\mu^2 + \lambda(\beta + 2\gamma\mu)\xi + \lambda^2\gamma\xi^2]v = 0.$$

Choosing

$$\lambda = \gamma^{-1/4}, \quad \mu = -\frac{\beta}{2\gamma}$$

yields the differential equation

$$v'' + (\xi^2 + A)v = 0$$

where

$$A = \gamma^{-1/2} - \frac{1}{4}\beta\gamma^{-3/2}.$$

### Solution 19.3

The substitution that will transform the equation to normal form is

$$\begin{aligned}y &= \exp\left(-\frac{1}{2} \int 2\left(a + \frac{b}{x}\right) dx\right) u \\ &= x^{-b} e^{-ax} u.\end{aligned}$$

The invariant of the equation is

$$\begin{aligned}I(x) &= c + \frac{d}{x} + \frac{e}{x^2} - \frac{1}{4} \left(2\left(a + \frac{b}{x}\right)\right)^2 - \frac{1}{2} \frac{d}{dx} \left(2\left(a + \frac{b}{x}\right)\right) \\ &= c - a^2 + \frac{d - 2ab}{x} + \frac{e + b - b^2}{x^2} \\ &\equiv \alpha + \frac{\beta}{x} + \frac{\gamma}{x^2}.\end{aligned}$$

The invariant form of the differential equation is

$$u'' + \left(\alpha + \frac{\beta}{x} + \frac{\gamma}{x^2}\right) u = 0.$$

We consider the following cases:

$$\alpha = 0.$$

$\beta = 0$ . We immediately have the equation

$$u'' + \frac{\gamma}{x^2} u = 0.$$

$\beta \neq 0$ . We have the equation

$$u'' + \left(\frac{\beta}{x} + \frac{\gamma}{x^2}\right) u = 0.$$

The scale transformation  $u(x) = v(\xi)$ ,  $x = \lambda\xi$  yields

$$v'' + \left( \frac{\beta\lambda}{\xi} + \frac{\gamma}{\xi^2} \right) u = 0.$$

Choosing  $\lambda = \beta^{-1}$ , we obtain

$$v'' + \left( \frac{1}{\xi} + \frac{\gamma}{\xi^2} \right) u = 0.$$

$\alpha \neq 0$ . The scale transformation  $x = \lambda\xi$  yields

$$v'' + \left( \alpha\lambda^2 + \frac{\beta\lambda}{\xi} + \frac{\gamma}{\xi^2} \right) v = 0.$$

Choosing  $\lambda = \alpha^{-1/2}$ , we obtain

$$v'' + \left( 1 + \frac{\alpha^{-1/2}\beta}{\xi} + \frac{\gamma}{\xi^2} \right) v = 0.$$

#### **Solution 19.4**

We write the derivatives with respect to  $x$  in terms of  $t$ .

$$\begin{aligned}x &= e^t \\dx &= e^t dt \\ \frac{d}{dx} &= e^{-t} \frac{d}{dt} \\ x \frac{d}{dx} &= \frac{d}{dt}\end{aligned}$$

Now we express  $x^2 \frac{d^2}{dx^2}$  in terms of  $t$ .

$$x^2 \frac{d^2}{dx^2} = x \frac{d}{dx} \left( x \frac{d}{dx} \right) - x \frac{d}{dx} = \frac{d^2}{dt^2} - \frac{d}{dt}$$

Thus under the change of variables,  $x = e^t$ ,  $y(x) = u(t)$ , the Euler equation becomes

$$u'' - u' + a_1 u' + a_0 u = 0$$
$$\boxed{u'' + (a_1 - 1)u' + a_0 u = 0.}$$

### Solution 19.5

The transformation

$$y = \exp\left(-\frac{1}{2} \int \frac{1}{x} dx\right) = x^{-1/2} u$$

will put the equation in normal form. The invariant is

$$I(x) = \left(1 - \frac{1}{4x^2}\right) - \frac{1}{4} \left(\frac{1}{x^2}\right) - \frac{1-1}{2x^2} = 1.$$

Thus we have the differential equation

$$u'' + u = 0,$$

with the solution

$$u = c_1 \cos x + c_2 \sin x.$$

The solution of Bessel's equation of order  $1/2$  is

$$\boxed{y = c_1 x^{-1/2} \cos x + c_2 x^{-1/2} \sin x.}$$



# Chapter 20

## The Dirac Delta Function

I do not know what I appear to the world; but to myself I seem to have been only like a boy playing on a seashore, and diverting myself now and then by finding a smoother pebble or a prettier shell than ordinary, whilst the great ocean of truth lay all undiscovered before me.

- Sir Issac Newton

### 20.1 Derivative of the Heaviside Function

The Heaviside function  $H(x)$  is defined

$$H(x) = \begin{cases} 0 & \text{for } x < 0, \\ 1 & \text{for } x > 0. \end{cases}$$

The derivative of the Heaviside function is zero for  $x \neq 0$ . At  $x = 0$  the derivative is undefined. We will represent the derivative of the Heaviside function by the Dirac delta function,  $\delta(x)$ . The delta function is zero for  $x \neq 0$  and infinite at the point  $x = 0$ . Since the derivative of  $H(x)$  is undefined,  $\delta(x)$  is not a function in the conventional sense of the word. One can derive the properties of the delta function rigorously, but the treatment in this text will be almost entirely heuristic.

The Dirac delta function is defined by the properties

$$\delta(x) = \begin{cases} 0 & \text{for } x \neq 0, \\ \infty & \text{for } x = 0, \end{cases} \quad \text{and} \quad \int_{-\infty}^{\infty} \delta(x) \, dx = 1.$$

The second property comes from the fact that  $\delta(x)$  represents the derivative of  $H(x)$ . The Dirac delta function is conceptually pictured in Figure 20.1.

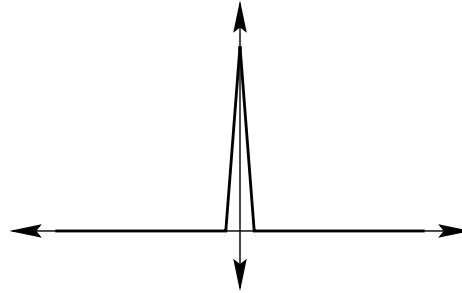

Figure 20.1: The Dirac Delta Function.

Let  $f(x)$  be a continuous function that vanishes at infinity. Consider the integral

$$\int_{-\infty}^{\infty} f(x)\delta(x) \, dx.$$

We use integration by parts to evaluate the integral.

$$\begin{aligned}\int_{-\infty}^{\infty} f(x)\delta(x) dx &= [f(x)H(x)]_{-\infty}^{\infty} - \int_{-\infty}^{\infty} f'(x)H(x) dx \\ &= - \int_0^{\infty} f'(x) dx \\ &= [-f(x)]_0^{\infty} \\ &= f(0)\end{aligned}$$

We assumed that  $f(x)$  vanishes at infinity in order to use integration by parts to evaluate the integral. However, since the delta function is zero for  $x \neq 0$ , the integrand is nonzero only at  $x = 0$ . Thus the behavior of the function at infinity should not affect the value of the integral. Thus it is reasonable that  $f(0) = \int_{-\infty}^{\infty} f(x)\delta(x) dx$  holds for all continuous functions. By changing variables and noting that  $\delta(x)$  is symmetric we can derive a more general formula.

$$\begin{aligned}f(0) &= \int_{-\infty}^{\infty} f(\xi)\delta(\xi) d\xi \\ f(x) &= \int_{-\infty}^{\infty} f(\xi + x)\delta(\xi) d\xi \\ f(x) &= \int_{-\infty}^{\infty} f(\xi)\delta(\xi - x) d\xi \\ f(x) &= \int_{-\infty}^{\infty} f(\xi)\delta(x - \xi) d\xi\end{aligned}$$

This formula is very important in solving inhomogeneous differential equations.

## 20.2 The Delta Function as a Limit

Consider a function  $b(x, \epsilon)$  defined by

$$b(x, \epsilon) = \begin{cases} 0 & \text{for } |x| > \epsilon/2 \\ \frac{1}{\epsilon} & \text{for } |x| < \epsilon/2. \end{cases}$$

The graph of  $b(x, 1/10)$  is shown in Figure 20.2.

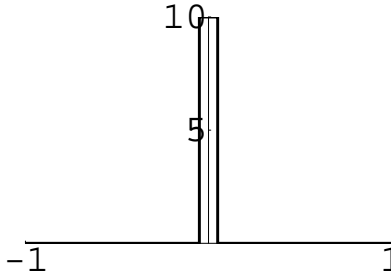

Figure 20.2: Graph of  $b(x, 1/10)$ .

The Dirac delta function  $\delta(x)$  can be thought of as  $b(x, \epsilon)$  in the limit as  $\epsilon \rightarrow 0$ . Note that the delta function so defined satisfies the properties,

$$\delta(x) = \begin{cases} 0 & \text{for } x \neq 0 \\ \infty & \text{for } x = 0 \end{cases} \quad \text{and} \quad \int_{-\infty}^{\infty} \delta(x) dx = 1$$

**Delayed Limiting Process.** When the Dirac delta function appears inside an integral, we can think of the delta function as a delayed limiting process.

$$\int_{-\infty}^{\infty} f(x)\delta(x) dx \equiv \lim_{\epsilon \rightarrow 0} \int_{-\infty}^{\infty} f(x)b(x, \epsilon) dx.$$

Let  $f(x)$  be a continuous function and let  $F'(x) = f(x)$ . We compute the integral of  $f(x)\delta(x)$ .

$$\begin{aligned}\int_{-\infty}^{\infty} f(x)\delta(x) dx &= \lim_{\epsilon \rightarrow 0} \frac{1}{\epsilon} \int_{-\epsilon/2}^{\epsilon/2} f(x) dx \\ &= \lim_{\epsilon \rightarrow 0} \frac{1}{\epsilon} [F(x)]_{-\epsilon/2}^{\epsilon/2} \\ &= \lim_{\epsilon \rightarrow 0} \frac{F(\epsilon/2) - F(-\epsilon/2)}{\epsilon} \\ &= F'(0) \\ &= f(0)\end{aligned}$$

## 20.3 Higher Dimensions

We can define a Dirac delta function in  $n$ -dimensional Cartesian space,  $\delta_n(\mathbf{x})$ ,  $\mathbf{x} \in \mathbb{R}^n$ . It is defined by the following two properties.

$$\begin{aligned}\delta_n(\mathbf{x}) &= 0 \quad \text{for } \mathbf{x} \neq \mathbf{0} \\ \int_{\mathbb{R}^n} \delta_n(\mathbf{x}) d\mathbf{x} &= 1\end{aligned}$$

It is easy to verify, that the  $n$ -dimensional Dirac delta function can be written as a product of 1-dimensional Dirac delta functions.

$$\delta_n(\mathbf{x}) = \prod_{k=1}^n \delta(x_k)$$

## 20.4 Non-Rectangular Coordinate Systems

We can derive Dirac delta functions in non-rectangular coordinate systems by making a change of variables in the relation,

$$\int_{\mathbb{R}^n} \delta_n(\mathbf{x}) \, d\mathbf{x} = 1$$

Where the transformation is non-singular, one merely divides the Dirac delta function by the Jacobian of the transformation to the coordinate system.

**Example 20.4.1** Consider the Dirac delta function in cylindrical coordinates,  $(r, \theta, z)$ . The Jacobian is  $J = r$ .

$$\int_{-\infty}^{\infty} \int_0^{2\pi} \int_0^{\infty} \delta_3(\mathbf{x} - \mathbf{x}_0) r \, dr \, d\theta \, dz = 1$$

For  $r_0 \neq 0$ , the Dirac Delta function is

$$\delta_3(\mathbf{x} - \mathbf{x}_0) = \frac{1}{r} \delta(r - r_0) \delta(\theta - \theta_0) \delta(z - z_0)$$

since it satisfies the two defining properties.

$$\frac{1}{r} \delta(r - r_0) \delta(\theta - \theta_0) \delta(z - z_0) = 0 \quad \text{for } (r, \theta, z) \neq (r_0, \theta_0, z_0)$$

$$\begin{aligned} \int_{-\infty}^{\infty} \int_0^{2\pi} \int_0^{\infty} \frac{1}{r} \delta(r - r_0) \delta(\theta - \theta_0) \delta(z - z_0) r \, dr \, d\theta \, dz \\ = \int_0^{\infty} \delta(r - r_0) \, dr \int_0^{2\pi} \delta(\theta - \theta_0) \, d\theta \int_{-\infty}^{\infty} \delta(z - z_0) \, dz = 1 \end{aligned}$$

For  $r_0 = 0$ , we have

$$\delta_3(\mathbf{x} - \mathbf{x}_0) = \frac{1}{2\pi r} \delta(r) \delta(z - z_0)$$

since this again satisfies the two defining properties.

$$\frac{1}{2\pi r} \delta(r) \delta(z - z_0) = 0 \quad \text{for } (r, z) \neq (0, z_0)$$
$$\int_{-\infty}^{\infty} \int_0^{2\pi} \int_0^{\infty} \frac{1}{2\pi r} \delta(r) \delta(z - z_0) r \, dr \, d\theta \, dz = \frac{1}{2\pi} \int_0^{\infty} \delta(r) \, dr \int_0^{2\pi} d\theta \int_{-\infty}^{\infty} \delta(z - z_0) \, dz = 1$$

## 20.5 Exercises

### Exercise 20.1

Let  $f(x)$  be a function that is continuous except for a jump discontinuity at  $x = 0$ . Using a delayed limiting process, show that

$$\frac{f(0^-) + f(0^+)}{2} = \int_{-\infty}^{\infty} f(x)\delta(x) dx.$$

Hint, Solution

### Exercise 20.2

Show that the Dirac delta function is symmetric.

$$\delta(-x) = \delta(x)$$

Hint, Solution

### Exercise 20.3

Show that

$$\delta(cx) = \frac{\delta(x)}{|c|}.$$

Hint, Solution

### Exercise 20.4

We will consider the Dirac delta function with a function as an argument,  $\delta(y(x))$ . Assume that  $y(x)$  has simple zeros at the points  $\{x_n\}$ .

$$y(x_n) = 0, \quad y'(x_n) \neq 0$$

Further assume that  $y(x)$  has no multiple zeros. (If  $y(x)$  has multiple zeros  $\delta(y(x))$  is not well-defined in the same sense that  $1/0$  is not well-defined.) Prove that

$$\delta(y(x)) = \sum_n \frac{\delta(x - x_n)}{|y'(x_n)|}.$$

Hint, Solution



### Exercise 20.5

Justify the identity

$$\int_{-\infty}^{\infty} f(x) \delta^{(n)}(x) dx = (-1)^n f^{(n)}(0)$$

From this show that

$$\delta^{(n)}(-x) = (-1)^n \delta^{(n)}(x) \quad \text{and} \quad x \delta^{(n)}(x) = -n \delta^{(n-1)}(x).$$

Hint, Solution

### Exercise 20.6

Consider  $\mathbf{x} = (x_1, \dots, x_n) \in \mathbb{R}^n$  and the curvilinear coordinate system  $\boldsymbol{\xi} = (\xi_1, \dots, \xi_n)$ . Show that

$$\delta(\mathbf{x} - \mathbf{a}) = \frac{\delta(\boldsymbol{\xi} - \boldsymbol{\alpha})}{|J|}$$

where  $\mathbf{a}$  and  $\boldsymbol{\alpha}$  are corresponding points in the two coordinate systems and  $J$  is the Jacobian of the transformation from  $\mathbf{x}$  to  $\boldsymbol{\xi}$ .

$$J \equiv \frac{\partial \mathbf{x}}{\partial \boldsymbol{\xi}}$$

Hint, Solution

### Exercise 20.7

Determine the Dirac delta function in spherical coordinates,  $(r, \theta, \phi)$ .

$$x = r \cos \theta \sin \phi, \quad y = r \sin \theta \sin \phi, \quad z = r \cos \phi$$

Hint, Solution

## 20.6 Hints

### Hint 20.1

### Hint 20.2

Verify that  $\delta(-x)$  satisfies the two properties of the Dirac delta function.

### Hint 20.3

Evaluate the integral,

$$\int_{-\infty}^{\infty} f(x)\delta(cx) dx,$$

by noting that the Dirac delta function is symmetric and making a change of variables.

### Hint 20.4

Let the points  $\{\xi_m\}$  partition the interval  $(-\infty \dots \infty)$  such that  $y'(x)$  is monotone on each interval  $(\xi_m \dots \xi_{m+1})$ . Consider some such interval,  $(a \dots b) \equiv (\xi_m \dots \xi_{m+1})$ . Show that

$$\int_a^b \delta(y(x)) dx = \begin{cases} \int_{\alpha}^{\beta} \frac{\delta(y)}{|y'(x_n)|} dy & \text{if } y(x_n) = 0 \text{ for } a < x_n < b \\ 0 & \text{otherwise} \end{cases}$$

for  $\alpha = \min(y(a), y(b))$  and  $\beta = \max(y(a), y(b))$ . Now consider the integral on the interval  $(-\infty \dots \infty)$  as the sum of integrals on the intervals  $\{(\xi_m \dots \xi_{m+1})\}$ .

### Hint 20.5

Justify the identity,

$$\int_{-\infty}^{\infty} f(x)\delta^{(n)}(x) dx = (-1)^n f^{(n)}(0),$$

with integration by parts.

**Hint 20.6**

The Dirac delta function is defined by the following two properties.

$$\delta(\mathbf{x} - \mathbf{a}) = 0 \quad \text{for } \mathbf{x} \neq \mathbf{a}$$
$$\int_{\mathbb{R}^n} \delta(\mathbf{x} - \mathbf{a}) \, d\mathbf{x} = 1$$

Verify that  $\delta(\boldsymbol{\xi} - \boldsymbol{\alpha})/|J|$  satisfies these properties in the  $\boldsymbol{\xi}$  coordinate system.

**Hint 20.7**

Consider the special cases  $\phi_0 = 0, \pi$  and  $r_0 = 0$ .

## 20.7 Solutions

### Solution 20.1

Let  $F'(x) = f(x)$ .

$$\begin{aligned}\int_{-\infty}^{\infty} f(x)\delta(x) dx &= \lim_{\epsilon \rightarrow 0} \frac{1}{\epsilon} \int_{-\infty}^{\infty} f(x)b(x, \epsilon) dx \\ &= \lim_{\epsilon \rightarrow 0} \frac{1}{\epsilon} \left( \int_{-\epsilon/2}^0 f(x)b(x, \epsilon) dx + \int_0^{\epsilon/2} f(x)b(x, \epsilon) dx \right) \\ &= \lim_{\epsilon \rightarrow 0} \frac{1}{\epsilon} ((F(0) - F(-\epsilon/2)) + (F(\epsilon/2) - F(0))) \\ &= \lim_{\epsilon \rightarrow 0} \frac{1}{2} \left( \frac{F(0) - F(-\epsilon/2)}{\epsilon/2} + \frac{F(\epsilon/2) - F(0)}{\epsilon/2} \right) \\ &= \frac{F'(0^-) + F'(0^+)}{2} \\ &= \frac{f(0^-) + f(0^+)}{2}\end{aligned}$$

### Solution 20.2

$\delta(-x)$  satisfies the two properties of the Dirac delta function.

$$\begin{aligned}\delta(-x) &= 0 \text{ for } x \neq 0 \\ \int_{-\infty}^{\infty} \delta(-x) dx &= \int_{\infty}^{-\infty} \delta(x) (-dx) = \int_{-\infty}^{\infty} \delta(-x) dx = 1\end{aligned}$$

Therefore  $\delta(-x) = \delta(x)$ .

### Solution 20.3

We note the the Dirac delta function is symmetric and we make a change of variables to derive the identity.

$$\begin{aligned}\int_{-\infty}^{\infty} \delta(cx) dx &= \int_{-\infty}^{\infty} \delta(|c|x) dx \\ &= \int_{-\infty}^{\infty} \frac{\delta(x)}{|c|} dx\end{aligned}$$

$$\boxed{\delta(cx) = \frac{\delta(x)}{|c|}}$$

### Solution 20.4

Let the points  $\{\xi_m\}$  partition the interval  $(-\infty \dots \infty)$  such that  $y'(x)$  is monotone on each interval  $(\xi_m \dots \xi_{m+1})$ . Consider some such interval,  $(a \dots b) \equiv (\xi_m \dots \xi_{m+1})$ . Note that  $y'(x)$  is either entirely positive or entirely negative in the interval. First consider the case when it is positive. In this case  $y(a) < y(b)$ .

$$\begin{aligned}\int_a^b \delta(y(x)) dx &= \int_{y(a)}^{y(b)} \delta(y) \left(\frac{dy}{dx}\right)^{-1} dy \\ &= \int_{y(a)}^{y(b)} \frac{\delta(y)}{y'(x)} dy \\ &= \begin{cases} \int_{y(a)}^{y(b)} \frac{\delta(y)}{y'(x_n)} dy & \text{for } y(x_n) = 0 \text{ if } y(a) < 0 < y(b) \\ 0 & \text{otherwise} \end{cases}\end{aligned}$$

Now consider the case that  $y'(x)$  is negative on the interval so  $y(a) > y(b)$ .

$$\begin{aligned}
 \int_a^b \delta(y(x)) \, dx &= \int_{y(a)}^{y(b)} \delta(y) \left( \frac{dy}{dx} \right)^{-1} \, dy \\
 &= \int_{y(a)}^{y(b)} \frac{\delta(y)}{y'(x)} \, dy \\
 &= \int_{y(b)}^{y(a)} \frac{\delta(y)}{-y'(x)} \, dy \\
 &= \begin{cases} \int_{y(b)}^{y(a)} \frac{\delta(y)}{-y'(x_n)} \, dy & \text{for } y(x_n) = 0 \text{ if } y(b) < 0 < y(a) \\ 0 & \text{otherwise} \end{cases}
 \end{aligned}$$

We conclude that

$$\int_a^b \delta(y(x)) \, dx = \begin{cases} \int_{\alpha}^{\beta} \frac{\delta(y)}{|y'(x_n)|} \, dy & \text{if } y(x_n) = 0 \text{ for } a < x_n < b \\ 0 & \text{otherwise} \end{cases}$$

for  $\alpha = \min(y(a), y(b))$  and  $\beta = \max(y(a), y(b))$ .

Now we turn to the integral of  $\delta(y(x))$  on  $(-\infty \dots \infty)$ . Let  $\alpha_m = \min(y(\xi_m), y(\xi_{m+1}))$  and  $\beta_m = \max(y(\xi_m), y(\xi_{m+1}))$ .

$$\begin{aligned}
 \int_{-\infty}^{\infty} \delta(y(x)) \, dx &= \sum_m \int_{\xi_m}^{\xi_{m+1}} \delta(y(x)) \, dx \\
 &= \sum_{x_n \in (\xi_m \dots \xi_{m+1})} \int_{\xi_m}^{\xi_{m+1}} \delta(y(x)) \, dx \\
 &= \sum_{x_n \in (\xi_m \dots \xi_{m+1})} \int_{\alpha_m}^{\beta_{m+1}} \frac{\delta(y)}{|y'(x_n)|} \, dy \\
 &= \sum_n \int_{-\infty}^{\infty} \frac{\delta(y)}{|y'(x_n)|} \, dy \\
 &= \int_{-\infty}^{\infty} \sum_n \frac{\delta(y)}{|y'(x_n)|} \, dy
 \end{aligned}$$

$$\boxed{\delta(y(x)) = \sum_n \frac{\delta(x - x_n)}{|y'(x_n)|}}$$

### Solution 20.5

To justify the identity,

$$\int_{-\infty}^{\infty} f(x) \delta^{(n)}(x) \, dx = (-1)^n f^{(n)}(0),$$

we will use integration by parts.

$$\begin{aligned}\int_{-\infty}^{\infty} f(x)\delta^{(n)}(x) dx &= [f(x)\delta^{(n-1)}(x)]_{-\infty}^{\infty} - \int_{-\infty}^{\infty} f'(x)\delta^{(n-1)}(x) dx \\ &= - \int_{-\infty}^{\infty} f'(x)\delta^{(n-1)}(x) dx \\ &= (-1)^n \int_{-\infty}^{\infty} f^{(n)}(x)\delta(x) dx \\ &= (-1)^n f^{(n)}(0)\end{aligned}$$

CONTINUE HERE

$$\delta^{(n)}(-x) = (-1)^n \delta^{(n)}(x) \quad \text{and} \quad x\delta^{(n)}(x) = -n\delta^{(n-1)}(x).$$

### Solution 20.6

The Dirac delta function is defined by the following two properties.

$$\begin{aligned}\delta(\mathbf{x} - \mathbf{a}) &= 0 \quad \text{for } \mathbf{x} \neq \mathbf{a} \\ \int_{\mathbb{R}^n} \delta(\mathbf{x} - \mathbf{a}) d\mathbf{x} &= 1\end{aligned}$$

We verify that  $\delta(\boldsymbol{\xi} - \boldsymbol{\alpha})/|J|$  satisfies these properties in the  $\boldsymbol{\xi}$  coordinate system.

$$\begin{aligned}\frac{\delta(\boldsymbol{\xi} - \boldsymbol{\alpha})}{|J|} &= \frac{\delta(\xi_1 - \alpha_1) \cdots \delta(\xi_n - \alpha_n)}{|J|} \\ &= 0 \quad \text{for } \boldsymbol{\xi} \neq \boldsymbol{\alpha}\end{aligned}$$



$$\begin{aligned}
\int \frac{\delta(\boldsymbol{\xi} - \boldsymbol{\alpha})}{|J|} |J| d\boldsymbol{\xi} &= \int \delta(\boldsymbol{\xi} - \boldsymbol{\alpha}) d\boldsymbol{\xi} \\
&= \int \delta(\xi_1 - \alpha_1) \cdots \delta(\xi_n - \alpha_n) d\boldsymbol{\xi} \\
&= \int \delta(\xi_1 - \alpha_1) d\xi_1 \cdots \int \delta(\xi_n - \alpha_n) d\xi_n \\
&= 1
\end{aligned}$$

We conclude that  $\delta(\boldsymbol{\xi} - \boldsymbol{\alpha})/|J|$  is the Dirac delta function in the  $\boldsymbol{\xi}$  coordinate system.

$$\delta(\mathbf{x} - \mathbf{a}) = \frac{\delta(\boldsymbol{\xi} - \boldsymbol{\alpha})}{|J|}$$

### Solution 20.7

We consider the Dirac delta function in spherical coordinates,  $(r, \theta, \phi)$ . The Jacobian is  $J = r^2 \sin(\phi)$ .

$$\int_0^\pi \int_0^{2\pi} \int_0^\infty \delta_3(\mathbf{x} - \mathbf{x}_0) r^2 \sin(\phi) dr d\theta d\phi = 1$$

For  $r_0 \neq 0$ , and  $\phi_0 \neq 0, \pi$ , the Dirac Delta function is

$$\delta_3(\mathbf{x} - \mathbf{x}_0) = \frac{1}{r^2 \sin(\phi)} \delta(r - r_0) \delta(\theta - \theta_0) \delta(\phi - \phi_0)$$

since it satisfies the two defining properties.

$$\frac{1}{r^2 \sin(\phi)} \delta(r - r_0) \delta(\theta - \theta_0) \delta(\phi - \phi_0) = 0 \quad \text{for } (r, \theta, \phi) \neq (r_0, \theta_0, \phi_0)$$

$$\begin{aligned}
\int_0^\pi \int_0^{2\pi} \int_0^\infty \frac{1}{r^2 \sin(\phi)} \delta(r - r_0) \delta(\theta - \theta_0) \delta(\phi - \phi_0) r^2 \sin(\phi) dr d\theta d\phi \\
= \int_0^\infty \delta(r - r_0) dr \int_0^{2\pi} \delta(\theta - \theta_0) d\theta \int_0^\pi \delta(\phi - \phi_0) d\phi = 1
\end{aligned}$$

For  $\phi_0 = 0$  or  $\phi_0 = \pi$ , the Dirac delta function is

$$\delta_3(\mathbf{x} - \mathbf{x}_0) = \frac{1}{2\pi r^2 \sin(\phi)} \delta(r - r_0) \delta(\phi - \phi_0).$$

We check that the value of the integral is unity.

$$\begin{aligned} \int_0^\pi \int_0^{2\pi} \int_0^\infty \frac{1}{2\pi r^2 \sin(\phi)} \delta(r - r_0) \delta(\phi - \phi_0) r^2 \sin(\phi) dr d\theta d\phi \\ = \frac{1}{2\pi} \int_0^\infty \delta(r - r_0) dr \int_0^{2\pi} d\theta \int_0^\pi \delta(\phi - \phi_0) d\phi = 1 \end{aligned}$$

For  $r_0 = 0$  the Dirac delta function is

$$\delta_3(\mathbf{x}) = \frac{1}{4\pi r^2} \delta(r)$$

We verify that the value of the integral is unity.

$$\int_0^\pi \int_0^{2\pi} \int_0^\infty \frac{1}{4\pi r^2} \delta(r - r_0) r^2 \sin(\phi) dr d\theta d\phi = \frac{1}{4\pi} \int_0^\infty \delta(r) dr \int_0^{2\pi} d\theta \int_0^\pi \sin(\phi) d\phi = 1$$

# Chapter 21

## Inhomogeneous Differential Equations

Feelin' stupid? I know I am!

-Homer Simpson

### 21.1 Particular Solutions

Consider the  $n^{\text{th}}$  order linear homogeneous equation

$$L[y] \equiv y^{(n)} + p_{n-1}(x)y^{(n-1)} + \cdots + p_1(x)y' + p_0(x)y = 0.$$

Let  $\{y_1, y_2, \dots, y_n\}$  be a set of linearly independent homogeneous solutions,  $L[y_k] = 0$ . We know that the general solution of the homogeneous equation is a linear combination of the homogeneous solutions.

$$y_h = \sum_{k=1}^n c_k y_k(x)$$

Now consider the  $n^{\text{th}}$  order linear *inhomogeneous* equation

$$L[y] \equiv y^{(n)} + p_{n-1}(x)y^{(n-1)} + \cdots + p_1(x)y' + p_0(x)y = f(x).$$

Any function  $y_p$  which satisfies this equation is called a *particular solution* of the differential equation. We want to know the general solution of the inhomogeneous equation. Later in this chapter we will cover methods of constructing this solution; now we consider the form of the solution.

Let  $y_p$  be a particular solution. Note that  $y_p + h$  is a particular solution if  $h$  satisfies the homogeneous equation.

$$L[y_p + h] = L[y_p] + L[h] = f + 0 = f$$

Therefore  $y_p + y_h$  satisfies the homogeneous equation. We show that this is the general solution of the inhomogeneous equation. Let  $y_p$  and  $\eta_p$  both be solutions of the inhomogeneous equation  $L[y] = f$ . The difference of  $y_p$  and  $\eta_p$  is a homogeneous solution.

$$L[y_p - \eta_p] = L[y_p] - L[\eta_p] = f - f = 0$$

$y_p$  and  $\eta_p$  differ by a linear combination of the homogeneous solutions  $\{y_k\}$ . Therefore the general solution of  $L[y] = f$  is the sum of any particular solution  $y_p$  and the general homogeneous solution  $y_h$ .

$$y_p + y_h = y_p(x) + \sum_{k=1}^n c_k y_k(x)$$

**Result 21.1.1** The general solution of the  $n^{\text{th}}$  order linear inhomogeneous equation  $L[y] = f(x)$  is

$$y = y_p + c_1 y_1 + c_2 y_2 + \cdots + c_n y_n,$$

where  $y_p$  is a particular solution,  $\{y_1, \dots, y_n\}$  is a set of linearly independent homogeneous solutions, and the  $c_k$ 's are arbitrary constants.

**Example 21.1.1** *The differential equation*

$$y'' + y = \sin(2x)$$

*has the two homogeneous solutions*

$$y_1 = \cos x, \quad y_2 = \sin x,$$

and a particular solution

$$y_p = -\frac{1}{3} \sin(2x).$$

We can add any combination of the homogeneous solutions to  $y_p$  and it will still be a particular solution. For example,

$$\begin{aligned} \eta_p &= -\frac{1}{3} \sin(2x) - \frac{1}{3} \sin x \\ &= -\frac{2}{3} \sin\left(\frac{3x}{2}\right) \cos\left(\frac{x}{2}\right) \end{aligned}$$

is a particular solution.

## 21.2 Method of Undetermined Coefficients

The first method we present for computing particular solutions is the *method of undetermined coefficients*. For some simple differential equations, (primarily constant coefficient equations), and some simple inhomogeneities we are able to guess the form of a particular solution. This form will contain some unknown parameters. We substitute this form into the differential equation to determine the parameters and thus determine a particular solution.

Later in this chapter we will present general methods which work for any linear differential equation and any inhomogeneity. Thus one might wonder why I would present a method that works only for some simple problems. (And why it is called a “method” if it amounts to no more than guessing.) The answer is that guessing an answer is less grungy than computing it with the formulas we will develop later. Also, the process of this guessing is not random, there is rhyme and reason to it.

Consider an  $n^{\text{th}}$  order constant coefficient, inhomogeneous equation.

$$L[y] \equiv y^{(n)} + a_{n-1}y^{(n-1)} + \cdots + a_1y' + a_0y = f(x)$$

If  $f(x)$  is one of a few simple forms, then we can guess the form of a particular solution. Below we enumerate some cases.

$\mathbf{f} = \mathbf{p}(\mathbf{x})$ . If  $f$  is an  $m^{\text{th}}$  order polynomial,  $f(x) = p_m x^m + \cdots + p_1 x + p_0$ , then guess

$$y_p = c_m x^m + \cdots + c_1 x + c_0.$$

$\mathbf{f} = \mathbf{p}(\mathbf{x}) e^{a\mathbf{x}}$ . If  $f$  is a polynomial times an exponential then guess

$$y_p = (c_m x^m + \cdots + c_1 x + c_0) e^{ax}.$$

$\mathbf{f} = \mathbf{p}(\mathbf{x}) e^{a\mathbf{x}} \cos(\mathbf{b}\mathbf{x})$ . If  $f$  is a cosine or sine times a polynomial and perhaps an exponential,  $f(x) = p(x) e^{ax} \cos(bx)$  or  $f(x) = p(x) e^{ax} \sin(bx)$  then guess

$$y_p = (c_m x^m + \cdots + c_1 x + c_0) e^{ax} \cos(bx) + (d_m x^m + \cdots + d_1 x + d_0) e^{ax} \sin(bx).$$

Likewise for hyperbolic sines and hyperbolic cosines.

**Example 21.2.1** Consider

$$y'' - 2y' + y = t^2.$$

The homogeneous solutions are  $y_1 = e^t$  and  $y_2 = t e^t$ . We guess a particular solution of the form

$$y_p = at^2 + bt + c.$$

We substitute the expression into the differential equation and equate coefficients of powers of  $t$  to determine the parameters.

$$\begin{aligned} y_p'' - 2y_p' + y_p &= t^2 \\ (2a) - 2(2at + b) + (at^2 + bt + c) &= t^2 \\ (a - 1)t^2 + (b - 4a)t + (2a - 2b + c) &= 0 \\ a - 1 = 0, \quad b - 4a = 0, \quad 2a - 2b + c = 0 \\ a = 1, \quad b = 4, \quad c = 6 \end{aligned}$$

A particular solution is

$$y_p = t^2 + 4t + 6.$$

If the inhomogeneity is a sum of terms,  $L[y] = f \equiv f_1 + \dots + f_k$ , you can solve the problems  $L[y] = f_1, \dots, L[y] = f_k$  independently and then take the sum of the solutions as a particular solution of  $L[y] = f$ .

**Example 21.2.2** Consider

$$L[y] \equiv y'' - 2y' + y = t^2 + e^{2t}. \quad (21.1)$$

The homogeneous solutions are  $y_1 = e^t$  and  $y_2 = t e^t$ . We already know a particular solution to  $L[y] = t^2$ . We seek a particular solution to  $L[y] = e^{2t}$ . We guess a particular solution of the form

$$y_p = a e^{2t}.$$

We substitute the expression into the differential equation to determine the parameter.

$$\begin{aligned} y_p'' - 2y_p' + y_p &= e^{2t} \\ 4a e^{2t} - 4a e^{2t} + a e^{2t} &= e^{2t} \\ a &= 1 \end{aligned}$$

A particular solution of  $L[y] = e^{2t}$  is  $y_p = e^{2t}$ . Thus a particular solution of Equation 21.1 is

$$y_p = t^2 + 4t + 6 + e^{2t}.$$

The above guesses will not work if the inhomogeneity is a homogeneous solution. In this case, multiply the guess by the lowest power of  $x$  such that the guess does not contain homogeneous solutions.

**Example 21.2.3** Consider

$$L[y] \equiv y'' - 2y' + y = e^t.$$

The homogeneous solutions are  $y_1 = e^t$  and  $y_2 = t e^t$ . Guessing a particular solution of the form  $y_p = a e^t$  would not work because  $L[e^t] = 0$ . We guess a particular solution of the form

$$y_p = a t^2 e^t$$

We substitute the expression into the differential equation and equate coefficients of like terms to determine the parameters.

$$\begin{aligned}y_p'' - 2y_p' + y_p &= e^t \\(at^2 + 4at + 2a)e^t - 2(at^2 + 2at)e^t + at^2 e^t &= e^t \\2a e^t &= e^t \\a &= \frac{1}{2}\end{aligned}$$

A particular solution is

$$y_p = \frac{t^2}{2} e^t.$$

**Example 21.2.4** Consider

$$y'' + \frac{1}{x}y' + \frac{1}{x^2}y = x, \quad x > 0.$$

The homogeneous solutions are  $y_1 = \cos(\ln x)$  and  $y_2 = \sin(\ln x)$ . We guess a particular solution of the form

$$y_p = ax^3$$

We substitute the expression into the differential equation and equate coefficients of like terms to determine the parameter.

$$\begin{aligned}y_p'' + \frac{1}{x}y_p' + \frac{1}{x^2}y_p &= x \\6ax + 3ax + ax &= x \\a &= \frac{1}{10}\end{aligned}$$

A particular solution is

$$y_p = \frac{x^3}{10}.$$



## 21.3 Variation of Parameters

In this section we present a method for computing a particular solution of an inhomogeneous equation given that we know the homogeneous solutions. We will first consider second order equations and then generalize the result for  $n^{\text{th}}$  order equations.

### 21.3.1 Second Order Differential Equations

Consider the second order inhomogeneous equation,

$$L[y] \equiv y'' + p(x)y' + q(x)y = f(x), \quad \text{on } a < x < b.$$

We assume that the coefficient functions in the differential equation are continuous on  $[a \dots b]$ . Let  $y_1(x)$  and  $y_2(x)$  be two linearly independent solutions to the homogeneous equation. Since the Wronskian,

$$W(x) = \exp\left(-\int p(x) dx\right),$$

is non-vanishing, we know that these solutions exist. We seek a particular solution of the form,

$$y_p = u_1(x)y_1 + u_2(x)y_2.$$

We compute the derivatives of  $y_p$ .

$$\begin{aligned} y_p' &= u_1'y_1 + u_1y_1' + u_2'y_2 + u_2y_2' \\ y_p'' &= u_1''y_1 + 2u_1'y_1' + u_1y_1'' + u_2''y_2 + 2u_2'y_2' + u_2y_2'' \end{aligned}$$

We substitute the expression for  $y_p$  and its derivatives into the inhomogeneous equation and use the fact that  $y_1$  and  $y_2$  are homogeneous solutions to simplify the equation.

$$\begin{aligned} u_1''y_1 + 2u_1'y_1' + u_1y_1'' + u_2''y_2 + 2u_2'y_2' + u_2y_2'' + p(u_1'y_1 + u_1y_1' + u_2'y_2 + u_2y_2') + q(u_1y_1 + u_2y_2) &= f \\ u_1''y_1 + 2u_1'y_1' + u_2''y_2 + 2u_2'y_2' + p(u_1'y_1 + u_2'y_2) &= f \end{aligned}$$

This is an ugly equation for  $u_1$  and  $u_2$ , however, we have an ace up our sleeve. Since  $u_1$  and  $u_2$  are undetermined functions of  $x$ , we are free to impose a constraint. We choose this constraint to simplify the algebra.

$$u_1' y_1 + u_2' y_2 = 0$$

This constraint simplifies the derivatives of  $y_p$ ,

$$\begin{aligned} y_p' &= u_1' y_1 + u_1 y_1' + u_2' y_2 + u_2 y_2' \\ &= u_1 y_1' + u_2 y_2' \\ y_p'' &= u_1' y_1' + u_1 y_1'' + u_2' y_2' + u_2 y_2''. \end{aligned}$$

We substitute the new expressions for  $y_p$  and its derivatives into the inhomogeneous differential equation to obtain a much simpler equation than before.

$$\begin{aligned} u_1' y_1' + u_1 y_1'' + u_2' y_2' + u_2 y_2'' + p(u_1 y_1' + u_2 y_2') + q(u_1 y_1 + u_2 y_2) &= f(x) \\ u_1' y_1' + u_2' y_2' + u_1 L[y_1] + u_2 L[y_2] &= f(x) \\ u_1' y_1' + u_2' y_2' &= f(x). \end{aligned}$$

With the constraint, we have a system of linear equations for  $u_1'$  and  $u_2'$ .

$$\begin{aligned} u_1' y_1 + u_2' y_2 &= 0 \\ u_1' y_1' + u_2' y_2' &= f(x). \end{aligned}$$

$$\begin{pmatrix} y_1 & y_2 \\ y_1' & y_2' \end{pmatrix} \begin{pmatrix} u_1' \\ u_2' \end{pmatrix} = \begin{pmatrix} 0 \\ f \end{pmatrix}$$

We solve this system using Kramer's rule. (See Appendix [O](#).)

$$u_1' = -\frac{f(x)y_2}{W(x)} \quad u_2' = \frac{f(x)y_1}{W(x)}$$

Here  $W(x)$  is the Wronskian.

$$W(x) = \begin{vmatrix} y_1 & y_2 \\ y_1' & y_2' \end{vmatrix}$$

We integrate to get  $u_1$  and  $u_2$ . This gives us a particular solution.

$$y_p = -y_1 \int \frac{f(x)y_2(x)}{W(x)} dx + y_2 \int \frac{f(x)y_1(x)}{W(x)} dx.$$

**Result 21.3.1** Let  $y_1$  and  $y_2$  be linearly independent homogeneous solutions of

$$L[y] = y'' + p(x)y' + q(x)y = f(x).$$

A particular solution is

$$y_p = -y_1(x) \int \frac{f(x)y_2(x)}{W(x)} dx + y_2(x) \int \frac{f(x)y_1(x)}{W(x)} dx,$$

where  $W(x)$  is the Wronskian of  $y_1$  and  $y_2$ .

**Example 21.3.1** Consider the equation,

$$y'' + y = \cos(2x).$$

The homogeneous solutions are  $y_1 = \cos x$  and  $y_2 = \sin x$ . We compute the Wronskian.

$$W(x) = \begin{vmatrix} \cos x & \sin x \\ -\sin x & \cos x \end{vmatrix} = \cos^2 x + \sin^2 x = 1$$

We use variation of parameters to find a particular solution.

$$\begin{aligned}
 y_p &= -\cos(x) \int \cos(2x) \sin(x) \, dx + \sin(x) \int \cos(2x) \cos(x) \, dx \\
 &= -\frac{1}{2} \cos(x) \int (\sin(3x) - \sin(x)) \, dx + \frac{1}{2} \sin(x) \int (\cos(3x) + \cos(x)) \, dx \\
 &= -\frac{1}{2} \cos(x) \left( -\frac{1}{3} \cos(3x) + \cos(x) \right) + \frac{1}{2} \sin(x) \left( \frac{1}{3} \sin(3x) + \sin(x) \right) \\
 &= \frac{1}{2} (\sin^2(x) - \cos^2(x)) + \frac{1}{6} (\cos(3x) \cos(x) + \sin(3x) \sin(x)) \\
 &= -\frac{1}{2} \cos(2x) + \frac{1}{6} \cos(2x) \\
 &= -\frac{1}{3} \cos(2x)
 \end{aligned}$$

The general solution of the inhomogeneous equation is

$$y = -\frac{1}{3} \cos(2x) + c_1 \cos(x) + c_2 \sin(x).$$

## 21.3.2 Higher Order Differential Equations

Consider the  $n^{\text{th}}$  order inhomogeneous equation,

$$L[y] = y^{(n)} + p_{n-1}(x)y^{(n-1)} + \cdots + p_1(x)y' + p_0(x)y = f(x), \quad \text{on } a < x < b.$$

We assume that the coefficient functions in the differential equation are continuous on  $[a \dots b]$ . Let  $\{y_1, \dots, y_n\}$  be a set of linearly independent solutions to the homogeneous equation. Since the Wronskian,

$$W(x) = \exp \left( - \int p_{n-1}(x) \, dx \right),$$

is non-vanishing, we know that these solutions exist. We seek a particular solution of the form

$$y_p = u_1 y_1 + u_2 y_2 + \cdots + u_n y_n.$$

Since  $\{u_1, \dots, u_n\}$  are undetermined functions of  $x$ , we are free to impose  $n-1$  constraints. We choose these constraints to simplify the algebra.

$$\begin{aligned} u_1' y_1 + u_2' y_2 + \cdots + u_n' y_n &= 0 \\ u_1' y_1' + u_2' y_2' + \cdots + u_n' y_n' &= 0 \\ \vdots + \vdots + \vdots + \vdots &= 0 \\ u_1' y_1^{(n-2)} + u_2' y_2^{(n-2)} + \cdots + u_n' y_n^{(n-2)} &= 0 \end{aligned}$$

We differentiate the expression for  $y_p$ , utilizing our constraints.

$$\begin{aligned} y_p &= u_1 y_1 + u_2 y_2 + \cdots + u_n y_n \\ y_p' &= u_1 y_1' + u_2 y_2' + \cdots + u_n y_n' \\ y_p'' &= u_1 y_1'' + u_2 y_2'' + \cdots + u_n y_n'' \\ \vdots &= \vdots + \vdots + \vdots + \vdots \\ y_p^{(n)} &= u_1 y_1^{(n)} + u_2 y_2^{(n)} + \cdots + u_n y_n^{(n)} + u_1' y_1^{(n-1)} + u_2' y_2^{(n-1)} + \cdots + u_n' y_n^{(n-1)} \end{aligned}$$

We substitute  $y_p$  and its derivatives into the inhomogeneous differential equation and use the fact that the  $y_k$  are homogeneous solutions.

$$\begin{aligned} u_1 y_1^{(n)} + \cdots + u_n y_n^{(n)} + u_1' y_1^{(n-1)} + \cdots + u_n' y_n^{(n-1)} + p_{n-1}(u_1 y_1^{(n-1)} + \cdots + u_n y_n^{(n-1)}) + \cdots + p_0(u_1 y_1 + \cdots + u_n y_n) &= f \\ u_1 L[y_1] + u_2 L[y_2] + \cdots + u_n L[y_n] + u_1' y_1^{(n-1)} + u_2' y_2^{(n-1)} + \cdots + u_n' y_n^{(n-1)} &= f \\ u_1' y_1^{(n-1)} + u_2' y_2^{(n-1)} + \cdots + u_n' y_n^{(n-1)} &= f. \end{aligned}$$

With the constraints, we have a system of linear equations for  $\{u_1, \dots, u_n\}$ .

$$\begin{pmatrix} y_1 & y_2 & \cdots & y_n \\ y_1' & y_2' & \cdots & y_n' \\ \vdots & \vdots & \ddots & \vdots \\ y_1^{(n-1)} & y_2^{(n-1)} & \cdots & y_n^{(n-1)} \end{pmatrix} \begin{pmatrix} u_1' \\ u_2' \\ \vdots \\ u_n' \end{pmatrix} = \begin{pmatrix} 0 \\ \vdots \\ 0 \\ f \end{pmatrix}.$$

We solve this system using Kramer's rule. (See Appendix O.)

$$u_k' = (-1)^{n+k+1} \frac{W[y_1, \dots, y_{k-1}, y_{k+1}, \dots, y_n]}{W[y_1, y_2, \dots, y_n]} f, \quad \text{for } k = 1, \dots, n,$$

Here  $W$  is the Wronskian.

We integrate to obtain the  $u_k$ 's.

$$u_k = (-1)^{n+k+1} \int \frac{W[y_1, \dots, y_{k-1}, y_{k+1}, \dots, y_n](x)}{W[y_1, y_2, \dots, y_n](x)} f(x) dx, \quad \text{for } k = 1, \dots, n$$

**Result 21.3.2** Let  $\{y_1, \dots, y_n\}$  be linearly independent homogeneous solutions of

$$L[y] = y^{(n)} + p_{n-1}(x)y^{(n-1)} + \cdots + p_1(x)y' + p_0(x)y = f(x), \quad \text{on } a < x < b.$$

A particular solution is

$$y_p = u_1 y_1 + u_2 y_2 + \cdots + u_n y_n.$$

where

$$u_k = (-1)^{n+k+1} \int \frac{W[y_1, \dots, y_{k-1}, y_{k+1}, \dots, y_n](x)}{W[y_1, y_2, \dots, y_n](x)} f(x) dx, \quad \text{for } k = 1, \dots, n,$$

and  $W[y_1, y_2, \dots, y_n](x)$  is the Wronskian of  $\{y_1(x), \dots, y_n(x)\}$ .

## 21.4 Piecewise Continuous Coefficients and Inhomogeneities

**Example 21.4.1** Consider the problem

$$y'' - y = e^{-\alpha|x|}, \quad y(\pm\infty) = 0, \quad \alpha > 0, \alpha \neq 1.$$

The homogeneous solutions of the differential equation are  $e^x$  and  $e^{-x}$ . We use variation of parameters to find a particular solution for  $x > 0$ .

$$\begin{aligned} y_p &= -e^x \int^x \frac{e^{-\xi} e^{-\alpha\xi}}{-2} d\xi + e^{-x} \int^x \frac{e^{\xi} e^{-\alpha\xi}}{-2} d\xi \\ &= \frac{1}{2} e^x \int^x e^{-(\alpha+1)\xi} d\xi - \frac{1}{2} e^{-x} \int^x e^{(1-\alpha)\xi} d\xi \\ &= -\frac{1}{2(\alpha+1)} e^{-\alpha x} + \frac{1}{2(\alpha-1)} e^{-\alpha x} \\ &= \frac{e^{-\alpha x}}{\alpha^2 - 1}, \quad \text{for } x > 0 \end{aligned}$$

A particular solution for  $x < 0$  is

$$y_p = \frac{e^{\alpha x}}{\alpha^2 - 1}, \quad \text{for } x < 0.$$

Thus a particular solution is

$$y_p = \frac{e^{-\alpha|x|}}{\alpha^2 - 1}.$$

The general solution is

$$y = \frac{1}{\alpha^2 - 1} e^{-\alpha|x|} + c_1 e^x + c_2 e^{-x}.$$

Applying the boundary conditions, we see that  $c_1 = c_2 = 0$ . Apparently the solution is

$$y = \frac{e^{-\alpha|x|}}{\alpha^2 - 1}.$$

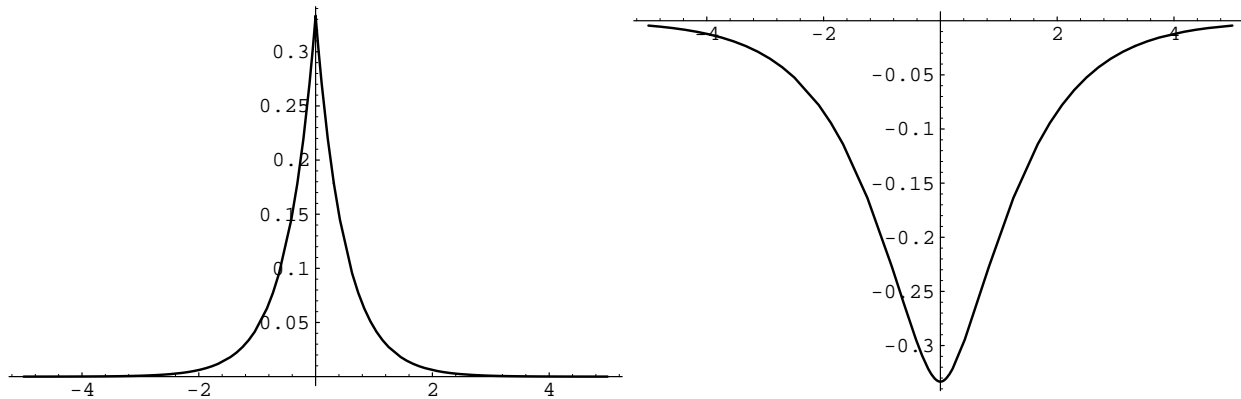

Figure 21.1: The Incorrect and Correct Solution to the Differential Equation.

*This function is plotted in Figure 21.1. This function satisfies the differential equation for positive and negative  $x$ . It also satisfies the boundary conditions. However, this is NOT a solution to the differential equation. Since the differential equation has no singular points and the inhomogeneous term is continuous, the solution must be twice continuously differentiable. Since the derivative of  $e^{-\alpha|x|}/(\alpha^2 - 1)$  has a jump discontinuity at  $x = 0$ , the second derivative does not exist. Thus this function could not possibly be a solution to the differential equation. In the next example we examine the right way to solve this problem.*

**Example 21.4.2** *Again consider*

$$y'' - y = e^{-\alpha|x|}, \quad y(\pm\infty) = 0, \quad \alpha > 0, \alpha \neq 1.$$



Separating this into two problems for positive and negative  $x$ ,

$$\begin{aligned} y''_- - y_- &= e^{\alpha x}, & y_-(-\infty) &= 0, & \text{on } -\infty < x \leq 0, \\ y''_+ - y_+ &= e^{-\alpha x}, & y_+(\infty) &= 0, & \text{on } 0 \leq x < \infty. \end{aligned}$$

In order for the solution over the whole domain to be twice differentiable, the solution and its first derivative must be continuous. Thus we impose the additional boundary conditions

$$y_-(0) = y_+(0), \quad y'_-(0) = y'_+(0).$$

The solutions that satisfy the two differential equations and the boundary conditions at infinity are

$$y_- = \frac{e^{\alpha x}}{\alpha^2 - 1} + c_- e^x, \quad y_+ = \frac{e^{-\alpha x}}{\alpha^2 - 1} + c_+ e^{-x}.$$

The two additional boundary conditions give us the equations

$$\begin{aligned} y_-(0) = y_+(0) &\rightarrow c_- = c_+ \\ y'_-(0) = y'_+(0) &\rightarrow \frac{\alpha}{\alpha^2 - 1} + c_- = -\frac{\alpha}{\alpha^2 - 1} - c_+. \end{aligned}$$

We solve these two equations to determine  $c_-$  and  $c_+$ .

$$c_- = c_+ = -\frac{\alpha}{\alpha^2 - 1}$$

Thus the solution over the whole domain is

$$y = \begin{cases} \frac{e^{\alpha x} - \alpha e^x}{\alpha^2 - 1} & \text{for } x < 0, \\ \frac{e^{-\alpha x} - \alpha e^{-x}}{\alpha^2 - 1} & \text{for } x > 0 \end{cases}$$

$$y = \frac{e^{-\alpha|x|} - \alpha e^{-|x|}}{\alpha^2 - 1}.$$

This function is plotted in Figure 21.1. You can verify that this solution is twice continuously differentiable.

## 21.5 Inhomogeneous Boundary Conditions

### 21.5.1 Eliminating Inhomogeneous Boundary Conditions

Consider the  $n^{\text{th}}$  order equation

$$L[y] = f(x), \quad \text{for } a < x < b,$$

subject to the linear inhomogeneous boundary conditions

$$B_j[y] = \gamma_j, \quad \text{for } j = 1, \dots, n,$$

where the boundary conditions are of the form

$$B[y] \equiv \alpha_0 y(a) + \alpha_1 y'(a) + \dots + \alpha_{n-1} y^{(n-1)}(a) + \beta_0 y(b) + \beta_1 y'(b) + \dots + \beta_{n-1} y^{(n-1)}(b)$$

Let  $g(x)$  be an  $n$ -times continuously differentiable function that satisfies the boundary conditions. Substituting  $y = u + g$  into the differential equation and boundary conditions yields

$$L[u] = f(x) - L[g], \quad B_j[u] = b_j - B_j[g] = 0 \quad \text{for } j = 1, \dots, n.$$

Note that the problem for  $u$  has homogeneous boundary conditions. Thus a problem with inhomogeneous boundary conditions can be reduced to one with homogeneous boundary conditions. This technique is of limited usefulness for ordinary differential equations but is important for solving some partial differential equation problems.

**Example 21.5.1** *Consider the problem*

$$y'' + y = \cos 2x, \quad y(0) = 1, \quad y(\pi) = 2.$$

$g(x) = \frac{x}{\pi} + 1$  satisfies the boundary conditions. Substituting  $y = u + g$  yields

$$u'' + u = \cos 2x - \frac{x}{\pi} - 1, \quad y(0) = y(\pi) = 0.$$

**Example 21.5.2** Consider

$$y'' + y = \cos 2x, \quad y'(0) = y(\pi) = 1.$$

$g(x) = \sin x - \cos x$  satisfies the inhomogeneous boundary conditions. Substituting  $y = u + \sin x - \cos x$  yields

$$u'' + u = \cos 2x, \quad u'(0) = u(\pi) = 0.$$

Note that since  $g(x)$  satisfies the homogeneous equation, the inhomogeneous term in the equation for  $u$  is the same as that in the equation for  $y$ .

**Example 21.5.3** Consider

$$y'' + y = \cos 2x, \quad y(0) = \frac{2}{3}, \quad y(\pi) = -\frac{4}{3}.$$

$g(x) = \cos x - \frac{1}{3}$  satisfies the boundary conditions. Substituting  $y = u + \cos x - \frac{1}{3}$  yields

$$u'' + u = \cos 2x + \frac{1}{3}, \quad u(0) = u(\pi) = 0.$$

**Result 21.5.1** The  $n^{\text{th}}$  order differential equation with boundary conditions

$$L[y] = f(x), \quad B_j[y] = b_j, \quad \text{for } j = 1, \dots, n$$

has the solution  $y = u + g$  where  $u$  satisfies

$$L[u] = f(x) - L[g], \quad B_j[u] = 0, \quad \text{for } j = 1, \dots, n$$

and  $g$  is any  $n$ -times continuously differentiable function that satisfies the inhomogeneous boundary conditions.

## 21.5.2 Separating Inhomogeneous Equations and Inhomogeneous Boundary Conditions

Now consider a problem with inhomogeneous boundary conditions

$$L[y] = f(x), \quad B_1[y] = \gamma_1, \quad B_2[y] = \gamma_2.$$

In order to solve this problem, we solve the two problems

$$L[u] = f(x), \quad B_1[u] = B_2[u] = 0, \quad \text{and}$$

$$L[v] = 0, \quad B_1[v] = \gamma_1, \quad B_2[v] = \gamma_2.$$

The solution for the problem with an inhomogeneous equation and inhomogeneous boundary conditions will be the sum of  $u$  and  $v$ . To verify this,

$$\begin{aligned} L[u + v] &= L[u] + L[v] = f(x) + 0 = f(x), \\ B_i[u + v] &= B_i[u] + B_i[v] = 0 + \gamma_i = \gamma_i. \end{aligned}$$

This will be a useful technique when we develop Green functions.

**Result 21.5.2** The solution to

$$L[y] = f(x), \quad B_1[y] = \gamma_1, \quad B_2[y] = \gamma_2,$$

is  $y = u + v$  where

$$\begin{aligned} L[u] &= f(x), \quad B_1[u] = 0, \quad B_2[u] = 0, \quad \text{and} \\ L[v] &= 0, \quad B_1[v] = \gamma_1, \quad B_2[v] = \gamma_2. \end{aligned}$$

### 21.5.3 Existence of Solutions of Problems with Inhomogeneous Boundary Conditions

Consider the  $n^{\text{th}}$  order homogeneous differential equation

$$L[y] = y^{(n)} + p_{n-1}y^{(n-1)} + \cdots + p_1y' + p_0y = f(x), \quad \text{for } a < x < b,$$

subject to the  $n$  inhomogeneous boundary conditions

$$B_j[y] = \gamma_j, \quad \text{for } j = 1, \dots, n$$

where each boundary condition is of the form

$$B[y] \equiv \alpha_0y(a) + \alpha_1y'(a) + \cdots + \alpha_{n-1}y^{(n-1)}(a) + \beta_0y(b) + \beta_1y'(b) + \cdots + \beta_{n-1}y^{(n-1)}(b).$$

We assume that the coefficients in the differential equation are continuous on  $[a, b]$ . Since the Wronskian of the solutions of the differential equation,

$$W(x) = \exp\left(-\int p_{n-1}(x) dx\right),$$

is non-vanishing on  $[a, b]$ , there are  $n$  linearly independent solutions on that range. Let  $\{y_1, \dots, y_n\}$  be a set of linearly independent solutions of the homogeneous equation. From Result 21.3.2 we know that a particular solution  $y_p$  exists. The general solution of the differential equation is

$$y = y_p + c_1y_1 + c_2y_2 + \cdots + c_ny_n.$$

The  $n$  boundary conditions impose the matrix equation,

$$\begin{pmatrix} B_1[y_1] & B_1[y_2] & \cdots & B_1[y_n] \\ B_2[y_1] & B_2[y_2] & \cdots & B_2[y_n] \\ \vdots & \vdots & \ddots & \vdots \\ B_n[y_1] & B_n[y_2] & \cdots & B_n[y_n] \end{pmatrix} \begin{pmatrix} c_1 \\ c_2 \\ \vdots \\ c_n \end{pmatrix} = \begin{pmatrix} \gamma_1 - B_1[y_p] \\ \gamma_2 - B_2[y_p] \\ \vdots \\ \gamma_n - B_n[y_p] \end{pmatrix}$$

This equation has a unique solution if and only if the equation

$$\begin{pmatrix} B_1[y_1] & B_1[y_2] & \cdots & B_1[y_n] \\ B_2[y_1] & B_2[y_2] & \cdots & B_2[y_n] \\ \vdots & \vdots & \ddots & \vdots \\ B_n[y_1] & B_n[y_2] & \cdots & B_n[y_n] \end{pmatrix} \begin{pmatrix} c_1 \\ c_2 \\ \vdots \\ c_n \end{pmatrix} = \begin{pmatrix} 0 \\ 0 \\ \vdots \\ 0 \end{pmatrix}$$

has only the trivial solution. (This is the case if and only if the determinant of the matrix is nonzero.) Thus the problem

$$L[y] = y^{(n)} + p_{n-1}y^{(n-1)} + \cdots + p_1y' + p_0y = f(x), \quad \text{for } a < x < b,$$

subject to the  $n$  inhomogeneous boundary conditions

$$B_j[y] = \gamma_j, \quad \text{for } j = 1, \dots, n,$$

has a unique solution if and only if the problem

$$L[y] = y^{(n)} + p_{n-1}y^{(n-1)} + \cdots + p_1y' + p_0y = 0, \quad \text{for } a < x < b,$$

subject to the  $n$  homogeneous boundary conditions

$$B_j[y] = 0, \quad \text{for } j = 1, \dots, n,$$

has only the trivial solution.

**Result 21.5.3** The problem

$$L[y] = y^{(n)} + p_{n-1}y^{(n-1)} + \cdots + p_1y' + p_0y = f(x), \quad \text{for } a < x < b,$$

subject to the  $n$  inhomogeneous boundary conditions

$$B_j[y] = \gamma_j, \quad \text{for } j = 1, \dots, n,$$

has a unique solution if and only if the problem

$$L[y] = y^{(n)} + p_{n-1}y^{(n-1)} + \cdots + p_1y' + p_0y = 0, \quad \text{for } a < x < b,$$

subject to

$$B_j[y] = 0, \quad \text{for } j = 1, \dots, n,$$

has only the trivial solution.

## 21.6 Green Functions for First Order Equations

Consider the first order inhomogeneous equation

$$L[y] \equiv y' + p(x)y = f(x), \quad \text{for } x > a, \tag{21.2}$$

subject to a homogeneous initial condition,  $B[y] \equiv y(a) = 0$ .

The Green function  $G(x|\xi)$  is defined as the solution to

$$L[G(x|\xi)] = \delta(x - \xi) \quad \text{subject to } G(a|\xi) = 0.$$

We can represent the solution to the inhomogeneous problem in Equation 21.2 as an integral involving the Green

function. To show that

$$y(x) = \int_a^\infty G(x|\xi)f(\xi) d\xi$$

is the solution, we apply the linear operator  $L$  to the integral. (Assume that the integral is uniformly convergent.)

$$\begin{aligned} L \left[ \int_a^\infty G(x|\xi)f(\xi) d\xi \right] &= \int_a^\infty L[G(x|\xi)]f(\xi) d\xi \\ &= \int_a^\infty \delta(x - \xi)f(\xi) d\xi \\ &= f(x) \end{aligned}$$

The integral also satisfies the initial condition.

$$\begin{aligned} B \left[ \int_a^\infty G(x|\xi)f(\xi) d\xi \right] &= \int_a^\infty B[G(x|\xi)]f(\xi) d\xi \\ &= \int_a^\infty (0)f(\xi) d\xi \\ &= 0 \end{aligned}$$

Now we consider the qualitative behavior of the Green function. For  $x \neq \xi$ , the Green function is simply a homogeneous solution of the differential equation, however at  $x = \xi$  we expect some singular behavior.  $G'(x|\xi)$  will have a Dirac delta function type singularity. This means that  $G(x|\xi)$  will have a jump discontinuity at  $x = \xi$ . We integrate the differential equation on the vanishing interval  $(\xi^- \dots \xi^+)$  to determine this jump.

$$\begin{aligned} G' + p(x)G &= \delta(x - \xi) \\ G(\xi^+|\xi) - G(\xi^-|\xi) + \int_{\xi^-}^{\xi^+} p(x)G(x|\xi) dx &= 1 \\ G(\xi^+|\xi) - G(\xi^-|\xi) &= 1 \end{aligned} \tag{21.3}$$



The homogeneous solution of the differential equation is

$$y_h = e^{-\int p(x) dx}$$

Since the Green function satisfies the homogeneous equation for  $x \neq \xi$ , it will be a constant times this homogeneous solution for  $x < \xi$  and  $x > \xi$ .

$$G(x|\xi) = \begin{cases} c_1 e^{-\int p(x) dx} & a < x < \xi \\ c_2 e^{-\int p(x) dx} & \xi < x \end{cases}$$

In order to satisfy the homogeneous initial condition  $G(a|\xi) = 0$ , the Green function must vanish on the interval  $(a \dots \xi)$ .

$$G(x|\xi) = \begin{cases} 0 & a < x < \xi \\ c e^{-\int p(x) dx} & \xi < x \end{cases}$$

The jump condition, (Equation 21.3), gives us the constraint  $G(\xi^+|\xi) = 1$ . This determines the constant in the homogeneous solution for  $x > \xi$ .

$$G(x|\xi) = \begin{cases} 0 & a < x < \xi \\ e^{-\int_{\xi}^x p(t) dt} & \xi < x \end{cases}$$

We can use the Heaviside function to write the Green function without using a case statement.

$$G(x|\xi) = e^{-\int_{\xi}^x p(t) dt} H(x - \xi)$$

Clearly the Green function is of little value in solving the inhomogeneous differential equation in Equation 21.2, as we can solve that problem directly. However, we will encounter first order Green function problems in solving some partial differential equations.

**Result 21.6.1** The first order inhomogeneous differential equation with homogeneous initial condition

$$L[y] \equiv y' + p(x)y = f(x), \quad \text{for } a < x, \quad y(a) = 0,$$

has the solution

$$y = \int_a^\infty G(x|\xi)f(\xi) d\xi,$$

where  $G(x|\xi)$  satisfies the equation

$$L[G(x|\xi)] = \delta(x - \xi), \quad \text{for } a < x, \quad G(a|\xi) = 0.$$

The Green function is

$$G(x|\xi) = e^{-\int_\xi^x p(t) dt} H(x - \xi)$$

## 21.7 Green Functions for Second Order Equations

Consider the second order inhomogeneous equation

$$L[y] = y'' + p(x)y' + q(x)y = f(x), \quad \text{for } a < x < b, \quad (21.4)$$

subject to the homogeneous boundary conditions

$$B_1[y] = B_2[y] = 0.$$

The Green function  $G(x|\xi)$  is defined as the solution to

$$L[G(x|\xi)] = \delta(x - \xi) \quad \text{subject to } B_1[G] = B_2[G] = 0.$$

The Green function is useful because you can represent the solution to the inhomogeneous problem in Equation 21.4 as an integral involving the Green function. To show that

$$y(x) = \int_a^b G(x|\xi)f(\xi) d\xi$$

is the solution, we apply the linear operator  $L$  to the integral. (Assume that the integral is uniformly convergent.)

$$\begin{aligned} L \left[ \int_a^b G(x|\xi)f(\xi) d\xi \right] &= \int_a^b L[G(x|\xi)]f(\xi) d\xi \\ &= \int_a^b \delta(x - \xi)f(\xi) d\xi \\ &= f(x) \end{aligned}$$

The integral also satisfies the boundary conditions.

$$\begin{aligned} B_i \left[ \int_a^b G(x|\xi)f(\xi) d\xi \right] &= \int_a^b B_i[G(x|\xi)]f(\xi) d\xi \\ &= \int_a^b [0]f(\xi) d\xi \\ &= 0 \end{aligned}$$

One of the advantages of using Green functions is that once you find the Green function for a linear operator and certain homogeneous boundary conditions,

$$L[G] = \delta(x - \xi), \quad B_1[G] = B_2[G] = 0,$$

you can write the solution for any inhomogeneity,  $f(x)$ .

$$L[f] = f(x), \quad B_1[y] = B_2[y] = 0$$

You do not need to do any extra work to obtain the solution for a different inhomogeneous term.

Qualitatively, what kind of behavior will the Green function for a second order differential equation have? Will it have a delta function singularity; will it be continuous? To answer these questions we will first look at the behavior of integrals and derivatives of  $\delta(x)$ .

The integral of  $\delta(x)$  is the Heaviside function,  $H(x)$ .

$$H(x) = \int_{-\infty}^x \delta(t) dt = \begin{cases} 0 & \text{for } x < 0 \\ 1 & \text{for } x > 0 \end{cases}$$

The integral of the Heaviside function is the ramp function,  $r(x)$ .

$$r(x) = \int_{-\infty}^x H(t) dt = \begin{cases} 0 & \text{for } x < 0 \\ x & \text{for } x > 0 \end{cases}$$

The derivative of the delta function is zero for  $x \neq 0$ . At  $x = 0$  it goes from 0 up to  $+\infty$ , down to  $-\infty$  and then back up to 0.

In Figure 21.2 we see conceptually the behavior of the ramp function, the Heaviside function, the delta function, and the derivative of the delta function.

We write the differential equation for the Green function.

$$G''(x|\xi) + p(x)G'(x|\xi) + q(x)G(x|\xi) = \delta(x - \xi)$$

we see that only the  $G''(x|\xi)$  term can have a delta function type singularity. If one of the other terms had a delta function type singularity then  $G''(x|\xi)$  would be more singular than a delta function and there would be nothing in the right hand side of the equation to match this kind of singularity. Analogous to the progression from a delta function to a Heaviside function to a ramp function, we see that  $G'(x|\xi)$  will have a jump discontinuity and  $G(x|\xi)$  will be continuous.

Let  $y_1$  and  $y_2$  be two linearly independent solutions to the homogeneous equation,  $L[y] = 0$ . Since the Green function satisfies the homogeneous equation for  $x \neq \xi$ , it will be a linear combination of the homogeneous solutions.

$$G(x|\xi) = \begin{cases} c_1y_1 + c_2y_2 & \text{for } x < \xi \\ d_1y_1 + d_2y_2 & \text{for } x > \xi \end{cases}$$



Figure 21.2:  $r(x)$ ,  $H(x)$ ,  $\delta(x)$  and  $\frac{d}{dx}\delta(x)$

We require that  $G(x|\xi)$  be continuous.

$$G(x|\xi)|_{x \rightarrow \xi^-} = G(x|\xi)|_{x \rightarrow \xi^+}$$

We can write this in terms of the homogeneous solutions.

$$c_1 y_1(\xi) + c_2 y_2(\xi) = d_1 y_1(\xi) + d_2 y_2(\xi)$$

We integrate  $L[G(x|\xi)] = \delta(x - \xi)$  from  $\xi^-$  to  $\xi^+$ .

$$\int_{\xi^-}^{\xi^+} [G''(x|\xi) + p(x)G'(x|\xi) + q(x)G(x|\xi)] dx = \int_{\xi^-}^{\xi^+} \delta(x - \xi) dx.$$

Since  $G(x|\xi)$  is continuous and  $G'(x|\xi)$  has only a jump discontinuity two of the terms vanish.

$$\int_{\xi^-}^{\xi^+} p(x)G'(x|\xi) dx = 0 \quad \text{and} \quad \int_{\xi^-}^{\xi^+} q(x)G(x|\xi) dx = 0$$

$$\int_{\xi^-}^{\xi^+} G''(x|\xi) dx = \int_{\xi^-}^{\xi^+} \delta(x - \xi) dx$$

$$[G'(x|\xi)]_{\xi^-}^{\xi^+} = [H(x - \xi)]_{\xi^-}^{\xi^+}$$

$$G'(\xi^+|\xi) - G'(\xi^-|\xi) = 1$$

We write this jump condition in terms of the homogeneous solutions.

$$d_1 y_1'(\xi) + d_2 y_2'(\xi) - c_1 y_1'(\xi) - c_2 y_2'(\xi) = 1$$

Combined with the two boundary conditions, this gives us a total of four equations to determine our four constants,  $c_1$ ,  $c_2$ ,  $d_1$ , and  $d_2$ .

**Result 21.7.1** The second order inhomogeneous differential equation with homogeneous boundary conditions

$$L[y] = y'' + p(x)y' + q(x)y = f(x), \quad \text{for } a < x < b, \quad B_1[y] = B_2[y] = 0,$$

has the solution

$$y = \int_a^b G(x|\xi) f(\xi) d\xi,$$

where  $G(x|\xi)$  satisfies the equation

$$L[G(x|\xi)] = \delta(x - \xi), \quad \text{for } a < x < b, \quad B_1[G(x|\xi)] = B_2[G(x|\xi)] = 0.$$

$G(x|\xi)$  is continuous and  $G'(x|\xi)$  has a jump discontinuity of height 1 at  $x = \xi$ .

**Example 21.7.1** Solve the boundary value problem

$$y'' = f(x), \quad y(0) = y(1) = 0,$$

using a Green function.

A pair of solutions to the homogeneous equation are  $y_1 = 1$  and  $y_2 = x$ . First note that only the trivial solution to the homogeneous equation satisfies the homogeneous boundary conditions. Thus there is a unique solution to this problem.

The Green function satisfies

$$G'''(x|\xi) = \delta(x - \xi), \quad G(0|\xi) = G(1|\xi) = 0.$$

The Green function has the form

$$G(x|\xi) = \begin{cases} c_1 + c_2x & \text{for } x < \xi \\ d_1 + d_2x & \text{for } x > \xi. \end{cases}$$

Applying the two boundary conditions, we see that  $c_1 = 0$  and  $d_1 = -d_2$ . The Green function now has the form

$$G(x|\xi) = \begin{cases} cx & \text{for } x < \xi \\ d(x - 1) & \text{for } x > \xi. \end{cases}$$

Since the Green function must be continuous,

$$c\xi = d(\xi - 1) \quad \rightarrow \quad d = c \frac{\xi}{\xi - 1}.$$

From the jump condition,

$$\begin{aligned} \frac{d}{dx} c \frac{\xi}{\xi - 1} (x - 1) \Big|_{x=\xi} - \frac{d}{dx} cx \Big|_{x=\xi} &= 1 \\ c \frac{\xi}{\xi - 1} - c &= 1 \\ c &= \xi - 1. \end{aligned}$$

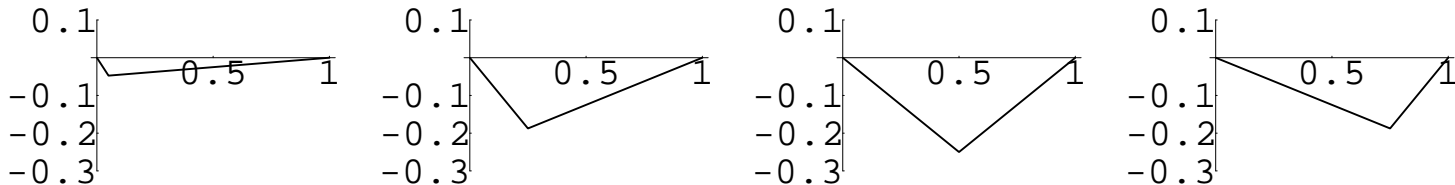

Figure 21.3: Plot of  $G(x|0.05), G(x|0.25), G(x|0.5)$  and  $G(x|0.75)$ .

Thus the Green function is

$$G(x|\xi) = \begin{cases} (\xi - 1)x & \text{for } x < \xi \\ \xi(x - 1) & \text{for } x > \xi. \end{cases}$$

The Green function is plotted in Figure 21.3 for various values of  $\xi$ . The solution to  $y'' = f(x)$  is

$$y(x) = \int_0^1 G(x|\xi) f(\xi) d\xi$$

$$y(x) = (x - 1) \int_0^x \xi f(\xi) d\xi + x \int_x^1 (\xi - 1) f(\xi) d\xi.$$

**Example 21.7.2** Solve the boundary value problem

$$y'' = f(x), \quad y(0) = 1, \quad y(1) = 2.$$

In Example 21.7.1 we saw that the solution to

$$u'' = f(x), \quad u(0) = u(1) = 0$$



is

$$u(x) = (x - 1) \int_0^x \xi f(\xi) \, d\xi + x \int_x^1 (\xi - 1) f(\xi) \, d\xi.$$

Now we have to find the solution to

$$v'' = 0, \quad v(0) = 1, \quad u(1) = 2.$$

The general solution is

$$v = c_1 + c_2 x.$$

Applying the boundary conditions yields

$$v = 1 + x.$$

Thus the solution for  $y$  is

$$y = 1 + x + (x - 1) \int_0^x \xi f(\xi) \, d\xi + x \int_x^1 (\xi - 1) f(\xi) \, d\xi.$$

**Example 21.7.3** Consider

$$y'' = x, \quad y(0) = y(1) = 0.$$

**Method 1.** Integrating the differential equation twice yields

$$y = \frac{1}{6}x^3 + c_1x + c_2.$$

Applying the boundary conditions, we find that the solution is

$$y = \frac{1}{6}(x^3 - x).$$

**Method 2.** Using the Green function to find the solution,

$$\begin{aligned}y &= (x-1) \int_0^x \xi^2 d\xi + x \int_x^1 (\xi-1)\xi d\xi \\ &= (x-1) \frac{1}{3}x^3 + x \left( \frac{1}{3} - \frac{1}{2} - \frac{1}{3}x^3 + \frac{1}{2}x^2 \right)\end{aligned}$$

$$y = \frac{1}{6}(x^3 - x).$$

**Example 21.7.4** Find the solution to the differential equation

$$y'' - y = \sin x,$$

that is bounded for all  $x$ .

The Green function for this problem satisfies

$$G''(x|\xi) - G(x|\xi) = \delta(x - \xi).$$

The homogeneous solutions are  $y_1 = e^x$ , and  $y_2 = e^{-x}$ . The Green function has the form

$$G(x|\xi) = \begin{cases} c_1 e^x + c_2 e^{-x} & \text{for } x < \xi \\ d_1 e^x + d_2 e^{-x} & \text{for } x > \xi. \end{cases}$$

Since the solution must be bounded for all  $x$ , the Green function must also be bounded. Thus  $c_2 = d_1 = 0$ . The Green function now has the form

$$G(x|\xi) = \begin{cases} c e^x & \text{for } x < \xi \\ d e^{-x} & \text{for } x > \xi. \end{cases}$$

Requiring that  $G(x|\xi)$  be continuous gives us the condition

$$c e^\xi = d e^{-\xi} \quad \rightarrow \quad d = c e^{2\xi}.$$

$G(x|\xi)$  has a jump discontinuity of height 1 at  $x = \xi$ .

$$\begin{aligned} \frac{d}{dx} c e^{2\xi} e^{-x} \Big|_{x=\xi} - \frac{d}{dx} c e^x \Big|_{x=\xi} &= 1 \\ -c e^{2\xi} e^{-\xi} - c e^{\xi} &= 1 \\ c &= -\frac{1}{2} e^{-\xi} \end{aligned}$$

The Green function is then

$$G(x|\xi) = \begin{cases} -\frac{1}{2} e^{x-\xi} & \text{for } x < \xi \\ -\frac{1}{2} e^{-x+\xi} & \text{for } x > \xi \end{cases}$$

$$G(x|\xi) = -\frac{1}{2} e^{-|x-\xi|}.$$

A plot of  $G(x|0)$  is given in Figure 21.4. The solution to  $y'' - y = \sin x$  is

$$\begin{aligned} y(x) &= \int_{-\infty}^{\infty} -\frac{1}{2} e^{-|x-\xi|} \sin \xi \, d\xi \\ &= -\frac{1}{2} \left( \int_{-\infty}^x \sin \xi e^{x-\xi} \, d\xi + \int_x^{\infty} \sin \xi e^{-x+\xi} \, d\xi \right) \\ &= -\frac{1}{2} \left( -\frac{\sin x + \cos x}{2} + \frac{-\sin x + \cos x}{2} \right) \end{aligned}$$

$$y = \frac{1}{2} \sin x.$$

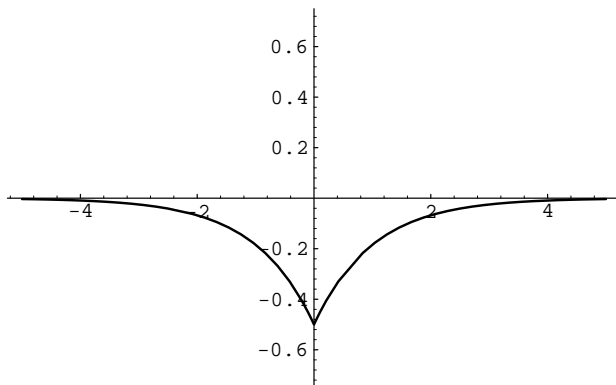

Figure 21.4: Plot of  $G(x|0)$ .

### 21.7.1 Green Functions for Sturm-Liouville Problems

Consider the problem

$$L[y] = (p(x)y')' + q(x)y = f(x), \quad \text{subject to}$$

$$B_1[y] = \alpha_1 y(a) + \alpha_2 y'(a) = 0, \quad B_2[y] = \beta_1 y(b) + \beta_2 y'(b) = 0.$$

This is known as a Sturm-Liouville problem. Equations of this type often occur when solving partial differential equations. The Green function associated with this problem satisfies

$$L[G(x|\xi)] = \delta(x - \xi), \quad B_1[G(x|\xi)] = B_2[G(x|\xi)] = 0.$$

Let  $y_1$  and  $y_2$  be two non-trivial homogeneous solutions that satisfy the left and right boundary conditions, respectively.

$$L[y_1] = 0, \quad B_1[y_1] = 0, \quad L[y_2] = 0, \quad B_2[y_2] = 0.$$

The Green function satisfies the homogeneous equation for  $x \neq \xi$  and satisfies the homogeneous boundary conditions. Thus it must have the following form.

$$G(x|\xi) = \begin{cases} c_1(\xi)y_1(x) & \text{for } a \leq x \leq \xi, \\ c_2(\xi)y_2(x) & \text{for } \xi \leq x \leq b, \end{cases}$$

Here  $c_1$  and  $c_2$  are unknown functions of  $\xi$ .

The first constraint on  $c_1$  and  $c_2$  comes from the continuity condition.

$$\begin{aligned} G(\xi^-|\xi) &= G(\xi^+|\xi) \\ c_1(\xi)y_1(\xi) &= c_2(\xi)y_2(\xi) \end{aligned}$$

We write the inhomogeneous equation in the standard form.

$$G''(x|\xi) + \frac{p'}{p}G'(x|\xi) + \frac{q}{p}G(x|\xi) = \frac{\delta(x - \xi)}{p}$$

The second constraint on  $c_1$  and  $c_2$  comes from the jump condition.

$$\begin{aligned} G'(\xi^+|\xi) - G'(\xi^-|\xi) &= \frac{1}{p(\xi)} \\ c_2(\xi)y_2'(\xi) - c_1(\xi)y_1'(\xi) &= \frac{1}{p(\xi)} \end{aligned}$$

Now we have a system of equations to determine  $c_1$  and  $c_2$ .

$$\begin{aligned} c_1(\xi)y_1(\xi) - c_2(\xi)y_2(\xi) &= 0 \\ c_1(\xi)y_1'(\xi) - c_2(\xi)y_2'(\xi) &= -\frac{1}{p(\xi)} \end{aligned}$$

We solve this system with Kramer's rule.

$$c_1(\xi) = -\frac{y_2(\xi)}{p(\xi)(-W(\xi))}, \quad c_2(\xi) = -\frac{y_1(\xi)}{p(\xi)(-W(\xi))}$$

Here  $W(x)$  is the Wronskian of  $y_1(x)$  and  $y_2(x)$ . The Green function is

$$G(x|\xi) = \begin{cases} \frac{y_1(x)y_2(\xi)}{p(\xi)W(\xi)} & \text{for } a \leq x \leq \xi, \\ \frac{y_2(x)y_1(\xi)}{p(\xi)W(\xi)} & \text{for } \xi \leq x \leq b. \end{cases}$$

The solution of the Sturm-Liouville problem is

$$y = \int_a^b G(x|\xi)f(\xi) d\xi.$$

**Result 21.7.2** The problem

$$L[y] = (p(x)y')' + q(x)y = f(x), \quad \text{subject to}$$

$$B_1[y] = \alpha_1y(a) + \alpha_2y'(a) = 0, \quad B_2[y] = \beta_1y(b) + \beta_2y'(b) = 0.$$

has the Green function

$$G(x|\xi) = \begin{cases} \frac{y_1(x)y_2(\xi)}{p(\xi)W(\xi)} & \text{for } a \leq x \leq \xi, \\ \frac{y_2(x)y_1(\xi)}{p(\xi)W(\xi)} & \text{for } \xi \leq x \leq b, \end{cases}$$

where  $y_1$  and  $y_2$  are non-trivial homogeneous solutions that satisfy  $B_1[y_1] = B_2[y_2] = 0$ , and  $W(x)$  is the Wronskian of  $y_1$  and  $y_2$ .

**Example 21.7.5** Consider the equation

$$y'' - y = f(x), \quad y(0) = y(1) = 0.$$

A set of solutions to the homogeneous equation is  $\{e^x, e^{-x}\}$ . Equivalently, one could use the set  $\{\cosh x, \sinh x\}$ . Note that  $\sinh x$  satisfies the left boundary condition and  $\sinh(x - 1)$  satisfies the right boundary condition. The Wronskian of these two homogeneous solutions is

$$\begin{aligned} W(x) &= \begin{vmatrix} \sinh x & \sinh(x-1) \\ \cosh x & \cosh(x-1) \end{vmatrix} \\ &= \sinh x \cosh(x-1) - \cosh x \sinh(x-1) \\ &= \frac{1}{2}[\sinh(2x-1) + \sinh(1)] - \frac{1}{2}[\sinh(2x-1) - \sinh(1)] \\ &= \sinh(1). \end{aligned}$$

The Green function for the problem is then

$$G(x|\xi) = \begin{cases} \frac{\sinh x \sinh(\xi-1)}{\sinh(1)} & \text{for } 0 \leq x \leq \xi \\ \frac{\sinh(x-1) \sinh \xi}{\sinh(1)} & \text{for } \xi \leq x \leq 1. \end{cases}$$

The solution to the problem is

$$y = \frac{\sinh(x-1)}{\sinh(1)} \int_0^x \sinh(\xi) f(\xi) d\xi + \frac{\sinh(x)}{\sinh(1)} \int_x^1 \sinh(\xi-1) f(\xi) d\xi.$$

## 21.7.2 Initial Value Problems

Consider

$$L[y] = y'' + p(x)y' + q(x)y = f(x), \quad \text{for } a < x < b,$$

subject to the initial conditions

$$y(a) = \gamma_1, \quad y'(a) = \gamma_2.$$

The solution is  $y = u + v$  where

$$u'' + p(x)u' + q(x)u = f(x), \quad u(a) = 0, \quad u'(a) = 0,$$

and

$$v'' + p(x)v' + q(x)v = 0, \quad v(a) = \gamma_1, \quad v'(a) = \gamma_2.$$

Since the Wronskian

$$W(x) = c \exp\left(-\int p(x) dx\right)$$

is non-vanishing, the solutions of the differential equation for  $v$  are linearly independent. Thus there is a unique solution for  $v$  that satisfies the initial conditions.

The Green function for  $u$  satisfies

$$G''(x|\xi) + p(x)G'(x|\xi) + q(x)G(x|\xi) = \delta(x - \xi), \quad G(a|\xi) = 0, \quad G'(a|\xi) = 0.$$

The continuity and jump conditions are

$$G(\xi^-|\xi) = G(\xi^+|\xi), \quad G'(\xi^-|\xi) + 1 = G'(\xi^+|\xi).$$

Let  $u_1$  and  $u_2$  be two linearly independent solutions of the differential equation. For  $x < \xi$ ,  $G(x|\xi)$  is a linear combination of these solutions. Since the Wronskian is non-vanishing, only the trivial solution satisfies the homogeneous initial conditions. The Green function must be

$$G(x|\xi) = \begin{cases} 0 & \text{for } x < \xi \\ u_\xi(x) & \text{for } x > \xi, \end{cases}$$

where  $u_\xi(x)$  is the linear combination of  $u_1$  and  $u_2$  that satisfies

$$u_\xi(\xi) = 0, \quad u'_\xi(\xi) = 1.$$



Note that the non-vanishing Wronskian ensures a unique solution for  $u_\xi$ . We can write the Green function in the form

$$G(x|\xi) = H(x - \xi)u_\xi(x).$$

This is known as the **causal solution**. The solution for  $u$  is

$$\begin{aligned} u &= \int_a^b G(x|\xi)f(\xi) \, d\xi \\ &= \int_a^b H(x - \xi)u_\xi(x)f(\xi) \, d\xi \\ &= \int_a^x u_\xi(x)f(\xi) \, d\xi \end{aligned}$$

Now we have the solution for  $y$ ,

$$y = v + \int_a^x u_\xi(x)f(\xi) \, d\xi.$$

**Result 21.7.3** The solution of the problem

$$y'' + p(x)y' + q(x)y = f(x), \quad y(a) = \gamma_1, \quad y'(a) = \gamma_2,$$

is

$$y = y_h + \int_a^x y_\xi(x)f(\xi) \, d\xi$$

where  $y_h$  is the combination of the homogeneous solutions of the equation that satisfy the initial conditions and  $y_\xi(x)$  is the linear combination of homogeneous solutions that satisfy  $y_\xi(\xi) = 0$ ,  $y'_\xi(\xi) = 1$ .

### 21.7.3 Problems with Unmixed Boundary Conditions

Consider

$$L[y] = y'' + p(x)y' + q(x)y = f(x), \quad \text{for } a < x < b,$$

subject to the unmixed boundary conditions

$$\alpha_1 y(a) + \alpha_2 y'(a) = \gamma_1, \quad \beta_1 y(b) + \beta_2 y'(b) = \gamma_2.$$

The solution is  $y = u + v$  where

$$u'' + p(x)u' + q(x)u = f(x), \quad \alpha_1 u(a) + \alpha_2 u'(a) = 0, \quad \beta_1 u(b) + \beta_2 u'(b) = 0,$$

and

$$v'' + p(x)v' + q(x)v = 0, \quad \alpha_1 v(a) + \alpha_2 v'(a) = \gamma_1, \quad \beta_1 v(b) + \beta_2 v'(b) = \gamma_2.$$

The problem for  $v$  may have no solution, a unique solution or an infinite number of solutions. We consider only the case that there is a unique solution for  $v$ . In this case the homogeneous equation subject to homogeneous boundary conditions has only the trivial solution.

The Green function for  $u$  satisfies

$$G''(x|\xi) + p(x)G'(x|\xi) + q(x)G(x|\xi) = \delta(x - \xi),$$

$$\alpha_1 G(a|\xi) + \alpha_2 G'(a|\xi) = 0, \quad \beta_1 G(b|\xi) + \beta_2 G'(b|\xi) = 0.$$

The continuity and jump conditions are

$$G(\xi^-|\xi) = G(\xi^+|\xi), \quad G'(\xi^-|\xi) + 1 = G'(\xi^+|\xi).$$

Let  $u_1$  and  $u_2$  be two solutions of the homogeneous equation that satisfy the left and right boundary conditions, respectively. The non-vanishing of the Wronskian ensures that these solutions exist. Let  $W(x)$  denote the Wronskian

of  $u_1$  and  $u_2$ . Since the homogeneous equation with homogeneous boundary conditions has only the trivial solution,  $W(x)$  is nonzero on  $[a, b]$ . The Green function has the form

$$G(x|\xi) = \begin{cases} c_1 u_1 & \text{for } x < \xi, \\ c_2 u_2 & \text{for } x > \xi. \end{cases}$$

The continuity and jump conditions for Green function gives us the equations

$$\begin{aligned} c_1 u_1(\xi) - c_2 u_2(\xi) &= 0 \\ c_1 u_1'(\xi) - c_2 u_2'(\xi) &= -1. \end{aligned}$$

Using Kramer's rule, the solution is

$$c_1 = \frac{u_2(\xi)}{W(\xi)}, \quad c_2 = \frac{u_1(\xi)}{W(\xi)}.$$

Thus the Green function is

$$G(x|\xi) = \begin{cases} \frac{u_1(x)u_2(\xi)}{W(\xi)} & \text{for } x < \xi, \\ \frac{u_1(\xi)u_2(x)}{W(\xi)} & \text{for } x > \xi. \end{cases}$$

The solution for  $u$  is

$$u = \int_a^b G(x|\xi) f(\xi) d\xi.$$

Thus if there is a unique solution for  $v$ , the solution for  $y$  is

$$y = v + \int_a^b G(x|\xi) f(\xi) d\xi.$$

**Result 21.7.4** Consider the problem

$$y'' + p(x)y' + q(x)y = f(x),$$

$$\alpha_1 y(a) + \alpha_2 y'(a) = \gamma_1, \quad \beta_1 y(b) + \beta_2 y'(b) = \gamma_2.$$

If the homogeneous differential equation subject to the inhomogeneous boundary conditions has the unique solution  $y_h$ , then the problem has the unique solution

$$y = y_h + \int_a^b G(x|\xi) f(\xi) d\xi$$

where

$$G(x|\xi) = \begin{cases} \frac{u_1(x)u_2(\xi)}{W(\xi)} & \text{for } x < \xi, \\ \frac{u_1(\xi)u_2(x)}{W(\xi)} & \text{for } x > \xi, \end{cases}$$

$u_1$  and  $u_2$  are solutions of the homogeneous differential equation that satisfy the left and right boundary conditions, respectively, and  $W(x)$  is the Wronskian of  $u_1$  and  $u_2$ .

## 21.7.4 Problems with Mixed Boundary Conditions

Consider

$$L[y] = y'' + p(x)y' + q(x)y = f(x), \quad \text{for } a < x < b,$$

subject to the mixed boundary conditions

$$B_1[y] = \alpha_{11}y(a) + \alpha_{12}y'(a) + \beta_{11}y(b) + \beta_{12}y'(b) = \gamma_1,$$

$$B_2[y] = \alpha_{21}y(a) + \alpha_{22}y'(a) + \beta_{21}y(b) + \beta_{22}y'(b) = \gamma_2.$$

The solution is  $y = u + v$  where

$$u'' + p(x)u' + q(x)u = f(x), \quad B_1[u] = 0, \quad B_2[u] = 0,$$

and

$$v'' + p(x)v' + q(x)v = 0, \quad B_1[v] = \gamma_1, \quad B_2[v] = \gamma_2.$$

The problem for  $v$  may have no solution, a unique solution or an infinite number of solutions. Again we consider only the case that there is a unique solution for  $v$ . In this case the homogeneous equation subject to homogeneous boundary conditions has only the trivial solution.

Let  $y_1$  and  $y_2$  be two solutions of the homogeneous equation that satisfy the boundary conditions  $B_1[y_1] = 0$  and  $B_2[y_2] = 0$ . Since the completely homogeneous problem has no solutions, we know that  $B_1[y_2]$  and  $B_2[y_1]$  are nonzero. The solution for  $v$  has the form

$$v = c_1 y_1 + c_2 y_2.$$

Applying the two boundary conditions yields

$$v = \frac{\gamma_2}{B_2[y_1]} y_1 + \frac{\gamma_1}{B_1[y_2]} y_2.$$

The Green function for  $u$  satisfies

$$G''(x|\xi) + p(x)G'(x|\xi) + q(x)G(x|\xi) = \delta(x - \xi), \quad B_1[G] = 0, \quad B_2[G] = 0.$$

The continuity and jump conditions are

$$G(\xi^-|\xi) = G(\xi^+|\xi), \quad G'(\xi^-|\xi) + 1 = G'(\xi^+|\xi).$$

We write the Green function as the sum of the causal solution and the two homogeneous solutions

$$G(x|\xi) = H(x - \xi)y_\xi(x) + c_1 y_1(x) + c_2 y_2(x)$$

With this form, the continuity and jump conditions are automatically satisfied. Applying the boundary conditions yields

$$\begin{aligned} B_1[G] &= B_1[H(x - \xi)y_\xi] + c_2 B_1[y_2] = 0, \\ B_2[G] &= B_2[H(x - \xi)y_\xi] + c_1 B_2[y_1] = 0, \end{aligned}$$

$$\begin{aligned} B_1[G] &= \beta_{11}y_\xi(b) + \beta_{12}y'_\xi(b) + c_2 B_1[y_2] = 0, \\ B_2[G] &= \beta_{21}y_\xi(b) + \beta_{22}y'_\xi(b) + c_1 B_2[y_1] = 0, \end{aligned}$$

$$G(x|\xi) = H(x - \xi)y_\xi(x) - \frac{\beta_{21}y_\xi(b) + \beta_{22}y'_\xi(b)}{B_2[y_1]}y_1(x) - \frac{\beta_{11}y_\xi(b) + \beta_{12}y'_\xi(b)}{B_1[y_2]}y_2(x).$$

Note that the Green function is well defined since  $B_2[y_1]$  and  $B_1[y_2]$  are nonzero. The solution for  $u$  is

$$u = \int_a^b G(x|\xi)f(\xi) d\xi.$$

Thus if there is a unique solution for  $v$ , the solution for  $y$  is

$$y = \int_a^b G(x|\xi)f(\xi) d\xi + \frac{\gamma_2}{B_2[y_1]}y_1 + \frac{\gamma_1}{B_1[y_2]}y_2.$$

**Result 21.7.5** Consider the problem

$$y'' + p(x)y' + q(x)y = f(x),$$

$$B_1[y] = \alpha_{11}y(a) + \alpha_{12}y'(a) + \beta_{11}y(b) + \beta_{12}y'(b) = \gamma_1,$$

$$B_2[y] = \alpha_{21}y(a) + \alpha_{22}y'(a) + \beta_{21}y(b) + \beta_{22}y'(b) = \gamma_2.$$

If the homogeneous differential equation subject to the homogeneous boundary conditions has no solution, then the problem has the unique solution

$$y = \int_a^b G(x|\xi)f(\xi) d\xi + \frac{\gamma_2}{B_2[y_1]}y_1 + \frac{\gamma_1}{B_1[y_2]}y_2,$$

where

$$G(x|\xi) = H(x - \xi)y_\xi(x) - \frac{\beta_{21}y_\xi(b) + \beta_{22}y'_\xi(b)}{B_2[y_1]}y_1(x) - \frac{\beta_{11}y_\xi(b) + \beta_{12}y'_\xi(b)}{B_1[y_2]}y_2(x),$$

$y_1$  and  $y_2$  are solutions of the homogeneous differential equation that satisfy the first and second boundary conditions, respectively, and  $y_\xi(x)$  is the solution of the homogeneous equation that satisfies  $y_\xi(\xi) = 0$ ,  $y'_\xi(\xi) = 1$ .

## 21.8 Green Functions for Higher Order Problems

Consider the  $n_{th}$  order differential equation

$$L[y] = y^{(n)} + p_{n-1}(x)y^{(n-1)} + \cdots + p_1(x)y' + p_0y = f(x) \quad \text{on } a < x < b,$$

subject to the  $n$  independent boundary conditions

$$B_j[y] = \gamma_j$$

where the boundary conditions are of the form

$$B[y] \equiv \sum_{k=0}^{n-1} \alpha_k y^{(k)}(a) + \sum_{k=0}^{n-1} \beta_k y^{(k)}(b).$$

We assume that the coefficient functions in the differential equation are continuous on  $[a, b]$ . The solution is  $y = u + v$  where  $u$  and  $v$  satisfy

$$L[u] = f(x), \quad \text{with} \quad B_j[u] = 0,$$

and

$$L[v] = 0, \quad \text{with} \quad B_j[v] = \gamma_j$$

From Result 21.5.3, we know that if the completely homogeneous problem

$$L[w] = 0, \quad \text{with} \quad B_j[w] = 0,$$

has only the trivial solution, then the solution for  $y$  exists and is unique. We will construct this solution using Green functions.



First we consider the problem for  $v$ . Let  $\{y_1, \dots, y_n\}$  be a set of linearly independent solutions. The solution for  $v$  has the form

$$v = c_1 y_1 + \cdots + c_n y_n$$

where the constants are determined by the matrix equation

$$\begin{pmatrix} B_1[y_1] & B_1[y_2] & \cdots & B_1[y_n] \\ B_2[y_1] & B_2[y_2] & \cdots & B_2[y_n] \\ \vdots & \vdots & \ddots & \vdots \\ B_n[y_1] & B_n[y_2] & \cdots & B_n[y_n] \end{pmatrix} \begin{pmatrix} c_1 \\ c_2 \\ \vdots \\ c_n \end{pmatrix} = \begin{pmatrix} \gamma_1 \\ \gamma_2 \\ \vdots \\ \gamma_n \end{pmatrix}.$$

To solve the problem for  $u$  we consider the Green function satisfying

$$L[G(x|\xi)] = \delta(x - \xi), \quad \text{with} \quad B_j[G] = 0.$$

Let  $y_\xi(x)$  be the linear combination of the homogeneous solutions that satisfy the conditions

$$\begin{aligned} y_\xi(\xi) &= 0 \\ y'_\xi(\xi) &= 0 \\ &\vdots = \vdots \\ y_\xi^{(n-2)}(\xi) &= 0 \\ y_\xi^{(n-1)}(\xi) &= 1. \end{aligned}$$

The causal solution is then

$$y_c(x) = H(x - \xi)y_\xi(x).$$

The Green function has the form

$$G(x|\xi) = H(x - \xi)y_\xi(x) + d_1 y_1(x) + \cdots + d_n y_n(x)$$

The constants are determined by the matrix equation

$$\begin{pmatrix} B_1[y_1] & B_1[y_2] & \cdots & B_1[y_n] \\ B_2[y_1] & B_2[y_2] & \cdots & B_2[y_n] \\ \vdots & \vdots & \ddots & \vdots \\ B_n[y_1] & B_n[y_2] & \cdots & B_n[y_n] \end{pmatrix} \begin{pmatrix} d_1 \\ d_2 \\ \vdots \\ d_n \end{pmatrix} = \begin{pmatrix} -B_1[H(x-\xi)y_\xi(x)] \\ -B_2[H(x-\xi)y_\xi(x)] \\ \vdots \\ -B_n[H(x-\xi)y_\xi(x)] \end{pmatrix}.$$

The solution for  $u$  then is

$$u = \int_a^b G(x|\xi)f(\xi) d\xi.$$

**Result 21.8.1** Consider the  $n_{th}$  order differential equation

$$L[y] = y^{(n)} + p_{n-1}(x)y^{(n-1)} + \cdots + p_1(x)y' + p_0y = f(x) \quad \text{on } a < x < b,$$

subject to the  $n$  independent boundary conditions

$$B_j[y] = \gamma_j$$

If the homogeneous differential equation subject to the homogeneous boundary conditions has only the trivial solution, then the problem has the unique solution

$$y = \int_a^b G(x|\xi)f(\xi) d\xi + c_1y_1 + \cdots + c_ny_n$$

where

$$G(x|\xi) = H(x-\xi)y_\xi(x) + d_1y_1(x) + \cdots + d_ny_n(x),$$

$\{y_1, \dots, y_n\}$  is a set of solutions of the homogeneous differential equation, and the constants  $c_j$  and  $d_j$  can be determined by solving sets of linear equations.

**Example 21.8.1** Consider the problem

$$y''' - y'' + y' - y = f(x),$$
$$y(0) = 1, \quad y'(0) = 2, \quad y(1) = 3.$$

The completely homogeneous associated problem is

$$w''' - w'' + w' - w = 0, \quad w(0) = w'(0) = w(1) = 0.$$

The solution of the differential equation is

$$w = c_1 \cos x + c_2 \sin x + c_3 e^x.$$

The boundary conditions give us the equation

$$\begin{pmatrix} 1 & 0 & 1 \\ 0 & 1 & 1 \\ \cos 1 & \sin 1 & e \end{pmatrix} \begin{pmatrix} c_1 \\ c_2 \\ c_3 \end{pmatrix} = \begin{pmatrix} 0 \\ 0 \\ 0 \end{pmatrix}.$$

The determinant of the matrix is  $e - \cos 1 - \sin 1 \neq 0$ . Thus the homogeneous problem has only the trivial solution and the inhomogeneous problem has a unique solution.

We separate the inhomogeneous problem into the two problems

$$u''' - u'' + u' - u = f(x), \quad u(0) = u'(0) = u(1) = 0,$$

$$v''' - v'' + v' - v = 0, \quad v(0) = 1, \quad v'(0) = 2, \quad v(1) = 3,$$

First we solve the problem for  $v$ . The solution of the differential equation is

$$v = c_1 \cos x + c_2 \sin x + c_3 e^x.$$

The boundary conditions yields the equation

$$\begin{pmatrix} 1 & 0 & 1 \\ 0 & 1 & 1 \\ \cos 1 & \sin 1 & e \end{pmatrix} \begin{pmatrix} c_1 \\ c_2 \\ c_3 \end{pmatrix} = \begin{pmatrix} 1 \\ 2 \\ 3 \end{pmatrix}.$$

The solution for  $v$  is

$$v = \frac{1}{e - \cos 1 - \sin 1} [(e + \sin 1 - 3) \cos x + (2e - \cos 1 - 3) \sin x + (3 - \cos 1 - 2 \sin 1) e^x].$$

Now we find the Green function for the problem in  $u$ . The causal solution is

$$H(x - \xi)u_\xi(x) = H(x - \xi)\frac{1}{2}[(\sin \xi - \cos \xi) \cos x - (\sin \xi + \cos \xi) \sin \xi + e^{-\xi} e^x],$$

$$H(x - \xi)u_\xi(x) = \frac{1}{2}H(x - \xi)[e^{x-\xi} - \cos(x - \xi) - \sin(x - \xi)].$$

The Green function has the form

$$G(x|\xi) = H(x - \xi)u_\xi(x) + c_1 \cos x + c_2 \sin x + c_3 e^x.$$

The constants are determined by the three conditions

$$\begin{aligned} [c_1 \cos x + c_2 \sin x + c_3 e^x]_{x=0} &= 0, \\ \left[ \frac{\partial}{\partial x} (c_1 \cos x + c_2 \sin x + c_3 e^x) \right]_{x=0} &= 0, \\ [u_\xi(x) + c_1 \cos x + c_2 \sin x + c_3 e^x]_{x=1} &= 0. \end{aligned}$$

The Green function is

$$G(x|\xi) = \frac{1}{2}H(x - \xi)[e^{x-\xi} - \cos(x - \xi) - \sin(x - \xi)] + \frac{\cos(1 - \xi) + \sin(1 - \xi) - e^{1-\xi}}{2(\cos 1 + \sin 1 - e)} [\cos x + \sin x - e^x]$$

The solution for  $v$  is

$$v = \int_0^1 G(x|\xi)f(\xi) d\xi.$$

Thus the solution for  $y$  is

$$y = \int_0^1 G(x|\xi)f(\xi) d\xi + \frac{1}{e - \cos 1 - \sin 1} [(e + \sin 1 - 3) \cos x + (2e - \cos 1 - 3) \sin x + (3 - \cos 1 - 2 \sin 1) e^x].$$

## 21.9 Fredholm Alternative Theorem

**Orthogonality.** Two real vectors,  $u$  and  $v$  are orthogonal if  $u \cdot v = 0$ . Consider two functions,  $u(x)$  and  $v(x)$ , defined in  $[a, b]$ . The dot product in vector space is analogous to the integral

$$\int_a^b u(x)v(x) dx$$

in function space. Thus two real functions are orthogonal if

$$\int_a^b u(x)v(x) dx = 0.$$

Consider the  $n^{\text{th}}$  order linear inhomogeneous differential equation

$$L[y] = f(x) \quad \text{on } [a, b],$$

subject to the linear inhomogeneous boundary conditions

$$B_j[y] = 0, \quad \text{for } j = 1, 2, \dots, n.$$

The Fredholm alternative theorem tells us if the problem has a unique solution, an infinite number of solutions, or no solution. Before presenting the theorem, we will consider a few motivating examples.

**No Nontrivial Homogeneous Solutions.** In the section on Green functions we showed that if the completely homogeneous problem has only the trivial solution then the inhomogeneous problem has a unique solution.

**Nontrivial Homogeneous Solutions Exist.** If there are nonzero solutions to the homogeneous problem  $L[y] = 0$  that satisfy the homogeneous boundary conditions  $B_j[y] = 0$  then the inhomogeneous problem  $L[y] = f(x)$  subject to the same boundary conditions either has no solution or an infinite number of solutions.

Suppose there is a particular solution  $y_p$  that satisfies the boundary conditions. If there is a solution  $y_h$  to the homogeneous equation that satisfies the boundary conditions then there will be an infinite number of solutions since  $y_p + cy_h$  is also a particular solution.

The question now remains: Given that there are homogeneous solutions that satisfy the boundary conditions, how do we know if a particular solution that satisfies the boundary conditions exists? Before we address this question we will consider a few examples.

**Example 21.9.1** *Consider the problem*

$$y'' + y = \cos x, \quad y(0) = y(\pi) = 0.$$

*The two homogeneous solutions of the differential equation are*

$$y_1 = \cos x, \quad \text{and} \quad y_2 = \sin x.$$

*$y_2 = \sin x$  satisfies the boundary conditions. Thus we know that there are either no solutions or an infinite number of*

solutions. A particular solution is

$$\begin{aligned}y_p &= -\cos x \int \frac{\cos x \sin x}{1} dx + \sin x \int \frac{\cos^2 x}{1} dx \\&= -\cos x \int \frac{1}{2} \sin(2x) dx + \sin x \int \left( \frac{1}{2} + \frac{1}{2} \cos(2x) \right) dx \\&= \frac{1}{4} \cos x \cos(2x) + \sin x \left( \frac{1}{2}x + \frac{1}{4} \sin(2x) \right) \\&= \frac{1}{2}x \sin x + \frac{1}{4} [\cos x \cos(2x) + \sin x \sin(2x)] \\&= \frac{1}{2}x \sin x + \frac{1}{4} \cos x\end{aligned}$$

The general solution is

$$y = \frac{1}{2}x \sin x + c_1 \cos x + c_2 \sin x.$$

Applying the two boundary conditions yields

$$y = \frac{1}{2}x \sin x + c \sin x.$$

Thus there are an infinite number of solutions.

**Example 21.9.2** Consider the differential equation

$$y'' + y = \sin x, \quad y(0) = y(\pi) = 0.$$

The general solution is

$$y = -\frac{1}{2}x \cos x + c_1 \cos x + c_2 \sin x.$$

*Applying the boundary conditions,*

$$\begin{aligned}y(0) = 0 &\rightarrow c_1 = 0 \\y(\pi) = 0 &\rightarrow -\frac{1}{2}\pi \cos(\pi) + c_2 \sin(\pi) = 0 \\&\rightarrow \frac{\pi}{2} = 0.\end{aligned}$$

*Since this equation has no solution, there are no solutions to the inhomogeneous problem.*

In both of the above examples there is a homogeneous solution  $y = \sin x$  that satisfies the boundary conditions. In Example 21.9.1, the inhomogeneous term is  $\cos x$  and there are an infinite number of solutions. In Example 21.9.2, the inhomogeneity is  $\sin x$  and there are no solutions. In general, if the inhomogeneous term is orthogonal to all the homogeneous solutions that satisfy the boundary conditions then there are an infinite number of solutions. If not, there are no inhomogeneous solutions.



**Result 21.9.1 Fredholm Alternative Theorem.** Consider the  $n^{\text{th}}$  order inhomogeneous problem

$$L[y] = f(x) \quad \text{on} \quad [a, b] \quad \text{subject to} \quad B_j[y] = 0 \quad \text{for} \quad j = 1, 2, \dots, n,$$

and the associated homogeneous problem

$$L[y] = 0 \quad \text{on} \quad [a, b] \quad \text{subject to} \quad B_j[y] = 0 \quad \text{for} \quad j = 1, 2, \dots, n.$$

If the homogeneous problem has only the trivial solution then the inhomogeneous problem has a unique solution. If the homogeneous problem has  $m$  independent solutions,  $\{y_1, y_2, \dots, y_m\}$ , then there are two possibilities:

- If  $f(x)$  is orthogonal to each of the homogeneous solutions then there are an infinite number of solutions of the form

$$y = y_p + \sum_{j=1}^m c_j y_j.$$

- If  $f(x)$  is not orthogonal to each of the homogeneous solutions then there are no inhomogeneous solutions.

**Example 21.9.3** Consider the problem

$$y'' + y = \cos 2x, \quad y(0) = 1, \quad y(\pi) = 2.$$

$\cos x$  and  $\sin x$  are two linearly independent solutions to the homogeneous equation.  $\sin x$  satisfies the homogeneous boundary conditions. Thus there are either an infinite number of solutions, or no solution.

To transform this problem to one with homogeneous boundary conditions, we note that  $g(x) = \frac{x}{\pi} + 1$  and make the change of variables  $y = u + g$  to obtain

$$u'' + u = \cos 2x - \frac{x}{\pi} - 1, \quad y(0) = 0, \quad y(\pi) = 0.$$

Since  $\cos 2x - \frac{x}{\pi} - 1$  is not orthogonal to  $\sin x$ , there is no solution to the inhomogeneous problem.

To check this, the general solution is

$$y = -\frac{1}{3} \cos 2x + c_1 \cos x + c_2 \sin x.$$

Applying the boundary conditions,

$$\begin{aligned} y(0) = 1 &\quad \rightarrow \quad c_1 = \frac{4}{3} \\ y(\pi) = 2 &\quad \rightarrow \quad -\frac{1}{3} - \frac{4}{3} = 2. \end{aligned}$$

Thus we see that the right boundary condition cannot be satisfied.

**Example 21.9.4** Consider

$$y'' + y = \cos 2x, \quad y'(0) = y(\pi) = 1.$$

There are no solutions to the homogeneous equation that satisfy the homogeneous boundary conditions. To check this, note that all solutions of the homogeneous equation have the form  $u_h = c_1 \cos x + c_2 \sin x$ .

$$\begin{aligned} u'_h(0) = 0 &\quad \rightarrow \quad c_2 = 0 \\ u_h(\pi) = 0 &\quad \rightarrow \quad c_1 = 0. \end{aligned}$$

From the Fredholm Alternative Theorem we see that the inhomogeneous problem has a unique solution.

To find the solution, start with

$$y = -\frac{1}{3} \cos 2x + c_1 \cos x + c_2 \sin x.$$

$$\begin{aligned} y'(0) = 1 &\quad \rightarrow \quad c_2 = 1 \\ y(\pi) = 1 &\quad \rightarrow \quad -\frac{1}{3} - c_1 = 1 \end{aligned}$$

Thus the solution is

$$y = -\frac{1}{3} \cos 2x - \frac{4}{3} \cos x + \sin x.$$

**Example 21.9.5** Consider

$$y'' + y = \cos 2x, \quad y(0) = \frac{2}{3}, \quad y(\pi) = -\frac{4}{3}.$$

$\cos x$  and  $\sin x$  satisfy the homogeneous differential equation.  $\sin x$  satisfies the homogeneous boundary conditions. Since  $g(x) = \cos x - 1/3$  satisfies the boundary conditions, the substitution  $y = u + g$  yields

$$u'' + u = \cos 2x + \frac{1}{3}, \quad y(0) = 0, \quad y(\pi) = 0.$$

Now we check if  $\sin x$  is orthogonal to  $\cos 2x + \frac{1}{3}$ .

$$\begin{aligned} \int_0^\pi \sin x \left( \cos 2x + \frac{1}{3} \right) dx &= \int_0^\pi \frac{1}{2} \sin 3x - \frac{1}{2} \sin x + \frac{1}{3} \sin x dx \\ &= \left[ -\frac{1}{6} \cos 3x + \frac{1}{6} \cos x \right]_0^\pi \\ &= 0 \end{aligned}$$

Since  $\sin x$  is orthogonal to the inhomogeneity, there are an infinite number of solutions to the problem for  $u$ , (and hence the problem for  $y$ ).

As a check, then general solution for  $y$  is

$$y = -\frac{1}{3} \cos 2x + c_1 \cos x + c_2 \sin x.$$

Applying the boundary conditions,

$$y(0) = \frac{2}{3} \quad \rightarrow \quad c_1 = 1$$
$$y(\pi) = -\frac{4}{3} \quad \rightarrow \quad -\frac{4}{3} = -\frac{4}{3}.$$

Thus we see that  $c_2$  is arbitrary. There are an infinite number of solutions of the form

$$y = -\frac{1}{3} \cos 2x + \cos x + c \sin x.$$

## 21.10 Exercises

### Undetermined Coefficients

#### Exercise 21.1 (mathematica/ode/inhomogeneous/undetermined.nb)

Find the general solution of the following equations.

1.  $y'' + 2y' + 5y = 3 \sin(2t)$
2.  $2y'' + 3y' + y = t^2 + 3 \sin(t)$

Hint, Solution

#### Exercise 21.2 (mathematica/ode/inhomogeneous/undetermined.nb)

Find the solution of each one of the following initial value problems.

1.  $y'' - 2y' + y = t e^t + 4$ ,  $y(0) = 1$ ,  $y'(0) = 1$
2.  $y'' + 2y' + 5y = 4 e^{-t} \cos(2t)$ ,  $y(0) = 1$ ,  $y'(0) = 0$

Hint, Solution

### Variation of Parameters

#### Exercise 21.3 (mathematica/ode/inhomogeneous/variation.nb)

Use the method of variation of parameters to find a particular solution of the given differential equation.

1.  $y'' - 5y' + 6y = 2 e^t$
2.  $y'' + y = \tan(t)$ ,  $0 < t < \pi/2$
3.  $y'' - 5y' + 6y = g(t)$ , for a given function  $g$ .

Hint, Solution

**Exercise 21.4 (mathematica/ode/inhomogeneous/variation.nb)**

Solve

$$y''(x) + y(x) = x, \quad y(0) = 1, \quad y'(0) = 0.$$

Hint, Solution

**Exercise 21.5 (mathematica/ode/inhomogeneous/variation.nb)**

Solve

$$x^2 y''(x) - x y'(x) + y(x) = x.$$

Hint, Solution

**Exercise 21.6 (mathematica/ode/inhomogeneous/variation.nb)**1. Find the general solution of  $y'' + y = e^x$ .2. Solve  $y'' + \lambda^2 y = \sin x$ ,  $y(0) = y'(0) = 0$ .  $\lambda$  is an arbitrary real constant. Is there anything special about  $\lambda = 1$ ?

Hint, Solution

**Exercise 21.7 (mathematica/ode/inhomogeneous/variation.nb)**

Consider the problem of solving the initial value problem

$$y'' + y = g(t), \quad y(0) = 0, \quad y'(0) = 0.$$

1. Show that the general solution of  $y'' + y = g(t)$  is

$$y(t) = \left( c_1 - \int_a^t g(\tau) \sin \tau \, d\tau \right) \cos t + \left( c_2 + \int_b^t g(\tau) \cos \tau \, d\tau \right) \sin t,$$

where  $c_1$  and  $c_2$  are arbitrary constants and  $a$  and  $b$  are any conveniently chosen points.2. Using the result of part (a) show that the solution satisfying the initial conditions  $y(0) = 0$  and  $y'(0) = 0$  is given by

$$y(t) = \int_0^t g(\tau) \sin(t - \tau) \, d\tau.$$

Notice that this equation gives a formula for computing the solution of the original initial value problem for any given inhomogeneous term  $g(t)$ . The integral is referred to as the *convolution* of  $g(t)$  with  $\sin t$ .

3. Use the result of part (b) to solve the initial value problem,

$$y'' + y = \sin(\lambda t), \quad y(0) = 0, \quad y'(0) = 0,$$

where  $\lambda$  is a real constant. How does the solution for  $\lambda = 1$  differ from that for  $\lambda \neq 1$ ? The  $\lambda = 1$  case provides an example of *resonant forcing*. Plot the solution for resonant and non-resonant forcing.

Hint, Solution

### Exercise 21.8

Find the variation of parameters solution for the third order differential equation

$$y''' + p_2(x)y'' + p_1(x)y' + p_0(x)y = f(x).$$

Hint, Solution

## Green Functions

### Exercise 21.9

Use a Green function to solve

$$y'' = f(x), \quad y(-\infty) = y'(-\infty) = 0.$$

Verify the the solution satisfies the differential equation.

Hint, Solution

### Exercise 21.10

Solve the initial value problem

$$y'' + \frac{1}{x}y' - \frac{1}{x^2}y = x^2, \quad y(0) = 0, \quad y'(0) = 1.$$

First use variation of parameters, and then solve the problem with a Green function.

Hint, Solution

**Exercise 21.11**

What are the continuity conditions at  $x = \xi$  for the Green function for the problem

$$y''' + p_2(x)y'' + p_1(x)y' + p_0(x)y = f(x).$$

Hint, Solution

**Exercise 21.12**

Use variation of parameters and Green functions to solve

$$x^2y'' - 2xy' + 2y = e^{-x}, \quad y(1) = 0, \quad y'(1) = 1.$$

Hint, Solution

**Exercise 21.13**

Find the Green function for

$$y'' - y = f(x), \quad y'(0) = y(1) = 0.$$

Hint, Solution

**Exercise 21.14**

Find the Green function for

$$y'' - y = f(x), \quad y(0) = y(\infty) = 0.$$

Hint, Solution

**Exercise 21.15**

Find the Green function for each of the following:

a)  $xu'' + u' = f(x)$ ,  $u(0^+)$  bounded,  $u(1) = 0$ .

b)  $u'' - u = f(x)$ ,  $u(-a) = u(a) = 0$ .

c)  $u'' - u = f(x)$ ,  $u(x)$  bounded as  $|x| \rightarrow \infty$ .



d) Show that the Green function for (b) approaches that for (c) as  $a \rightarrow \infty$ .

**Hint, Solution**

### Exercise 21.16

1. For what values of  $\lambda$  does the problem

$$y'' + \lambda y = f(x), \quad y(0) = y(\pi) = 0, \quad (21.5)$$

have a unique solution? Find the Green functions for these cases.

2. For what values of  $\alpha$  does the problem

$$y'' + 9y = 1 + \alpha x, \quad y(0) = y(\pi) = 0,$$

have a solution? Find the solution.

3. For  $\lambda = n^2$ ,  $n \in \mathbb{Z}^+$  state in general the conditions on  $f$  in Equation 21.5 so that a solution will exist. What is the appropriate modified Green function (in terms of eigenfunctions)?

**Hint, Solution**

### Exercise 21.17

Show that the inhomogeneous boundary value problem:

$$Lu \equiv (pu')' + qu = f(x), \quad a < x < b, \quad u(a) = \alpha, \quad u(b) = \beta$$

has the solution:

$$u(x) = \int_a^b g(x; \xi) f(\xi) d\xi - \alpha p(a) g_\xi(x; a) + \beta p(b) g_\xi(x; b).$$

**Hint, Solution**

### Exercise 21.18

The Green function for

$$u'' - k^2 u = f(x), \quad -\infty < x < \infty$$

subject to  $|u(\pm\infty)| < \infty$  is

$$G(x; \xi) = -\frac{1}{2k} e^{-k|x-\xi|}.$$

(We assume that  $k > 0$ .) Use the image method to find the Green function for the same equation on the semi-infinite interval  $0 < x < \infty$  satisfying the boundary conditions,

- i)  $u(0) = 0 \quad |u(\infty)| < \infty,$
- ii)  $u'(0) = 0 \quad |u(\infty)| < \infty.$

Express these results in simplified forms without absolute values.

**Hint, Solution**

### Exercise 21.19

1. Determine the Green function for solving:

$$y'' - a^2y = f(x), \quad y(0) = y'(L) = 0.$$

2. Take the limit as  $L \rightarrow \infty$  to find the Green function on  $(0, \infty)$  for the boundary conditions:  $y(0) = 0, y'(\infty) = 0$ . We assume here that  $a > 0$ . Use the limiting Green function to solve:

$$y'' - a^2y = e^{-x}, \quad y(0) = 0, \quad y'(\infty) = 0.$$

Check that your solution satisfies all the conditions of the problem.

**Hint, Solution**

## 21.11 Hints

### Undetermined Coefficients

Hint 21.1

Hint 21.2

### Variation of Parameters

Hint 21.3

Hint 21.4

Hint 21.5

Hint 21.6

Hint 21.7

Hint 21.8

Look for a particular solution of the form

$$y_p = u_1y_1 + u_2y_2 + u_3y_3,$$

where the  $y_j$ 's are homogeneous solutions. Impose the constraints

$$u'_1 y_1 + u'_2 y_2 + u'_3 y_3 = 0$$

$$u'_1 y'_1 + u'_2 y'_2 + u'_3 y'_3 = 0.$$

To avoid some messy algebra when solving for  $u'_j$ , use Kramer's rule.

## Green Functions

**Hint 21.9**

**Hint 21.10**

**Hint 21.11**

**Hint 21.12**

**Hint 21.13**

$\cosh(x)$  and  $\sinh(x - 1)$  are homogeneous solutions that satisfy the left and right boundary conditions, respectively.

**Hint 21.14**

$\sinh(x)$  and  $e^{-x}$  are homogeneous solutions that satisfy the left and right boundary conditions, respectively.

**Hint 21.15**

The Green function for the differential equation

$$L[y] \equiv \frac{d}{dx}(p(x)y') + q(x)y = f(x),$$

subject to unmixed, homogeneous boundary conditions is

$$G(x|\xi) = \frac{y_1(x_<)y_2(x_>)}{p(\xi)W(\xi)},$$

$$G(x|\xi) = \begin{cases} \frac{y_1(x)y_2(\xi)}{p(\xi)W(\xi)} & \text{for } a \leq x \leq \xi, \\ \frac{y_1(\xi)y_2(x)}{p(\xi)W(\xi)} & \text{for } \xi \leq x \leq b, \end{cases}$$

where  $y_1$  and  $y_2$  are homogeneous solutions that satisfy the left and right boundary conditions, respectively.

Recall that if  $y(x)$  is a solution of a homogeneous, constant coefficient differential equation then  $y(x + c)$  is also a solution.

### Hint 21.16

The problem has a Green function if and only if the inhomogeneous problem has a unique solution. The inhomogeneous problem has a unique solution if and only if the homogeneous problem has only the trivial solution.

### Hint 21.17

Show that  $g_\xi(x; a)$  and  $g_\xi(x; b)$  are solutions of the homogeneous differential equation. Determine the value of these solutions at the boundary.

### Hint 21.18

### Hint 21.19

## 21.12 Solutions

### Undetermined Coefficients

#### Solution 21.1

1. We consider

$$y'' + 2y' + 5y = 3 \sin(2t).$$

We first find the homogeneous solution with the substitution  $y = e^{\lambda t}$ .

$$\lambda^2 + 2\lambda + 5 = 0$$

$$\lambda = -1 \pm 2i$$

The homogeneous solution is

$$y_h = c_1 e^{-t} \cos(2t) + c_2 e^{-t} \sin(2t).$$

We guess a particular solution of the form

$$y_p = a \cos(2t) + b \sin(2t).$$

We substitute this into the differential equation to determine the coefficients.

$$\begin{aligned} y_p'' + 2y_p' + 5y_p &= 3 \sin(2t) \\ -4a \cos(2t) - 4b \sin(2t) - 4a \sin(2t) + 4b \sin(2t) + 5a \cos(2t) + 5b \sin(2t) &= -3 \sin(2t) \\ (a + 4b) \cos(2t) + (-3 - 4a + b) \sin(2t) &= 0 \\ a + 4b &= 0, \quad -4a + b = 3 \\ a &= -\frac{12}{17}, \quad b = \frac{3}{17} \end{aligned}$$

A particular solution is

$$y_p = \frac{3}{17}(\sin(2t) - 4 \cos(2t)).$$

The general solution of the differential equation is

$$y = c_1 e^{-t} \cos(2t) + c_2 e^{-t} \sin(2t) + \frac{3}{17}(\sin(2t) - 4 \cos(2t)).$$

2. We consider

$$2y'' + 3y' + y = t^2 + 3 \sin(t)$$

We first find the homogeneous solution with the substitution  $y = e^{\lambda t}$ .

$$2\lambda^2 + 3\lambda + 1 = 0$$

$$\lambda = \{-1, -1/2\}$$

The homogeneous solution is

$$y_h = c_1 e^{-t} + c_2 e^{-t/2}.$$

We guess a particular solution of the form

$$y_p = at^2 + bt + c + d \cos(t) + e \sin(t).$$

We substitute this into the differential equation to determine the coefficients.

$$2y_p'' + 3y_p' + y_p = t^2 + 3 \sin(t)$$

$$2(2a - d \cos(t) - e \sin(t)) + 3(2at + b - d \sin(t) + e \cos(t)) + at^2 + bt + c + d \cos(t) + e \sin(t) = t^2 + 3 \sin(t)$$

$$(a - 1)t^2 + (6a + b)t + (4a + 3b + c) + (-d + 3e) \cos(t) - (3 + 3d + e) \sin(t) = 0$$

$$a - 1 = 0, \quad 6a + b = 0, \quad 4a + 3b + c = 0, \quad -d + 3e = 0, \quad 3 + 3d + e = 0$$

$$a = 1, \quad b = -6, \quad c = 14, \quad d = -\frac{9}{10}, \quad e = -\frac{3}{10}$$

A particular solution is

$$y_p = t^2 - 6t + 14 - \frac{3}{10}(3 \cos(t) + \sin(t)).$$

The general solution of the differential equation is

$$y = c_1 e^{-t} + c_2 e^{-t/2} + t^2 - 6t + 14 - \frac{3}{10}(3 \cos(t) + \sin(t)).$$

### Solution 21.2

1. We consider the problem

$$y'' - 2y' + y = t e^t + 4, \quad y(0) = 1, \quad y'(0) = 1.$$

First we solve the homogeneous equation with the substitution  $y = e^{\lambda t}$ .

$$\lambda^2 - 2\lambda + 1 = 0$$

$$(\lambda - 1)^2 = 0$$

$$\lambda = 1$$

The homogeneous solution is

$$y_h = c_1 e^t + c_2 t e^t.$$

We guess a particular solution of the form

$$y_p = at^3 e^t + bt^2 e^t + 4.$$

We substitute this into the inhomogeneous differential equation to determine the coefficients.

$$y_p'' - 2y_p' + y_p = t e^t + 4$$

$$(a(t^3 + 6t^2 + 6t) + b(t^2 + 4t + 2)) e^t - 2(a(t^2 + 3t) + b(t + 2)) e^t + at^3 e^t + bt^2 e^t + 4 = t e^t + 4$$

$$(6a - 1)t + 2b = 0$$

$$6a - 1 = 0, \quad 2b = 0$$

$$a = \frac{1}{6}, \quad b = 0$$



A particular solution is

$$y_p = \frac{t^3}{6} e^t + 4.$$

The general solution of the differential equation is

$$y = c_1 e^t + c_2 t e^t + \frac{t^3}{6} e^t + 4.$$

We use the initial conditions to determine the constants of integration.

$$\begin{aligned} y(0) &= 1, & y'(0) &= 1 \\ c_1 + 4 &= 1, & c_1 + c_2 &= 1 \\ c_1 &= -3, & c_2 &= 4 \end{aligned}$$

The solution of the initial value problem is

$$y = \left( \frac{t^3}{6} + 4t - 3 \right) e^t + 4.$$

2. We consider the problem

$$y'' + 2y' + 5y = 4e^{-t} \cos(2t), \quad y(0) = 1, \quad y'(0) = 0.$$

First we solve the homogeneous equation with the substitution  $y = e^{\lambda t}$ .

$$\begin{aligned} \lambda^2 + 2\lambda + 5 &= 0 \\ \lambda &= -1 \pm \sqrt{1 - 5} \\ \lambda &= -1 \pm i2 \end{aligned}$$

The homogeneous solution is

$$y_h = c_1 e^{-t} \cos(2t) + c_2 e^{-t} \sin(2t).$$

We guess a particular solution of the form

$$y_p = t e^{-t}(a \cos(2t) + b \sin(2t))$$

We substitute this into the inhomogeneous differential equation to determine the coefficients.

$$y_p'' + 2y_p' + 5y_p = 4 e^{-t} \cos(2t)$$

$$\begin{aligned} e^{-t}((-2 + 3t)a + 4(1 - t)b) \cos(2t) + (4(t - 1)a - (2 + 3t)b) \sin(2t) \\ + 2 e^{-t}(((1 - t)a + 2tb) \cos(2t) + (-2ta + (1 - t)b) \sin(2t)) \\ + 5(e^{-t}(ta \cos(2t) + tb \sin(2t))) = 4 e^{-t} \cos(2t) \end{aligned}$$

$$\begin{aligned} 4(b - 1) \cos(2t) - 4a \sin(2t) &= 0 \\ a = 0, \quad b &= 1 \end{aligned}$$

A particular solution is

$$y_p = t e^{-t} \sin(2t).$$

The general solution of the differential equation is

$$y = c_1 e^{-t} \cos(2t) + c_2 e^{-t} \sin(2t) + t e^{-t} \sin(2t).$$

We use the initial conditions to determine the constants of integration.

$$\begin{aligned} y(0) &= 1, \quad y'(0) = 0 \\ c_1 &= 1, \quad -c_1 + 2c_2 = 0 \\ c_1 &= 1, \quad c_2 = \frac{1}{2} \end{aligned}$$

The solution of the initial value problem is

$$y = \frac{1}{2} e^{-t} (2 \cos(2t) + (2t + 1) \sin(2t)).$$

## Variation of Parameters

### Solution 21.3

1. We consider the equation

$$y'' - 5y' + 6y = 2e^t.$$

We find homogeneous solutions with the substitution  $y = e^{\lambda t}$ .

$$\lambda^2 - 5\lambda + 6 = 0$$

$$\lambda = \{2, 3\}$$

The homogeneous solutions are

$$y_1 = e^{2t}, \quad y_2 = e^{3t}.$$

We compute the Wronskian of these solutions.

$$W(t) = \begin{vmatrix} e^{2t} & e^{3t} \\ 2e^{2t} & 3e^{3t} \end{vmatrix} = e^{5t}$$

We find a particular solution with variation of parameters.

$$\begin{aligned} y_p &= -e^{2t} \int \frac{2e^t e^{3t}}{e^{5t}} dt + e^{3t} \int \frac{2e^t e^{2t}}{e^{5t}} dt \\ &= -2e^{2t} \int e^{-t} dt + 2e^{3t} \int e^{-2t} dt \\ &= 2e^t - e^t \end{aligned}$$

$$\boxed{y_p = e^t}$$

2. We consider the equation

$$y'' + y = \tan(t), \quad 0 < t < \frac{\pi}{2}.$$

We find homogeneous solutions with the substitution  $y = e^{\lambda t}$ .

$$\lambda^2 + 1 = 0$$

$$\lambda = \pm i$$

The homogeneous solutions are

$$y_1 = \cos(t), \quad y_2 = \sin(t).$$

We compute the Wronskian of these solutions.

$$W(t) = \begin{vmatrix} \cos(t) & \sin(t) \\ -\sin(t) & \cos(t) \end{vmatrix} = \cos^2(t) + \sin^2(t) = 1$$

We find a particular solution with variation of parameters.

$$\begin{aligned} y_p &= -\cos(t) \int \tan(t) \sin(t) dt + \sin(t) \int \tan(t) \cos(t) dt \\ &= -\cos(t) \int \frac{\sin^2(t)}{\cos(t)} dt + \sin(t) \int \sin(t) dt \\ &= \cos(t) \left( \ln \left( \frac{\cos(t/2) - \sin(t/2)}{\cos(t/2) + \sin(t/2)} + \sin(t) \right) \right) - \sin(t) \cos(t) \end{aligned}$$

$$y_p = \cos(t) \ln \left( \frac{\cos(t/2) - \sin(t/2)}{\cos(t/2) + \sin(t/2)} \right)$$

3. We consider the equation

$$y'' - 5y' + 6y = g(t).$$

The homogeneous solutions are

$$y_1 = e^{2t}, \quad y_2 = e^{3t}.$$

The Wronskian of these solutions is  $W(t) = e^{5t}$ . We find a particular solution with variation of parameters.

$$y_p = -e^{2t} \int \frac{g(t) e^{3t}}{e^{5t}} dt + e^{3t} \int \frac{g(t) e^{2t}}{e^{5t}} dt$$

$$y_p = -e^{2t} \int g(t) e^{-2t} dt + e^{3t} \int g(t) e^{-3t} dt$$

### Solution 21.4

Solve

$$y''(x) + y(x) = x, \quad y(0) = 1, \quad y'(0) = 0.$$

The solutions of the homogeneous equation are

$$y_1(x) = \cos x, \quad y_2(x) = \sin x.$$

The Wronskian of these solutions is

$$\begin{aligned} W[\cos x, \sin x] &= \begin{vmatrix} \cos x & \sin x \\ -\sin x & \cos x \end{vmatrix} \\ &= \cos^2 x + \sin^2 x \\ &= 1. \end{aligned}$$

The variation of parameters solution for the particular solution is

$$\begin{aligned} y_p &= -\cos x \int x \sin x dx + \sin x \int x \cos x dx \\ &= -\cos x \left( -x \cos x + \int \cos x dx \right) + \sin x \left( x \sin x - \int \sin x dx \right) \\ &= -\cos x (-x \cos x + \sin x) + \sin x (x \sin x + \cos x) \\ &= x \cos^2 x - \cos x \sin x + x \sin^2 x + \cos x \sin x \\ &= x \end{aligned}$$

The general solution of the differential equation is thus

$$y = c_1 \cos x + c_2 \sin x + x.$$

Applying the two initial conditions gives us the equations

$$c_1 = 1, \quad c_2 + 1 = 0.$$

The solution subject to the initial conditions is

$$\boxed{y = \cos x - \sin x + x.}$$

### Solution 21.5

Solve

$$x^2 y''(x) - xy'(x) + y(x) = x.$$

The homogeneous equation is

$$x^2 y''(x) - xy'(x) + y(x) = 0.$$

Substituting  $y = x^\lambda$  into the homogeneous differential equation yields

$$x^2 \lambda(\lambda - 1)x^{\lambda-2} - x \lambda x^\lambda + x^\lambda = 0$$

$$\lambda^2 - 2\lambda + 1 = 0$$

$$(\lambda - 1)^2 = 0$$

$$\lambda = 1.$$

The homogeneous solutions are

$$y_1 = x, \quad y_2 = x \log x.$$

The Wronskian of the homogeneous solutions is

$$\begin{aligned} W[x, x \log x] &= \begin{vmatrix} x & x \log x \\ 1 & 1 + \log x \end{vmatrix} \\ &= x + x \log x - x \log x \\ &= x. \end{aligned}$$

Writing the inhomogeneous equation in the standard form:

$$y''(x) - \frac{1}{x}y'(x) + \frac{1}{x^2}y(x) = \frac{1}{x}.$$

Using variation of parameters to find the particular solution,

$$\begin{aligned}y_p &= -x \int \frac{\log x}{x} dx + x \log x \int \frac{1}{x} dx \\&= -x \frac{1}{2} \log^2 x + x \log x \log x \\&= \frac{1}{2}x \log^2 x.\end{aligned}$$

Thus the general solution of the inhomogeneous differential equation is

$$y = c_1x + c_2x \log x + \frac{1}{2}x \log^2 x.$$

### Solution 21.6

1. First we find the homogeneous solutions. We substitute  $y = e^{\lambda x}$  into the homogeneous differential equation.

$$\begin{aligned}y'' + y &= 0 \\ \lambda^2 + 1 &= 0 \\ \lambda &= \pm i \\ y &= \{e^{ix}, e^{-ix}\}\end{aligned}$$

We can also write the solutions in terms of real-valued functions.

$$y = \{\cos x, \sin x\}$$

The Wronskian of the homogeneous solutions is

$$W[\cos x, \sin x] = \begin{vmatrix} \cos x & \sin x \\ -\sin x & \cos x \end{vmatrix} = \cos^2 x + \sin^2 x = 1.$$

We obtain a particular solution with the variation of parameters formula.

$$\begin{aligned} y_p &= -\cos x \int e^x \sin x \, dx + \sin x \int e^x \cos x \, dx \\ y_p &= -\cos x \frac{1}{2} e^x (\sin x - \cos x) + \sin x \frac{1}{2} e^x (\sin x + \cos x) \\ y_p &= \frac{1}{2} e^x \end{aligned}$$

The general solution is the particular solution plus a linear combination of the homogeneous solutions.

$$y = \frac{1}{2} e^x + \cos x + \sin x$$

2.

$$y'' + \lambda^2 y = \sin x, \quad y(0) = y'(0) = 0$$

Assume that  $\lambda$  is positive. First we find the homogeneous solutions by substituting  $y = e^{\alpha x}$  into the homogeneous differential equation.

$$\begin{aligned} y'' + \lambda^2 y &= 0 \\ \alpha^2 + \lambda^2 &= 0 \\ \alpha &= \pm i\lambda \\ y &= \{e^{i\lambda x}, e^{-i\lambda x}\} \\ y &= \{\cos(\lambda x), \sin(\lambda x)\} \end{aligned}$$



The Wronskian of these homogeneous solution is

$$W[\cos(\lambda x), \sin(\lambda x)] = \begin{vmatrix} \cos(\lambda x) & \sin(\lambda x) \\ -\lambda \sin(\lambda x) & \lambda \cos(\lambda x) \end{vmatrix} = \lambda \cos^2(\lambda x) + \lambda \sin^2(\lambda x) = \lambda.$$

We obtain a particular solution with the variation of parameters formula.

$$y_p = -\cos(\lambda x) \int \frac{\sin(\lambda x) \sin x}{\lambda} dx + \sin(\lambda x) \int \frac{\cos(\lambda x) \sin x}{\lambda} dx$$

We evaluate the integrals for  $\lambda \neq 1$ .

$$y_p = -\cos(\lambda x) \frac{\cos(x) \sin(\lambda x) - \lambda \sin x \cos(\lambda x)}{\lambda(\lambda^2 - 1)} + \sin(\lambda x) \frac{\cos(x) \cos(\lambda x) + \lambda \sin x \sin(\lambda x)}{\lambda(\lambda^2 - 1)}$$
$$y_p = \frac{\sin x}{\lambda^2 - 1}$$

The general solution for  $\lambda \neq 1$  is

$$y = \frac{\sin x}{\lambda^2 - 1} + c_1 \cos(\lambda x) + c_2 \sin(\lambda x).$$

The initial conditions give us the constraints:

$$c_1 = 0,$$
$$\frac{1}{\lambda^2 - 1} + \lambda c_2 = 0,$$

For  $\lambda \neq 1$ , (non-resonant forcing), the solution subject to the initial conditions is

$$y = \frac{\lambda \sin(x) - \sin(\lambda x)}{\lambda(\lambda^2 - 1)}.$$

Now consider the case  $\lambda = 1$ . We obtain a particular solution with the variation of parameters formula.

$$y_p = -\cos(x) \int \sin^2(x) dx + \sin(x) \int \cos(x) \sin x dx$$

$$y_p = -\cos(x) \frac{1}{2}(x - \cos(x) \sin(x)) + \sin(x) \left( -\frac{1}{2} \cos^2(x) \right)$$

$$y_p = -\frac{1}{2}x \cos(x)$$

The general solution for  $\lambda = 1$  is

$$y = -\frac{1}{2}x \cos(x) + c_1 \cos(x) + c_2 \sin(x).$$

The initial conditions give us the constraints:

$$c_1 = 0$$

$$-\frac{1}{2} + c_2 = 0$$

For  $\lambda = 1$ , (resonant forcing), the solution subject to the initial conditions is

$$y = \frac{1}{2}(\sin(x) - x \cos x).$$

### Solution 21.7

1. A set of linearly independent, homogeneous solutions is  $\{\cos t, \sin t\}$ . The Wronskian of these solutions is

$$W(t) = \begin{vmatrix} \cos t & \sin t \\ -\sin t & \cos t \end{vmatrix} = \cos^2 t + \sin^2 t = 1.$$

We use variation of parameters to find a particular solution.

$$y_p = -\cos t \int g(t) \sin t dt + \sin t \int g(t) \cos t dt$$

The general solution can be written in the form,

$$y(t) = \left( c_1 - \int_a^t g(\tau) \sin \tau \, d\tau \right) \cos t + \left( c_2 + \int_b^t g(\tau) \cos \tau \, d\tau \right) \sin t.$$

2. Since the initial conditions are given at  $t = 0$  we choose the lower bounds of integration in the general solution to be that point.

$$y = \left( c_1 - \int_0^t g(\tau) \sin \tau \, d\tau \right) \cos t + \left( c_2 + \int_0^t g(\tau) \cos \tau \, d\tau \right) \sin t$$

The initial condition  $y(0) = 0$  gives the constraint,  $c_1 = 0$ . The derivative of  $y(t)$  is then,

$$y'(t) = -g(t) \sin t \cos t + \int_0^t g(\tau) \sin \tau \, d\tau \sin t + g(t) \cos t \sin t + \left( c_2 + \int_0^t g(\tau) \cos \tau \, d\tau \right) \cos t,$$
$$y'(t) = \int_0^t g(\tau) \sin \tau \, d\tau \sin t + \left( c_2 + \int_0^t g(\tau) \cos \tau \, d\tau \right) \cos t.$$

The initial condition  $y'(0) = 0$  gives the constraint  $c_2 = 0$ . The solution subject to the initial conditions is

$$y = \int_0^t g(\tau) (\sin t \cos \tau - \cos t \sin \tau) \, d\tau$$

$$y = \int_0^t g(\tau) \sin(t - \tau) \, d\tau$$

3. The solution of the initial value problem

$$y'' + y = \sin(\lambda t), \quad y(0) = 0, \quad y'(0) = 0,$$

is

$$y = \int_0^t \sin(\lambda \tau) \sin(t - \tau) \, d\tau.$$

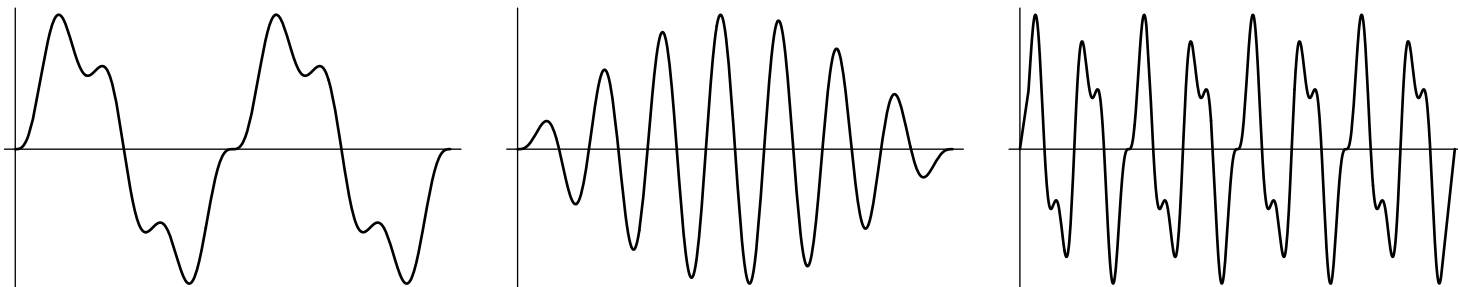

Figure 21.5: Non-resonant Forcing

For  $\lambda \neq 1$ , this is

$$\begin{aligned}
 y &= \frac{1}{2} \int_0^t (\cos(t - \tau - \lambda\tau) - \cos(t - \tau + \lambda\tau)) \, d\tau \\
 &= \frac{1}{2} \left[ -\frac{\sin(t - \tau - \lambda\tau)}{1 + \lambda} + \frac{\sin(t - \tau + \lambda\tau)}{1 - \lambda} \right]_0^t \\
 &= \frac{1}{2} \left( \frac{\sin(t) - \sin(-\lambda t)}{1 + \lambda} + \frac{-\sin(t) + \sin(\lambda t)}{1 - \lambda} \right)
 \end{aligned}$$

$$\boxed{y = -\frac{\lambda \sin t}{1 - \lambda^2} + \frac{\sin(\lambda t)}{1 - \lambda^2}} \quad (21.6)$$

The solution is the sum of two periodic functions of period  $2\pi$  and  $2\pi/\lambda$ . This solution is plotted in Figure 21.5 on the interval  $t \in [0, 16\pi]$  for the values  $\lambda = 1/4, 7/8, 5/2$ .

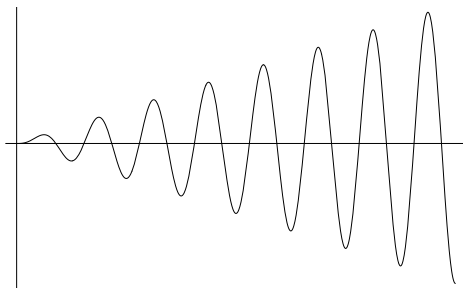

Figure 21.6: Resonant Forcing

For  $\lambda = 1$ , we have

$$\begin{aligned}
 y &= \frac{1}{2} \int_0^t (\cos(t - 2\tau) - \cos(\tau)) \, d\tau \\
 &= \frac{1}{2} \left[ -\frac{1}{2} \sin(t - 2\tau) - \tau \cos t \right]_0^t
 \end{aligned}$$

$$\boxed{y = \frac{1}{2} (\sin t - t \cos t)}. \tag{21.7}$$

The solution has both a periodic and a transient term. This solution is plotted in Figure 21.5 on the interval  $t \in [0, 16\pi]$ .

Note that we can derive (21.7) from (21.6) by taking the limit as  $\lambda \rightarrow 1$ .

$$\begin{aligned}
 \lim_{\lambda \rightarrow 1} \frac{\sin(\lambda t) - \lambda \sin t}{1 - \lambda^2} &= \lim_{\lambda \rightarrow 1} \frac{t \cos(\lambda t) - \sin t}{-2\lambda} \\
 &= \frac{1}{2} (\sin t - t \cos t)
 \end{aligned}$$

### Solution 21.8

Let  $y_1$ ,  $y_2$  and  $y_3$  be linearly independent homogeneous solutions to the differential equation

$$L[y] = y''' + p_2y'' + p_1y' + p_0y = f(x).$$

We will look for a particular solution of the form

$$y_p = u_1y_1 + u_2y_2 + u_3y_3.$$

Since the  $u_j$ 's are undetermined functions, we are free to impose two constraints. We choose the constraints to simplify the algebra.

$$\begin{aligned}u_1'y_1 + u_2'y_2 + u_3'y_3 &= 0 \\u_1'y_1' + u_2'y_2' + u_3'y_3' &= 0\end{aligned}$$

Differentiating the expression for  $y_p$ ,

$$\begin{aligned}y_p' &= u_1'y_1 + u_1y_1' + u_2'y_2 + u_2y_2' + u_3'y_3 + u_3y_3' \\&= u_1y_1' + u_2y_2' + u_3y_3' \\y_p'' &= u_1'y_1' + u_1y_1'' + u_2'y_2' + u_2y_2'' + u_3'y_3' + u_3y_3'' \\&= u_1y_1'' + u_2y_2'' + u_3y_3'' \\y_p''' &= u_1'y_1'' + u_1y_1''' + u_2'y_2'' + u_2y_2''' + u_3'y_3'' + u_3y_3'''\end{aligned}$$

Substituting the expressions for  $y_p$  and its derivatives into the differential equation,

$$\begin{aligned}u_1'y_1'' + u_1y_1''' + u_2'y_2'' + u_2y_2''' + u_3'y_3'' + u_3y_3''' + p_2(u_1y_1'' + u_2y_2'' + u_3y_3'') + p_1(u_1y_1' + u_2y_2' + u_3y_3') \\+ p_0(u_1y_1 + u_2y_2 + u_3y_3) = f(x)\end{aligned}$$

$$\begin{aligned}u_1'y_1'' + u_2'y_2'' + u_3'y_3'' + u_1L[y_1] + u_2L[y_2] + u_3L[y_3] &= f(x) \\u_1'y_1'' + u_2'y_2'' + u_3'y_3'' &= f(x).\end{aligned}$$

With the two constraints, we have the system of equations,

$$\begin{aligned}u_1' y_1 + u_2' y_2 + u_3' y_3 &= 0 \\u_1' y_1' + u_2' y_2' + u_3' y_3' &= 0 \\u_1' y_1'' + u_2' y_2'' + u_3' y_3'' &= f(x)\end{aligned}$$

We solve for the  $u_j'$  using Kramer's rule.

$$u_1' = \frac{(y_2 y_3' - y_2' y_3) f(x)}{W(x)}, \quad u_2' = -\frac{(y_1 y_3' - y_1' y_3) f(x)}{W(x)}, \quad u_3' = \frac{(y_1 y_2' - y_1' y_2) f(x)}{W(x)}$$

Here  $W(x)$  is the Wronskian of  $\{y_1, y_2, y_3\}$ . Integrating the expressions for  $u_j'$ , the particular solution is

$$y_p = y_1 \int \frac{(y_2 y_3' - y_2' y_3) f(x)}{W(x)} dx + y_2 \int \frac{(y_3 y_1' - y_3' y_1) f(x)}{W(x)} dx + y_3 \int \frac{(y_1 y_2' - y_1' y_2) f(x)}{W(x)} dx.$$

## Green Functions

### Solution 21.9

We consider the Green function problem

$$G'' = f(x), \quad G(-\infty|\xi) = G'(-\infty|\xi) = 0.$$

The homogeneous solution is  $y = c_1 + c_2 x$ . The homogeneous solution that satisfies the boundary conditions is  $y = 0$ . Thus the Green function has the form

$$G(x|\xi) = \begin{cases} 0 & x < \xi, \\ c_1 + c_2 x & x > \xi. \end{cases}$$

The continuity and jump conditions are then

$$G(\xi^+|\xi) = 0, \quad G'(\xi^+|\xi) = 1.$$

Thus the Green function is

$$G(x|\xi) = \begin{cases} 0 & x < \xi, \\ x - \xi & x > \xi \end{cases} = (x - \xi)H(x - \xi).$$

The solution of the problem

$$y'' = f(x), \quad y(-\infty) = y'(-\infty) = 0.$$

is

$$y = \int_{-\infty}^{\infty} f(\xi)G(x|\xi) d\xi$$
$$y = \int_{-\infty}^{\infty} f(\xi)(x - \xi)H(x - \xi) d\xi$$

$$y = \int_{-\infty}^x f(\xi)(x - \xi) d\xi$$

We differentiate this solution to verify that it satisfies the differential equation.

$$y' = [f(\xi)(x - \xi)]_{\xi=x} + \int_{-\infty}^x \frac{\partial}{\partial x} (f(\xi)(x - \xi)) d\xi = \int_{-\infty}^x f(\xi) d\xi$$
$$y'' = [f(\xi)]_{\xi=x} = f(x)$$

### Solution 21.10

Since we are dealing with an Euler equation, we substitute  $y = x^\lambda$  to find the homogeneous solutions.

$$\lambda(\lambda - 1) + \lambda - 1 = 0$$

$$(\lambda - 1)(\lambda + 1) = 0$$

$$y_1 = x, \quad y_2 = \frac{1}{x}$$



**Variation of Parameters.** The Wronskian of the homogeneous solutions is

$$W(x) = \begin{vmatrix} x & 1/x \\ 1 & -1/x^2 \end{vmatrix} = -\frac{1}{x} - \frac{1}{x} = -\frac{2}{x}.$$

A particular solution is

$$\begin{aligned} y_p &= -x \int \frac{x^2(1/x)}{-2/x} dx + \frac{1}{x} \int \frac{x^2x}{-2/x} dx \\ &= -x \int -\frac{x^2}{2} dx + \frac{1}{x} \int -\frac{x^4}{2} dx \\ &= \frac{x^4}{6} - \frac{x^4}{10} \\ &= \frac{x^4}{15}. \end{aligned}$$

The general solution is

$$y = \frac{x^4}{15} + c_1x + c_2\frac{1}{x}.$$

Applying the initial conditions,

$$\begin{aligned} y(0) = 0 &\rightarrow c_2 = 0 \\ y'(0) = 0 &\rightarrow c_1 = 1. \end{aligned}$$

Thus we have the solution

$$\boxed{y = \frac{x^4}{15} + x.}$$

**Green Function.** Since this problem has both an inhomogeneous term in the differential equation and inhomogeneous boundary conditions, we separate it into the two problems

$$\begin{aligned} u'' + \frac{1}{x}u' - \frac{1}{x^2}u &= x^2, & u(0) = u'(0) &= 0, \\ v'' + \frac{1}{x}v' - \frac{1}{x^2}v &= 0, & v(0) = 0, \quad v'(0) &= 1. \end{aligned}$$

First we solve the inhomogeneous differential equation with the homogeneous boundary conditions. The Green function for this problem satisfies

$$L[G(x|\xi)] = \delta(x - \xi), \quad G(0|\xi) = G'(0|\xi) = 0.$$

Since the Green function must satisfy the homogeneous boundary conditions, it has the form

$$G(x|\xi) = \begin{cases} 0 & \text{for } x < \xi \\ cx + d/x & \text{for } x > \xi. \end{cases}$$

From the continuity condition,

$$0 = c\xi + d/\xi.$$

The jump condition yields

$$c - d/\xi^2 = 1.$$

Solving these two equations, we obtain

$$G(x|\xi) = \begin{cases} 0 & \text{for } x < \xi \\ \frac{1}{2}x - \frac{\xi^2}{2x} & \text{for } x > \xi \end{cases}$$

Thus the solution is

$$\begin{aligned}u(x) &= \int_0^{\infty} G(x|\xi)\xi^2 d\xi \\&= \int_0^x \left(\frac{1}{2}x - \frac{\xi^2}{2x}\right)\xi^2 d\xi \\&= \frac{1}{6}x^4 - \frac{1}{10}x^4 \\&= \frac{x^4}{15}.\end{aligned}$$

Now to solve the homogeneous differential equation with inhomogeneous boundary conditions. The general solution for  $v$  is

$$v = cx + d/x.$$

Applying the two boundary conditions gives

$$v = x.$$

Thus the solution for  $y$  is

$$y = x + \frac{x^4}{15}.$$

### Solution 21.11

The Green function satisfies

$$G'''(x|\xi) + p_2(x)G''(x|\xi) + p_1(x)G'(x|\xi) + p_0(x)G(x|\xi) = \delta(x - \xi).$$

First note that only the  $G'''(x|\xi)$  term can have a delta function singularity. If a lower derivative had a delta function type singularity, then  $G'''(x|\xi)$  would be more singular than a delta function and there would be no other term in the equation to balance that behavior. Thus we see that  $G'''(x|\xi)$  will have a delta function singularity;  $G''(x|\xi)$  will have a jump discontinuity;  $G'(x|\xi)$  will be continuous at  $x = \xi$ . Integrating the differential equation from  $\xi^-$  to  $\xi^+$  yields

$$\int_{\xi^-}^{\xi^+} G'''(x|\xi) dx = \int_{\xi^-}^{\xi^+} \delta(x - \xi) dx$$

$$G''(\xi^+|\xi) - G''(\xi^-|\xi) = 1.$$

Thus we have the three continuity conditions:

$$G''(\xi^+|\xi) = G''(\xi^-|\xi) + 1$$

$$G'(\xi^+|\xi) = G'(\xi^-|\xi)$$

$$G(\xi^+|\xi) = G(\xi^-|\xi)$$

### Solution 21.12

**Variation of Parameters.** Consider the problem

$$x^2 y'' - 2xy' + 2y = e^{-x}, \quad y(1) = 0, \quad y'(1) = 1.$$

Previously we showed that two homogeneous solutions are

$$y_1 = x, \quad y_2 = x^2.$$

The Wronskian of these solutions is

$$W(x) = \begin{vmatrix} x & x^2 \\ 1 & 2x \end{vmatrix} = 2x^2 - x^2 = x^2.$$

In the variation of parameters formula, we will choose 1 as the lower bound of integration. (This will simplify the algebra in applying the initial conditions.)

$$\begin{aligned} y_p &= -x \int_1^x \frac{e^{-\xi} \xi^2}{\xi^4} d\xi + x^2 \int_1^x \frac{e^{-\xi} \xi}{\xi^4} d\xi \\ &= -x \int_1^x \frac{e^{-\xi}}{\xi^2} d\xi + x^2 \int_1^x \frac{e^{-\xi}}{\xi^3} d\xi \\ &= -x \left( e^{-1} - \frac{e^{-x}}{x} - \int_1^x \frac{e^{-\xi}}{\xi} d\xi \right) + x^2 \left( \frac{e^{-x}}{2x} - \frac{e^{-x}}{2x^2} + \frac{1}{2} \int_1^x \frac{e^{-\xi}}{\xi} d\xi \right) \\ &= -x e^{-1} + \frac{1}{2}(1+x)e^{-x} + \left( \frac{x+x^2}{2} \right) \int_1^x \frac{e^{-\xi}}{\xi} d\xi \end{aligned}$$

If you wanted to, you could write the last integral in terms of exponential integral functions.

The general solution is

$$y = c_1x + c_2x^2 - xe^{-1} + \frac{1}{2}(1+x)e^{-x} + \left(x + \frac{x^2}{2}\right) \int_1^x \frac{e^{-\xi}}{\xi} d\xi$$

Applying the boundary conditions,

$$\begin{aligned} y(1) = 0 & \quad \rightarrow \quad c_1 + c_2 = 0 \\ y'(1) = 1 & \quad \rightarrow \quad c_1 + 2c_2 = 1, \end{aligned}$$

we find that  $c_1 = -1$ ,  $c_2 = 1$ .

Thus the solution subject to the initial conditions is

$$y = -(1 + e^{-1})x + x^2 + \frac{1}{2}(1+x)e^{-x} + \left(x + \frac{x^2}{2}\right) \int_1^x \frac{e^{-\xi}}{\xi} d\xi$$

**Green Functions.** The solution to the problem is  $y = u + v$  where

$$u'' - \frac{2}{x}u' + \frac{2}{x^2}u = \frac{e^{-x}}{x^2}, \quad u(1) = 0, \quad u'(1) = 0,$$

and

$$v'' - \frac{2}{x}v' + \frac{2}{x^2}v = 0, \quad v(1) = 0, \quad v'(1) = 1.$$

The problem for  $v$  has the solution

$$v = -x + x^2.$$

The Green function for  $u$  is

$$G(x|\xi) = H(x - \xi)u_\xi(x)$$

where

$$u_\xi(\xi) = 0, \quad \text{and} \quad u'_\xi(\xi) = 1.$$

Thus the Green function is

$$G(x|\xi) = H(x - \xi) \left( -x + \frac{x^2}{\xi} \right).$$

The solution for  $u$  is then

$$\begin{aligned} u &= \int_1^\infty G(x|\xi) \frac{e^{-\xi}}{\xi^2} d\xi \\ &= \int_1^x \left( -x + \frac{x^2}{\xi} \right) \frac{e^{-\xi}}{\xi^2} d\xi \\ &= -x e^{-1} + \frac{1}{2}(1+x) e^{-x} + \left( x + \frac{x^2}{2} \right) \int_1^x \frac{e^{-\xi}}{\xi} d\xi. \end{aligned}$$

Thus we find the solution for  $y$  is

$$y = -(1 + e^{-1})x + x^2 + \frac{1}{2}(1+x) e^{-x} + \left( x + \frac{x^2}{2} \right) \int_1^x \frac{e^{-\xi}}{\xi} d\xi$$

### Solution 21.13

The differential equation for the Green function is

$$G'' - G = \delta(x - \xi), \quad G_x(0|\xi) = G(1|\xi) = 0.$$

Note that  $\cosh(x)$  and  $\sinh(x - 1)$  are homogeneous solutions that satisfy the left and right boundary conditions, respectively. The Wronskian of these two solutions is

$$\begin{aligned} W(x) &= \begin{vmatrix} \cosh(x) & \sinh(x - 1) \\ \sinh(x) & \cosh(x - 1) \end{vmatrix} \\ &= \cosh(x) \cosh(x - 1) - \sinh(x) \sinh(x - 1) \\ &= \frac{1}{4} ((e^x + e^{-x})(e^{x-1} + e^{-x+1}) - (e^x - e^{-x})(e^{x-1} - e^{-x+1})) \\ &= \frac{1}{2} (e^1 + e^{-1}) \\ &= \cosh(1). \end{aligned}$$

The Green function for the problem is then

$$G(x|\xi) = \frac{\cosh(x_{<}) \sinh(x_{>} - 1)}{\cosh(1)},$$

$$G(x|\xi) = \begin{cases} \frac{\cosh(x) \sinh(\xi-1)}{\cosh(1)} & \text{for } 0 \leq x \leq \xi, \\ \frac{\cosh(\xi) \sinh(x-1)}{\cosh(1)} & \text{for } \xi \leq x \leq 1. \end{cases}$$

### Solution 21.14

The differential equation for the Green function is

$$G'' - G = \delta(x - \xi), \quad G(0|\xi) = G(\infty|\xi) = 0.$$

Note that  $\sinh(x)$  and  $e^{-x}$  are homogeneous solutions that satisfy the left and right boundary conditions, respectively. The Wronskian of these two solutions is

$$\begin{aligned} W(x) &= \begin{vmatrix} \sinh(x) & e^{-x} \\ \cosh(x) & -e^{-x} \end{vmatrix} \\ &= -\sinh(x) e^{-x} - \cosh(x) e^{-x} \\ &= -\frac{1}{2} (e^x - e^{-x}) e^{-x} - \frac{1}{2} (e^x + e^{-x}) e^{-x} \\ &= -1 \end{aligned}$$

The Green function for the problem is then

$$G(x|\xi) = -\sinh(x_{<}) e^{-x_{>}}$$

$$G(x|\xi) = \begin{cases} -\sinh(x) e^{-\xi} & \text{for } 0 \leq x \leq \xi, \\ -\sinh(\xi) e^{-x} & \text{for } \xi \leq x \leq \infty. \end{cases}$$

## Solution 21.15

a) The Green function problem is

$$xG''(x|\xi) + G'(x|\xi) = \delta(x - \xi), \quad G(0|\xi) \text{ bounded}, G(1|\xi) = 0.$$

First we find the homogeneous solutions of the differential equation.

$$xy'' + y' = 0$$

This is an exact equation.

$$\frac{d}{dx}[xy'] = 0$$

$$y' = \frac{c_1}{x}$$

$$y = c_1 \log x + c_2$$

The homogeneous solutions  $y_1 = 1$  and  $y_2 = \log x$  satisfy the left and right boundary conditions, respectively. The Wronskian of these solutions is

$$W(x) = \begin{vmatrix} 1 & \log x \\ 0 & 1/x \end{vmatrix} = \frac{1}{x}.$$

The Green function is

$$G(x|\xi) = \frac{1 \cdot \log x_{>}}{\xi(1/\xi)},$$

$$\boxed{G(x|\xi) = \log x_{>}.}$$

b) The Green function problem is

$$G''(x|\xi) - G(x|\xi) = \delta(x - \xi), \quad G(-a|\xi) = G(a|\xi) = 0.$$



$\{e^x, e^{-x}\}$  and  $\{\cosh x, \sinh x\}$  are both linearly independent sets of homogeneous solutions.  $\sinh(x + a)$  and  $\sinh(x - a)$  are homogeneous solutions that satisfy the left and right boundary conditions, respectively. The Wronskian of these two solutions is,

$$\begin{aligned} W(x) &= \begin{vmatrix} \sinh(x + a) & \sinh(x - a) \\ \cosh(x + a) & \cosh(x - a) \end{vmatrix} \\ &= \sinh(x + a) \cosh(x - a) - \sinh(x - a) \cosh(x + a) \\ &= \sinh(2a) \end{aligned}$$

The Green function is

$$G(x|\xi) = \frac{\sinh(x_{<} + a) \sinh(x_{>} - a)}{\sinh(2a)}.$$

c) The Green function problem is

$$G''(x|\xi) - G(x|\xi) = \delta(x - \xi), \quad G(x|\xi) \text{ bounded as } |x| \rightarrow \infty.$$

$e^x$  and  $e^{-x}$  are homogeneous solutions that satisfy the left and right boundary conditions, respectively. The Wronskian of these solutions is

$$W(x) = \begin{vmatrix} e^x & e^{-x} \\ e^x & -e^{-x} \end{vmatrix} = -2.$$

The Green function is

$$G(x|\xi) = \frac{e^{x_{<}} e^{-x_{>}}}{-2},$$

$$G(x|\xi) = -\frac{1}{2} e^{x_{<} - x_{>}}.$$

d) The Green function from part (b) is,

$$G(x|\xi) = \frac{\sinh(x_{<} + a) \sinh(x_{>} - a)}{\sinh(2a)}.$$

We take the limit as  $a \rightarrow \infty$ .

$$\begin{aligned} \lim_{a \rightarrow \infty} \frac{\sinh(x_{<} + a) \sinh(x_{>} - a)}{\sinh(2a)} &= \lim_{a \rightarrow \infty} \frac{(e^{x_{<}+a} - e^{-x_{<}+a})(e^{x_{>}-a} - e^{-x_{>}+a})}{2(e^{2a} - e^{-2a})} \\ &= \lim_{a \rightarrow \infty} \frac{-e^{x_{<}-x_{>}} + e^{x_{>}+x_{<}-2a} + e^{-x_{<}+x_{>}-2a} - e^{-x_{<}+x_{>}+4a}}{2 - 2e^{-4a}} \\ &= -\frac{e^{x_{<}-x_{>}}}{2} \end{aligned}$$

Thus we see that the solution from part (b) approaches the solution from part (c) as  $a \rightarrow \infty$ .

### Solution 21.16

1. The problem,

$$y'' + \lambda y = f(x), \quad y(0) = y(\pi) = 0,$$

has a Green function if and only if it has a unique solution. This inhomogeneous problem has a unique solution if and only if the homogeneous problem has only the trivial solution.

First consider the case  $\lambda = 0$ . We find the general solution of the homogeneous differential equation.

$$y = c_1 + c_2 x$$

Only the trivial solution satisfies the boundary conditions. The problem has a unique solution for  $\lambda = 0$ .

Now consider non-zero  $\lambda$ . We find the general solution of the homogeneous differential equation.

$$y = c_1 \cos(\sqrt{\lambda}x) + c_2 \sin(\sqrt{\lambda}x).$$

The solution that satisfies the left boundary condition is

$$y = c \sin(\sqrt{\lambda}x).$$

We apply the right boundary condition and find nontrivial solutions.

$$\begin{aligned}\sin(\sqrt{\lambda}\pi) &= 0 \\ \lambda &= n^2, \quad n \in \mathbb{Z}^+\end{aligned}$$

Thus the problem has a unique solution for all complex  $\lambda$  except  $\lambda = n^2$ ,  $n \in \mathbb{Z}^+$ .

Consider the case  $\lambda = 0$ . We find solutions of the homogeneous equation that satisfy the left and right boundary conditions, respectively.

$$y_1 = x, \quad y_2 = x - \pi.$$

We compute the Wronskian of these functions.

$$W(x) = \begin{vmatrix} x & x - \pi \\ 1 & 1 \end{vmatrix} = \pi.$$

The Green function for this case is

$$G(x|\xi) = \frac{x_{<}(x_{>} - \pi)}{\pi}.$$

We consider the case  $\lambda \neq n^2$ ,  $\lambda \neq 0$ . We find the solutions of the homogeneous equation that satisfy the left and right boundary conditions, respectively.

$$y_1 = \sin(\sqrt{\lambda}x), \quad y_2 = \sin(\sqrt{\lambda}(x - \pi)).$$

We compute the Wronskian of these functions.

$$W(x) = \begin{vmatrix} \sin(\sqrt{\lambda}x) & \sin(\sqrt{\lambda}(x - \pi)) \\ \sqrt{\lambda}\cos(\sqrt{\lambda}x) & \sqrt{\lambda}\cos(\sqrt{\lambda}(x - \pi)) \end{vmatrix} = \sqrt{\lambda}\sin(\sqrt{\lambda}\pi)$$

The Green function for this case is

$$G(x|\xi) = \frac{\sin(\sqrt{\lambda}x_{<})\sin(\sqrt{\lambda}(x_{>} - \pi))}{\sqrt{\lambda}\sin(\sqrt{\lambda}\pi)}.$$

2. Now we consider the problem

$$y'' + 9y = 1 + \alpha x, \quad y(0) = y(\pi) = 0.$$

The homogeneous solutions of the problem are constant multiples of  $\sin(3x)$ . Thus for each value of  $\alpha$ , the problem either has no solution or an infinite number of solutions. There will be an infinite number of solutions if the inhomogeneity  $1 + \alpha x$  is orthogonal to the homogeneous solution  $\sin(3x)$  and no solution otherwise.

$$\int_0^\pi (1 + \alpha x) \sin(3x) \, dx = \frac{\pi\alpha + 2}{3}$$

The problem has a solution only for  $\alpha = -2/\pi$ . For this case the general solution of the inhomogeneous differential equation is

$$y = \frac{1}{9} \left( 1 - \frac{2x}{\pi} \right) + c_1 \cos(3x) + c_2 \sin(3x).$$

The one-parameter family of solutions that satisfies the boundary conditions is

$$y = \frac{1}{9} \left( 1 - \frac{2x}{\pi} - \cos(3x) \right) + c \sin(3x).$$

3. For  $\lambda = n^2$ ,  $n \in \mathbb{Z}^+$ ,  $y = \sin(nx)$  is a solution of the homogeneous equation that satisfies the boundary conditions. Equation 21.5 has a (non-unique) solution only if  $f$  is orthogonal to  $\sin(nx)$ .

$$\int_0^\pi f(x) \sin(nx) \, dx = 0$$

The modified Green function satisfies

$$G'' + n^2 G = \delta(x - \xi) - \frac{\sin(nx) \sin(n\xi)}{\pi/2}.$$

We expand  $G$  in a series of the eigenfunctions.

$$G(x|\xi) = \sum_{k=1}^{\infty} g_k \sin(kx)$$

We substitute the expansion into the differential equation to determine the coefficients. This will not determine  $g_n$ . We choose  $g_n = 0$ , which is one of the choices that will make the modified Green function symmetric in  $x$  and  $\xi$ .

$$\sum_{k=1}^{\infty} g_k (n^2 - k^2) \sin(kx) = \frac{2}{\pi} \sum_{\substack{k=1 \\ k \neq n}}^{\infty} \sin(kx) \sin(k\xi)$$

$$G(x|\xi) = \frac{2}{\pi} \sum_{\substack{k=1 \\ k \neq n}}^{\infty} \frac{\sin(kx) \sin(k\xi)}{n^2 - k^2}$$

The solution of the inhomogeneous problem is

$$y(x) = \int_0^{\pi} f(\xi) G(x|\xi) d\xi.$$

### Solution 21.17

We separate the problem for  $u$  into the two problems:

$$Lv \equiv (pv')' + qv = f(x), \quad a < x < b, \quad v(a) = 0, \quad v(b) = 0$$

$$Lw \equiv (pw')' + qw = 0, \quad a < x < b, \quad w(a) = \alpha, \quad w(b) = \beta$$

and note that the solution for  $u$  is  $u = v + w$ .

The problem for  $v$  has the solution,

$$v = \int_a^b g(x; \xi) f(\xi) d\xi,$$

with the Green function,

$$g(x; \xi) = \frac{v_1(x_{<})v_2(x_{>})}{p(\xi)W(\xi)} \equiv \begin{cases} \frac{v_1(x)v_2(\xi)}{p(\xi)W(\xi)} & \text{for } a \leq x \leq \xi, \\ \frac{v_1(\xi)v_2(x)}{p(\xi)W(\xi)} & \text{for } \xi \leq x \leq b. \end{cases}$$

Here  $v_1$  and  $v_2$  are homogeneous solutions that respectively satisfy the left and right homogeneous boundary conditions.

Since  $g(x; \xi)$  is a solution of the homogeneous equation for  $x \neq \xi$ ,  $g_\xi(x; \xi)$  is a solution of the homogeneous equation for  $x \neq \xi$ . This is because for  $x \neq \xi$ ,

$$L \left[ \frac{\partial}{\partial \xi} g \right] = \frac{\partial}{\partial \xi} L[g] = \frac{\partial}{\partial \xi} \delta(x - \xi) = 0.$$

If  $\xi$  is outside of the domain,  $(a, b)$ , then  $g(x; \xi)$  and  $g_\xi(x; \xi)$  are homogeneous solutions on that domain. In particular  $g_\xi(x; a)$  and  $g_\xi(x; b)$  are homogeneous solutions,

$$L [g_\xi(x; a)] = L [g_\xi(x; b)] = 0.$$

Now we use the definition of the Green function and  $v_1(a) = v_2(b) = 0$  to determine simple expressions for these homogeneous solutions.

$$\begin{aligned} g_\xi(x; a) &= \frac{v_1'(a)v_2(x)}{p(a)W(a)} - \frac{(p'(a)W(a) + p(a)W'(a))v_1(a)v_2(x)}{(p(a)W(a))^2} \\ &= \frac{v_1'(a)v_2(x)}{p(a)W(a)} \\ &= \frac{v_1'(a)v_2(x)}{p(a)(v_1(a)v_2'(a) - v_1'(a)v_2(a))} \\ &= -\frac{v_1'(a)v_2(x)}{p(a)v_1'(a)v_2(a)} \\ &= -\frac{v_2(x)}{p(a)v_2(a)} \end{aligned}$$

We note that this solution has the boundary values,

$$g_\xi(a; a) = -\frac{v_2(a)}{p(a)v_2(a)} = -\frac{1}{p(a)}, \quad g_\xi(b; a) = -\frac{v_2(b)}{p(a)v_2(a)} = 0.$$

We examine the second solution.

$$\begin{aligned}
 g_{\xi}(x; b) &= \frac{v_1(x)v_2'(b)}{p(b)W(b)} - \frac{(p'(b)W(b) + p(b)W'(b))v_1(x)v_2(b)}{(p(b)W(b))^2} \\
 &= \frac{v_1(x)v_2'(b)}{p(b)W(b)} \\
 &= \frac{v_1(x)v_2'(b)}{p(b)(v_1(b)v_2'(b) - v_1'(b)v_2(b))} \\
 &= \frac{v_1(x)v_2'(b)}{p(b)v_1(b)v_2'(b)} \\
 &= \frac{v_1(x)}{p(b)v_1(b)}
 \end{aligned}$$

This solution has the boundary values,

$$g_{\xi}(a; b) = \frac{v_1(a)}{p(b)v_1(b)} = 0, \quad g_{\xi}(b; b) = \frac{v_1(b)}{p(b)v_1(b)} = \frac{1}{p(b)}.$$

Thus we see that the solution of

$$Lw = (pw')' + qw = 0, \quad a < x < b, \quad w(a) = \alpha, \quad w(b) = \beta,$$

is

$$w = -\alpha p(a)g_{\xi}(x; a) + \beta p(b)g_{\xi}(x; b).$$

Therefore the solution of the problem for  $u$  is

$$u = \int_a^b g(x; \xi)f(\xi) \, d\xi - \alpha p(a)g_{\xi}(x; a) + \beta p(b)g_{\xi}(x; b).$$

### Solution 21.18

Figure 21.7 shows a plot of  $G(x; 1)$  and  $G(x; -1)$  for  $k = 1$ .

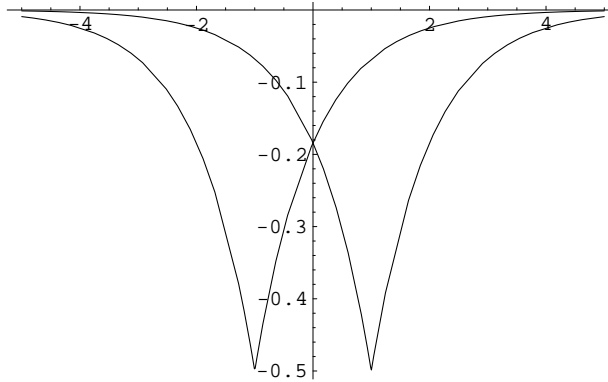

Figure 21.7:  $G(x; 1)$  and  $G(x; -1)$

First we consider the boundary condition  $u(0) = 0$ . Note that the solution of

$$G'' - k^2 G = \delta(x - \xi) - \delta(x + \xi), |G(\pm\infty; \xi)| < \infty,$$

satisfies the condition  $G(0; \xi) = 0$ . Thus the Green function which satisfies  $G(0; \xi) = 0$  is

$$G(x; \xi) = -\frac{1}{2k} e^{-k|x-\xi|} + \frac{1}{2k} e^{-k|x+\xi|}.$$

Since  $x, \xi > 0$  we can write this as

$$\begin{aligned} G(x; \xi) &= -\frac{1}{2k} e^{-k|x-\xi|} + \frac{1}{2k} e^{-k(x+\xi)} \\ &= \begin{cases} -\frac{1}{2k} e^{-k(\xi-x)} + \frac{1}{2k} e^{-k(x+\xi)}, & \text{for } x < \xi \\ -\frac{1}{2k} e^{-k(x-\xi)} + \frac{1}{2k} e^{-k(x+\xi)}, & \text{for } \xi < x \end{cases} \\ &= \begin{cases} -\frac{1}{k} e^{-k\xi} \sinh(kx), & \text{for } x < \xi \\ -\frac{1}{k} e^{-kx} \sinh(k\xi), & \text{for } \xi < x \end{cases} \end{aligned}$$



$$G(x; \xi) = -\frac{1}{k} e^{-kx} \sinh(kx_{<})$$

Now consider the boundary condition  $u'(0) = 0$ . Note that the solution of

$$G'' - k^2 G = \delta(x - \xi) + \delta(x + \xi), \quad |G(\pm\infty; \xi)| < \infty,$$

satisfies the boundary condition  $G'(x; \xi) = 0$ . Thus the Green function is

$$G(x; \xi) = -\frac{1}{2k} e^{-k|x-\xi|} - \frac{1}{2k} e^{-k|x+\xi|}.$$

Since  $x, \xi > 0$  we can write this as

$$\begin{aligned} G(x; \xi) &= -\frac{1}{2k} e^{-k|x-\xi|} - \frac{1}{2k} e^{-k(x+\xi)} \\ &= \begin{cases} -\frac{1}{2k} e^{-k(\xi-x)} - \frac{1}{2k} e^{-k(x+\xi)}, & \text{for } x < \xi \\ -\frac{1}{2k} e^{-k(x-\xi)} - \frac{1}{2k} e^{-k(x+\xi)}, & \text{for } \xi < x \end{cases} \\ &= \begin{cases} -\frac{1}{k} e^{-k\xi} \cosh(kx), & \text{for } x < \xi \\ -\frac{1}{k} e^{-kx} \cosh(k\xi), & \text{for } \xi < x \end{cases} \end{aligned}$$

$$G(x; \xi) = -\frac{1}{k} e^{-kx} \cosh(kx_{<})$$

The Green functions which satisfies  $G(0; \xi) = 0$  and  $G'(0; \xi) = 0$  are shown in Figure 21.8.

### Solution 21.19

1. The Green function satisfies

$$g'' - a^2 g = \delta(x - \xi), \quad g(0; \xi) = g'(L; \xi) = 0.$$

We can write the set of homogeneous solutions as

$$\{e^{ax}, e^{-ax}\} \text{ or } \{\cosh(ax), \sinh(ax)\}.$$

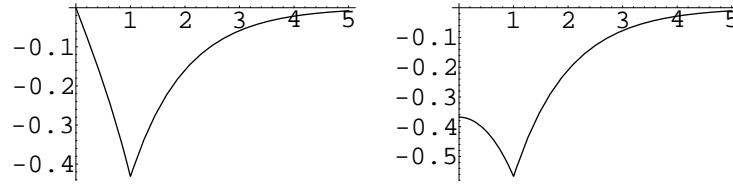

Figure 21.8:  $G(x; 1)$  and  $G(x; -1)$

The solutions that respectively satisfy the left and right boundary conditions are

$$u_1 = \sinh(ax), \quad u_2 = \cosh(a(x - L)).$$

The Wronskian of these solutions is

$$W(x) = \begin{pmatrix} \sinh(ax) & \cosh(a(x - L)) \\ a \cosh(ax) & a \sinh(a(x - L)) \end{pmatrix} = -a \cosh(aL).$$

Thus the Green function is

$$g(x; \xi) = \begin{cases} -\frac{\sinh(ax) \cosh(a(\xi - L))}{a \cosh(aL)} & \text{for } x \leq \xi, \\ -\frac{\sinh(a\xi) \cosh(a(x - L))}{a \cosh(aL)} & \text{for } \xi \leq x. \end{cases} = -\frac{\sinh(ax_{<}) \cosh(a(x_{>} - L))}{a \cosh(aL)}.$$

2. We take the limit as  $L \rightarrow \infty$ .

$$\begin{aligned} g(x; \xi) &= \lim_{L \rightarrow \infty} -\frac{\sinh(ax_{<}) \cosh(a(x_{>} - L))}{a \cosh(aL)} \\ &= \lim_{L \rightarrow \infty} -\frac{\sinh(ax_{<}) \cosh(ax_{>}) \cosh(aL) - \sinh(ax_{>}) \sinh(aL)}{a \cosh(aL)} \\ &= -\frac{\sinh(ax_{<})}{a} (\cosh(ax_{>}) - \sinh(ax_{>})) \end{aligned}$$

$$g(x; \xi) = -\frac{1}{a} \sinh(ax_{<}) e^{-ax_{>}}$$

The solution of

$$y'' - a^2 y = e^{-x}, \quad y(0) = y'(\infty) = 0$$

is

$$\begin{aligned} y &= \int_0^\infty g(x; \xi) e^{-\xi} d\xi \\ &= -\frac{1}{a} \int_0^\infty \sinh(ax_{<}) e^{-ax_{>}} e^{-\xi} d\xi \\ &= -\frac{1}{a} \left( \int_0^x \sinh(a\xi) e^{-ax} e^{-\xi} d\xi + \int_x^\infty \sinh(ax) e^{-a\xi} e^{-\xi} d\xi \right) \end{aligned}$$

We first consider the case that  $a \neq 1$ .

$$\begin{aligned} &= -\frac{1}{a} \left( \frac{e^{-ax}}{a^2 - 1} (-a + e^{-x}(a \cosh(ax) + \sinh(ax))) + \frac{1}{a+1} e^{-(a+1)x} \sinh(ax) \right) \\ &= \frac{e^{-ax} - e^{-x}}{a^2 - 1} \end{aligned}$$

For  $a = 1$ , we have

$$\begin{aligned} y &= - \left( \frac{1}{4} e^{-x} (-1 + 2x + e^{-2x}) + \frac{1}{2} e^{-2x} \sinh(x) \right) \\ &= -\frac{1}{2} x e^{-x}. \end{aligned}$$

Thus the solution of the problem is

$$y = \begin{cases} \frac{e^{-ax} - e^{-x}}{a^2 - 1} & \text{for } a \neq 1, \\ -\frac{1}{2} x e^{-x} & \text{for } a = 1. \end{cases}$$

We note that this solution satisfies the differential equation and the boundary conditions.

## 21.13 Quiz

### Problem 21.1

Find the general solution of

$$y'' - y = f(x),$$

where  $f(x)$  is a known function.

**Solution**

## 21.14 Quiz Solutions

### Solution 21.1

$$y'' - y = f(x)$$

We substitute  $y = e^{\lambda x}$  into the homogeneous differential equation.

$$\begin{aligned}y'' - y &= 0 \\ \lambda^2 e^{\lambda x} - e^{\lambda x} &= 0 \\ \lambda &= \pm 1\end{aligned}$$

The homogeneous solutions are  $e^x$  and  $e^{-x}$ . The Wronskian of these solutions is

$$\begin{vmatrix} e^x & e^{-x} \\ e^x & -e^{-x} \end{vmatrix} = -2.$$

We find a particular solution with variation of parameters.

$$y_p = -e^x \int \frac{e^{-x} f(x)}{-2} dx + e^{-x} \int \frac{e^x f(x)}{-2} dx$$

The general solution is

$$y = c_1 e^x + c_2 e^{-x} - e^x \int \frac{e^{-x} f(x)}{-2} dx + e^{-x} \int \frac{e^x f(x)}{-2} dx.$$

# Chapter 22

## Difference Equations

Televisions should have a dial to turn up the intelligence. There is a brightness knob, but it doesn't work.

-?

### 22.1 Introduction

**Example 22.1.1 Gambler's ruin problem.** *Consider a gambler that initially has  $n$  dollars. He plays a game in which he has a probability  $p$  of winning a dollar and  $q$  of losing a dollar. (Note that  $p + q = 1$ .) The gambler has decided that if he attains  $N$  dollars he will stop playing the game. In this case we will say that he has succeeded. Of course if he runs out of money before that happens, we will say that he is ruined. What is the probability of the gambler's ruin? Let us denote this probability by  $a_n$ . We know that if he has no money left, then his ruin is certain, so  $a_0 = 1$ . If he reaches  $N$  dollars he will quit the game, so that  $a_N = 0$ . If he is somewhere in between ruin and success then the probability of his ruin is equal to  $p$  times the probability of his ruin if he had  $n + 1$  dollars plus  $q$  times the probability of his ruin if he had  $n - 1$  dollars. Writing this in an equation,*

$$a_n = pa_{n+1} + qa_{n-1} \quad \text{subject to} \quad a_0 = 1, \quad a_N = 0.$$

*This is an example of a difference equation. You will learn how to solve this particular problem in the section on constant coefficient equations.*

Consider the sequence  $a_1, a_2, a_3, \dots$ . Analogous to a derivative of a continuous function, we can define a discrete derivative on the sequence

$$Da_n = a_{n+1} - a_n.$$

The second discrete derivative is then defined as

$$D^2a_n = D[a_{n+1} - a_n] = a_{n+2} - 2a_{n+1} + a_n.$$

The discrete integral of  $a_n$  is

$$\sum_{i=n_0}^n a_i.$$

Corresponding to

$$\int_{\alpha}^{\beta} \frac{df}{dx} dx = f(\beta) - f(\alpha),$$

in the discrete realm we have

$$\sum_{n=\alpha}^{\beta-1} D[a_n] = \sum_{n=\alpha}^{\beta-1} (a_{n+1} - a_n) = a_{\beta} - a_{\alpha}.$$

Linear difference equations have the form

$$D^r a_n + p_{r-1}(n)D^{r-1}a_n + \dots + p_1(n)Da_n + p_0(n)a_n = f(n).$$

From the definition of the discrete derivative an equivalent form is

$$a_{n+r} + q_{r-1}(n)a_{n,r-1} + \dots + q_1(n)a_{n+1} + q_0(n)a_n = f(n).$$

Besides being important in their own right, we will need to solve difference equations in order to develop series solutions of differential equations. Also, some methods of solving differential equations numerically are based on approximating them with difference equations.

There are many similarities between differential and difference equations. Like differential equations, an  $r^{\text{th}}$  order homogeneous difference equation has  $r$  linearly independent solutions. The general solution to the  $r^{\text{th}}$  order inhomogeneous equation is the sum of the particular solution and an arbitrary linear combination of the homogeneous solutions.

For an  $r^{\text{th}}$  order difference equation, the initial condition is given by specifying the values of the first  $r$   $a_n$ 's.

**Example 22.1.2** Consider the difference equation  $a_{n-2} - a_{n-1} - a_n = 0$  subject to the initial condition  $a_1 = a_2 = 1$ . Note that although we may not know a closed-form formula for the  $a_n$  we can calculate the  $a_n$  in order by substituting into the difference equation. The first few  $a_n$  are 1, 1, 2, 3, 5, 8, 13, 21, ... We recognize this as the Fibonacci sequence.

## 22.2 Exact Equations

Consider the sequence  $a_1, a_2, \dots$ . Exact difference equations on this sequence have the form

$$D[F(a_n, a_{n+1}, \dots, n)] = g(n).$$

We can reduce the order of, (or solve for first order), this equation by summing from 1 to  $n - 1$ .

$$\begin{aligned} \sum_{j=1}^{n-1} D[F(a_j, a_{j+1}, \dots, j)] &= \sum_{j=1}^{n-1} g(j) \\ F(a_n, a_{n+1}, \dots, n) - F(a_1, a_2, \dots, 1) &= \sum_{j=1}^{n-1} g(j) \\ F(a_n, a_{n+1}, \dots, n) &= \sum_{j=1}^{n-1} g(j) + F(a_1, a_2, \dots, 1) \end{aligned}$$



**Result 22.2.1** We can reduce the order of the exact difference equation

$$D[F(a_n, a_{n+1}, \dots, n)] = g(n), \quad \text{for } n \geq 1$$

by summing both sides of the equation to obtain

$$F(a_n, a_{n+1}, \dots, n) = \sum_{j=1}^{n-1} g(j) + F(a_1, a_2, \dots, 1).$$

**Example 22.2.1** Consider the difference equation,  $D[na_n] = 1$ . Summing both sides of this equation

$$\sum_{j=1}^{n-1} D[ja_j] = \sum_{j=1}^{n-1} 1$$

$$na_n - a_1 = n - 1$$

$$a_n = \frac{n + a_1 - 1}{n}.$$

## 22.3 Homogeneous First Order

Consider the homogeneous first order difference equation

$$a_{n+1} = p(n)a_n, \quad \text{for } n \geq 1.$$

We can directly solve for  $a_n$ .

$$\begin{aligned} a_n &= a_n \frac{a_{n-1}}{a_{n-1}} \frac{a_{n-2}}{a_{n-2}} \cdots \frac{a_1}{a_1} \\ &= a_1 \frac{a_n}{a_{n-1}} \frac{a_{n-1}}{a_{n-2}} \cdots \frac{a_2}{a_1} \\ &= a_1 p(n-1)p(n-2) \cdots p(1) \\ &= a_1 \prod_{j=1}^{n-1} p(j) \end{aligned}$$

Alternatively, we could solve this equation by making it exact. Analogous to an integrating factor for differential equations, we multiply the equation by the summing factor

$$S(n) = \left[ \prod_{j=1}^n p(j) \right]^{-1}.$$

$$\begin{aligned} a_{n+1} - p(n)a_n &= 0 \\ \frac{a_{n+1}}{\prod_{j=1}^n p(j)} - \frac{a_n}{\prod_{j=1}^{n-1} p(j)} &= 0 \\ D \left[ \frac{a_n}{\prod_{j=1}^{n-1} p(j)} \right] &= 0 \end{aligned}$$

Now we sum from 1 to  $n-1$ .

$$\begin{aligned} \frac{a_n}{\prod_{j=1}^{n-1} p(j)} - a_1 &= 0 \\ a_n &= a_1 \prod_{j=1}^{n-1} p(j) \end{aligned}$$

**Result 22.3.1** The solution of the homogeneous first order difference equation

$$a_{n+1} = p(n)a_n, \quad \text{for } n \geq 1,$$

is

$$a_n = a_1 \prod_{j=1}^{n-1} p(j).$$

**Example 22.3.1** Consider the equation  $a_{n+1} = na_n$  with the initial condition  $a_1 = 1$ .

$$a_n = a_1 \prod_{j=1}^{n-1} j = (1)(n-1)! = \Gamma(n)$$

Recall that  $\Gamma(z)$  is the generalization of the factorial function. For positive integral values of the argument,  $\Gamma(n) = (n-1)!$ .

## 22.4 Inhomogeneous First Order

Consider the equation

$$a_{n+1} = p(n)a_n + q(n) \quad \text{for } n \geq 1.$$

Multiplying by  $S(n) = \left[ \prod_{j=1}^n p(j) \right]^{-1}$  yields

$$\frac{a_{n+1}}{\prod_{j=1}^n p(j)} - \frac{a_n}{\prod_{j=1}^{n-1} p(j)} = \frac{q(n)}{\prod_{j=1}^n p(j)}.$$

The left hand side is a discrete derivative.

$$D \left[ \frac{a_n}{\prod_{j=1}^{n-1} p(j)} \right] = \frac{q(n)}{\prod_{j=1}^n p(j)}$$

Summing both sides from 1 to  $n - 1$ ,

$$\frac{a_n}{\prod_{j=1}^{n-1} p(j)} - a_1 = \sum_{k=1}^{n-1} \left[ \frac{q(k)}{\prod_{j=1}^k p(j)} \right]$$

$$a_n = \left[ \prod_{m=1}^{n-1} p(m) \right] \left[ \sum_{k=1}^{n-1} \left[ \frac{q(k)}{\prod_{j=1}^k p(j)} \right] + a_1 \right].$$

**Result 22.4.1** The solution of the inhomogeneous first order difference equation

$$a_{n+1} = p(n)a_n + q(n) \quad \text{for } n \geq 1$$

is

$$a_n = \left[ \prod_{m=1}^{n-1} p(m) \right] \left[ \sum_{k=1}^{n-1} \left[ \frac{q(k)}{\prod_{j=1}^k p(j)} \right] + a_1 \right].$$

**Example 22.4.1** Consider the equation  $a_{n+1} = na_n + 1$  for  $n \geq 1$ . The summing factor is

$$S(n) = \left[ \prod_{j=1}^n j \right]^{-1} = \frac{1}{n!}.$$

Multiplying the difference equation by the summing factor,

$$\frac{a_{n+1}}{n!} - \frac{a_n}{(n-1)!} = \frac{1}{n!}$$

$$D \left[ \frac{a_n}{(n-1)!} \right] = \frac{1}{n!}$$

$$\frac{a_n}{(n-1)!} - a_1 = \sum_{k=1}^{n-1} \frac{1}{k!}$$

$$a_n = (n-1)! \left[ \sum_{k=1}^{n-1} \frac{1}{k!} + a_1 \right].$$

**Example 22.4.2** Consider the equation

$$a_{n+1} = \lambda a_n + \mu, \quad \text{for } n \geq 0.$$

From the above result, (with the products and sums starting at zero instead of one), the solution is

$$\begin{aligned} a_0 &= \left[ \prod_{m=0}^{n-1} \lambda \right] \left[ \sum_{k=0}^{n-1} \left[ \frac{\mu}{\prod_{j=0}^k \lambda} \right] + a_0 \right] \\ &= \lambda^n \left[ \sum_{k=0}^{n-1} \left[ \frac{\mu}{\lambda^{k+1}} \right] + a_0 \right] \\ &= \lambda^n \left[ \mu \frac{\lambda^{-n-1} - \lambda^{-1}}{\lambda^{-1} - 1} + a_0 \right] \\ &= \lambda^n \left[ \mu \frac{\lambda^{-n} - 1}{1 - \lambda} + a_0 \right] \\ &= \mu \frac{1 - \lambda^n}{1 - \lambda} + a_0 \lambda^n. \end{aligned}$$

## 22.5 Homogeneous Constant Coefficient Equations

Homogeneous constant coefficient equations have the form

$$a_{n+N} + p_{N-1}a_{n+N-1} + \cdots + p_1a_{n+1} + p_0a_n = 0.$$

The substitution  $a_n = r^n$  yields

$$\begin{aligned} r^N + p_{N-1}r^{N-1} + \cdots + p_1r + p_0 &= 0 \\ (r - r_1)^{m_1} \cdots (r - r_k)^{m_k} &= 0. \end{aligned}$$

If  $r_1$  is a distinct root then the associated linearly independent solution is  $r_1^n$ . If  $r_1$  is a root of multiplicity  $m > 1$  then the associated solutions are  $r_1^n, nr_1^n, n^2r_1^n, \dots, n^{m-1}r_1^n$ .

**Result 22.5.1** Consider the homogeneous constant coefficient difference equation

$$a_{n+N} + p_{N-1}a_{n+N-1} + \cdots + p_1a_{n+1} + p_0a_n = 0.$$

The substitution  $a_n = r^n$  yields the equation

$$(r - r_1)^{m_1} \cdots (r - r_k)^{m_k} = 0.$$

A set of linearly independent solutions is

$$\{r_1^n, nr_1^n, \dots, n^{m_1-1}r_1^n, \dots, r_k^n, nr_k^n, \dots, n^{m_k-1}r_k^n\}.$$

**Example 22.5.1** Consider the equation  $a_{n+2} - 3a_{n+1} + 2a_n = 0$  with the initial conditions  $a_1 = 1$  and  $a_2 = 3$ . The substitution  $a_n = r^n$  yields

$$r^2 - 3r + 2 = (r - 1)(r - 2) = 0.$$

Thus the general solution is

$$a_n = c_11^n + c_22^n.$$

The initial conditions give the two equations,

$$a_1 = 1 = c_1 + 2c_2$$

$$a_2 = 3 = c_1 + 4c_2$$

Since  $c_1 = -1$  and  $c_2 = 1$ , the solution to the difference equation subject to the initial conditions is

$$a_n = 2^n - 1.$$

**Example 22.5.2** Consider the gambler's ruin problem that was introduced in Example 22.1.1. The equation for the probability of the gambler's ruin at  $n$  dollars is

$$a_n = pa_{n+1} + qa_{n-1} \quad \text{subject to} \quad a_0 = 1, \quad a_N = 0.$$

We assume that  $0 < p < 1$ . With the substitution  $a_n = r^n$  we obtain

$$r = pr^2 + q.$$

The roots of this equation are

$$\begin{aligned} r &= \frac{1 \pm \sqrt{1 - 4pq}}{2p} \\ &= \frac{1 \pm \sqrt{1 - 4p(1-p)}}{2p} \\ &= \frac{1 \pm \sqrt{(1-2p)^2}}{2p} \\ &= \frac{1 \pm |1-2p|}{2p}. \end{aligned}$$

We will consider the two cases  $p \neq 1/2$  and  $p = 1/2$ .

$p \neq 1/2$ . If  $p < 1/2$ , the roots are

$$r = \frac{1 \pm (1 - 2p)}{2p}$$
$$r_1 = \frac{1 - p}{p} = \frac{q}{p}, \quad r_2 = 1.$$

If  $p > 1/2$  the roots are

$$r = \frac{1 \pm (2p - 1)}{2p}$$
$$r_1 = 1, \quad r_2 = \frac{-p + 1}{p} = \frac{q}{p}.$$

Thus the general solution for  $p \neq 1/2$  is

$$a_n = c_1 + c_2 \left(\frac{q}{p}\right)^n.$$

The boundary condition  $a_0 = 1$  requires that  $c_1 + c_2 = 1$ . From the boundary condition  $a_N = 0$  we have

$$(1 - c_2) + c_2 \left(\frac{q}{p}\right)^N = 0$$
$$c_2 = \frac{-1}{-1 + (q/p)^N}$$
$$c_2 = \frac{p^N}{p^N - q^N}.$$

Solving for  $c_1$ ,

$$c_1 = 1 - \frac{p^N}{p^N - q^N}$$
$$c_1 = \frac{-q^N}{p^N - q^N}.$$



Thus we have

$$a_n = \frac{-q^N}{p^N - q^N} + \frac{p^N}{p^N - q^N} \left(\frac{q}{p}\right)^n.$$

$p = 1/2$ . In this case, the two roots of the polynomial are both 1. The general solution is

$$a_n = c_1 + c_2 n.$$

The left boundary condition demands that  $c_1 = 1$ . From the right boundary condition we obtain

$$\begin{aligned} 1 + c_2 N &= 0 \\ c_2 &= -\frac{1}{N}. \end{aligned}$$

Thus the solution for this case is

$$a_n = 1 - \frac{n}{N}.$$

As a check that this formula makes sense, we see that for  $n = N/2$  the probability of ruin is  $1 - \frac{N/2}{N} = \frac{1}{2}$ .

## 22.6 Reduction of Order

Consider the difference equation

$$(n+1)(n+2)a_{n+2} - 3(n+1)a_{n+1} + 2a_n = 0 \quad \text{for } n \geq 0 \quad (22.1)$$

We see that one solution to this equation is  $a_n = 1/n!$ . Analogous to the reduction of order for differential equations, the substitution  $a_n = b_n/n!$  will reduce the order of the difference equation.

$$\begin{aligned} \frac{(n+1)(n+2)b_{n+2}}{(n+2)!} - \frac{3(n+1)b_{n+1}}{(n+1)!} + \frac{2b_n}{n!} &= 0 \\ b_{n+2} - 3b_{n+1} + 2b_n &= 0 \end{aligned} \quad (22.2)$$

At first glance it appears that we have not reduced the order of the equation, but writing it in terms of discrete derivatives

$$D^2b_n - Db_n = 0$$

shows that we now have a first order difference equation for  $Db_n$ . The substitution  $b_n = r^n$  in equation 22.2 yields the algebraic equation

$$r^2 - 3r + 2 = (r - 1)(r - 2) = 0.$$

Thus the solutions are  $b_n = 1$  and  $b_n = 2^n$ . Only the  $b_n = 2^n$  solution will give us another linearly independent solution for  $a_n$ . Thus the second solution for  $a_n$  is  $a_n = b_n/n! = 2^n/n!$ . The general solution to equation 22.1 is then

$$a_n = c_1 \frac{1}{n!} + c_2 \frac{2^n}{n!}.$$

**Result 22.6.1** Let  $a_n = s_n$  be a homogeneous solution of a linear difference equation. The substitution  $a_n = s_n b_n$  will yield a difference equation for  $b_n$  that is of order one less than the equation for  $a_n$ .

## 22.7 Exercises

### Exercise 22.1

Find a formula for the  $n^{\text{th}}$  term in the Fibonacci sequence  $1, 1, 2, 3, 5, 8, 13, \dots$

[Hint](#), [Solution](#)

### Exercise 22.2

Solve the difference equation

$$a_{n+2} = \frac{2}{n}a_n, \quad a_1 = a_2 = 1.$$

[Hint](#), [Solution](#)

## 22.8 Hints

### Hint 22.1

The difference equation corresponding to the Fibonacci sequence is

$$a_{n+2} - a_{n+1} - a_n = 0, \quad a_1 = a_2 = 1.$$

### Hint 22.2

Consider this exercise as two first order difference equations; one for the even terms, one for the odd terms.

## 22.9 Solutions

### Solution 22.1

We can describe the Fibonacci sequence with the difference equation

$$a_{n+2} - a_{n+1} - a_n = 0, \quad a_1 = a_2 = 1.$$

With the substitution  $a_n = r^n$  we obtain the equation

$$r^2 - r - 1 = 0.$$

This equation has the two distinct roots

$$r_1 = \frac{1 + \sqrt{5}}{2}, \quad r_2 = \frac{1 - \sqrt{5}}{2}.$$

Thus the general solution is

$$a_n = c_1 \left( \frac{1 + \sqrt{5}}{2} \right)^n + c_2 \left( \frac{1 - \sqrt{5}}{2} \right)^n.$$

From the initial conditions we have

$$c_1 r_1 + c_2 r_2 = 1$$

$$c_1 r_1^2 + c_2 r_2^2 = 1.$$

Solving for  $c_2$  in the first equation,

$$c_2 = \frac{1}{r_2}(1 - c_1 r_1).$$

We substitute this into the second equation.

$$c_1 r_1^2 + \frac{1}{r_2}(1 - c_1 r_1)r_2^2 = 1$$

$$c_1(r_1^2 - r_1 r_2) = 1 - r_2$$

$$\begin{aligned}
c_1 &= \frac{1 - r_2}{r_1^2 - r_1 r_2} \\
&= \frac{1 - \frac{1 - \sqrt{5}}{2}}{\frac{1 + \sqrt{5}}{2} \sqrt{5}} \\
&= \frac{\frac{1 + \sqrt{5}}{2}}{\frac{1 + \sqrt{5}}{2} \sqrt{5}} \\
&= \frac{1}{\sqrt{5}}
\end{aligned}$$

Substitute this result into the equation for  $c_2$ .

$$\begin{aligned}
c_2 &= \frac{1}{r_2} \left( 1 - \frac{1}{\sqrt{5}} r_1 \right) \\
&= \frac{2}{1 - \sqrt{5}} \left( 1 - \frac{1}{\sqrt{5}} \frac{1 + \sqrt{5}}{2} \right) \\
&= -\frac{2}{1 - \sqrt{5}} \left( \frac{1 - \sqrt{5}}{2\sqrt{5}} \right) \\
&= -\frac{1}{\sqrt{5}}
\end{aligned}$$

Thus the  $n^{\text{th}}$  term in the Fibonacci sequence has the formula

$$a_n = \frac{1}{\sqrt{5}} \left( \frac{1 + \sqrt{5}}{2} \right)^n - \frac{1}{\sqrt{5}} \left( \frac{1 - \sqrt{5}}{2} \right)^n.$$

It is interesting to note that although the Fibonacci sequence is defined in terms of integers, one cannot express the formula form the  $n^{\text{th}}$  element in terms of rational numbers.

## Solution 22.2

We can consider

$$a_{n+2} = \frac{2}{n}a_n, \quad a_1 = a_2 = 1$$

to be a first order difference equation. First consider the odd terms.

$$a_1 = 1$$

$$a_3 = \frac{2}{1}$$

$$a_5 = \frac{2 \cdot 2}{3 \cdot 1}$$

$$a_n = \frac{2^{(n-1)/2}}{(n-2)(n-4)\cdots(1)}$$

For the even terms,

$$a_2 = 1$$

$$a_4 = \frac{2}{2}$$

$$a_6 = \frac{2 \cdot 2}{4 \cdot 2}$$

$$a_n = \frac{2^{(n-2)/2}}{(n-2)(n-4)\cdots(2)}.$$

Thus

$$a_n = \begin{cases} \frac{2^{(n-1)/2}}{(n-2)(n-4)\cdots(1)} & \text{for odd } n \\ \frac{2^{(n-2)/2}}{(n-2)(n-4)\cdots(2)} & \text{for even } n. \end{cases}$$

# Chapter 23

## Series Solutions of Differential Equations

Skill beats honesty any day.

-?

### 23.1 Ordinary Points

**Big  $\mathcal{O}$  and Little  $o$  Notation.** The notation  $\mathcal{O}(z^n)$  means “terms no bigger than  $z^n$ .” This gives us a convenient shorthand for manipulating series. For example,

$$\sin z = z - \frac{z^3}{6} + \mathcal{O}(z^5)$$

$$\frac{1}{1-z} = 1 + \mathcal{O}(z)$$

The notation  $o(z^n)$  means “terms smaller than  $z^n$ .” For example,

$$\cos z = 1 + o(1)$$

$$e^z = 1 + z + o(z)$$



**Example 23.1.1** Consider the equation

$$w''(z) - 3w'(z) + 2w(z) = 0.$$

The general solution to this constant coefficient equation is

$$w = c_1 e^z + c_2 e^{2z}.$$

The functions  $e^z$  and  $e^{2z}$  are analytic in the finite complex plane. Recall that a function is analytic at a point  $z_0$  if and only if the function has a Taylor series about  $z_0$  with a nonzero radius of convergence. If we substitute the Taylor series expansions about  $z = 0$  of  $e^z$  and  $e^{2z}$  into the general solution, we obtain

$$w = c_1 \sum_{n=0}^{\infty} \frac{z^n}{n!} + c_2 \sum_{n=0}^{\infty} \frac{2^n z^n}{n!}.$$

Thus we have a series solution of the differential equation.

Alternatively, we could try substituting a Taylor series into the differential equation and solving for the coefficients. Substituting  $w = \sum_{n=0}^{\infty} a_n z^n$  into the differential equation yields

$$\begin{aligned} \frac{d^2}{dz^2} \sum_{n=0}^{\infty} a_n z^n - 3 \frac{d}{dz} \sum_{n=0}^{\infty} a_n z^n + 2 \sum_{n=0}^{\infty} a_n z^n &= 0 \\ \sum_{n=2}^{\infty} n(n-1) a_n z^{n-2} - 3 \sum_{n=1}^{\infty} n a_n z^{n-1} + 2 \sum_{n=0}^{\infty} a_n z^n &= 0 \\ \sum_{n=0}^{\infty} (n+2)(n+1) a_{n+2} z^n - 3 \sum_{n=0}^{\infty} (n+1) a_{n+1} z^n + 2 \sum_{n=0}^{\infty} a_n z^n &= 0 \\ \sum_{n=0}^{\infty} \left[ (n+2)(n+1) a_{n+2} - 3(n+1) a_{n+1} + 2a_n \right] z^n &= 0. \end{aligned}$$

Equating powers of  $z$ , we obtain the difference equation

$$(n+2)(n+1) a_{n+2} - 3(n+1) a_{n+1} + 2a_n = 0, \quad n \geq 0.$$

We see that  $a_n = 1/n!$  is one solution since

$$\frac{(n+2)(n+1)}{(n+2)!} - 3\frac{n+1}{(n+1)!} + 2\frac{1}{n!} = \frac{1-3+2}{n!} = 0.$$

We use reduction of order for difference equations to find the other solution. Substituting  $a_n = b_n/n!$  into the difference equation yields

$$(n+2)(n+1)\frac{b_{n+2}}{(n+2)!} - 3(n+1)\frac{b_{n+1}}{(n+1)!} + 2\frac{b_n}{n!} = 0$$
$$b_{n+2} - 3b_{n+1} + 2b_n = 0.$$

At first glance it appears that we have not reduced the order of the difference equation. However writing this equation in terms of discrete derivatives,

$$D^2b_n - Db_n = 0$$

we see that this is a first order difference equation for  $Db_n$ . Since this is a constant coefficient difference equation we substitute  $b_n = r^n$  into the equation to obtain an algebraic equation for  $r$ .

$$r^2 - 3r + 2 = (r-1)(r-2) = 0$$

Thus the two solutions are  $b_n = 1^n b_0$  and  $b_n = 2^n b_0$ . Only  $b_n = 2^n b_0$  will give us a second independent solution for  $a_n$ . Thus the two solutions for  $a_n$  are

$$a_n = \frac{a_0}{n!} \quad \text{and} \quad a_n = \frac{2^n a_0}{n!}.$$

Thus we can write the general solution to the differential equation as

$$w = c_1 \sum_{n=0}^{\infty} \frac{z^n}{n!} + c_2 \sum_{n=0}^{\infty} \frac{2^n z^n}{n!}.$$

We recognize these two sums as the Taylor expansions of  $e^z$  and  $e^{2z}$ . Thus we obtain the same result as we did solving the differential equation directly.

Of course it would be pretty silly to go through all the grunge involved in developing a series expansion of the solution in a problem like Example 23.1.1 since we can solve the problem exactly. However if we could not solve a differential equation, then having a Taylor series expansion of the solution about a point  $z_0$  would be useful in determining the behavior of the solutions near that point.

For this method of substituting a Taylor series into the differential equation to be useful we have to know at what points the solutions are analytic. Let's say we were considering a second order differential equation whose solutions were

$$w_1 = \frac{1}{z}, \quad \text{and} \quad w_2 = \log z.$$

Trying to find a Taylor series expansion of the solutions about the point  $z = 0$  would fail because the solutions are not analytic at  $z = 0$ . This brings us to two important questions.

1. Can we tell if the solutions to a linear differential equation are analytic at a point without knowing the solutions?
2. If there are Taylor series expansions of the solutions to a differential equation, what are the radii of convergence of the series?

In order to answer these questions, we will introduce the concept of an ordinary point. Consider the  $n^{\text{th}}$  order linear homogeneous equation

$$\frac{d^n w}{dz^n} + p_{n-1}(z) \frac{d^{n-1} w}{dz^{n-1}} + \cdots + p_1(z) \frac{dw}{dz} + p_0(z) w = 0.$$

If each of the coefficient functions  $p_i(z)$  are analytic at  $z = z_0$  then  $z_0$  is an **ordinary point** of the differential equation.

For reasons of typography we will restrict our attention to second order equations and the point  $z_0 = 0$  for a while. The generalization to an  $n^{\text{th}}$  order equation will be apparent. Considering the point  $z_0 \neq 0$  is only trivially more general as we could introduce the transformation  $z - z_0 \rightarrow z$  to move the point to the origin.

In the chapter on first order differential equations we showed that the solution is analytic at ordinary points. One would guess that this remains true for higher order equations. Consider the second order equation

$$y'' + p(z)y' + q(z)y = 0,$$

where  $p$  and  $q$  are analytic at the origin.

$$p(z) = \sum_{n=0}^{\infty} p_n z^n, \quad \text{and} \quad q(z) = \sum_{n=0}^{\infty} q_n z^n$$

Assume that one of the solutions is not analytic at the origin and behaves like  $z^\alpha$  at  $z = 0$  where  $\alpha \neq 0, 1, 2, \dots$ . That is, we can approximate the solution with  $w(z) = z^\alpha + o(z^\alpha)$ . Let's substitute  $w = z^\alpha + o(z^\alpha)$  into the differential equation and look at the lowest power of  $z$  in each of the terms.

$$[\alpha(\alpha - 1)z^{\alpha-2} + o(z^{\alpha-2})] + [\alpha z^{\alpha-1} + o(z^{\alpha-1})] \sum_{n=0}^{\infty} p_n z^n + [z^\alpha + o(z^\alpha)] \sum_{n=0}^{\infty} q_n z^n = 0.$$

We see that the solution could not possibly behave like  $z^\alpha$ ,  $\alpha \neq 0, 1, 2, \dots$  because there is no term on the left to cancel out the  $z^{\alpha-2}$  term. The terms on the left side could not add to zero.

You could also check that a solution could not possibly behave like  $\log z$  at the origin. Though we will not prove it, if  $z_0$  is an ordinary point of a homogeneous differential equation, then all the solutions are analytic at the point  $z_0$ . Since the solution is analytic at  $z_0$  we can expand it in a Taylor series.

Now we are prepared to answer our second question. From complex variables, we know that the radius of convergence of the Taylor series expansion of a function is the distance to the nearest singularity of that function. Since the solutions to a differential equation are analytic at ordinary points of the equation, the series expansion about an ordinary point will have a radius of convergence at least as large as the distance to the nearest singularity of the coefficient functions.

**Example 23.1.2** Consider the equation

$$w'' + \frac{1}{\cos z} w' + z^2 w = 0.$$

If we expand the solution to the differential equation in Taylor series about  $z = 0$ , the radius of convergence will be at least  $\pi/2$ . This is because the coefficient functions are analytic at the origin, and the nearest singularities of  $1/\cos z$  are at  $z = \pm\pi/2$ .

### 23.1.1 Taylor Series Expansion for a Second Order Differential Equation

Consider the differential equation

$$w'' + p(z)w' + q(z)w = 0$$

where  $p(z)$  and  $q(z)$  are analytic in some neighborhood of the origin.

$$p(z) = \sum_{n=0}^{\infty} p_n z^n \quad \text{and} \quad q(z) = \sum_{n=0}^{\infty} q_n z^n$$

We substitute a Taylor series and its derivatives

$$\begin{aligned} w &= \sum_{n=0}^{\infty} a_n z^n \\ w' &= \sum_{n=1}^{\infty} n z_n z^{n-1} = \sum_{n=0}^{\infty} (n+1) a_{n+1} z^n \\ w'' &= \sum_{n=2}^{\infty} n(n-1) a_n z^{n-2} = \sum_{n=0}^{\infty} (n+2)(n+1) a_{n+2} z^n \end{aligned}$$

into the differential equation to obtain

$$\begin{aligned} \sum_{n=0}^{\infty} (n+2)(n+1) a_{n+2} z^n + \left( \sum_{n=0}^{\infty} p_n z^n \right) \left( \sum_{n=0}^{\infty} (n+1) a_{n+1} z^n \right) \\ + \left( \sum_{n=0}^{\infty} q_n z^n \right) \left( \sum_{n=0}^{\infty} a_n z^n \right) = 0 \end{aligned}$$

$$\begin{aligned} \sum_{n=0}^{\infty} (n+2)(n+1) a_{n+2} z^n + \sum_{n=0}^{\infty} \left( \sum_{m=0}^n (m+1) a_{m+1} p_{n-m} \right) z^n + \sum_{n=0}^{\infty} \left( \sum_{m=0}^n a_m q_{n-m} \right) z^n = 0 \\ \sum_{n=0}^{\infty} \left[ (n+2)(n+1) a_{n+2} + \sum_{m=0}^n ((m+1) a_{m+1} p_{n-m} + a_m q_{n-m}) \right] z^n = 0. \end{aligned}$$

Equating coefficients of powers of  $z$ ,

$$(n+2)(n+1)a_{n+2} + \sum_{m=0}^n ((m+1)a_{m+1}p_{n-m} + a_m q_{n-m}) = 0 \quad \text{for } n \geq 0.$$

We see that  $a_0$  and  $a_1$  are arbitrary and the rest of the coefficients are determined by the recurrence relation

$$a_{n+2} = -\frac{1}{(n+1)(n+2)} \sum_{m=0}^n ((m+1)a_{m+1}p_{n-m} + a_m q_{n-m}) \quad \text{for } n \geq 0.$$

**Example 23.1.3** Consider the problem

$$y'' + \frac{1}{\cos x} y' + e^x y = 0, \quad y(0) = y'(0) = 1.$$

Let's expand the solution in a Taylor series about the origin.

$$y(x) = \sum_{n=0}^{\infty} a_n x^n$$

Since  $y(0) = a_0$  and  $y'(0) = a_1$ , we see that  $a_0 = a_1 = 1$ . The Taylor expansions of the coefficient functions are

$$\frac{1}{\cos x} = 1 + \mathcal{O}(x), \quad \text{and} \quad e^x = 1 + \mathcal{O}(x).$$

Now we can calculate  $a_2$  from the recurrence relation.

$$\begin{aligned} a_2 &= -\frac{1}{1 \cdot 2} \sum_{m=0}^0 ((m+1)a_{m+1}p_{0-m} + a_m q_{0-m}) \\ &= -\frac{1}{2}(1 \cdot 1 \cdot 1 + 1 \cdot 1) \\ &= -1 \end{aligned}$$

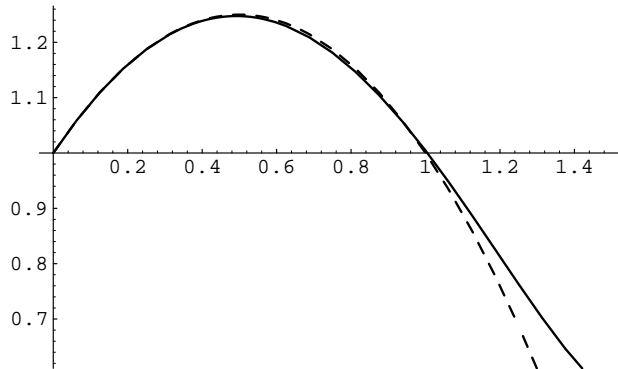

Figure 23.1: Plot of the Numerical Solution and the First Three Terms in the Taylor Series.

Thus the solution to the problem is

$$y(x) = 1 + x - x^2 + \mathcal{O}(x^3).$$

In Figure 23.1 the numerical solution is plotted in a solid line and the sum of the first three terms of the Taylor series is plotted in a dashed line.

The general recurrence relation for the  $a_n$ 's is useful if you only want to calculate the first few terms in the Taylor expansion. However, for many problems substituting the Taylor series for the coefficient functions into the differential equation will enable you to find a simpler form of the solution. We consider the following example to illustrate this point.

**Example 23.1.4** *Develop a series expansion of the solution to the initial value problem*

$$w'' + \frac{1}{(z^2 + 1)}w = 0, \quad w(0) = 1, \quad w'(0) = 0.$$

**Solution using the General Recurrence Relation.** *The coefficient function has the Taylor expansion*

$$\frac{1}{1 + z^2} = \sum_{n=0}^{\infty} (-1)^n z^{2n}.$$

*From the initial condition we obtain  $a_0 = 1$  and  $a_1 = 0$ . Thus we see that the solution is*

$$w = \sum_{n=0}^{\infty} a_n z^n,$$

where

$$a_{n+2} = -\frac{1}{(n+1)(n+2)} \sum_{m=0}^n a_m q_{n-m}$$

and

$$q_n = \begin{cases} 0 & \text{for odd } n \\ (-1)^{(n/2)} & \text{for even } n. \end{cases}$$

*Although this formula is fine if you only want to calculate the first few  $a_n$ 's, it is just a tad unwieldy to work with. Let's see if we can get a better expression for the solution.*

**Substitute the Taylor Series into the Differential Equation.** *Substituting a Taylor series for  $w$  yields*

$$\frac{d^2}{dz^2} \sum_{n=0}^{\infty} a_n z^n + \frac{1}{(z^2 + 1)} \sum_{n=0}^{\infty} a_n z^n = 0.$$



Note that the algebra will be easier if we multiply by  $z^2 + 1$ . The polynomial  $z^2 + 1$  has only two terms, but the Taylor series for  $1/(z^2 + 1)$  has an infinite number of terms.

$$\begin{aligned}
 (z^2 + 1) \frac{d^2}{dz^2} \sum_{n=0}^{\infty} a_n z^n + \sum_{n=0}^{\infty} a_n z^n &= 0 \\
 \sum_{n=2}^{\infty} n(n-1) a_n z^n + \sum_{n=2}^{\infty} n(n-1) a_n z^{n-2} + \sum_{n=0}^{\infty} a_n z^n &= 0 \\
 \sum_{n=0}^{\infty} n(n-1) a_n z^n + \sum_{n=0}^{\infty} (n+2)(n+1) a_{n+2} z^n + \sum_{n=0}^{\infty} a_n z^n &= 0 \\
 \sum_{n=0}^{\infty} \left[ (n+2)(n+1) a_{n+2} + n(n-1) a_n + a_n \right] z^n &= 0
 \end{aligned}$$

Equating powers of  $z$  gives us the difference equation

$$a_{n+2} = -\frac{n^2 - n + 1}{(n+2)(n+1)} a_n, \quad \text{for } n \geq 0.$$

From the initial conditions we see that  $a_0 = 1$  and  $a_1 = 0$ . All of the odd terms in the series will be zero. For the even terms, it is easier to reformulate the problem with the change of variables  $b_n = a_{2n}$ . In terms of  $b_n$  the difference equation is

$$b_{n+1} = -\frac{(2n)^2 - 2n + 1}{(2n+2)(2n+1)} b_n, \quad b_0 = 1.$$

This is a first order difference equation with the solution

$$b_n = \prod_{j=0}^n \left( -\frac{4j^2 - 2j + 1}{(2j+2)(2j+1)} \right).$$

Thus we have that

$$a_n = \begin{cases} \prod_{j=0}^{n/2} \left( -\frac{4j^2 - 2j + 1}{(2j+2)(2j+1)} \right) & \text{for even } n, \\ 0 & \text{for odd } n. \end{cases}$$

Note that the nearest singularities of  $1/(z^2 + 1)$  in the complex plane are at  $z = \pm i$ . Thus the radius of convergence must be at least 1. Applying the ratio test, the series converges for values of  $|z|$  such that

$$\lim_{n \rightarrow \infty} \left| \frac{a_{n+2} z^{n+2}}{a_n z^n} \right| < 1$$

$$\lim_{n \rightarrow \infty} \left| -\frac{n^2 - n + 1}{(n+2)(n+1)} \right| |z|^2 < 1$$

$$|z|^2 < 1.$$

The radius of convergence is 1.

The first few terms in the Taylor expansion are

$$w = 1 - \frac{1}{2}z^2 + \frac{1}{8}z^4 - \frac{13}{240}z^6 + \dots$$

In Figure 23.2 the plot of the first two nonzero terms is shown in a short dashed line, the plot of the first four nonzero terms is shown in a long dashed line, and the numerical solution is shown in a solid line.

In general, if the coefficient functions are rational functions, that is they are fractions of polynomials, multiplying the equations by the quotient will reduce the algebra involved in finding the series solution.

**Example 23.1.5** If we were going to find the Taylor series expansion about  $z = 0$  of the solution to

$$w'' + \frac{z}{1+z}w' + \frac{1}{1-z^2}w = 0,$$

we would first want to multiply the equation by  $1 - z^2$  to obtain

$$(1 - z^2)w'' + z(1 - z)w' + w = 0.$$

**Example 23.1.6** Find the series expansions about  $z = 0$  of the fundamental set of solutions for

$$w'' + z^2w = 0.$$

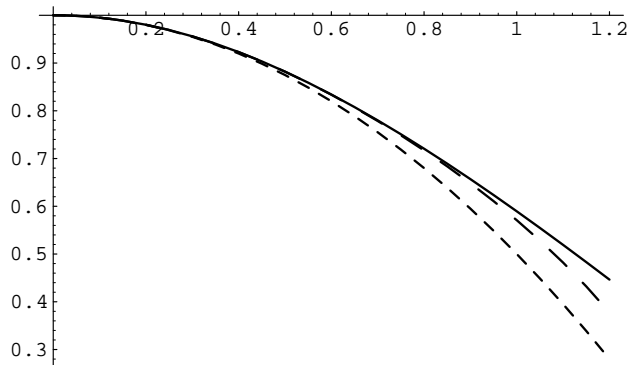

Figure 23.2: Plot of the solution and approximations.

Recall that the fundamental set of solutions  $\{w_1, w_2\}$  satisfy

$$\begin{aligned} w_1(0) &= 1 & w_2(0) &= 0 \\ w_1'(0) &= 0 & w_2'(0) &= 1. \end{aligned}$$

Thus if

$$w_1 = \sum_{n=0}^{\infty} a_n z^n \quad \text{and} \quad w_2 = \sum_{n=0}^{\infty} b_n z^n,$$

then the coefficients must satisfy

$$a_0 = 1, \quad a_1 = 0, \quad \text{and} \quad b_0 = 0, \quad b_1 = 1.$$

Substituting the Taylor expansion  $w = \sum_{n=0}^{\infty} c_n z^n$  into the differential equation,

$$\begin{aligned} \sum_{n=2}^{\infty} n(n-1)c_n z^{n-2} + \sum_{n=0}^{\infty} c_n z^{n+2} &= 0 \\ \sum_{n=0}^{\infty} (n+2)(n+1)c_{n+2} z^n + \sum_{n=2}^{\infty} c_{n-2} z^n &= 0 \\ 2c_2 + 6c_3 z + \sum_{n=2}^{\infty} \left[ (n+2)(n+1)c_{n+2} + c_{n-2} \right] z^n &= 0 \end{aligned}$$

Equating coefficients of powers of  $z$ ,

$$z^0 : c_2 = 0$$

$$z^1 : c_3 = 0$$

$$z^n : (n+2)(n+1)c_{n+2} + c_{n-2} = 0, \quad \text{for } n \geq 2$$

$$c_{n+4} = -\frac{c_n}{(n+4)(n+3)}$$

For our first solution we have the difference equation

$$a_0 = 1, \quad a_1 = 0, \quad a_2 = 0, \quad a_3 = 0, \quad a_{n+4} = -\frac{a_n}{(n+4)(n+3)}.$$

For our second solution,

$$b_0 = 0, \quad b_1 = 1, \quad b_2 = 0, \quad b_3 = 0, \quad b_{n+4} = -\frac{b_n}{(n+4)(n+3)}.$$

The first few terms in the fundamental set of solutions are

$$\boxed{w_1 = 1 - \frac{1}{12}z^4 + \frac{1}{672}z^8 - \dots, \quad w_2 = z - \frac{1}{20}z^5 + \frac{1}{1440}z^9 - \dots}$$

In Figure 23.3 the five term approximation is graphed in a coarse dashed line, the ten term approximation is graphed in a fine dashed line, and the numerical solution of  $w_1$  is graphed in a solid line. The same is done for  $w_2$ .

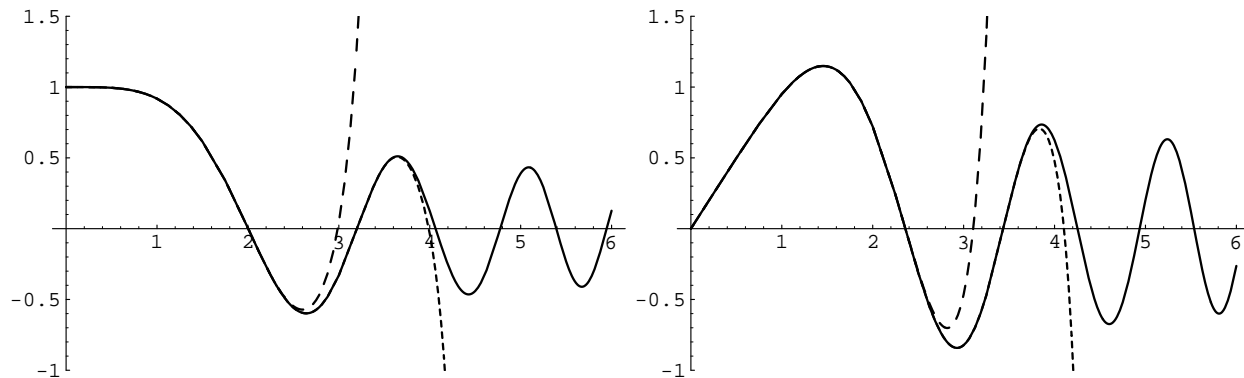

Figure 23.3: The graph of approximations and numerical solution of  $w_1$  and  $w_2$ .

**Result 23.1.1** Consider the  $n^{\text{th}}$  order linear homogeneous equation

$$\frac{d^n w}{dz^n} + p_{n-1}(z) \frac{d^{n-1} w}{dz^{n-1}} + \cdots + p_1(z) \frac{dw}{dz} + p_0(z) w = 0.$$

If each of the coefficient functions  $p_i(z)$  are analytic at  $z = z_0$  then  $z_0$  is an ordinary point of the differential equation. The solution is analytic in some region containing  $z_0$  and can be expanded in a Taylor series. The radius of convergence of the series will be at least the distance to the nearest singularity of the coefficient functions in the complex plane.

## 23.2 Regular Singular Points of Second Order Equations

Consider the differential equation

$$w'' + \frac{p(z)}{z - z_0}w' + \frac{q(z)}{(z - z_0)^2}w = 0.$$

If  $z = z_0$  is not an ordinary point but both  $p(z)$  and  $q(z)$  are analytic at  $z = z_0$  then  $z_0$  is a **regular singular point** of the differential equation. The following equations have a regular singular point at  $z = 0$ .

- $w'' + \frac{1}{z}w' + z^2w = 0$
- $w'' + \frac{1}{\sin z}w' - w = 0$
- $w'' - zw' + \frac{1}{z \sin z}w = 0$

Concerning regular singular points of second order linear equations there is good news and bad news.

**The Good News.** We will find that with the use of the Frobenius method we can always find series expansions of two linearly independent solutions at a regular singular point. We will illustrate this theory with several examples.

**The Bad News.** Instead of a tidy little theory like we have for ordinary points, the solutions can be of several different forms. Also, for some of the problems the algebra can get pretty ugly.

**Example 23.2.1** Consider the equation

$$w'' + \frac{3(1+z)}{16z^2}w = 0.$$

We wish to find series solutions about the point  $z = 0$ . First we try a Taylor series  $w = \sum_{n=0}^{\infty} a_n z^n$ . Substituting this

into the differential equation,

$$z^2 \sum_{n=2}^{\infty} n(n-1)a_n z^{n-2} + \frac{3}{16}(1+z) \sum_{n=0}^{\infty} a_n z^n = 0$$

$$\sum_{n=0}^{\infty} n(n-1)a_n z^n + \frac{3}{16} \sum_{n=0}^{\infty} a_n z^n + \frac{3}{16} \sum_{n=1}^{\infty} a_{n+1} z^n = 0.$$

Equating powers of  $z$ ,

$$z^0 : \quad a_0 = 0$$

$$z^n : \quad \left[ n(n-1) + \frac{3}{16} \right] a_n + \frac{3}{16} a_{n+1} = 0$$

$$a_{n+1} = \left[ \frac{16}{3} n(n-1) + 1 \right] a_n.$$

This difference equation has the solution  $a_n = 0$  for all  $n$ . Thus we have obtained only the trivial solution to the differential equation. We must try an expansion of a more general form. We recall that for regular singular points of first order equations we can always find a solution in the form of a Frobenius series  $w = z^\alpha \sum_{n=0}^{\infty} a_n z^n$ ,  $a_0 \neq 0$ . We substitute this series into the differential equation.

$$z^2 \sum_{n=0}^{\infty} [\alpha(\alpha-1) + 2\alpha n + n(n-1)] a_n z^{n+\alpha-2} + \frac{3}{16}(1+z) z^\alpha \sum_{n=0}^{\infty} a_n z^n = 0$$

$$\sum_{n=0}^{\infty} [\alpha(\alpha-1) + 2n + n(n-1)] a_n z^n + \frac{3}{16} \sum_{n=0}^{\infty} a_n z^n + \frac{3}{16} \sum_{n=1}^{\infty} a_{n-1} z^n = 0$$

Equating the  $z^0$  term to zero yields the equation

$$\left( \alpha(\alpha-1) + \frac{3}{16} \right) a_0 = 0.$$

Since we have assumed that  $a_0 \neq 0$ , the polynomial in  $\alpha$  must be zero. The two roots of the polynomial are

$$\alpha_1 = \frac{1 + \sqrt{1 - 3/4}}{2} = \frac{3}{4}, \quad \alpha_2 = \frac{1 - \sqrt{1 - 3/4}}{2} = \frac{1}{4}.$$

Thus our two series solutions will be of the form

$$w_1 = z^{3/4} \sum_{n=0}^{\infty} a_n z^n, \quad w_2 = z^{1/4} \sum_{n=0}^{\infty} b_n z^n.$$

Substituting the first series into the differential equation,

$$\sum_{n=0}^{\infty} \left[ -\frac{3}{16} + 2n + n(n-1) + \frac{3}{16} \right] a_n z^n + \frac{3}{16} \sum_{n=1}^{\infty} a_{n-1} z^n = 0.$$

Equating powers of  $z$ , we see that  $a_0$  is arbitrary and

$$a_n = -\frac{3}{16n(n+1)} a_{n-1} \quad \text{for } n \geq 1.$$

This difference equation has the solution

$$\begin{aligned} a_n &= a_0 \prod_{j=1}^n \left( -\frac{3}{16j(j+1)} \right) \\ &= a_0 \left( -\frac{3}{16} \right)^n \prod_{j=1}^n \frac{1}{j(j+1)} \\ &= a_0 \left( -\frac{3}{16} \right)^n \frac{1}{n!(n+1)!} \quad \text{for } n \geq 1. \end{aligned}$$

Substituting the second series into the differential equation,

$$\sum_{n=0}^{\infty} \left[ -\frac{3}{16} + 2n + n(n-1) + \frac{3}{16} \right] b_n z^n + \frac{3}{16} \sum_{n=1}^{\infty} b_{n-1} z^n = 0.$$



We see that the difference equation for  $b_n$  is the same as the equation for  $a_n$ . Thus we can write the general solution to the differential equation as

$$w = c_1 z^{3/4} \left( 1 + \sum_{n=1}^{\infty} \left( -\frac{3}{16} \right)^n \frac{1}{n!(n+1)!} z^n \right) + c_2 z^{1/4} \left( 1 + \sum_{n=1}^{\infty} \left( -\frac{3}{16} \right)^n \frac{1}{n!(n+1)!} z^n \right)$$

$$\boxed{(c_1 z^{3/4} + c_2 z^{1/4}) \left( 1 + \sum_{n=1}^{\infty} \left( -\frac{3}{16} \right)^n \frac{1}{n!(n+1)!} z^n \right)}.$$

### 23.2.1 Indicial Equation

Now let's consider the general equation for a regular singular point at  $z = 0$

$$w'' + \frac{p(z)}{z} w' + \frac{q(z)}{z^2} w = 0.$$

Since  $p(z)$  and  $q(z)$  are analytic at  $z = 0$  we can expand them in Taylor series.

$$p(z) = \sum_{n=0}^{\infty} p_n z^n, \quad q(z) = \sum_{n=0}^{\infty} q_n z^n$$

Substituting a Frobenius series  $w = z^\alpha \sum_{n=0}^{\infty} a_n z^n$ ,  $a_0 \neq 0$  and the Taylor series for  $p(z)$  and  $q(z)$  into the differential equation yields

$$\sum_{n=0}^{\infty} \left[ (\alpha + n)(\alpha + n - 1) \right] a_n z^n + \left( \sum_{n=0}^{\infty} p_n z^n \right) \left( \sum_{n=0}^{\infty} (\alpha + n) a_n z^n \right) + \left( \sum_{n=0}^{\infty} q_n z^n \right) \left( \sum_{n=0}^{\infty} a_n z^n \right) = 0$$

$$\begin{aligned} \sum_{n=0}^{\infty} \left[ (\alpha + n)^2 - (\alpha + n) + p_0(\alpha + n) + q_0 \right] a_n z^n \\ + \left( \sum_{n=1}^{\infty} p_n z^n \right) \left( \sum_{n=0}^{\infty} (\alpha + n) a_n z^n \right) + \left( \sum_{n=1}^{\infty} q_n z^n \right) \left( \sum_{n=0}^{\infty} a_n z^n \right) = 0 \end{aligned}$$

$$\sum_{n=0}^{\infty} \left[ (\alpha + n)^2 + (p_0 - 1)(\alpha_n) + q_0 \right] a_n z^n + \sum_{n=1}^{\infty} \left( \sum_{j=0}^{n-1} (\alpha + j) a_j p_{n-j} \right) z^n + \sum_{n=1}^{\infty} \left( \sum_{j=0}^{n-1} a_j q_{n-j} \right) z^n = 0$$

Equating powers of  $z$ ,

$$z^0 : \quad \left[ \alpha^2 + (p_0 - 1)\alpha + q_0 \right] a_0 = 0$$

$$z^n : \quad \left[ (\alpha + n)^2 + (p_0 - 1)(\alpha + n) + q_0 \right] a_n = - \sum_{j=0}^{n-1} \left[ (\alpha + j) p_{n-j} + q_{n-j} \right] a_j.$$

Let

$$I(\alpha) = \alpha^2 + (p_0 - 1)\alpha + q_0 = 0.$$

This is known as the **indicial equation**. The indicial equation gives us the form of the solutions. The equation for  $a_0$  is  $I(\alpha)a_0 = 0$ . Since we assumed that  $a_0$  is nonzero,  $I(\alpha) = 0$ . Let the two roots of  $I(\alpha)$  be  $\alpha_1$  and  $\alpha_2$  where  $\Re(\alpha_1) \geq \Re(\alpha_2)$ .

Rewriting the difference equation for  $a_n(\alpha)$ ,

$$I(\alpha + n)a_n(\alpha) = - \sum_{j=0}^{n-1} \left[ (\alpha + j) p_{n-j} + q_{n-j} \right] a_j(\alpha) \quad \text{for } n \geq 1. \quad (23.1)$$

If the roots are distinct and do not differ by an integer then we can use Equation 23.1 to solve for  $a_n(\alpha_1)$  and  $a_n(\alpha_2)$ , which will give us the two solutions

$$w_1 = z^{\alpha_1} \sum_{n=0}^{\infty} a_n(\alpha_1) z^n, \quad \text{and} \quad w_2 = z^{\alpha_2} \sum_{n=0}^{\infty} a_n(\alpha_2) z^n.$$

If the roots are not distinct,  $\alpha_1 = \alpha_2$ , we will only have one solution and will have to generate another. If the roots differ by an integer,  $\alpha_1 - \alpha_2 = N$ , there is one solution corresponding to  $\alpha_1$ , but when we try to solve Equation 23.1 for  $a_n(\alpha_2)$ , we will encounter the equation

$$I(\alpha_2 + N)a_N(\alpha_2) = I(\alpha_1)a_N(\alpha_2) = 0 \cdot a_N(\alpha_2) = - \sum_{j=0}^{N-1} \left[ (\alpha + n) p_{n-j} + q_{n-j} \right] a_j(\alpha_2).$$

If the right side of the equation is nonzero, then  $a_N(\alpha_2)$  is undefined. On the other hand, if the right side is zero then  $a_N(\alpha_2)$  is arbitrary. The rest of this section is devoted to considering the cases  $\alpha_1 = \alpha_2$  and  $\alpha_1 - \alpha_2 = N$ .

### 23.2.2 The Case: Double Root

Consider a second order equation  $L[w] = 0$  with a regular singular point at  $z = 0$ . Suppose the indicial equation has a double root.

$$I(\alpha) = (\alpha - \alpha_1)^2 = 0$$

One solution has the form

$$w_1 = z^{\alpha_1} \sum_{n=0}^{\infty} a_n z^n.$$

In order to find the second solution, we will differentiate with respect to the parameter,  $\alpha$ . Let  $a_n(\alpha)$  satisfy Equation 23.1 Substituting the Frobenius expansion into the differential equation,

$$L \left[ z^\alpha \sum_{n=0}^{\infty} a_n(\alpha) z^n \right] = 0.$$

Setting  $\alpha = \alpha_1$  will make the left hand side of the equation zero. Differentiating this equation with respect to  $\alpha$ ,

$$\frac{\partial}{\partial \alpha} L \left[ z^\alpha \sum_{n=0}^{\infty} a_n(\alpha) z^n \right] = 0.$$

Interchanging the order of differentiation,

$$L \left[ \log z z^\alpha \sum_{n=0}^{\infty} a_n(\alpha) z^n + z^\alpha \sum_{n=0}^{\infty} \frac{da_n(\alpha)}{d\alpha} z^n \right] = 0.$$

Since setting  $\alpha = \alpha_1$  will make the left hand side of this equation zero, the second linearly independent solution is

$$w_2 = \log z z^{\alpha_1} \sum_{n=0}^{\infty} a_n(\alpha_1) z^n + z^{\alpha_1} \sum_{n=0}^{\infty} \frac{da_n(\alpha)}{d\alpha} \Big|_{\alpha=\alpha_1} z^n$$

$$w_2 = w_1 \log z + z^{\alpha_1} \sum_{n=0}^{\infty} a'_n(\alpha_1) z^n.$$

**Example 23.2.2** Consider the differential equation

$$w'' + \frac{1+z}{4z^2}w = 0.$$

There is a regular singular point at  $z = 0$ . The indicial equation is

$$\alpha(\alpha - 1) + \frac{1}{4} = \left(\alpha - \frac{1}{2}\right)^2 = 0.$$

One solution will have the form

$$w_1 = z^{1/2} \sum_{n=0}^{\infty} a_n z^n, \quad a_0 \neq 0.$$

Substituting the Frobenius expansion

$$z^\alpha \sum_{n=0}^{\infty} a_n(\alpha) z^n$$

into the differential equation yields

$$z^2 w'' + \frac{1}{4}(1+z)w = 0$$

$$\sum_{n=0}^{\infty} [\alpha(\alpha - 1) + 2\alpha n + n(n - 1)] a_n(\alpha) z^{n+\alpha} + \frac{1}{4} \sum_{n=0}^{\infty} a_n(\alpha) z^{n+\alpha} + \frac{1}{4} \sum_{n=0}^{\infty} a_n(\alpha) z^{n+\alpha+1} = 0.$$

Divide by  $z^\alpha$  and adjust the summation indices.

$$\sum_{n=0}^{\infty} [\alpha(\alpha - 1) + 2\alpha n + n(n - 1)] a_n(\alpha) z^n + \frac{1}{4} \sum_{n=0}^{\infty} a_n(\alpha) z^n + \frac{1}{4} \sum_{n=1}^{\infty} a_{n-1}(\alpha) z^n = 0$$

$$\left[ \alpha(\alpha - 1)a_0 + \frac{1}{4} \right] a_0 + \sum_{n=1}^{\infty} \left( \left[ \alpha(\alpha - 1) + 2n + n(n - 1) + \frac{1}{4} \right] a_n(\alpha) + \frac{1}{4} a_{n-1}(\alpha) \right) z^n = 0$$

Equating the coefficient of  $z^0$  to zero yields  $I(\alpha)a_0 = 0$ . Equating the coefficients of  $z^n$  to zero yields the difference equation

$$\left[ \alpha(\alpha - 1) + 2n + n(n - 1) + \frac{1}{4} \right] a_n(\alpha) + \frac{1}{4} a_{n-1}(\alpha) = 0$$

$$a_n(\alpha) = - \left( \frac{n(n + 1)}{4} + \frac{\alpha(\alpha - 1)}{4} + \frac{1}{16} \right) a_{n-1}(\alpha).$$

The first few  $a_n$ 's are

$$a_0, \quad - \left( \alpha(\alpha - 1) + \frac{9}{16} \right) a_0, \quad \left( \alpha(\alpha - 1) + \frac{25}{16} \right) \left( \alpha(\alpha - 1) + \frac{9}{16} \right) a_0, \dots$$

Setting  $\alpha = 1/2$ , the coefficients for the first solution are

$$a_0, \quad -\frac{5}{16}a_0, \quad \frac{105}{16}a_0, \quad \dots$$

The second solution has the form

$$w_2 = w_1 \log z + z^{1/2} \sum_{n=0}^{\infty} a'_n(1/2) z^n.$$

Differentiating the  $a_n(\alpha)$ ,

$$\frac{da_0}{d\alpha} = 0, \quad \frac{da_1(\alpha)}{d\alpha} = -(2\alpha - 1)a_0, \quad \frac{da_2(\alpha)}{d\alpha} = (2\alpha - 1) \left[ \left( \alpha(\alpha - 1) + \frac{9}{16} \right) + \left( \alpha(\alpha - 1) + \frac{25}{16} \right) \right] a_0, \quad \dots$$

Setting  $\alpha = 1/2$  in this equation yields

$$a'_0 = 0, \quad a'_1(1/2) = 0, \quad a'_2(1/2) = 0, \quad \dots$$

Thus the second solution is

$$w_2 = w_1 \log z.$$

The first few terms in the general solution are

$$\boxed{(c_1 + c_2 \log z) \left( 1 - \frac{5}{16}z + \frac{105}{16}z^2 - \dots \right)}.$$

### 23.2.3 The Case: Roots Differ by an Integer

Consider the case in which the roots of the indicial equation  $\alpha_1$  and  $\alpha_2$  differ by an integer. ( $\alpha_1 - \alpha_2 = N$ ) Recall the equation that determines  $a_n(\alpha)$

$$I(\alpha + n)a_n = \left[ (\alpha + n)^2 + (p_0 - 1)(\alpha + n) + q_0 \right] a_n = - \sum_{j=0}^{n-1} \left[ (\alpha + j)p_{n-j} + q_{n-j} \right] a_j.$$

When  $\alpha = \alpha_2$  the equation for  $a_N$  is

$$I(\alpha_2 + N)a_N(\alpha_2) = 0 \cdot a_N(\alpha_2) = - \sum_{j=0}^{N-1} \left[ (\alpha_2 + j)p_{N-j} + q_{N-j} \right] a_j.$$

If the right hand side of this equation is zero, then  $a_N$  is arbitrary. There will be two solutions of the Frobenius form.

$$w_1 = z^{\alpha_1} \sum_{n=0}^{\infty} a_n(\alpha_1) z^n \quad \text{and} \quad w_2 = z^{\alpha_2} \sum_{n=0}^{\infty} a_n(\alpha_2) z^n.$$

If the right hand side of the equation is nonzero then  $a_N(\alpha_2)$  will be undefined. We will have to generate the second solution. Let

$$w(z, \alpha) = z^\alpha \sum_{n=0}^{\infty} a_n(\alpha) z^n,$$

where  $a_n(\alpha)$  satisfies the recurrence formula. Substituting this series into the differential equation yields

$$L[w(z, \alpha)] = 0.$$

We will multiply by  $(\alpha - \alpha_2)$ , differentiate this equation with respect to  $\alpha$  and then set  $\alpha = \alpha_2$ . This will generate a linearly independent solution.

$$\begin{aligned} \frac{\partial}{\partial \alpha} L[(\alpha - \alpha_2)w(z, \alpha)] &= L \left[ \frac{\partial}{\partial \alpha} (\alpha - \alpha_2)w(z, \alpha) \right] \\ &= L \left[ \frac{\partial}{\partial \alpha} (\alpha - \alpha_2) z^\alpha \sum_{n=0}^{\infty} a_n(\alpha) z^n \right] \\ &= L \left[ \log z z^\alpha \sum_{n=0}^{\infty} (\alpha - \alpha_2) a_n(\alpha) z^n + z^\alpha \sum_{n=0}^{\infty} \frac{d}{d\alpha} [(\alpha - \alpha_2) a_n(\alpha)] z^n \right] \end{aligned}$$

Setting  $\alpha = \alpha_2$  will make this expression zero, thus

$$\log z z^{\alpha_2} \sum_{n=0}^{\infty} \lim_{\alpha \rightarrow \alpha_2} \{(\alpha - \alpha_2) a_n(\alpha)\} z^n + z^{\alpha_2} \sum_{n=0}^{\infty} \lim_{\alpha \rightarrow \alpha_2} \left\{ \frac{d}{d\alpha} [(\alpha - \alpha_2) a_n(\alpha)] \right\} z^n$$

is a solution. Now let's look at the first term in this solution

$$\log z z^{\alpha_2} \sum_{n=0}^{\infty} \lim_{\alpha \rightarrow \alpha_2} \{(\alpha - \alpha_2) a_n(\alpha)\} z^n.$$

The first  $N$  terms in the sum will be zero. That is because  $a_0, \dots, a_{N-1}$  are finite, so multiplying by  $(\alpha - \alpha_2)$  and taking the limit as  $\alpha \rightarrow \alpha_2$  will make the coefficients vanish. The equation for  $a_N(\alpha)$  is

$$I(\alpha + N)a_N(\alpha) = - \sum_{j=0}^{N-1} [(\alpha + j)p_{N-j} + q_{N-j}] a_j(\alpha).$$

Thus the coefficient of the  $N^{\text{th}}$  term is

$$\begin{aligned} \lim_{\alpha \rightarrow \alpha_2} (\alpha - \alpha_2) a_N(\alpha) &= - \lim_{\alpha \rightarrow \alpha_2} \left[ \frac{(\alpha - \alpha_2)}{I(\alpha + N)} \sum_{j=0}^{N-1} [(\alpha + j)p_{N-j} + q_{N-j}] a_j(\alpha) \right] \\ &= - \lim_{\alpha \rightarrow \alpha_2} \left[ \frac{(\alpha - \alpha_2)}{(\alpha + N - \alpha_1)(\alpha + N - \alpha_2)} \sum_{j=0}^{N-1} [(\alpha + j)p_{N-j} + q_{N-j}] a_j(\alpha) \right] \end{aligned}$$

Since  $\alpha_1 = \alpha_2 + N$ ,  $\lim_{\alpha \rightarrow \alpha_2} \frac{\alpha - \alpha_2}{\alpha + N - \alpha_1} = 1$ .

$$= - \frac{1}{(\alpha_1 - \alpha_2)} \sum_{j=0}^{N-1} [(\alpha_2 + j)p_{N-j} + q_{N-j}] a_j(\alpha_2).$$

Using this you can show that the first term in the solution can be written

$$d_{-1} \log z w_1,$$

where  $d_{-1}$  is a constant. Thus the second linearly independent solution is

$$w_2 = d_{-1} \log z w_1 + z^{\alpha_2} \sum_{n=0}^{\infty} d_n z^n,$$

where

$$d_{-1} = - \frac{1}{a_0} \frac{1}{(\alpha_1 - \alpha_2)} \sum_{j=0}^{N-1} [(\alpha_2 + j)p_{N-j} + q_{N-j}] a_j(\alpha_2)$$

and

$$d_n = \lim_{\alpha \rightarrow \alpha_2} \left\{ \frac{d}{d\alpha} [(\alpha - \alpha_2) a_n(\alpha)] \right\} \quad \text{for } n \geq 0.$$



**Example 23.2.3** Consider the differential equation

$$w'' + \left(1 - \frac{2}{z}\right)w' + \frac{2}{z^2}w = 0.$$

The point  $z = 0$  is a regular singular point. In order to find series expansions of the solutions, we first calculate the indicial equation. We can write the coefficient functions in the form

$$\frac{p(z)}{z} = \frac{1}{z}(-2 + z), \quad \text{and} \quad \frac{q(z)}{z^2} = \frac{1}{z^2}(2).$$

Thus the indicial equation is

$$\begin{aligned}\alpha^2 + (-2 - 1)\alpha + 2 &= 0 \\ (\alpha - 1)(\alpha - 2) &= 0.\end{aligned}$$

**The First Solution.** The first solution will have the Frobenius form

$$w_1 = z^2 \sum_{n=0}^{\infty} a_n(\alpha_1)z^n.$$

Substituting a Frobenius series into the differential equation,

$$\begin{aligned}z^2 w'' + (z^2 - 2z)w' + 2w &= 0 \\ \sum_{n=0}^{\infty} (n + \alpha)(n + \alpha - 1)z^{n+\alpha} + (z^2 - 2z) \sum_{n=0}^{\infty} (n + \alpha)z^{n+\alpha-1} + 2 \sum_{n=0}^{\infty} a_n z^n &= 0 \\ [\alpha^2 - 3\alpha + 2]a_0 + \sum_{n=1}^{\infty} \left[ (n + \alpha)(n + \alpha - 1)a_n + (n + \alpha - 1)a_{n-1} - 2(n + \alpha)a_n + 2a_n \right] z^n &= 0.\end{aligned}$$

Equating powers of  $z$ ,

$$\begin{aligned}\left[ (n + \alpha)(n + \alpha - 1) - 2(n + \alpha) + 2 \right] a_n &= -(n + \alpha - 1)a_{n-1} \\ a_n &= -\frac{a_{n-1}}{n + \alpha - 2}.\end{aligned}$$

Setting  $\alpha = \alpha_1 = 2$ , the recurrence relation becomes

$$\begin{aligned} a_n(\alpha_1) &= -\frac{a_{n-1}(\alpha_1)}{n} \\ &= a_0 \frac{(-1)^n}{n!}. \end{aligned}$$

The first solution is

$$w_1 = a_0 \sum_{n=0}^{\infty} \frac{(-1)^n}{n!} z^n = a_0 e^{-z}.$$

**The Second Solution.** The equation for  $a_1(\alpha_2)$  is

$$0 \cdot a_1(\alpha_2) = 2a_0.$$

Since the right hand side of this equation is not zero, the second solution will have the form

$$w_2 = d_{-1} \log z w_1 + z^{\alpha_2} \sum_{n=0}^{\infty} \lim_{\alpha \rightarrow \alpha_2} \left\{ \frac{d}{d\alpha} [(\alpha - \alpha_2) a_n(\alpha)] \right\} z^n$$

First we will calculate  $d_{-1}$  as we defined it previously.

$$d_{-1} = -\frac{1}{a_0} \frac{1}{2-1} a_0 = -1.$$

The expression for  $a_n(\alpha)$  is

$$a_n(\alpha) = \frac{(-1)^n a_0}{(\alpha + n - 2)(\alpha + n - 1) \cdots (\alpha - 1)}.$$

The first few  $a_n(\alpha)$  are

$$\begin{aligned}a_1(\alpha) &= -\frac{a_0}{\alpha - 1} \\a_2(\alpha) &= \frac{a_0}{\alpha(\alpha - 1)} \\a_3(\alpha) &= -\frac{a_0}{(\alpha + 1)\alpha(\alpha - 1)}.\end{aligned}$$

We would like to calculate

$$d_n = \lim_{\alpha \rightarrow 1} \left\{ \frac{d}{d\alpha} [(\alpha - 1)a_n(\alpha)] \right\}.$$

The first few  $d_n$  are

$$\begin{aligned}
 d_0 &= \lim_{\alpha \rightarrow 1} \left\{ \frac{d}{d\alpha} [(\alpha - 1)a_0] \right\} \\
 &= a_0 \\
 d_1 &= \lim_{\alpha \rightarrow 1} \left\{ \frac{d}{d\alpha} \left[ (\alpha - 1) \left( -\frac{a_0}{\alpha - 1} \right) \right] \right\} \\
 &= \lim_{\alpha \rightarrow 1} \left\{ \frac{d}{d\alpha} [-a_0] \right\} \\
 &= 0 \\
 d_2 &= \lim_{\alpha \rightarrow 1} \left\{ \frac{d}{d\alpha} \left[ (\alpha - 1) \left( \frac{a_0}{\alpha(\alpha - 1)} \right) \right] \right\} \\
 &= \lim_{\alpha \rightarrow 1} \left\{ \frac{d}{d\alpha} \left[ \frac{a_0}{\alpha} \right] \right\} \\
 &= -a_0 \\
 d_3 &= \lim_{\alpha \rightarrow 1} \left\{ \frac{d}{d\alpha} \left[ (\alpha - 1) \left( -\frac{a_0}{(\alpha + 1)\alpha(\alpha - 1)} \right) \right] \right\} \\
 &= \lim_{\alpha \rightarrow 1} \left\{ \frac{d}{d\alpha} \left[ -\frac{a_0}{(\alpha + 1)\alpha} \right] \right\} \\
 &= \frac{3}{4}a_0.
 \end{aligned}$$

It will take a little work to find the general expression for  $d_n$ . We will need the following relations.

$$\Gamma(n) = (n - 1)!, \quad \Gamma'(z) = \Gamma(z)\psi(z), \quad \psi(n) = -\gamma + \sum_{k=1}^{n-1} \frac{1}{k}.$$

See the chapter on the Gamma function for explanations of these equations.

$$\begin{aligned}
 d_n &= \lim_{\alpha \rightarrow 1} \left\{ \frac{d}{d\alpha} \left[ (\alpha - 1) \frac{(-1)^n a_0}{(\alpha + n - 2)(\alpha + n - 1) \cdots (\alpha - 1)} \right] \right\} \\
 &= \lim_{\alpha \rightarrow 1} \left\{ \frac{d}{d\alpha} \left[ \frac{(-1)^n a_0}{(\alpha + n - 2)(\alpha + n - 1) \cdots (\alpha)} \right] \right\} \\
 &= \lim_{\alpha \rightarrow 1} \left\{ \frac{d}{d\alpha} \left[ \frac{(-1)^n a_0 \Gamma(\alpha)}{\Gamma(\alpha + n - 1)} \right] \right\} \\
 &= (-1)^n a_0 \lim_{\alpha \rightarrow 1} \left\{ \frac{\Gamma(\alpha) \psi(\alpha)}{\Gamma(\alpha + n - 1)} - \frac{\Gamma(\alpha) \psi(\alpha + n - 1)}{\Gamma(\alpha + n - 1)} \right\} \\
 &= (-1)^n a_0 \lim_{\alpha \rightarrow 1} \left\{ \frac{\Gamma(\alpha) [\psi(\alpha) - \psi(\alpha + n - 1)]}{\Gamma(\alpha + n - 1)} \right\} \\
 &= (-1)^n a_0 \frac{\psi(1) - \psi(n)}{(n - 1)!} \\
 &= \frac{(-1)^{n+1} a_0}{(n - 1)!} \sum_{k=0}^{n-1} \frac{1}{k}
 \end{aligned}$$

Thus the second solution is

$$w_2 = -\log z w_1 + z \sum_{n=0}^{\infty} \left( \frac{(-1)^{n+1} a_0}{(n - 1)!} \sum_{k=0}^{n-1} \frac{1}{k} \right) z^n.$$

The general solution is

$$w = c_1 e^{-z} - c_2 \log z e^{-z} + c_2 z \sum_{n=0}^{\infty} \left( \frac{(-1)^{n+1}}{(n - 1)!} \sum_{k=0}^{n-1} \frac{1}{k} \right) z^n.$$

We see that even in problems that are chosen for their simplicity, the algebra involved in the Frobenius method can be pretty involved.

**Example 23.2.4** Consider a series expansion about the origin of the equation

$$w'' + \frac{1-z}{z}w' - \frac{1}{z^2}w = 0.$$

The indicial equation is

$$\alpha^2 - 1 = 0$$

$$\alpha = \pm 1.$$

Substituting a Frobenius series into the differential equation,

$$\begin{aligned} z^2 \sum_{n=0}^{\infty} (n+\alpha)(n+\alpha-1)a_n z^{n-2} + (z-z^2) \sum_{n=0}^{\infty} (n+\alpha)a_n z^{n-1} - \sum_{n=0}^{\infty} a_n z^n &= 0 \\ \sum_{n=0}^{\infty} (n+\alpha)(n+\alpha-1)a_n z^n + \sum_{n=1}^{\infty} (n+\alpha)a_n z^n - \sum_{n=1}^{\infty} (n+\alpha-1)a_{n-1} z^n - \sum_{n=0}^{\infty} a_n z^n &= 0 \\ \left[ \alpha(\alpha-1) + \alpha - 1 \right] a_0 + \sum_{n=1}^{\infty} \left[ (n+\alpha)(n+\alpha-1)a_n + (n+\alpha-1)a_n - (n+\alpha-1)a_{n-1} \right] z^n &= 0. \end{aligned}$$

Equating powers of  $z$  to zero,

$$a_n(\alpha) = \frac{a_{n-1}(\alpha)}{n+\alpha+1}.$$

We know that the first solution has the form

$$w_1 = z \sum_{n=0}^{\infty} a_n z^n.$$

Setting  $\alpha = 1$  in the recurrence formula,

$$a_n = \frac{a_{n-1}}{n+2} = \frac{2a_0}{(n+2)!}.$$

Thus the first solution is

$$\begin{aligned}w_1 &= z \sum_{n=0}^{\infty} \frac{2a_0}{(n+2)!} z^n \\&= 2a_0 \frac{1}{z} \sum_{n=0}^{\infty} \frac{z^{n+2}}{(n+2)!} \\&= \frac{2a_0}{z} \left( \sum_{n=0}^{\infty} \frac{z^n}{n!} - 1 - z \right) \\&= \frac{2a_0}{z} (e^z - 1 - z).\end{aligned}$$

Now to find the second solution. Setting  $\alpha = -1$  in the recurrence formula,

$$a_n = \frac{a_{n-1}}{n} = \frac{a_0}{n!}.$$

We see that in this case there is no trouble in defining  $a_2(\alpha_2)$ . The second solution is

$$w_2 = \frac{a_0}{z} \sum_{n=0}^{\infty} \frac{z^n}{n!} = \frac{a_0}{z} e^z.$$

Thus we see that the general solution is

$$w = \frac{c_1}{z} (e^z - 1 - z) + \frac{c_2}{z} e^z$$

$$w = \frac{d_1}{z} e^z + d_2 \left( 1 + \frac{1}{z} \right).$$

## 23.3 Irregular Singular Points

If a point  $z_0$  of a differential equation is not ordinary or regular singular, then it is an **irregular singular point**. At least one of the solutions at an irregular singular point will not be of the Frobenius form. We will examine how to obtain series expansions about an irregular singular point in the chapter on asymptotic expansions.

## 23.4 The Point at Infinity

If we want to determine the behavior of a function  $f(z)$  at infinity, we can make the transformation  $\zeta = 1/z$  and examine the point  $\zeta = 0$ .

**Example 23.4.1** Consider the behavior of  $f(z) = \sin z$  at infinity. This is the same as considering the point  $\zeta = 0$  of  $\sin(1/\zeta)$ , which has the series expansion

$$\sin\left(\frac{1}{\zeta}\right) = \sum_{n=0}^{\infty} \frac{(-1)^n}{(2n+1)! \zeta^{2n+1}}.$$

Thus we see that the point  $\zeta = 0$  is an essential singularity of  $\sin(1/\zeta)$ . Hence  $\sin z$  has an essential singularity at  $z = \infty$ .

**Example 23.4.2** Consider the behavior at infinity of  $z e^{1/z}$ . We make the transformation  $\zeta = 1/z$ .

$$\frac{1}{\zeta} e^{\zeta} = \frac{1}{\zeta} \sum_{n=0}^{\infty} \frac{\zeta^n}{n!}$$

Thus  $z e^{1/z}$  has a pole of order 1 at infinity.



In order to classify the point at infinity of a differential equation in  $w(z)$ , we apply the transformation  $\zeta = 1/z$ ,  $u(\zeta) = w(z)$ . We write the derivatives with respect to  $z$  in terms of  $\zeta$ .

$$z = \frac{1}{\zeta}$$

$$dz = -\frac{1}{\zeta^2}d\zeta$$

$$\frac{d}{dz} = -\zeta^2 \frac{d}{d\zeta}$$

$$\begin{aligned} \frac{d^2}{dz^2} &= -\zeta^2 \frac{d}{d\zeta} \left( -\zeta^2 \frac{d}{d\zeta} \right) \\ &= \zeta^4 \frac{d^2}{d\zeta^2} + 2\zeta^3 \frac{d}{d\zeta} \end{aligned}$$

Now we apply the transformation to the differential equation.

$$\begin{aligned} w'' + p(z)w' + q(z)w &= 0 \\ \zeta^4 u'' + 2\zeta^3 u' + p(1/\zeta)(-\zeta^2)u' + q(1/\zeta)u &= 0 \\ u'' + \left( \frac{2}{\zeta} - \frac{p(1/\zeta)}{\zeta^2} \right) u' + \frac{q(1/\zeta)}{\zeta^4} u &= 0 \end{aligned}$$

**Example 23.4.3** *Classify the singular points of the differential equation*

$$w'' + \frac{1}{z}w' + 2w = 0.$$

*There is a regular singular point at  $z = 0$ . To examine the point at infinity we make the transformation  $\zeta = 1/z$ ,  $u(\zeta) = w(z)$ .*

$$\begin{aligned} u'' + \left( \frac{2}{\zeta} - \frac{1}{\zeta} \right) u' + \frac{2}{\zeta^4} u &= 0 \\ u'' + \frac{1}{\zeta} u' + \frac{2}{\zeta^4} u &= 0 \end{aligned}$$

*Thus we see that the differential equation for  $w(z)$  has an irregular singular point at infinity.*

## 23.5 Exercises

### Exercise 23.1 (mathematica/ode/series/series.nb)

$f(x)$  satisfies the Hermite equation

$$\frac{d^2 f}{dx^2} - 2x \frac{df}{dx} + 2\lambda f = 0.$$

Construct two linearly independent solutions of the equation as Taylor series about  $x = 0$ . For what values of  $x$  do the series converge?

Show that for certain values of  $\lambda$ , called eigenvalues, one of the solutions is a polynomial, called an eigenfunction. Calculate the first four eigenfunctions  $H_0(x)$ ,  $H_1(x)$ ,  $H_2(x)$ ,  $H_3(x)$ , ordered by degree.

**Hint, Solution**

### Exercise 23.2

Consider the Legendre equation

$$(1 - x^2)y'' - 2xy' + \alpha(\alpha + 1)y = 0.$$

1. Find two linearly independent solutions in the form of power series about  $x = 0$ .
2. Compute the radius of convergence of the series. Explain why it is possible to predict the radius of convergence without actually deriving the series.
3. Show that if  $\alpha = 2n$ , with  $n$  an integer and  $n \geq 0$ , the series for one of the solutions reduces to an even polynomial of degree  $2n$ .
4. Show that if  $\alpha = 2n + 1$ , with  $n$  an integer and  $n \geq 0$ , the series for one of the solutions reduces to an odd polynomial of degree  $2n + 1$ .
5. Show that the first 4 polynomial solutions  $P_n(x)$  (known as *Legendre* polynomials) ordered by their degree and normalized so that  $P_n(1) = 1$  are

$$\begin{aligned} P_0 &= 1 & P_1 &= x \\ P_2 &= \frac{1}{2}(3x^2 - 1) & P_4 &= \frac{1}{2}(5x^3 - 3x) \end{aligned}$$

6. Show that the Legendre equation can also be written as

$$((1 - x^2)y')' = -\alpha(\alpha + 1)y.$$

Note that two Legendre polynomials  $P_n(x)$  and  $P_m(x)$  must satisfy this relation for  $\alpha = n$  and  $\alpha = m$  respectively. By multiplying the first relation by  $P_m(x)$  and the second by  $P_n(x)$  and integrating by parts show that Legendre polynomials satisfy the orthogonality relation

$$\int_{-1}^1 P_n(x)P_m(x) dx = 0 \text{ if } n \neq m.$$

If  $n = m$ , it can be shown that the value of the integral is  $2/(2n + 1)$ . Verify this for the first three polynomials (but you needn't prove it in general).

Hint, Solution

### Exercise 23.3

Find the forms of two linearly independent series expansions about the point  $z = 0$  for the differential equation

$$w'' + \frac{1}{\sin z}w' + \frac{1 - z}{z^2}w = 0,$$

such that the series are real-valued on the positive real axis. Do not calculate the coefficients in the expansions.

Hint, Solution

### Exercise 23.4

Classify the singular points of the equation

$$w'' + \frac{w'}{z - 1} + 2w = 0.$$

Hint, Solution

**Exercise 23.5**

Find the series expansions about  $z = 0$  for

$$w'' + \frac{5}{4z}w' + \frac{z-1}{8z^2}w = 0.$$

**Hint, Solution**

**Exercise 23.6**

Find the series expansions about  $z = 0$  of the fundamental solutions of

$$w'' + zw' + w = 0.$$

**Hint, Solution**

**Exercise 23.7**

Find the series expansions about  $z = 0$  of the two linearly independent solutions of

$$w'' + \frac{1}{2z}w' + \frac{1}{z}w = 0.$$

**Hint, Solution**

**Exercise 23.8**

Classify the singularity at infinity of the differential equation

$$w'' + \left( \frac{2}{z} + \frac{3}{z^2} \right) w' + \frac{1}{z^2} w = 0.$$

Find the forms of the series solutions of the differential equation about infinity that are real-valued when  $z$  is real-valued and positive. Do not calculate the coefficients in the expansions.

**Hint, Solution**

### Exercise 23.9

Consider the second order differential equation

$$x \frac{d^2 y}{dx^2} + (b - x) \frac{dy}{dx} - ay = 0,$$

where  $a, b$  are real constants.

1. Show that  $x = 0$  is a regular singular point. Determine the location of any additional singular points and classify them. Include the point at infinity.
2. Compute the indicial equation for the point  $x = 0$ .
3. By solving an appropriate recursion relation, show that one solution has the form

$$y_1(x) = 1 + \frac{ax}{b} + \frac{(a)_2 x^2}{(b)_2 2!} + \cdots + \frac{(a)_n x^n}{(b)_n n!} + \cdots$$

where the notation  $(a)_n$  is defined by

$$(a)_n = a(a+1)(a+2) \cdots (a+n-1), \quad (a)_0 = 1.$$

Assume throughout this problem that  $b \neq n$  where  $n$  is a non-negative integer.

4. Show that when  $a = -m$ , where  $m$  is a non-negative integer, that there are polynomial solutions to this equation. Compute the radius of convergence of the series above when  $a \neq -m$ . Verify that the result you get is in accord with the Frobenius theory.
5. Show that if  $b = n + 1$  where  $n = 0, 1, 2, \dots$ , then the second solution of this equation has logarithmic terms. Indicate the *form* of the second solution in this case. You need not compute any coefficients.

**Hint, Solution**

**Exercise 23.10**

Consider the equation

$$xy'' + 2xy' + 6e^x y = 0.$$

Find the first three non-zero terms in each of two linearly independent series solutions about  $x = 0$ .

[Hint](#), [Solution](#)

## 23.6 Hints

**Hint 23.1**

**Hint 23.2**

**Hint 23.3**

**Hint 23.4**

**Hint 23.5**

**Hint 23.6**

**Hint 23.7**

**Hint 23.8**

**Hint 23.9**

**Hint 23.10**



## 23.7 Solutions

### Solution 23.1

$f(x)$  is a Taylor series about  $x = 0$ .

$$\begin{aligned}f(x) &= \sum_{n=0}^{\infty} a_n x^n \\f'(x) &= \sum_{n=1}^{\infty} n a_n x^{n-1} \\&= \sum_{n=0}^{\infty} n a_n x^{n-1} \\f''(x) &= \sum_{n=2}^{\infty} n(n-1) a_n x^{n-2} \\&= \sum_{n=0}^{\infty} (n+2)(n+1) a_{n+2} x^n\end{aligned}$$

We substitute the Taylor series into the differential equation.

$$\begin{aligned}f''(x) - 2x f'(x) + 2\lambda f &= 0 \\ \sum_{n=0}^{\infty} (n+2)(n+1) a_{n+2} x^n - 2 \sum_{n=0}^{\infty} n a_n x^n + 2\lambda \sum_{n=0}^{\infty} a_n x^n &= 0\end{aligned}$$

Equating coefficients gives us a difference equation for  $a_n$ :

$$\begin{aligned}(n+2)(n+1) a_{n+2} - 2n a_n + 2\lambda a_n &= 0 \\ a_{n+2} &= 2 \frac{n - \lambda}{(n+1)(n+2)} a_n.\end{aligned}$$

The first two coefficients,  $a_0$  and  $a_1$  are arbitrary. The remaining coefficients are determined by the recurrence relation. We will find the fundamental set of solutions at  $x = 0$ . That is, for the first solution we choose  $a_0 = 1$  and  $a_1 = 0$ ; for the second solution we choose  $a_0 = 0$ ,  $a_1 = 1$ . The difference equation for  $y_1$  is

$$a_{n+2} = 2 \frac{n - \lambda}{(n + 1)(n + 2)} a_n, \quad a_0 = 1, \quad a_1 = 0,$$

which has the solution

$$a_{2n} = \frac{2^n \prod_{k=0}^n (2(n - k) - \lambda)}{(2n)!}, \quad a_{2n+1} = 0.$$

The difference equation for  $y_2$  is

$$a_{n+2} = 2 \frac{n - \lambda}{(n + 1)(n + 2)} a_n, \quad a_0 = 0, \quad a_1 = 1,$$

which has the solution

$$a_{2n} = 0, \quad a_{2n+1} = \frac{2^n \prod_{k=0}^{n-1} (2(n - k) - 1 - \lambda)}{(2n + 1)!}.$$

A set of linearly independent solutions, (in fact the fundamental set of solutions at  $x = 0$ ), is

$$y_1(x) = \sum_{n=0}^{\infty} \frac{2^n \prod_{k=0}^n (2(n - k) - \lambda)}{(2n)!} x^{2n}, \quad y_2(x) = \sum_{n=0}^{\infty} \frac{2^n \prod_{k=0}^{n-1} (2(n - k) - 1 - \lambda)}{(2n + 1)!} x^{2n+1}.$$

Since the coefficient functions in the differential equation do not have any singularities in the finite complex plane, the radius of convergence of the series is infinite.

If  $\lambda = n$  is a positive even integer, then the first solution,  $y_1$ , is a polynomial of order  $n$ . If  $\lambda = n$  is a positive odd integer, then the second solution,  $y_2$ , is a polynomial of order  $n$ . For  $\lambda = 0, 1, 2, 3$ , we have

$$H_0(x) = 1$$

$$H_1(x) = x$$

$$H_2(x) = 1 - 2x^2$$

$$H_3(x) = x - \frac{2}{3}x^3$$

### Solution 23.2

1. First we write the differential equation in the standard form.

$$(1 - x^2)y'' - 2xy' + \alpha(\alpha + 1)y = 0 \quad (23.2)$$

$$y'' - \frac{2x}{1 - x^2}y' + \frac{\alpha(\alpha + 1)}{1 - x^2}y = 0. \quad (23.3)$$

Since the coefficients of  $y'$  and  $y$  are analytic in a neighborhood of  $x = 0$ , We can find two Taylor series solutions about that point. We find the Taylor series for  $y$  and its derivatives.

$$\begin{aligned} y &= \sum_{n=0}^{\infty} a_n x^n \\ y' &= \sum_{n=1}^{\infty} n a_n x^{n-1} \\ y'' &= \sum_{n=2}^{\infty} (n-1)n a_n x^{n-2} \\ &= \sum_{n=0}^{\infty} (n+1)(n+2)a_{n+2}x^n \end{aligned}$$

Here we used index shifting to explicitly write the two forms that we will need for  $y''$ . Note that we can take the lower bound of summation to be  $n = 0$  for all above sums. The terms added by this operation are zero. We substitute the Taylor series into Equation 23.2.

$$\begin{aligned} \sum_{n=0}^{\infty} (n+1)(n+2)a_{n+2}x^n - \sum_{n=0}^{\infty} (n-1)n a_n x^n - 2 \sum_{n=0}^{\infty} n a_n x^n + \alpha(\alpha + 1) \sum_{n=0}^{\infty} a_n x^n &= 0 \\ \sum_{n=0}^{\infty} \left( (n+1)(n+2)a_{n+2} - ((n-1)n + 2n - \alpha(\alpha + 1))a_n \right) x^n &= 0 \end{aligned}$$

We equate coefficients of  $x^n$  to obtain a recurrence relation.

$$(n+1)(n+2)a_{n+2} = (n(n+1) - \alpha(\alpha+1))a_n$$

$$a_{n+2} = \frac{n(n+1) - \alpha(\alpha+1)}{(n+1)(n+2)}a_n, \quad n \geq 0$$

We can solve this difference equation to determine the  $a_n$ 's. ( $a_0$  and  $a_1$  are arbitrary.)

$$a_n = \begin{cases} \frac{a_0}{n!} \prod_{\substack{k=0 \\ \text{even } k}}^{n-2} (k(k+1) - \alpha(\alpha+1)), & \text{even } n, \\ \frac{a_1}{n!} \prod_{\substack{k=1 \\ \text{odd } k}}^{n-2} (k(k+1) - \alpha(\alpha+1)), & \text{odd } n \end{cases}$$

We will find the fundamental set of solutions at  $x = 0$ , that is the set  $\{y_1, y_2\}$  that satisfies

$$y_1(0) = 1 \quad y_1'(0) = 0$$

$$y_2(0) = 0 \quad y_2'(0) = 1.$$

For  $y_1$  we take  $a_0 = 1$  and  $a_1 = 0$ ; for  $y_2$  we take  $a_0 = 0$  and  $a_1 = 1$ . The rest of the coefficients are determined from the recurrence relation.

$$y_1 = \sum_{\substack{n=0 \\ \text{even } n}}^{\infty} \left( \frac{1}{n!} \prod_{\substack{k=0 \\ \text{even } k}}^{n-2} (k(k+1) - \alpha(\alpha+1)) \right) x^n$$

$$y_2 = \sum_{\substack{n=1 \\ \text{odd } n}}^{\infty} \left( \frac{1}{n!} \prod_{\substack{k=1 \\ \text{odd } k}}^{n-2} (k(k+1) - \alpha(\alpha+1)) \right) x^n$$

2. We determine the radius of convergence of the series solutions with the ratio test.

$$\lim_{n \rightarrow \infty} \left| \frac{a_{n+2} x^{n+2}}{a_n x^n} \right| < 1$$

$$\lim_{n \rightarrow \infty} \left| \frac{\frac{n(n+1) - \alpha(\alpha+1)}{(n+1)(n+2)} a_n x^{n+2}}{a_n x^n} \right| < 1$$

$$\lim_{n \rightarrow \infty} \left| \frac{n(n+1) - \alpha(\alpha+1)}{(n+1)(n+2)} \right| |x^2| < 1$$

$$|x^2| < 1$$

Thus we see that the radius of convergence of the series is 1. We knew that the radius of convergence would be at least one, because the nearest singularities of the coefficients of (23.3) occur at  $x = \pm 1$ , a distance of 1 from the origin. This implies that the solutions of the equation are analytic in the unit circle about  $x = 0$ . The radius of convergence of the Taylor series expansion of an analytic function is the distance to the nearest singularity.

3. If  $\alpha = 2n$  then  $a_{2n+2} = 0$  in our first solution. From the recurrence relation, we see that all subsequent coefficients are also zero. The solution becomes an even polynomial.

$$y_1 = \sum_{\substack{m=0 \\ \text{even } m}}^{2n} \left( \frac{1}{m!} \prod_{\substack{k=0 \\ \text{even } k}}^{m-2} (k(k+1) - \alpha(\alpha+1)) \right) x^m$$

4. If  $\alpha = 2n + 1$  then  $a_{2n+3} = 0$  in our second solution. From the recurrence relation, we see that all subsequent coefficients are also zero. The solution becomes an odd polynomial.

$$y_2 = \sum_{\substack{m=1 \\ \text{odd } m}}^{2n+1} \left( \frac{1}{m!} \prod_{\substack{k=1 \\ \text{odd } k}}^{m-2} (k(k+1) - \alpha(\alpha+1)) \right) x^m$$

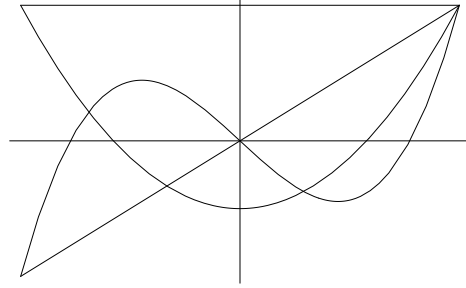

Figure 23.4: The First Four Legendre Polynomials

5. From our solutions above, the first four polynomials are

$$\begin{aligned}
 &1 \\
 &x \\
 &1 - 3x^2 \\
 &x - \frac{5}{3}x^3
 \end{aligned}$$

To obtain the Legendre polynomials we normalize these to have value unity at  $x = 1$

$$\begin{aligned}
 P_0 &= 1 \\
 P_1 &= x \\
 P_2 &= \frac{1}{2}(3x^2 - 1) \\
 P_3 &= \frac{1}{2}(5x^3 - 3x)
 \end{aligned}$$

These four Legendre polynomials are plotted in Figure 23.4.

6. We note that the first two terms in the Legendre equation form an exact derivative. Thus the Legendre equation can also be written as

$$((1 - x^2)y')' = -\alpha(\alpha + 1)y.$$

$P_n$  and  $P_m$  are solutions of the Legendre equation.

$$((1 - x^2)P_n')' = -n(n + 1)P_n, \quad ((1 - x^2)P_m')' = -m(m + 1)P_m \quad (23.4)$$

We multiply the first relation of Equation 23.4 by  $P_m$  and integrate by parts.

$$\begin{aligned} ((1 - x^2)P_n')' P_m &= -n(n + 1)P_n P_m \\ \int_{-1}^1 ((1 - x^2)P_n')' P_m dx &= -n(n + 1) \int_{-1}^1 P_n P_m dx \\ [((1 - x^2)P_n') P_m]_{-1}^1 - \int_{-1}^1 (1 - x^2)P_n' P_m' dx &= -n(n + 1) \int_{-1}^1 P_n P_m dx \\ \int_{-1}^1 (1 - x^2)P_n' P_m' dx &= n(n + 1) \int_{-1}^1 P_n P_m dx \end{aligned}$$

We multiply the second relation of Equation 23.4 by  $P_n$  and integrate by parts. To obtain a different expression for  $\int_{-1}^1 (1 - x^2)P_m' P_n' dx$ .

$$\int_{-1}^1 (1 - x^2)P_m' P_n' dx = m(m + 1) \int_{-1}^1 P_m P_n dx$$

We equate the two expressions for  $\int_{-1}^1 (1 - x^2)P_m' P_n' dx$ . to obtain an orthogonality relation.

$$(n(n + 1) - m(m + 1)) \int_{-1}^1 P_n P_m dx = 0$$

$$\boxed{\int_{-1}^1 P_n(x)P_m(x) dx = 0 \text{ if } n \neq m.}$$

We verify that for the first four polynomials the value of the integral is  $2/(2n + 1)$  for  $n = m$ .

$$\begin{aligned}\int_{-1}^1 P_0(x)P_0(x) dx &= \int_{-1}^1 1 dx = 2 \\ \int_{-1}^1 P_1(x)P_1(x) dx &= \int_{-1}^1 x^2 dx = \left[\frac{x^3}{3}\right]_{-1}^1 = \frac{2}{3} \\ \int_{-1}^1 P_2(x)P_2(x) dx &= \int_{-1}^1 \frac{1}{4}(9x^4 - 6x^2 + 1) dx = \left[\frac{1}{4}\left(\frac{9x^5}{5} - 2x^3 + x\right)\right]_{-1}^1 = \frac{2}{5} \\ \int_{-1}^1 P_3(x)P_3(x) dx &= \int_{-1}^1 \frac{1}{4}(25x^6 - 30x^4 + 9x^2) dx = \left[\frac{1}{4}\left(\frac{25x^7}{7} - 6x^5 + 3x^3\right)\right]_{-1}^1 = \frac{2}{7}\end{aligned}$$

### Solution 23.3

The indicial equation for this problem is

$$\alpha^2 + 1 = 0.$$

Since the two roots  $\alpha_1 = i$  and  $\alpha_2 = -i$  are distinct and do not differ by an integer, there are two solutions in the Frobenius form.

$$w_1 = z^i \sum_{n=0}^{\infty} a_n z^n, \quad w_2 = z^{-i} \sum_{n=0}^{\infty} b_n z^n$$

However, these series are not real-valued on the positive real axis. Recalling that

$$z^i = e^{i \log z} = \cos(\log z) + i \sin(\log z), \quad \text{and} \quad z^{-i} = e^{-i \log z} = \cos(\log z) - i \sin(\log z),$$

we can write a new set of solutions that are real-valued on the positive real axis as linear combinations of  $w_1$  and  $w_2$ .

$$u_1 = \frac{1}{2}(w_1 + w_2), \quad u_2 = \frac{1}{2i}(w_1 - w_2)$$

$$\boxed{u_1 = \cos(\log z) \sum_{n=0}^{\infty} c_n z^n, \quad u_2 = \sin(\log z) \sum_{n=0}^{\infty} d_n z^n}$$



**Solution 23.4**

Consider the equation  $w'' + w'/(z - 1) + 2w = 0$ .

We see that there is a regular singular point at  $z = 1$ . All other finite values of  $z$  are ordinary points of the equation. To examine the point at infinity we introduce the transformation  $z = 1/t$ ,  $w(z) = u(t)$ . Writing the derivatives with respect to  $z$  in terms of  $t$  yields

$$\frac{d}{dz} = -t^2 \frac{d}{dt}, \quad \frac{d^2}{dz^2} = t^4 \frac{d^2}{dt^2} + 2t^3 \frac{d}{dt}.$$

Substituting into the differential equation gives us

$$t^4 u'' + 2t^3 u' - \frac{t^2 u'}{1/t - 1} + 2u = 0$$

$$u'' + \left( \frac{2}{t} - \frac{1}{t(1-t)} \right) u' + \frac{2}{t^4} u = 0.$$

Since  $t = 0$  is an irregular singular point in the equation for  $u(t)$ ,  $z = \infty$  is an irregular singular point in the equation for  $w(z)$ .

**Solution 23.5**

Find the series expansions about  $z = 0$  for

$$w'' + \frac{5}{4z} w' + \frac{z-1}{8z^2} w = 0.$$

We see that  $z = 0$  is a regular singular point of the equation. The indicial equation is

$$\alpha^2 + \frac{1}{4}\alpha - \frac{1}{8} = 0$$

$$\left( \alpha + \frac{1}{2} \right) \left( \alpha - \frac{1}{4} \right) = 0.$$

Since the roots are distinct and do not differ by an integer, there will be two solutions in the Frobenius form.

$$w_1 = z^{1/4} \sum_{n=0}^{\infty} a_n(\alpha_1) z^n, \quad w_2 = z^{-1/2} \sum_{n=0}^{\infty} a_n(\alpha_2) z^n$$

We multiply the differential equation by  $8z^2$  to put it in a better form. Substituting a Frobenius series into the differential equation,

$$8z^2 \sum_{n=0}^{\infty} (n + \alpha)(n + \alpha - 1)a_n z^{n+\alpha-2} + 10z \sum_{n=0}^{\infty} (n + \alpha)a_n z^{n+\alpha-1} + (z - 1) \sum_{n=0}^{\infty} a_n z^{n+\alpha}$$

$$8 \sum_{n=0}^{\infty} (n + \alpha)(n + \alpha - 1)a_n z^n + 10 \sum_{n=0}^{\infty} (n + \alpha)a_n z^n + \sum_{n=1}^{\infty} a_{n-1} z^n - \sum_{n=0}^{\infty} a_n z^n.$$

Equating coefficients of powers of  $z$ ,

$$[8(n + \alpha)(n + \alpha - 1) + 10(n + \alpha) - 1] a_n = -a_{n-1}$$

$$a_n = -\frac{a_{n-1}}{8(n + \alpha)^2 + 2(n + \alpha) - 1}.$$

**The First Solution.** Setting  $\alpha = 1/4$  in the recurrence formula,

$$a_n(\alpha_1) = -\frac{a_{n-1}}{8(n + 1/4)^2 + 2(n + 1/4) - 1}$$

$$a_n(\alpha_1) = -\frac{a_{n-1}}{2n(4n + 3)}.$$

Thus the first solution is

$$w_1 = z^{1/4} \sum_{n=0}^{\infty} a_n(\alpha_1) z^n = a_0 z^{1/4} \left( 1 - \frac{1}{14} z + \frac{1}{616} z^2 + \dots \right).$$

**The Second Solution.** Setting  $\alpha = -1/2$  in the recurrence formula,

$$a_n = -\frac{a_{n-1}}{8(n - 1/2)^2 + 2(n - 1/2) - 1}$$

$$a_n = -\frac{a_{n-1}}{2n(4n - 3)}$$

Thus the second linearly independent solution is

$$w_2 = z^{-1/2} \sum_{n=0}^{\infty} a_n(\alpha_2) z^n = a_0 z^{-1/2} \left( 1 - \frac{1}{2}z + \frac{1}{40}z^2 + \dots \right).$$

### Solution 23.6

We consider the series solutions of,

$$w'' + zw' + w = 0.$$

We would like to find the expansions of the fundamental set of solutions about  $z = 0$ . Since  $z = 0$  is a regular point, (the coefficient functions are analytic there), we expand the solutions in Taylor series. Differentiating the series expansions for  $w(z)$ ,

$$\begin{aligned} w &= \sum_{n=0}^{\infty} a_n z^n \\ w' &= \sum_{n=1}^{\infty} n a_n z^{n-1} \\ w'' &= \sum_{n=2}^{\infty} n(n-1) a_n z^{n-2} \\ &= \sum_{n=0}^{\infty} (n+2)(n+1) a_{n+2} z^n \end{aligned}$$

We may take the lower limit of summation to be zero without changing the sums. Substituting these expressions into the differential equation,

$$\begin{aligned} \sum_{n=0}^{\infty} (n+2)(n+1) a_{n+2} z^n + \sum_{n=0}^{\infty} n a_n z^n + \sum_{n=0}^{\infty} a_n z^n &= 0 \\ \sum_{n=0}^{\infty} ((n+2)(n+1) a_{n+2} + (n+1) a_n) z^n &= 0. \end{aligned}$$

Equating the coefficient of the  $z^n$  term gives us

$$(n+2)(n+1)a_{n+2} + (n+1)a_n = 0, \quad n \geq 0$$

$$a_{n+2} = -\frac{a_n}{n+2}, \quad n \geq 0.$$

$a_0$  and  $a_1$  are arbitrary. We determine the rest of the coefficients from the recurrence relation. We consider the cases for even and odd  $n$  separately.

$$\begin{aligned} a_{2n} &= -\frac{a_{2n-2}}{2n} \\ &= \frac{a_{2n-4}}{(2n)(2n-2)} \\ &= (-1)^n \frac{a_0}{(2n)(2n-2) \cdots 4 \cdot 2} \\ &= (-1)^n \frac{a_0}{\prod_{m=1}^n 2m}, \quad n \geq 0 \end{aligned}$$

$$\begin{aligned} a_{2n+1} &= -\frac{a_{2n-1}}{2n+1} \\ &= \frac{a_{2n-3}}{(2n+1)(2n-1)} \\ &= (-1)^n \frac{a_1}{(2n+1)(2n-1) \cdots 5 \cdot 3} \\ &= (-1)^n \frac{a_1}{\prod_{m=1}^n (2m+1)}, \quad n \geq 0 \end{aligned}$$

If  $\{w_1, w_2\}$  is the fundamental set of solutions, then the initial conditions demand that  $w_1 = 1 + 0 \cdot z + \cdots$  and  $w_2 = 0 + z + \cdots$ . We see that  $w_1$  will have only even powers of  $z$  and  $w_2$  will have only odd powers of  $z$ .

$$w_1 = \sum_{n=0}^{\infty} \frac{(-1)^n}{\prod_{m=1}^n 2m} z^{2n}, \quad w_2 = \sum_{n=0}^{\infty} \frac{(-1)^n}{\prod_{m=1}^n (2m+1)} z^{2n+1}$$

Since the coefficient functions in the differential equation are entire, (analytic in the finite complex plane), the radius of convergence of these series solutions is infinite.

### Solution 23.7

$$w'' + \frac{1}{2z}w' + \frac{1}{z}w = 0.$$

We can find the indicial equation by substituting  $w = z^\alpha + \mathcal{O}(z^{\alpha+1})$  into the differential equation.

$$\alpha(\alpha - 1)z^{\alpha-2} + \frac{1}{2}\alpha z^{\alpha-2} + z^{\alpha-1} = \mathcal{O}(z^{\alpha-1})$$

Equating the coefficient of the  $z^{\alpha-2}$  term,

$$\begin{aligned}\alpha(\alpha - 1) + \frac{1}{2}\alpha &= 0 \\ \alpha &= 0, \frac{1}{2}.\end{aligned}$$

Since the roots are distinct and do not differ by an integer, the solutions are of the form

$$w_1 = \sum_{n=0}^{\infty} a_n z^n, \quad w_2 = z^{1/2} \sum_{n=0}^{\infty} b_n z^n.$$

Differentiating the series for the first solution,

$$\begin{aligned}
 w_1 &= \sum_{n=0}^{\infty} a_n z^n \\
 w_1' &= \sum_{n=1}^{\infty} n a_n z^{n-1} \\
 &= \sum_{n=0}^{\infty} (n+1) a_{n+1} z^n \\
 w_1'' &= \sum_{n=1}^{\infty} n(n+1) a_{n+1} z^{n-1}.
 \end{aligned}$$

Substituting this series into the differential equation,

$$\begin{aligned}
 \sum_{n=1}^{\infty} n(n+1) a_{n+1} z^{n-1} + \frac{1}{2z} \sum_{n=0}^{\infty} (n+1) a_{n+1} z^n + \frac{1}{z} \sum_{n=0}^{\infty} a_n z^n &= 0 \\
 \sum_{n=1}^{\infty} \left[ n(n+1) a_{n+1} + \frac{1}{2}(n+1) a_{n+1} + a_n \right] z^{n-1} + \frac{1}{2z} a_1 + \frac{1}{z} a_0 &= 0.
 \end{aligned}$$

Equating powers of  $z$ ,

$$\begin{aligned}
 z^{-1} : \frac{a_1}{2} + a_0 &= 0 & \rightarrow & a_1 = -2a_0 \\
 z^{n-1} : \left( n + \frac{1}{2} \right) (n+1) a_{n+1} + a_n &= 0 & \rightarrow & a_{n+1} = -\frac{a_n}{(n+1/2)(n+1)}.
 \end{aligned}$$

We can combine the above two equations for  $a_n$ .

$$a_{n+1} = -\frac{a_n}{(n+1/2)(n+1)}, \quad \text{for } n \geq 0$$

Solving this difference equation for  $a_n$ ,

$$a_n = a_0 \prod_{j=0}^{n-1} \frac{-1}{(j + 1/2)(j + 1)}$$

$$a_n = a_0 \frac{(-1)^n}{n!} \prod_{j=0}^{n-1} \frac{1}{j + 1/2}$$

Now let's find the second solution. Differentiating  $w_2$ ,

$$w_2' = \sum_{n=0}^{\infty} (n + 1/2) b_n z^{n-1/2}$$

$$w_2'' = \sum_{n=0}^{\infty} (n + 1/2)(n - 1/2) b_n z^{n-3/2}.$$

Substituting these expansions into the differential equation,

$$\sum_{n=0}^{\infty} (n + 1/2)(n - 1/2) b_n z^{n-3/2} + \frac{1}{2} \sum_{n=0}^{\infty} (n + 1/2) b_n z^{n-3/2} + \sum_{n=1}^{\infty} b_{n-1} z^{n-3/2} = 0.$$

Equating the coefficient of the  $z^{-3/2}$  term,

$$\frac{1}{2} \left( -\frac{1}{2} \right) b_0 + \frac{1}{2} \frac{1}{2} b_0 = 0,$$

we see that  $b_0$  is arbitrary. Equating the other coefficients of powers of  $z$ ,

$$(n + 1/2)(n - 1/2) b_n + \frac{1}{2}(n + 1/2) b_n + b_{n-1} = 0$$
$$b_n = -\frac{b_{n-1}}{n(n + 1/2)}$$

Calculating the  $b_n$ 's,

$$b_1 = -\frac{b_0}{1 \cdot \frac{3}{2}}$$

$$b_2 = \frac{b_0}{1 \cdot 2 \cdot \frac{3}{2} \cdot \frac{5}{2}}$$

$$b_n = \frac{(-1)^n 2^n b_0}{n! \cdot 3 \cdot 5 \cdots (2n + 1)}$$

Thus the second solution is

$$w_2 = b_0 z^{1/2} \sum_{n=0}^{\infty} \frac{(-1)^n 2^n z^n}{n! \cdot 3 \cdot 5 \cdots (2n + 1)}.$$

### Solution 23.8

$$w'' + \left( \frac{2}{z} + \frac{3}{z^2} \right) w' + \frac{1}{z^2} w = 0.$$

In order to analyze the behavior at infinity we make the change of variables  $t = 1/z$ ,  $u(t) = w(z)$  and examine the point  $t = 0$ . Writing the derivatives with respect to  $z$  in terms of  $t$  yields

$$z = \frac{1}{t}$$

$$dz = -\frac{1}{t^2} dt$$

$$\frac{d}{dz} = -t^2 \frac{d}{dt}$$

$$\begin{aligned} \frac{d^2}{dz^2} &= -t^2 \frac{d}{dt} \left( -t^2 \frac{d}{dt} \right) \\ &= t^4 \frac{d^2}{dt^2} + 2t^3 \frac{d}{dt}. \end{aligned}$$



The equation for  $u$  is then

$$t^4 u'' + 2t^3 u' + (2t + 3t^2)(-t^2)u' + t^2 u = 0$$

$$u'' + -3u' + \frac{1}{t^2}u = 0$$

We see that  $t = 0$  is a regular singular point. To find the indicial equation, we substitute  $u = t^\alpha + \mathcal{O}(t^{\alpha+1})$  into the differential equation.

$$\alpha(\alpha - 1)t^{\alpha-2} - 3\alpha t^{\alpha-1} + t^{\alpha-2} = \mathcal{O}(t^{\alpha-1})$$

Equating the coefficients of the  $t^{\alpha-2}$  terms,

$$\alpha(\alpha - 1) + 1 = 0$$

$$\alpha = \frac{1 \pm i\sqrt{3}}{2}$$

Since the roots of the indicial equation are distinct and do not differ by an integer, a set of solutions has the form

$$\left\{ t^{(1+i\sqrt{3})/2} \sum_{n=0}^{\infty} a_n t^n, \quad t^{(1-i\sqrt{3})/2} \sum_{n=0}^{\infty} b_n t^n \right\}.$$

Noting that

$$t^{(1+i\sqrt{3})/2} = t^{1/2} \exp\left(\frac{i\sqrt{3}}{2} \log t\right), \quad \text{and} \quad t^{(1-i\sqrt{3})/2} = t^{1/2} \exp\left(-\frac{i\sqrt{3}}{2} \log t\right).$$

We can take the sum and difference of the above solutions to obtain the form

$$u_1 = t^{1/2} \cos\left(\frac{\sqrt{3}}{2} \log t\right) \sum_{n=0}^{\infty} a_n t^n, \quad u_2 = t^{1/2} \sin\left(\frac{\sqrt{3}}{2} \log t\right) \sum_{n=0}^{\infty} b_n t^n.$$

Putting the answer in terms of  $z$ , we have the form of the two Frobenius expansions about infinity.

$$w_1 = z^{-1/2} \cos\left(\frac{\sqrt{3}}{2} \log z\right) \sum_{n=0}^{\infty} \frac{a_n}{z^n}, \quad w_2 = z^{-1/2} \sin\left(\frac{\sqrt{3}}{2} \log z\right) \sum_{n=0}^{\infty} \frac{b_n}{z^n}.$$

### Solution 23.9

1. We write the equation in the standard form.

$$y'' + \frac{b-x}{x}y' - \frac{a}{x}y = 0$$

Since  $\frac{b-x}{x}$  has no worse than a first order pole and  $\frac{a}{x}$  has no worse than a second order pole at  $x = 0$ , that is a regular singular point. Since the coefficient functions have no other singularities in the finite complex plane, all the other points in the finite complex plane are regular points.

Now to examine the point at infinity. We make the change of variables  $u(\xi) = y(x)$ ,  $\xi = 1/x$ .

$$y' = \frac{d\xi}{dx} \frac{d}{d\xi} u = -\frac{1}{x^2} u' = -\xi^2 u'$$

$$y'' = -\xi^2 \frac{d}{d\xi} \left( -\xi^2 \frac{d}{d\xi} \right) u = \xi^4 u'' + 2\xi^3 u'$$

The differential equation becomes

$$xy'' + (b-x)y' - ay$$

$$\frac{1}{\xi} (\xi^4 u'' + 2\xi^3 u') + \left( b - \frac{1}{\xi} \right) (-\xi^2 u') - au = 0$$

$$\xi^3 u'' + ((2-b)\xi^2 + \xi) u' - au = 0$$

$$u'' + \left( \frac{2-b}{\xi} + \frac{1}{\xi^2} \right) u' - \frac{a}{\xi^3} u = 0$$

Since this equation has an irregular singular point at  $\xi = 0$ , the equation for  $y(x)$  has an irregular singular point at infinity.

2. The coefficient functions are

$$p(x) \equiv \frac{1}{x} \sum_{n=1}^{\infty} p_n x^n = \frac{1}{x}(b - x),$$
$$q(x) \equiv \frac{1}{x^2} \sum_{n=1}^{\infty} q_n x^n = \frac{1}{x^2}(0 - ax).$$

The indicial equation is

$$\alpha^2 + (p_0 - 1)\alpha + q_0 = 0$$

$$\alpha^2 + (b - 1)\alpha + 0 = 0$$

$$\boxed{\alpha(\alpha + b - 1) = 0.}$$

3. Since one of the roots of the indicial equation is zero, and the other root is not a negative integer, one of the

solutions of the differential equation is a Taylor series.

$$\begin{aligned}
 y_1 &= \sum_{k=0}^{\infty} c_k x^k \\
 y_1' &= \sum_{k=1}^{\infty} k c_k x^{k-1} \\
 &= \sum_{k=0}^{\infty} (k+1) c_{k+1} x^k \\
 &= \sum_{k=0}^{\infty} k c_k x^{k-1} \\
 y_1'' &= \sum_{k=2}^{\infty} k(k-1) c_k x^{k-2} \\
 &= \sum_{k=1}^{\infty} (k+1) k c_{k+1} x^{k-1} \\
 &= \sum_{k=0}^{\infty} (k+1) k c_{k+1} x^{k-1}
 \end{aligned}$$

We substitute the Taylor series into the differential equation.

$$\begin{aligned}
 &xy'' + (b-x)y' - ay = 0 \\
 &\sum_{k=0}^{\infty} (k+1) k c_{k+1} x^k + b \sum_{k=0}^{\infty} (k+1) c_{k+1} x^k - \sum_{k=0}^{\infty} k c_k x^k - a \sum_{k=0}^{\infty} c_k x^k = 0
 \end{aligned}$$

We equate coefficients to determine a recurrence relation for the coefficients.

$$\begin{aligned}
 (k+1) k c_{k+1} + b(k+1) c_{k+1} - k c_k - a c_k &= 0 \\
 c_{k+1} &= \frac{k+a}{(k+1)(k+b)} c_k
 \end{aligned}$$

For  $c_0 = 1$ , the recurrence relation has the solution

$$c_k = \frac{(a)_k x^k}{(b)_k k!}.$$

Thus one solution is

$$y_1(x) = \sum_{k=0}^{\infty} \frac{(a)_k}{(b)_k k!} x^k.$$

4. If  $a = -m$ , where  $m$  is a non-negative integer, then  $(a)_k = 0$  for  $k > m$ . This makes  $y_1$  a polynomial:

$$y_1(x) = \sum_{k=0}^m \frac{(a)_k}{(b)_k k!} x^k.$$

5. If  $b = n + 1$ , where  $n$  is a non-negative integer, the indicial equation is

$$\alpha(\alpha + n) = 0.$$

For the case  $n = 0$ , the indicial equation has a double root at zero. Thus the solutions have the form:

$$y_1(x) = \sum_{k=0}^m \frac{(a)_k}{(b)_k k!} x^k, \quad y_2(x) = y_1(x) \log x + \sum_{k=0}^{\infty} d_k x^k$$

For the case  $n > 0$  the roots of the indicial equation differ by an integer. The solutions have the form:

$$y_1(x) = \sum_{k=0}^m \frac{(a)_k}{(b)_k k!} x^k, \quad y_2(x) = d_{-1} y_1(x) \log x + x^{-n} \sum_{k=0}^{\infty} d_k x^k$$

The form of the solution for  $y_2$  can be substituted into the equation to determine the coefficients  $d_k$ .

**Solution 23.10**

We write the equation in the standard form.

$$xy'' + 2xy' + 6e^x y = 0$$

$$y'' + 2y' + 6\frac{e^x}{x}y = 0$$

We see that  $x = 0$  is a regular singular point. The indicial equation is

$$\alpha^2 - \alpha = 0$$

$$\alpha = 0, 1.$$

The first solution has the Frobenius form.

$$y_1 = x + a_2x^2 + a_3x^3 + \mathcal{O}(x^4)$$

We substitute  $y_1$  into the differential equation and equate coefficients of powers of  $x$ .

$$xy'' + 2xy' + 6e^x y = 0$$

$$\begin{aligned} x(2a_2 + 6a_3x + \mathcal{O}(x^2)) + 2x(1 + 2a_2x + 3a_3x^2 + \mathcal{O}(x^3)) \\ + 6(1 + x + x^2/2 + \mathcal{O}(x^3))(x + a_2x^2 + a_3x^3 + \mathcal{O}(x^4)) = 0 \end{aligned}$$

$$(2a_2x + 6a_3x^2) + (2x + 4a_2x^2) + (6x + 6(1 + a_2)x^2) = \mathcal{O}(x^3) = 0$$

$$a_2 = -4, \quad a_3 = \frac{17}{3}$$

$$y_1 = x - 4x^2 + \frac{17}{3}x^3 + \mathcal{O}(x^4)$$

Now we see if the second solution has the Frobenius form. There is no  $a_1x$  term because  $y_2$  is only determined up to an additive constant times  $y_1$ .

$$y_2 = 1 + \mathcal{O}(x^2)$$

We substitute  $y_2$  into the differential equation and equate coefficients of powers of  $x$ .

$$\begin{aligned}xy'' + 2xy' + 6e^x y &= 0 \\ \mathcal{O}(x) + \mathcal{O}(x) + 6(1 + \mathcal{O}(x))(1 + \mathcal{O}(x^2)) &= 0 \\ 6 &= \mathcal{O}(x)\end{aligned}$$

The substitution  $y_2 = 1 + \mathcal{O}(x)$  has yielded a contradiction. Since the second solution is not of the Frobenius form, it has the following form:

$$y_2 = y_1 \ln(x) + a_0 + a_2 x^2 + \mathcal{O}(x^3)$$

The first three terms in the solution are

$$y_2 = a_0 + x \ln x - 4x^2 \ln x + \mathcal{O}(x^2).$$

We calculate the derivatives of  $y_2$ .

$$\begin{aligned}y_2' &= \ln(x) + \mathcal{O}(1) \\ y_2'' &= \frac{1}{x} + \mathcal{O}(\ln(x))\end{aligned}$$

We substitute  $y_2$  into the differential equation and equate coefficients.

$$\begin{aligned}xy'' + 2xy' + 6e^x y &= 0 \\ (1 + \mathcal{O}(x \ln x)) + 2(\mathcal{O}(x \ln x)) + 6(a_0 + \mathcal{O}(x \ln x)) &= 0 \\ 1 + 6a_0 &= 0\end{aligned}$$

$$y_2 = -\frac{1}{6} + x \ln x - 4x^2 \ln x + \mathcal{O}(x^2)$$

## 23.8 Quiz

### Problem 23.1

Write the definition of convergence of the series  $\sum_{n=1}^{\infty} a_n$ .

**Solution**

### Problem 23.2

What is the Cauchy convergence criterion for series?

**Solution**

### Problem 23.3

Define absolute convergence and uniform convergence. What is the relationship between the two?

**Solution**

### Problem 23.4

Write the geometric series and the function to which it converges. For what values of the variable does the series converge?

**Solution**

### Problem 23.5

For what real values of  $a$  does the series  $\sum_{n=1}^{\infty} n^a$  converge?

**Solution**

### Problem 23.6

State the ratio and root convergence tests.

**Solution**

### Problem 23.7

State the integral convergence test.

**Solution**



## 23.9 Quiz Solutions

### Solution 23.1

The series  $\sum_{n=1}^{\infty} a_n$  converges if the sequence of partial sums,  $S_N = \sum_{n=1}^N a_n$ , converges. That is,

$$\lim_{N \rightarrow \infty} S_N = \lim_{N \rightarrow \infty} \sum_{n=1}^N a_n = \text{constant}.$$

### Solution 23.2

A series converges if and only if for any  $\epsilon > 0$  there exists an  $N$  such that  $|S_n - S_m| < \epsilon$  for all  $n, m > N$ .

### Solution 23.3

The series  $\sum_{n=1}^{\infty} a_n$  converges absolutely if  $\sum_{n=1}^{\infty} |a_n|$  converges. If the rate of convergence of  $\sum_{n=1}^{\infty} a_n(z)$  is independent of  $z$  then the series is uniformly convergent. The series is uniformly convergent in a domain if for any given  $\epsilon > 0$  there exists an  $N$ , independent of  $z$ , such that

$$|f(z) - S_N(z)| = \left| f(z) - \sum_{n=1}^N a_n(z) \right| < \epsilon$$

for all  $z$  in the domain.

There is no relationship between absolute convergence and uniform convergence.

### Solution 23.4

$$\frac{1}{1-z} = \sum_{n=0}^{\infty} z^n \quad \text{for } |z| < 1.$$

### Solution 23.5

The series converges for  $a < -1$ .

**Solution 23.6**

The series  $\sum_{n=1}^{\infty} a_n$  converges absolutely if

$$\lim_{n \rightarrow \infty} \left| \frac{a_{n+1}}{a_n} \right| < 1.$$

If the limit is greater than unity, then the series diverges. If the limit is unity, the test fails.

The series  $\sum_{n=1}^{\infty} a_n$  converges absolutely if

$$\lim_{n \rightarrow \infty} |a_n|^{1/n} < 1.$$

If the limit is greater than unity, then the series diverges. If the limit is unity, the test fails.

**Solution 23.7**

If the coefficients  $a_n$  of a series  $\sum_{n=1}^{\infty} a_n$  are monotonically decreasing and can be extended to a monotonically decreasing function of the continuous variable  $x$ :

$$a(x) = a_n \quad \text{for integer } x,$$

then the sum converges or diverges with the integral:

$$\int_1^{\infty} a(x) \, dx.$$

# Chapter 24

## Asymptotic Expansions

The more you sweat in practice, the less you bleed in battle.

-Navy Seal Saying

### 24.1 Asymptotic Relations

The  $\ll$  and  $\sim$  symbols. First we will introduce two new symbols used in asymptotic relations.

$$f(x) \ll g(x) \quad \text{as } x \rightarrow x_0,$$

is read, “ $f(x)$  is much smaller than  $g(x)$  as  $x$  tends to  $x_0$ ”. This means

$$\lim_{x \rightarrow x_0} \frac{f(x)}{g(x)} = 0.$$

The notation

$$f(x) \sim g(x) \quad \text{as } x \rightarrow x_0,$$

is read “ $f(x)$  is asymptotic to  $g(x)$  as  $x$  tends to  $x_0$ ”; which means

$$\lim_{x \rightarrow x_0} \frac{f(x)}{g(x)} = 1.$$

A few simple examples are

- $-e^x \gg x$  as  $x \rightarrow +\infty$
- $\sin x \sim x$  as  $x \rightarrow 0$
- $1/x \ll 1$  as  $x \rightarrow +\infty$
- $e^{-1/x} \ll x^{-n}$  as  $x \rightarrow 0^+$  for all  $n$

An equivalent definition of  $f(x) \sim g(x)$  as  $x \rightarrow x_0$  is

$$f(x) - g(x) \ll g(x) \quad \text{as } x \rightarrow x_0.$$

Note that it does not make sense to say that a function  $f(x)$  is asymptotic to zero. Using the above definition this would imply

$$f(x) \ll 0 \quad \text{as } x \rightarrow x_0.$$

If you encounter an expression like  $f(x) + g(x) \sim 0$ , take this to mean  $f(x) \sim -g(x)$ .

**The Big  $\mathcal{O}$  and Little  $\mathcal{o}$  Notation.** If  $|f(x)| \leq m|g(x)|$  for some constant  $m$  in some neighborhood of the point  $x = x_0$ , then we say that

$$f(x) = \mathcal{O}(g(x)) \quad \text{as } x \rightarrow x_0.$$

We read this as “ $f$  is big  $\mathcal{O}$  of  $g$  as  $x$  goes to  $x_0$ ”. If  $g(x)$  does not vanish, an equivalent definition is that  $f(x)/g(x)$  is bounded as  $x \rightarrow x_0$ .

If for any given positive  $\delta$  there exists a neighborhood of  $x = x_0$  in which  $|f(x)| \leq \delta|g(x)|$  then

$$f(x) = \mathcal{o}(g(x)) \quad \text{as } x \rightarrow x_0.$$

This is read, “ $f$  is little  $\mathcal{o}$  of  $g$  as  $x$  goes to  $x_0$ .”

For a few examples of the use of this notation,

- $e^{-x} = o(x^{-n})$  as  $x \rightarrow \infty$  for any  $n$ .
- $\sin x = \mathcal{O}(x)$  as  $x \rightarrow 0$ .
- $\cos x - 1 = o(1)$  as  $x \rightarrow 0$ .
- $\log x = o(x^\alpha)$  as  $x \rightarrow +\infty$  for any positive  $\alpha$ .

**Operations on Asymptotic Relations.** You can perform the ordinary arithmetic operations on asymptotic relations. Addition, multiplication, and division are valid.

You can always integrate an asymptotic relation. Integration is a smoothing operation. However, it is necessary to exercise some care.

**Example 24.1.1** Consider

$$f'(x) \sim \frac{1}{x^2} \quad \text{as } x \rightarrow \infty.$$

*This does not imply that*

$$f(x) \sim \frac{-1}{x} \quad \text{as } x \rightarrow \infty.$$

*We have forgotten the constant of integration. Integrating the asymptotic relation for  $f'(x)$  yields*

$$f(x) \sim \frac{-1}{x} + c \quad \text{as } x \rightarrow \infty.$$

*If  $c$  is nonzero then*

$$f(x) \sim c \quad \text{as } x \rightarrow \infty.$$

It is not always valid to differentiate an asymptotic relation.

**Example 24.1.2** Consider  $f(x) = \frac{1}{x} + \frac{1}{x^2} \sin(x^3)$ .

$$f(x) \sim \frac{1}{x} \quad \text{as } x \rightarrow \infty.$$

Differentiating this relation yields

$$f'(x) \sim -\frac{1}{x^2} \quad \text{as } x \rightarrow \infty.$$

However, this is not true since

$$\begin{aligned} f'(x) &= -\frac{1}{x^2} - \frac{2}{x^3} \sin(x^3) + 2 \cos(x^3) \\ &\not\sim -\frac{1}{x^2} \quad \text{as } x \rightarrow \infty. \end{aligned}$$

**The Controlling Factor.** The controlling factor is the most rapidly varying factor in an asymptotic relation. Consider a function  $f(x)$  that is asymptotic to  $x^2 e^x$  as  $x$  goes to infinity. The controlling factor is  $e^x$ . For a few examples of this,

- $x \log x$  has the controlling factor  $x$  as  $x \rightarrow \infty$ .
- $x^{-2} e^{1/x}$  has the controlling factor  $e^{1/x}$  as  $x \rightarrow 0$ .
- $x^{-1} \sin x$  has the controlling factor  $\sin x$  as  $x \rightarrow \infty$ .

**The Leading Behavior.** Consider a function that is asymptotic to a sum of terms.

$$f(x) \sim a_0(x) + a_1(x) + a_2(x) + \cdots, \quad \text{as } x \rightarrow x_0.$$

where

$$a_0(x) \gg a_1(x) \gg a_2(x) \gg \cdots, \quad \text{as } x \rightarrow x_0.$$

The first term in the sum is the leading order behavior. For a few examples,

- For  $\sin x \sim x - x^3/6 + x^5/120 - \cdots$  as  $x \rightarrow 0$ , the leading order behavior is  $x$ .
- For  $f(x) \sim e^x(1 - 1/x + 1/x^2 - \cdots)$  as  $x \rightarrow \infty$ , the leading order behavior is  $e^x$ .

## 24.2 Leading Order Behavior of Differential Equations

It is often useful to know the leading order behavior of the solutions to a differential equation. If we are considering a regular point or a regular singular point, the approach is straight forward. We simply use a Taylor expansion or the Frobenius method. However, if we are considering an irregular singular point, we will have to be a little more creative. Instead of an all encompassing theory like the Frobenius method which always gives us the solution, we will use a heuristic approach that usually gives us the solution.

**Example 24.2.1** Consider the Airy equation

$$y'' = xy.$$

We<sup>1</sup> would like to know how the solutions of this equation behave as  $x \rightarrow +\infty$ . First we need to classify the point at infinity. The change of variables

$$x = \frac{1}{t}, \quad y(x) = u(t), \quad \frac{d}{dx} = -t^2 \frac{d}{dt}, \quad \frac{d^2}{dx^2} = t^4 \frac{d^2}{dt^2} + 2t^3 \frac{d}{dt}$$

yields

$$\begin{aligned} t^4 u'' + 2t^3 u' &= \frac{1}{t} u \\ u'' + \frac{2}{t} u' - \frac{1}{t^5} u &= 0. \end{aligned}$$

Since the equation for  $u$  has an irregular singular point at zero, the equation for  $y$  has an irregular singular point at infinity.

---

<sup>1</sup>Using "We" may be a bit presumptuous on my part. Even if you don't particularly want to know how the solutions behave, I urge you to just play along. This is an interesting section, I promise.

**The Controlling Factor.** *Since the solutions at irregular singular points often have exponential behavior, we make the substitution  $y = e^{s(x)}$  into the differential equation for  $y$ .*

$$\begin{aligned}\frac{d^2}{dx^2} [e^s] &= x e^s \\ [s'' + (s')^2] e^s &= x e^s \\ s'' + (s')^2 &= x\end{aligned}$$

**The Dominant Balance.** *Now we have a differential equation for  $s$  that appears harder to solve than our equation for  $y$ . However, we did not introduce the substitution in order to obtain an equation that we could solve exactly. We are looking for an equation that we can solve approximately in the limit as  $x \rightarrow \infty$ . If one of the terms in the equation for  $s$  is much smaller than the other two as  $x \rightarrow \infty$ , then dropping that term and solving the simpler equation may give us an approximate solution. If one of the terms in the equation for  $s$  is much smaller than the others then we say that the remaining terms form a **dominant balance** in the limit as  $x \rightarrow \infty$ .*

*Assume that the  $s''$  term is much smaller than the others,  $s'' \ll (s')^2, x$  as  $x \rightarrow \infty$ . This gives us*

$$\begin{aligned}(s')^2 &\sim x \\ s' &\sim \pm\sqrt{x} \\ s &\sim \pm\frac{2}{3}x^{3/2} \quad \text{as } x \rightarrow \infty.\end{aligned}$$

*Now let's check our assumption that the  $s''$  term is small. Assuming that we can differentiate the asymptotic relation  $s' \sim \pm\sqrt{x}$ , we obtain  $s'' \sim \pm\frac{1}{2}x^{-1/2}$  as  $x \rightarrow \infty$ .*

$$s'' \ll (s')^2, x \quad \rightarrow \quad x^{-1/2} \ll x \quad \text{as } x \rightarrow \infty$$

*Thus we see that the behavior we found for  $s$  is consistent with our assumption. The controlling factors for solutions to the Airy equation are  $\exp(\pm\frac{2}{3}x^{3/2})$  as  $x \rightarrow \infty$ .*



**The Leading Order Behavior of the Decaying Solution.** Let's find the leading order behavior as  $x$  goes to infinity of the solution with the controlling factor  $\exp(-\frac{2}{3}x^{3/2})$ . We substitute

$$s(x) = -\frac{2}{3}x^{3/2} + t(x), \quad \text{where } t(x) \ll x^{3/2} \text{ as } x \rightarrow \infty$$

into the differential equation for  $s$ .

$$\begin{aligned} s'' + (s')^2 &= x \\ -\frac{1}{2}x^{-1/2} + t'' + (-x^{1/2} + t')^2 &= x \\ t'' + (t')^2 - 2x^{1/2}t' - \frac{1}{2}x^{-1/2} &= 0 \end{aligned}$$

Assume that we can differentiate  $t \ll x^{3/2}$  to obtain

$$t' \ll x^{1/2}, \quad t'' \ll x^{-1/2} \quad \text{as } x \rightarrow \infty.$$

Since  $t'' \ll -\frac{1}{2}x^{-1/2}$  we drop the  $t''$  term. Also,  $t' \ll x^{1/2}$  implies that  $(t')^2 \ll -2x^{1/2}t'$ , so we drop the  $(t')^2$  term.

This gives us

$$\begin{aligned} -2x^{1/2}t' - \frac{1}{2}x^{-1/2} &\sim 0 \\ t' &\sim -\frac{1}{4}x^{-1} \\ t &\sim -\frac{1}{4}\log x + c \\ t &\sim -\frac{1}{4}\log x \quad \text{as } x \rightarrow \infty. \end{aligned}$$

Checking our assumptions about  $t$ ,

$$\begin{aligned} t' \ll x^{1/2} &\rightarrow x^{-1} \ll x^{1/2} \\ t'' \ll x^{-1/2} &\rightarrow x^{-2} \ll x^{-1/2} \end{aligned}$$

we see that the behavior of  $t$  is consistent with our assumptions.

So far we have

$$y(x) \sim \exp\left(-\frac{2}{3}x^{3/2} - \frac{1}{4}\log x + u(x)\right) \quad \text{as } x \rightarrow \infty,$$

where  $u(x) \ll \log x$  as  $x \rightarrow \infty$ . To continue, we substitute  $t(x) = -\frac{1}{4}\log x + u(x)$  into the differential equation for  $t(x)$ .

$$\begin{aligned} t'' + (t')^2 - 2x^{1/2}t' - \frac{1}{2}x^{-1/2} &= 0 \\ \frac{1}{4}x^{-2} + u'' + \left(-\frac{1}{4}x^{-1} + u'\right)^2 - 2x^{1/2}\left(-\frac{1}{4}x^{-1} + u'\right) - \frac{1}{2}x^{-1/2} &= 0 \\ u'' + (u')^2 + \left(-\frac{1}{2}x^{-1} - 2x^{1/2}\right)u' + \frac{5}{16}x^{-2} &= 0 \end{aligned}$$

Assume that we can differentiate the asymptotic relation for  $u$  to obtain

$$u' \ll x^{-1}, \quad u'' \ll x^{-2} \quad \text{as } x \rightarrow \infty.$$

We know that  $-\frac{1}{2}x^{-1}u' \ll -2x^{1/2}u'$ . Using our assumptions,

$$\begin{aligned} u'' \ll x^{-2} &\rightarrow u'' \ll \frac{5}{16}x^{-2} \\ u' \ll x^{-1} &\rightarrow (u')^2 \ll \frac{5}{16}x^{-2}. \end{aligned}$$

Thus we obtain

$$\begin{aligned} -2x^{1/2}u' + \frac{5}{16}x^{-2} &\sim 0 \\ u' &\sim \frac{5}{32}x^{-5/2} \\ u &\sim -\frac{5}{48}x^{-3/2} + c \\ u &\sim c \quad \text{as } x \rightarrow \infty. \end{aligned}$$

Since  $u = c + o(1)$ ,  $e^u = e^c + o(1)$ . The behavior of  $y$  is

$$y \sim x^{-1/4} \exp\left(-\frac{2}{3}x^{3/2}\right) (e^c + o(1)) \quad \text{as } x \rightarrow \infty.$$

Thus the full leading order behavior of the decaying solution is

$$y \sim (\text{const})x^{-1/4} \exp\left(-\frac{2}{3}x^{3/2}\right) \quad \text{as } x \rightarrow \infty.$$

You can show that the leading behavior of the exponentially growing solution is

$$y \sim (\text{const})x^{-1/4} \exp\left(\frac{2}{3}x^{3/2}\right) \quad \text{as } x \rightarrow \infty.$$

**Example 24.2.2 The Modified Bessel Equation.** Consider the modified Bessel equation

$$x^2y'' + xy' - (x^2 + \nu^2)y = 0.$$

We would like to know how the solutions of this equation behave as  $x \rightarrow +\infty$ . First we need to classify the point at infinity. The change of variables  $x = \frac{1}{t}$ ,  $y(x) = u(t)$  yields

$$\begin{aligned} \frac{1}{t^2}(t^4u'' + 2t^3u') + \frac{1}{t}(-t^2u') - \left(\frac{1}{t^2} + \nu^2\right)u &= 0 \\ u'' + \frac{1}{t}u' - \left(\frac{1}{t^4} + \frac{\nu^2}{t^2}\right)u &= 0 \end{aligned}$$

Since  $u(t)$  has an irregular singular point at  $t = 0$ ,  $y(x)$  has an irregular singular point at infinity.

**The Controlling Factor.** Since the solutions at irregular singular points often have exponential behavior, we make the substitution  $y = e^{s(x)}$  into the differential equation for  $y$ .

$$\begin{aligned} x^2(s'' + (s')^2)e^s + xs'e^s - (x^2 + \nu^2)e^s &= 0 \\ s'' + (s')^2 + \frac{1}{x}s' - \left(1 + \frac{\nu^2}{x^2}\right) &= 0 \end{aligned}$$

We make the assumption that  $s'' \ll (s')^2$  as  $x \rightarrow \infty$  and we know that  $v^2/x^2 \ll 1$  as  $x \rightarrow \infty$ . Thus we drop these two terms from the equation to obtain an approximate equation for  $s$ .

$$(s')^2 + \frac{1}{x}s' - 1 \sim 0$$

This is a quadratic equation for  $s'$ , so we can solve it exactly. However, let us try to simplify the equation even further. Assume that as  $x$  goes to infinity one of the three terms is much smaller than the other two. If this is the case, there will be a balance between the two dominant terms and we can neglect the third. Let's check the three possibilities.

1.

$$1 \text{ is small.} \quad \rightarrow \quad (s')^2 + \frac{1}{x}s' \sim 0 \quad \rightarrow \quad s' \sim -\frac{1}{x}, 0$$

$1 \ll \frac{1}{x^2}, 0$  as  $x \rightarrow \infty$  so this balance is inconsistent.

2.

$$\frac{1}{x}s' \text{ is small.} \quad \rightarrow \quad (s')^2 - 1 \sim 0 \quad \rightarrow \quad s' \sim \pm 1$$

This balance is consistent as  $\frac{1}{x} \ll 1$  as  $x \rightarrow \infty$ .

3.

$$(s')^2 \text{ is small.} \quad \rightarrow \quad \frac{1}{x}s' - 1 \sim 0 \quad \rightarrow \quad s' \sim x$$

This balance is not consistent as  $x^2 \ll 1$  as  $x \rightarrow \infty$ .

The only dominant balance that makes sense leads to  $s' \sim \pm 1$  as  $x \rightarrow \infty$ . Integrating this relationship,

$$\begin{aligned} s &\sim \pm x + c \\ &\sim \pm x \quad \text{as } x \rightarrow \infty. \end{aligned}$$

Now let's see if our assumption that we made to get the simplified equation for  $s$  is valid. Assuming that we can differentiate  $s' \sim \pm 1$ ,  $s'' \ll (s')^2$  becomes

$$\begin{aligned} \frac{d}{dx} [\pm 1 + o(1)] &\ll [\pm 1 + o(1)]^2 \\ 0 + o(1/x) &\ll 1 \end{aligned}$$

Thus we see that the behavior we obtained for  $s$  is consistent with our initial assumption.

We have found two controlling factors,  $e^x$  and  $e^{-x}$ . This is a good sign as we know that there must be two linearly independent solutions to the equation.

**Leading Order Behavior.** Now let's find the full leading behavior of the solution with the controlling factor  $e^{-x}$ . In order to find a better approximation for  $s$ , we substitute  $s(x) = -x + t(x)$ , where  $t(x) \ll x$  as  $x \rightarrow \infty$ , into the differential equation for  $s$ .

$$s'' + (s')^2 + \frac{1}{x}s' - \left(1 + \frac{\nu^2}{x^2}\right) = 0$$

$$t'' + (-1 + t')^2 + \frac{1}{x}(-1 + t') - \left(1 + \frac{\nu^2}{x^2}\right) = 0$$

$$t'' + (t')^2 + \left(\frac{1}{x} - 2\right)t' - \left(\frac{1}{x} + \frac{\nu^2}{x^2}\right) = 0$$

We know that  $\frac{1}{x} \ll 2$  and  $\frac{\nu^2}{x^2} \ll \frac{1}{x}$  as  $x \rightarrow \infty$ . Dropping these terms from the equation yields

$$t'' + (t')^2 - 2t' - \frac{1}{x} \sim 0.$$

Assuming that we can differentiate the asymptotic relation for  $t$ , we obtain  $t' \ll 1$  and  $t'' \ll \frac{1}{x}$  as  $x \rightarrow \infty$ . We can drop  $t''$ . Since  $t'$  vanishes as  $x$  goes to infinity,  $(t')^2 \ll t'$ . Thus we are left with

$$-2t' - \frac{1}{x} \sim 0, \quad \text{as } x \rightarrow \infty.$$

Integrating this relationship,

$$t \sim -\frac{1}{2} \log x + c$$

$$\sim -\frac{1}{2} \log x \quad \text{as } x \rightarrow \infty.$$

Checking our assumptions about the behavior of  $t$ ,

$$\begin{aligned} t' \ll 1 &\quad \rightarrow \quad -\frac{1}{2x} \ll 1 \\ t'' \ll \frac{1}{x} &\quad \rightarrow \quad \frac{1}{2x^2} \ll \frac{1}{x} \end{aligned}$$

we see that the solution is consistent with our assumptions.

The leading order behavior to the solution with controlling factor  $e^{-x}$  is

$$y(x) \sim \exp\left(-x - \frac{1}{2} \log x + u(x)\right) = x^{-1/2} e^{-x+u(x)} \quad \text{as } x \rightarrow \infty,$$

where  $u(x) \ll \log x$ . We substitute  $t = -\frac{1}{2} \log x + u(x)$  into the differential equation for  $t$  in order to find the asymptotic behavior of  $u$ .

$$\begin{aligned} t'' + (t')^2 + \left(\frac{1}{x} - 2\right)t' - \left(\frac{1}{x} + \frac{\nu^2}{x^2}\right) &= 0 \\ \frac{1}{2x^2} + u'' + \left(-\frac{1}{2x} + u'\right)^2 + \left(\frac{1}{x} - 2\right)\left(-\frac{1}{2x} + u'\right) - \left(\frac{1}{x} + \frac{\nu^2}{x^2}\right) &= 0 \\ u'' + (u')^2 - 2u' + \frac{1}{4x^2} - \frac{\nu^2}{x^2} &= 0 \end{aligned}$$

Assuming that we can differentiate the asymptotic relation for  $u$ ,  $u' \ll \frac{1}{x}$  and  $u'' \ll \frac{1}{x^2}$  as  $x \rightarrow \infty$ . Thus we see that we can neglect the  $u''$  and  $(u')^2$  terms.

$$\begin{aligned} -2u' + \left(\frac{1}{4} - \nu^2\right) \frac{1}{x^2} &\sim 0 \\ u' &\sim \frac{1}{2} \left(\frac{1}{4} - \nu^2\right) \frac{1}{x^2} \\ u &\sim \frac{1}{2} \left(\nu^2 - \frac{1}{4}\right) \frac{1}{x} + c \\ u &\sim c \quad \text{as } x \rightarrow \infty \end{aligned}$$

Since  $u = c + o(1)$ , we can expand  $e^u$  as  $e^c + o(1)$ . Thus we can write the leading order behavior as

$$y \sim x^{-1/2} e^{-x} (e^c + o(1)).$$

Thus the full leading order behavior is

$$y \sim (\text{const}) x^{-1/2} e^{-x} \quad \text{as } x \rightarrow \infty.$$

You can verify that the solution with the controlling factor  $e^x$  has the leading order behavior

$$y \sim (\text{const}) x^{-1/2} e^x \quad \text{as } x \rightarrow \infty.$$

Two linearly independent solutions to the modified Bessel equation are the modified Bessel functions,  $I_\nu(x)$  and  $K_\nu(x)$ . These functions have the asymptotic behavior

$$I_\nu(x) \sim \frac{1}{\sqrt{2\pi x}} e^x, \quad K_\nu(x) \sim \frac{\sqrt{\pi}}{\sqrt{2x}} e^{-x} \quad \text{as } x \rightarrow \infty.$$

In Figure 24.1  $K_0(x)$  is plotted in a solid line and  $\frac{\sqrt{\pi}}{\sqrt{2x}} e^{-x}$  is plotted in a dashed line. We see that the leading order behavior of the solution as  $x$  goes to infinity gives a good approximation to the behavior even for fairly small values of  $x$ .

## 24.3 Integration by Parts

**Example 24.3.1** *The complementary error function*

$$\text{erfc}(x) = \frac{2}{\sqrt{\pi}} \int_x^\infty e^{-t^2} dt$$

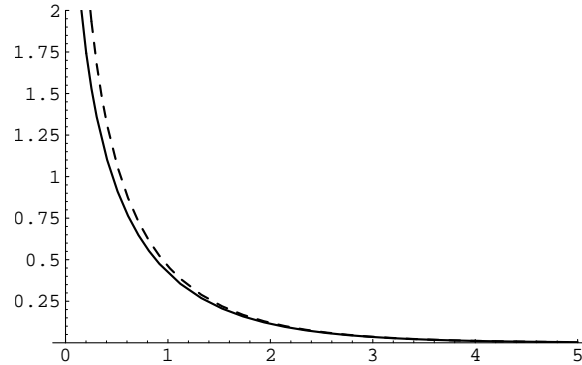

Figure 24.1: Plot of  $K_0(x)$  and it's leading order behavior.

is used in statistics for its relation to the normal probability distribution. We would like to find an approximation to  $\operatorname{erfc}(x)$  for large  $x$ . Using integration by parts,

$$\begin{aligned}
 \operatorname{erfc}(x) &= \frac{2}{\sqrt{\pi}} \int_x^\infty \left( \frac{-1}{2t} \right) \left( -2t e^{-t^2} \right) dt \\
 &= \frac{2}{\sqrt{\pi}} \left[ \frac{-1}{2t} e^{-t^2} \right]_x^\infty - \frac{2}{\sqrt{\pi}} \int_x^\infty \frac{1}{2} t^{-2} e^{-t^2} dt \\
 &= \frac{1}{\sqrt{\pi}} x^{-1} e^{-x^2} - \frac{1}{\sqrt{\pi}} \int_x^\infty t^{-2} e^{-t^2} dt.
 \end{aligned}$$



We examine the residual integral in this expression.

$$\begin{aligned} \frac{1}{\sqrt{\pi}} \int_x^\infty t^{-2} e^{-t^2} dt &\leq \frac{-1}{2\sqrt{\pi}} x^{-3} \int_x^\infty -2t e^{-t^2} dt \\ &= \frac{1}{2\sqrt{\pi}} x^{-3} e^{-x^2}. \end{aligned}$$

Thus we see that

$$\frac{1}{\sqrt{\pi}} x^{-1} e^{-x^2} \gg \frac{1}{\sqrt{\pi}} \int_x^\infty t^{-2} e^{-t^2} dt \quad \text{as } x \rightarrow \infty.$$

Therefore,

$$\operatorname{erfc}(x) \sim \frac{1}{\sqrt{\pi}} x^{-1} e^{-x^2} \quad \text{as } x \rightarrow \infty,$$

and we expect that  $\frac{1}{\sqrt{\pi}} x^{-1} e^{-x^2}$  would be a good approximation to  $\operatorname{erfc}(x)$  for large  $x$ . In Figure 24.2  $\log(\operatorname{erfc}(x))$  is graphed in a solid line and  $\log\left(\frac{1}{\sqrt{\pi}} x^{-1} e^{-x^2}\right)$  is graphed in a dashed line. We see that this first approximation to the error function gives very good results even for moderate values of  $x$ . Table 24.1 gives the error in this first approximation for various values of  $x$ .

If we continue integrating by parts, we might get a better approximation to the complementary error function.

$$\begin{aligned} \operatorname{erfc}(x) &= \frac{1}{\sqrt{\pi}} x^{-1} e^{-x^2} - \frac{1}{\sqrt{\pi}} \int_x^\infty t^{-2} e^{-t^2} dt \\ &= \frac{1}{\sqrt{\pi}} x^{-1} e^{-x^2} - \frac{1}{\sqrt{\pi}} \left[ -\frac{1}{2} t^{-3} e^{-t^2} \right]_x^\infty + \frac{1}{\sqrt{\pi}} \int_x^\infty \frac{3}{2} t^{-4} e^{-t^2} dt \\ &= \frac{1}{\sqrt{\pi}} e^{-x^2} \left( x^{-1} - \frac{1}{2} x^{-3} \right) + \frac{1}{\sqrt{\pi}} \int_x^\infty \frac{3}{2} t^{-4} e^{-t^2} dt \\ &= \frac{1}{\sqrt{\pi}} e^{-x^2} \left( x^{-1} - \frac{1}{2} x^{-3} \right) + \frac{1}{\sqrt{\pi}} \left[ -\frac{3}{4} t^{-5} e^{-t^2} \right]_x^\infty - \frac{1}{\sqrt{\pi}} \int_x^\infty \frac{15}{4} t^{-6} e^{-t^2} dt \\ &= \frac{1}{\sqrt{\pi}} e^{-x^2} \left( x^{-1} - \frac{1}{2} x^{-3} + \frac{3}{4} x^{-5} \right) - \frac{1}{\sqrt{\pi}} \int_x^\infty \frac{15}{4} t^{-6} e^{-t^2} dt \end{aligned}$$

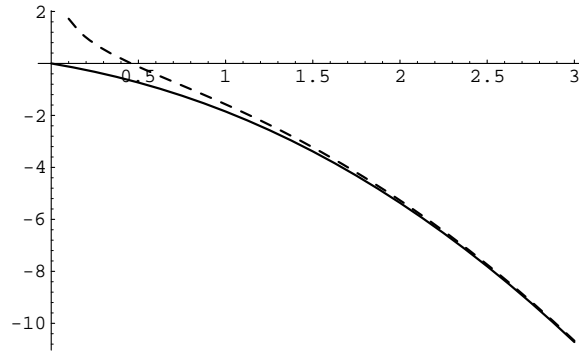

Figure 24.2: Logarithm of the Approximation to the Complementary Error Function.

*The error in approximating  $\operatorname{erfc}(x)$  with the first three terms is given in Table 24.1. We see that for  $x \geq 2$  the three terms give a much better approximation to  $\operatorname{erfc}(x)$  than just the first term.*

*At this point you might guess that you could continue this process indefinitely. By repeated application of integration by parts, you can obtain the series expansion*

$$\operatorname{erfc}(x) = \frac{2}{\sqrt{\pi}} e^{-x^2} \sum_{n=0}^{\infty} \frac{(-1)^n (2n)!}{n! (2x)^{2n+1}}.$$

$x$	$\operatorname{erfc}(x)$	One Term Relative Error	Three Term Relative Error
1	0.157	0.3203	0.6497
2	0.00468	0.1044	0.0182
3	$2.21 \times 10^{-5}$	0.0507	0.0020
4	$1.54 \times 10^{-8}$	0.0296	$3.9 \cdot 10^{-4}$
5	$1.54 \times 10^{-12}$	0.0192	$1.1 \cdot 10^{-4}$
6	$2.15 \times 10^{-17}$	0.0135	$3.7 \cdot 10^{-5}$
7	$4.18 \times 10^{-23}$	0.0100	$1.5 \cdot 10^{-5}$
8	$1.12 \times 10^{-29}$	0.0077	$6.9 \cdot 10^{-6}$
9	$4.14 \times 10^{-37}$	0.0061	$3.4 \cdot 10^{-6}$
10	$2.09 \times 10^{-45}$	0.0049	$1.8 \cdot 10^{-6}$

Table 24.1:

*This is a Taylor expansion about infinity. Let's find the radius of convergence.*

$$\begin{aligned}
\lim_{n \rightarrow \infty} \left| \frac{a_{n+1}(x)}{a_n(x)} \right| < 1 &\rightarrow \lim_{n \rightarrow \infty} \left| \frac{(-1)^{n+1}(2(n+1))!}{(n+1)!(2x)^{2(n+1)+1}} \frac{n!(2x)^{2n+1}}{(-1)^n(2n)!} \right| < 1 \\
&\rightarrow \lim_{n \rightarrow \infty} \left| \frac{(2n+2)(2n+1)}{(n+1)(2x)^2} \right| < 1 \\
&\rightarrow \lim_{n \rightarrow \infty} \left| \frac{2(2n+1)}{(2x)^2} \right| < 1 \\
&\rightarrow \left| \frac{1}{x} \right| = 0
\end{aligned}$$

*Thus we see that our series diverges for all  $x$ . Our conventional mathematical sense would tell us that this series is useless, however we will see that this series is very useful as an asymptotic expansion of  $\operatorname{erfc}(x)$ .*

Say we are working with a convergent series expansion of some function  $f(x)$ .

$$f(x) = \sum_{n=0}^{\infty} a_n(x)$$

For fixed  $x = x_0$ ,

$$f(x_0) - \sum_{n=0}^N a_n(x_0) \rightarrow 0 \quad \text{as } N \rightarrow \infty.$$

For an asymptotic series we have a quite different behavior. If  $g(x)$  is asymptotic to  $\sum_{n=0}^{\infty} b_n(x)$  as  $x \rightarrow x_0$  then for fixed  $N$ ,

$$g(x) - \sum_{n=0}^N b_n(x) \ll b_N(x) \quad \text{as } x \rightarrow x_0.$$

For the complementary error function,

$$\text{For fixed } N, \quad \text{erfc}(x) - \frac{2}{\sqrt{\pi}} e^{-x^2} \sum_{n=0}^N \frac{(-1)^n (2n)!}{n! (2x)^{2n+1}} \ll x^{-2N-1} \quad \text{as } x \rightarrow \infty.$$

We say that the error function is asymptotic to the series as  $x$  goes to infinity.

$$\text{erfc}(x) \sim \frac{2}{\sqrt{\pi}} e^{-x^2} \sum_{n=0}^{\infty} \frac{(-1)^n (2n)!}{n! (2x)^{2n+1}} \quad \text{as } x \rightarrow \infty$$

In Figure 24.3 the logarithm of the difference between the one term, ten term and twenty term approximations and the complementary error function are graphed in coarse, medium, and fine dashed lines, respectively.

**\*Optimal Asymptotic Series.** Of the three approximations, the one term is best for  $x \lesssim 2$ , the ten term is best for  $2 \lesssim x \lesssim 4$ , and the twenty term is best for  $4 \lesssim x$ . This leads us to the concept of an optimal asymptotic approximation. An optimal asymptotic approximation contains the number of terms in the series that best approximates the true behavior.

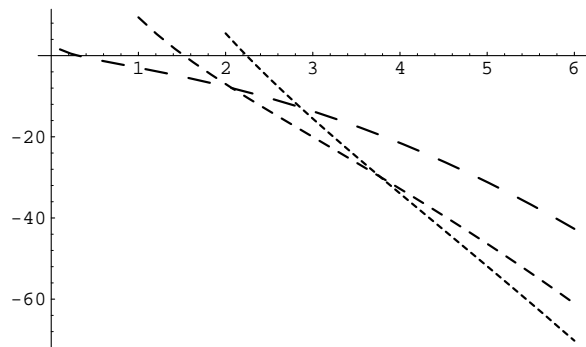

Figure 24.3:  $\log(\text{error in approximation})$

In Figure 24.4 we see a plot of the number of terms in the approximation versus the logarithm of the error for  $x = 3$ . Thus we see that the optimal asymptotic approximation is the first nine terms. After nine terms the error gets larger. It was inevitable that the error would start to grow after some point as the series diverges for all  $x$ .

A good rule of thumb for finding the optimal series is to find the smallest term in the series and take all of the terms up to but not including the smallest term as the optimal approximation. This makes sense, because the  $n^{\text{th}}$  term is an approximation of the error incurred by using the first  $n - 1$  terms. In Figure 24.5 there is a plot of  $n$  versus the logarithm of the  $n^{\text{th}}$  term in the asymptotic expansion of  $\text{erfc}(3)$ . We see that the tenth term is the smallest. Thus, in this case, our rule of thumb predicts the actual optimal series.

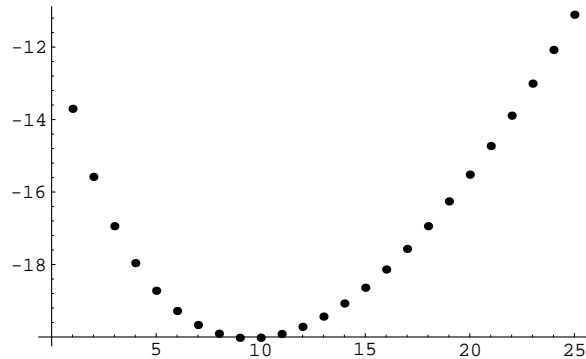

Figure 24.4: The logarithm of the error in using  $n$  terms.

## 24.4 Asymptotic Series

A function  $f(x)$  has an asymptotic series expansion about  $x = x_0$ ,  $\sum_{n=0}^{\infty} a_n(x)$ , if

$$f(x) - \sum_{n=0}^N a_n(x) \ll a_N(x) \quad \text{as } x \rightarrow x_0 \quad \text{for all } N.$$

An asymptotic series may be convergent or divergent. Most of the asymptotic series you encounter will be divergent. If the series is convergent, then we have that

$$f(x) - \sum_{n=0}^N a_n(x) \rightarrow 0 \quad \text{as } N \rightarrow \infty \quad \text{for fixed } x.$$

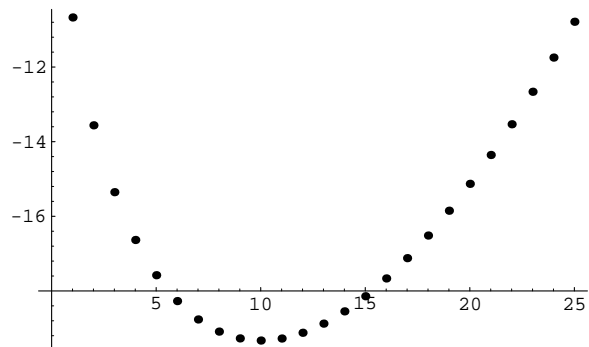

Figure 24.5: The logarithm of the  $n^{\text{th}}$  term in the expansion for  $x = 3$ .

Let  $\epsilon_n(x)$  be some set of gauge functions. The example that we are most familiar with is  $\epsilon_n(x) = x^n$ . If we say that

$$\sum_{n=0}^{\infty} a_n \epsilon_n(x) \sim \sum_{n=0}^{\infty} b_n \epsilon_n(x),$$

then this means that  $a_n = b_n$ .

## 24.5 Asymptotic Expansions of Differential Equations

### 24.5.1 The Parabolic Cylinder Equation.

**Controlling Factor.** Let us examine the behavior of the bounded solution of the parabolic cylinder equation as  $x \rightarrow +\infty$ .

$$y'' + \left( \nu + \frac{1}{2} - \frac{1}{4}x^2 \right) y = 0$$

This equation has an irregular singular point at infinity. With the substitution  $y = e^s$ , the equation becomes

$$s'' + (s')^2 + \nu + \frac{1}{2} - \frac{1}{4}x^2 = 0.$$

We know that

$$\nu + \frac{1}{2} \ll \frac{1}{4}x^2 \quad \text{as } x \rightarrow +\infty$$

so we drop this term from the equation. Let us make the assumption that

$$s'' \ll (s')^2 \quad \text{as } x \rightarrow +\infty.$$

Thus we are left with the equation

$$\begin{aligned}(s')^2 &\sim \frac{1}{4}x^2 \\ s' &\sim \pm \frac{1}{2}x \\ s &\sim \pm \frac{1}{4}x^2 + c \\ s &\sim \pm \frac{1}{4}x^2 \quad \text{as } x \rightarrow +\infty\end{aligned}$$

Now let's check if our assumption is consistent. Substituting into  $s'' \ll (s')^2$  yields  $1/2 \ll x^2/4$  as  $x \rightarrow +\infty$  which is true. Since the equation for  $y$  is second order, we would expect that there are two different behaviors as  $x \rightarrow +\infty$ . This is confirmed by the fact that we found two behaviors for  $s$ .  $s \sim -x^2/4$  corresponds to the solution that is bounded at  $+\infty$ . Thus the controlling factor of the leading behavior is  $e^{-x^2/4}$ .



**Leading Order Behavior.** Now we attempt to get a better approximation to  $s$ . We make the substitution  $s = -\frac{1}{4}x^2 + t(x)$  into the equation for  $s$  where  $t \ll x^2$  as  $x \rightarrow +\infty$ .

$$-\frac{1}{2} + t'' + \frac{1}{4}x^2 - xt' + (t')^2 + \nu + \frac{1}{2} - \frac{1}{4}x^2 = 0$$

$$t'' - xt' + (t')^2 + \nu = 0$$

Since  $t \ll x^2$ , we assume that  $t' \ll x$  and  $t'' \ll 1$  as  $x \rightarrow +\infty$ . Note that this is only an assumption since it is not always valid to differentiate an asymptotic relation. Thus  $(t')^2 \ll xt'$  and  $t'' \ll xt'$  as  $x \rightarrow +\infty$ ; we drop these terms from the equation.

$$t' \sim \frac{\nu}{x}$$

$$t \sim \nu \log x + c$$

$$t \sim \nu \log x \quad \text{as } x \rightarrow +\infty$$

Checking our assumptions for the derivatives of  $t$ ,

$$t' \ll x \quad \rightarrow \quad \frac{1}{x} \ll x \quad \quad t'' \ll 1 \quad \rightarrow \quad \frac{1}{x^2} \ll 1,$$

we see that they were consistent. Now we wish to refine our approximation for  $t$  with the substitution  $t(x) = \nu \log x + u(x)$ . So far we have that

$$y \sim \exp \left[ -\frac{x^2}{4} + \nu \log x + u(x) \right] = x^\nu \exp \left[ -\frac{x^2}{4} + u(x) \right] \quad \text{as } x \rightarrow +\infty.$$

We can try and determine  $u(x)$  by substituting the expression  $t(x) = \nu \log x + u(x)$  into the equation for  $t$ .

$$-\frac{\nu}{x^2} + u'' - (\nu + xu') + \frac{\nu^2}{x^2} + \frac{2\nu}{x}u' + (u')^2 + \nu = 0$$

After suitable simplification, this equation becomes

$$u' \sim \frac{\nu^2 - \nu}{x^3} \quad \text{as } x \rightarrow +\infty$$

Integrating this asymptotic relation,

$$u \sim \frac{\nu - \nu^2}{2x^2} + c \quad \text{as } x \rightarrow +\infty.$$

Notice that  $\frac{\nu - \nu^2}{2x^2} \ll c$  as  $x \rightarrow +\infty$ ; thus this procedure fails to give us the behavior of  $u(x)$ . Further refinements to our approximation for  $s$  go to a constant value as  $x \rightarrow +\infty$ . Thus we have that the leading behavior is

$$y \sim cx^\nu \exp\left[-\frac{x^2}{4}\right] \quad \text{as } x \rightarrow +\infty$$

**Asymptotic Expansion** Since we have factored off the singular behavior of  $y$ , we might expect that what is left over is well behaved enough to be expanded in a Taylor series about infinity. Let us assume that we can expand the solution for  $y$  in the form

$$y(x) \sim x^\nu \exp\left(-\frac{x^2}{4}\right) \sigma(x) = x^\nu \exp\left(-\frac{x^2}{4}\right) \sum_{n=0}^{\infty} a_n x^{-n} \text{ as } x \rightarrow +\infty$$

where  $a_0 = 1$ . Differentiating  $y = x^\nu \exp\left(-\frac{x^2}{4}\right) \sigma(x)$ ,

$$y' = \left[ \nu x^{\nu-1} - \frac{1}{2} x^{\nu+1} \right] e^{-x^2/4} \sigma(x) + x^\nu e^{-x^2/4} \sigma'(x)$$

$$y'' = \left[ \nu(\nu-1)x^{\nu-2} - \frac{1}{2}\nu x^\nu - \frac{1}{2}(\nu+1)x^\nu + \frac{1}{4}x^{\nu+2} \right] e^{-x^2/4} \sigma(x) + 2 \left[ \nu x^{\nu-1} - \frac{1}{2}x^{\nu+1} \right] e^{-x^2/4} \sigma'(x) + x^\nu e^{-x^2/4} \sigma''(x).$$

Substituting this into the differential equation for  $y$ ,

$$\begin{aligned} \left[ \nu(\nu-1)x^{-2} - \left(\nu + \frac{1}{2}\right) + \frac{1}{4}x^2 \right] \sigma(x) + 2 \left[ \nu x^{-1} - \frac{1}{2}x \right] \sigma'(x) + \sigma''(x) + \left[ \nu + \frac{1}{2} - \frac{1}{4}x^2 \right] \sigma(x) &= 0 \\ \sigma''(x) + (2\nu x^{-1} - x)\sigma'(x) + \nu(\nu-1)x^{-2}\sigma &= 0 \\ x^2\sigma''(x) + (2\nu x - x^3)\sigma'(x) + \nu(\nu-1)\sigma(x) &= 0. \end{aligned}$$

Differentiating the expression for  $\sigma(x)$ ,

$$\begin{aligned}\sigma(x) &= \sum_{n=0}^{\infty} a_n x^{-n} \\ \sigma'(x) &= \sum_{n=1}^{\infty} -n a_n x^{-n-1} = \sum_{n=-1}^{\infty} -(n+2) a_{n+2} x^{-n-3} \\ \sigma''(x) &= \sum_{n=1}^{\infty} n(n+1) a_n x^{-n-2}.\end{aligned}$$

Substituting this into the differential equation for  $\sigma(x)$ ,

$$\sum_{n=1}^{\infty} n(n+1) a_n x^{-n} + 2\nu \sum_{n=1}^{\infty} -n a_n x^{-n} - \sum_{n=-1}^{\infty} -(n+2) a_{n+2} x^{-n} + \nu(\nu-1) \sum_{n=0}^{\infty} a_n x^{-n} = 0.$$

Equating the coefficient of  $x^1$  to zero yields

$$a_1 x = 0 \quad \rightarrow \quad a_1 = 0.$$

Equating the coefficient of  $x^0$ ,

$$2a_2 + \nu(\nu-1)a_0 = 0 \quad \rightarrow \quad a_2 = -\frac{1}{2}\nu(\nu-1).$$

From the coefficient of  $x^{-n}$  for  $n > 0$ ,

$$\begin{aligned}n(n+1)a_n - 2\nu n a_n + (n+2)a_{n+2} + \nu(\nu-1)a_n &= 0 \\ (n+2)a_{n+2} &= -[n(n+1) - 2\nu n + \nu(\nu-1)]a_n \\ (n+2)a_{n+2} &= -[n^2 + n - 2\nu n + \nu(\nu-1)]a_n \\ (n+2)a_{n+2} &= -(n-\nu)(n-\nu+1)a_n.\end{aligned}$$

Thus the recursion formula for the  $a_n$ 's is

$$a_{n+2} = -\frac{(n-\nu)(n-\nu+1)}{n+2}a_n, \quad a_0 = 1, \quad a_1 = 0.$$

The first few terms in  $\sigma(x)$  are

$$\sigma(x) \sim 1 - \frac{\nu(\nu-1)}{2^1 1!} x^{-2} + \frac{\nu(\nu-1)(\nu-2)(\nu-3)}{2^2 2!} x^{-4} - \dots \quad \text{as } x \rightarrow +\infty$$

If we check the radius of convergence of this series

$$\begin{aligned} \lim_{n \rightarrow \infty} \left| \frac{a_{n+2} x^{-n-2}}{a_n x^{-n}} \right| < 1 &\rightarrow \lim_{n \rightarrow \infty} \left| -\frac{(n-\nu)(n-\nu+1)}{n+2} x^{-2} \right| < 1 \\ &\rightarrow \frac{1}{x} = 0 \end{aligned}$$

we see that the radius of convergence is zero. Thus if  $\nu \neq 0, 1, 2, \dots$  our asymptotic expansion for  $y$

$$y \sim x^\nu e^{-x^2/4} \left[ 1 - \frac{\nu(\nu-1)}{2^1 1!} x^{-2} + \frac{\nu(\nu-1)(\nu-2)(\nu-3)}{2^2 2!} x^{-4} - \dots \right]$$

diverges for all  $x$ . However this solution is still very useful. If we only use a finite number of terms, we will get a very good numerical approximation for large  $x$ .

In Figure 24.6 the one term, two term, and three term asymptotic approximations are shown in rough, medium, and fine dashing, respectively. The numerical solution is plotted in a solid line.

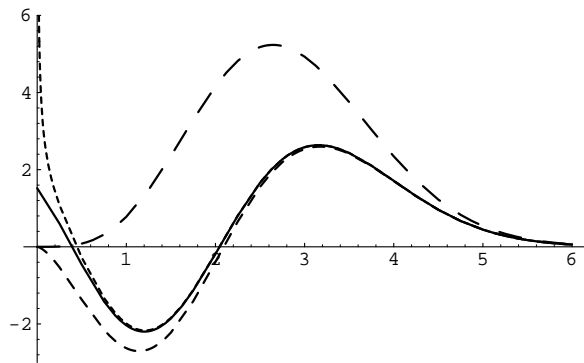

Figure 24.6: Asymptotic Approximations to the Parabolic Cylinder Function.

# Chapter 25

## Hilbert Spaces

An expert is a man who has made all the mistakes which can be made, in a narrow field.

- Niels Bohr

WARNING: UNDER HEAVY CONSTRUCTION.

In this chapter we will introduce Hilbert spaces. We develop the two important examples:  $l_2$ , the space of square summable infinite vectors and  $L_2$ , the space of square integrable functions.

### 25.1 Linear Spaces

A *linear space* is a set of elements  $\{x, y, z, \dots\}$  that is closed under addition and scalar multiplication. By closed under addition we mean: if  $x$  and  $y$  are elements, then  $z = x + y$  is an element. The addition is commutative and associative.

$$\begin{aligned}x + y &= y + x \\(x + y) + z &= x + (y + z)\end{aligned}$$

Scalar multiplication is associative and distributive. Let  $a$  and  $b$  be scalars,  $a, b \in \mathbb{C}$ .

$$\begin{aligned}(ab)x &= a(bx) \\ (a + b)x &= ax + bx \\ a(x + y) &= ax + ay\end{aligned}$$

All the linear spaces that we will work with have additional properties: The zero element  $0$  is the additive identity.

$$x + 0 = x$$

Multiplication by the scalar  $1$  is the multiplicative identity.

$$1x = x$$

Each element  $x$  and the additive inverse,  $-x$ .

$$x + (-x) = 0$$

Consider a set of elements  $\{x_1, x_2, \dots\}$ . Let the  $c_i$  be scalars. If

$$y = c_1x_1 + c_2x_2 + \dots$$

then  $y$  is a *linear combination* of the  $x_i$ . A set of elements  $\{x_1, x_2, \dots\}$  is *linearly independent* if the equation

$$c_1x_1 + c_2x_2 + \dots = 0$$

has only the trivial solution  $c_1 = c_2 = \dots = 0$ . Otherwise the set is *linearly dependent*.

Let  $\{e_1, e_2, \dots\}$  be a linearly independent set of elements. If every element  $x$  can be written as a linear combination of the  $e_i$  then the set  $\{e_i\}$  is a *basis* for the space. The  $e_i$  are called *base elements*.

$$x = \sum_i c_i e_i$$

The set  $\{e_i\}$  is also called a *coordinate system*. The scalars  $c_i$  are the *coordinates* or *components* of  $x$ . If the set  $\{e_i\}$  is a basis, then we say that the set is *complete*.

## 25.2 Inner Products

$\langle x|y\rangle$  is an *inner product* of two elements  $x$  and  $y$  if it satisfies the properties:

1. Conjugate-commutative.

$$\langle x|y\rangle = \overline{\langle y|x\rangle}$$

2. Linearity in the second argument.

$$\langle x|ay + bz\rangle = a\langle x|y\rangle + b\langle x|z\rangle$$

3. Positive definite.

$$\langle x|x\rangle \geq 0$$

$$\langle x|x\rangle = 0 \text{ if and only if } x = 0$$

From these properties one can derive the properties:

1. Conjugate linearity in the first argument.

$$\langle ax + by|z\rangle = \bar{a}\langle x|z\rangle + \bar{b}\langle y|z\rangle$$

2. Schwarz Inequality.

$$|\langle x|y\rangle|^2 \leq \langle x|x\rangle\langle y|y\rangle$$

One inner product of vectors is the *Euclidean inner product*.

$$\langle \mathbf{x}|\mathbf{y}\rangle \equiv \mathbf{x} \cdot \mathbf{y} = \sum_{i=0}^n \bar{x}_i y_i.$$

One inner product of functions defined on  $(a \dots b)$  is

$$\langle u|v\rangle = \int_a^b \overline{u(x)}v(x) dx.$$



If  $\sigma(x)$  is a positive-valued function, then we can define the inner product:

$$\langle u|\sigma|v\rangle = \int_a^b \overline{u(x)}\sigma(x)v(x) dx.$$

This is called the inner product with respect to the weighting function  $\sigma(x)$ . It is also denoted  $\langle u|v\rangle_\sigma$ .

## 25.3 Norms

A *norm* is a real-valued function on a space which satisfies the following properties.

1. Positive.

$$\|x\| \geq 0$$

2. Definite.

$$\|x\| = 0 \text{ if and only if } x = 0$$

3. Multiplication by a scalar,  $c \in \mathbb{C}$ .

$$\|cx\| = |c|\|x\|$$

4. Triangle inequality.

$$\|x + y\| \leq \|x\| + \|y\|$$

**Example 25.3.1** Consider a vector space, (finite or infinite dimension), with elements  $x = (x_1, x_2, x_3, \dots)$ . Here are some common norms.

- Norm generated by the inner product.

$$\|x\| = \sqrt{\langle x|x\rangle}$$

- The  $l_p$  norm.

$$\|x\|_p = \left( \sum_{k=1}^{\infty} |x_k|^p \right)^{1/p}$$

There are three common cases of the  $l_p$  norm.

- Euclidian norm, or  $l_2$  norm.

$$\|x\|_2 = \sqrt{\sum_{k=1}^{\infty} |x_k|^2}$$

- $l_1$  norm.

$$\|x\|_1 = \sum_{k=1}^{\infty} |x_k|$$

- $l_{\infty}$  norm.

$$\|x\|_{\infty} = \max_k |x_k|$$

**Example 25.3.2** Consider a space of functions defined on the interval  $(a \dots b)$ . Here are some common norms.

- Norm generated by the inner product.

$$\|u\| = \sqrt{\langle u|u \rangle}$$

- The  $L_p$  norm.

$$\|u\|_p = \left( \int_a^b |u(x)|^p dx \right)^{1/p}$$

There are three common cases of the  $L_p$  norm.

- Euclidian norm, or  $L_2$  norm.

$$\|u\|_2 = \sqrt{\int_a^b |u(x)|^2 dx}$$

–  $L_1$  norm.

$$\|u\|_1 = \int_a^b |u(x)| \, dx$$

–  $L_\infty$  norm.

$$\|u\|_\infty = \limsup_{x \in (a \dots b)} |u(x)|$$

**Distance.** Using the norm, we can define the distance between elements  $u$  and  $v$ .

$$d(u, v) \equiv \|u - v\|$$

Note that  $d(u, v) = 0$  does not necessarily imply that  $u = v$ . CONTINUE.

## 25.4 Linear Independence.

## 25.5 Orthogonality

Orthogonality.

$$\langle \phi_j | \phi_k \rangle = 0 \text{ if } j \neq k$$

Orthonormality.

$$\langle \phi_j | \phi_k \rangle = \delta_{jk}$$

**Example 25.5.1** *Infinite vectors.*  $e_j$  has all zeros except for a 1 in the  $j^{\text{th}}$  position.

$$e_j = (0, 0, \dots, 0, 1, 0, \dots)$$

**Example 25.5.2**  $L_2$  functions on  $(0 \dots 2\pi)$ .

$$\phi_j = \frac{1}{\sqrt{2\pi}} e^{ijx}, \quad j \in \mathbb{Z}$$

$$\phi_0 = \frac{1}{\sqrt{2\pi}}, \quad \phi_j^{(1)} = \frac{1}{\sqrt{\pi}} \cos(jx), \quad \phi_j^{(1)} = \frac{1}{\sqrt{\pi}} \sin(jx), \quad j \in \mathbb{Z}^+$$

## 25.6 Gram-Schmidt Orthogonalization

Let  $\{\psi_1(x), \dots, \psi_n(x)\}$  be a set of linearly independent functions. Using the Gram-Schmidt orthogonalization process we can construct a set of orthogonal functions  $\{\phi_1(x), \dots, \phi_n(x)\}$  that has the same span as the set of  $\psi_n$ 's with the formulas

$$\begin{aligned}\phi_1 &= \psi_1 \\ \phi_2 &= \psi_2 - \frac{\langle \phi_1 | \psi_2 \rangle}{\|\phi_1\|^2} \phi_1 \\ \phi_3 &= \psi_3 - \frac{\langle \phi_1 | \psi_3 \rangle}{\|\phi_1\|^2} \phi_1 - \frac{\langle \phi_2 | \psi_3 \rangle}{\|\phi_2\|^2} \phi_2 \\ &\dots \\ \phi_n &= \psi_n - \sum_{j=1}^{n-1} \frac{\langle \phi_j | \psi_n \rangle}{\|\phi_j\|^2} \phi_j.\end{aligned}$$

You could verify that the  $\phi_m$  are orthogonal with a proof by induction.

**Example 25.6.1** Suppose we would like a polynomial approximation to  $\cos(\pi x)$  in the domain  $[-1, 1]$ . One way to do this is to find the Taylor expansion of the function about  $x = 0$ . Up to terms of order  $x^4$ , this is

$$\cos(\pi x) = 1 - \frac{(\pi x)^2}{2} + \frac{(\pi x)^4}{24} + O(x^6).$$

In the first graph of Figure 25.1  $\cos(\pi x)$  and this fourth degree polynomial are plotted. We see that the approximation is very good near  $x = 0$ , but deteriorates as we move away from that point. This makes sense because the Taylor expansion only makes use of information about the function's behavior at the point  $x = 0$ .

As a second approach, we could find the least squares fit of a fourth degree polynomial to  $\cos(\pi x)$ . The set of functions  $\{1, x, x^2, x^3, x^4\}$  is independent, but not orthogonal in the interval  $[-1, 1]$ . Using Gram-Schmidt orthogo-

nalization,

$$\phi_0 = 1$$

$$\phi_1 = x - \frac{\langle 1|x \rangle}{\langle 1|1 \rangle} = x$$

$$\phi_2 = x^2 - \frac{\langle 1|x^2 \rangle}{\langle 1|1 \rangle} - \frac{\langle x|x^2 \rangle}{\langle x|x \rangle} x = x^2 - \frac{1}{3}$$

$$\phi_3 = x^3 - \frac{3}{5}x$$

$$\phi_4 = x^4 - \frac{6}{7}x^2 - \frac{3}{35}$$

A widely used set of functions in mathematics is the set of **Legendre polynomials**  $\{P_0(x), P_1(x), \dots\}$ . They differ from the  $\phi_n$ 's that we generated only by constant factors. The first few are

$$P_0(x) = 1$$

$$P_1(x) = x$$

$$P_2(x) = \frac{3x^2 - 1}{2}$$

$$P_3(x) = \frac{5x^3 - 3x}{2}$$

$$P_4(x) = \frac{35x^4 - 30x^2 + 3}{8}.$$

*Expanding  $\cos(\pi x)$  in Legendre polynomials*

$$\cos(\pi x) \approx \sum_{n=0}^4 c_n P_n(x),$$

*and calculating the generalized Fourier coefficients with the formula*

$$c_n = \frac{\langle P_n | \cos(\pi x) \rangle}{\langle P_n | P_n \rangle},$$

yields

$$\begin{aligned}\cos(\pi x) &\approx -\frac{15}{\pi^2}P_2(x) + \frac{45(2\pi^2 - 21)}{\pi^4}P_4(x) \\ &= \frac{105}{8\pi^4}[(315 - 30\pi^2)x^4 + (24\pi^2 - 270)x^2 + (27 - 2\pi^2)]\end{aligned}$$

The cosine and this polynomial are plotted in the second graph in Figure 25.1. The least squares fit method uses information about the function on the entire interval. We see that the least squares fit does not give as good an approximation close to the point  $x = 0$  as the Taylor expansion. However, the least squares fit gives a good approximation on the entire interval.

In order to expand a function in a Taylor series, the function must be analytic in some domain. One advantage of using the method of least squares is that the function being approximated does not even have to be continuous.

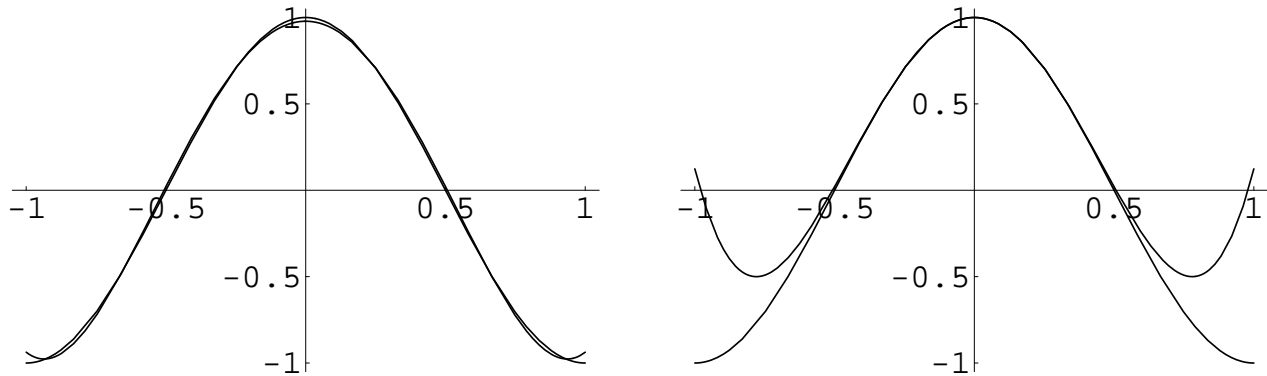

Figure 25.1: Polynomial Approximations to  $\cos(\pi x)$ .

## 25.7 Orthonormal Function Expansion

Let  $\{\phi_j\}$  be an orthonormal set of functions on the interval  $(a, b)$ . We expand a function  $f(x)$  in the  $\phi_j$ .

$$f(x) = \sum_j c_j \phi_j$$

We choose the coefficients to minimize the norm of the error.

$$\begin{aligned} \left\| f - \sum_j c_j \phi_j \right\|^2 &= \left\langle f - \sum_j c_j \phi_j \left| f - \sum_j c_j \phi_j \right. \right\rangle \\ &= \|f\|^2 - \left\langle f \left| \sum_j c_j \phi_j \right. \right\rangle - \left\langle \sum_j c_j \phi_j \left| f \right. \right\rangle + \left\langle \sum_j c_j \phi_j \left| \sum_j c_j \phi_j \right. \right\rangle \\ &= \|f\|^2 + \sum_j |c_j|^2 - \sum_j c_j \langle f | \phi_j \rangle - \sum_j \bar{c}_j \langle \phi_j | f \rangle \end{aligned}$$

$$\left\| f - \sum_j c_j \phi_j \right\|^2 = \|f\|^2 + \sum_j |c_j|^2 - \sum_j c_j \overline{\langle \phi_j | f \rangle} - \sum_j \bar{c}_j \langle \phi_j | f \rangle \quad (25.1)$$

To complete the square, we add the constant  $\sum_j \langle \phi_j | f \rangle \overline{\langle \phi_j | f \rangle}$ . We see the values of  $c_j$  which minimize

$$\|f\|^2 + \sum_j |c_j - \langle \phi_j | f \rangle|^2.$$

Clearly the unique minimum occurs for

$$c_j = \langle \phi_j | f \rangle.$$

We substitute this value for  $c_j$  into the right side of Equation 25.1 and note that this quantity, the squared norm of the error, is non-negative.

$$\begin{aligned}\|f\|^2 + \sum_j |c_j|^2 - \sum_j |c_j|^2 - \sum_j |c_j|^2 &\geq 0 \\ \|f\|^2 &\geq \sum_j |c_j|^2\end{aligned}$$

This is known as *Bessel's Inequality*. If the set of  $\{\phi_j\}$  is complete then the norm of the error is zero and we obtain *Bessel's Equality*.

$$\|f\|^2 = \sum_j |c_j|^2$$

## 25.8 Sets Of Functions

**Orthogonality.** Consider two complex valued functions of a real variable  $\phi_1(x)$  and  $\phi_2(x)$  defined on the interval  $a \leq x \leq b$ . The inner product of the two functions is defined

$$\langle \phi_1 | \phi_2 \rangle = \int_a^b \overline{\phi_1(x)} \phi_2(x) dx.$$

The two functions are orthogonal if  $\langle \phi_1 | \phi_2 \rangle = 0$ . The  $L_2$  norm of a function is defined  $\|\phi\| = \sqrt{\langle \phi | \phi \rangle}$ .

Let  $\{\phi_1, \phi_2, \phi_3, \dots\}$  be a set of complex valued functions. The set of functions is orthogonal if each pair of functions is orthogonal. That is,

$$\langle \phi_n | \phi_m \rangle = 0 \quad \text{if } n \neq m.$$

If in addition the norm of each function is 1, then the set is orthonormal. That is,

$$\langle \phi_n | \phi_m \rangle = \delta_{nm} = \begin{cases} 1 & \text{if } n = m \\ 0 & \text{if } n \neq m. \end{cases}$$



**Example 25.8.1** *The set of functions*

$$\left\{ \sqrt{\frac{2}{\pi}} \sin(x), \sqrt{\frac{2}{\pi}} \sin(2x), \sqrt{\frac{2}{\pi}} \sin(3x), \dots \right\}$$

is orthonormal on the interval  $[0, \pi]$ . To verify this,

$$\begin{aligned} \left\langle \sqrt{\frac{2}{\pi}} \sin(nx) \middle| \sqrt{\frac{2}{\pi}} \sin(nx) \right\rangle &= \frac{2}{\pi} \int_0^{\pi} \sin^2(nx) \, dx \\ &= 1 \end{aligned}$$

If  $n \neq m$  then

$$\begin{aligned} \left\langle \sqrt{\frac{2}{\pi}} \sin(nx) \middle| \sqrt{\frac{2}{\pi}} \sin(mx) \right\rangle &= \frac{2}{\pi} \int_0^{\pi} \sin(nx) \sin(mx) \, dx \\ &= \frac{1}{\pi} \int_0^{\pi} (\cos[(n-m)x] - \cos[(n+m)x]) \, dx \\ &= 0. \end{aligned}$$

**Example 25.8.2** *The set of functions*

$$\left\{ \dots, \frac{1}{\sqrt{2\pi}} e^{-ix}, \frac{1}{\sqrt{2\pi}}, \frac{1}{\sqrt{2\pi}} e^{ix}, \frac{1}{\sqrt{2\pi}} e^{i2x}, \dots \right\},$$

is orthonormal on the interval  $[-\pi, \pi]$ . To verify this,

$$\begin{aligned} \left\langle \frac{1}{\sqrt{2\pi}} e^{inx} \middle| \frac{1}{\sqrt{2\pi}} e^{inx} \right\rangle &= \frac{1}{2\pi} \int_{-\pi}^{\pi} e^{-inx} e^{inx} \, dx \\ &= \frac{1}{2\pi} \int_{-\pi}^{\pi} dx \\ &= 1. \end{aligned}$$

If  $n \neq m$  then

$$\begin{aligned}\left\langle \frac{1}{\sqrt{2\pi}} e^{inx} \left| \frac{1}{\sqrt{2\pi}} e^{imx} \right. \right\rangle &= \frac{1}{2\pi} \int_{-\pi}^{\pi} e^{-inx} e^{imx} dx \\ &= \frac{1}{2\pi} \int_{-\pi}^{\pi} e^{i(m-n)x} dx \\ &= 0.\end{aligned}$$

**Orthogonal with Respect to a Weighting Function.** Let  $\sigma(x)$  be a real-valued, positive function on the interval  $[a, b]$ . We introduce the notation

$$\langle \phi_n | \sigma | \phi_m \rangle \equiv \int_a^b \overline{\phi_n} \sigma \phi_m dx.$$

If the set of functions  $\{\phi_1, \phi_2, \phi_3, \dots\}$  satisfy

$$\langle \phi_n | \sigma | \phi_m \rangle = 0 \quad \text{if } n \neq m$$

then the functions are orthogonal with respect to the weighting function  $\sigma(x)$ .

If the functions satisfy

$$\langle \phi_n | \sigma | \phi_m \rangle = \delta_{nm}$$

then the set is orthonormal with respect to  $\sigma(x)$ .

**Example 25.8.3** We know that the set of functions

$$\left\{ \sqrt{\frac{2}{\pi}} \sin(x), \sqrt{\frac{2}{\pi}} \sin(2x), \sqrt{\frac{2}{\pi}} \sin(3x), \dots \right\}$$

is orthonormal on the interval  $[0, \pi]$ . That is,

$$\int_0^{\pi} \sqrt{\frac{2}{\pi}} \sin(nx) \sqrt{\frac{2}{\pi}} \sin(mx) dx = \delta_{nm}.$$

If we make the change of variables  $x = \sqrt{t}$  in this integral, we obtain

$$\int_0^{\pi^2} \frac{1}{2\sqrt{t}} \sqrt{\frac{2}{\pi}} \sin(n\sqrt{t}) \sqrt{\frac{2}{\pi}} \sin(m\sqrt{t}) dt = \delta_{nm}.$$

Thus the set of functions

$$\left\{ \sqrt{\frac{1}{\pi}} \sin(\sqrt{t}), \sqrt{\frac{1}{\pi}} \sin(2\sqrt{t}), \sqrt{\frac{1}{\pi}} \sin(3\sqrt{t}), \dots \right\}$$

is orthonormal with respect to  $\sigma(t) = \frac{1}{2\sqrt{t}}$  on the interval  $[0, \pi^2]$ .

**Orthogonal Series.** Suppose that a function  $f(x)$  defined on  $[a, b]$  can be written as a uniformly convergent sum of functions that are orthogonal with respect to  $\sigma(x)$ .

$$f(x) = \sum_{n=1}^{\infty} c_n \phi_n(x)$$

We can solve for the  $c_n$  by taking the inner product of  $\phi_m(x)$  and each side of the equation with respect to  $\sigma(x)$ .

$$\langle \phi_m | \sigma | f \rangle = \left\langle \phi_m \left| \sigma \left| \sum_{n=1}^{\infty} c_n \phi_n \right. \right. \right\rangle$$

$$\langle \phi_m | \sigma | f \rangle = \sum_{n=1}^{\infty} c_n \langle \phi_m | \sigma | \phi_n \rangle$$

$$\langle \phi_m | \sigma | f \rangle = c_m \langle \phi_m | \sigma | \phi_m \rangle$$

$$c_m = \frac{\langle \phi_m | \sigma | f \rangle}{\langle \phi_m | \sigma | \phi_m \rangle}$$

The  $c_m$  are known as **Generalized Fourier coefficients**. If the functions in the expansion are orthonormal, the formula simplifies to

$$c_m = \langle \phi_m | \sigma | f \rangle.$$

**Example 25.8.4** The function  $f(x) = x(\pi - x)$  has a uniformly convergent series expansion in the domain  $[0, \pi]$  of the form

$$x(\pi - x) = \sum_{n=1}^{\infty} c_n \sqrt{\frac{2}{\pi}} \sin(nx).$$

The Fourier coefficients are

$$\begin{aligned} c_n &= \left\langle \sqrt{\frac{2}{\pi}} \sin(nx) \middle| x(\pi - x) \right\rangle \\ &= \sqrt{\frac{2}{\pi}} \int_0^{\pi} x(\pi - x) \sin(nx) \, dx \\ &= \sqrt{\frac{2}{\pi}} \frac{2}{n^3} (1 - (-1)^n) \\ &= \begin{cases} \sqrt{\frac{2}{\pi}} \frac{4}{n^3} & \text{for odd } n \\ 0 & \text{for even } n \end{cases} \end{aligned}$$

Thus the expansion is

$$x(\pi - x) = \sum_{\substack{n=1 \\ \text{odd } n}}^{\infty} \frac{8}{\pi n^3} \sin(nx) \quad \text{for } x \in [0, \pi].$$

In the first graph of Figure 25.2 the first term in the expansion is plotted in a dashed line and  $x(\pi - x)$  is plotted in a solid line. The second graph shows the two term approximation.

**Example 25.8.5** The set  $\{\dots, 1/\sqrt{2\pi} e^{-ix}, 1/\sqrt{2\pi}, 1/\sqrt{2\pi} e^{ix}, 1/\sqrt{2\pi} e^{i2x}, \dots\}$  is orthonormal on the interval  $[-\pi, \pi]$ .

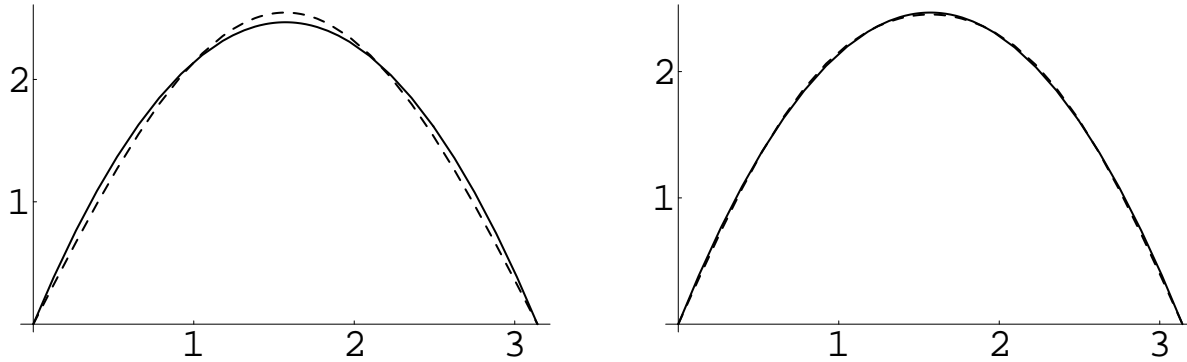

Figure 25.2: Series Expansions of  $x(\pi - x)$ .

$f(x) = \text{sign}(x)$  has the expansion

$$\begin{aligned}
 \text{sign}(x) &\sim \sum_{n=-\infty}^{\infty} \left\langle \frac{1}{\sqrt{2\pi}} e^{in\xi} \middle| \text{sign}(\xi) \right\rangle \frac{1}{\sqrt{2\pi}} e^{inx} \\
 &= \frac{1}{2\pi} \sum_{n=-\infty}^{\infty} \int_{-\pi}^{\pi} e^{-in\xi} \text{sign}(\xi) d\xi e^{inx} \\
 &= \frac{1}{2\pi} \sum_{n=-\infty}^{\infty} \left( \int_{-\pi}^0 -e^{-in\xi} d\xi + \int_0^{\pi} e^{-in\xi} d\xi \right) e^{inx} \\
 &= \frac{1}{\pi} \sum_{n=-\infty}^{\infty} \frac{1 - (-1)^n}{in} e^{inx}.
 \end{aligned}$$

In terms of real functions, this is

$$\begin{aligned}
 &= \frac{1}{\pi} \sum_{n=-\infty}^{\infty} \frac{1 - (-1)^n}{in} (\cos(nx) + i \sin(nx)) \\
 &= \frac{2}{\pi} \sum_{n=1}^{\infty} \frac{1 - (-1)^n}{in} \sin(nx)
 \end{aligned}$$

$$\text{sign}(x) \sim \frac{4}{\pi} \sum_{\substack{n=1 \\ \text{oddn}}}^{\infty} \frac{1}{n} \sin(nx).$$

## 25.9 Least Squares Fit to a Function and Completeness

Let  $\{\phi_1, \phi_2, \phi_3, \dots\}$  be a set of real, square integrable functions that are orthonormal with respect to the weighting function  $\sigma(x)$  on the interval  $[a, b]$ . That is,

$$\langle \phi_n | \sigma | \phi_m \rangle = \delta_{nm}.$$

Let  $f(x)$  be some square integrable function defined on the same interval. We would like to approximate the function  $f(x)$  with a finite orthonormal series.

$$f(x) \approx \sum_{n=1}^N \alpha_n \phi_n(x)$$

$f(x)$  may or may not have a uniformly convergent expansion in the orthonormal functions.

We would like to choose the  $\alpha_n$  so that we get the best possible approximation to  $f(x)$ . The most common measure of how well a series approximates a function is the least squares measure. The error is defined as the integral of the weighting function times the square of the deviation.

$$E = \int_a^b \sigma(x) \left( f(x) - \sum_{n=1}^N \alpha_n \phi_n(x) \right)^2 dx$$

The “best” fit is found by choosing the  $\alpha_n$  that minimize  $E$ . Let  $c_n$  be the Fourier coefficients of  $f(x)$ .

$$c_n = \langle \phi_n | \sigma | f \rangle$$

we expand the integral for  $E$ .

$$\begin{aligned} E(\alpha) &= \int_a^b \sigma(x) \left( f(x) - \sum_{n=1}^N \alpha_n \phi_n(x) \right)^2 dx \\ &= \left\langle f - \sum_{n=1}^N \alpha_n \phi_n \left| \sigma \right| f - \sum_{n=1}^N \alpha_n \phi_n \right\rangle \\ &= \langle f | \sigma | f \rangle - 2 \left\langle \sum_{n=1}^N \alpha_n \phi_n \left| \sigma \right| f \right\rangle + \left\langle \sum_{n=1}^N \alpha_n \phi_n \left| \sigma \right| \sum_{n=1}^N \alpha_n \phi_n \right\rangle \\ &= \langle f | \sigma | f \rangle - 2 \sum_{n=1}^N \alpha_n \langle \phi_n | \sigma | f \rangle + \sum_{n=1}^N \sum_{m=1}^N \alpha_n \alpha_m \langle \phi_n | \sigma | \phi_m \rangle \\ &= \langle f | \sigma | f \rangle - 2 \sum_{n=1}^N \alpha_n c_n + \sum_{n=1}^N \alpha_n^2 \\ &= \langle f | \sigma | f \rangle + \sum_{n=1}^N (\alpha_n - c_n)^2 - \sum_{n=1}^N c_n^2 \end{aligned}$$

Each term involving  $\alpha_n$  is non-negative and is minimized for  $\alpha_n = c_n$ . The Fourier coefficients give the least squares approximation to a function. The least squares fit to  $f(x)$  is thus

$$f(x) \approx \sum_{n=1}^N \langle \phi_n | \sigma | f \rangle \phi_n(x).$$

**Result 25.9.1** If  $\{\phi_1, \phi_2, \phi_3, \dots\}$  is a set of real, square integrable functions that are orthogonal with respect to  $\sigma(x)$  then the least squares fit of the first  $N$  orthogonal functions to the square integrable function  $f(x)$  is

$$f(x) \approx \sum_{n=1}^N \frac{\langle \phi_n | \sigma | f \rangle}{\langle \phi_n | \sigma | \phi_n \rangle} \phi_n(x).$$

If the set is orthonormal, this formula reduces to

$$f(x) \approx \sum_{n=1}^N \langle \phi_n | \sigma | f \rangle \phi_n(x).$$

Since the error in the approximation  $E$  is a nonnegative number we can obtain an inequality on the sum of the squared coefficients.

$$E = \langle f | \sigma | f \rangle - \sum_{n=1}^N c_n^2$$

$$\sum_{n=1}^N c_n^2 \leq \langle f | \sigma | f \rangle$$

This equation is known as **Bessel's Inequality**. Since  $\langle f | \sigma | f \rangle$  is just a nonnegative number, independent of  $N$ , the sum  $\sum_{n=1}^{\infty} c_n^2$  is convergent and  $c_n \rightarrow 0$  as  $n \rightarrow \infty$

**Convergence in the Mean.** If the error  $E$  goes to zero as  $N$  tends to infinity

$$\lim_{N \rightarrow \infty} \int_a^b \sigma(x) \left( f(x) - \sum_{n=1}^N c_n \phi_n(x) \right)^2 dx = 0,$$



then the sum converges in the mean to  $f(x)$  relative to the weighting function  $\sigma(x)$ . This implies that

$$\lim_{N \rightarrow \infty} \left( \langle f | \sigma | f \rangle - \sum_{n=1}^N c_n^2 \right) = 0$$

$$\sum_{n=1}^{\infty} c_n^2 = \langle f | \sigma | f \rangle.$$

This is known as **Parseval's identity**.

**Completeness.** Consider a set of functions  $\{\phi_1, \phi_2, \phi_3, \dots\}$  that is orthogonal with respect to the weighting function  $\sigma(x)$ . If every function  $f(x)$  that is square integrable with respect to  $\sigma(x)$  has an orthogonal series expansion

$$f(x) \sim \sum_{n=1}^{\infty} c_n \phi_n(x)$$

that converges in the mean to  $f(x)$ , then the set is **complete**.

## 25.10 Closure Relation

Let  $\{\phi_1, \phi_2, \dots\}$  be an orthonormal, complete set on the domain  $[a, b]$ . For any square integrable function  $f(x)$  we can write

$$f(x) \sim \sum_{n=1}^{\infty} c_n \phi_n(x).$$

Here the  $c_n$  are the generalized Fourier coefficients and the sum converges in the mean to  $f(x)$ . Substituting the expression for the Fourier coefficients into the sum yields

$$\begin{aligned} f(x) &\sim \sum_{n=1}^{\infty} \langle \phi_n | f \rangle \phi_n(x) \\ &= \sum_{n=1}^{\infty} \left( \int_a^b \overline{\phi_n(\xi)} f(\xi) \, d\xi \right) \phi_n(x). \end{aligned}$$

Since the sum is not necessarily uniformly convergent, we are not justified in exchanging the order of summation and integration. . . but what the heck, let's do it anyway.

$$\begin{aligned} &= \int_a^b \left( \sum_{n=1}^{\infty} \overline{\phi_n(\xi)} f(\xi) \phi_n(x) \right) \, d\xi \\ &= \int_a^b \left( \sum_{n=1}^{\infty} \overline{\phi_n(\xi)} \phi_n(x) \right) f(\xi) \, d\xi \end{aligned}$$

The sum behaves like a Dirac delta function. Recall that  $\delta(x - \xi)$  satisfies the equation

$$f(x) = \int_a^b \delta(x - \xi) f(\xi) \, d\xi \quad \text{for } x \in (a, b).$$

Thus we could say that the sum is a representation of  $\delta(x - \xi)$ . Note that a series representation of the delta function could not be convergent, hence the necessity of throwing caution to the wind when we interchanged the summation and integration in deriving the series. The **closure relation** for an orthonormal, complete set states

$$\sum_{n=1}^{\infty} \phi_n(x) \overline{\phi_n(\xi)} \sim \delta(x - \xi).$$

Alternatively, you can derive the closure relation by computing the generalized Fourier coefficients of the delta function.

$$\delta(x - \xi) \sim \sum_{n=1}^{\infty} c_n \phi_n(x)$$

$$\begin{aligned} c_n &= \langle \phi_n | \delta(x - \xi) \rangle \\ &= \int_a^b \overline{\phi_n(x)} \delta(x - \xi) dx \\ &= \overline{\phi_n(\xi)} \end{aligned}$$

$$\delta(x - \xi) \sim \sum_{n=1}^{\infty} \phi_n(x) \overline{\phi_n(\xi)}$$

**Result 25.10.1** If  $\{\phi_1, \phi_2, \dots\}$  is an orthogonal, complete set on the domain  $[a, b]$ , then

$$\sum_{n=1}^{\infty} \frac{\phi_n(x) \overline{\phi_n(\xi)}}{\|\phi_n\|^2} \sim \delta(x - \xi).$$

If the set is orthonormal, then

$$\sum_{n=1}^{\infty} \phi_n(x) \overline{\phi_n(\xi)} \sim \delta(x - \xi).$$

**Example 25.10.1** The integral of the Dirac delta function is the Heaviside function. On the interval  $x \in (-\pi, \pi)$

$$\int_{-\pi}^x \delta(t) dt = H(x) = \begin{cases} 1 & \text{for } 0 < x < \pi \\ 0 & \text{for } -\pi < x < 0. \end{cases}$$

Consider the orthonormal, complete set  $\{\dots, \frac{1}{\sqrt{2\pi}} e^{-inx}, \frac{1}{\sqrt{2\pi}}, \frac{1}{\sqrt{2\pi}} e^{inx}, \dots\}$  on the domain  $[-\pi, \pi]$ . The delta function has the series

$$\delta(t) \sim \sum_{n=-\infty}^{\infty} \frac{1}{\sqrt{2\pi}} e^{int} \frac{1}{\sqrt{2\pi}} e^{-in0} = \frac{1}{2\pi} \sum_{n=-\infty}^{\infty} e^{int}.$$

We will find the series expansion of the Heaviside function first by expanding directly and then by integrating the expansion for the delta function.

**Finding the series expansion of  $H(x)$  directly.** The generalized Fourier coefficients of  $H(x)$  are

$$\begin{aligned} c_0 &= \int_{-\pi}^{\pi} \frac{1}{\sqrt{2\pi}} H(x) dx \\ &= \frac{1}{\sqrt{2\pi}} \int_0^{\pi} dx \\ &= \sqrt{\frac{\pi}{2}} \\ c_n &= \int_{-\pi}^{\pi} \frac{1}{\sqrt{2\pi}} e^{-inx} H(x) dx \\ &= \frac{1}{\sqrt{2\pi}} \int_0^{\pi} e^{-inx} dx \\ &= \frac{1 - (-1)^n}{in\sqrt{2\pi}}. \end{aligned}$$

Thus the Heaviside function has the expansion

$$\begin{aligned}
 H(x) &\sim \sqrt{\frac{\pi}{2}} \frac{1}{\sqrt{2\pi}} + \sum_{\substack{n=-\infty \\ n \neq 0}}^{\infty} \frac{1 - (-1)^n}{in\sqrt{2\pi}} \frac{1}{\sqrt{2\pi}} e^{inx} \\
 &= \frac{1}{2} + \frac{1}{\pi} \sum_{n=1}^{\infty} \frac{1 - (-1)^n}{n} \sin(nx)
 \end{aligned}$$

$$H(x) \sim \frac{1}{2} + \frac{2}{\pi} \sum_{\substack{n=1 \\ \text{oddn}}}^{\infty} \frac{1}{n} \sin(nx).$$

Integrating the series for  $\delta(t)$ .

$$\begin{aligned}
 \int_{-\pi}^x \delta(t) dt &\sim \frac{1}{2\pi} \int_{-\pi}^x \sum_{n=-\infty}^{\infty} e^{int} dt \\
 &= \frac{1}{2\pi} \left( (x + \pi) + \sum_{\substack{n=-\infty \\ n \neq 0}}^{\infty} \left[ \frac{1}{in} e^{int} \right]_{-\pi}^x \right) \\
 &= \frac{1}{2\pi} \left( (x + \pi) + \sum_{\substack{n=-\infty \\ n \neq 0}}^{\infty} \frac{1}{in} (e^{inx} - (-1)^n) \right) \\
 &= \frac{x}{2\pi} + \frac{1}{2} + \frac{1}{2\pi} \sum_{n=1}^{\infty} \frac{1}{in} (e^{inx} - e^{-inx} - (-1)^n + (-1)^n) \\
 &= \frac{x}{2\pi} + \frac{1}{2} + \frac{1}{\pi} \sum_{n=1}^{\infty} \frac{1}{n} \sin(nx)
 \end{aligned}$$

Expanding  $\frac{x}{2\pi}$  in the orthonormal set,

$$\frac{x}{2\pi} \sim \sum_{n=-\infty}^{\infty} c_n \frac{1}{\sqrt{2\pi}} e^{inx}.$$

$$c_0 = \int_{-\pi}^{\pi} \frac{1}{\sqrt{2\pi}} \frac{x}{2\pi} dx = 0$$

$$c_n = \int_{-\pi}^{\pi} \frac{1}{\sqrt{2\pi}} e^{-inx} \frac{x}{2\pi} dx = \frac{i(-1)^n}{n\sqrt{2\pi}}$$

$$\frac{x}{2\pi} \sim \sum_{\substack{n=-\infty \\ n \neq 0}}^{\infty} \frac{i(-1)^n}{n\sqrt{2\pi}} \frac{1}{\sqrt{2\pi}} e^{inx} = -\frac{1}{\pi} \sum_{n=1}^{\infty} (-1)^n \sin(nx)$$

Substituting the series for  $\frac{x}{2\pi}$  into the expression for the integral of the delta function,

$$\int_{-\pi}^x \delta(t) dt \sim \frac{1}{2} + \frac{1}{\pi} \sum_{n=1}^{\infty} \frac{1 - (-1)^n}{n} \sin(nx)$$

$$\int_{-\pi}^x \delta(t) dt \sim \frac{1}{2} + \frac{2}{\pi} \sum_{\substack{n=1 \\ \text{oddn}}}^{\infty} \frac{1}{n} \sin(nx).$$

Thus we see that the series expansions of the Heaviside function and the integral of the delta function are the same.

## 25.11 Linear Operators

## 25.12 Exercises

### Exercise 25.1

1. Suppose  $\{\phi_k(x)\}_{k=0}^{\infty}$  is an orthogonal system on  $[a, b]$ . Show that any finite set of the  $\phi_j(x)$  is a linearly independent set on  $[a, b]$ . That is, if  $\{\phi_{j_1}(x), \phi_{j_2}(x), \dots, \phi_{j_n}(x)\}$  is the set and all the  $j_\nu$  are distinct, then

$$a_1\phi_{j_1}(x) + a_2\phi_{j_2}(x) + \cdots + a_n\phi_{j_n}(x) = 0 \quad \text{on} \quad a \leq x \leq b$$

is true iff:  $a_1 = a_2 = \cdots = a_n = 0$ .

2. Show that the complex functions  $\phi_k(x) \equiv e^{ik\pi x/L}$ ,  $k = 0, 1, 2, \dots$  are orthogonal in the sense that  $\int_{-L}^L \phi_k(x)\phi_n^*(x) dx = 0$ , for  $n \neq k$ . Here  $\phi_n^*(x)$  is the complex conjugate of  $\phi_n(x)$ .

Hint, Solution

## 25.13 Hints

### Hint 25.1



## 25.14 Solutions

### Solution 25.1

1.

$$a_1\phi_{j_1}(x) + a_2\phi_{j_2}(x) + \cdots + a_n\phi_{j_n}(x) = 0$$
$$\sum_{k=1}^n a_k\phi_{j_k}(x) = 0$$

We take the inner product with  $\phi_{j_\nu}$  for any  $\nu = 1, \dots, n$ . ( $\langle \phi, \psi \rangle \equiv \int_a^b \phi(x)\psi^*(x) dx$ .)

$$\left\langle \sum_{k=1}^n a_k\phi_{j_k}, \phi_{j_\nu} \right\rangle = 0$$

We interchange the order of summation and integration.

$$\sum_{k=1}^n a_k \langle \phi_{j_k}, \phi_{j_\nu} \rangle = 0$$

$\langle \phi_{j_k}, \phi_{j_\nu} \rangle = 0$  for  $j \neq \nu$ .

$$a_\nu \langle \phi_{j_\nu}, \phi_{j_\nu} \rangle = 0$$

$\langle \phi_{j_\nu}, \phi_{j_\nu} \rangle \neq 0$ .

$$a_\nu = 0$$

Thus we see that  $a_1 = a_2 = \cdots = a_n = 0$ .

2. For  $k \neq n$ ,  $\langle \phi_k, \phi_n \rangle = 0$ .

$$\begin{aligned}\langle \phi_k, \phi_n \rangle &\equiv \int_{-L}^L \phi_k(x) \phi_n^*(x) \, dx \\ &= \int_{-L}^L e^{ik\pi x/L} e^{-in\pi x/L} \, dx \\ &= \int_{-L}^L e^{i(k-n)\pi x/L} \, dx \\ &= \left[ \frac{e^{i(k-n)\pi x/L}}{i(k-n)\pi/L} \right]_{-L}^L \\ &= \frac{e^{i(k-n)\pi} - e^{-i(k-n)\pi}}{i(k-n)\pi/L} \\ &= \frac{2L \sin((k-n)\pi)}{(k-n)\pi} \\ &= 0\end{aligned}$$

# Chapter 26

## Self Adjoint Linear Operators

### 26.1 Adjoint Operators

The *adjoint* of an operator,  $L^*$ , satisfies

$$\langle v|Lu\rangle - \langle L^*v|u\rangle = 0$$

for all elements  $u$  and  $v$ . This is known as *Green's Identity*.

**The adjoint of a matrix.** For vectors, one can represent linear operators  $L$  with matrix multiplication.

$$Lx \equiv Ax$$

Let  $\mathbf{B} = \mathbf{A}^*$  be the adjoint of the matrix  $\mathbf{A}$ . We determine the adjoint of  $\mathbf{A}$  from Green's Identity.

$$\begin{aligned}\langle \mathbf{x} | \mathbf{A} \mathbf{y} \rangle - \langle \mathbf{B} \mathbf{x} | \mathbf{y} \rangle &= 0 \\ \bar{x} \cdot \mathbf{A} \mathbf{y} &= \overline{\mathbf{B} \mathbf{x}} \cdot \mathbf{y} \\ \bar{x}^T \mathbf{A} \mathbf{y} &= \overline{\mathbf{B} \mathbf{x}}^T \mathbf{y} \\ \bar{x}^T \mathbf{A} \mathbf{y} &= \bar{x}^T \overline{\mathbf{B}}^T \mathbf{y} \\ \bar{y}^T \overline{\mathbf{A}}^T \mathbf{x} &= \bar{y}^T \mathbf{B} \mathbf{x} = \overline{\mathbf{A}}^T\end{aligned}$$

Thus we see that the adjoint of a matrix is the *conjugate transpose* of the matrix,  $\mathbf{A}^* = \overline{\mathbf{A}}^T$ . The conjugate transpose is also called the *Hermitian transpose* and is denoted  $\mathbf{A}^H$ .

**The adjoint of a differential operator.** Consider a second order linear differential operator acting on  $C^2$  functions defined on  $(a \dots b)$  which satisfy certain boundary conditions.

$$Lu \equiv p_2(x)u'' + p_1(x)u' + p_0(x)u$$

## 26.2 Self-Adjoint Operators

**Matrices.** A matrix is self-adjoint if it is equal to its conjugate transpose  $\mathbf{A} = \mathbf{A}^H \equiv \overline{\mathbf{A}}^T$ . Such matrices are called *Hermitian*. For a Hermitian matrix  $\mathbf{H}$ , Green's identity is

$$\begin{aligned}\langle \mathbf{y} | \mathbf{H} \mathbf{x} \rangle &= \langle \mathbf{H} \mathbf{y} | \mathbf{x} \rangle \\ \bar{y} \cdot \mathbf{H} \mathbf{x} &= \overline{\mathbf{H} \mathbf{y}} \cdot \mathbf{x}\end{aligned}$$

The eigenvalues of a Hermitian matrix are real. Let  $\mathbf{x}$  be an eigenvector with eigenvalue  $\lambda$ .

$$\begin{aligned}\langle \mathbf{x} | \mathbf{H} \mathbf{x} \rangle &= \langle \mathbf{H} \mathbf{x} | \mathbf{x} \rangle \\ \langle \mathbf{x} | \lambda \mathbf{x} \rangle - \langle \lambda \mathbf{x} | \mathbf{x} \rangle &= 0 \\ (\lambda - \bar{\lambda}) \langle \mathbf{x} | \mathbf{x} \rangle &= 0 \\ \lambda &= \bar{\lambda}\end{aligned}$$

The eigenvectors corresponding to distinct eigenvalues are distinct. Let  $\mathbf{x}$  and  $\mathbf{y}$  be eigenvectors with distinct eigenvalues  $\lambda$  and  $\mu$ .

$$\begin{aligned}\langle \mathbf{y} | \mathbf{H} \mathbf{x} \rangle &= \langle \mathbf{H} \mathbf{y} | \mathbf{x} \rangle \\ \langle \mathbf{y} | \lambda \mathbf{x} \rangle - \langle \mu \mathbf{y} | \mathbf{x} \rangle &= 0 \\ (\lambda - \bar{\mu}) \langle \mathbf{y} | \lambda \mathbf{x} \rangle &= 0 \\ (\lambda - \mu) \langle \mathbf{y} | \mathbf{x} \rangle &= 0 \\ \langle \mathbf{y} | \mathbf{x} \rangle &= 0\end{aligned}$$

Furthermore, all Hermitian matrices are similar to a diagonal matrix and have a complete set of orthogonal eigenvectors.

**Trigonometric Series.** Consider the problem

$$-y'' = \lambda y, \quad y(0) = y(2\pi), \quad y'(0) = y'(2\pi).$$

We verify that the differential operator  $L = -\frac{d^2}{dx^2}$  with periodic boundary conditions is self-adjoint.

$$\begin{aligned}\langle v|Lu\rangle &= \langle v|-u''\rangle \\ &= [-\bar{v}u']_0^{2\pi} - \langle v'| -u'\rangle \\ &= \langle v'|u'\rangle \\ &= [\bar{v}'u]_0^{2\pi} - \langle v''|u\rangle \\ &= \langle -v''|u\rangle \\ &= \langle Lv|u\rangle\end{aligned}$$

The eigenvalues and eigenfunctions of this problem are

$$\lambda_0 = 0, \quad \phi_0 = 1$$
$$\lambda_n = n^2, \quad \phi_n^{(1)} = \cos(nx), \quad \phi_n^{(2)} = \sin(nx), \quad n \in \mathbb{Z}^+$$

## 26.3 Exercises

## 26.4 Hints



## 26.5 Solutions

# Chapter 27

## Self-Adjoint Boundary Value Problems

Seize the day and throttle it.

-Calvin

### 27.1 Summary of Adjoint Operators

The adjoint of the operator

$$L[y] = p_n \frac{d^n y}{dx^n} + p_{n-1} \frac{d^{n-1} y}{dx^{n-1}} + \cdots + p_0 y,$$

is defined

$$L^*[y] = (-1)^n \frac{d^n}{dx^n} (\overline{p_n} y) + (-1)^{n-1} \frac{d^{n-1}}{dx^{n-1}} (\overline{p_{n-1}} y) + \cdots + \overline{p_0} y$$

If each of the  $p_k$  is  $k$  times continuously differentiable and  $u$  and  $v$  are  $n$  times continuously differentiable on some interval, then on that interval Lagrange's identity states

$$\overline{v}L[u] - u\overline{L^*[v]} = \frac{d}{dx}B[u, v]$$

where  $B[u, v]$  is the bilinear form

$$B[u, v] = \sum_{m=1}^n \sum_{\substack{j+k=m-1 \\ j \geq 0, k \geq 0}} (-1)^j u^{(k)} (p_m \bar{v})^{(j)}.$$

If  $L$  is a second order operator then

$$\bar{v}L[u] - u\overline{L^*[v]} = u''p_2\bar{v} + u'p_1\bar{v} + u[-p_2\bar{v}'' + (-2p_2' + p_1)\bar{v}' + (-p_2'' + p_1')\bar{v}].$$

Integrating Lagrange's identity on its interval of validity gives us Green's formula.

$$\int_a^b (\bar{v}L[u] - u\overline{L^*[v]}) dx = \langle v|L[u] \rangle - \langle L^*[v]|u \rangle = B[u, v] \Big|_{x=b} - B[u, v] \Big|_{x=a}$$

## 27.2 Formally Self-Adjoint Operators

**Example 27.2.1** *The linear operator*

$$L[y] = x^2y'' + 2xy' + 3y$$

*has the adjoint operator*

$$\begin{aligned} L^*[y] &= \frac{d^2}{dx^2}(x^2y) - \frac{d}{dx}(2xy) + 3y \\ &= x^2y'' + 4xy' + 2y - 2xy' - 2y + 3y \\ &= x^2y'' + 2xy' + 3y. \end{aligned}$$

In Example 27.2.1, the adjoint operator is the same as the operator. If  $L = L^*$ , the operator is said to be **formally self-adjoint**.

Most of the differential equations that we study in this book are second order, formally self-adjoint, with real-valued coefficient functions. Thus we wish to find the general form of this operator. Consider the operator

$$L[y] = p_2 y'' + p_1 y' + p_0 y,$$

where the  $p_j$ 's are real-valued functions. The adjoint operator then is

$$\begin{aligned} L^*[y] &= \frac{d^2}{dx^2}(p_2 y) - \frac{d}{dx}(p_1 y) + p_0 y \\ &= p_2 y'' + 2p_2' y' + p_2'' y - p_1 y' - p_1' y + p_0 y \\ &= p_2 y'' + (2p_2' - p_1) y' + (p_2'' - p_1' + p_0) y. \end{aligned}$$

Equating  $L$  and  $L^*$  yields the two equations,

$$\begin{aligned} 2p_2' - p_1 &= p_1, & p_2'' - p_1' + p_0 &= p_0 \\ p_2' &= p_1, & p_2'' &= p_1'. \end{aligned}$$

Thus second order, formally self-adjoint operators with real-valued coefficient functions have the form

$$L[y] = p_2 y'' + p_2' y' + p_0 y,$$

which is equivalent to the form

$$L[y] = \frac{d}{dx}(p y') + q y.$$

Any linear differential equation of the form

$$L[y] = y'' + p_1 y' + p_0 y = f(x),$$

where each  $p_j$  is  $j$  times continuously differentiable and real-valued, can be written as a formally self adjoint equation. We just multiply by the factor,

$$e^{P(x)} = \exp\left(\int^x p_1(\xi) d\xi\right)$$

to obtain

$$\begin{aligned}\exp [P(x)]\left(y''+p_1 y'+p_0 y\right) &= \exp [P(x)] f(x) \\ \frac{d}{d x}\left(\exp [P(x)] y'\right) &+ \exp [P(x)] p_0 y = \exp [P(x)] f(x).\end{aligned}$$

**Example 27.2.2** Consider the equation

$$y'' + \frac{1}{x} y' + y = 0.$$

Multiplying by the factor

$$\exp \left(\int^x \frac{1}{\xi} d \xi\right) = e^{\log x} = x$$

will make the equation formally self-adjoint.

$$\begin{aligned}x y'' + y' + x y &= 0 \\ \frac{d}{d x}(x y') + x y &= 0\end{aligned}$$

**Result 27.2.1** If  $L = L^*$  then the linear operator  $L$  is formally self-adjoint. Second order formally self-adjoint operators have the form

$$L[y] = \frac{d}{d x}(p y') + q y.$$

Any differential equation of the form

$$L[y] = y'' + p_1 y' + p_0 y = f(x),$$

where each  $p_j$  is  $j$  times continuously differentiable and real-valued, can be written as a formally self adjoint equation by multiplying the equation by the factor  $\exp\left(\int^x p_1(\xi) d \xi\right)$ .

## 27.3 Self-Adjoint Problems

Consider the  $n^{\text{th}}$  order formally self-adjoint equation  $L[y] = 0$ , on the domain  $a \leq x \leq b$  subject to the boundary conditions,  $B_j[y] = 0$  for  $j = 1, \dots, n$ . where the boundary conditions can be written

$$B_j[y] = \sum_{k=1}^n \alpha_{jk} y^{(k-1)}(a) + \beta_{jk} y^{(k-1)}(b) = 0.$$

If the boundary conditions are such that Green's formula reduces to

$$\langle v | L[u] \rangle - \langle L[v] | u \rangle = 0$$

then the problem is **self-adjoint**

**Example 27.3.1** Consider the formally self-adjoint equation  $-y'' = 0$ , subject to the boundary conditions  $y(0) = y(\pi) = 0$ . Green's formula is

$$\begin{aligned} \langle v | -u'' \rangle - \langle -v'' | u \rangle &= [u'(-\bar{v}) - u(-\bar{v})']_0^\pi \\ &= [u\bar{v}' - u'\bar{v}]_0^\pi \\ &= 0. \end{aligned}$$

Thus this problem is self-adjoint.

## 27.4 Self-Adjoint Eigenvalue Problems

Associated with the self-adjoint problem

$$L[y] = 0, \quad \text{subject to} \quad B_j[y] = 0,$$

is the eigenvalue problem

$$L[y] = \lambda y, \quad \text{subject to} \quad B_j[y] = 0.$$

This is called a self-adjoint eigenvalue problem. The values of  $\lambda$  for which there exist nontrivial solutions to this problem are called eigenvalues. The functions that satisfy the equation when  $\lambda$  is an eigenvalue are called eigenfunctions.

**Example 27.4.1** Consider the self-adjoint eigenvalue problem

$$-y'' = \lambda y, \quad \text{subject to } y(0) = y(\pi) = 0.$$

First consider the case  $\lambda = 0$ . The general solution is

$$y = c_1 + c_2 x.$$

Only the trivial solution satisfies the boundary conditions.  $\lambda = 0$  is not an eigenvalue. Now consider  $\lambda \neq 0$ . The general solution is

$$y = c_1 \cos(\sqrt{\lambda}x) + c_2 \sin(\sqrt{\lambda}x).$$

The solution that satisfies the left boundary condition is

$$y = c \sin(\sqrt{\lambda}x).$$

For non-trivial solutions, we must have

$$\sin(\sqrt{\lambda}\pi) = 0,$$

$$\lambda = n^2, \quad n \in \mathbb{N}.$$

Thus the eigenvalues  $\lambda_n$  and eigenfunctions  $\phi_n$  are

$\lambda_n = n^2, \quad \phi_n = \sin(nx), \quad \text{for } n = 1, 2, 3, \dots$
--

Self-adjoint eigenvalue problems have a number of interesting properties. We will devote the rest of this section to developing some of these properties.

**Real Eigenvalues.** The eigenvalues of a self-adjoint problem are real. Let  $\lambda$  be an eigenvalue with the eigenfunction  $\phi$ . Green's formula states

$$\langle \phi | L[\phi] \rangle - \langle L[\phi] | \phi \rangle = 0$$

$$\langle \phi | \lambda \phi \rangle - \langle \lambda \phi | \phi \rangle = 0$$

$$(\lambda - \bar{\lambda}) \langle \phi | \phi \rangle = 0$$

Since  $\phi \neq 0$ ,  $\langle \phi | \phi \rangle > 0$ . Thus  $\lambda = \bar{\lambda}$  and  $\lambda$  is real.

**Orthogonal Eigenfunctions.** The eigenfunctions corresponding to distinct eigenvalues are orthogonal. Let  $\lambda_n$  and  $\lambda_m$  be distinct eigenvalues with the eigenfunctions  $\phi_n$  and  $\phi_m$ . Using Green's formula,

$$\begin{aligned}\langle \phi_n | L[\phi_m] \rangle - \langle L[\phi_n] | \phi_m \rangle &= 0 \\ \langle \phi_n | \lambda_m \phi_m \rangle - \langle \lambda_n \phi_n | \phi_m \rangle &= 0 \\ (\lambda_m - \bar{\lambda}_n) \langle \phi_n | \phi_m \rangle &= 0.\end{aligned}$$

Since the eigenvalues are real,

$$(\lambda_m - \lambda_n) \langle \phi_n | \phi_m \rangle = 0.$$

Since the two eigenvalues are distinct,  $\langle \phi_n | \phi_m \rangle = 0$  and thus  $\phi_n$  and  $\phi_m$  are orthogonal.

**\*Enumerable Set of Eigenvalues.** The eigenvalues of a self-adjoint eigenvalue problem form an enumerable set with no finite cluster point. Consider the problem

$$L[y] = \lambda y \text{ on } a \leq x \leq b, \quad \text{subject to } B_j[y] = 0.$$

Let  $\{\psi_1, \psi_2, \dots, \psi_n\}$  be a fundamental set of solutions at  $x = x_0$  for some  $a \leq x_0 \leq b$ . That is,

$$\psi_j^{(k-1)}(x_0) = \delta_{jk}.$$

The key to showing that the eigenvalues are enumerable, is that the  $\psi_j$  are entire functions of  $\lambda$ . That is, they are analytic functions of  $\lambda$  for all finite  $\lambda$ . We will not prove this.

The boundary conditions are

$$B_j[y] = \sum_{k=1}^n [\alpha_{jk} y^{(k-1)}(a) + \beta_{jk} y^{(k-1)}(b)] = 0.$$

The eigenvalue problem has a solution for a given value of  $\lambda$  if  $y = \sum_{k=1}^n c_k \psi_k$  satisfies the boundary conditions. That is,

$$B_j \left[ \sum_{k=1}^n c_k \psi_k \right] = \sum_{k=1}^n c_k B_j[\psi_k] = 0 \quad \text{for } j = 1, \dots, n.$$



Define an  $n \times n$  matrix  $M$  such that  $M_{jk} = B_k[\psi_j]$ . Then if  $\vec{c} = (c_1, c_2, \dots, c_n)$ , the boundary conditions can be written in terms of the matrix equation  $M\vec{c} = 0$ . This equation has a solution if and only if the determinant of the matrix is zero. Since the  $\psi_j$  are entire functions of  $\lambda$ ,  $\Delta[M]$  is an entire function of  $\lambda$ . The eigenvalues are real, so  $\Delta[M]$  has only real roots. Since  $\Delta[M]$  is an entire function, (that is not identically zero), with only real roots, the roots of  $\Delta[M]$  can only cluster at infinity. Thus the eigenvalues of a self-adjoint problem are enumerable and can only cluster at infinity.

An example of a function whose roots have a finite cluster point is  $\sin(1/x)$ . This function, (graphed in Figure 27.1), is clearly not analytic at the cluster point  $x = 0$ .

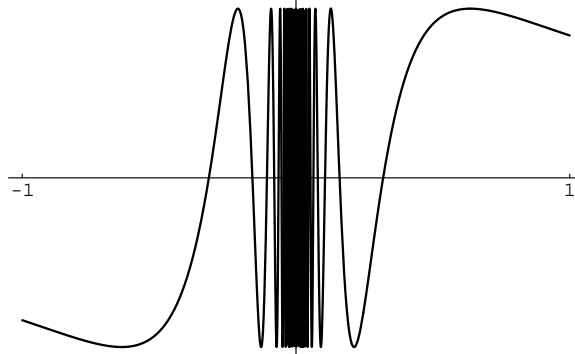

Figure 27.1: Graph of  $\sin(1/x)$ .

**Infinite Number of Eigenvalues.** Though we will not show it, self-adjoint problems have an infinite number of eigenvalues. Thus the eigenfunctions form an infinite orthogonal set.

**Eigenvalues of Second Order Problems.** Consider the second order, self-adjoint eigenvalue problem

$$L[y] = (py')' + qy = \lambda y, \quad \text{on } a \leq x \leq b, \quad \text{subject to } B_j[y] = 0.$$

Let  $\lambda_n$  be an eigenvalue with the eigenfunction  $\phi_n$ .

$$\begin{aligned} \langle \phi_n | L[\phi_n] \rangle &= \langle \phi_n | \lambda_n \phi_n \rangle \\ \langle \phi_n | (p\phi_n')' + q\phi_n \rangle &= \lambda_n \langle \phi_n | \phi_n \rangle \\ \int_a^b \overline{\phi_n} (p\phi_n')' dx + \langle \phi_n | q | \phi_n \rangle &= \lambda_n \langle \phi_n | \phi_n \rangle \\ [\overline{\phi_n} p \phi_n']_a^b - \int_a^b \overline{\phi_n}' p \phi_n' dx + \langle \phi_n | q | \phi_n \rangle &= \lambda_n \langle \phi_n | \phi_n \rangle \\ \lambda_n &= \frac{[p \overline{\phi_n} \phi_n']_a^b - \langle \phi_n' | p | \phi_n' \rangle + \langle \phi_n | q | \phi_n \rangle}{\langle \phi_n | \phi_n \rangle} \end{aligned}$$

Thus we can express each eigenvalue in terms of its eigenfunction. You might think that this formula is just a shade less than worthless. When solving an eigenvalue problem you have to find the eigenvalues before you determine the eigenfunctions. Thus this formula could not be used to compute the eigenvalues. However, we can often use the formula to obtain information about the eigenvalues before we solve a problem.

**Example 27.4.2** Consider the self-adjoint eigenvalue problem

$$-y'' = \lambda y, \quad y(0) = y(\pi) = 0.$$

The eigenvalues are given by the formula

$$\begin{aligned}\lambda_n &= \frac{[(-1)\bar{\phi}\phi']_a^b - \langle \phi'_n | (-1) | \phi'_n \rangle + \langle \phi_n | 0 | \phi_n \rangle}{\langle \phi_n | \phi_n \rangle} \\ &= \frac{0 + \langle \phi'_n | \phi'_n \rangle + 0}{\langle \phi_n | \phi_n \rangle}.\end{aligned}$$

We see that  $\lambda_n \geq 0$ . If  $\lambda_n = 0$  then  $\langle \phi'_n | \phi'_n \rangle = 0$ , which implies that  $\phi_n = \text{const}$ . The only constant that satisfies the boundary conditions is  $\phi_n = 0$  which is not an eigenfunction since it is the trivial solution. Thus the eigenvalues are positive.

## 27.5 Inhomogeneous Equations

Let the problem,

$$L[y] = 0, \quad B_k[y] = 0,$$

be self-adjoint. If the inhomogeneous problem,

$$L[y] = f, \quad B_k[y] = 0,$$

has a solution, then we we can write this solution in terms of the eigenfunction of the associated eigenvalue problem,

$$L[y] = \lambda y, \quad B_k[y] = 0.$$

We denote the eigenvalues as  $\lambda_n$  and the eigenfunctions as  $\phi_n$  for  $n \in \mathbb{Z}^+$ . For the moment we assume that  $\lambda = 0$  is not an eigenvalue and that the eigenfunctions are real-valued. We expand the function  $f(x)$  in a series of the eigenfunctions.

$$f(x) = \sum f_n \phi_n(x), \quad f_n = \frac{\langle \phi_n | f \rangle}{\|\phi_n\|}$$

We expand the inhomogeneous solution in a series of eigenfunctions and substitute it into the differential equation.

$$\begin{aligned}L[y] &= f \\L\left[\sum y_n\phi_n(x)\right] &= \sum f_n\phi_n(x) \\ \sum \lambda_n y_n\phi_n(x) &= \sum f_n\phi_n(x) \\ y_n &= \frac{f_n}{\lambda_n}\end{aligned}$$

The inhomogeneous solution is

$$y(x) = \sum \frac{\langle \phi_n | f \rangle}{\lambda_n \|\phi_n\|} \phi_n(x). \quad (27.1)$$

As a special case we consider the Green function problem,

$$L[G] = \delta(x - \xi), \quad B_k[G] = 0,$$

We expand the Dirac delta function in an eigenfunction series.

$$\delta(x - \xi) = \sum \frac{\langle \phi_n | \delta \rangle}{\|\phi_n\|} \phi_n(x) = \sum \frac{\phi_n(\xi)\phi_n(x)}{\|\phi_n\|}$$

The Green function is

$$G(x|\xi) = \sum \frac{\phi_n(\xi)\phi_n(x)}{\lambda_n \|\phi_n\|}.$$

We corroborate Equation 27.1 by solving the inhomogeneous equation in terms of the Green function.

$$\begin{aligned}
 y &= \int_a^b G(x|\xi) f(\xi) \, d\xi \\
 y &= \int_a^b \sum \frac{\phi_n(\xi)\phi_n(x)}{\lambda_n \|\phi_n\|} f(\xi) \, d\xi \\
 y &= \sum \frac{\int_a^b \phi_n(\xi) f(\xi) \, d\xi}{\lambda_n \|\phi_n\|} \phi_n(x) \\
 y &= \sum \frac{\langle \phi_n | f \rangle}{\lambda_n \|\phi_n\|} \phi_n(x)
 \end{aligned}$$

**Example 27.5.1** Consider the Green function problem

$$G'' + G = \delta(x - \xi), \quad G(0|\xi) = G(1|\xi) = 0.$$

First we examine the associated eigenvalue problem.

$$\begin{aligned}
 \phi'' + \phi &= \lambda\phi, & \phi(0) &= \phi(1) = 0 \\
 \phi'' + (1 - \lambda)\phi &= 0, & \phi(0) &= \phi(1) = 0 \\
 \lambda_n &= 1 - (n\pi)^2, & \phi_n &= \sin(n\pi x), \quad n \in \mathbb{Z}^+
 \end{aligned}$$

We write the Green function as a series of the eigenfunctions.

$$G(x|\xi) = 2 \sum_{n=1}^{\infty} \frac{\sin(n\pi\xi) \sin(n\pi x)}{1 - (n\pi)^2}$$

## 27.6 Exercises

### Exercise 27.1

Show that the operator adjoint to

$$Ly = y^{(n)} + p_1(z)y^{(n-1)} + p_2(z)y^{(n-2)} + \cdots + p_n(z)y$$

is given by

$$My = (-1)^n u^{(n)} + (-1)^{n-1} \overline{p_1(z)} u^{(n-1)} + (-1)^{n-2} \overline{p_2(z)} u^{(n-2)} + \cdots + \overline{p_n(z)} u.$$

Hint, Solution

## 27.7 Hints

### Hint 27.1

## 27.8 Solutions

### Solution 27.1

Consider  $u(x), v(x) \in C^n$ . ( $C^n$  is the set of  $n$  times continuously differentiable functions). First we prove the preliminary result

$$uv^{(n)} - (-1)^n u^{(n)}v = \frac{d}{dx} \sum_{k=0}^{n-1} (-1)^k u^{(k)} v^{(n-k-1)} \quad (27.2)$$

by simplifying the right side.

$$\begin{aligned} \frac{d}{dx} \sum_{k=0}^{n-1} (-1)^k u^{(k)} v^{(n-k-1)} &= \sum_{k=0}^{n-1} (-1)^k \left( u^{(k)} v^{(n-k)} + u^{(k+1)} v^{(n-k-1)} \right) \\ &= \sum_{k=0}^{n-1} (-1)^k u^{(k)} v^{(n-k)} - \sum_{k=0}^{n-1} (-1)^{k+1} u^{(k+1)} v^{(n-k-1)} \\ &= \sum_{k=0}^{n-1} (-1)^k u^{(k)} v^{(n-k)} - \sum_{k=1}^n (-1)^k u^{(k)} v^{(n-k)} \\ &= (-1)^0 u^{(0)} v^{(n-0)} - (-1)^n u^{(n)} v^{(n-n)} \\ &= uv^{(n)} - (-1)^n u^{(n)}v \end{aligned}$$

We define  $p_0(x) = 1$  so that we can write the operators in a nice form.

$$Ly = \sum_{m=0}^n p_m(z) y^{(n-m)}, \quad Mu = \sum_{m=0}^n (-1)^m \overline{(p_m(z)u)}^{(n-m)}$$

Now we show that  $M$  is the adjoint to  $L$ .

$$\begin{aligned} \bar{u}Ly - y\overline{Mu} &= \bar{u} \sum_{m=0}^n p_m(z) y^{(n-m)} - y \sum_{m=0}^n (-1)^m \overline{(p_m(z)u)}^{(n-m)} \\ &= \sum_{m=0}^n \left( \bar{u} p_m(z) y^{(n-m)} - (p_m(z)\bar{u})^{(n-m)} y \right) \end{aligned}$$



We use Equation 27.2.

$$= \sum_{m=0}^n \frac{d}{dz} \sum_{k=0}^{n-m-1} (-1)^k (\bar{u}p_m(z))^{(k)} y^{(n-m-k-1)}$$

$$\bar{u}Ly - y\overline{Mu} = \frac{d}{dz} \sum_{m=0}^n \sum_{k=0}^{n-m-1} (-1)^k (\bar{u}p_m(z))^{(k)} y^{(n-m-k-1)}$$

# Chapter 28

## Fourier Series

Every time I close my eyes  
The noise inside me amplifies  
I can't escape  
I relive every moment of the day  
Every misstep I have made  
Finds a way it can invade  
My every thought  
And this is why I find myself awake

*-Failure*

-Tom Shear (Assemblage 23)

### 28.1 An Eigenvalue Problem.

A self adjoint eigenvalue problem. Consider the eigenvalue problem

$$y'' + \lambda y = 0, \quad y(-\pi) = y(\pi), \quad y'(-\pi) = y'(\pi).$$

We rewrite the equation so the eigenvalue is on the right side.

$$L[y] \equiv -y'' = \lambda y$$

We demonstrate that this eigenvalue problem is self adjoint.

$$\begin{aligned} \langle v|L[u] \rangle - \langle L[v]|u \rangle &= \langle v| -u'' \rangle - \langle -v''|u \rangle \\ &= [-\bar{v}u']_{-\pi}^{\pi} + \langle v'|u' \rangle - [-\bar{v}'u]_{-\pi}^{\pi} - \langle v'|u' \rangle \\ &= -\overline{v(\pi)}u'(\pi) + \overline{v(-\pi)}u'(-\pi) + \overline{v'(\pi)}u(\pi) - \overline{v'(-\pi)}u(-\pi) \\ &= -\overline{v(\pi)}u'(\pi) + \overline{v(\pi)}u'(\pi) + \overline{v'(\pi)}u(\pi) - \overline{v'(\pi)}u(\pi) \\ &= 0 \end{aligned}$$

Since Green's Identity reduces to  $\langle v|L[u] \rangle - \langle L[v]|u \rangle = 0$ , the problem is self adjoint. This means that the eigenvalues are real and that eigenfunctions corresponding to distinct eigenvalues are orthogonal. We compute the Rayleigh quotient for an eigenvalue  $\lambda$  with eigenfunction  $\phi$ .

$$\begin{aligned} \lambda &= \frac{-[\bar{\phi}\phi']_{-\pi}^{\pi} + \langle \phi'|\phi' \rangle}{\langle \phi|\phi \rangle} \\ &= \frac{-\overline{\phi(\pi)}\phi'(\pi) + \overline{\phi(-\pi)}\phi'(-\pi) + \langle \phi'|\phi' \rangle}{\langle \phi|\phi \rangle} \\ &= \frac{-\overline{\phi(\pi)}\phi'(\pi) + \overline{\phi(\pi)}\phi'(\pi) + \langle \phi'|\phi' \rangle}{\langle \phi|\phi \rangle} \\ &= \frac{\langle \phi'|\phi' \rangle}{\langle \phi|\phi \rangle} \end{aligned}$$

We see that the eigenvalues are non-negative.

**Computing the eigenvalues and eigenfunctions.** Now we find the eigenvalues and eigenfunctions. First we consider the case  $\lambda = 0$ . The general solution of the differential equation is

$$y = c_1 + c_2x.$$

The solution that satisfies the boundary conditions is  $y = \text{const}$ .

Now consider  $\lambda > 0$ . The general solution of the differential equation is

$$y = c_1 \cos(\sqrt{\lambda}x) + c_2 \sin(\sqrt{\lambda}x).$$

We apply the first boundary condition.

$$\begin{aligned}y(-\pi) &= y(\pi) \\c_1 \cos(-\sqrt{\lambda}\pi) + c_2 \sin(-\sqrt{\lambda}\pi) &= c_1 \cos(\sqrt{\lambda}\pi) + c_2 \sin(\sqrt{\lambda}\pi) \\c_1 \cos(\sqrt{\lambda}\pi) - c_2 \sin(\sqrt{\lambda}\pi) &= c_1 \cos(\sqrt{\lambda}\pi) + c_2 \sin(\sqrt{\lambda}\pi) \\c_2 \sin(\sqrt{\lambda}\pi) &= 0\end{aligned}$$

Then we apply the second boundary condition.

$$\begin{aligned}y'(-\pi) &= y'(\pi) \\-c_1 \sqrt{\lambda} \sin(-\sqrt{\lambda}\pi) + c_2 \sqrt{\lambda} \cos(-\sqrt{\lambda}\pi) &= -c_1 \sqrt{\lambda} \sin(\sqrt{\lambda}\pi) + c_2 \sqrt{\lambda} \cos(\sqrt{\lambda}\pi) \\c_1 \sin(\sqrt{\lambda}\pi) + c_2 \cos(\sqrt{\lambda}\pi) &= -c_1 \sin(\sqrt{\lambda}\pi) + c_2 \cos(\sqrt{\lambda}\pi) \\c_1 \sin(\sqrt{\lambda}\pi) &= 0\end{aligned}$$

To satisfy the two boundary conditions either  $c_1 = c_2 = 0$  or  $\sin(\sqrt{\lambda}\pi) = 0$ . The former yields the trivial solution.

The latter gives us the eigenvalues  $\lambda_n = n^2$ ,  $n \in \mathbb{Z}^+$ . The corresponding solution is

$$y_n = c_1 \cos(nx) + c_2 \sin(nx).$$

There are two eigenfunctions for each of the positive eigenvalues.

We choose the eigenvalues and eigenfunctions.

$$\begin{aligned}\lambda_0 &= 0, & \phi_0 &= \frac{1}{2} \\ \lambda_n &= n^2, & \phi_{2n-1} &= \cos(nx), & \phi_{2n} &= \sin(nx), & \text{for } n = 1, 2, 3, \dots\end{aligned}$$

**Orthogonality of Eigenfunctions.** We know that the eigenfunctions of distinct eigenvalues are orthogonal. In addition, the two eigenfunctions of each positive eigenvalue are orthogonal.

$$\int_{-\pi}^{\pi} \cos(nx) \sin(nx) \, dx = \left[ \frac{1}{2n} \sin^2(nx) \right]_{-\pi}^{\pi} = 0$$

Thus the eigenfunctions  $\{\frac{1}{2}, \cos(x), \sin(x), \cos(2x), \sin(2x)\}$  are an orthogonal set.

## 28.2 Fourier Series.

A series of the eigenfunctions

$$\phi_0 = \frac{1}{2}, \quad \phi_n^{(1)} = \cos(nx), \quad \phi_n^{(2)} = \sin(nx), \quad \text{for } n \geq 1$$

is

$$\frac{1}{2}a_0 + \sum_{n=1}^{\infty} (a_n \cos(nx) + b_n \sin(nx)).$$

This is known as a *Fourier series*. (We choose  $\phi_0 = \frac{1}{2}$  so all of the eigenfunctions have the same norm.) A fairly general class of functions can be expanded in Fourier series. Let  $f(x)$  be a function defined on  $-\pi < x < \pi$ . Assume that  $f(x)$  can be expanded in a Fourier series

$$f(x) \sim \frac{1}{2}a_0 + \sum_{n=1}^{\infty} (a_n \cos(nx) + b_n \sin(nx)). \tag{28.1}$$

Here the “ $\sim$ ” means “has the Fourier series”. We have not said if the series converges yet. For now let’s assume that the series converges uniformly so we can replace the  $\sim$  with an  $=$ .

We integrate Equation 28.1 from  $-\pi$  to  $\pi$  to determine  $a_0$ .

$$\int_{-\pi}^{\pi} f(x) dx = \frac{1}{2}a_0 \int_{-\pi}^{\pi} dx + \int_{-\pi}^{\pi} \sum_{n=1}^{\infty} a_n \cos(nx) + b_n \sin(nx) dx$$

$$\int_{-\pi}^{\pi} f(x) dx = \pi a_0 + \sum_{n=1}^{\infty} \left( a_n \int_{-\pi}^{\pi} \cos(nx) dx + b_n \int_{-\pi}^{\pi} \sin(nx) dx \right)$$

$$\int_{-\pi}^{\pi} f(x) dx = \pi a_0$$

$$a_0 = \frac{1}{\pi} \int_{-\pi}^{\pi} f(x) dx$$

Multiplying by  $\cos(mx)$  and integrating will enable us to solve for  $a_m$ .

$$\int_{-\pi}^{\pi} f(x) \cos(mx) dx = \frac{1}{2}a_0 \int_{-\pi}^{\pi} \cos(mx) dx$$

$$+ \sum_{n=1}^{\infty} \left( a_n \int_{-\pi}^{\pi} \cos(nx) \cos(mx) dx + b_n \int_{-\pi}^{\pi} \sin(nx) \cos(mx) dx \right)$$

All but one of the terms on the right side vanishes due to the orthogonality of the eigenfunctions.

$$\int_{-\pi}^{\pi} f(x) \cos(mx) dx = a_m \int_{-\pi}^{\pi} \cos(mx) \cos(mx) dx$$

$$\int_{-\pi}^{\pi} f(x) \cos(mx) dx = a_m \int_{-\pi}^{\pi} \left( \frac{1}{2} + \cos(2mx) \right) dx$$

$$\int_{-\pi}^{\pi} f(x) \cos(mx) dx = \pi a_m$$

$$a_m = \frac{1}{\pi} \int_{-\pi}^{\pi} f(x) \cos(mx) dx.$$

Note that this formula is valid for  $m = 0, 1, 2, \dots$

Similarly, we can multiply by  $\sin(mx)$  and integrate to solve for  $b_m$ . The result is

$$b_m = \frac{1}{\pi} \int_{-\pi}^{\pi} f(x) \sin(mx) dx.$$

$a_n$  and  $b_n$  are called *Fourier coefficients*.

Although we will not show it, Fourier series converge for a fairly general class of functions. Let  $f(x^-)$  denote the left limit of  $f(x)$  and  $f(x^+)$  denote the right limit.

**Example 28.2.1** For the function defined

$$f(x) = \begin{cases} 0 & \text{for } x < 0, \\ x + 1 & \text{for } x \geq 0, \end{cases}$$

the left and right limits at  $x = 0$  are

$$f(0^-) = 0, \quad f(0^+) = 1.$$

**Result 28.2.1** Let  $f(x)$  be a  $2\pi$ -periodic function for which  $\int_{-\pi}^{\pi} |f(x)| dx$  exists. Define the Fourier coefficients

$$a_n = \frac{1}{\pi} \int_{-\pi}^{\pi} f(x) \cos(nx) dx, \quad b_n = \frac{1}{\pi} \int_{-\pi}^{\pi} f(x) \sin(nx) dx.$$

If  $x$  is an interior point of an interval on which  $f(x)$  has limited total fluctuation, then the Fourier series of  $f(x)$

$$\frac{a_0}{2} + \sum_{n=1}^{\infty} (a_n \cos(nx) + b_n \sin(nx)),$$

converges to  $\frac{1}{2}(f(x^-) + f(x^+))$ . If  $f$  is continuous at  $x$ , then the series converges to  $f(x)$ .

**Periodic Extension of a Function.** Let  $g(x)$  be a function that is arbitrarily defined on  $-\pi \leq x < \pi$ . The Fourier series of  $g(x)$  will represent the periodic extension of  $g(x)$ . The periodic extension,  $f(x)$ , is defined by the two conditions:

$$\begin{aligned} f(x) &= g(x) \quad \text{for } -\pi \leq x < \pi, \\ f(x + 2\pi) &= f(x). \end{aligned}$$

The periodic extension of  $g(x) = x^2$  is shown in Figure 28.1.

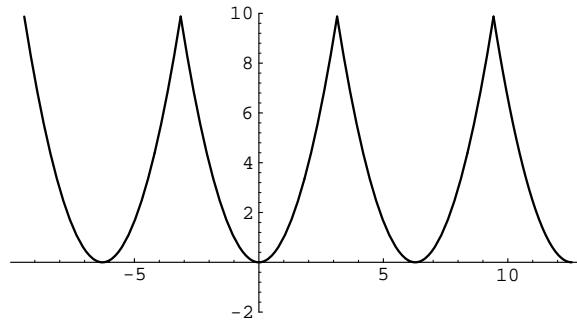

Figure 28.1: The Periodic Extension of  $g(x) = x^2$ .

**Limited Fluctuation.** A function that has limited total fluctuation can be written  $f(x) = \psi_+(x) - \psi_-(x)$ , where  $\psi_+$  and  $\psi_-$  are bounded, nondecreasing functions. An example of a function that does not have limited total fluctuation



is  $\sin(1/x)$ , whose fluctuation is unlimited at the point  $x = 0$ .

**Functions with Jump Discontinuities.** Let  $f(x)$  be a discontinuous function that has a convergent Fourier series. Note that the series does not necessarily converge to  $f(x)$ . Instead it converges to  $\hat{f}(x) = \frac{1}{2}(f(x^-) + f(x^+))$ .

**Example 28.2.2** Consider the function defined by

$$f(x) = \begin{cases} -x & \text{for } -\pi \leq x < 0 \\ \pi - 2x & \text{for } 0 \leq x < \pi. \end{cases}$$

The Fourier series converges to the function defined by

$$\hat{f}(x) = \begin{cases} 0 & \text{for } x = -\pi \\ -x & \text{for } -\pi < x < 0 \\ \pi/2 & \text{for } x = 0 \\ \pi - 2x & \text{for } 0 < x < \pi. \end{cases}$$

The function  $\hat{f}(x)$  is plotted in Figure 28.2.

## 28.3 Least Squares Fit

**Approximating a function with a Fourier series.** Suppose we want to approximate a  $2\pi$ -periodic function  $f(x)$  with a finite Fourier series.

$$f(x) \approx \frac{a_0}{2} + \sum_{n=1}^N (a_n \cos(nx) + b_n \sin(nx))$$

Here the coefficients are computed with the familiar formulas. Is this the best approximation to the function? That is, is it possible to choose coefficients  $\alpha_n$  and  $\beta_n$  such that

$$f(x) \approx \frac{\alpha_0}{2} + \sum_{n=1}^N (\alpha_n \cos(nx) + \beta_n \sin(nx))$$

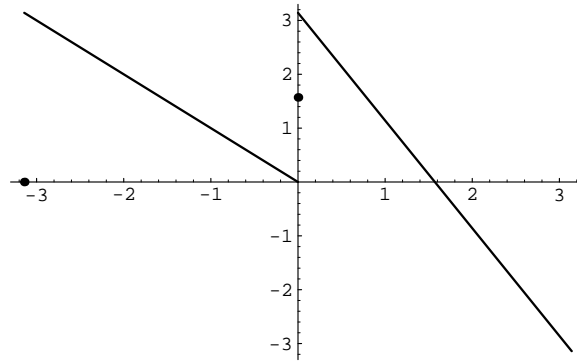

Figure 28.2: Graph of  $\hat{f}(x)$ .

would give a better approximation?

**Least squared error fit.** The most common criterion for finding the best fit to a function is the least squares fit. The best approximation to a function is defined as the one that minimizes the integral of the square of the deviation. Thus if  $f(x)$  is to be approximated on the interval  $a \leq x \leq b$  by a series

$$f(x) \approx \sum_{n=1}^N c_n \phi_n(x), \quad (28.2)$$

the best approximation is found by choosing values of  $c_n$  that minimize the error  $E$ .

$$E \equiv \int_a^b \left| f(x) - \sum_{n=1}^N c_n \phi_n(x) \right|^2 dx$$

**Generalized Fourier coefficients.** We consider the case that the  $\phi_n$  are orthogonal. For simplicity, we also assume that the  $\phi_n$  are real-valued. Then most of the terms will vanish when we interchange the order of integration and summation.

$$\begin{aligned} E &= \int_a^b \left( f^2 - 2f \sum_{n=1}^N c_n \phi_n + \sum_{n=1}^N c_n \phi_n \sum_{m=1}^N c_m \phi_m \right) dx \\ E &= \int_a^b f^2 dx - 2 \sum_{n=1}^N c_n \int_a^b f \phi_n dx + \sum_{n=1}^N \sum_{m=1}^N c_n c_m \int_a^b \phi_n \phi_m dx \\ E &= \int_a^b f^2 dx - 2 \sum_{n=1}^N c_n \int_a^b f \phi_n dx + \sum_{n=1}^N c_n^2 \int_a^b \phi_n^2 dx \\ E &= \int_a^b f^2 dx + \sum_{n=1}^N \left( c_n^2 \int_a^b \phi_n^2 dx - 2c_n \int_a^b f \phi_n dx \right) \end{aligned}$$

We complete the square for each term.

$$E = \int_a^b f^2 dx + \sum_{n=1}^N \left( \int_a^b \phi_n^2 dx \left( c_n - \frac{\int_a^b f \phi_n dx}{\int_a^b \phi_n^2 dx} \right)^2 - \left( \frac{\int_a^b f \phi_n dx}{\int_a^b \phi_n^2 dx} \right)^2 \right)$$

Each term involving  $c_n$  is non-negative, and is minimized for

$$c_n = \frac{\int_a^b f \phi_n dx}{\int_a^b \phi_n^2 dx}. \quad (28.3)$$

We call these the *generalized Fourier coefficients*.

For such a choice of the  $c_n$ , the error is

$$E = \int_a^b f^2 dx - \sum_{n=1}^N c_n^2 \int_a^b \phi_n^2 dx.$$

Since the error is non-negative, we have

$$\int_a^b f^2 dx \geq \sum_{n=1}^N c_n^2 \int_a^b \phi_n^2 dx.$$

This is known as *Bessel's Inequality*. If the series in Equation 28.2 converges in the mean to  $f(x)$ ,  $\lim N \rightarrow \infty E = 0$ , then we have equality as  $N \rightarrow \infty$ .

$$\int_a^b f^2 dx = \sum_{n=1}^{\infty} c_n^2 \int_a^b \phi_n^2 dx.$$

This is *Parseval's equality*.

**Fourier coefficients.** Previously we showed that if the series,

$$f(x) = \frac{a_0}{2} + \sum_{n=1}^{\infty} (a_n \cos(nx) + b_n \sin(nx)),$$

converges uniformly then the coefficients in the series are the Fourier coefficients,

$$a_n = \frac{1}{\pi} \int_{-\pi}^{\pi} f(x) \cos(nx) dx, \quad b_n = \frac{1}{\pi} \int_{-\pi}^{\pi} f(x) \sin(nx) dx.$$

Now we show that by choosing the coefficients to minimize the squared error, we obtain the same result. We apply Equation 28.3 to the Fourier eigenfunctions.

$$a_0 = \frac{\int_{-\pi}^{\pi} f \frac{1}{2} dx}{\int_{-\pi}^{\pi} \frac{1}{4} dx} = \frac{1}{\pi} \int_{-\pi}^{\pi} f(x) dx$$

$$a_n = \frac{\int_{-\pi}^{\pi} f \cos(nx) dx}{\int_{-\pi}^{\pi} \cos^2(nx) dx} = \frac{1}{\pi} \int_{-\pi}^{\pi} f(x) \cos(nx) dx$$

$$b_n = \frac{\int_{-\pi}^{\pi} f \sin(nx) dx}{\int_{-\pi}^{\pi} \sin^2(nx) dx} = \frac{1}{\pi} \int_{-\pi}^{\pi} f(x) \sin(nx) dx$$

## 28.4 Fourier Series for Functions Defined on Arbitrary Ranges

If  $f(x)$  is defined on  $c - d \leq x < c + d$  and  $f(x + 2d) = f(x)$ , then  $f(x)$  has a Fourier series of the form

$$f(x) \sim \frac{a_0}{2} + \sum_{n=1}^{\infty} a_n \cos\left(\frac{n\pi(x+c)}{d}\right) + b_n \sin\left(\frac{n\pi(x+c)}{d}\right).$$

Since

$$\int_{c-d}^{c+d} \cos^2\left(\frac{n\pi(x+c)}{d}\right) dx = \int_{c-d}^{c+d} \sin^2\left(\frac{n\pi(x+c)}{d}\right) dx = d,$$

the Fourier coefficients are given by the formulas

$$a_n = \frac{1}{d} \int_{c-d}^{c+d} f(x) \cos\left(\frac{n\pi(x+c)}{d}\right) dx$$

$$b_n = \frac{1}{d} \int_{c-d}^{c+d} f(x) \sin\left(\frac{n\pi(x+c)}{d}\right) dx.$$

**Example 28.4.1** Consider the function defined by

$$f(x) = \begin{cases} x + 1 & \text{for } -1 \leq x < 0 \\ x & \text{for } 0 \leq x < 1 \\ 3 - 2x & \text{for } 1 \leq x < 2. \end{cases}$$

This function is graphed in Figure 28.3.

The Fourier series converges to  $\hat{f}(x) = (f(x^-) + f(x^+))/2$ ,

$$\hat{f}(x) = \begin{cases} -\frac{1}{2} & \text{for } x = -1 \\ x + 1 & \text{for } -1 < x < 0 \\ \frac{1}{2} & \text{for } x = 0 \\ x & \text{for } 0 < x < 1 \\ 3 - 2x & \text{for } 1 \leq x < 2. \end{cases}$$

$\hat{f}(x)$  is also graphed in Figure 28.3.

The Fourier coefficients are

$$\begin{aligned} a_n &= \frac{1}{3/2} \int_{-1}^2 f(x) \cos\left(\frac{2n\pi(x+1/2)}{3}\right) dx \\ &= \frac{2}{3} \int_{-1/2}^{5/2} f(x-1/2) \cos\left(\frac{2n\pi x}{3}\right) dx \\ &= \frac{2}{3} \int_{-1/2}^{1/2} (x+1/2) \cos\left(\frac{2n\pi x}{3}\right) dx + \frac{2}{3} \int_{1/2}^{3/2} (x-1/2) \cos\left(\frac{2n\pi x}{3}\right) dx \\ &\quad + \frac{2}{3} \int_{3/2}^{5/2} (4-2x) \cos\left(\frac{2n\pi x}{3}\right) dx \\ &= -\frac{1}{(n\pi)^2} \sin\left(\frac{2n\pi}{3}\right) \left[2(-1)^n n\pi + 9 \sin\left(\frac{n\pi}{3}\right)\right] \end{aligned}$$

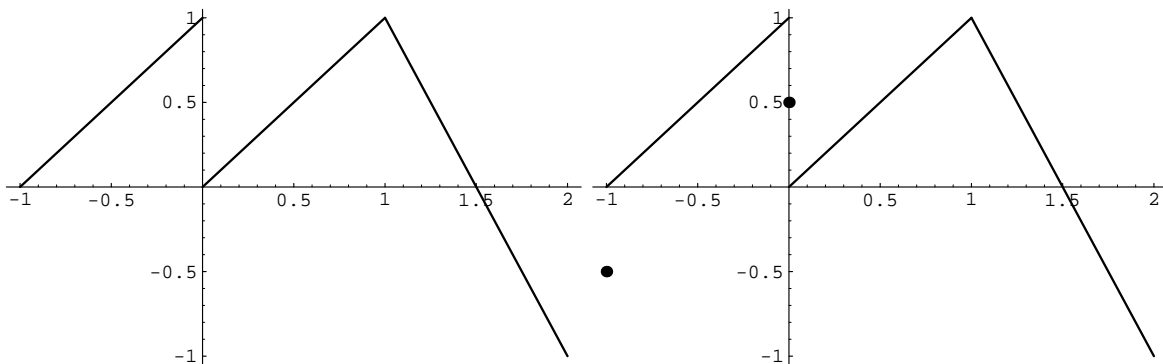

Figure 28.3: A Function Defined on the range  $-1 \leq x < 2$  and the Function to which the Fourier Series Converges.

$$\begin{aligned}
 b_n &= \frac{1}{3/2} \int_{-1}^2 f(x) \sin\left(\frac{2n\pi(x+1/2)}{3}\right) dx \\
 &= \frac{2}{3} \int_{-1/2}^{5/2} f(x-1/2) \sin\left(\frac{2n\pi x}{3}\right) dx \\
 &= \frac{2}{3} \int_{-1/2}^{1/2} (x+1/2) \sin\left(\frac{2n\pi x}{3}\right) dx + \frac{2}{3} \int_{1/2}^{3/2} (x-1/2) \sin\left(\frac{2n\pi x}{3}\right) dx \\
 &\quad + \frac{2}{3} \int_{3/2}^{5/2} (4-2x) \sin\left(\frac{2n\pi x}{3}\right) dx \\
 &= -\frac{2}{(n\pi)^2} \sin^2\left(\frac{n\pi}{3}\right) \left[ 2(-1)^n n\pi + 4n\pi \cos\left(\frac{n\pi}{3}\right) - 3 \sin\left(\frac{n\pi}{3}\right) \right]
 \end{aligned}$$

## 28.5 Fourier Cosine Series

If  $f(x)$  is an even function, ( $f(-x) = f(x)$ ), then there will not be any sine terms in the Fourier series for  $f(x)$ . The Fourier sine coefficient is

$$b_n = \frac{1}{\pi} \int_{-\pi}^{\pi} f(x) \sin(nx) \, dx.$$

Since  $f(x)$  is an even function and  $\sin(nx)$  is odd,  $f(x) \sin(nx)$  is odd.  $b_n$  is the integral of an odd function from  $-\pi$  to  $\pi$  and is thus zero. We can rewrite the cosine coefficients,

$$\begin{aligned} a_n &= \frac{1}{\pi} \int_{-\pi}^{\pi} f(x) \cos(nx) \, dx \\ &= \frac{2}{\pi} \int_0^{\pi} f(x) \cos(nx) \, dx. \end{aligned}$$

**Example 28.5.1** Consider the function defined on  $[0, \pi)$  by

$$f(x) = \begin{cases} x & \text{for } 0 \leq x < \pi/2 \\ \pi - x & \text{for } \pi/2 \leq x < \pi. \end{cases}$$

The Fourier cosine coefficients for this function are

$$\begin{aligned} a_n &= \frac{2}{\pi} \int_0^{\pi/2} x \cos(nx) \, dx + \frac{2}{\pi} \int_{\pi/2}^{\pi} (\pi - x) \cos(nx) \, dx \\ &= \begin{cases} \frac{\pi}{4} & \text{for } n = 0, \\ \frac{8}{\pi n^2} \cos\left(\frac{n\pi}{2}\right) \sin^2\left(\frac{n\pi}{4}\right) & \text{for } n \geq 1. \end{cases} \end{aligned}$$

In Figure 28.4 the even periodic extension of  $f(x)$  is plotted in a dashed line and the sum of the first five nonzero terms in the Fourier cosine series are plotted in a solid line.



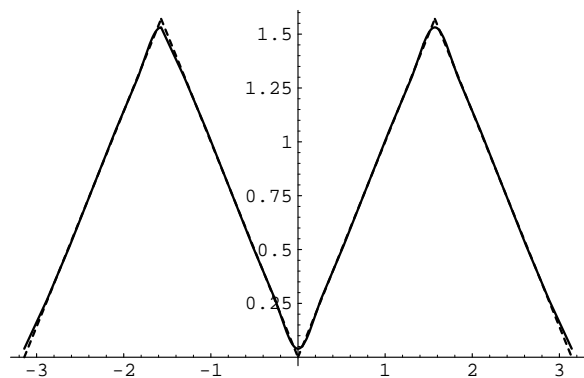

Figure 28.4: Fourier Cosine Series.

## 28.6 Fourier Sine Series

If  $f(x)$  is an odd function, ( $f(-x) = -f(x)$ ), then there will not be any cosine terms in the Fourier series. Since  $f(x)\cos(nx)$  is an odd function, the cosine coefficients will be zero. Since  $f(x)\sin(nx)$  is an even function, we can rewrite the sine coefficients

$$b_n = \frac{2}{\pi} \int_0^{\pi} f(x) \sin(nx) dx.$$

**Example 28.6.1** Consider the function defined on  $[0, \pi)$  by

$$f(x) = \begin{cases} x & \text{for } 0 \leq x < \pi/2 \\ \pi - x & \text{for } \pi/2 \leq x < \pi. \end{cases}$$

The Fourier sine coefficients for this function are

$$\begin{aligned} b_n &= \frac{2}{\pi} \int_0^{\pi/2} x \sin(nx) \, dx + \frac{2}{\pi} \int_{\pi/2}^{\pi} (\pi - x) \sin(nx) \, dx \\ &= \frac{16}{\pi n^2} \cos\left(\frac{n\pi}{4}\right) \sin^3\left(\frac{n\pi}{4}\right) \end{aligned}$$

In Figure 28.5 the odd periodic extension of  $f(x)$  is plotted in a dashed line and the sum of the first five nonzero terms in the Fourier sine series are plotted in a solid line.

## 28.7 Complex Fourier Series and Parseval's Theorem

By writing  $\sin(nx)$  and  $\cos(nx)$  in terms of  $e^{inx}$  and  $e^{-inx}$  we can obtain the complex form for a Fourier series.

$$\begin{aligned} \frac{a_0}{2} + \sum_{n=1}^{\infty} (a_n \cos(nx) + b_n \sin(nx)) &= \frac{a_0}{2} + \sum_{n=1}^{\infty} \left( a_n \frac{1}{2} (e^{inx} + e^{-inx}) + b_n \frac{1}{i2} (e^{inx} - e^{-inx}) \right) \\ &= \frac{a_0}{2} + \sum_{n=1}^{\infty} \left( \frac{1}{2} (a_n - ib_n) e^{inx} + \frac{1}{2} (a_n + ib_n) e^{-inx} \right) \\ &= \sum_{n=-\infty}^{\infty} c_n e^{inx} \end{aligned}$$

where

$$c_n = \begin{cases} \frac{1}{2}(a_n - ib_n) & \text{for } n \geq 1 \\ \frac{a_0}{2} & \text{for } n = 0 \\ \frac{1}{2}(a_{-n} + ib_{-n}) & \text{for } n \leq -1. \end{cases}$$

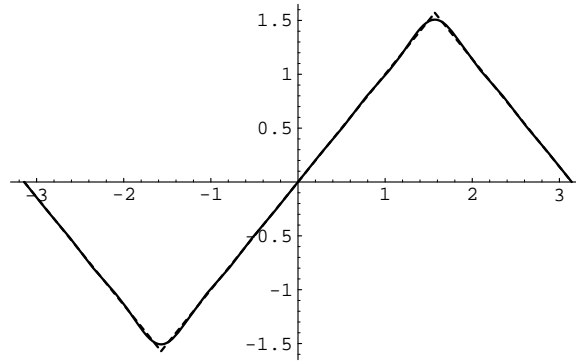

Figure 28.5: Fourier Sine Series.

The functions  $\{\dots, e^{-ix}, 1, e^{ix}, e^{i2x}, \dots\}$ , satisfy the relation

$$\int_{-\pi}^{\pi} e^{inx} e^{-imx} dx = \int_{-\pi}^{\pi} e^{i(n-m)x} dx = \begin{cases} 2\pi & \text{for } n = m \\ 0 & \text{for } n \neq m. \end{cases}$$

Starting with the complex form of the Fourier series of a function  $f(x)$ ,

$$f(x) \sim \sum_{-\infty}^{\infty} c_n e^{inx},$$

we multiply by  $e^{-imx}$  and integrate from  $-\pi$  to  $\pi$  to obtain

$$\int_{-\pi}^{\pi} f(x) e^{-imx} dx = \int_{-\pi}^{\pi} \sum_{-\infty}^{\infty} c_n e^{inx} e^{-imx} dx$$

$$c_m = \frac{1}{2\pi} \int_{-\pi}^{\pi} f(x) e^{-imx} dx$$

If  $f(x)$  is real-valued then

$$c_{-m} = \frac{1}{2\pi} \int_{-\pi}^{\pi} f(x) e^{imx} dx = \frac{1}{2\pi} \int_{-\pi}^{\pi} f(x) \overline{(e^{-imx})} dx = \bar{c}_m$$

where  $\bar{z}$  denotes the complex conjugate of  $z$ .

Assume that  $f(x)$  has a uniformly convergent Fourier series.

$$\begin{aligned} \int_{-\pi}^{\pi} f^2(x) dx &= \int_{-\pi}^{\pi} \left( \sum_{m=-\infty}^{\infty} c_m e^{imx} \right) \left( \sum_{n=-\infty}^{\infty} c_n e^{inx} \right) dx \\ &= 2\pi \sum_{n=-\infty}^{\infty} c_n c_{-n} \\ &= 2\pi \left( \sum_{n=-\infty}^{-1} \left[ \frac{1}{4} (a_{-n} + ib_{-n})(a_{-n} - ib_{-n}) \right] + \frac{a_0}{2} \frac{a_0}{2} + \sum_{n=1}^{\infty} \left[ \frac{1}{4} (a_n - ib_n)(a_n + ib_n) \right] \right) \\ &= 2\pi \left( \frac{a_0^2}{4} + \frac{1}{2} \sum_{n=1}^{\infty} (a_n^2 + b_n^2) \right) \end{aligned}$$

This yields a result known as Parseval's theorem which holds even when the Fourier series of  $f(x)$  is not uniformly convergent.

**Result 28.7.1 Parseval's Theorem.** If  $f(x)$  has the Fourier series

$$f(x) \sim \frac{a_0}{2} + \sum_{n=1}^{\infty} (a_n \cos(nx) + b_n \sin(nx)),$$

then

$$\int_{-\pi}^{\pi} f^2(x) dx = \frac{\pi}{2} a_0^2 + \pi \sum_{n=1}^{\infty} (a_n^2 + b_n^2).$$

## 28.8 Behavior of Fourier Coefficients

Before we jump hip-deep into the grunge involved in determining the behavior of the Fourier coefficients, let's take a step back and get some perspective on what we should be looking for.

One of the important questions is whether the Fourier series converges uniformly. From Result 12.2.1 we know that a uniformly convergent series represents a continuous function. Thus we know that the Fourier series of a discontinuous function cannot be uniformly convergent. From Section 12.2 we know that a series is uniformly convergent if it can be bounded by a series of positive terms. If the Fourier coefficients,  $a_n$  and  $b_n$ , are  $O(1/n^\alpha)$  where  $\alpha > 1$  then the series can be bounded by  $(\text{const}) \sum_{n=1}^{\infty} 1/n^\alpha$  and will thus be uniformly convergent.

Let  $f(x)$  be a function that meets the conditions for having a Fourier series and in addition is bounded. Let  $(-\pi, p_1), (p_1, p_2), (p_2, p_3), \dots, (p_m, \pi)$  be a partition into a finite number of intervals of the domain,  $(-\pi, \pi)$  such that on each interval  $f(x)$  and all its derivatives are continuous. Let  $f(p^-)$  denote the left limit of  $f(p)$  and  $f(p^+)$  denote the right limit.

$$f(p^-) = \lim_{\epsilon \rightarrow 0^+} f(p - \epsilon), \quad f(p^+) = \lim_{\epsilon \rightarrow 0^+} f(p + \epsilon)$$

**Example 28.8.1** The function shown in Figure 28.6 would be partitioned into the intervals

$$(-2, -1), (-1, 0), (0, 1), (1, 2).$$

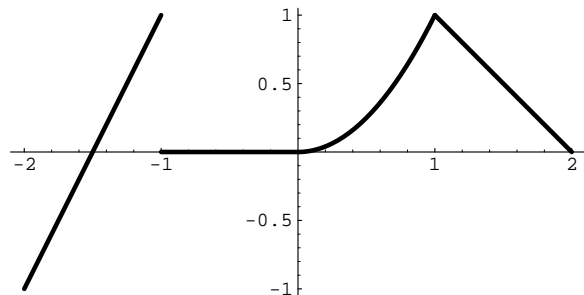

Figure 28.6: A Function that can be Partitioned.

Suppose  $f(x)$  has the Fourier series

$$f(x) \sim \frac{a_0}{2} + \sum_{n=1}^{\infty} a_n \cos(nx) + b_n \sin(nx).$$

We can use the integral formula to find the  $a_n$ 's.

$$\begin{aligned} a_n &= \frac{1}{\pi} \int_{-\pi}^{\pi} f(x) \cos(nx) \, dx \\ &= \frac{1}{\pi} \left( \int_{-\pi}^{p_1} f(x) \cos(nx) \, dx + \int_{p_1}^{p_2} f(x) \cos(nx) \, dx + \cdots + \int_{p_m}^{\pi} f(x) \cos(nx) \, dx \right) \end{aligned}$$

Using integration by parts,

$$\begin{aligned}
 &= \frac{1}{n\pi} \left( \left[ f(x) \sin(nx) \right]_{-\pi}^{p_1} + \left[ f(x) \sin(nx) \right]_{p_1}^{p_2} + \cdots + \left[ f(x) \sin(nx) \right]_{p_m}^{\pi} \right) \\
 &\quad - \frac{1}{n\pi} \left( \int_{-\pi}^{p_1} f'(x) \sin(nx) \, dx + \int_{p_1}^{p_2} f'(x) \sin(nx) \, dx + \int_{p_m}^{\pi} f'(x) \sin(nx) \, dx \right) \\
 &= \frac{1}{n\pi} \left\{ \left[ f(p_1^-) - f(p_1^+) \right] \sin(np_1) + \cdots + \left[ f(p_m^-) - f(p_m^+) \right] \sin(np_m) \right\} \\
 &\quad - \frac{1}{n} \frac{1}{\pi} \int_{-\pi}^{\pi} f'(x) \sin(nx) \, dx \\
 &= \frac{1}{n} A_n - \frac{1}{n} b'_n
 \end{aligned}$$

where

$$A_n = \frac{1}{\pi} \sum_{j=1}^m \sin(np_j) [f(p_j^-) - f(p_j^+)]$$

and the  $b'_n$  are the sine coefficients of  $f'(x)$ .

Since  $f(x)$  is bounded,  $A_n = O(1)$ . Since  $f'(x)$  is bounded,

$$b'_n = \frac{1}{\pi} \int_{-\pi}^{\pi} f'(x) \sin(nx) \, dx = O(1).$$

Thus  $a_n = O(1/n)$  as  $n \rightarrow \infty$ . (Actually, from the Riemann-Lebesgue Lemma,  $b'_n = \mathcal{O}(1/n)$ .)

Now we repeat this analysis for the sine coefficients.

$$\begin{aligned}
 b_n &= \frac{1}{\pi} \int_{-\pi}^{\pi} f(x) \sin(nx) \, dx \\
 &= \frac{1}{\pi} \left( \int_{-\pi}^{p_1} f(x) \sin(nx) \, dx + \int_{p_1}^{p_2} f(x) \sin(nx) \, dx + \cdots + \int_{p_m}^{\pi} f(x) \sin(nx) \, dx \right) \\
 &= \frac{-1}{n\pi} \left\{ [f(x) \cos(nx)]_{-\pi}^{p_1} + [f(x) \cos(nx)]_{p_1}^{p_2} + \cdots + [f(x) \cos(nx)]_{p_m}^{\pi} \right\} \\
 &\quad + \frac{1}{n\pi} \left( \int_{-\pi}^{p_1} f'(x) \cos(nx) \, dx + \int_{p_1}^{p_2} f'(x) \cos(nx) \, dx + \int_{p_m}^{\pi} f'(x) \cos(nx) \, dx \right) \\
 &= -\frac{1}{n} B_n + \frac{1}{n} a'_n
 \end{aligned}$$

where

$$B_n = \frac{(-1)^n}{\pi} [f(-\pi) - f(\pi)] - \frac{1}{\pi} \sum_{j=1}^m \cos(np_j) [f(p_j^-) - f(p_j^+)]$$

and the  $a'_n$  are the cosine coefficients of  $f'(x)$ .

Since  $f(x)$  and  $f'(x)$  are bounded,  $B_n, a'_n = O(1)$  and thus  $b_n = O(1/n)$  as  $n \rightarrow \infty$ .

With integration by parts on the Fourier coefficients of  $f'(x)$  we could find that

$$a'_n = \frac{1}{n} A'_n - \frac{1}{n} b''_n$$

where  $A'_n = \frac{1}{\pi} \sum_{j=1}^m \sin(np_j) [f'(p_j^-) - f'(p_j^+)]$  and the  $b''_n$  are the sine coefficients of  $f''(x)$ , and

$$b'_n = -\frac{1}{n} B'_n + \frac{1}{n} a''_n$$

where  $B'_n = \frac{(-1)^n}{\pi} [f'(-\pi) - f'(\pi)] - \frac{1}{\pi} \sum_{j=1}^m \cos(np_j) [f'(p_j^-) - f'(p_j^+)]$  and the  $a''_n$  are the cosine coefficients of  $f''(x)$ .



Now we can rewrite  $a_n$  and  $b_n$  as

$$a_n = \frac{1}{n}A_n + \frac{1}{n^2}B'_n - \frac{1}{n^2}a''_n$$

$$b_n = -\frac{1}{n}B_n + \frac{1}{n^2}A'_n - \frac{1}{n^2}b''_n.$$

Continuing this process we could define  $A_n^{(j)}$  and  $B_n^{(j)}$  so that

$$a_n = \frac{1}{n}A_n + \frac{1}{n^2}B'_n - \frac{1}{n^3}A''_n - \frac{1}{n^4}B'''_n + \dots$$

$$b_n = -\frac{1}{n}B_n + \frac{1}{n^2}A'_n + \frac{1}{n^3}B''_n - \frac{1}{n^4}A'''_n - \dots.$$

For any bounded function, the Fourier coefficients satisfy  $a_n, b_n = O(1/n)$  as  $n \rightarrow \infty$ . If  $A_n$  and  $B_n$  are zero then the Fourier coefficients will be  $O(1/n^2)$ . A sufficient condition for this is that the periodic extension of  $f(x)$  is continuous. We see that if the periodic extension of  $f'(x)$  is continuous then  $A'_n$  and  $B'_n$  will be zero and the Fourier coefficients will be  $O(1/n^3)$ .

**Result 28.8.1** Let  $f(x)$  be a bounded function for which there is a partition of the range  $(-\pi, \pi)$  into a finite number of intervals such that  $f(x)$  and all its derivatives are continuous on each of the intervals. If  $f(x)$  is not continuous then the Fourier coefficients are  $O(1/n)$ . If  $f(x), f'(x), \dots, f^{(k-2)}(x)$  are continuous then the Fourier coefficients are  $O(1/n^k)$ .

If the periodic extension of  $f(x)$  is continuous, then the Fourier coefficients will be  $O(1/n^2)$ . The series  $\sum_{n=1}^{\infty} |a_n \cos(nx)|$  can be bounded by  $M \sum_{n=1}^{\infty} 1/n^2$  where  $M = \max_n (|a_n| + |b_n|)$ . Thus the Fourier series converges to  $f(x)$  uniformly.

**Result 28.8.2** If the periodic extension of  $f(x)$  is continuous then the Fourier series of  $f(x)$  will converge uniformly for all  $x$ .

If the periodic extension of  $f(x)$  is not continuous, we have the following result.

**Result 28.8.3** If  $f(x)$  is continuous in the interval  $c < x < d$ , then the Fourier series is uniformly convergent in the interval  $c + \delta \leq x \leq d - \delta$  for any  $\delta > 0$ .

**Example 28.8.2 Different Rates of Convergence.**

**A Discontinuous Function.** Consider the function defined by

$$f_1(x) = \begin{cases} -1 & \text{for } -1 < x < 0 \\ 1, & \text{for } 0 < x < 1. \end{cases}$$

This function has jump discontinuities, so we know that the Fourier coefficients are  $O(1/n)$ .

Since this function is odd, there will only be sine terms in its Fourier expansion. Furthermore, since the function is symmetric about  $x = 1/2$ , there will be only odd sine terms. Computing these terms,

$$\begin{aligned} b_n &= 2 \int_0^1 \sin(n\pi x) \, dx \\ &= 2 \left[ \frac{-1}{n\pi} \cos(n\pi x) \right]_0^1 \\ &= 2 \left( -\frac{(-1)^n}{n\pi} - \frac{-1}{n\pi} \right) \\ &= \begin{cases} \frac{4}{n\pi} & \text{for odd } n \\ 0 & \text{for even } n. \end{cases} \end{aligned}$$

The function and the sum of the first three terms in the expansion are plotted, in dashed and solid lines respectively, in Figure 28.7. Although the three term sum follows the general shape of the function, it is clearly not a good approximation.

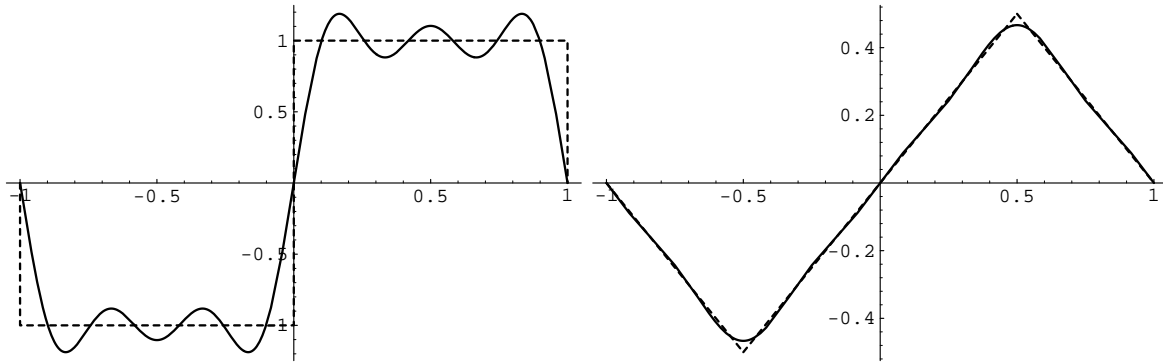

Figure 28.7: Three Term Approximation for a Function with Jump Discontinuities and a Continuous Function.

**A Continuous Function.** Consider the function defined by

$$f_2(x) = \begin{cases} -x - 1 & \text{for } -1 < x < -1/2 \\ x & \text{for } -1/2 < x < 1/2 \\ -x + 1 & \text{for } 1/2 < x < 1. \end{cases}$$

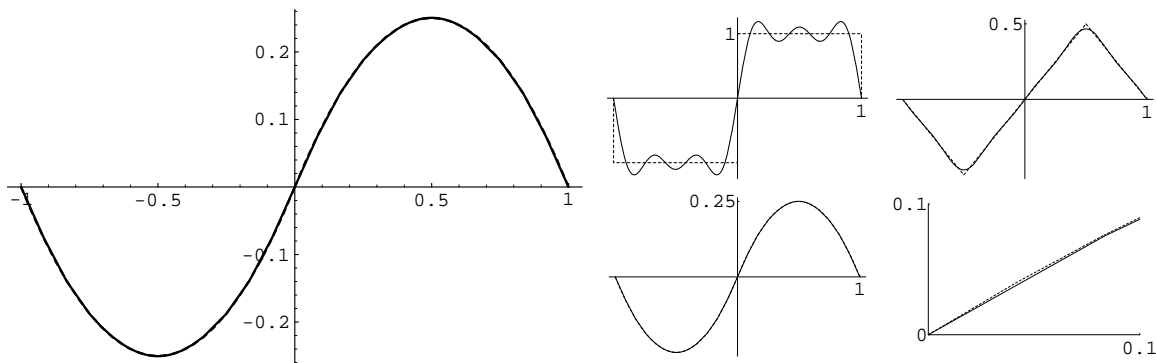

Figure 28.8: Three Term Approximation for a Function with Continuous First Derivative and Comparison of the Rates of Convergence.

Since this function is continuous, the Fourier coefficients will be  $O(1/n^2)$ . Also we see that there will only be odd sine terms in the expansion.

$$\begin{aligned}
 b_n &= \int_{-1}^{-1/2} (-x - 1) \sin(n\pi x) \, dx + \int_{-1/2}^{1/2} x \sin(n\pi x) \, dx + \int_{1/2}^1 (-x + 1) \sin(n\pi x) \, dx \\
 &= 2 \int_0^{1/2} x \sin(n\pi x) \, dx + 2 \int_{1/2}^1 (1 - x) \sin(n\pi x) \, dx \\
 &= \frac{4}{(n\pi)^2} \sin(n\pi/2) \\
 &= \begin{cases} \frac{4}{(n\pi)^2} (-1)^{(n-1)/2} & \text{for odd } n \\ 0 & \text{for even } n. \end{cases}
 \end{aligned}$$

The function and the sum of the first three terms in the expansion are plotted, in dashed and solid lines respectively, in Figure 28.7. We see that the convergence is much better than for the function with jump discontinuities.

**A Function with a Continuous First Derivative.** Consider the function defined by

$$f_3(x) = \begin{cases} x(1+x) & \text{for } -1 < x < 0 \\ x(1-x) & \text{for } 0 < x < 1. \end{cases}$$

Since the periodic extension of this function is continuous and has a continuous first derivative, the Fourier coefficients will be  $O(1/n^3)$ . We see that the Fourier expansion will contain only odd sine terms.

$$\begin{aligned} b_n &= \int_{-1}^0 x(1+x) \sin(n\pi x) \, dx + \int_0^1 x(1-x) \sin(n\pi x) \, dx \\ &= 2 \int_0^1 x(1-x) \sin(n\pi x) \, dx \\ &= \frac{4(1 - (-1)^n)}{(n\pi)^3} \\ &= \begin{cases} \frac{4}{(n\pi)^3} & \text{for odd } n \\ 0 & \text{for even } n. \end{cases} \end{aligned}$$

The function and the sum of the first three terms in the expansion are plotted in Figure 28.8. We see that the first three terms give a very good approximation to the function. The plots of the function, (in a dashed line), and the three term approximation, (in a solid line), are almost indistinguishable.

In Figure 28.8 the convergence of the of the first three terms to  $f_1(x)$ ,  $f_2(x)$ , and  $f_3(x)$  are compared. In the last graph we see a closeup of  $f_3(x)$  and it's Fourier expansion to show the error.

## 28.9 Gibb's Phenomenon

The Fourier expansion of

$$f(x) = \begin{cases} 1 & \text{for } 0 \leq x < 1 \\ -1 & \text{for } -1 \leq x < 0 \end{cases}$$

is

$$f(x) \sim \frac{4}{\pi} \sum_{n=1}^{\infty} \frac{1}{n} \sin(n\pi x).$$

For any fixed  $x$ , the series converges to  $\frac{1}{2}(f(x^-) + f(x^+))$ . For any  $\delta > 0$ , the convergence is uniform in the intervals  $-1 + \delta \leq x \leq -\delta$  and  $\delta \leq x \leq 1 - \delta$ . How will the nonuniform convergence at integral values of  $x$  affect the Fourier series? Finite Fourier series are plotted in Figure 28.9 for 5, 10, 50 and 100 terms. (The plot for 100 terms is closeup of the behavior near  $x = 0$ .) Note that at each discontinuous point there is a series of overshoots and undershoots that are pushed closer to the discontinuity by increasing the number of terms, but do not seem to decrease in height. In fact, as the number of terms goes to infinity, the height of the overshoots and undershoots does not vanish. This is known as Gibb's phenomenon.

## 28.10 Integrating and Differentiating Fourier Series

**Integrating Fourier Series.** Since integration is a smoothing operation, any convergent Fourier series can be integrated term by term to yield another convergent Fourier series.

**Example 28.10.1** Consider the step function

$$f(x) = \begin{cases} \pi & \text{for } 0 \leq x < \pi \\ -\pi & \text{for } -\pi \leq x < 0. \end{cases}$$

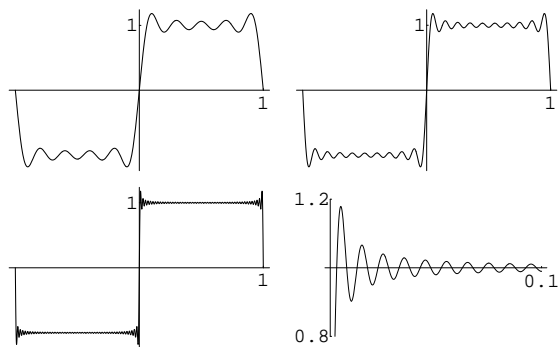

Figure 28.9:

*Since this is an odd function, there are no cosine terms in the Fourier series.*

$$\begin{aligned}
 b_n &= \frac{2}{\pi} \int_0^{\pi} \sin(nx) \, dx \\
 &= 2 \left[ -\frac{1}{n} \cos(nx) \right]_0^{\pi} \\
 &= \frac{2}{n} (1 - (-1)^n) \\
 &= \begin{cases} \frac{4}{n} & \text{for odd } n \\ 0 & \text{for even } n. \end{cases}
 \end{aligned}$$

$$f(x) \sim \sum_{\substack{n=1 \\ \text{odd}n}}^{\infty} \frac{4}{n} \sin nx$$

Integrating this relation,

$$\begin{aligned} \int_{-\pi}^x f(t) dt &\sim \int_{-\pi}^x \sum_{\substack{n=1 \\ \text{odd}n}}^{\infty} \frac{4}{n} \sin(nt) dt \\ F(x) &\sim \sum_{\substack{n=1 \\ \text{odd}n}}^{\infty} \frac{4}{n} \int_{-\pi}^x \sin(nt) dt \\ &= \sum_{\substack{n=1 \\ \text{odd}n}}^{\infty} \frac{4}{n} \left[ -\frac{1}{n} \cos(nt) \right]_{-\pi}^x \\ &= \sum_{\substack{n=1 \\ \text{odd}n}}^{\infty} \frac{4}{n^2} (-\cos(nx) + (-1)^n) \\ &= 4 \sum_{\substack{n=1 \\ \text{odd}n}}^{\infty} \frac{-1}{n^2} - 4 \sum_{\substack{n=1 \\ \text{odd}n}}^{\infty} \frac{\cos(nx)}{n^2} \end{aligned}$$

Since this series converges uniformly,

$$4 \sum_{\substack{n=1 \\ \text{odd}n}}^{\infty} \frac{-1}{n^2} - 4 \sum_{\substack{n=1 \\ \text{odd}n}}^{\infty} \frac{\cos(nx)}{n^2} = F(x) = \begin{cases} -x - \pi & \text{for } -\pi \leq x < 0 \\ x - \pi & \text{for } 0 \leq x < \pi. \end{cases}$$

The value of the constant term is

$$4 \sum_{\substack{n=1 \\ \text{odd}n}}^{\infty} \frac{-1}{n^2} = \frac{2}{\pi} \int_0^{\pi} F(x) dx = -\frac{1}{\pi}.$$



Thus

$$-\frac{1}{\pi} - 4 \sum_{\substack{n=1 \\ \text{odd}n}}^{\infty} \frac{\cos(nx)}{n^2} = \begin{cases} -x - \pi & \text{for } -\pi \leq x < 0 \\ x - \pi & \text{for } 0 \leq x < \pi. \end{cases}$$

**Differentiating Fourier Series.** Recall that in general, a series can only be differentiated if it is uniformly convergent. The necessary and sufficient condition that a Fourier series be uniformly convergent is that the periodic extension of the function is continuous.

**Result 28.10.1** The Fourier series of a function  $f(x)$  can be differentiated only if the periodic extension of  $f(x)$  is continuous.

**Example 28.10.2** Consider the function defined by

$$f(x) = \begin{cases} \pi & \text{for } 0 \leq x < \pi \\ -\pi & \text{for } -\pi \leq x < 0. \end{cases}$$

$f(x)$  has the Fourier series

$$f(x) \sim \sum_{\substack{n=1 \\ \text{odd}n}}^{\infty} \frac{4}{n} \sin nx.$$

The function has a derivative except at the points  $x = n\pi$ . Differentiating the Fourier series yields

$$f'(x) \sim 4 \sum_{\substack{n=1 \\ \text{odd}n}}^{\infty} \cos(nx).$$

For  $x \neq n\pi$ , this implies

$$0 = 4 \sum_{\substack{n=1 \\ \text{odd}n}}^{\infty} \cos(nx),$$

*which is false. The series does not converge. This is as we expected since the Fourier series for  $f(x)$  is not uniformly convergent.*

## 28.11 Exercises

### Exercise 28.1

1. Consider a  $2\pi$  periodic function  $f(x)$  expressed as a Fourier series with partial sums

$$S_N(x) = \frac{a_0}{2} + \sum_{n=1}^N a_n \cos(nx) + b_n \sin(nx).$$

Assuming that the Fourier series converges in the mean, i.e.

$$\lim_{N \rightarrow \infty} \int_{-\pi}^{\pi} (f(x) - S_N(x))^2 dx = 0,$$

show

$$\frac{a_0^2}{2} + \sum_{n=1}^{\infty} a_n^2 + b_n^2 = \frac{1}{\pi} \int_{-\pi}^{\pi} f(x)^2 dx.$$

This is called Parseval's equation.

2. Find the Fourier series for  $f(x) = x$  on  $-\pi \leq x < \pi$  (and repeating periodically). Use this to show

$$\sum_{n=1}^{\infty} \frac{1}{n^2} = \frac{\pi^2}{6}.$$

3. Similarly, by choosing appropriate functions  $f(x)$ , use Parseval's equation to determine

$$\sum_{n=1}^{\infty} \frac{1}{n^4} \quad \text{and} \quad \sum_{n=1}^{\infty} \frac{1}{n^6}.$$

### Exercise 28.2

Consider the Fourier series of  $f(x) = x$  on  $-\pi \leq x < \pi$  as found above. Investigate the convergence at the points of discontinuity.

1. Let  $S_N$  be the sum of the first  $N$  terms in the Fourier series. Show that

$$\frac{dS_N}{dx} = 1 - (-1)^N \frac{\cos\left(\left(N + \frac{1}{2}\right)x\right)}{\cos\left(\frac{x}{2}\right)}.$$

2. Now use this to show that

$$x - S_N = \int_0^x \frac{\sin\left(\left(N + \frac{1}{2}\right)(\xi - \pi)\right)}{\sin\left(\frac{\xi - \pi}{2}\right)} d\xi.$$

3. Finally investigate the maxima of this difference around  $x = \pi$  and provide an estimate (good to two decimal places) of the overshoot in the limit  $N \rightarrow \infty$ .

### Exercise 28.3

Consider the boundary value problem on the interval  $0 < x < 1$

$$y'' + 2y = 1 \quad y(0) = y(1) = 0.$$

1. Choose an appropriate periodic extension and find a Fourier series solution.
2. Solve directly and find the Fourier series of the solution (using the same extension). Compare the result to the previous step and verify the series agree.

### Exercise 28.4

Consider the boundary value problem on  $0 < x < \pi$

$$y'' + 2y = \sin x \quad y'(0) = y'(\pi) = 0.$$

1. Find a Fourier series solution.
2. Suppose the ODE is slightly modified:  $y'' + 4y = \sin x$  with the same boundary conditions. Attempt to find a Fourier series solution and discuss in as much detail as possible what goes wrong.

**Exercise 28.5**

Find the Fourier cosine and sine series for  $f(x) = x^2$  on  $0 \leq x < \pi$ . Are the series differentiable?

**Exercise 28.6**

Find the Fourier series of  $\cos^n(x)$ .

**Exercise 28.7**

For what values of  $x$  does the Fourier series

$$\frac{\pi^2}{3} + 4 \sum_{n=1}^{\infty} \frac{(-1)^n}{n^2} \cos nx = x^2$$

converge? What is the value of the above Fourier series for all  $x$ ? From this relation show that

$$\sum_{n=1}^{\infty} \frac{1}{n^2} = \frac{\pi^2}{6}$$

$$\sum_{n=1}^{\infty} \frac{(-1)^{n+1}}{n^2} = \frac{\pi^2}{12}$$

**Exercise 28.8**

1. Compute the Fourier sine series for the function

$$f(x) = \cos x - 1 + \frac{2x}{\pi}, \quad 0 \leq x \leq \pi.$$

2. How fast do the Fourier coefficients  $a_n$  where

$$f(x) = \sum_{n=1}^{\infty} a_n \sin nx$$

decrease with increasing  $n$ ? Explain this rate of decrease.

**Exercise 28.9**

Determine the cosine and sine series of

$$f(x) = x \sin x, \quad (0 < x < \pi).$$

Estimate before doing the calculation the rate of decrease of Fourier coefficients,  $a_n, b_n$ , for large  $n$ .

**Exercise 28.10**

Determine the Fourier cosine series of the function

$$f(x) = \cos(\nu x), \quad 0 \leq x \leq \pi,$$

where  $\nu$  is an arbitrary real number. From this series deduce the following identities for non-integer  $\nu$ .

$$\frac{\pi}{\sin(\pi\nu)} = \frac{1}{\nu} + \sum_{n=1}^{\infty} (-1)^n \left( \frac{1}{\nu - n} + \frac{1}{\nu + n} \right)$$

$$\pi \cot(\pi\nu) = \frac{1}{\nu} + \sum_{n=1}^{\infty} \left( \frac{1}{\nu - n} + \frac{1}{\nu + n} \right)$$

Integrate the last formula from  $\nu = 0$  to  $\nu = \theta$ , ( $0 < \theta < 1$ ), to show that

$$\frac{\sin(\pi\theta)}{\pi\theta} = \prod_{n=1}^{\infty} \left( 1 - \frac{\theta^2}{n^2} \right).$$

**Exercise 28.11**

1. Show that

$$\ln \left( \cos \left( \frac{x}{2} \right) \right) = -\ln 2 - \sum_{n=1}^{\infty} \frac{(-1)^n}{n} \cos(nx), \quad -\pi < x < \pi.$$

Use properties of Fourier series to conclude that

$$\ln \left| \cos \frac{x}{2} \right| = -\ln 2 - \sum_{n=1}^{\infty} \frac{(-1)^n}{n} \cos(nx), \quad x \neq (2k+1)\pi, \quad k \in \mathbb{Z}.$$

Hint: use the identity

$$\operatorname{Log}(1 - z) = - \sum_{n=1}^{\infty} \frac{z^n}{n} \quad \text{for } |z| \leq 1, z \neq 1.$$

2. From this series deduce that

$$\int_0^{\pi} \ln \left( \cos \frac{x}{2} \right) dx = -\pi \ln 2.$$

3. Show that

$$\frac{1}{2} \ln \left| \frac{\sin((x + \xi)/2)}{\sin((x - \xi)/2)} \right| = \sum_{n=1}^{\infty} \frac{\sin(nx) \sin(n\xi)}{n}, \quad x \neq \pm\xi + 2k\pi.$$

### Exercise 28.12

Solve the problem

$$y'' + \alpha y = f(x), \quad y(a) = y(b) = 0,$$

with an eigenfunction expansion. Assume that  $\alpha \neq n\pi/(b - a)$ ,  $n \in \mathbb{N}$ .

### Exercise 28.13

Solve the problem

$$y'' + \alpha y = f(x), \quad y(a) = A, \quad y(b) = B,$$

with an eigenfunction expansion. Assume that  $\alpha \neq n\pi/(b - a)$ ,  $n \in \mathbb{N}$ .

### Exercise 28.14

Find the trigonometric series and the simple closed form expressions for  $A(r, x)$  and  $B(r, x)$  where  $z = r e^{ix}$  and  $|r| < 1$ .

$$\text{a) } A + \imath B \equiv \frac{1}{1 - z^2} = 1 + z^2 + z^4 + \dots$$

$$\text{b) } A + \imath B \equiv \log(1 + z) = z - \frac{1}{2}z^2 + \frac{1}{3}z^3 - \dots$$

Find  $A_n$  and  $B_n$ , and the trigonometric sum for them where:

$$\text{c) } A_n + \imath B_n = 1 + z + z^2 + \dots + z^n.$$

**Exercise 28.15**

1. Is the trigonometric system

$$\{1, \sin x, \cos x, \sin 2x, \cos 2x, \dots\}$$

orthogonal on the interval  $[0, \pi]$ ? Is the system orthogonal on any interval of length  $\pi$ ? Why, in each case?

2. Show that each of the systems

$$\{1, \cos x, \cos 2x, \dots\}, \quad \text{and} \quad \{\sin x, \sin 2x, \dots\}$$

are orthogonal on  $[0, \pi]$ . Make them orthonormal too.

**Exercise 28.16**

Let  $S_N(x)$  be the  $N^{\text{th}}$  partial sum of the Fourier series for  $f(x) \equiv |x|$  on  $-\pi < x < \pi$ . Find  $N$  such that  $|f(x) - S_N(x)| < 10^{-1}$  on  $|x| < \pi$ .

**Exercise 28.17**

The set  $\{\sin(nx)\}_{n=1}^{\infty}$  is orthogonal and complete on  $[0, \pi]$ .

1. Find the Fourier sine series for  $f(x) \equiv 1$  on  $0 \leq x \leq \pi$ .
2. Find a convergent series for  $g(x) = x$  on  $0 \leq x \leq \pi$  by integrating the series for part (a).
3. Apply Parseval's relation to the series in (a) to find:

$$\sum_{n=1}^{\infty} \frac{1}{(2n-1)^2}$$

Check this result by evaluating the series in (b) at  $x = \pi$ .

**Exercise 28.18**

1. Show that the Fourier cosine series expansion on  $[0, \pi]$  of:

$$f(x) \equiv \begin{cases} 1, & 0 \leq x < \frac{\pi}{2}, \\ \frac{1}{2}, & x = \frac{\pi}{2}, \\ 0, & \frac{\pi}{2} < x \leq \pi, \end{cases}$$



is

$$S(x) = \frac{1}{2} + \frac{2}{\pi} \sum_{n=0}^{\infty} \frac{(-1)^n}{2n+1} \cos((2n+1)x).$$

2. Show that the  $N^{\text{th}}$  partial sum of the series in (a) is

$$S_N(x) = \frac{1}{2} - \frac{1}{\pi} \int_0^{x-\pi/2} \frac{\sin((2(N+1)t)}{\sin t} dt.$$

(Hint: Consider the difference of  $\sum_{n=1}^{2N+1} (e^{iy})^n$  and  $\sum_{n=1}^N (e^{i2y})^n$ , where  $y = x - \pi/2$ .)

3. Show that  $dS_N(x)/dx = 0$  at  $x = x_n = \frac{n\pi}{2(N+1)}$  for  $n = 0, 1, \dots, N, N+2, \dots, 2N+2$ .

4. Show that at  $x = x_N$ , the maximum of  $S_N(x)$  nearest to  $\pi/2$  in  $(0, \pi/2)$  is

$$S_N(x_N) = \frac{1}{2} + \frac{1}{\pi} \int_0^{\frac{\pi N}{2(N+1)}} \frac{\sin(2(N+1)t)}{\sin t} dt.$$

Clearly  $x_N \uparrow \pi/2$  as  $N \rightarrow \infty$ .

5. Show that also in this limit,

$$S_N(x_N) \rightarrow \frac{1}{2} + \frac{1}{\pi} \int_0^{\pi} \frac{\sin t}{t} dt \approx 1.0895.$$

How does this compare with  $f(\pi/2 - 0)$ ? This overshoot is the Gibbs phenomenon that occurs at each discontinuity. It is a manifestation of the non-uniform convergence of the Fourier series for  $f(x)$  on  $[0, \pi]$ .

### Exercise 28.19

Prove the Isoperimetric Inequality:  $L^2 \geq 4\pi A$  where  $L$  is the length of the perimeter and  $A$  the area of any piecewise smooth plane figure. Show that equality is attained only for the circle. (Hints: The closed curve is represented parametrically as

$$x = x(s), \quad y = y(s), \quad 0 \leq s \leq L$$

where  $s$  is the arclength. In terms of  $t = 2\pi s/L$  we have

$$\left(\frac{dx}{dt}\right)^2 + \left(\frac{dy}{dt}\right)^2 = \left(\frac{L}{2\pi}\right)^2.$$

Integrate this relation over  $[0, 2\pi]$ . The area is given by

$$A = \int_0^{2\pi} x \frac{dy}{dt} dt.$$

Express  $x(t)$  and  $y(t)$  as Fourier series and use the completeness and orthogonality relations to show that  $L^2 - 4\pi A \geq 0$ .)

### Exercise 28.20

1. Find the Fourier sine series expansion and the Fourier cosine series expansion of

$$g(x) = x(1 - x), \text{ on } 0 \leq x \leq 1.$$

Which is better and why over the indicated interval?

2. Use these expansions to show that:

$$\text{i) } \sum_{k=1}^{\infty} \frac{1}{k^2} = \frac{\pi^2}{6}, \quad \text{ii) } \sum_{k=1}^{\infty} \frac{(-1)^k}{k^2} = -\frac{\pi^2}{12}, \quad \text{iii) } \sum_{k=1}^{\infty} \frac{(-1)^k}{(2k-1)^2} = -\frac{\pi^3}{32}.$$

Note: Some useful integration by parts formulas are:

$$\begin{aligned} \int x \sin(nx) &= \frac{1}{n^2} \sin(nx) - \frac{x}{n} \cos(nx); & \int x \cos(nx) &= \frac{1}{n^2} \cos(nx) + \frac{x}{n} \sin(nx) \\ \int x^2 \sin(nx) &= \frac{2x}{n^2} \sin(nx) - \frac{n^2 x^2 - 2}{n^3} \cos(nx) \\ \int x^2 \cos(nx) &= \frac{2x}{n^2} \cos(nx) + \frac{n^2 x^2 - 2}{n^3} \sin(nx) \end{aligned}$$

## 28.12 Hints

**Hint 28.1**

**Hint 28.2**

**Hint 28.3**

**Hint 28.4**

**Hint 28.5**

**Hint 28.6**

Expand

$$\cos^n(x) = \left[ \frac{1}{2}(e^{ix} + e^{-ix}) \right]^n$$

Using Newton's binomial formula.

**Hint 28.7**

**Hint 28.8**

**Hint 28.9**

**Hint 28.10**

**Hint 28.11**

**Hint 28.12**

**Hint 28.13**

**Hint 28.14**

**Hint 28.15**

**Hint 28.16**

**Hint 28.17**

**Hint 28.18**

**Hint 28.19**

**Hint 28.20**

## 28.13 Solutions

### Solution 28.1

1. We start by assuming that the Fourier series converges in the mean.

$$\int_{-\pi}^{\pi} \left( f(x) - \frac{a_0}{2} - \sum_{n=1}^{\infty} (a_n \cos(nx) + b_n \sin(nx)) \right)^2 dx = 0$$

We interchange the order of integration and summation.

$$\begin{aligned} \int_{-\pi}^{\pi} (f(x))^2 dx - a_0 \int_{-\pi}^{\pi} f(x) dx - 2 \sum_{n=1}^{\infty} \left( a_n \int_{-\pi}^{\pi} f(x) \cos(nx) dx + b_n \int_{-\pi}^{\pi} f(x) \sin(nx) dx \right) \\ + \frac{\pi a_0^2}{2} + a_0 \sum_{n=1}^{\infty} \int_{-\pi}^{\pi} (a_n \cos(nx) + b_n \sin(nx)) dx \\ + \sum_{n=1}^{\infty} \sum_{m=1}^{\infty} \int_{-\pi}^{\pi} (a_n \cos(nx) + b_n \sin(nx))(a_m \cos(mx) + b_m \sin(mx)) dx = 0 \end{aligned}$$

Most of the terms vanish because the eigenfunctions are orthogonal.

$$\begin{aligned} \int_{-\pi}^{\pi} (f(x))^2 dx - a_0 \int_{-\pi}^{\pi} f(x) dx - 2 \sum_{n=1}^{\infty} \left( a_n \int_{-\pi}^{\pi} f(x) \cos(nx) dx + b_n \int_{-\pi}^{\pi} f(x) \sin(nx) dx \right) \\ + \frac{\pi a_0^2}{2} + \sum_{n=1}^{\infty} \int_{-\pi}^{\pi} (a_n^2 \cos^2(nx) + b_n^2 \sin^2(nx)) dx = 0 \end{aligned}$$

We use the definition of the Fourier coefficients to evaluate the integrals in the last sum.

$$\int_{-\pi}^{\pi} (f(x))^2 dx - \pi a_0^2 - 2\pi \sum_{n=1}^{\infty} (a_n^2 + b_n^2) + \frac{\pi a_0^2}{2} + \pi \sum_{n=1}^{\infty} (a_n^2 + b_n^2) = 0$$

$$\boxed{\frac{a_0^2}{2} + \sum_{n=1}^{\infty} (a_n^2 + b_n^2) = \frac{1}{\pi} \int_{-\pi}^{\pi} f(x)^2 dx}$$

2. We determine the Fourier coefficients for  $f(x) = x$ . Since  $f(x)$  is odd, all of the  $a_n$  are zero.

$$\begin{aligned} b_0 &= \frac{1}{\pi} \int_{-\pi}^{\pi} x \sin(nx) dx \\ &= \frac{1}{\pi} \left[ -\frac{1}{n} x \cos(nx) \right]_{-\pi}^{\pi} + \int_{-\pi}^{\pi} \frac{1}{n} \cos(nx) dx \\ &= \frac{2(-1)^{n+1}}{n} \end{aligned}$$

The Fourier series is

$$x = \sum_{n=1}^{\infty} \frac{2(-1)^{n+1}}{n} \sin(nx) \quad \text{for } x \in (-\pi \dots \pi).$$

We apply Parseval's theorem for this series to find the value of  $\sum_{n=1}^{\infty} \frac{1}{n^2}$ .

$$\sum_{n=1}^{\infty} \frac{4}{n^2} = \frac{1}{\pi} \int_{-\pi}^{\pi} x^2 dx$$

$$\sum_{n=1}^{\infty} \frac{4}{n^2} = \frac{2\pi^2}{3}$$

$$\boxed{\sum_{n=1}^{\infty} \frac{1}{n^2} = \frac{\pi^2}{6}}$$

3. Consider  $f(x) = x^2$ . Since the function is even, there are no sine terms in the Fourier series. The coefficients in the cosine series are

$$\begin{aligned}a_0 &= \frac{2}{\pi} \int_0^{\pi} x^2 \, dx \\ &= \frac{2\pi^2}{3} \\ a_n &= \frac{2}{\pi} \int_0^{\pi} x^2 \cos(nx) \, dx \\ &= \frac{4(-1)^n}{n^2}.\end{aligned}$$

Thus the Fourier series is

$$x^2 = \frac{\pi^2}{3} + 4 \sum_{n=1}^{\infty} \frac{(-1)^n}{n^2} \cos(nx) \quad \text{for } x \in (-\pi \dots \pi).$$

We apply Parseval's theorem for this series to find the value of  $\sum_{n=1}^{\infty} \frac{1}{n^4}$ .

$$\begin{aligned}\frac{2\pi^4}{9} + 16 \sum_{n=1}^{\infty} \frac{1}{n^4} &= \frac{1}{\pi} \int_{-\pi}^{\pi} x^4 \, dx \\ \frac{2\pi^4}{9} + 16 \sum_{n=1}^{\infty} \frac{1}{n^4} &= \frac{2\pi^4}{5} \\ \boxed{\sum_{n=1}^{\infty} \frac{1}{n^4} = \frac{\pi^4}{90}}\end{aligned}$$

Now we integrate the series for  $f(x) = x^2$ .

$$\int_0^x \left( \xi^2 - \frac{\pi^2}{3} \right) d\xi = 4 \sum_{n=1}^{\infty} \frac{(-1)^n}{n^2} \int_0^x \cos(n\xi) d\xi$$
$$\frac{x^3}{3} - \frac{\pi^2}{3}x = 4 \sum_{n=1}^{\infty} \frac{(-1)^n}{n^3} \sin(nx)$$

We apply Parseval's theorem for this series to find the value of  $\sum_{n=1}^{\infty} \frac{1}{n^6}$ .

$$16 \sum_{n=1}^{\infty} \frac{1}{n^6} = \frac{1}{\pi} \int_{-\pi}^{\pi} \left( \frac{x^3}{3} - \frac{\pi^2}{3}x \right)^2 dx$$

$$16 \sum_{n=1}^{\infty} \frac{1}{n^6} = \frac{16\pi^6}{945}$$

$$\boxed{\sum_{n=1}^{\infty} \frac{1}{n^6} = \frac{\pi^6}{945}}$$



**Solution 28.2**

1. We differentiate the partial sum of the Fourier series and evaluate the sum.

$$S_N = \sum_{n=1}^N \frac{2(-1)^{n+1}}{n} \sin(nx)$$

$$S'_N = 2 \sum_{n=1}^N (-1)^{n+1} \cos(nx)$$

$$S'_N = 2\Re \left( \sum_{n=1}^N (-1)^{n+1} e^{inx} \right)$$

$$S'_N = 2\Re \left( \frac{1 - (-1)^{N+2} e^{i(N+1)x}}{1 + e^{ix}} \right)$$

$$S'_N = \Re \left( \frac{1 + e^{-ix} - (-1)^N e^{i(N+1)x} - (-1)^N e^{iNx}}{1 + \cos(x)} \right)$$

$$S'_N = 1 - (-1)^N \frac{\cos((N+1)x) + \cos(Nx)}{1 + \cos(x)}$$

$$S'_N = 1 - (-1)^N \frac{\cos\left(\left(N + \frac{1}{2}\right)x\right) \cos\left(\frac{x}{2}\right)}{\cos^2\left(\frac{x}{2}\right)}$$

$$\boxed{\frac{dS_N}{dx} = 1 - (-1)^N \frac{\cos\left(\left(N + \frac{1}{2}\right)x\right)}{\cos\left(\frac{x}{2}\right)}}$$

2. We integrate  $S'_N$ .

$$S_N(x) - S_N(0) = x - \int_0^x \frac{(-1)^N \cos\left(\left(N + \frac{1}{2}\right)\xi\right)}{\cos\left(\frac{\xi}{2}\right)} d\xi$$

$$x - S_N = \int_0^x \frac{\sin\left(\left(N + \frac{1}{2}\right)(\xi - \pi)\right)}{\sin\left(\frac{\xi - \pi}{2}\right)} d\xi$$

3. We find the extrema of the overshoot  $E = x - S_N$  with the first derivative test.

$$E' = \frac{\sin\left(\left(N + \frac{1}{2}\right)(x - \pi)\right)}{\sin\left(\frac{x - \pi}{2}\right)} = 0$$

We look for extrema in the range  $(-\pi \dots \pi)$ .

$$\begin{aligned} \left(N + \frac{1}{2}\right)(x - \pi) &= -n\pi \\ x &= \pi \left(1 - \frac{n}{N + 1/2}\right), \quad n \in [1 \dots 2N] \end{aligned}$$

The closest of these extrema to  $x = \pi$  is

$$x = \pi \left(1 - \frac{1}{N + 1/2}\right)$$

Let  $E_0$  be the overshoot at this point. We approximate  $E_0$  for large  $N$ .

$$E_0 = \int_0^{\pi(1-1/(N+1/2))} \frac{\sin\left(\left(N + \frac{1}{2}\right)(\xi - \pi)\right)}{\sin\left(\frac{\xi - \pi}{2}\right)} d\xi$$

We shift the limits of integration.

$$E_0 = \int_{\pi/(N+1/2)}^{\pi} \frac{\sin\left(\left(N + \frac{1}{2}\right)\xi\right)}{\sin\left(\frac{\xi}{2}\right)} d\xi$$

We add and subtract an integral over  $[0 \dots \pi/(N + 1/2)]$ .

$$E_0 = \int_0^\pi \frac{\sin\left(\left(N + \frac{1}{2}\right)\xi\right)}{\sin\left(\frac{\xi}{2}\right)} d\xi - \int_0^{\pi/(N+1/2)} \frac{\sin\left(\left(N + \frac{1}{2}\right)\xi\right)}{\sin\left(\frac{\xi}{2}\right)} d\xi$$

We can evaluate the first integral with contour integration on the unit circle  $C$ .

$$\begin{aligned} \int_0^\pi \frac{\sin\left(\left(N + \frac{1}{2}\right)\xi\right)}{\sin\left(\frac{\xi}{2}\right)} d\xi &= \int_0^\pi \frac{\sin\left((2N + 1)\xi\right)}{\sin(\xi)} d\xi \\ &= \frac{1}{2} \int_{-\pi}^\pi \frac{\sin\left((2N + 1)\xi\right)}{\sin(\xi)} d\xi \\ &= \frac{1}{2} \oint_C \frac{\Im\left(z^{2N+1}\right)}{(z - 1/z)/(i2)} \frac{dz}{iz} \\ &= \Im\left(\oint_C \frac{z^{2N+1}}{(z^2 - 1)} dz\right) \\ &= \Im\left(i\pi \operatorname{Res}\left(\frac{z^{2N+1}}{(z + 1)(z - 1)}, 1\right) + i\pi \operatorname{Res}\left(\frac{z^{2N+1}}{(z + 1)(z - 1)}, -1\right)\right) \\ &= \pi \Re\left(\frac{1^{2N+1}}{2} + \frac{(-1)^{2N+1}}{-2}\right) \\ &= \pi \end{aligned}$$

We approximate the second integral.

$$\begin{aligned}
 \int_0^{\pi/(N+1/2)} \frac{\sin\left(\left(N + \frac{1}{2}\right)\xi\right)}{\sin\left(\frac{\xi}{2}\right)} d\xi &= \frac{2}{2N+1} \int_0^\pi \frac{\sin(x)}{\sin\left(\frac{x}{2N+1}\right)} dx \\
 &\approx 2 \int_0^\pi \frac{\sin(x)}{x} dx \\
 &= 2 \int_0^\pi \frac{1}{x} \sum_{n=0}^{\infty} \frac{(-1)^n x^{2n+1}}{(2n+1)!} dx \\
 &= 2 \sum_{n=0}^{\infty} \int_0^\pi \frac{(-1)^n x^{2n}}{(2n+1)!} dx \\
 &= 2 \sum_{n=0}^{\infty} \frac{(-1)^n \pi^{2n+1}}{(2n+1)(2n+1)!} dx \\
 &\approx 3.70387
 \end{aligned}$$

In the limit as  $N \rightarrow \infty$ , the overshoot is

$$|\pi - 3.70387| \approx 0.56.$$

### Solution 28.3

1. The eigenfunctions of the self-adjoint problem

$$-y'' = \lambda y, \quad y(0) = y(1) = 0,$$

are

$$\phi_n = \sin(n\pi x), \quad n \in \mathbb{Z}^+$$

We find the series expansion of the inhomogeneity  $f(x) = 1$ .

$$1 = \sum_{n=1}^{\infty} f_n \sin(n\pi x)$$
$$f_n = 2 \int_0^1 \sin(n\pi x) dx$$
$$f_n = 2 \left[ -\frac{\cos(n\pi x)}{n\pi} \right]_0^1$$
$$f_n = \frac{2}{n\pi} (1 - (-1)^n)$$
$$f_n = \begin{cases} \frac{4}{n\pi} & \text{for odd } n \\ 0 & \text{for even } n \end{cases}$$

We expand the solution in a series of the eigenfunctions.

$$y = \sum_{n=1}^{\infty} a_n \sin(n\pi x)$$

We substitute the series into the differential equation.

$$y'' + 2y = 1$$
$$-\sum_{n=1}^{\infty} a_n \pi^2 n^2 \sin(n\pi x) + 2 \sum_{n=1}^{\infty} a_n \sin(n\pi x) = \sum_{\substack{n=1 \\ \text{odd } n}}^{\infty} \frac{4}{n\pi} \sin(n\pi x)$$

$$a_n = \begin{cases} \frac{4}{n\pi(2 - \pi^2 n^2)} & \text{for odd } n \\ 0 & \text{for even } n \end{cases}$$

$$y = \sum_{\substack{n=1 \\ \text{odd } n}}^{\infty} \frac{4}{n\pi(2 - \pi^2 n^2)} \sin(n\pi x)$$

2. Now we solve the boundary value problem directly.

$$y'' + 2y = 1 \quad y(0) = y(1) = 0$$

The general solution of the differential equation is

$$y = c_1 \cos(\sqrt{2}x) + c_2 \sin(\sqrt{2}x) + \frac{1}{2}.$$

We apply the boundary conditions to find the solution.

$$c_1 + \frac{1}{2} = 0, \quad c_1 \cos(\sqrt{2}) + c_2 \sin(\sqrt{2}) + \frac{1}{2} = 0$$

$$c_1 = -\frac{1}{2}, \quad c_2 = \frac{\cos(\sqrt{2}) - 1}{2 \sin(\sqrt{2})}$$

$$y = \frac{1}{2} \left( 1 - \cos(\sqrt{2}x) + \frac{\cos(\sqrt{2}) - 1}{\sin(\sqrt{2})} \sin(\sqrt{2}x) \right)$$

We find the Fourier sine series of the solution.

$$y = \sum_{n=1}^{\infty} a_n \sin(n\pi x)$$

$$a_n = 2 \int_0^1 y(x) \sin(n\pi x) dx$$

$$a_n = \int_0^1 \left( 1 - \cos(\sqrt{2}x) + \frac{\cos(\sqrt{2}) - 1}{\sin(\sqrt{2})} \sin(\sqrt{2}x) \right) \sin(n\pi x) dx$$

$$a_n = \frac{2(1 - (-1)^2)}{n\pi(2 - \pi^2 n^2)}$$

$$a_n = \begin{cases} \frac{4}{n\pi(2 - \pi^2 n^2)} & \text{for odd } n \\ 0 & \text{for even } n \end{cases}$$

We obtain the same series as in the first part.

### Solution 28.4

1. The eigenfunctions of the self-adjoint problem

$$-y'' = \lambda y, \quad y'(0) = y'(\pi) = 0,$$

are

$$\phi_0 = \frac{1}{2}, \quad \phi_n = \cos(nx), \quad n \in \mathbb{Z}^+$$

We find the series expansion of the inhomogeneity  $f(x) = \sin(x)$ .

$$f(x) = \frac{f_0}{2} + \sum_{n=1}^{\infty} f_n \cos(nx)$$

$$f_0 = \frac{2}{\pi} \int_0^{\pi} \sin(x) \, dx$$

$$f_0 = \frac{4}{\pi}$$

$$f_n = \frac{2}{\pi} \int_0^{\pi} \sin(x) \cos(nx) \, dx$$

$$f_n = \frac{2(1 + (-1)^n)}{\pi(1 - n^2)}$$

$$f_n = \begin{cases} \frac{4}{\pi(1-n^2)} & \text{for even } n \\ 0 & \text{for odd } n \end{cases}$$

We expand the solution in a series of the eigenfunctions.

$$y = \frac{a_0}{2} + \sum_{n=1}^{\infty} a_n \cos(nx)$$

We substitute the series into the differential equation.

$$y'' + 2y = \sin(x)$$

$$-\sum_{n=1}^{\infty} a_n n^2 \cos(nx) + a_0 + 2 \sum_{n=1}^{\infty} a_n \cos(nx) = \frac{2}{\pi} + \sum_{\substack{n=2 \\ \text{even } n}}^{\infty} \frac{4}{\pi(1-n^2)} \cos(nx)$$

$$y = \frac{1}{\pi} + \sum_{\substack{n=2 \\ \text{even } n}}^{\infty} \frac{4}{\pi(1-n^2)(2-n^2)} \cos(nx)$$

2. We expand the solution in a series of the eigenfunctions.

$$y = \frac{a_0}{2} + \sum_{n=1}^{\infty} a_n \cos(nx)$$

We substitute the series into the differential equation.

$$y'' + 4y = \sin(x)$$

$$-\sum_{n=1}^{\infty} a_n n^2 \cos(nx) + 2a_0 + 4 \sum_{n=1}^{\infty} a_n \cos(nx) = \frac{2}{\pi} + \sum_{\substack{n=2 \\ \text{even } n}}^{\infty} \frac{4}{\pi(1-n^2)} \cos(nx)$$

It is not possible to solve for the  $a_2$  coefficient. That equation is

$$(0)a_2 = -\frac{4}{3\pi}.$$

This problem is to be expected, as this boundary value problem does not have a solution. The solution of the differential equation is

$$y = c_1 \cos(2x) + c_2 \sin(2x) + \frac{1}{3} \sin(x)$$



The boundary conditions give us an inconsistent set of constraints.

$$\begin{aligned}y'(0) &= 0, & y'(\pi) &= 0 \\c_2 + \frac{1}{3} &= 0, & c_2 - \frac{1}{3} &= 0\end{aligned}$$

Thus the problem has no solution.

### Solution 28.5

**Cosine Series.** The coefficients in the cosine series are

$$\begin{aligned}a_0 &= \frac{2}{\pi} \int_0^\pi x^2 dx \\&= \frac{2\pi^2}{3} \\a_n &= \frac{2}{\pi} \int_0^\pi x^2 \cos(nx) dx \\&= \frac{4(-1)^n}{n^2}.\end{aligned}$$

Thus the Fourier cosine series is

$$f(x) = \frac{\pi^2}{3} + \sum_{n=1}^{\infty} \frac{4(-1)^n}{n^2} \cos(nx).$$

In Figure 28.10 the even periodic extension of  $f(x)$  is plotted in a dashed line and the sum of the first five terms in the Fourier series is plotted in a solid line. Since the even periodic extension is continuous, the cosine series is differentiable.

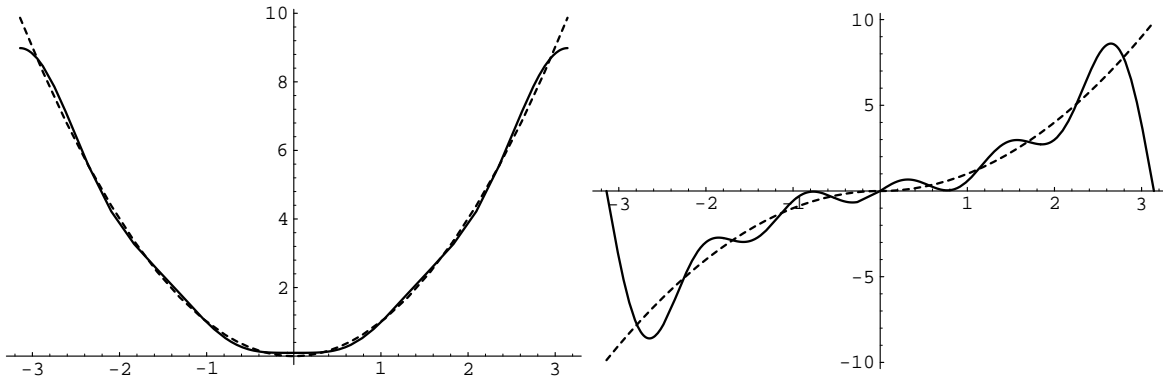

Figure 28.10: The Fourier Cosine and Sine Series of  $f(x) = x^2$ .

**Sine Series.** The coefficients in the sine series are

$$\begin{aligned}
 b_n &= \frac{2}{\pi} \int_0^{\pi} x^2 \sin(nx) \, dx \\
 &= -\frac{2(-1)^n \pi}{n} - \frac{4(1 - (-1)^n)}{\pi n^3} \\
 &= \begin{cases} -\frac{2(-1)^n \pi}{n} & \text{for even } n \\ -\frac{2(-1)^n \pi}{n} - \frac{8}{\pi n^3} & \text{for odd } n. \end{cases}
 \end{aligned}$$

Thus the Fourier sine series is

$$f(x) \sim - \sum_{n=1}^{\infty} \left( \frac{2(-1)^n \pi}{n} + \frac{4(1 - (-1)^n)}{\pi n^3} \right) \sin(nx).$$

In Figure 28.10 the odd periodic extension of  $f(x)$  and the sum of the first five terms in the sine series are plotted. Since the odd periodic extension of  $f(x)$  is not continuous, the series is not differentiable.

### Solution 28.6

We could find the expansion by integrating to find the Fourier coefficients, but it is easier to expand  $\cos^n(x)$  directly.

$$\begin{aligned} \cos^n(x) &= \left[ \frac{1}{2}(e^{ix} + e^{-ix}) \right]^n \\ &= \frac{1}{2^n} \left[ \binom{n}{0} e^{inx} + \binom{n}{1} e^{i(n-2)x} + \cdots + \binom{n}{n-1} e^{-i(n-2)x} + \binom{n}{n} e^{-inx} \right] \end{aligned}$$

If  $n$  is odd,

$$\begin{aligned} \cos^n(x) &= \frac{1}{2^n} \left[ \binom{n}{0} (e^{inx} + e^{-inx}) + \binom{n}{1} (e^{i(n-2)x} + e^{-i(n-2)x}) + \cdots \right. \\ &\quad \left. + \binom{n}{(n-1)/2} (e^{ix} + e^{-ix}) \right] \\ &= \frac{1}{2^n} \left[ \binom{n}{0} 2 \cos(nx) + \binom{n}{1} 2 \cos((n-2)x) + \cdots + \binom{n}{(n-1)/2} 2 \cos(x) \right] \\ &= \frac{1}{2^{n-1}} \sum_{m=0}^{(n-1)/2} \binom{n}{m} \cos((n-2m)x) \\ &= \frac{1}{2^{n-1}} \sum_{\substack{k=1 \\ \text{odd } k}}^n \binom{n}{(n-k)/2} \cos(kx). \end{aligned}$$

If  $n$  is even,

$$\begin{aligned}
 \cos^n(x) &= \frac{1}{2^n} \left[ \binom{n}{0} (e^{inx} + e^{-inx}) + \binom{n}{1} (e^{i(n-2)x} + e^{-i(n-2)x}) + \dots \right. \\
 &\quad \left. + \binom{n}{n/2-1} (e^{i2x} + e^{-i2x}) + \binom{n}{n/2} \right] \\
 &= \frac{1}{2^n} \left[ \binom{n}{0} 2 \cos(nx) + \binom{n}{1} 2 \cos((n-2)x) + \dots + \binom{n}{n/2-1} 2 \cos(2x) + \binom{n}{n/2} \right] \\
 &= \frac{1}{2^n} \binom{n}{n/2} + \frac{1}{2^{n-1}} \sum_{m=0}^{(n-2)/2} \binom{n}{m} \cos((n-2m)x) \\
 &= \frac{1}{2^n} \binom{n}{n/2} + \frac{1}{2^{n-1}} \sum_{\substack{k=2 \\ \text{even } k}}^n \binom{n}{(n-k)/2} \cos(kx).
 \end{aligned}$$

We may denote,

$$\boxed{\cos^n(x) = \frac{a_0}{2} \sum_{k=1}^n a_k \cos(kx),}$$

where

$$\boxed{a_k = \frac{1 + (-1)^{n-k}}{2} \frac{1}{2^{n-1}} \binom{n}{(n-k)/2}.}$$

**Solution 28.7**

We expand  $f(x)$  in a cosine series. The coefficients in the cosine series are

$$\begin{aligned} a_0 &= \frac{2}{\pi} \int_0^\pi x^2 dx \\ &= \frac{2\pi^2}{3} \\ a_n &= \frac{2}{\pi} \int_0^\pi x^2 \cos(nx) dx \\ &= \frac{4(-1)^n}{n^2}. \end{aligned}$$

Thus the Fourier cosine series is

$$f(x) = \frac{\pi^2}{3} + 4 \sum_{n=1}^{\infty} \frac{(-1)^n}{n^2} \cos(nx).$$

The Fourier series converges to the even periodic extension of

$$f(x) = x^2 \quad \text{for } 0 < x < \pi,$$

which is

$$\hat{f}(x) = \left( x - 2\pi \left( \left\lfloor \frac{x + \pi}{2\pi} \right\rfloor \right) \right)^2.$$

( $\lfloor \cdot \rfloor$  denotes the floor or greatest integer function.) This periodic extension is a continuous function. Since  $x^2$  is an even function, we have

$$\frac{\pi^2}{3} + 4 \sum_{n=1}^{\infty} \frac{(-1)^n}{n^2} \cos nx = x^2 \quad \text{for } -\pi \leq x \leq \pi.$$

We substitute  $x = \pi$  into the Fourier series.

$$\frac{\pi^2}{3} + 4 \sum_{n=1}^{\infty} \frac{(-1)^n}{n^2} \cos(n\pi) = \pi^2$$

$$\boxed{\sum_{n=1}^{\infty} \frac{1}{n^2} = \frac{\pi^2}{6}}$$

We substitute  $x = 0$  into the Fourier series.

$$\frac{\pi^2}{3} + 4 \sum_{n=1}^{\infty} \frac{(-1)^n}{n^2} = 0$$

$$\boxed{\sum_{n=1}^{\infty} \frac{(-1)^{n+1}}{n^2} = \frac{\pi^2}{12}}$$

### Solution 28.8

1. We compute the Fourier sine coefficients.

$$\begin{aligned} a_n &= \frac{2}{\pi} \int_0^{\pi} f(x) \sin(nx) \, dx \\ &= \frac{2}{\pi} \int_0^{\pi} \left( \cos x - 1 + \frac{2x}{\pi} \right) \sin(nx) \, dx \\ &= \frac{2(1 + (-1)^n)}{\pi(n^3 - n)} \end{aligned}$$

$$\boxed{a_n = \begin{cases} \frac{4}{\pi(n^3 - n)} & \text{for even } n \\ 0 & \text{for odd } n \end{cases}}$$

2. From our work in the previous part, we see that the Fourier coefficients decay as  $1/n^3$ . The Fourier sine series converges to the odd periodic extension of the function,  $\hat{f}(x)$ . We can determine the rate of decay of the Fourier coefficients from the smoothness of  $\hat{f}(x)$ . For  $-\pi < x < \pi$ , the odd periodic extension of  $f(x)$  is defined

$$\hat{f}(x) = \begin{cases} f(x) = \cos(x) - 1 + \frac{2x}{\pi} & 0 \leq x < \pi, \\ -f(-x) = -\cos(x) + 1 + \frac{2x}{\pi} & -\pi \leq x < 0. \end{cases}$$

Since

$$\hat{f}(0^+) = \hat{f}(0^-) = 0 \quad \text{and} \quad \hat{f}(\pi) = \hat{f}(-\pi) = 0$$

$\hat{f}(x)$  is continuous,  $C^0$ . Since

$$\hat{f}'(0^+) = \hat{f}'(0^-) = \frac{2}{\pi} \quad \text{and} \quad \hat{f}'(\pi) = \hat{f}'(-\pi) = \frac{2}{\pi}$$

$\hat{f}(x)$  is continuously differentiable,  $C^1$ . However, since

$$\hat{f}''(0^+) = -1, \quad \text{and} \quad \hat{f}''(0^-) = 1$$

$\hat{f}(x)$  is not  $C^2$ . Since  $\hat{f}(x)$  is  $C^1$  we know that the Fourier coefficients decay as  $1/n^3$ .

### Solution 28.9

**Cosine Series.** The even periodic extension of  $f(x)$  is a  $C^0$ , continuous, function (See Figure 28.11). Thus the coefficients in the cosine series will decay as  $1/n^2$ . The Fourier cosine coefficients are

$$\begin{aligned} a_0 &= \frac{2}{\pi} \int_0^{\pi} x \sin x \, dx \\ &= 2 \end{aligned}$$

$$\begin{aligned} a_1 &= \frac{2}{\pi} \int_0^{\pi} x \sin x \cos x \, dx \\ &= -\frac{1}{2} \end{aligned}$$

$$\begin{aligned}
 a_n &= \frac{2}{\pi} \int_0^\pi x \sin x \cos(nx) \, dx \\
 &= \frac{2(-1)^{n+1}}{n^2 - 1}, \quad \text{for } n \geq 2
 \end{aligned}$$

The Fourier cosine series is

$$\hat{f}(x) = 1 - \frac{1}{2} \cos x - 2 \sum_{n=2}^{\infty} \frac{2(-1)^n}{n^2 - 1} \cos(nx).$$

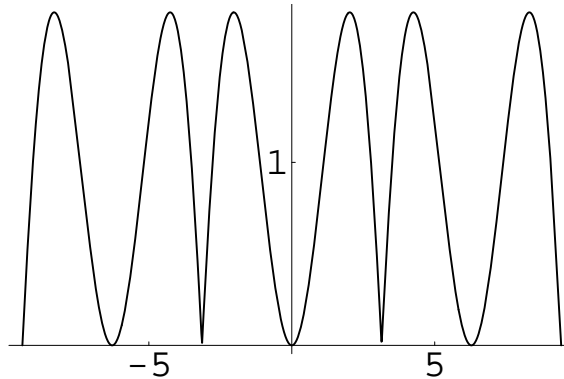

Figure 28.11: The even periodic extension of  $x \sin x$ .

**Sine Series.** The odd periodic extension of  $f(x)$  is a  $C^1$ , continuously differentiable, function (See Figure 28.12). Thus the coefficients in the cosine series will decay as  $1/n^3$ . The Fourier sine coefficients are

$$\begin{aligned}
 a_1 &= \frac{1}{\pi} \int_0^\pi x \sin x \sin x \, dx \\
 &= \frac{\pi}{2}
 \end{aligned}$$



$$\begin{aligned}
 a_n &= \frac{2}{\pi} \int_0^\pi x \sin x \sin(nx) \, dx \\
 &= -\frac{4(1 + (-1)^n)n}{\pi(n^2 - 1)^2}, \quad \text{for } n \geq 2
 \end{aligned}$$

The Fourier sine series is

$$\hat{f}(x) = \frac{\pi}{2} \sin x - \frac{4}{\pi} \sum_{n=2}^{\infty} \frac{(1 + (-1)^n)n}{(n^2 - 1)^2} \cos(nx).$$

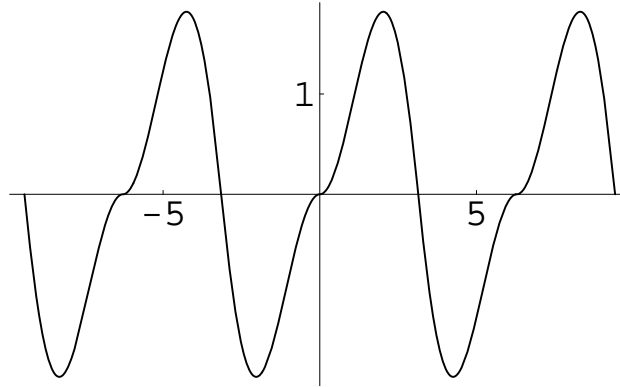

Figure 28.12: The odd periodic extension of  $x \sin x$ .

### Solution 28.10

If  $\nu = n$  is an integer, then the Fourier cosine series is the single term  $\cos(|n|x)$ . We assume that  $\nu \neq n$ .

We note that the even periodic extension of  $\cos(\nu x)$  is  $C^0$  so that the series converges to  $\cos(\nu x)$  for  $-\pi \leq x \leq \pi$

and the coefficients decay as  $1/n^2$ . We compute the Fourier cosine coefficients.

$$\begin{aligned} a_0 &= \frac{2}{\pi} \int_0^\pi \cos(\nu x) \, dx \\ &= \frac{2 \sin(\pi\nu)}{\pi\nu} \end{aligned}$$

$$\begin{aligned} a_n &= \frac{2}{\pi} \int_0^\pi \cos(\nu x) \cos(nx) \, dx \\ &= (-1)^n \left( \frac{1}{\nu - n} + \frac{1}{\nu + n} \right) \sin(\pi\nu) \end{aligned}$$

The Fourier cosine series is

$$\cos(\nu x) = \frac{\sin(\pi\nu)}{\pi\nu} + \sum_{n=1}^{\infty} (-1)^n \left( \frac{1}{\nu - n} + \frac{1}{\nu + n} \right) \sin(\pi\nu) \cos(nx).$$

We substitute  $x = 0$  into the Fourier cosine series.

$$1 = \frac{\sin(\pi\nu)}{\pi\nu} + \sum_{n=1}^{\infty} (-1)^n \left( \frac{1}{\nu - n} + \frac{1}{\nu + n} \right) \sin(\pi\nu)$$

$$\frac{\pi}{\sin \pi\nu} = \frac{1}{\nu} + \sum_{n=1}^{\infty} (-1)^n \left( \frac{1}{\nu - n} + \frac{1}{\nu + n} \right)$$

Next we substitute  $x = \pi$  into the Fourier cosine series.

$$\cos(\nu\pi) = \frac{\sin(\pi\nu)}{\pi\nu} + \sum_{n=1}^{\infty} (-1)^n \left( \frac{1}{\nu - n} + \frac{1}{\nu + n} \right) \sin(\pi\nu) (-1)^n$$

$$\pi \cot \pi\nu = \frac{1}{\nu} + \sum_{n=1}^{\infty} \left( \frac{1}{\nu - n} + \frac{1}{\nu + n} \right)$$

Note that neither  $\cot(\pi\nu)$  nor  $1/\nu$  is integrable at  $\nu = 0$ . We write the last formula so each side is integrable.

$$\pi \cot \pi\nu - \frac{1}{\nu} = \sum_{n=1}^{\infty} \left( \frac{1}{\nu - n} + \frac{1}{\nu + n} \right)$$

We integrate from  $\nu = 0$  to  $\nu = \theta < 1$ .

$$\begin{aligned} \left[ \ln \left( \frac{\sin(\pi\nu)}{\nu} \right) \right]_0^{\theta} &= \sum_{n=1}^{\infty} \left( [\ln(n - \nu)]_0^{\theta} + [\ln(n + \nu)]_0^{\theta} \right) \\ \ln \left( \frac{\sin(\pi\theta)}{\theta} \right) - \ln \pi &= \sum_{n=1}^{\infty} \left( \ln \left( \frac{n - \theta}{n} \right) + \ln \left( \frac{n + \theta}{n} \right) \right) \\ \ln \left( \frac{\sin(\pi\theta)}{\pi\theta} \right) &= \sum_{n=1}^{\infty} \ln \left( 1 - \frac{\theta^2}{n^2} \right) \\ \ln \left( \frac{\sin(\pi\theta)}{\pi\theta} \right) &= \ln \left( \prod_{n=1}^{\infty} \left( 1 - \frac{\theta^2}{n^2} \right) \right) \\ \boxed{\frac{\sin(\pi\theta)}{\pi\theta} = \prod_{n=1}^{\infty} \left( 1 - \frac{\theta^2}{n^2} \right)} \end{aligned}$$

### Solution 28.11

1. We will consider the principal branch of the logarithm,  $-\pi < \Im(\text{Log } z) \leq \pi$ . For  $-\pi < x < \pi$ ,  $\cos(x/2)$  is positive so that  $\ln(\cos(x/2))$  is well-defined. At  $x = \pm\pi$ ,  $\ln(\cos(x/2))$  is singular. However, the function is integrable so it has a Fourier series which converges except at  $x = (2k + 1)\pi$ ,  $k \in \mathbb{Z}$ .

$$\begin{aligned} \ln \left( \cos \frac{x}{2} \right) &= \ln \left( \frac{e^{ix/2} + e^{-ix/2}}{2} \right) \\ &= -\ln 2 + \ln \left( e^{-ix/2} (1 + e^{ix}) \right) \\ &= -\ln 2 - i\frac{x}{2} + \text{Log}(1 + e^{ix}) \end{aligned}$$

Since  $|e^{ix}| \leq 1$  and  $e^{ix} \neq -1$  for  $\Im(x) \geq 0$ ,  $x \neq (2k+1)\pi$ , we can expand the last term in a Taylor series in that domain.

$$\begin{aligned} &= -\ln 2 - i\frac{x}{2} - \sum_{n=1}^{\infty} \frac{(-1)^n}{n} (e^{ix})^n \\ &= -\ln 2 - \sum_{n=1}^{\infty} \frac{(-1)^n}{n} \cos(nx) - i \left( \frac{x}{2} + \sum_{n=1}^{\infty} \frac{(-1)^n}{n} \sin(nx) \right) \end{aligned}$$

For  $-\pi < x < \pi$ ,  $\ln(\cos(x/2))$  is real-valued. We equate the real parts of the equation on this domain to obtain the desired Fourier series.

$$\ln \left( \cos \left( \frac{x}{2} \right) \right) = -\ln 2 - \sum_{n=1}^{\infty} \frac{(-1)^n}{n} \cos(nx), \quad -\pi < x < \pi.$$

The domain of convergence for this series is  $\Im(x) = 0$ ,  $x \neq (2k+1)\pi$ . The Fourier series converges to the periodic extension of the function.

$$\ln \left| \cos \frac{x}{2} \right| = -\ln 2 - \sum_{n=1}^{\infty} \frac{(-1)^n}{n} \cos(nx), \quad x \neq (2k+1)\pi, \quad k \in \mathbb{Z}$$

2. Now we integrate the function from 0 to  $\pi$ .

$$\begin{aligned} \int_0^{\pi} \ln \left( \cos \frac{x}{2} \right) dx &= \int_0^{\pi} \left( -\ln 2 - \sum_{n=1}^{\infty} \frac{(-1)^n}{n} \cos(nx) \right) dx \\ &= -\pi \ln 2 - \sum_{n=1}^{\infty} \frac{(-1)^n}{n} \int_0^{\pi} \cos(nx) dx \\ &= -\pi \ln 2 - \sum_{n=1}^{\infty} \frac{(-1)^n}{n} \left[ \frac{\sin(nx)}{n} \right]_0^{\pi} \end{aligned}$$

$$\int_0^\pi \ln \left( \cos \left( \frac{x}{2} \right) \right) dx = -\pi \ln 2$$

3. We expand the logarithm.

$$\frac{1}{2} \ln \left| \frac{\sin((x + \xi)/2)}{\sin((x - \xi)/2)} \right| = \frac{1}{2} \ln |\sin((x + \xi)/2)| - \frac{1}{2} \ln |\sin((x - \xi)/2)|$$

Consider the function  $\ln |\sin(y/2)|$ . Since  $\sin(x) = \cos(x - \pi/2)$ , we can use the result of part (a) to obtain,

$$\begin{aligned} \ln \left| \sin \left( \frac{y}{2} \right) \right| &= \ln \left| \cos \left( \frac{y - \pi}{2} \right) \right| \\ &= -\ln 2 - \sum_{n=1}^{\infty} \frac{(-1)^n}{n} \cos(n(y - \pi)) \\ &= -\ln 2 - \sum_{n=1}^{\infty} \frac{1}{n} \cos(ny), \quad \text{for } y \neq 2\pi k, \quad k \in \mathbb{Z}. \end{aligned}$$

We return to the original function:

$$\frac{1}{2} \ln \left| \frac{\sin((x + \xi)/2)}{\sin((x - \xi)/2)} \right| = \frac{1}{2} \left( -\ln 2 - \sum_{n=1}^{\infty} \frac{1}{n} \cos(n(x + \xi)) + \ln 2 + \sum_{n=1}^{\infty} \frac{1}{n} \cos(n(x - \xi)) \right),$$

for  $x \pm \xi \neq 2\pi k$ ,  $k \in \mathbb{Z}$ .

$$\frac{1}{2} \ln \left| \frac{\sin((x + \xi)/2)}{\sin((x - \xi)/2)} \right| = \sum_{n=1}^{\infty} \frac{\sin(nx) \sin(n\xi)}{n}, \quad x \neq \pm\xi + 2k\pi$$

### Solution 28.12

The eigenfunction problem associated with this problem is

$$\phi'' + \lambda^2 \phi = 0, \quad \phi(a) = \phi(b) = 0,$$

which has the solutions,

$$\lambda_n = \frac{n\pi}{b-a}, \quad \phi_n = \sin\left(\frac{n\pi(x-a)}{b-a}\right), \quad n \in \mathbb{N}.$$

We expand the solution and the inhomogeneity in the eigenfunctions.

$$y(x) = \sum_{n=1}^{\infty} y_n \sin\left(\frac{n\pi(x-a)}{b-a}\right)$$

$$f(x) = \sum_{n=1}^{\infty} f_n \sin\left(\frac{n\pi(x-a)}{b-a}\right), \quad f_n = \frac{2}{b-a} \int_a^b f(x) \sin\left(\frac{n\pi(x-a)}{b-a}\right) dx$$

Since the solution  $y(x)$  satisfies the same homogeneous boundary conditions as the eigenfunctions, we can differentiate the series. We substitute the series expansions into the differential equation.

$$\begin{aligned} y'' + \alpha y &= f(x) \\ \sum_{n=1}^{\infty} y_n (-\lambda_n^2 + \alpha) \sin(\lambda_n x) &= \sum_{n=1}^{\infty} f_n \sin(\lambda_n x) \\ y_n &= \frac{f_n}{\alpha - \lambda_n^2} \end{aligned}$$

Thus the solution of the problem has the series representation,

$$y(x) = \sum_{n=1}^{\infty} (\alpha - \lambda_n^2) \sin\left(\frac{n\pi(x-a)}{b-a}\right).$$

### Solution 28.13

The eigenfunction problem associated with this problem is

$$\phi'' + \lambda^2 \phi = 0, \quad \phi(a) = \phi(b) = 0,$$

which has the solutions,

$$\lambda_n = \frac{n\pi}{b-a}, \quad \phi_n = \sin\left(\frac{n\pi(x-a)}{b-a}\right), \quad n \in \mathbb{N}.$$

We expand the solution and the inhomogeneity in the eigenfunctions.

$$y(x) = \sum_{n=1}^{\infty} y_n \sin\left(\frac{n\pi(x-a)}{b-a}\right)$$

$$f(x) = \sum_{n=1}^{\infty} f_n \sin\left(\frac{n\pi(x-a)}{b-a}\right), \quad f_n = \frac{2}{b-a} \int_a^b f(x) \sin\left(\frac{n\pi(x-a)}{b-a}\right) dx$$

Since the solution  $y(x)$  does not satisfy the same homogeneous boundary conditions as the eigenfunctions, we can differentiate the series. We multiply the differential equation by an eigenfunction and integrate from  $a$  to  $b$ . We use integration by parts to move derivatives from  $y$  to the eigenfunction.

$$y'' + \alpha y = f(x)$$

$$\int_a^b y''(x) \sin(\lambda_m x) dx + \alpha \int_a^b y(x) \sin(\lambda_m x) dx = \int_a^b f(x) \sin(\lambda_m x) dx$$

$$[y' \sin(\lambda_m x)]_a^b - \int_a^b y' \lambda_m \cos(\lambda_m x) dx + \alpha \frac{b-a}{2} y_m = \frac{b-a}{2} f_m$$

$$- [y \lambda_m \cos(\lambda_m x)]_a^b - \int_a^b y \lambda_m^2 \sin(\lambda_m x) dx + \alpha \frac{b-a}{2} y_m = \frac{b-a}{2} f_m$$

$$-B \lambda_m (-1)^m + A \lambda_m (-1)^{m+1} - \lambda_m^2 y_m + \alpha \frac{b-a}{2} y_m = \frac{b-a}{2} f_m$$

$$y_m = \frac{f_m + (-1)^m \lambda_m (A+B)}{\alpha - \lambda_m^2}$$

Thus the solution of the problem has the series representation,

$$y(x) = \sum_{n=1}^{\infty} \frac{f_n + (-1)^n \lambda_n (A+B)}{\alpha - \lambda_n^2} \sin\left(\frac{n\pi(x-a)}{b-a}\right).$$

**Solution 28.14**

1.

$$\begin{aligned}
A + iB &= \frac{1}{1 - z^2} \\
&= \sum_{n=0}^{\infty} z^{2n} \\
&= \sum_{n=0}^{\infty} r^{2n} e^{i2nx} \\
&= \sum_{n=0}^{\infty} r^{2n} \cos(2nx) + i \sum_{n=1}^{\infty} r^{2n} \sin(2nx)
\end{aligned}$$

$A = \sum_{n=0}^{\infty} r^{2n} \cos(2nx), \quad B = \sum_{n=1}^{\infty} r^{2n} \sin(2nx)$
--

$$\begin{aligned}
A + iB &= \frac{1}{1 - z^2} \\
&= \frac{1}{1 - r^2 e^{i2x}} \\
&= \frac{1}{1 - r^2 \cos(2x) - ir^2 \sin(2x)} \\
&= \frac{1 - r^2 \cos(2x) + ir^2 \sin(2x)}{(1 - r^2 \cos(2x))^2 + (r^2 \sin(2x))^2}
\end{aligned}$$

$A = \frac{1 - r^2 \cos(2x)}{1 - 2r^2 \cos(2x) + r^4}, \quad B = \frac{r^2 \sin(2x)}{1 - 2r^2 \cos(2x) + r^4}$
--



2. We consider the principal branch of the logarithm.

$$\begin{aligned}
 A + \iota B &= \log(1 + z) \\
 &= \sum_{n=1}^{\infty} \frac{(-1)^{n+1}}{n} z^n \\
 &= \sum_{n=1}^{\infty} \frac{(-1)^{n+1}}{n} r^n e^{inx} \\
 &= \sum_{n=1}^{\infty} \frac{(-1)^{n+1}}{n} r^n (\cos(nx) + \iota \sin(nx))
 \end{aligned}$$

$$A = \sum_{n=1}^{\infty} \frac{(-1)^{n+1}}{n} r^n \cos(nx), \quad B = \sum_{n=1}^{\infty} \frac{(-1)^{n+1}}{n} r^n \sin(nx)$$

$$\begin{aligned}
 A + \iota B &= \log(1 + z) \\
 &= \log(1 + r e^{ix}) \\
 &= \log(1 + r \cos x + \iota r \sin x) \\
 &= \log|1 + r \cos x + \iota r \sin x| + \iota \arg(1 + r \cos x + \iota r \sin x) \\
 &= \log \sqrt{(1 + r \cos x)^2 + (r \sin x)^2} + \iota \arctan(1 + r \cos x, r \sin x)
 \end{aligned}$$

$$A = \frac{1}{2} \log(1 + 2r \cos x + r^2), \quad B = \arctan(1 + r \cos x, r \sin x)$$

3.

$$\begin{aligned}
 A_n + iB_n &= \sum_{k=1}^n z^k \\
 &= \frac{1 - z^{n+1}}{1 - z} \\
 &= \frac{1 - r^{n+1} e^{i(n+1)x}}{1 - r e^{ix}} \\
 &= \frac{1 - r e^{-ix} - r^{n+1} e^{i(n+1)x} + r^{n+2} e^{inx}}{1 - 2r \cos x + r^2}
 \end{aligned}$$

$$A_n = \frac{1 - r \cos x - r^{n+1} \cos((n+1)x) + r^{n+2} \cos(nx)}{1 - 2r \cos x + r^2}$$

$$B_n = \frac{r \sin x - r^{n+1} \sin((n+1)x) + r^{n+2} \sin(nx)}{1 - 2r \cos x + r^2}$$

$$\begin{aligned}
 A_n + iB_n &= \sum_{k=1}^n z^k \\
 &= \sum_{k=1}^n r^k e^{ikx}
 \end{aligned}$$

$$A_n = \sum_{k=1}^n r^k \cos(kx), \quad B_n = \sum_{k=1}^n r^k \sin(kx)$$

**Solution 28.15**

1.

$$\int_0^\pi 1 \cdot \sin x \, dx = [-\cos x]_0^\pi = 2$$

Thus the system is not orthogonal on the interval  $[0, \pi]$ . Consider the interval  $[a, a + \pi]$ .

$$\int_a^{a+\pi} 1 \cdot \sin x \, dx = [-\cos x]_a^{a+\pi} = 2 \cos a$$

$$\int_a^{a+\pi} 1 \cdot \cos x \, dx = [\sin x]_a^{a+\pi} = -2 \sin a$$

Since there is no value of  $a$  for which both  $\cos a$  and  $\sin a$  vanish, the system is not orthogonal for any interval of length  $\pi$ .

2. First note that

$$\int_0^\pi \cos nx \, dx = 0 \text{ for } n \in \mathbb{N}.$$

If  $n \neq m$ ,  $n \geq 1$  and  $m \geq 0$  then

$$\int_0^\pi \cos nx \cos mx \, dx = \frac{1}{2} \int_0^\pi (\cos((n-m)x) + \cos((n+m)x)) \, dx = 0$$

Thus the set  $\{1, \cos x, \cos 2x, \dots\}$  is orthogonal on  $[0, \pi]$ . Since

$$\int_0^\pi dx = \pi$$

$$\int_0^\pi \cos^2(nx) \, dx = \frac{\pi}{2},$$

the set

$$\left\{ \sqrt{\frac{1}{\pi}}, \sqrt{\frac{2}{\pi}} \cos x, \sqrt{\frac{2}{\pi}} \cos 2x, \dots \right\}$$

is orthonormal on  $[0, \pi]$ .

If  $n \neq m$ ,  $n \geq 1$  and  $m \geq 1$  then

$$\int_0^\pi \sin nx \sin mx \, dx = \frac{1}{2} \int_0^\pi (\cos((n-m)x) - \cos((n+m)x)) \, dx = 0$$

Thus the set  $\{\sin x, \sin 2x, \dots\}$  is orthogonal on  $[0, \pi]$ . Since

$$\int_0^\pi \sin^2(nx) \, dx = \frac{\pi}{2},$$

the set

$$\left\{ \sqrt{\frac{2}{\pi}} \sin x, \sqrt{\frac{2}{\pi}} \sin 2x, \dots \right\}$$

is orthonormal on  $[0, \pi]$ .

### Solution 28.16

Since the periodic extension of  $|x|$  in  $[-\pi, \pi]$  is an even function its Fourier series is a cosine series. Because of the anti-symmetry about  $x = \pi/2$  we see that except for the constant term, there will only be odd cosine terms. Since the periodic extension is a continuous function, but has a discontinuous first derivative, the Fourier coefficients will decay as  $1/n^2$ .

$$|x| = \sum_{n=0}^{\infty} a_n \cos(nx), \quad \text{for } x \in [-\pi, \pi]$$

$$a_0 = \frac{1}{\pi} \int_0^\pi x \, dx = \frac{1}{\pi} \left[ \frac{x^2}{2} \right]_0^\pi = \frac{\pi}{2}$$

$$\begin{aligned}
a_n &= \frac{2}{\pi} \int_0^\pi x \cos(nx) \, dx \\
&= \frac{2}{\pi} \left[ x \frac{\sin(nx)}{n} \right]_0^\pi - \frac{2}{\pi} \int_0^\pi \frac{\sin(nx)}{n} \, dx \\
&= -\frac{2}{\pi} \left[ \frac{\cos(nx)}{n^2} \right]_0^\pi \\
&= -\frac{2}{\pi n^2} (\cos(n\pi) - 1) \\
&= \frac{2(1 - (-1)^n)}{\pi n^2}
\end{aligned}$$

$$|x| = \frac{\pi}{2} + \frac{4}{\pi} \sum_{\substack{n=1 \\ \text{odd } n}}^{\infty} \frac{1}{n^2} \cos(nx) \quad \text{for } x \in [-\pi, \pi]$$

Define  $R_N(x) = f(x) - S_N(x)$ . We seek an upper bound on  $|R_N(x)|$ .

$$\begin{aligned}
|R_N(x)| &= \left| \frac{4}{\pi} \sum_{\substack{n=N+1 \\ \text{odd } n}}^{\infty} \frac{1}{n^2} \cos(nx) \right| \\
&\leq \frac{4}{\pi} \sum_{\substack{n=N+1 \\ \text{odd } n}}^{\infty} \frac{1}{n^2} \\
&= \frac{4}{\pi} \sum_{\substack{n=1 \\ \text{odd } n}}^{\infty} \frac{1}{n^2} - \frac{4}{\pi} \sum_{\substack{n=1 \\ \text{odd } n}}^N \frac{1}{n^2}
\end{aligned}$$

Since

$$\sum_{\substack{n=1 \\ \text{odd } n}}^{\infty} \frac{1}{n^2} = \frac{\pi^2}{8}$$

We can bound the error with,

$$|R_N(x)| \leq \frac{\pi}{2} - \frac{4}{\pi} \sum_{\substack{n=1 \\ \text{odd } n}}^N \frac{1}{n^2}.$$

$N = 7$  is the smallest number for which our error bound is less than  $10^{-1}$ .  $N \geq 7$  is sufficient to make the error less than 0.1.

$$|R_7(x)| \leq \frac{\pi}{2} - \frac{4}{\pi} \left( 1 + \frac{1}{9} + \frac{1}{25} + \frac{1}{49} \right) \approx 0.079$$

$N \geq 7$  is also necessary because.

$$|R_N(0)| = \frac{4}{\pi} \sum_{\substack{n=N+1 \\ \text{odd } n}}^{\infty} \frac{1}{n^2}.$$

### Solution 28.17

1.

$$1 \sim \sum_{n=1}^{\infty} a_n \sin(nx), \quad 0 \leq x \leq \pi$$

Since the odd periodic extension of the function is discontinuous, the Fourier coefficients will decay as  $1/n$ . Because of the symmetry about  $x = \pi/2$ , there will be only odd sine terms.

$$\begin{aligned} a_n &= \frac{2}{\pi} \int_0^{\pi} 1 \cdot \sin(nx) \, dx \\ &= \frac{2}{n\pi} (-\cos(n\pi) + \cos(0)) \\ &= \frac{2}{n\pi} (1 - (-1)^n) \end{aligned}$$

$$1 \sim \frac{4}{\pi} \sum_{\substack{n=1 \\ \text{odd } n}}^{\infty} \frac{\sin(nx)}{n}$$

2. It's always OK to integrate a Fourier series term by term. We integrate the series in part (a).

$$\int_a^x 1 \, dx \sim \frac{4}{\pi} \sum_{\substack{n=1 \\ \text{odd } n}}^{\infty} \int_a^x \frac{\sin(n\xi)}{n} \, dx$$

$$x - a \sim \frac{4}{\pi} \sum_{\substack{n=1 \\ \text{odd } n}}^{\infty} \frac{\cos(na) - \cos(nx)}{n^2}$$

Since the series converges uniformly, we can replace the  $\sim$  with  $=$ .

$$x - a = \frac{4}{\pi} \sum_{\substack{n=1 \\ \text{odd } n}}^{\infty} \frac{\cos(na)}{n^2} - \frac{4}{\pi} \sum_{\substack{n=1 \\ \text{odd } n}}^{\infty} \frac{\cos(nx)}{n^2}$$

Now we have a Fourier cosine series. The first sum on the right is the constant term. If we choose  $a = \pi/2$  this sum vanishes since  $\cos(n\pi/2) = 0$  for odd integer  $n$ .

$$x = \frac{\pi}{2} - \frac{4}{\pi} \sum_{\substack{n=1 \\ \text{odd } n}}^{\infty} \frac{\cos(nx)}{n^2}$$

3. If  $f(x)$  has the Fourier series

$$f(x) \sim \frac{a_0}{2} + \sum_{n=1}^{\infty} (a_n \cos(nx) + b_n \sin(nx)),$$

then Parseval's theorem states that

$$\int_{-\pi}^{\pi} f^2(x) \, dx = \frac{\pi}{2} a_0^2 + \pi \sum_{n=1}^{\infty} (a_n^2 + b_n^2).$$

We apply this to the Fourier sine series from part (a).

$$\int_{-\pi}^{\pi} f^2(x) dx = \pi \sum_{\substack{n=1 \\ \text{odd } n}}^{\infty} \left( \frac{4}{\pi n} \right)^2$$

$$\int_{-\pi}^0 (-1)^2 dx + \int_0^{\pi} (1)^2 dx = \frac{16}{\pi} \sum_{n=1}^{\infty} \frac{1}{(2n-1)^2}$$

$$\sum_{n=1}^{\infty} \frac{1}{(2n-1)^2} = \frac{\pi^2}{8}$$

We substitute  $x = \pi$  in the series from part (b) to corroborate the result.

$$x = \frac{\pi}{2} - \frac{4}{\pi} \sum_{n=1}^{\infty} \frac{\cos((2n-1)x)}{(2n-1)^2}$$

$$\pi = \frac{\pi}{2} - \frac{4}{\pi} \sum_{n=1}^{\infty} \frac{\cos((2n-1)\pi)}{(2n-1)^2}$$

$$\sum_{n=1}^{\infty} \frac{1}{(2n-1)^2} = \frac{\pi^2}{8}$$

### Solution 28.18

1.

$$f(x) \sim a_0 + \sum_{n=1}^{\infty} a_n \cos(nx)$$

Since the periodic extension of the function is discontinuous, the Fourier coefficients will decay like  $1/n$ . Because of the anti-symmetry about  $x = \pi/2$ , there will be only odd cosine terms.

$$a_0 = \frac{1}{\pi} \int_0^{\pi} f(x) dx = \frac{1}{2}$$



$$\begin{aligned}
a_n &= \frac{2}{\pi} \int_0^\pi f(x) \cos(nx) \, dx \\
&= \frac{2}{\pi} \int_0^{\pi/2} \cos(nx) \, dx \\
&= \frac{2}{\pi n} \sin(n\pi/2) \\
&= \begin{cases} \frac{2}{\pi n} (-1)^{(n-1)/2}, & \text{for odd } n \\ 0 & \text{for even } n \end{cases}
\end{aligned}$$

The Fourier cosine series of  $f(x)$  is

$$f(x) \sim \frac{1}{2} + \frac{2}{\pi} \sum_{n=0}^{\infty} \frac{(-1)^n}{2n+1} \cos((2n+1)x).$$

2. The  $N^{\text{th}}$  partial sum is

$$S_N(x) = \frac{1}{2} + \frac{2}{\pi} \sum_{n=0}^N \frac{(-1)^n}{2n+1} \cos((2n+1)x).$$

We wish to evaluate the sum from part (a). First we make the change of variables  $y = x - \pi/2$  to get rid of the

$(-1)^n$  factor.

$$\begin{aligned} & \sum_{n=0}^{\infty} \frac{(-1)^n}{2n+1} \cos((2n+1)x) \\ &= \sum_{n=0}^N \frac{(-1)^n}{2n+1} \cos((2n+1)(y + \pi/2)) \\ &= \sum_{n=0}^N \frac{(-1)^n}{2n+1} (-1)^{n+1} \sin((2n+1)y) \\ &= - \sum_{n=0}^N \frac{1}{2n+1} \sin((2n+1)y) \end{aligned}$$

We write the summand as an integral and interchange the order of summation and integration to get rid of the  $1/(2n+1)$  factor.

$$\begin{aligned}
&= - \sum_{n=0}^N \int_0^y \cos((2n+1)t) dt \\
&= - \int_0^y \sum_{n=0}^N \cos((2n+1)t) dt \\
&= - \int_0^y \left( \sum_{n=1}^{2N+1} \cos(nt) - \sum_{n=1}^N \cos(2nt) \right) dt \\
&= - \int_0^y \Re \left( \sum_{n=1}^{2N+1} e^{int} - \sum_{n=1}^N e^{i2nt} \right) dt \\
&= - \int_0^y \Re \left( \frac{e^{it} - e^{i(2N+2)t}}{1 - e^{it}} - \frac{e^{i2t} - e^{i2(N+1)t}}{1 - e^{i2t}} \right) dt \\
&= - \int_0^y \Re \left( \frac{(e^{it} - e^{i2(N+1)t})(1 - e^{i2t}) - (e^{i2t} - e^{i2(N+1)t})(1 - e^{it})}{(1 - e^{it})(1 - e^{i2t})} \right) dt \\
&= - \int_0^y \Re \left( \frac{e^{it} - e^{i2t} + e^{i(2N+4)t} - e^{i(2N+3)t}}{(1 - e^{it})(1 - e^{i2t})} \right) dt \\
&= - \int_0^y \Re \left( \frac{e^{it} - e^{i(2N+3)t}}{1 - e^{i2t}} \right) dt \\
&= - \int_0^y \Re \left( \frac{e^{i(2N+2)t} - 1}{e^{it} - e^{-it}} \right) dt \\
&= - \int_0^y \Re \left( \frac{-i e^{i2(N+1)t} + i}{2 \sin t} \right) dt \\
&= - \frac{1}{2} \int_0^y \frac{\sin(2(N+1)t)}{\sin t} dt \\
&= - \frac{1}{2} \int_0^{x-\pi/2} \frac{\sin(2(N+1)t)}{\sin t} dt
\end{aligned}$$

Now we have a tidy representation of the partial sum.

$$S_N(x) = \frac{1}{2} - \frac{1}{\pi} \int_0^{x-\pi/2} \frac{\sin(2(N+1)t)}{\sin t} dt$$

3. We solve  $\frac{dS_N(x)}{dx} = 0$  to find the relative extrema of  $S_N(x)$ .

$$\begin{aligned} S'_N(x) &= 0 \\ -\frac{1}{\pi} \frac{\sin(2(N+1)(x-\pi/2))}{\sin(x-\pi/2)} &= 0 \\ \frac{(-1)^{N+1} \sin(2(N+1)x)}{-\cos(x)} &= 0 \\ \frac{\sin(2(N+1)x)}{\cos(x)} &= 0 \end{aligned}$$

$$x = x_n = \frac{n\pi}{2(N+1)}, \quad n = 0, 1, \dots, N, N+2, \dots, 2N+2$$

Note that  $x_{N+1} = \pi/2$  is not a solution as the denominator vanishes there. The function has a removable singularity at  $x = \pi/2$  with limiting value  $(-1)^N$ .

4.

$$S_N(x_N) = \frac{1}{2} - \frac{1}{\pi} \int_0^{\frac{\pi N}{2(N+1)} - \pi/2} \frac{\sin(2(N+1)t)}{\sin t} dt$$

We note that the integrand is even.

$$\int_0^{\frac{\pi N}{2(N+1)} - \pi/2} = \int_0^{-\frac{\pi}{2(N+1)}} = - \int_0^{\frac{\pi}{2(N+1)}}$$

$$S_N(x_N) = \frac{1}{2} + \frac{1}{\pi} \int_0^{\frac{\pi}{2(N+1)}} \frac{\sin(2(N+1)t)}{\sin t} dt$$

5. We make the change of variables  $2(N + 1)t \rightarrow t$ .

$$S_N(x_N) = \frac{1}{2} + \frac{1}{\pi} \int_0^\pi \frac{\sin(t)}{2(N + 1) \sin(t/(2(N + 1)))} dt$$

Note that

$$\lim_{\epsilon \rightarrow 0} \frac{\sin(\epsilon t)}{\epsilon} = \lim_{\epsilon \rightarrow 0} \frac{t \cos(\epsilon t)}{1} = t$$

$$S_N(x_N) \rightarrow \frac{1}{2} + \frac{1}{\pi} \int_0^\pi \frac{\sin(t)}{t} dt \approx 1.0895 \quad \text{as } N \rightarrow \infty$$

This is not equal to the limiting value of  $f(x)$ ,  $f(\pi/2 - 0) = 1$ .

### Solution 28.19

With the parametrization in  $t$ ,  $x(t)$  and  $y(t)$  are continuous functions on the range  $[0, 2\pi]$ . Since the curve is closed, we have  $x(0) = x(2\pi)$  and  $y(0) = y(2\pi)$ . This means that the periodic extensions of  $x(t)$  and  $y(t)$  are continuous functions. Thus we can differentiate their Fourier series. First we define formal Fourier series for  $x(t)$  and  $y(t)$ .

$$x(t) = \frac{a_0}{2} + \sum_{n=1}^{\infty} (a_n \cos(nt) + b_n \sin(nt))$$

$$y(t) = \frac{c_0}{2} + \sum_{n=1}^{\infty} (c_n \cos(nt) + d_n \sin(nt))$$

$$x'(t) = \sum_{n=1}^{\infty} (nb_n \cos(nt) - na_n \sin(nt))$$

$$y'(t) = \sum_{n=1}^{\infty} (nd_n \cos(nt) - nc_n \sin(nt))$$

In this problem we will be dealing with integrals on  $[0, 2\pi]$  of products of Fourier series. We derive a general formula

for later use.

$$\begin{aligned}\int_0^{2\pi} xy \, dt &= \int_0^{2\pi} \left( \frac{a_0}{2} + \sum_{n=1}^{\infty} (a_n \cos(nt) + b_n \sin(nt)) \right) \left( \frac{c_0}{2} + \sum_{n=1}^{\infty} (c_n \cos(nt) + d_n \sin(nt)) \right) dt \\ &= \int_0^{2\pi} \left( \frac{a_0 c_0}{4} + \sum_{n=1}^{\infty} (a_n c_n \cos^2(nt) + b_n d_n \sin^2(nt)) \right) dt \\ &= \pi \left( \frac{1}{2} a_0 c_0 + \sum_{n=1}^{\infty} (a_n c_n + b_n d_n) \right)\end{aligned}$$

In the arclength parametrization we have

$$\left( \frac{dx}{ds} \right)^2 + \left( \frac{dy}{ds} \right)^2 = 1.$$

In terms of  $t = 2\pi s/L$  this is

$$\left( \frac{dx}{dt} \right)^2 + \left( \frac{dy}{dt} \right)^2 = \left( \frac{L}{2\pi} \right)^2.$$

We integrate this identity on  $[0, 2\pi]$ .

$$\begin{aligned}\frac{L^2}{2\pi} &= \int_0^{2\pi} \left( \left( \frac{dx}{dt} \right)^2 + \left( \frac{dy}{dt} \right)^2 \right) dt \\ &= \pi \left( \sum_{n=1}^{\infty} ((nb_n)^2 + (-na_n)^2) + \sum_{n=1}^{\infty} ((nd_n)^2 + (-nc_n)^2) \right) \\ &= \pi \sum_{n=1}^{\infty} n^2 (a_n^2 + b_n^2 + c_n^2 + d_n^2) \\ &= 2\pi^2 \sum_{n=1}^{\infty} n^2 (a_n^2 + b_n^2 + c_n^2 + d_n^2)\end{aligned}$$

We assume that the curve is parametrized so that the area is positive. (Reversing the orientation changes the sign of the area as defined above.) The area is

$$\begin{aligned} A &= \int_0^{2\pi} x \frac{dy}{dt} dt \\ &= \int_0^{2\pi} \left( \frac{a_0}{2} + \sum_{n=1}^{\infty} (a_n \cos(nt) + b_n \sin(nt)) \right) \left( \sum_{n=1}^{\infty} (nd_n \cos(nt) - nc_n \sin(nt)) \right) dt \\ &= \pi \sum_{n=1}^{\infty} n(a_n d_n - b_n c_n) \end{aligned}$$

Now we find an upper bound on the area. We will use the inequality  $|ab| \leq \frac{1}{2}|a^2 + b^2|$ , which follows from expanding  $(a - b)^2 \geq 0$ .

$$\begin{aligned} A &\leq \frac{\pi}{2} \sum_{n=1}^{\infty} n (a_n^2 + b_n^2 + c_n^2 + d_n^2) \\ &\leq \frac{\pi}{2} \sum_{n=1}^{\infty} n^2 (a_n^2 + b_n^2 + c_n^2 + d_n^2) \end{aligned}$$

We can express this in terms of the perimeter.

$$= \frac{L^2}{4\pi}$$

$$\boxed{L^2 \geq 4\pi A}$$

Now we determine the curves for which  $L^2 = 4\pi A$ . To do this we find conditions for which  $A$  is equal to the upper bound we obtained for it above. First note that

$$\sum_{n=1}^{\infty} n (a_n^2 + b_n^2 + c_n^2 + d_n^2) = \sum_{n=1}^{\infty} n^2 (a_n^2 + b_n^2 + c_n^2 + d_n^2)$$

implies that all the coefficients except  $a_0$ ,  $c_0$ ,  $a_1$ ,  $b_1$ ,  $c_1$  and  $d_1$  are zero. The constraint,

$$\pi \sum_{n=1}^{\infty} n(a_n d_n - b_n c_n) = \frac{\pi}{2} \sum_{n=1}^{\infty} n(a_n^2 + b_n^2 + c_n^2 + d_n^2)$$

then becomes

$$a_1 d_1 - b_1 c_1 = a_1^2 + b_1^2 + c_1^2 + d_1^2.$$

This implies that  $d_1 = a_1$  and  $c_1 = -b_1$ .  $a_0$  and  $c_0$  are arbitrary. Thus curves for which  $L^2 = 4\pi A$  have the parametrization

$$x(t) = \frac{a_0}{2} + a_1 \cos t + b_1 \sin t, \quad y(t) = \frac{c_0}{2} - b_1 \cos t + a_1 \sin t.$$

Note that

$$\left(x(t) - \frac{a_0}{2}\right)^2 + \left(y(t) - \frac{c_0}{2}\right)^2 = a_1^2 + b_1^2.$$

The curve is a circle of radius  $\sqrt{a_1^2 + b_1^2}$  and center  $(a_0/2, c_0/2)$ .

### Solution 28.20

1. The Fourier sine series has the form

$$x(1-x) = \sum_{n=1}^{\infty} a_n \sin(n\pi x).$$

The norm of the eigenfunctions is

$$\int_0^1 \sin^2(n\pi x) dx = \frac{1}{2}.$$

The coefficients in the expansion are

$$\begin{aligned} a_n &= 2 \int_0^1 x(1-x) \sin(n\pi x) dx \\ &= \frac{2}{\pi^3 n^3} (2 - 2 \cos(n\pi) - n\pi \sin(n\pi)) \\ &= \frac{4}{\pi^3 n^3} (1 - (-1)^n). \end{aligned}$$



Thus the Fourier sine series is

$$x(1-x) = \frac{8}{\pi^3} \sum_{\substack{n=1 \\ \text{odd } n}}^{\infty} \frac{\sin(n\pi x)}{n^3} = \frac{8}{\pi^3} \sum_{n=1}^{\infty} \frac{\sin((2n-1)\pi x)}{(2n-1)^3}.$$

The Fourier cosine series has the form

$$x(1-x) = \sum_{n=0}^{\infty} a_n \cos(n\pi x).$$

The norm of the eigenfunctions is

$$\int_0^1 1^2 dx = 1, \quad \int_0^1 \cos^2(n\pi x) dx = \frac{1}{2}.$$

The coefficients in the expansion are

$$a_0 = \int_0^1 x(1-x) dx = \frac{1}{6},$$

$$\begin{aligned} a_n &= 2 \int_0^1 x(1-x) \cos(n\pi x) dx \\ &= -\frac{2}{\pi^2 n^2} + \frac{4 \sin(n\pi) - n\pi \cos(n\pi)}{\pi^3 n^3} \\ &= -\frac{2}{\pi^2 n^2} (1 + (-1)^n) \end{aligned}$$

Thus the Fourier cosine series is

$$x(1-x) = \frac{1}{6} - \frac{4}{\pi^2} \sum_{\substack{n=1 \\ \text{even } n}}^{\infty} \frac{\cos(n\pi x)}{n^2} = \frac{1}{6} - \frac{1}{\pi^2} \sum_{n=1}^{\infty} \frac{\cos(2n\pi x)}{n^2}.$$

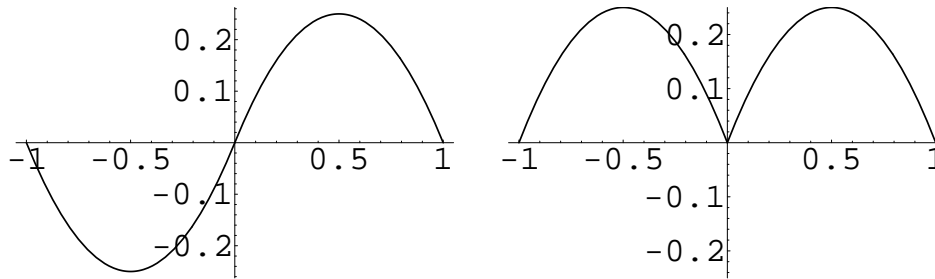

Figure 28.13: The odd and even periodic extension of  $x(1-x)$ ,  $0 \leq x \leq 1$ .

The Fourier sine series converges to the odd periodic extension of the function. Since this function is  $C^1$ , continuously differentiable, we know that the Fourier coefficients must decay as  $1/n^3$ . The Fourier cosine series converges to the even periodic extension of the function. Since this function is only  $C^0$ , continuous, the Fourier coefficients must decay as  $1/n^2$ . The odd and even periodic extensions are shown in Figure 28.13. The sine series is better because of the faster convergence of the series.

2. (a) We substitute  $x = 0$  into the cosine series.

$$0 = \frac{1}{6} - \frac{1}{\pi^2} \sum_{n=1}^{\infty} \frac{1}{n^2}$$

$$\boxed{\sum_{n=1}^{\infty} \frac{1}{n^2} = \frac{\pi^2}{6}}$$

(b) We substitute  $x = 1/2$  into the cosine series.

$$\frac{1}{4} = \frac{1}{6} - \frac{1}{\pi^2} \sum_{n=1}^{\infty} \frac{\cos(n\pi)}{n^2}$$

$$\boxed{\sum_{n=1}^{\infty} \frac{(-1)^n}{n^2} = -\frac{\pi^2}{12}}$$

(c) We substitute  $x = 1/2$  into the sine series.

$$\frac{1}{4} = \frac{8}{\pi^3} \sum_{n=1}^{\infty} \frac{\sin((2n-1)\pi/2)}{(2n-1)^3}$$

$$\boxed{\sum_{n=1}^{\infty} \frac{(-1)^n}{(2n-1)^3} = -\frac{\pi^3}{32}}$$

# Chapter 29

## Regular Sturm-Liouville Problems

I learned there are troubles  
Of more than one kind.  
Some come from ahead  
And some come from behind.

But I've bought a big bat.  
I'm all ready, you see.  
Now my troubles are going  
To have troubles with *me!*

*-I Had Trouble in Getting to Solla Sollew*  
-Theodor S. Geisel, (Dr. Seuss)

### 29.1 Derivation of the Sturm-Liouville Form

Consider the eigenvalue problem on the finite interval  $[a \dots b]$ ,

$$p_2(x)y'' + p_1(x)y' + p_0(x)y = \mu y,$$

subject to the homogeneous unmixed boundary conditions

$$\alpha_1 y(a) + \alpha_2 y'(a) = 0, \quad \beta_1 y(b) + \beta_2 y'(b) = 0.$$

Here the coefficient functions  $p_j$  are real and continuous and  $p_2 > 0$  on the interval  $[a \dots b]$ . (Note that if  $p_2$  were negative we could multiply the equation by  $(-1)$  and replace  $\mu$  by  $-\mu$ .) The parameters  $\alpha_j$  and  $\beta_j$  are real.

We would like to write this problem in a form that can be used to obtain qualitative information about the problem. First we will write the operator in self-adjoint form. We divide by  $p_2$  since it is non-vanishing.

$$y'' + \frac{p_1}{p_2} y' + \frac{p_0}{p_2} y = \frac{\mu}{p_2} y.$$

We multiply by an integrating factor.

$$\begin{aligned} I &= \exp\left(\int \frac{p_1}{p_2} dx\right) \equiv e^{P(x)} \\ e^{P(x)} \left(y'' + \frac{p_1}{p_2} y' + \frac{p_0}{p_2} y\right) &= e^{P(x)} \frac{\mu}{p_2} y \\ (e^{P(x)} y')' + e^{P(x)} \frac{p_0}{p_2} y &= e^{P(x)} \frac{\mu}{p_2} y \end{aligned}$$

For notational convenience, we define new coefficient functions and parameters.

$$p = e^{P(x)}, \quad q = e^{P(x)} \frac{p_0}{p_2}, \quad \sigma = e^{P(x)} \frac{1}{p_2}, \quad \lambda = -\mu.$$

Since the  $p_j$  are continuous and  $p_2$  is positive,  $p$ ,  $q$ , and  $\sigma$  are continuous.  $p$  and  $\sigma$  are positive functions. The problem now has the form,

$$(py')' + qy + \lambda\sigma y = 0,$$

subject to the same boundary conditions,

$$\alpha_1 y(a) + \alpha_2 y'(a) = 0, \quad \beta_1 y(b) + \beta_2 y'(b) = 0.$$

This is known as a *Regular Sturm-Liouville* problem. We will devote much of this chapter to studying the properties of this problem. We will encounter many results that are analogous to the properties of self-adjoint eigenvalue problems.

### Example 29.1.1

$$\frac{d}{dx} \left( \ln x \frac{dy}{dx} \right) + \lambda xy = 0, \quad y(1) = y(2) = 0$$

is not a regular Sturm-Liouville problem since  $\ln x$  vanishes at  $x = 1$ .

**Result 29.1.1** Any eigenvalue problem of the form

$$\begin{aligned} p_2 y'' + p_1 y' + p_0 y &= \mu y, \quad \text{for } a \leq x \leq b, \\ \alpha_1 y(a) + \alpha_2 y'(a) &= 0, \quad \beta_1 y(b) + \beta_2 y'(b) = 0, \end{aligned}$$

where the  $p_j$  are real and continuous and  $p_2 > 0$  on  $[a, b]$ , and the  $\alpha_j$  and  $\beta_j$  are real can be written in the form of a regular Sturm-Liouville problem,

$$\begin{aligned} (py')' + qy + \lambda \sigma y &= 0, \quad \text{on } a \leq x \leq b, \\ \alpha_1 y(a) + \alpha_2 y'(a) &= 0, \quad \beta_1 y(b) + \beta_2 y'(b) = 0. \end{aligned}$$

## 29.2 Properties of Regular Sturm-Liouville Problems

**Self-Adjoint.** Consider the Regular Sturm-Liouville equation.

$$L[y] \equiv (py')' + qy = -\lambda \sigma y.$$

We see that the operator is formally self-adjoint. Now we determine if the problem is self-adjoint.

$$\begin{aligned}
 \langle v|L[u]\rangle - \langle L[v]|u\rangle &= \langle v|(pu')' + qu\rangle - \langle (pv)' + qv|u\rangle \\
 &= [\bar{v}pu']_a^b - \langle \bar{v}'|pu'\rangle + \langle \bar{v}|qu\rangle - [p\bar{v}'u]_a^b + \langle p\bar{v}'|u'\rangle - \langle q\bar{v}|u\rangle \\
 &= [\bar{v}pu']_a^b - [p\bar{v}'u]_a^b \\
 &= p(b)(\bar{v}(b)u'(b) - \bar{v}'(b)u(b)) + p(a)(\bar{v}(a)u'(a) - \bar{v}'(a)u(a)) \\
 &= p(b)\left(\bar{v}(b)\left(-\frac{\beta_1}{\beta_2}\right)u(b) - \left(-\frac{\beta_1}{\beta_2}\right)\bar{v}(b)u(b)\right) \\
 &\quad + p(a)\left(\bar{v}(a)\left(-\frac{\alpha_1}{\alpha_2}\right)u(a) - \left(-\frac{\alpha_1}{\alpha_2}\right)\bar{v}(a)u(a)\right) \\
 &= 0
 \end{aligned}$$

Above we used the fact that the  $\alpha_i$  and  $\beta_i$  are real.

$$\overline{\left(\frac{\alpha_1}{\alpha_2}\right)} = \left(\frac{\alpha_1}{\alpha_2}\right), \quad \overline{\left(\frac{\beta_1}{\beta_2}\right)} = \left(\frac{\beta_1}{\beta_2}\right)$$

Thus  $L[y]$  subject to the boundary conditions is self-adjoint.

**Real Eigenvalues.** Let  $\lambda$  be an eigenvalue with the eigenfunction  $\phi$ . We start with Green's formula.

$$\begin{aligned}
 \langle \phi|L[\phi]\rangle - \langle L[\phi]|\phi\rangle &= 0 \\
 \langle \phi|-\lambda\sigma\phi\rangle - \langle -\lambda\sigma\phi|\phi\rangle &= 0 \\
 -\lambda\langle \phi|\sigma|\phi\rangle + \bar{\lambda}\langle \phi|\sigma|\phi\rangle &= 0 \\
 (\bar{\lambda} - \lambda)\langle \phi|\sigma|\phi\rangle &= 0
 \end{aligned}$$

Since  $\langle \phi|\sigma|\phi\rangle > 0$ ,  $\bar{\lambda} - \lambda = 0$ . Thus the eigenvalues are real.

**Infinite Number of Eigenvalues.** There are an infinite of eigenvalues which have no finite cluster point. This result is analogous to the result that we derived for self-adjoint eigenvalue problems. When we cover the Rayleigh quotient, we will find that there is a least eigenvalue. Since the eigenvalues are distinct and have no finite cluster point,  $\lambda_n \rightarrow \infty$  as  $n \rightarrow \infty$ . Thus the eigenvalues form an ordered sequence,

$$\lambda_1 < \lambda_2 < \lambda_3 < \cdots .$$

**Orthogonal Eigenfunctions.** Let  $\lambda$  and  $\mu$  be two distinct eigenvalues with the eigenfunctions  $\phi$  and  $\psi$ . Green's formula states

$$\begin{aligned} \langle \psi | L[\phi] \rangle - \langle L[\psi] | \phi \rangle &= 0. \\ \langle \psi | -\lambda \sigma \phi \rangle - \langle -\mu \sigma \psi | \phi \rangle &= 0 \\ -\lambda \langle \psi | \sigma | \phi \rangle + \bar{\mu} \langle \psi | \sigma | \phi \rangle &= 0 \\ (\mu - \lambda) \langle \psi | \sigma | \phi \rangle &= 0 \end{aligned}$$

Since the eigenvalues are distinct,  $\langle \psi | \sigma | \phi \rangle = 0$ . Thus eigenfunctions corresponding to distinct eigenvalues are orthogonal with respect to  $\sigma$ .

**Unique Eigenfunctions.** Let  $\lambda$  be an eigenvalue. Suppose  $\phi$  and  $\psi$  are two independent eigenfunctions corresponding to  $\lambda$ .

$$L[\phi] + \lambda \sigma \phi = 0, \quad L[\psi] + \lambda \sigma \psi = 0$$

We take the difference of  $\psi$  times the first equation and  $\phi$  times the second equation.

$$\begin{aligned} \psi L[\phi] - \phi L[\psi] &= 0 \\ \psi(p\phi)' - \phi(p\psi)' &= 0 \\ (p(\psi\phi' - \psi'\phi))' &= 0 \\ p(\psi\phi' - \psi'\phi) &= \text{const} \end{aligned}$$

In order to satisfy the boundary conditions, the constant must be zero.

$$p(\psi\phi' - \psi'\phi) = 0$$



Since  $p > 0$  the second factor vanishes.

$$\begin{aligned}\psi\phi' - \psi'\phi &= 0 \\ \frac{\phi'}{\psi} - \frac{\psi'\phi}{\psi^2} &= 0 \\ \frac{d}{dx} \left( \frac{\phi}{\psi} \right) &= 0 \\ \frac{\phi}{\psi} &= \text{const}\end{aligned}$$

$\phi$  and  $\psi$  are not independent. Thus each eigenvalue has a unique, (to within a multiplicative constant), eigenfunction.

**Real Eigenfunctions.** If  $\lambda$  is an eigenvalue with eigenfunction  $\phi$ , then

$$(p\phi')' + q\phi + \lambda\sigma\phi = 0.$$

We take the complex conjugate of this equation.

$$\left( p\bar{\phi}' \right)' + q\bar{\phi} + \lambda\sigma\bar{\phi} = 0.$$

Thus  $\bar{\phi}$  is also an eigenfunction corresponding to  $\lambda$ . Are  $\phi$  and  $\bar{\phi}$  independent functions, or do they just differ by a multiplicative constant? (For example,  $e^{ix}$  and  $e^{-ix}$  are independent functions, but  $ix$  and  $-ix$  are dependent.) From our argument on unique eigenfunctions, we see that

$$\phi = (\text{const})\bar{\phi}.$$

Since  $\phi$  and  $\bar{\phi}$  only differ by a multiplicative constant, the eigenfunctions can be chosen so that they are real-valued functions.

**Rayleigh's Quotient.** Let  $\lambda$  be an eigenvalue with the eigenfunction  $\phi$ .

$$\begin{aligned}\langle \phi | L[\phi] \rangle &= \langle \phi | -\lambda \sigma \phi \rangle \\ \langle \phi | (p\phi)' + q\phi \rangle &= -\lambda \langle \phi | \sigma | \phi \rangle \\ \left[ \overline{\phi p \phi'} \right]_a^b - \langle \phi' | p | \phi' \rangle + \langle \phi | q | \phi \rangle &= -\lambda \langle \phi | \sigma | \phi \rangle \\ \lambda &= \frac{-\left[ \overline{p \phi \phi'} \right]_a^b + \langle \phi' | p | \phi' \rangle - \langle \phi | q | \phi \rangle}{\langle \phi | \sigma | \phi \rangle}\end{aligned}$$

This is known as *Rayleigh's quotient*. It is useful for obtaining qualitative information about the eigenvalues.

**Minimum Property of Rayleigh's Quotient.** Note that since  $p$ ,  $q$ ,  $\sigma$  and  $\phi$  are bounded functions, the Rayleigh quotient is bounded below. Thus there is a least eigenvalue. If we restrict  $u$  to be a real continuous function that satisfies the boundary conditions, then

$$\lambda_1 = \min_u \frac{-\left[ \overline{p u u'} \right]_a^b + \langle u' | p | u' \rangle - \langle u | q | u \rangle}{\langle u | \sigma | u \rangle},$$

where  $\lambda_1$  is the least eigenvalue. This form allows us to get upper and lower bounds on  $\lambda_1$ .

To derive this formula, we first write it in terms of the operator  $L$ .

$$\lambda_1 = \min_u \frac{-\langle u | L[u] \rangle}{\langle u | \sigma | u \rangle}$$

Since  $u$  is continuous and satisfies the boundary conditions, we can expand  $u$  in a series of the eigenfunctions.

$$\begin{aligned}-\frac{\langle u | L[u] \rangle}{\langle u | \sigma | u \rangle} &= -\frac{\langle \sum_{n=1}^{\infty} c_n \phi_n | L[\sum_{m=1}^{\infty} c_m \phi_m] \rangle}{\langle \sum_{n=1}^{\infty} c_n \phi_n | \sigma | \sum_{m=1}^{\infty} c_m \phi_m \rangle} \\ &= -\frac{\langle \sum_{n=1}^{\infty} c_n \phi_n | -\sum_{m=1}^{\infty} c_m \lambda_m \sigma \phi_m \rangle}{\langle \sum_{n=1}^{\infty} c_n \phi_n | \sigma | \sum_{m=1}^{\infty} c_m \phi_m \rangle}\end{aligned}$$

We assume that we can interchange summation and integration.

$$\begin{aligned}
 &= \frac{\sum_{n=1}^{\infty} \sum_{m=1}^{\infty} \overline{c_n} c_m \lambda_n \langle \phi_m | \sigma | \phi_n \rangle}{\sum_{n=1}^{\infty} \sum_{m=1}^{\infty} \overline{c_n} c_m \langle \phi_m | \sigma | \phi_n \rangle} \\
 &= \frac{\sum_{n=1}^{\infty} |c_n|^2 \lambda_n \langle \phi_n | \sigma | \phi_n \rangle}{\sum_{n=1}^{\infty} |c_n|^2 \langle \phi_n | \sigma | \phi_n \rangle} \\
 &\leq \lambda_1 \frac{\sum_{n=1}^{\infty} |c_n|^2 \langle \phi_n | \sigma | \phi_n \rangle}{\sum_{n=1}^{\infty} |c_n|^2 \langle \phi_n | \sigma | \phi_n \rangle} \\
 &= \lambda_1
 \end{aligned}$$

We see that the minimum value of Rayleigh's quotient is  $\lambda_1$ . The minimum is attained when  $c_n = 0$  for all  $n \geq 2$ , that is, when  $u = c_1 \phi_1$ .

**Completeness.** The set of the eigenfunctions of a regular Sturm-Liouville problem is complete. That is, any piecewise continuous function defined on  $[a, b]$  can be expanded in a series of the eigenfunctions,

$$f(x) \sim \sum_{n=1}^{\infty} c_n \phi_n(x),$$

where the  $c_n$  are the generalized Fourier coefficients,

$$c_n = \frac{\langle \phi_n | \sigma | f \rangle}{\langle \phi_n | \sigma | \phi_n \rangle}.$$

Here the sum is convergent in the mean. For any fixed  $x$ , the sum converges to  $\frac{1}{2}(f(x^-) + f(x^+))$ . If  $f(x)$  is continuous and satisfies the boundary conditions, then the convergence is uniform.

**Result 29.2.1** Properties of regular Sturm-Liouville problems.

- The eigenvalues  $\lambda$  are real.
- There are an infinite number of eigenvalues

$$\lambda_1 < \lambda_2 < \lambda_3 < \dots .$$

There is a least eigenvalue  $\lambda_1$  but there is no greatest eigenvalue, ( $\lambda_n \rightarrow \infty$  as  $n \rightarrow \infty$ ).

- For each eigenvalue, there is one unique, (to within a multiplicative constant), eigenfunction  $\phi_n$ . The eigenfunctions can be chosen to be real-valued. (Assume the  $\phi_n$  following are real-valued.) The eigenfunction  $\phi_n$  has exactly  $n - 1$  zeros in the open interval  $a < x < b$ .
- The eigenfunctions are orthogonal with respect to the weighting function  $\sigma(x)$ .

$$\int_a^b \phi_n(x)\phi_m(x)\sigma(x) dx = 0 \quad \text{if } n \neq m.$$

- The eigenfunctions are complete. Any piecewise continuous function  $f(x)$  defined on  $a \leq x \leq b$  can be expanded in a series of eigenfunctions

$$f(x) \sim \sum_{n=1}^{\infty} c_n \phi_n(x),$$

where

$$c_n = \frac{\int_a^b f(x)\phi_n(x)\sigma(x) dx}{\int_a^b \phi_n^2(x)\sigma(x) dx}.$$

The sum converges to  $\frac{1}{2}(f(x^-) + f(x^+))$ .

**Example 29.2.1** A simple example of a Sturm-Liouville problem is

$$\frac{d}{dx} \left( \frac{dy}{dx} \right) + \lambda y = 0, \quad y(0) = y(\pi) = 0.$$

**Bounding The Least Eigenvalue.** The Rayleigh quotient for the first eigenvalue is

$$\lambda_1 = \frac{\int_0^\pi (\phi_1')^2 dx}{\int_0^\pi \phi_1^2 dx}.$$

Immediately we see that the eigenvalues are non-negative. If  $\int_0^\pi (\phi_1')^2 dx = 0$  then  $\phi = (\text{const})$ . The only constant that satisfies the boundary conditions is  $\phi = 0$ . Since the trivial solution is not an eigenfunction,  $\lambda = 0$  is not an eigenvalue. Thus all the eigenvalues are positive.

Now we get an upper bound for the first eigenvalue.

$$\lambda_1 = \min_u \frac{\int_0^\pi (u')^2 dx}{\int_0^\pi u^2 dx}$$

where  $u$  is continuous and satisfies the boundary conditions. We choose  $u = x(x - \pi)$  as a trial function.

$$\begin{aligned} \lambda_1 &\leq \frac{\int_0^\pi (u')^2 dx}{\int_0^\pi u^2 dx} \\ &= \frac{\int_0^\pi (2x - \pi)^2 dx}{\int_0^\pi (x^2 - \pi x)^2 dx} \\ &= \frac{\pi^3/3}{\pi^5/30} \\ &= \frac{10}{\pi^2} \\ &\approx 1.013 \end{aligned}$$

**Finding the Eigenvalues and Eigenfunctions.** We consider the cases of negative, zero, and positive eigenvalues to check our results above.

$\lambda < 0$ . The general solution is

$$y = ce^{\sqrt{-\lambda}x} + de^{-\sqrt{-\lambda}x}.$$

The only solution that satisfies the boundary conditions is the trivial solution,  $y = 0$ . Thus there are no negative eigenvalues.

$\lambda = 0$ . The general solution is

$$y = c + dx.$$

Again only the trivial solution satisfies the boundary conditions, so  $\lambda = 0$  is not an eigenvalue.

$\lambda > 0$ . The general solution is

$$y = c \cos(\sqrt{\lambda}x) + d \sin(\sqrt{\lambda}x).$$

We apply the boundary conditions.

$$y(0) = 0 \quad \rightarrow \quad c = 0$$

$$y(\pi) = 0 \quad \rightarrow \quad d \sin(\sqrt{\lambda}\pi) = 0$$

The nontrivial solutions are

$$\sqrt{\lambda} = n = 1, 2, 3, \dots \quad y = d \sin(n\pi).$$

Thus the eigenvalues and eigenfunctions are

$$\lambda_n = n^2, \quad \phi_n = \sin(nx), \quad \text{for } n = 1, 2, 3, \dots$$

We can verify that this example satisfies all the properties listed in Result 29.2.1. Note that there are an infinite number of eigenvalues. There is a least eigenvalue  $\lambda_1 = 1$  but there is no greatest eigenvalue. For each eigenvalue, there is one eigenfunction. The  $n^{\text{th}}$  eigenfunction  $\sin(nx)$  has  $n - 1$  zeroes in the interval  $0 < x < \pi$ .

Since a series of the eigenfunctions is the familiar Fourier sine series, we know that the eigenfunctions are orthogonal and complete. We check Rayleigh's quotient.

$$\begin{aligned}\lambda_n &= \frac{-p\phi_n \frac{d\phi_n}{dx} \Big|_0^\pi + \int_0^\pi \left( p \left( \frac{d\phi_n}{dx} \right)^2 - q\phi_n^2 \right) dx}{\int_0^\pi \phi_n^2 \sigma dx} \\ &= \frac{-\sin(nx) \frac{d(\sin(nx))}{dx} \Big|_0^\pi + \int_0^\pi \left( \left( \frac{d(\sin(nx))}{dx} \right)^2 \right) dx}{\int_0^\pi \sin^2(nx) dx} \\ &= \frac{\int_0^\pi n^2 \cos^2(nx) dx}{\pi/2} \\ &= n^2\end{aligned}$$

**Example 29.2.2** Consider the eigenvalue problem

$$x^2 y'' + xy' + y = \mu y, \quad y(1) = y(2) = 0.$$

Since  $x^2 > 0$  on  $[1 \dots 2]$ , we can write this problem in terms of a regular Sturm-Liouville eigenvalue problem. We divide by  $x^2$ .

$$y'' + \frac{1}{x} y' + \frac{1}{x^2} (1 - \mu) y = 0$$

We multiply by the integrating factor  $\exp(\int \frac{1}{x} dx) = \exp(\ln x) = x$  and make the substitution,  $\lambda = 1 - \mu$  to obtain the Sturm-Liouville form.

$$\begin{aligned}xy'' + y' + \lambda \frac{1}{x} y &= 0 \\ (xy')' + \lambda \frac{1}{x} y &= 0\end{aligned}$$

We see that the eigenfunctions will be orthogonal with respect to the weighting function  $\sigma = 1/x$ .

The Rayleigh quotient is

$$\begin{aligned}\lambda &= \frac{-[p\bar{\phi}\phi']_a^b + \langle\phi'|x|\phi'\rangle}{\langle\phi|\frac{1}{x}|\phi\rangle} \\ &= \frac{\langle\phi'|x|\phi'\rangle}{\langle\phi|\frac{1}{x}|\phi\rangle}.\end{aligned}$$

If  $\phi' = 0$ , then only the trivial solution,  $\phi = 0$ , satisfies the boundary conditions. Thus the eigenvalues  $\lambda$  are positive.

Returning to the original problem, we see that the eigenvalues,  $\mu$ , satisfy  $\mu < 1$ . Since this is an Euler equation, we can find solutions with the substitution  $y = x^\alpha$ .

$$\begin{aligned}\alpha(\alpha - 1) + \alpha + 1 - \mu &= 0 \\ \alpha^2 + 1 - \mu &= 0\end{aligned}$$

Note that  $\mu < 1$ .

$$\alpha = \pm i\sqrt{1 - \mu}$$

The general solution is

$$y = c_1 x^{i\sqrt{1-\mu}} + c_2 x^{-i\sqrt{1-\mu}}.$$

We know that the eigenfunctions can be written as real functions. We rewrite the solution.

$$y = c_1 e^{i\sqrt{1-\mu}\ln x} + c_2 e^{-i\sqrt{1-\mu}\ln x}$$

An equivalent form is

$$y = c_1 \cos(\sqrt{1 - \mu} \ln x) + c_2 \sin(\sqrt{1 - \mu} \ln x).$$

We apply the boundary conditions.

$$\begin{aligned}y(1) = 0 &\quad \rightarrow \quad c_1 = 0 \\ y(2) = 0 &\quad \rightarrow \quad \sin(\sqrt{1 - \mu} \ln 2) = 0 \\ &\quad \rightarrow \quad \sqrt{1 - \mu} \ln 2 = n\pi, \quad \text{for } n = 1, 2, \dots\end{aligned}$$



Thus the eigenvalues and eigenfunctions are

$$\mu_n = 1 - \left(\frac{n\pi}{\ln 2}\right)^2, \quad \phi_n = \sin\left(n\pi \frac{\ln x}{\ln 2}\right) \quad \text{for } n = 1, 2, \dots$$

## 29.3 Solving Differential Equations With Eigenfunction Expansions

**Linear Algebra.** Consider the eigenvalue problem,

$$\mathbf{A}\mathbf{x} = \lambda\mathbf{x}.$$

If the matrix  $\mathbf{A}$  has a complete, orthonormal set of eigenvectors  $\{\mathbf{x}^{i_k}\}$  with eigenvalues  $\{\lambda_k\}$  then we can represent any vector as a linear combination of the eigenvectors.

$$\mathbf{y} = \sum_{k=1}^n a_k \mathbf{x}^{i_k}, \quad a_k = \mathbf{x}^{i_k} \cdot \mathbf{y}$$

$$\mathbf{y} = \sum_{k=1}^n (\mathbf{x}^{i_k} \cdot \mathbf{y}) \mathbf{x}^{i_k}$$

This property allows us to solve the inhomogeneous equation

$$\mathbf{A}\mathbf{x} - \mu\mathbf{x} = \mathbf{b}. \tag{29.1}$$

Before we try to solve this equation, we should consider the existence/uniqueness of the solution. If  $\mu$  is not an eigenvalue, then the range of  $L \equiv \mathbf{A} - \mu$  is  $\mathbb{R}^n$ . The problem has a unique solution. If  $\mu$  is an eigenvalue, then the null space of  $L$  is the span of the eigenvectors of  $\mu$ . That is, if  $\mu = \lambda_i$ , then  $\text{nullspace}(L) = \text{span}(\mathbf{x}^{i_1}, \mathbf{x}^{i_2}, \dots, \mathbf{x}^{i_m})$ . ( $\{\mathbf{x}^{i_1}, \mathbf{x}^{i_2}, \dots, \mathbf{x}^{i_m}\}$  are the eigenvectors of  $\lambda_i$ .) If  $\mathbf{b}$  is orthogonal to  $\text{nullspace}(L)$  then Equation 29.1 has a solution, but it is not unique. If  $\mathbf{y}$  is a solution then we can add any linear combination of  $\{\mathbf{x}^{i_j}\}$  to obtain another solution. Thus the solutions have the form

$$\mathbf{x} = \mathbf{y} + \sum_{j=1}^m c_j \mathbf{x}^{i_j}.$$

If  $\mathbf{b}$  is not orthogonal to  $\text{nullspace}(L)$  then Equation 29.1 has no solution.

Now we solve Equation 29.1. We assume that  $\mu$  is not an eigenvalue. We expand the solution  $\mathbf{x}$  and the inhomogeneity in the orthonormal eigenvectors.

$$\mathbf{x} = \sum_{k=1}^n a_k \mathbf{x}i_k, \quad \mathbf{b} = \sum_{k=1}^n b_k \mathbf{x}i_k$$

We substitute the expansions into Equation 29.1.

$$\begin{aligned} \mathbf{A} \sum_{k=1}^n a_k \mathbf{x}i_k - \mu \sum_{k=1}^n a_k \mathbf{x}i_k &= \sum_{k=1}^n b_k \mathbf{x}i_k \\ \sum_{k=1}^n a_k \lambda_k \mathbf{x}i_k - \mu \sum_{k=1}^n a_k \mathbf{x}i_k &= \sum_{k=1}^n b_k \mathbf{x}i_k \\ a_k &= \frac{b_k}{\lambda_k - \mu} \end{aligned}$$

The solution is

$$\mathbf{x} = \sum_{k=1}^n \frac{b_k}{\lambda_k - \mu} \mathbf{x}i_k.$$

**Inhomogeneous Boundary Value Problems.** Consider the self-adjoint eigenvalue problem,

$$\begin{aligned} Ly &= \lambda y, \quad a < x < b, \\ B_1[y] &= B_2[y] = 0. \end{aligned}$$

If the problem has a complete, orthonormal set of eigenfunctions  $\{\phi_k\}$  with eigenvalues  $\{\lambda_k\}$  then we can represent any square-integrable function as a linear combination of the eigenfunctions.

$$\begin{aligned} f &= \sum_k f_k \phi_k, \quad f_k = \langle \phi_k | f \rangle = \int_a^b \overline{\phi_k(x)} f(x) dx \\ f &= \sum_k \langle \phi_k | f \rangle \phi_k \end{aligned}$$

This property allows us to solve the inhomogeneous differential equation

$$\begin{aligned} Ly - \mu y &= f, & a < x < b, \\ B_1[y] &= B_2[y] = 0. \end{aligned} \tag{29.2}$$

Before we try to solve this equation, we should consider the existence/uniqueness of the solution. If  $\mu$  is not an eigenvalue, then the range of  $L - \mu$  is the space of square-integrable functions. The problem has a unique solution. If  $\mu$  is an eigenvalue, then the null space of  $L$  is the span of the eigenfunctions of  $\mu$ . That is, if  $\mu = \lambda_i$ , then  $\text{nullspace}(L) = \text{span}(\phi_{i_1}, \phi_{i_2}, \dots, \phi_{i_m})$ . ( $\{\phi_{i_1}, \phi_{i_2}, \dots, \phi_{i_m}\}$  are the eigenvalues of  $\lambda_i$ .) If  $f$  is orthogonal to  $\text{nullspace}(L - \mu)$  then Equation 29.2 has a solution, but it is not unique. If  $u$  is a solution then we can add any linear combination of  $\{\phi_{i_j}\}$  to obtain another solution. Thus the solutions have the form

$$y = u + \sum_{j=1}^m c_j \phi_{i_j}.$$

If  $f$  is not orthogonal to  $\text{nullspace}(L - \mu)$  then Equation 29.2 has no solution.

Now we solve Equation 29.2. We assume that  $\mu$  is not an eigenvalue. We expand the solution  $y$  and the inhomogeneity in the orthonormal eigenfunctions.

$$y = \sum_k y_k \phi_k, \quad f = \sum_k f_k \phi_k$$

It would be handy if we could substitute the expansions into Equation 29.2. However, the expansion of a function is not necessarily differentiable. Thus we demonstrate that since  $y$  is  $C^2(a \dots b)$  and satisfies the boundary conditions  $B_1[y] = B_2[y] = 0$ , we are justified in substituting it into the differential equation. In particular, we will show that

$$L[y] = L \left[ \sum_k y_k \phi_k \right] = \sum_k y_k L[\phi_k] = \sum_k y_k \lambda_k \phi_k.$$

To do this we will use Green's identity. If  $u$  and  $v$  are  $C^2(a \dots b)$  and satisfy the boundary conditions  $B_1[y] = B_2[y] = 0$  then

$$\langle u | L[v] \rangle = \langle L[u] | v \rangle.$$

First we assume that we can differentiate  $y$  term-by-term.

$$L[y] = \sum_k y_k \lambda_k \phi_k$$

Now we directly expand  $L[y]$  and show that we get the same result.

$$L[y] = \sum_k c_k \phi_k$$

$$\begin{aligned} c_k &= \langle \phi_k | L[y] \rangle \\ &= \langle L[\phi_k] | y \rangle \\ &= \langle \lambda_k \phi_k | y \rangle \\ &= \lambda_k \langle \phi_k | y \rangle \\ &= \lambda_k y_k \end{aligned}$$

$$L[y] = \sum_k y_k \lambda_k \phi_k$$

The series representation of  $y$  may *not* be differentiable, but we *are* justified in applying  $L$  term-by-term.

Now we substitute the expansions into Equation 29.2.

$$\begin{aligned} L \left[ \sum_k y_k \phi_k \right] - \mu \sum_k y_k \phi_k &= \sum_k f_k \phi_k \\ \sum_k \lambda_k y_k \phi_k - \mu \sum_k y_k \phi_k &= \sum_k f_k \phi_k \\ y_k &= \frac{f_k}{\lambda_k - \mu} \end{aligned}$$

The solution is

$$y = \sum_k \frac{f_k}{\lambda_k - \mu} \phi_k$$

Consider a second order, inhomogeneous problem.

$$L[y] = f(x), \quad B_1[y] = b_1, \quad B_2[y] = b_2$$

We will expand the solution in an orthogonal basis.

$$y = \sum_n a_n \phi_n$$

We would like to substitute the series into the differential equation, but in general we are not allowed to differentiate such series. To get around this, we use integration by parts to move derivatives from the solution  $y$ , to the  $\phi_n$ .

**Example 29.3.1** Consider the problem,

$$y'' + \alpha y = f(x), \quad y(0) = a, \quad y(\pi) = b,$$

where  $\alpha \neq n^2$ ,  $n \in \mathbb{Z}^+$ . We expand the solution in a cosine series.

$$y(x) = \frac{y_0}{\sqrt{\pi}} + \sum_{n=1}^{\infty} y_n \sqrt{\frac{2}{\pi}} \cos(nx)$$

We also expand the inhomogeneous term.

$$f(x) = \frac{f_0}{\sqrt{\pi}} + \sum_{n=1}^{\infty} f_n \sqrt{\frac{2}{\pi}} \cos(nx)$$

We multiply the differential equation by the orthonormal functions and integrate over the interval. We neglect the

special case  $\phi_0 = 1/\sqrt{\pi}$  for now.

$$\begin{aligned}\int_0^\pi \sqrt{\frac{2}{\pi}} \cos(nx) y'' dx + \alpha \int_0^\pi \sqrt{\frac{2}{\pi}} \cos(nx) y dx &= \int_0^\pi \sqrt{\frac{2}{\pi}} f(x) dx \\ \left[ \sqrt{\frac{2}{\pi}} \cos(nx) y'(x) \right]_0^\pi + \int_0^\pi \sqrt{\frac{2}{\pi}} n \sin(nx) y'(x) dx + \alpha y_n &= f_n \\ \sqrt{\frac{2}{\pi}} ((-1)^n y'(\pi) - y'(0)) + \left[ \sqrt{\frac{2}{\pi}} n \sin(nx) y(x) \right]_0^\pi - \int_0^\pi \sqrt{\frac{2}{\pi}} n^2 \cos(nx) y(x) dx + \alpha y_n &= f_n \\ \sqrt{\frac{2}{\pi}} ((-1)^n y'(\pi) - y'(0)) - n^2 y_n + \alpha y_n &= f_n\end{aligned}$$

Unfortunately we don't know the values of  $y'(0)$  and  $y'(\pi)$ .

CONTINUE HERE

## 29.4 Exercises

### Exercise 29.1

Find the eigenvalues and eigenfunctions of

$$y'' + 2\alpha y' + \lambda y = 0, \quad y(a) = y(b) = 0,$$

where  $a < b$ .

Write the problem in Sturm Liouville form. Verify that the eigenvalues and eigenfunctions satisfy the properties of regular Sturm-Liouville problems. Find the coefficients in the expansion of an arbitrary function  $f(x)$  in a series of the eigenfunctions.

[Hint](#), [Solution](#)

### Exercise 29.2

Find the eigenvalues and eigenfunctions of the boundary value problem

$$y'' + \frac{\lambda}{(x+1)^2}y = 0$$

on the interval  $1 \leq x \leq 2$  with boundary conditions  $y(1) = y(2) = 0$ . Discuss how the results satisfy the properties of Sturm-Liouville problems.

[Hint](#), [Solution](#)

### Exercise 29.3

Find the eigenvalues and eigenfunctions of

$$y'' + \frac{2\alpha + 1}{x}y' + \frac{\lambda}{x^2}y = 0, \quad y(a) = y(b) = 0,$$

where  $0 < a < b$ . Write the problem in Sturm Liouville form. Verify that the eigenvalues and eigenfunctions satisfy the properties of regular Sturm-Liouville problems. Find the coefficients in the expansion of an arbitrary function  $f(x)$  in a series of the eigenfunctions.

[Hint](#), [Solution](#)

**Exercise 29.4**

Find the eigenvalues and eigenfunctions of

$$y'' - y' + \lambda y = 0, \quad y(0) = y(1) = 0.$$

Find the coefficients in the expansion of an arbitrary,  $f(x)$ , in a series of the eigenfunctions.

**Hint, Solution**

**Exercise 29.5**

Consider

$$y'' + y = f(x), \quad y(0) = 0, \quad y(1) + y'(1) = 0. \quad (29.3)$$

The associated eigenvalue problem is

$$y'' + y = \mu y \quad y(0) = 0 \quad y(1) + y'(1) = 0.$$

Find the eigenfunctions for this problem and the equation which the eigenvalues must satisfy.

To do this, consider the eigenvalues and eigenfunctions for,

$$y'' + \lambda y = 0, \quad y(0) = 0, \quad y(1) + y'(1) = 0.$$

Show that the transcendental equation for  $\lambda$  has infinitely many roots  $\lambda_1 < \lambda_2 < \lambda_3 < \dots$ . Find the limit of  $\lambda_n$  as  $n \rightarrow \infty$ . How is this limit approached?

Give the general solution of Equation 29.3 in terms of the eigenfunctions.

**Hint, Solution**

**Exercise 29.6**

Consider

$$y'' + y = f(x) \quad y(0) = 0 \quad y(1) + y'(1) = 0.$$

Find the eigenfunctions for this problem and the equation which the eigenvalues satisfy. Give the general solution in terms of these eigenfunctions.

**Hint, Solution**



**Exercise 29.7**

Show that the eigenvalue problem,

$$y'' + \lambda y = 0, \quad y(0) = 0, \quad y'(0) - y(1) = 0,$$

(note the mixed boundary condition), has only one real eigenvalue. Find it and the corresponding eigenfunction. Show that this problem is not self-adjoint. Thus the proof, valid for unmixed, homogeneous boundary conditions, that all eigenvalues are real fails in this case.

**Hint, Solution**

**Exercise 29.8**

Determine the Rayleigh quotient,  $R[\phi]$  for,

$$y'' + \frac{1}{x}y' + \lambda y = 0, \quad |y(0)| < \infty, \quad y(1) = 0.$$

Use the trial function  $\phi = 1 - x$  in  $R[\phi]$  to deduce that the smallest zero of  $J_0(x)$ , the Bessel function of the first kind and order zero, is less than  $\sqrt{6}$ .

**Hint, Solution**

**Exercise 29.9**

Discuss the eigenvalues of the equation

$$y'' + \lambda q(z)y = 0, \quad y(0) = y(\pi) = 0$$

where

$$q(z) = \begin{cases} a > 0, & 0 \leq z \leq l \\ b > 0, & l < z \leq \pi. \end{cases}$$

This is an example that indicates that the results we obtained in class for eigenfunctions and eigenvalues with  $q(z)$  continuous and bounded also hold if  $q(z)$  is simply integrable; that is

$$\int_0^\pi |q(z)| dz$$

is finite.

Hint, Solution

### Exercise 29.10

1. Find conditions on the smooth real functions  $p(x)$ ,  $q(x)$ ,  $r(x)$  and  $s(x)$  so that the eigenvalues,  $\lambda$ , of:

$$\begin{aligned}Lv &\equiv (p(x)v''(x))'' - (q(x)v'(x))' + r(x)v(x) = \lambda s(x)v(x), & a < x < b \\v(a) &= v'(a) = 0 \\v''(b) &= 0, & p(b)v'''(b) - q(b)v'(b) = 0\end{aligned}$$

are positive. Prove the assertion.

2. Show that for any smooth  $p(x)$ ,  $q(x)$ ,  $r(x)$  and  $s(x)$  the eigenfunctions belonging to distinct eigenvalues are orthogonal relative to the weight  $s(x)$ . That is:

$$\int_a^b v_m(x)v_k(x)s(x) dx = 0 \text{ if } \lambda_k \neq \lambda_m.$$

3. Find the eigenvalues and eigenfunctions for:

$$\frac{d^4\phi}{dx^4} = \lambda\phi, \quad \begin{cases} \phi(0) = \phi''(0) = 0, \\ \phi(1) = \phi''(1) = 0. \end{cases}$$

Hint, Solution

## 29.5 Hints

### Hint 29.1

### Hint 29.2

### Hint 29.3

### Hint 29.4

Write the problem in Sturm-Liouville form to show that the eigenfunctions are orthogonal with respect to the weighting function  $\sigma = e^{-x}$ .

### Hint 29.5

Note that the solution is a regular Sturm-Liouville problem and thus the eigenvalues are real. Use the Rayleigh quotient to show that there are only positive eigenvalues. Informally show that there are an infinite number of eigenvalues with a graph.

### Hint 29.6

### Hint 29.7

Find the solution for  $\lambda = 0$ ,  $\lambda < 0$  and  $\lambda > 0$ . A problem is self-adjoint if it satisfies Green's identity.

### Hint 29.8

Write the equation in self-adjoint form. The Bessel equation of the first kind and order zero satisfies the problem,

$$y'' + \frac{1}{x}y' + y = 0, \quad |y(0)| < \infty, \quad y(r) = 0,$$

where  $r$  is a positive root of  $J_0(x)$ . Make the change of variables  $\xi = x/r$ ,  $u(\xi) = y(x)$ .

**Hint 29.9**

**Hint 29.10**

## 29.6 Solutions

### Solution 29.1

Recall that constant coefficient equations are shift invariant. If  $u(x)$  is a solution, then so is  $u(x - c)$ .

We substitute  $y = e^{\gamma x}$  into the constant coefficient equation.

$$\begin{aligned}y'' + 2\alpha y' + \lambda y &= 0 \\ \gamma^2 + 2\alpha\gamma + \lambda &= 0 \\ \gamma &= -\alpha \pm \sqrt{\alpha^2 - \lambda}\end{aligned}$$

First we consider the case  $\lambda = \alpha^2$ . A set of solutions of the differential equation is

$$\{e^{-\alpha x}, x e^{-\alpha x}\}$$

The homogeneous solution that satisfies the left boundary condition  $y(a) = 0$  is

$$y = c(x - a)e^{-\alpha x}.$$

Since only the trivial solution with  $c = 0$  satisfies the right boundary condition,  $\lambda = \alpha^2$  is not an eigenvalue.

Next we consider the case  $\lambda \neq \alpha^2$ . We write

$$\gamma = -\alpha \pm i\sqrt{\lambda - \alpha^2}.$$

Note that  $\Re(\sqrt{\lambda - \alpha^2}) \geq 0$ . A set of solutions of the differential equation is

$$\left\{e^{(-\alpha \pm i\sqrt{\lambda - \alpha^2})x}\right\}$$

By taking the sum and difference of these solutions we obtain a new set of linearly independent solutions.

$$\left\{e^{-\alpha x} \cos\left(\sqrt{\lambda - \alpha^2}x\right), e^{-\alpha x} \sin\left(\sqrt{\lambda - \alpha^2}x\right)\right\}$$

The solution which satisfies the left boundary condition is

$$y = c e^{-\alpha x} \sin\left(\sqrt{\lambda - \alpha^2}(x - a)\right).$$

For nontrivial solutions, the right boundary condition  $y(b) = 0$  imposes the constraint

$$e^{-\alpha b} \sin \left( \sqrt{\lambda - \alpha^2} (b - a) \right) = 0$$
$$\sqrt{\lambda - \alpha^2} (b - a) = n\pi, \quad n \in \mathbb{Z}$$

We have the eigenvalues

$$\lambda_n = \alpha^2 + \left( \frac{n\pi}{b - a} \right)^2, \quad n \in \mathbb{Z}$$

with the eigenfunctions

$$\phi_n = e^{-\alpha x} \sin \left( n\pi \frac{x - a}{b - a} \right).$$

To write the problem in Sturm-Liouville form, we multiply by the integrating factor

$$e^{\int 2\alpha dx} = e^{2\alpha x}.$$

$$\left( e^{2\alpha x} y' \right)' + \lambda e^{2\alpha x} y = 0, \quad y(a) = y(b) = 0$$

Now we verify that the Sturm-Liouville properties are satisfied.

- The eigenvalues

$$\lambda_n = \alpha^2 + \left( \frac{n\pi}{b - a} \right)^2, \quad n \in \mathbb{Z}$$

are real.

- There are an infinite number of eigenvalues

$$\lambda_1 < \lambda_2 < \lambda_3 < \dots,$$
$$\alpha^2 + \left( \frac{\pi}{b - a} \right)^2 < \alpha^2 + \left( \frac{2\pi}{b - a} \right)^2 < \alpha^2 + \left( \frac{3\pi}{b - a} \right)^2 < \dots.$$

There is a least eigenvalue

$$\lambda_1 = \alpha^2 + \left( \frac{\pi}{b-a} \right)^2,$$

but there is no greatest eigenvalue, ( $\lambda_n \rightarrow \infty$  as  $n \rightarrow \infty$ ).

- For each eigenvalue, we found one unique, (to within a multiplicative constant), eigenfunction  $\phi_n$ . We were able to choose the eigenfunctions to be real-valued. The eigenfunction

$$\phi_n = e^{-\alpha x} \sin \left( n\pi \frac{x-a}{b-a} \right).$$

has exactly  $n - 1$  zeros in the open interval  $a < x < b$ .

- The eigenfunctions are orthogonal with respect to the weighting function  $\sigma(x) = e^{2\alpha x}$ .

$$\begin{aligned} \int_a^b \phi_n(x)\phi_m(x)\sigma(x) dx &= \int_a^b e^{-\alpha x} \sin \left( n\pi \frac{x-a}{b-a} \right) e^{-\alpha x} \sin \left( m\pi \frac{x-a}{b-a} \right) e^{2\alpha x} dx \\ &= \int_a^b \sin \left( n\pi \frac{x-a}{b-a} \right) \sin \left( m\pi \frac{x-a}{b-a} \right) dx \\ &= \frac{b-a}{\pi} \int_0^\pi \sin(nx) \sin(mx) dx \\ &= \frac{b-a}{2\pi} \int_0^\pi (\cos((n-m)x) - \cos((n+m)x)) dx \\ &= 0 \quad \text{if } n \neq m \end{aligned}$$

- The eigenfunctions are complete. Any piecewise continuous function  $f(x)$  defined on  $a \leq x \leq b$  can be expanded in a series of eigenfunctions

$$f(x) \sim \sum_{n=1}^{\infty} c_n \phi_n(x),$$

where

$$c_n = \frac{\int_a^b f(x)\phi_n(x)\sigma(x) dx}{\int_a^b \phi_n^2(x)\sigma(x) dx}.$$

The sum converges to  $\frac{1}{2}(f(x^-) + f(x^+))$ . (We do not prove this property.)

- The eigenvalues can be related to the eigenfunctions with the Rayleigh quotient.

$$\begin{aligned} \lambda_n &= \frac{[-p\phi_n \frac{d\phi_n}{dx}]_a^b + \int_a^b \left( p \left( \frac{d\phi_n}{dx} \right)^2 - q\phi_n^2 \right) dx}{\int_a^b \phi_n^2 \sigma dx} \\ &= \frac{\int_a^b \left( e^{2\alpha x} \left( e^{-\alpha x} \left( \frac{n\pi}{b-a} \cos \left( n\pi \frac{x-a}{b-a} \right) - \alpha \sin \left( n\pi \frac{x-a}{b-a} \right) \right) \right)^2 dx}{\int_a^b \left( e^{-\alpha x} \sin \left( n\pi \frac{x-a}{b-a} \right) \right)^2 e^{2\alpha x} dx} \\ &= \frac{\int_a^b \left( \left( \frac{n\pi}{b-a} \right)^2 \cos^2 \left( n\pi \frac{x-a}{b-a} \right) - 2\alpha \frac{n\pi}{b-a} \cos \left( n\pi \frac{x-a}{b-a} \right) \sin \left( n\pi \frac{x-a}{b-a} \right) + \alpha^2 \sin^2 \left( n\pi \frac{x-a}{b-a} \right) \right) dx}{\int_a^b \sin^2 \left( n\pi \frac{x-a}{b-a} \right) dx} \\ &= \frac{\int_0^\pi \left( \left( \frac{n\pi}{b-a} \right)^2 \cos^2(x) - 2\alpha \frac{n\pi}{b-a} \cos(x) \sin(x) + \alpha^2 \sin^2(x) \right) dx}{\int_0^\pi \sin^2(x) dx} \\ &= \alpha^2 + \left( \frac{n\pi}{b-a} \right)^2 \end{aligned}$$

Now we expand a function  $f(x)$  in a series of the eigenfunctions.

$$f(x) \sim \sum_{n=1}^{\infty} c_n e^{-\alpha x} \sin \left( n\pi \frac{x-a}{b-a} \right),$$



where

$$\begin{aligned}c_n &= \frac{\int_a^b f(x)\phi_n(x)\sigma(x) dx}{\int_a^b \phi_n^2(x)\sigma(x) dx} \\ &= \frac{2n}{b-a} \int_a^b f(x) e^{\alpha x} \sin\left(n\pi \frac{x-a}{b-a}\right) dx\end{aligned}$$

### Solution 29.2

This is an Euler equation. We substitute  $y = (x+1)^\alpha$  into the equation.

$$\begin{aligned}y'' + \frac{\lambda}{(x+1)^2}y &= 0 \\ \alpha(\alpha-1) + \lambda &= 0 \\ \alpha &= \frac{1 \pm \sqrt{1-4\lambda}}{2}\end{aligned}$$

First consider the case  $\lambda = 1/4$ . A set of solutions is

$$\left\{ \sqrt{x+1}, \sqrt{x+1} \ln(x+1) \right\}.$$

Another set of solutions is

$$\left\{ \sqrt{x+1}, \sqrt{x+1} \ln\left(\frac{x+1}{2}\right) \right\}.$$

The solution which satisfies the boundary condition  $y(1) = 0$  is

$$y = c\sqrt{x+1} \ln\left(\frac{x+1}{2}\right).$$

Since only the trivial solution satisfies the  $y(2) = 0$ ,  $\lambda = 1/4$  is not an eigenvalue.

Now consider the case  $\lambda \neq 1/4$ . A set of solutions is

$$\left\{ (x+1)^{(1+\sqrt{1-4\lambda})/2}, (x+1)^{(1-\sqrt{1-4\lambda})/2} \right\}.$$

We can write this in terms of the exponential and the logarithm.

$$\left\{ \sqrt{x+1} \exp\left(i \frac{\sqrt{4\lambda-1}}{2} \ln(x+1)\right), \sqrt{x+1} \exp\left(-i \frac{\sqrt{4\lambda-1}}{2} \ln(x+1)\right) \right\}.$$

Note that

$$\left\{ \sqrt{x+1} \exp\left(i \frac{\sqrt{4\lambda-1}}{2} \ln\left(\frac{x+1}{2}\right)\right), \sqrt{x+1} \exp\left(-i \frac{\sqrt{4\lambda-1}}{2} \ln\left(\frac{x+1}{2}\right)\right) \right\}.$$

is also a set of solutions. The new factor of 2 in the logarithm just multiplies the solutions by a constant. We write the solution in terms of the cosine and sine.

$$\left\{ \sqrt{x+1} \cos\left(\frac{\sqrt{4\lambda-1}}{2} \ln\left(\frac{x+1}{2}\right)\right), \sqrt{x+1} \sin\left(\frac{\sqrt{4\lambda-1}}{2} \ln\left(\frac{x+1}{2}\right)\right) \right\}.$$

The solution of the differential equation which satisfies the boundary condition  $y(1) = 0$  is

$$y = c\sqrt{x+1} \sin\left(\frac{\sqrt{1-4\lambda}}{2} \ln\left(\frac{x+1}{2}\right)\right).$$

Now we use the second boundary condition to find the eigenvalues.

$$\begin{aligned} y(2) &= 0 \\ \sin\left(\frac{\sqrt{4\lambda-1}}{2} \ln\left(\frac{3}{2}\right)\right) &= 0 \\ \frac{\sqrt{4\lambda-1}}{2} \ln\left(\frac{3}{2}\right) &= n\pi, \quad n \in \mathbb{Z} \\ \lambda &= \frac{1}{4} \left(1 + \left(\frac{2n\pi}{\ln(3/2)}\right)^2\right), \quad n \in \mathbb{Z} \end{aligned}$$

$n = 0$  gives us a trivial solution, so we discard it. Discarding duplicate solutions, The eigenvalues and eigenfunctions are

$$\lambda_n = \frac{1}{4} + \left( \frac{n\pi}{\ln(3/2)} \right)^2, \quad y_n = \sqrt{x+1} \sin \left( n\pi \frac{\ln((x+1)/2)}{\ln(3/2)} \right), \quad n \in \mathbb{Z}^+.$$

Now we verify that the eigenvalues and eigenfunctions satisfy the properties of regular Sturm-Liouville problems.

- The eigenvalues are real.
- There are an infinite number of eigenvalues

$$\lambda_1 < \lambda_2 < \lambda_3 < \dots$$

$$\frac{1}{4} + \left( \frac{\pi}{\ln(3/2)} \right)^2 < \frac{1}{4} + \left( \frac{2\pi}{\ln(3/2)} \right)^2 < \frac{1}{4} + \left( \frac{3\pi}{\ln(3/2)} \right)^2 < \dots$$

There is a least eigenvalue

$$\lambda_1 = \frac{1}{4} + \left( \frac{\pi}{\ln(3/2)} \right)^2,$$

but there is no greatest eigenvalue.

- The eigenfunctions are orthogonal with respect to the weighting function  $\sigma(x) = 1/(x+1)^2$ . Let  $n \neq m$ .

$$\begin{aligned} & \int_1^2 y_n(x)y_m(x)\sigma(x) dx \\ &= \int_1^2 \sqrt{x+1} \sin \left( n\pi \frac{\ln((x+1)/2)}{\ln(3/2)} \right) \sqrt{x+1} \sin \left( m\pi \frac{\ln((x+1)/2)}{\ln(3/2)} \right) \frac{1}{(x+1)^2} dx \\ &= \int_0^\pi \sin(nx) \sin(mx) \frac{\ln(3/2)}{\pi} dx \\ &= \frac{\ln(3/2)}{2\pi} \int_0^\pi (\cos((n-m)x) - \cos((n+m)x)) dx \\ &= 0 \end{aligned}$$

- The eigenfunctions are complete. A function  $f(x)$  defined on  $(1 \dots 2)$  has the series representation

$$f(x) \sim \sum_{n=1}^{\infty} c_n y_n(x) = \sum_{n=1}^{\infty} c_n \sqrt{x+1} \sin \left( n\pi \frac{\ln((x+1)/2)}{\ln(3/2)} \right),$$

where

$$c_n = \frac{\langle y_n | 1/(x+1)^2 | f \rangle}{\langle y_n | 1/(x+1)^2 | y_n \rangle} = \frac{2}{\ln(3/2)} \int_1^2 \sin \left( n\pi \frac{\ln((x+1)/2)}{\ln(3/2)} \right) \frac{1}{(x+1)^{3/2}} f(x) dx$$

### Solution 29.3

Recall that Euler equations are scale invariant. If  $u(x)$  is a solution, then so is  $u(cx)$  for any nonzero constant  $c$ .

We substitute  $y = x^\gamma$  into the Euler equation.

$$\begin{aligned} y'' + \frac{2\alpha+1}{x}y' + \frac{\lambda}{x^2}y &= 0 \\ \gamma(\gamma-1) + (2\alpha+1)\gamma + \lambda &= 0 \\ \gamma^2 + 2\alpha\gamma + \lambda &= 0 \\ \gamma &= -\alpha \pm \sqrt{\alpha^2 - \lambda} \end{aligned}$$

First we consider the case  $\lambda = \alpha^2$ . A set of solutions of the differential equation is

$$\{x^{-\alpha}, x^{-\alpha} \ln x\}$$

The homogeneous solution that satisfies the left boundary condition  $y(a) = 0$  is

$$y = cx^{-\alpha}(\ln x - \ln a) = cx^{-\alpha} \ln \left( \frac{x}{a} \right).$$

Since only the trivial solution with  $c = 0$  satisfies the right boundary condition,  $\lambda = \alpha^2$  is not an eigenvalue.

Next we consider the case  $\lambda \neq \alpha^2$ . We write

$$\gamma = -\alpha \pm i\sqrt{\lambda - \alpha^2}.$$

Note that  $\Re(\sqrt{\lambda - \alpha^2}) \geq 0$ . A set of solutions of the differential equation is

$$\left\{ x^{-\alpha \pm i\sqrt{\lambda - \alpha^2}} \right\} \\ \left\{ x^{-\alpha} e^{\pm i\sqrt{\lambda - \alpha^2} \ln x} \right\}.$$

By taking the sum and difference of these solutions we obtain a new set of linearly independent solutions.

$$\left\{ x^{-\alpha} \cos\left(\sqrt{\lambda - \alpha^2} \ln x\right), x^{-\alpha} \sin\left(\sqrt{\lambda - \alpha^2} \ln x\right), \right\}$$

The solution which satisfies the left boundary condition is

$$y = cx^{-\alpha} \sin\left(\sqrt{\lambda - \alpha^2} \ln\left(\frac{x}{a}\right)\right).$$

For nontrivial solutions, the right boundary condition  $y(b) = 0$  imposes the constraint

$$b^{-\alpha} \sin\left(\sqrt{\lambda - \alpha^2} \ln\left(\frac{b}{a}\right)\right) \\ \sqrt{\lambda - \alpha^2} \ln\left(\frac{b}{a}\right) = n\pi, \quad n \in \mathbb{Z}$$

We have the eigenvalues

$$\lambda_n = \alpha^2 + \left(\frac{n\pi}{\ln(b/a)}\right)^2, \quad n \in \mathbb{Z}$$

with the eigenfunctions

$$\phi_n = x^{-\alpha} \sin\left(n\pi \frac{\ln(x/a)}{\ln(b/a)}\right).$$

To write the problem in Sturm-Liouville form, we multiply by the integrating factor

$$e^{\int (2\alpha+1)/x \, dx} = e^{(2\alpha+1) \ln x} = x^{2\alpha+1}.$$

$$\boxed{(x^{2\alpha+1}y')' + \lambda x^{2\alpha-1}y = 0, \quad y(a) = y(b) = 0}$$

Now we verify that the Sturm-Liouville properties are satisfied.

- The eigenvalues

$$\lambda_n = \alpha^2 + \left( \frac{n\pi}{\ln(b/a)} \right)^2, \quad n \in \mathbb{Z}$$

are real.

- There are an infinite number of eigenvalues

$$\lambda_1 < \lambda_2 < \lambda_3 < \dots, \\ \alpha^2 + \left( \frac{\pi}{\ln(b/a)} \right)^2 < \alpha^2 + \left( \frac{2\pi}{\ln(b/a)} \right)^2 < \alpha^2 + \left( \frac{3\pi}{\ln(b/a)} \right)^2 < \dots$$

There is a least eigenvalue

$$\lambda_1 = \alpha^2 + \left( \frac{\pi}{\ln(b/a)} \right)^2,$$

but there is no greatest eigenvalue, ( $\lambda_n \rightarrow \infty$  as  $n \rightarrow \infty$ ).

- For each eigenvalue, we found one unique, (to within a multiplicative constant), eigenfunction  $\phi_n$ . We were able to choose the eigenfunctions to be real-valued. The eigenfunction

$$\phi_n = x^{-\alpha} \sin \left( n\pi \frac{\ln(x/a)}{\ln(b/a)} \right).$$

has exactly  $n - 1$  zeros in the open interval  $a < x < b$ .

- The eigenfunctions are orthogonal with respect to the weighting function  $\sigma(x) = x^{2\alpha-1}$ .

$$\begin{aligned}
 \int_a^b \phi_n(x)\phi_m(x)\sigma(x) dx &= \int_a^b x^{-\alpha} \sin\left(n\pi \frac{\ln(x/a)}{\ln(b/a)}\right) x^{-\alpha} \sin\left(m\pi \frac{\ln(x/a)}{\ln(b/a)}\right) x^{2\alpha-1} dx \\
 &= \int_a^b \sin\left(n\pi \frac{\ln(x/a)}{\ln(b/a)}\right) \sin\left(m\pi \frac{\ln(x/a)}{\ln(b/a)}\right) \frac{1}{x} dx \\
 &= \frac{\ln(b/a)}{\pi} \int_0^\pi \sin(nx) \sin(mx) dx \\
 &= \frac{\ln(b/a)}{2\pi} \int_0^\pi (\cos((n-m)x) - \cos((n+m)x)) dx \\
 &= 0 \quad \text{if } n \neq m
 \end{aligned}$$

- The eigenfunctions are complete. Any piecewise continuous function  $f(x)$  defined on  $a \leq x \leq b$  can be expanded in a series of eigenfunctions

$$f(x) \sim \sum_{n=1}^{\infty} c_n \phi_n(x),$$

where

$$c_n = \frac{\int_a^b f(x)\phi_n(x)\sigma(x) dx}{\int_a^b \phi_n^2(x)\sigma(x) dx}.$$

The sum converges to  $\frac{1}{2}(f(x^-) + f(x^+))$ . (We do not prove this property.)

- The eigenvalues can be related to the eigenfunctions with the Rayleigh quotient.

$$\begin{aligned}
\lambda_n &= \frac{[-p\phi_n \frac{d\phi_n}{dx}]_a^b + \int_a^b \left( p \left( \frac{d\phi_n}{dx} \right)^2 - q\phi_n^2 \right) dx}{\int_a^b \phi_n^2 \sigma dx} \\
&= \frac{\int_a^b \left( x^{2\alpha+1} \left( x^{-\alpha-1} \left( \frac{n\pi}{\ln(b/a)} \cos \left( n\pi \frac{\ln(x/a)}{\ln(b/a)} \right) - \alpha \sin \left( n\pi \frac{\ln(x/a)}{\ln(b/a)} \right) \right) \right)^2 dx}{\int_a^b \left( x^{-\alpha} \sin \left( n\pi \frac{\ln(x/a)}{\ln(b/a)} \right) \right)^2 x^{2\alpha-1} dx} \\
&= \frac{\int_a^b \left( \left( \frac{n\pi}{\ln(b/a)} \right)^2 \cos^2(\cdot) - 2\alpha \frac{n\pi}{\ln(b/a)} \cos(\cdot) \sin(\cdot) + \alpha^2 \sin^2(\cdot) \right) x^{-1} dx}{\int_a^b \sin^2 \left( n\pi \frac{\ln(x/a)}{\ln(b/a)} \right) x^{-1} dx} \\
&= \frac{\int_0^\pi \left( \left( \frac{n\pi}{\ln(b/a)} \right)^2 \cos^2(x) - 2\alpha \frac{n\pi}{\ln(b/a)} \cos(x) \sin(x) + \alpha^2 \sin^2(x) \right) dx}{\int_0^\pi \sin^2(x) dx} \\
&= \alpha^2 + \left( \frac{n\pi}{\ln(b/a)} \right)^2
\end{aligned}$$

Now we expand a function  $f(x)$  in a series of the eigenfunctions.

$$f(x) \sim \sum_{n=1}^{\infty} c_n x^{-\alpha} \sin \left( n\pi \frac{\ln(x/a)}{\ln(b/a)} \right),$$

where

$$\begin{aligned}
c_n &= \frac{\int_a^b f(x) \phi_n(x) \sigma(x) dx}{\int_a^b \phi_n^2(x) \sigma(x) dx} \\
&= \frac{2n}{\ln(b/a)} \int_a^b f(x) x^{\alpha-1} \sin \left( n\pi \frac{\ln(x/a)}{\ln(b/a)} \right) dx
\end{aligned}$$



### Solution 29.4

$$y'' - y' + \lambda y = 0, \quad y(0) = y(1) = 0.$$

The factor that will put this equation in Sturm-Liouville form is

$$F(x) = \exp\left(\int^x -1 \, dx\right) = e^{-x}.$$

The differential equation becomes

$$\frac{d}{dx} (e^{-x} y') + \lambda e^{-x} y = 0.$$

Thus we see that the eigenfunctions will be orthogonal with respect to the weighting function  $\sigma = e^{-x}$ .

Substituting  $y = e^{\alpha x}$  into the differential equation yields

$$\begin{aligned}\alpha^2 - \alpha + \lambda &= 0 \\ \alpha &= \frac{1 \pm \sqrt{1 - 4\lambda}}{2} \\ \alpha &= \frac{1}{2} \pm \sqrt{1/4 - \lambda}.\end{aligned}$$

If  $\lambda < 1/4$  then the solutions to the differential equation are exponential and only the trivial solution satisfies the boundary conditions.

If  $\lambda = 1/4$  then the solution is  $y = c_1 e^{x/2} + c_2 x e^{x/2}$  and again only the trivial solution satisfies the boundary conditions.

Now consider the case that  $\lambda > 1/4$ .

$$\alpha = \frac{1}{2} \pm i\sqrt{\lambda - 1/4}$$

The solutions are

$$e^{x/2} \cos(\sqrt{\lambda - 1/4} x), \quad e^{x/2} \sin(\sqrt{\lambda - 1/4} x).$$

The left boundary condition gives us

$$y = c e^{x/2} \sin(\sqrt{\lambda - 1/4} x).$$

The right boundary condition demands that

$$\sqrt{\lambda - 1/4} = n\pi, \quad n = 1, 2, \dots$$

Thus we see that the eigenvalues and eigenfunctions are

$$\lambda_n = \frac{1}{4} + (n\pi)^2, \quad y_n = e^{x/2} \sin(n\pi x).$$

If  $f(x)$  is a piecewise continuous function then we can expand it in a series of the eigenfunctions.

$$f(x) = \sum_{n=1}^{\infty} a_n e^{x/2} \sin(n\pi x)$$

The coefficients are

$$\begin{aligned} a_n &= \frac{\int_0^1 f(x) e^{-x} e^{x/2} \sin(n\pi x) dx}{\int_0^1 e^{-x} (e^{x/2} \sin(n\pi x))^2 dx} \\ &= \frac{\int_0^1 f(x) e^{-x/2} \sin(n\pi x) dx}{\int_0^1 \sin^2(n\pi x) dx} \\ &= 2 \int_0^1 f(x) e^{-x/2} \sin(n\pi x) dx. \end{aligned}$$

### Solution 29.5

Consider the eigenvalue problem

$$y'' + \lambda y = 0 \quad y(0) = 0 \quad y(1) + y'(1) = 0.$$

Since this is a Sturm-Liouville problem, there are only real eigenvalues. By the Rayleigh quotient, the eigenvalues are

$$\lambda = \frac{-\phi \frac{d\phi}{dx} \Big|_0^1 + \int_0^1 \left( \left( \frac{d\phi}{dx} \right)^2 \right) dx}{\int_0^1 \phi^2 dx},$$

$$\lambda = \frac{\phi^2(1) + \int_0^1 \left( \left( \frac{d\phi}{dx} \right)^2 \right) dx}{\int_0^1 \phi^2 dx}.$$

This demonstrates that there are only positive eigenvalues. The general solution of the differential equation for positive, real  $\lambda$  is

$$y = c_1 \cos(\sqrt{\lambda}x) + c_2 \sin(\sqrt{\lambda}x).$$

The solution that satisfies the left boundary condition is

$$y = c \sin(\sqrt{\lambda}x).$$

For nontrivial solutions we must have

$$\sin(\sqrt{\lambda}) + \sqrt{\lambda} \cos(\sqrt{\lambda}) = 0$$

$$\sqrt{\lambda} = -\tan(\sqrt{\lambda}).$$

The positive solutions of this equation are eigenvalues with corresponding eigenfunctions  $\sin(\sqrt{\lambda}x)$ . In Figure 29.1 we plot the functions  $x$  and  $-\tan(x)$  and draw vertical lines at  $x = (n - 1/2)\pi$ ,  $n \in \mathbb{N}$ .

From this we see that there are an infinite number of eigenvalues,  $\lambda_1 < \lambda_2 < \lambda_3 < \dots$ . In the limit as  $n \rightarrow \infty$ ,  $\lambda_n \rightarrow (n - 1/2)\pi$ . The limit is approached from above.

Now consider the eigenvalue problem

$$y'' + y = \mu y \quad y(0) = 0 \quad y(1) + y'(1) = 0.$$

From above we see that the eigenvalues satisfy

$$\sqrt{1 - \mu} = -\tan(\sqrt{1 - \mu})$$

and that there are an infinite number of eigenvalues. For large  $n$ ,  $\mu_n \approx 1 - (n - 1/2)\pi$ . The eigenfunctions are

$$\phi_n = \sin(\sqrt{1 - \mu_n}x).$$

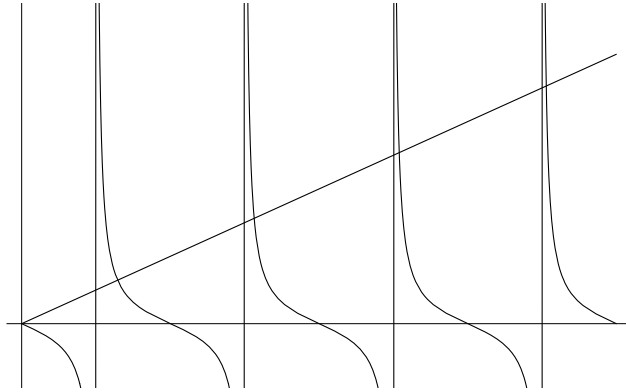

Figure 29.1:  $x$  and  $-\tan(x)$ .

To solve the inhomogeneous problem, we expand the solution and the inhomogeneity in a series of the eigenfunctions.

$$f = \sum_{n=1}^{\infty} f_n \phi_n, \quad f_n = \frac{\int_0^1 f(x) \phi_n(x) dx}{\int_0^1 \phi_n^2(x) dx}$$

$$y = \sum_{n=1}^{\infty} y_n \phi_n$$

We substitute the expansions into the differential equation to determine the coefficients.

$$y'' + y = f$$

$$\sum_{n=1}^{\infty} \mu_n y_n \phi_n = \sum_{n=1}^{\infty} f_n \phi_n$$

$$y = \sum_{n=1}^{\infty} \frac{f_n}{\mu_n} \sin(\sqrt{1 - \mu_n} x)$$

**Solution 29.6**

Consider the eigenvalue problem

$$y'' + y = \mu y \quad y(0) = 0 \quad y(1) + y'(1) = 0.$$

From Exercise 29.5 we see that the eigenvalues satisfy

$$\sqrt{1 - \mu} = -\tan\left(\sqrt{1 - \mu}\right)$$

and that there are an infinite number of eigenvalues. For large  $n$ ,  $\mu_n \approx 1 - (n - 1/2)\pi$ . The eigenfunctions are

$$\phi_n = \sin\left(\sqrt{1 - \mu_n}x\right).$$

To solve the inhomogeneous problem, we expand the solution and the inhomogeneity in a series of the eigenfunctions.

$$f = \sum_{n=1}^{\infty} f_n \phi_n, \quad f_n = \frac{\int_0^1 f(x) \phi_n(x) dx}{\int_0^1 \phi_n^2(x) dx}$$

$$y = \sum_{n=1}^{\infty} y_n \phi_n$$

We substitute the expansions into the differential equation to determine the coefficients.

$$y'' + y = f$$

$$\sum_{n=1}^{\infty} \mu_n y_n \phi_n = \sum_{n=1}^{\infty} f_n \phi_n$$

$$y = \sum_{n=1}^{\infty} \frac{f_n}{\mu_n} \sin\left(\sqrt{1 - \mu_n}x\right)$$

**Solution 29.7**

First consider  $\lambda = 0$ . The general solution is

$$y = c_1 + c_2 x.$$

$y = cx$  satisfies the boundary conditions. Thus  $\lambda = 0$  is an eigenvalue.

Now consider negative real  $\lambda$ . The general solution is

$$y = c_1 \cosh(\sqrt{-\lambda}x) + c_2 \sinh(\sqrt{-\lambda}x).$$

The solution that satisfies the left boundary condition is

$$y = c \sinh(\sqrt{-\lambda}x).$$

For nontrivial solutions of the boundary value problem, there must be negative real solutions of

$$\sqrt{-\lambda} - \sinh(\sqrt{-\lambda}) = 0.$$

Since  $x = \sinh x$  has no nonzero real solutions, this equation has no solutions for negative real  $\lambda$ . There are no negative real eigenvalues.

Finally consider positive real  $\lambda$ . The general solution is

$$y = c_1 \cos(\sqrt{\lambda}x) + c_2 \sin(\sqrt{\lambda}x).$$

The solution that satisfies the left boundary condition is

$$y = c \sin(\sqrt{\lambda}x).$$

For nontrivial solutions of the boundary value problem, there must be positive real solutions of

$$\sqrt{\lambda} - \sin(\sqrt{\lambda}) = 0.$$

Since  $x = \sin x$  has no nonzero real solutions, this equation has no solutions for positive real  $\lambda$ . There are no positive real eigenvalues.

There is only one real eigenvalue,  $\lambda = 0$ , with corresponding eigenfunction  $\phi = x$ .

The difficulty with the boundary conditions,  $y(0) = 0$ ,  $y'(0) - y(1) = 0$  is that the problem is not self-adjoint. We demonstrate this by showing that the problem does not satisfy Green's identity. Let  $u$  and  $v$  be two functions that satisfy the boundary conditions, but not necessarily the differential equation.

$$\begin{aligned}\langle u, L[v] \rangle - \langle L[u], v \rangle &= \langle u, v'' \rangle - \langle u'', v \rangle \\ &= [uv']_0^1 - \langle u', v' \rangle - \langle u', v' \rangle - [u'v]_0^1 + \langle u', v' \rangle - \langle u', v' \rangle \\ &= u(1)v'(1) - u'(1)v(1)\end{aligned}$$

Green's identity is not satisfied,

$$\langle u, L[v] \rangle - \langle L[u], v \rangle \neq 0;$$

The problem is not self-adjoint.

### Solution 29.8

First we write the equation in formally self-adjoint form,

$$L[y] \equiv (xy')' = -\lambda xy, \quad |y(0)| < \infty, \quad y(1) = 0.$$

Let  $\lambda$  be an eigenvalue with corresponding eigenfunction  $\phi$ . We derive the Rayleigh quotient for  $\lambda$ .

$$\begin{aligned}\langle \phi, L[\phi] \rangle &= \langle \phi, -\lambda x\phi \rangle \\ \langle \phi, (x\phi')' \rangle &= -\lambda \langle \phi, x\phi \rangle \\ [x\phi\phi']_0^1 - \langle \phi', x\phi' \rangle &= -\lambda \langle \phi, x\phi \rangle\end{aligned}$$

We apply the boundary conditions and solve for  $\lambda$ .

$$\lambda = \frac{\langle \phi', x\phi' \rangle}{\langle \phi, x\phi \rangle}$$

The Bessel equation of the first kind and order zero satisfies the problem,

$$y'' + \frac{1}{x}y' + y = 0, \quad |y(0)| < \infty, \quad y(r) = 0,$$

where  $r$  is a positive root of  $J_0(x)$ . We make the change of variables  $\xi = x/r$ ,  $u(\xi) = y(x)$  to obtain the problem

$$\frac{1}{r^2}u'' + \frac{1}{r\xi}u' + u = 0, \quad |u(0)| < \infty, \quad u(1) = 0,$$

$$u'' + \frac{1}{\xi}u' + r^2u = 0, \quad |u(0)| < \infty, \quad u(1) = 0.$$

Now  $r^2$  is the eigenvalue of the problem for  $u(\xi)$ . From the Rayleigh quotient, the minimum eigenvalue obeys the inequality

$$r^2 \leq \frac{\langle \phi', x\phi' \rangle}{\langle \phi, x\phi \rangle},$$

where  $\phi$  is any test function that satisfies the boundary conditions. Taking  $\phi = 1 - x$  we obtain,

$$r^2 \leq \frac{\int_0^1 (-1)x(-1) dx}{\int_0^1 (1-x)x(1-x) dx} = 6,$$

$$\boxed{r \leq \sqrt{6}}$$

Thus the smallest zero of  $J_0(x)$  is less than or equal to  $\sqrt{6} \approx 2.4494$ . (The smallest zero of  $J_0(x)$  is approximately 2.40483.)

### Solution 29.9

We assume that  $0 < l < \pi$ .

Recall that the solution of a second order differential equation with piecewise continuous coefficient functions is piecewise  $C^2$ . This means that the solution is  $C^2$  except for a finite number of points where it is  $C^1$ .

First consider the case  $\lambda = 0$ . A set of linearly independent solutions of the differential equation is  $\{1, z\}$ . The solution which satisfies  $y(0) = 0$  is  $y_1 = c_1z$ . The solution which satisfies  $y(\pi) = 0$  is  $y_2 = c_2(\pi - z)$ . There is a solution for the problem if there are values of  $c_1$  and  $c_2$  such that  $y_1$  and  $y_2$  have the same position and slope at  $z = l$ .

$$\begin{aligned} y_1(l) &= y_2(l), & y_1'(l) &= y_2'(l) \\ c_1l &= c_2(\pi - l), & c_1 &= -c_2 \end{aligned}$$



Since there is only the trivial solution,  $c_1 = c_2 = 0$ ,  $\lambda = 0$  is not an eigenvalue.

Now consider  $\lambda \neq 0$ . For  $0 \leq z \leq l$  a set of linearly independent solutions is

$$\left\{ \cos(\sqrt{a\lambda}z), \sin(\sqrt{a\lambda}z) \right\}.$$

The solution which satisfies  $y(0) = 0$  is

$$y_1 = c_1 \sin(\sqrt{a\lambda}z).$$

For  $l < z \leq \pi$  a set of linearly independent solutions is

$$\left\{ \cos(\sqrt{b\lambda}z), \sin(\sqrt{b\lambda}z) \right\}.$$

The solution which satisfies  $y(\pi) = 0$  is

$$y_2 = c_2 \sin(\sqrt{b\lambda}(\pi - z)).$$

$\lambda \neq 0$  is an eigenvalue if there are nontrivial solutions of

$$\begin{aligned} y_1(l) &= y_2(l), & y_1'(l) &= y_2'(l) \\ c_1 \sin(\sqrt{a\lambda}l) &= c_2 \sin(\sqrt{b\lambda}(\pi - l)), & c_1 \sqrt{a\lambda} \cos(\sqrt{a\lambda}l) &= -c_2 \sqrt{b\lambda} \cos(\sqrt{b\lambda}(\pi - l)) \end{aligned}$$

We divide the second equation by  $\sqrt{b\lambda}$  since  $\lambda \neq 0$  and write this as a linear algebra problem.

$$\begin{pmatrix} \sin(\sqrt{a\lambda}l) & -\sin(\sqrt{b\lambda}(\pi - l)) \\ \sqrt{a\lambda} \cos(\sqrt{a\lambda}l) & \sqrt{b\lambda} \cos(\sqrt{b\lambda}(\pi - l)) \end{pmatrix} \begin{pmatrix} c_1 \\ c_2 \end{pmatrix} = \begin{pmatrix} 0 \\ 0 \end{pmatrix}$$

This system of equations has nontrivial solutions if and only if the determinant of the matrix is zero.

$$\sqrt{b\lambda} \sin(\sqrt{a\lambda}l) \sin(\sqrt{b\lambda}(\pi - l)) + \sqrt{a\lambda} \cos(\sqrt{a\lambda}l) \cos(\sqrt{b\lambda}(\pi - l)) = 0$$

We can use trigonometric identities to write this equation as

$$\boxed{(\sqrt{b} - \sqrt{a}) \sin\left(\sqrt{\lambda}(l\sqrt{a} - (\pi - l)\sqrt{b})\right) + (\sqrt{b} + \sqrt{a}) \sin\left(\sqrt{\lambda}(l\sqrt{a} + (\pi - l)\sqrt{b})\right) = 0}$$

Clearly this equation has an infinite number of solutions for real, positive  $\lambda$ . However, it is not clear that this equation does not have non-real solutions. In order to prove that, we will show that the problem is self-adjoint. Before going on to that we note that the eigenfunctions have the form

$$\phi_n(z) = \begin{cases} \sin(\sqrt{a\lambda_n}z) & 0 \leq z \leq l \\ \sin(\sqrt{b\lambda_n}(\pi - z)) & l < z \leq \pi. \end{cases}$$

Now we prove that the problem is self-adjoint. We consider the class of functions which are  $C^2$  in  $(0 \dots \pi)$  except at the interior point  $x = l$  where they are  $C^1$  and which satisfy the boundary conditions  $y(0) = y(\pi) = 0$ . Note that the differential operator is not defined at the point  $x = l$ . Thus Green's identity,

$$\langle u|q|Lv \rangle = \langle Lu|q|v \rangle$$

is not well-defined. To remedy this we must define a new inner product. We choose

$$\langle u|v \rangle \equiv \int_0^l \bar{u}v \, dx + \int_l^\pi \bar{u}v \, dx.$$

This new inner product does not require differentiability at the point  $x = l$ .

The problem is self-adjoint if Green's identity is satisfied. Let  $u$  and  $v$  be elements of our class of functions. In

addition to the boundary conditions, we will use the fact that  $u$  and  $v$  satisfy  $y(l^-) = y(l^+)$  and  $y'(l^-) = y'(l^+)$ .

$$\begin{aligned}
 \langle v|Lu \rangle &= \int_0^l \bar{v}u'' \, dx + \int_l^\pi \bar{v}u'' \, dx \\
 &= [\bar{v}u']_0^l - \int_0^l \bar{v}'u' \, dx + [\bar{v}u']_l^\pi - \int_l^\pi \bar{v}'u' \, dx \\
 &= \bar{v}(l)u'(l) - \int_0^l \bar{v}'u' \, dx - \bar{v}(l)u'(l) - \int_l^\pi \bar{v}'u' \, dx \\
 &= - \int_0^l \bar{v}'u' \, dx - \int_l^\pi \bar{v}'u' \, dx \\
 &= - [\bar{v}'u]_0^l + \int_0^l \bar{v}''u \, dx - [\bar{v}'u]_l^\pi + \int_l^\pi \bar{v}''u \, dx \\
 &= -\bar{v}'(l)u(l) + \int_0^l \bar{v}''u \, dx + \bar{v}'(l)u(l) + \int_l^\pi \bar{v}''u \, dx \\
 &= \int_0^l \bar{v}''u \, dx + \int_l^\pi \bar{v}''u \, dx \\
 &= \langle Lv|Lu \rangle
 \end{aligned}$$

The problem is self-adjoint. Hence the eigenvalues are real. There are an infinite number of positive, real eigenvalues  $\lambda_n$ .

### Solution 29.10

1. Let  $v$  be an eigenfunction with the eigenvalue  $\lambda$ . We start with the differential equation and then take the inner product with  $v$ .

$$\begin{aligned}
 (pv'')'' - (qv')' + rv &= \lambda sv \\
 \langle v, (pv'')'' - (qv')' + rv \rangle &= \langle v, \lambda sv \rangle
 \end{aligned}$$

We use integration by parts and utilize the homogeneous boundary conditions.

$$\begin{aligned} [v(pv'')]_a^b - \langle v', (pv'')' \rangle - [vqv']_a^b + \langle v', qv' \rangle + \langle v, rv \rangle &= \lambda \langle v, sv \rangle \\ - [v'pv'']_a^b + \langle v'', pv'' \rangle + \langle v', qv' \rangle + \langle v, rv \rangle &= \lambda \langle v, sv \rangle \\ \lambda &= \frac{\langle v'', pv'' \rangle + \langle v', qv' \rangle + \langle v, rv \rangle}{\langle v, sv \rangle} \end{aligned}$$

We see that if  $p, q, r, s \geq 0$  then the eigenvalues will be positive. (Of course we assume that  $p$  and  $s$  are not identically zero.)

2. First we prove that this problem is self-adjoint. Let  $u$  and  $v$  be functions that satisfy the boundary conditions, but do not necessarily satisfy the differential equation.

$$\langle v, L[u] \rangle - \langle L[v], u \rangle = \langle v, (pu'')'' - (qu')' + ru \rangle - \langle (pv'')'' - (qv')' + rv, u \rangle$$

Following our work in part (a) we use integration by parts to move the derivatives.

$$\begin{aligned} &= (\langle v'', pu'' \rangle + \langle v', qu' \rangle + \langle v, ru \rangle) - (\langle pv''', u'' \rangle + \langle qv', u' \rangle + \langle rv, u \rangle) \\ &= 0 \end{aligned}$$

This problem satisfies Green's identity,

$$\langle v, L[u] \rangle - \langle L[v], u \rangle = 0,$$

and is thus self-adjoint.

Let  $v_k$  and  $v_m$  be eigenfunctions corresponding to the distinct eigenvalues  $\lambda_k$  and  $\lambda_m$ . We start with Green's identity.

$$\begin{aligned} \langle v_k, L[v_m] \rangle - \langle L[v_k], v_m \rangle &= 0 \\ \langle v_k, \lambda_m sv_m \rangle - \langle \lambda_k sv_k, v_m \rangle &= 0 \\ (\lambda_m - \lambda_k) \langle v_k, sv_m \rangle &= 0 \\ \langle v_k, sv_m \rangle &= 0 \end{aligned}$$

The eigenfunctions are orthogonal with respect to the weighting function  $s$ .

3. From part (a) we know that there are only positive eigenvalues. The general solution of the differential equation is

$$\phi = c_1 \cos(\lambda^{1/4}x) + c_2 \cosh(\lambda^{1/4}x) + c_3 \sin(\lambda^{1/4}x) + c_4 \sinh(\lambda^{1/4}x).$$

Applying the condition  $\phi(0) = 0$  we obtain

$$\phi = c_1(\cos(\lambda^{1/4}x) - \cosh(\lambda^{1/4}x)) + c_2 \sin(\lambda^{1/4}x) + c_3 \sinh(\lambda^{1/4}x).$$

The condition  $\phi''(0) = 0$  reduces this to

$$\phi = c_1 \sin(\lambda^{1/4}x) + c_2 \sinh(\lambda^{1/4}x).$$

We substitute the solution into the two right boundary conditions.

$$\begin{aligned} c_1 \sin(\lambda^{1/4}) + c_2 \sinh(\lambda^{1/4}) &= 0 \\ -c_1 \lambda^{1/2} \sin(\lambda^{1/4}) + c_2 \lambda^{1/2} \sinh(\lambda^{1/4}) &= 0 \end{aligned}$$

We see that  $\sin(\lambda^{1/4}) = 0$ . The eigenvalues and eigenfunctions are

$$\lambda_n = (n\pi)^4, \quad \phi_n = \sin(n\pi x), \quad n \in \mathbb{N}.$$

# Chapter 30

## Integrals and Convergence

Never try to teach a pig to sing. It wastes your time and annoys the pig.

-?

### 30.1 Uniform Convergence of Integrals

Consider the improper integral

$$\int_c^\infty f(x, t) dt.$$

The integral is convergent to  $S(x)$  if, given any  $\epsilon > 0$ , there exists  $T(x, \epsilon)$  such that

$$\left| \int_c^\tau f(x, t) dt - S(x) \right| < \epsilon \quad \text{for all } \tau > T(x, \epsilon).$$

The sum is uniformly convergent if  $T$  is independent of  $x$ .

Similar to the Weierstrass M-test for infinite sums we have a uniform convergence test for integrals. If there exists a continuous function  $M(t)$  such that  $|f(x, t)| \leq M(t)$  and  $\int_c^\infty M(t) dt$  is convergent, then  $\int_c^\infty f(x, t) dt$  is uniformly convergent.

If  $\int_c^\infty f(x, t) dt$  is uniformly convergent, we have the following properties:

- If  $f(x, t)$  is continuous for  $x \in [a, b]$  and  $t \in [c, \infty)$  then for  $a < x_0 < b$ ,

$$\lim_{x \rightarrow x_0} \int_c^\infty f(x, t) dt = \int_c^\infty \left( \lim_{x \rightarrow x_0} f(x, t) \right) dt.$$

- If  $a \leq x_1 < x_2 \leq b$  then we can interchange the order of integration.

$$\int_{x_1}^{x_2} \left( \int_c^\infty f(x, t) dt \right) dx = \int_c^\infty \left( \int_{x_1}^{x_2} f(x, t) dx \right) dt$$

- If  $\frac{\partial f}{\partial x}$  is continuous, then

$$\frac{d}{dx} \int_c^\infty f(x, t) dt = \int_c^\infty \frac{\partial}{\partial x} f(x, t) dt.$$

## 30.2 The Riemann-Lebesgue Lemma

**Result 30.2.1** If  $\int_a^b |f(x)| dx$  exists, then

$$\int_a^b f(x) \sin(\lambda x) dx \rightarrow 0 \text{ as } \lambda \rightarrow \infty.$$

Before we try to justify the Riemann-Lebesgue lemma, we will need a preliminary result. Let  $\lambda$  be a positive constant.

$$\begin{aligned} \left| \int_a^b \sin(\lambda x) dx \right| &= \left| \left[ -\frac{1}{\lambda} \cos(\lambda x) \right]_a^b \right| \\ &\leq \frac{2}{\lambda}. \end{aligned}$$

We will prove the Riemann-Lebesgue lemma for the case when  $f(x)$  has limited total fluctuation on the interval  $(a, b)$ . We can express  $f(x)$  as the difference of two functions

$$f(x) = \psi_+(x) - \psi_-(x),$$

where  $\psi_+$  and  $\psi_-$  are positive, increasing, bounded functions.

From the mean value theorem for positive, increasing functions, there exists an  $x_0$ ,  $a \leq x_0 \leq b$ , such that

$$\begin{aligned} \left| \int_a^b \psi_+(x) \sin(\lambda x) \, dx \right| &= \left| \psi_+(b) \int_{x_0}^b \sin(\lambda x) \, dx \right| \\ &\leq |\psi_+(b)| \frac{2}{\lambda}. \end{aligned}$$

Similarly,

$$\left| \int_a^b \psi_-(x) \sin(\lambda x) \, dx \right| \leq |\psi_-(b)| \frac{2}{\lambda}.$$

Thus

$$\begin{aligned} \left| \int_a^b f(x) \sin(\lambda x) \, dx \right| &\leq \frac{2}{\lambda} (|\psi_+(b)| + |\psi_-(b)|) \\ &\rightarrow 0 \quad \text{as } \lambda \rightarrow \infty. \end{aligned}$$

## 30.3 Cauchy Principal Value

### 30.3.1 Integrals on an Infinite Domain

The improper integral  $\int_{-\infty}^{\infty} f(x) \, dx$  is defined

$$\int_{-\infty}^{\infty} f(x) \, dx = \lim_{a \rightarrow -\infty} \int_a^0 f(x) \, dx + \lim_{b \rightarrow \infty} \int_0^b f(x) \, dx,$$



when these limits exist. The Cauchy principal value of the integral is defined

$$\text{PV} \int_{-\infty}^{\infty} f(x) \, dx = \lim_{a \rightarrow \infty} \int_{-a}^a f(x) \, dx.$$

The principal value may exist when the integral diverges.

**Example 30.3.1**  $\int_{-\infty}^{\infty} x \, dx$  diverges, but

$$\text{PV} \int_{-\infty}^{\infty} x \, dx = \lim_{a \rightarrow \infty} \int_{-a}^a x \, dx = \lim_{a \rightarrow \infty} (0) = 0.$$

If the improper integral converges, then the Cauchy principal value exists and is equal to the value of the integral. The principal value of the integral of an odd function is zero. If the principal value of the integral of an even function exists, then the integral converges.

### 30.3.2 Singular Functions

Let  $f(x)$  have a singularity at  $x = 0$ . Let  $a$  and  $b$  satisfy  $a < 0 < b$ . The integral of  $f(x)$  is defined

$$\int_a^b f(x) \, dx = \lim_{\epsilon_1 \rightarrow 0^-} \int_a^{\epsilon_1} f(x) \, dx + \lim_{\epsilon_2 \rightarrow 0^+} \int_{\epsilon_2}^b f(x) \, dx,$$

when the limits exist. The Cauchy principal value of the integral is defined

$$\text{PV} \int_a^b f(x) \, dx = \lim_{\epsilon \rightarrow 0^+} \left( \int_a^{-\epsilon} f(x) \, dx + \int_{\epsilon}^b f(x) \, dx \right),$$

when the limit exists.

**Example 30.3.2** *The integral*

$$\int_{-1}^2 \frac{1}{x} \, dx$$

*diverges, but the principal value exists.*

$$\begin{aligned}\text{PV} \int_{-1}^2 \frac{1}{x} dx &= \lim_{\epsilon \rightarrow 0^+} \left( \int_{-1}^{-\epsilon} \frac{1}{x} dx + \int_{\epsilon}^2 \frac{1}{x} dx \right) \\ &= \lim_{\epsilon \rightarrow 0^+} \left( - \int_{\epsilon}^1 \frac{1}{x} dx + \int_{\epsilon}^2 \frac{1}{x} dx \right) \\ &= \int_1^2 \frac{1}{x} dx \\ &= \log 2\end{aligned}$$

# Chapter 31

## The Laplace Transform

### 31.1 The Laplace Transform

The Laplace transform of the function  $f(t)$  is defined

$$\mathcal{L}[f(t)] = \int_0^{\infty} e^{-st} f(t) dt,$$

for all values of  $s$  for which the integral exists. The Laplace transform of  $f(t)$  is a function of  $s$  which we will denote  $\hat{f}(s)$ .<sup>1</sup>

A function  $f(t)$  is of exponential order  $\alpha$  if there exist constants  $t_0$  and  $M$  such that

$$|f(t)| < M e^{\alpha t}, \quad \text{for all } t > t_0.$$

If  $\int_0^{t_0} f(t) dt$  exists and  $f(t)$  is of exponential order  $\alpha$  then the Laplace transform  $\hat{f}(s)$  exists for  $\Re(s) > \alpha$ . Here are a few examples of these concepts.

- $\sin t$  is of exponential order 0.

---

<sup>1</sup>Denoting the Laplace transform of  $f(t)$  as  $F(s)$  is also common.

- $t e^{2t}$  is of exponential order  $\alpha$  for any  $\alpha > 2$ .
- $e^{t^2}$  is not of exponential order  $\alpha$  for any  $\alpha$ .
- $t^n$  is of exponential order  $\alpha$  for any  $\alpha > 0$ .
- $t^{-2}$  does not have a Laplace transform as the integral diverges.

**Example 31.1.1** Consider the Laplace transform of  $f(t) = 1$ . Since  $f(t) = 1$  is of exponential order  $\alpha$  for any  $\alpha > 0$ , the Laplace transform integral converges for  $\Re(s) > 0$ .

$$\begin{aligned}\hat{f}(s) &= \int_0^{\infty} e^{-st} dt \\ &= \left[ -\frac{1}{s} e^{-st} \right]_0^{\infty} \\ &= \frac{1}{s}\end{aligned}$$

**Example 31.1.2** The function  $f(t) = t e^t$  is of exponential order  $\alpha$  for any  $\alpha > 1$ . We compute the Laplace transform of this function.

$$\begin{aligned}\hat{f}(s) &= \int_0^{\infty} e^{-st} t e^t dt \\ &= \int_0^{\infty} t e^{(1-s)t} dt \\ &= \left[ \frac{1}{1-s} t e^{(1-s)t} \right]_0^{\infty} - \int_0^{\infty} \frac{1}{1-s} e^{(1-s)t} dt \\ &= - \left[ \frac{1}{(1-s)^2} e^{(1-s)t} \right]_0^{\infty} \\ &= \frac{1}{(1-s)^2} \quad \text{for } \Re(s) > 1.\end{aligned}$$

**Example 31.1.3** Consider the Laplace transform of the Heaviside function,

$$H(t - c) = \begin{cases} 0 & \text{for } t < c \\ 1 & \text{for } t > c, \end{cases}$$

where  $c > 0$ .

$$\begin{aligned} \mathcal{L}[H(t - c)] &= \int_0^{\infty} e^{-st} H(t - c) dt \\ &= \int_c^{\infty} e^{-st} dt \\ &= \left[ \frac{e^{-st}}{-s} \right]_c^{\infty} \\ &= \frac{e^{-cs}}{s} \quad \text{for } \Re(s) > 0 \end{aligned}$$

**Example 31.1.4** Next consider  $H(t - c)f(t - c)$ .

$$\begin{aligned} \mathcal{L}[H(t - c)f(t - c)] &= \int_0^{\infty} e^{-st} H(t - c)f(t - c) dt \\ &= \int_c^{\infty} e^{-st} f(t - c) dt \\ &= \int_0^{\infty} e^{-s(t+c)} f(t) dt \\ &= e^{-cs} \hat{f}(s) \end{aligned}$$

## 31.2 The Inverse Laplace Transform

The *inverse Laplace transform* is denoted

$$f(t) = \mathcal{L}^{-1}[\hat{f}(s)].$$

We compute the inverse Laplace transform with the *Mellin inversion formula*.

$$f(t) = \frac{1}{i2\pi} \int_{\alpha-i\infty}^{\alpha+i\infty} e^{st} \hat{f}(s) ds$$

Here  $\alpha$  is a real constant that is to the right of the singularities of  $\hat{f}(s)$ .

To see why the Mellin inversion formula is correct, we take the Laplace transform of it. Assume that  $f(t)$  is of exponential order  $\alpha$ . Then  $\alpha$  will be to the right of the singularities of  $\hat{f}(s)$ .

$$\begin{aligned} \mathcal{L}[\mathcal{L}^{-1}[\hat{f}(s)]] &= \mathcal{L} \left[ \frac{1}{i2\pi} \int_{\alpha-i\infty}^{\alpha+i\infty} e^{zt} \hat{f}(z) dz \right] \\ &= \int_0^\infty e^{-st} \frac{1}{i2\pi} \int_{\alpha-i\infty}^{\alpha+i\infty} e^{zt} \hat{f}(z) dz dt \end{aligned}$$

We interchange the order of integration.

$$= \frac{1}{i2\pi} \int_{\alpha-i\infty}^{\alpha+i\infty} \hat{f}(z) \int_0^\infty e^{(z-s)t} dt dz$$

Since  $\Re(z) = \alpha$ , the integral in  $t$  exists for  $\Re(s) > \alpha$ .

$$= \frac{1}{i2\pi} \int_{\alpha-i\infty}^{\alpha+i\infty} \frac{\hat{f}(z)}{s-z} dz$$

We would like to evaluate this integral by closing the path of integration with a semi-circle of radius  $R$  in the right half plane and applying the residue theorem. However, in order for the integral along the semi-circle to vanish as  $R \rightarrow \infty$ ,  $\hat{f}(z)$  must vanish as  $|z| \rightarrow \infty$ . If  $\hat{f}(z)$  vanishes we can use the maximum modulus bound to show that the integral along the semi-circle vanishes. This we assume that  $\hat{f}(z)$  vanishes at infinity.

Consider the integral,

$$\frac{1}{i2\pi} \oint_C \frac{\hat{f}(z)}{s-z} dz,$$

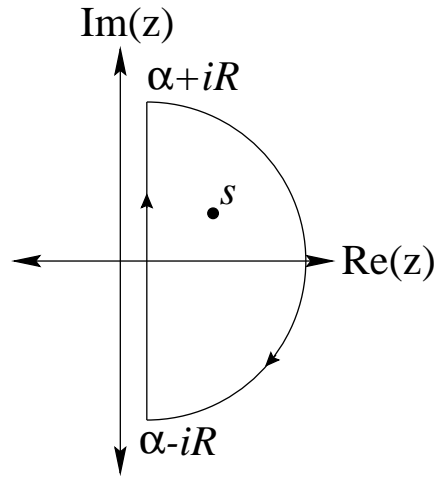

Figure 31.1: The Laplace Transform Pair Contour.

where  $C$  is the contour that starts at  $\alpha - iR$ , goes straight up to  $\alpha + iR$ , and then follows a semi-circle back down to  $\alpha - iR$ . This contour is shown in Figure 31.1.

If  $s$  is inside the contour then

$$\frac{1}{i2\pi} \oint_C \frac{\hat{f}(z)}{s-z} dz = \hat{f}(s).$$

Note that the contour is traversed in the negative direction. Since  $\hat{f}(z)$  decays as  $|z| \rightarrow \infty$ , the semicircular contribution to the integral will vanish as  $R \rightarrow \infty$ . Thus

$$\frac{1}{i2\pi} \int_{\alpha-i\infty}^{\alpha+i\infty} \frac{\hat{f}(z)}{s-z} dz = \hat{f}(s).$$

Therefore, we have shown that

$$\mathcal{L}[\mathcal{L}^{-1}[\hat{f}(s)]] = \hat{f}(s).$$

$f(t)$  and  $\hat{f}(s)$  are known as Laplace transform pairs.

### 31.2.1 $\hat{f}(s)$ with Poles

**Example 31.2.1** Consider the inverse Laplace transform of  $1/s^2$ .  $s = 1$  is to the right of the singularity of  $1/s^2$ .

$$\mathcal{L}^{-1}\left[\frac{1}{s^2}\right] = \frac{1}{i2\pi} \int_{1-i\infty}^{1+i\infty} e^{st} \frac{1}{s^2} ds$$

Let  $B_R$  be the contour starting at  $1 - iR$  and following a straight line to  $1 + iR$ ; let  $C_R$  be the contour starting at  $1 + iR$  and following a semicircular path down to  $1 - iR$ . Let  $C$  be the combination of  $B_R$  and  $C_R$ . This contour is shown in Figure 31.2.

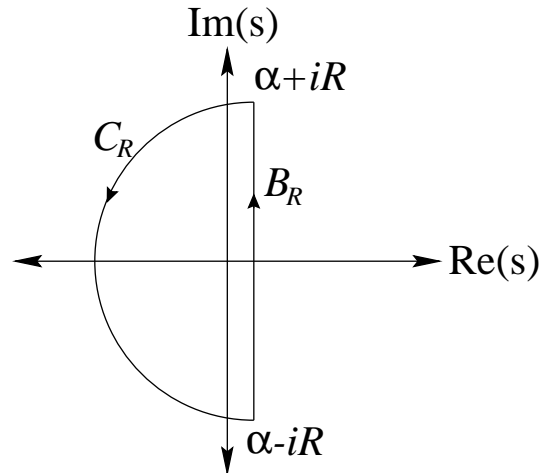

Figure 31.2: The Path of Integration for the Inverse Laplace Transform.



Consider the line integral on  $C$  for  $R > 1$ .

$$\begin{aligned} \frac{1}{i2\pi} \oint_C e^{st} \frac{1}{s^2} ds &= \text{Res} \left( e^{st} \frac{1}{s^2}, 0 \right) \\ &= \left. \frac{d}{ds} e^{st} \right|_{s=0} \\ &= t \end{aligned}$$

If  $t \geq 0$ , the integral along  $C_R$  vanishes as  $R \rightarrow \infty$ . We parameterize  $s$ .

$$\begin{aligned} s &= 1 + R e^{i\theta}, \quad \frac{\pi}{2} \leq \theta \leq \frac{3\pi}{2} \\ |e^{st}| &= \left| e^{t(1+R e^{i\theta})} \right| = e^t e^{tR \cos \theta} \leq e^t \end{aligned}$$

$$\begin{aligned} \left| \int_{C_R} e^{st} \frac{1}{s^2} ds \right| &\leq \int_{C_R} \left| e^{st} \frac{1}{s^2} \right| ds \\ &\leq \pi R e^t \frac{1}{(R-1)^2} \\ &\rightarrow 0 \text{ as } R \rightarrow \infty \end{aligned}$$

Thus the inverse Laplace transform of  $1/s^2$  is

$$\mathcal{L}^{-1} \left[ \frac{1}{s^2} \right] = t, \quad \text{for } t \geq 0.$$

Let  $\hat{f}(s)$  be analytic except for isolated poles at  $s_1, s_2, \dots, s_N$  and let  $\alpha$  be to the right of these poles. Also, let  $\hat{f}(s) \rightarrow 0$  as  $|s| \rightarrow \infty$ . Define  $B_R$  to be the straight line from  $\alpha - iR$  to  $\alpha + iR$  and  $C_R$  to be the semicircular path

from  $\alpha + iR$  to  $\alpha - iR$ . If  $R$  is large enough to enclose all the poles, then

$$\frac{1}{i2\pi} \oint_{B_R + C_R} e^{st} \hat{f}(s) ds = \sum_{n=1}^N \text{Res}(e^{st} \hat{f}(s), s_n)$$

$$\frac{1}{i2\pi} \int_{B_R} e^{st} \hat{f}(s) ds = \sum_{n=1}^N \text{Res}(e^{st} \hat{f}(s), s_n) - \frac{1}{i2\pi} \int_{C_R} e^{st} \hat{f}(s) ds.$$

Now let's examine the integral along  $C_R$ . Let the maximum of  $|\hat{f}(s)|$  on  $C_R$  be  $M_R$ . We can parameterize the contour with  $s = \alpha + R e^{i\theta}$ ,  $\pi/2 < \theta < 3\pi/2$ .

$$\left| \int_{C_R} e^{st} \hat{f}(s) ds \right| = \left| \int_{\pi/2}^{3\pi/2} e^{t(\alpha + R e^{i\theta})} \hat{f}(\alpha + R e^{i\theta}) R i e^{i\theta} d\theta \right|$$

$$\leq \int_{\pi/2}^{3\pi/2} e^{\alpha t} e^{tR \cos \theta} R M_R d\theta$$

$$= R M_R e^{\alpha t} \int_0^{\pi} e^{-tR \sin \theta} d\theta$$

If  $t \geq 0$  we can use Jordan's Lemma to obtain,

$$< R M_R e^{\alpha t} \frac{\pi}{tR}$$

$$= M_R e^{\alpha t} \frac{\pi}{t}$$

We use that  $M_R \rightarrow 0$  as  $R \rightarrow \infty$ .

$$\rightarrow 0 \quad \text{as } R \rightarrow \infty$$

Thus we have an expression for the inverse Laplace transform of  $\hat{f}(s)$ .

$$\frac{1}{i2\pi} \int_{\alpha-i\infty}^{\alpha+i\infty} e^{st} \hat{f}(s) ds = \sum_{n=1}^N \text{Res}(e^{st} \hat{f}(s), s_n)$$

$$\mathcal{L}^{-1}[\hat{f}(s)] = \sum_{n=1}^N \text{Res}(e^{st} \hat{f}(s), s_n)$$

**Result 31.2.1** If  $\hat{f}(s)$  is analytic except for poles at  $s_1, s_2, \dots, s_N$  and  $\hat{f}(s) \rightarrow 0$  as  $|s| \rightarrow \infty$  then the inverse Laplace transform of  $\hat{f}(s)$  is

$$f(t) = \mathcal{L}^{-1}[\hat{f}(s)] = \sum_{n=1}^N \text{Res}(e^{st} \hat{f}(s), s_n), \quad \text{for } t > 0.$$

**Example 31.2.2** Consider the inverse Laplace transform of  $\frac{1}{s^3 - s^2}$ .

First we factor the denominator.

$$\frac{1}{s^3 - s^2} = \frac{1}{s^2} \frac{1}{s - 1}.$$

Taking the inverse Laplace transform,

$$\begin{aligned} \mathcal{L}^{-1} \left[ \frac{1}{s^3 - s^2} \right] &= \text{Res} \left( e^{st} \frac{1}{s^2} \frac{1}{s - 1}, 0 \right) + \text{Res} \left( e^{st} \frac{1}{s^2} \frac{1}{s - 1}, 1 \right) \\ &= \left. \frac{d}{ds} \frac{e^{st}}{s - 1} \right|_{s=0} + e^t \\ &= \frac{-1}{(-1)^2} + \frac{t}{-1} + e^t \end{aligned}$$

Thus we have that

$$\mathcal{L}^{-1} \left[ \frac{1}{s^3 - s^2} \right] = e^t - t - 1, \quad \text{for } t > 0.$$

**Example 31.2.3** Consider the inverse Laplace transform of

$$\frac{s^2 + s - 1}{s^3 - 2s^2 + s - 2}.$$

We factor the denominator.

$$\frac{s^2 + s - 1}{(s - 2)(s - i)(s + i)}.$$

Then we take the inverse Laplace transform.

$$\begin{aligned} \mathcal{L}^{-1} \left[ \frac{s^2 + s - 1}{s^3 - 2s^2 + s - 2} \right] &= \text{Res} \left( e^{st} \frac{s^2 + s - 1}{(s - 2)(s - i)(s + i)}, 2 \right) + \text{Res} \left( e^{st} \frac{s^2 + s - 1}{(s - 2)(s - i)(s + i)}, i \right) \\ &\quad + \text{Res} \left( e^{st} \frac{s^2 + s - 1}{(s - 2)(s - i)(s + i)}, -i \right) \\ &= e^{2t} + e^{it} \frac{1}{i2} + e^{-it} \frac{-1}{i2} \end{aligned}$$

Thus we have

$$\mathcal{L}^{-1} \left[ \frac{s^2 + s - 1}{s^3 - 2s^2 + s - 2} \right] = \sin t + e^{2t}, \quad \text{for } t > 0.$$

## 31.2.2 $\hat{f}(s)$ with Branch Points

**Example 31.2.4** Consider the inverse Laplace transform of  $\frac{1}{\sqrt{s}}$ .  $\sqrt{s}$  denotes the principal branch of  $s^{1/2}$ . There is a branch cut from  $s = 0$  to  $s = -\infty$  and

$$\frac{1}{\sqrt{s}} = \frac{e^{-i\theta/2}}{\sqrt{r}}, \quad \text{for } -\pi < \theta < \pi.$$

Let  $\alpha$  be any positive number. The inverse Laplace transform of  $\frac{1}{\sqrt{s}}$  is

$$f(t) = \frac{1}{i2\pi} \int_{\alpha-i\infty}^{\alpha+i\infty} e^{st} \frac{1}{\sqrt{s}} ds.$$

We will evaluate the integral by deforming it to wrap around the branch cut. Consider the integral on the contour shown in Figure 31.3.  $C_R^+$  and  $C_R^-$  are circular arcs of radius  $R$ .  $B$  is the vertical line at  $\Re(s) = \alpha$  joining the two arcs.  $C_\epsilon$  is a semi-circle in the right half plane joining  $i\epsilon$  and  $-i\epsilon$ .  $L^+$  and  $L^-$  are lines joining the circular arcs at  $\Im(s) = \pm\epsilon$ .

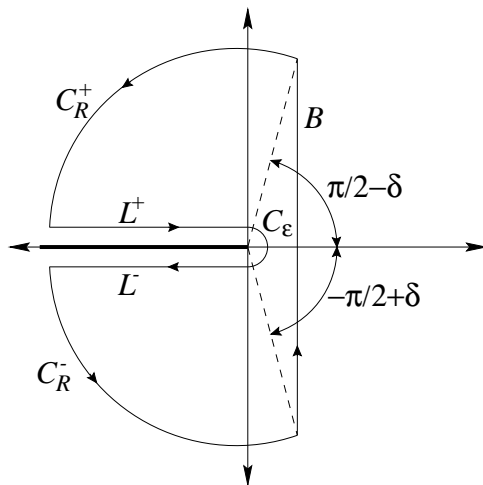

Figure 31.3: Path of Integration for  $1/\sqrt{s}$

Since there are no residues inside the contour, we have

$$\frac{1}{i2\pi} \left( \int_B + \int_{C_R^+} + \int_{L^+} + \int_{C_\epsilon} + \int_{L^-} + \int_{C_R^-} \right) e^{st} \frac{1}{\sqrt{s}} ds = 0.$$

We will evaluate the inverse Laplace transform for  $t > 0$ .

First we will show that the integral along  $C_R^+$  vanishes as  $R \rightarrow \infty$ .

$$\int_{C_R^+} \cdots ds = \int_{\pi/2-\delta}^{\pi/2} \cdots d\theta + \int_{\pi/2}^{\pi} \cdots d\theta.$$

The first integral vanishes by the maximum modulus bound. Note that the length of the path of integration is less than  $2\alpha$ .

$$\begin{aligned} \left| \int_{\pi/2-\delta}^{\pi/2} \cdots d\theta \right| &\leq \left( \max_{s \in C_R^+} \left| e^{st} \frac{1}{\sqrt{s}} \right| \right) (2\alpha) \\ &= e^{\alpha t} \frac{1}{\sqrt{R}} (2\alpha) \\ &\rightarrow 0 \text{ as } R \rightarrow \infty \end{aligned}$$

The second integral vanishes by Jordan's Lemma. A parameterization of  $C_R^+$  is  $s = R e^{i\theta}$ .

$$\begin{aligned} \left| \int_{\pi/2}^{\pi} e^{R e^{i\theta} t} \frac{1}{\sqrt{R e^{i\theta}}} d\theta \right| &\leq \int_{\pi/2}^{\pi} \left| e^{R e^{i\theta} t} \frac{1}{\sqrt{R e^{i\theta}}} \right| d\theta \\ &\leq \frac{1}{\sqrt{R}} \int_{\pi/2}^{\pi} e^{R \cos(\theta)t} d\theta \\ &\leq \frac{1}{\sqrt{R}} \int_0^{\pi/2} e^{-Rt \sin(\phi)} d\phi \\ &< \frac{1}{\sqrt{R}} \frac{\pi}{2Rt} \\ &\rightarrow 0 \text{ as } R \rightarrow \infty \end{aligned}$$

We could show that the integral along  $C_R^-$  vanishes by the same method. Now we have

$$\frac{1}{i2\pi} \left( \int_B + \int_{L^+} + \int_{C_\epsilon} + \int_{L^-} \right) e^{st} \frac{1}{\sqrt{s}} ds = 0.$$

We can show that the integral along  $C_\epsilon$  vanishes as  $\epsilon \rightarrow 0$  with the maximum modulus bound.

$$\begin{aligned} \left| \int_{C_\epsilon} e^{st} \frac{1}{\sqrt{s}} ds \right| &\leq \left( \max_{s \in C_\epsilon} \left| e^{st} \frac{1}{\sqrt{s}} \right| \right) (\pi\epsilon) \\ &< e^{\epsilon t} \frac{1}{\sqrt{\epsilon}} \pi\epsilon \\ &\rightarrow 0 \quad \text{as } \epsilon \rightarrow 0 \end{aligned}$$

Now we can express the inverse Laplace transform in terms of the integrals along  $L^+$  and  $L^-$ .

$$f(t) \equiv \frac{1}{i2\pi} \int_{\alpha-i\infty}^{\alpha+i\infty} e^{st} \frac{1}{\sqrt{s}} ds = -\frac{1}{i2\pi} \int_{L^+} e^{st} \frac{1}{\sqrt{s}} ds - \frac{1}{i2\pi} \int_{L^-} e^{st} \frac{1}{\sqrt{s}} ds$$

On  $L^+$ ,  $s = r e^{i\pi}$ ,  $ds = e^{i\pi} dr = -dr$ ; on  $L^-$ ,  $s = r e^{-i\pi}$ ,  $ds = e^{-i\pi} dr = -dr$ . We can combine the integrals along the top and bottom of the branch cut.

$$\begin{aligned} f(t) &= -\frac{1}{i2\pi} \int_{\infty}^0 e^{-rt} \frac{-i}{\sqrt{r}} (-1) dr - \frac{1}{i2\pi} \int_0^{\infty} e^{-rt} \frac{i}{\sqrt{r}} (-1) dr \\ &= \frac{1}{i2\pi} \int_0^{\infty} e^{-rt} \frac{i2}{\sqrt{r}} dr \end{aligned}$$

We make the change of variables  $x = rt$ .

$$= \frac{1}{\pi\sqrt{t}} \int_0^{\infty} e^{-x} \frac{1}{\sqrt{x}} dx$$

We recognize this integral as  $\Gamma(1/2)$ .

$$\begin{aligned} &= \frac{1}{\pi\sqrt{t}} \Gamma(1/2) \\ &= \frac{1}{\sqrt{\pi t}} \end{aligned}$$

Thus the inverse Laplace transform of  $\frac{1}{\sqrt{s}}$  is

$$f(t) = \frac{1}{\sqrt{\pi t}}, \quad \text{for } t > 0.$$

### 31.2.3 Asymptotic Behavior of $\hat{f}(s)$

Consider the behavior of

$$\hat{f}(s) = \int_0^{\infty} e^{-st} f(t) dt$$

as  $s \rightarrow +\infty$ . Assume that  $f(t)$  is analytic in a neighborhood of  $t = 0$ . Only the behavior of the integrand near  $t = 0$  will make a significant contribution to the value of the integral. As you move away from  $t = 0$ , the  $e^{-st}$  term dominates. Thus we could approximate the value of  $\hat{f}(s)$  by replacing  $f(t)$  with the first few terms in its Taylor series expansion about the origin.

$$\hat{f}(s) \sim \int_0^{\infty} e^{-st} \left[ f(0) + tf'(0) + \frac{t^2}{2}f''(0) + \cdots \right] dt \quad \text{as } s \rightarrow +\infty$$

Using

$$\mathcal{L}[t^n] = \frac{n!}{s^{n+1}}$$

we obtain

$$\hat{f}(s) \sim \frac{f(0)}{s} + \frac{f'(0)}{s^2} + \frac{f''(0)}{s^3} + \cdots \quad \text{as } s \rightarrow +\infty.$$

**Example 31.2.5** The Taylor series expansion of  $\sin t$  about the origin is

$$\sin t = t - \frac{t^3}{6} + \mathcal{O}(t^5).$$

Thus the Laplace transform of  $\sin t$  has the behavior

$$\mathcal{L}[\sin t] \sim \frac{1}{s^2} - \frac{1}{s^4} + \mathcal{O}(s^{-6}) \quad \text{as } s \rightarrow +\infty.$$



We corroborate this by expanding  $\mathcal{L}[\sin t]$ .

$$\begin{aligned}\mathcal{L}[\sin t] &= \frac{1}{s^2 + 1} \\ &= \frac{s^{-2}}{1 + s^{-2}} \\ &= s^{-2} \sum_{n=0}^{\infty} (-1)^n s^{-2n} \\ &= \frac{1}{s^2} - \frac{1}{s^4} + \mathcal{O}(s^{-6})\end{aligned}$$

### 31.3 Properties of the Laplace Transform

In this section we will list several useful properties of the Laplace transform. If a result is not derived, it is shown in the Problems section. Unless otherwise stated, assume that  $f(t)$  and  $g(t)$  are piecewise continuous and of exponential order  $\alpha$ .

- $\mathcal{L}[af(t) + bg(t)] = a\mathcal{L}[f(t)] + b\mathcal{L}[g(t)]$
- $\mathcal{L}[e^{ct} f(t)] = \hat{f}(s - c)$  for  $s > c + \alpha$
- $\mathcal{L}[t^n f(t)] = (-1)^n \frac{d^n}{ds^n} [\hat{f}(s)]$  for  $n = 1, 2, \dots$
- If  $\int_0^\beta \frac{f(t)}{t} dt$  exists for positive  $\beta$  then

$$\mathcal{L}\left[\frac{f(t)}{t}\right] = \int_s^\infty \hat{f}(\sigma) d\sigma.$$

- $\mathcal{L}\left[\int_0^t f(\tau) d\tau\right] = \frac{\hat{f}(s)}{s}$

- $\mathcal{L} \left[ \frac{d}{dt} f(t) \right] = s\hat{f}(s) - f(0)$

$$\mathcal{L} \left[ \frac{d^2}{dt^2} f(t) \right] = s^2\hat{f}(s) - sf(0) - f'(0)$$

To derive these formulas,

$$\begin{aligned} \mathcal{L} \left[ \frac{d}{dt} f(t) \right] &= \int_0^{\infty} e^{-st} f'(t) dt \\ &= \left[ e^{-st} f(t) \right]_0^{\infty} - \int_0^{\infty} -s e^{-st} f(t) dt \\ &= -f(0) + s\hat{f}(s) \end{aligned}$$

$$\begin{aligned} \mathcal{L} \left[ \frac{d^2}{dt^2} f(t) \right] &= s\mathcal{L}[f'(t)] - f'(0) \\ &= s^2\hat{f}(s) - sf(0) - f'(0) \end{aligned}$$

- Let  $f(t)$  and  $g(t)$  be continuous. The convolution of  $f(t)$  and  $g(t)$  is defined

$$h(t) = (f * g) = \int_0^t f(\tau)g(t - \tau) d\tau = \int_0^t f(t - \tau)g(\tau) d\tau$$

The **convolution theorem** states

$$\hat{h}(s) = \hat{f}(s)\hat{g}(s).$$

To show this,

$$\begin{aligned}
 \hat{h}(s) &= \int_0^\infty e^{-st} \int_0^t f(\tau)g(t-\tau) \, d\tau \, dt \\
 &= \int_0^\infty \int_\tau^\infty e^{-st} f(\tau)g(t-\tau) \, dt \, d\tau \\
 &= \int_0^\infty e^{-s\tau} f(\tau) \int_\tau^\infty e^{-s(t-\tau)} g(t-\tau) \, dt \, d\tau \\
 &= \int_0^\infty e^{-s\tau} f(\tau) \, d\tau \int_0^\infty e^{-s\eta} g(\eta) \, d\eta \\
 &= \hat{f}(s)\hat{g}(s)
 \end{aligned}$$

- If  $f(t)$  is periodic with period  $T$  then

$$\mathcal{L}[f(t)] = \frac{\int_0^T e^{-st} f(t) \, dt}{1 - e^{-sT}}.$$

**Example 31.3.1** Consider the inverse Laplace transform of  $\frac{1}{s^3 - s^2}$ . First we factor the denominator.

$$\frac{1}{s^3 - s^2} = \frac{1}{s^2} \frac{1}{s - 1}$$

We know the inverse Laplace transforms of each term.

$$\mathcal{L}^{-1} \left[ \frac{1}{s^2} \right] = t, \quad \mathcal{L}^{-1} \left[ \frac{1}{s - 1} \right] = e^t$$

We apply the convolution theorem.

$$\begin{aligned}
 \mathcal{L}^{-1} \left[ \frac{1}{s^2} \frac{1}{s - 1} \right] &= \int_0^t \tau e^{t-\tau} \, d\tau \\
 &= e^t \left[ -\tau e^{-\tau} \right]_0^t - e^t \int_0^t -e^{-\tau} \, d\tau \\
 &= -t - 1 + e^t
 \end{aligned}$$

$$\mathcal{L}^{-1} \left[ \frac{1}{s^2} \frac{1}{s-1} \right] = e^t - t - 1.$$

**Example 31.3.2** We can find the inverse Laplace transform of

$$\frac{s^2 + s - 1}{s^3 - 2s^2 + s - 2}$$

with the aid of a table of Laplace transform pairs. We factor the denominator.

$$\frac{s^2 + s - 1}{(s-2)(s-i)(s+i)}$$

We expand the function in partial fractions and then invert each term.

$$\frac{s^2 + s - 1}{(s-2)(s-i)(s+i)} = \frac{1}{s-2} - \frac{i/2}{s-i} + \frac{i/2}{s+i}$$

$$\frac{s^2 + s - 1}{(s-2)(s-i)(s+i)} = \frac{1}{s-2} + \frac{1}{s^2+1}$$

$$\mathcal{L}^{-1} \left[ \frac{1}{s-2} + \frac{1}{s^2+1} \right] = e^{2t} + \sin t$$

## 31.4 Constant Coefficient Differential Equations

**Example 31.4.1** Consider the differential equation

$$y' + y = \cos t, \quad \text{for } t > 0, \quad y(0) = 1.$$

We take the Laplace transform of this equation.

$$\begin{aligned} s\hat{y}(s) - y(0) + \hat{y}(s) &= \frac{s}{s^2 + 1} \\ \hat{y}(s) &= \frac{s}{(s + 1)(s^2 + 1)} + \frac{1}{s + 1} \\ \hat{y}(s) &= \frac{1/2}{s + 1} + \frac{1}{2} \frac{s + 1}{s^2 + 1} \end{aligned}$$

Now we invert  $\hat{y}(s)$ .

$$y(t) = \frac{1}{2} e^{-t} + \frac{1}{2} \cos t + \frac{1}{2} \sin t, \quad \text{for } t > 0$$

Notice that the initial condition was included when we took the Laplace transform.

One can see from this example that taking the Laplace transform of a constant coefficient differential equation reduces the differential equation for  $y(t)$  to an algebraic equation for  $\hat{y}(s)$ .

**Example 31.4.2** Consider the differential equation

$$y'' + y = \cos(2t), \quad \text{for } t > 0, \quad y(0) = 1, \quad y'(0) = 0.$$

We take the Laplace transform of this equation.

$$\begin{aligned} s^2\hat{y}(s) - sy(0) - y'(0) + \hat{y}(s) &= \frac{s}{s^2 + 4} \\ \hat{y}(s) &= \frac{s}{(s^2 + 1)(s^2 + 4)} + \frac{s}{s^2 + 1} \end{aligned}$$

From the table of Laplace transform pairs we know

$$\mathcal{L}^{-1} \left[ \frac{s}{s^2 + 1} \right] = \cos t, \quad \mathcal{L}^{-1} \left[ \frac{1}{s^2 + 4} \right] = \frac{1}{2} \sin(2t).$$

We use the convolution theorem to find the inverse Laplace transform of  $\hat{y}(s)$ .

$$\begin{aligned}
 y(t) &= \int_0^t \frac{1}{2} \sin(2\tau) \cos(t - \tau) \, d\tau + \cos t \\
 &= \frac{1}{4} \int_0^t \sin(t + \tau) + \sin(3\tau - t) \, d\tau + \cos t \\
 &= \frac{1}{4} \left[ -\cos(t + \tau) - \frac{1}{3} \cos(3\tau - t) \right]_0^t + \cos t \\
 &= \frac{1}{4} \left( -\cos(2t) + \cos t - \frac{1}{3} \cos(2t) + \frac{1}{3} \cos(t) \right) + \cos t \\
 &= -\frac{1}{3} \cos(2t) + \frac{4}{3} \cos(t)
 \end{aligned}$$

Alternatively, we can find the inverse Laplace transform of  $\hat{y}(s)$  by first finding its partial fraction expansion.

$$\begin{aligned}
 \hat{y}(s) &= \frac{s/3}{s^2 + 1} - \frac{s/3}{s^2 + 4} + \frac{s}{s^2 + 1} \\
 &= -\frac{s/3}{s^2 + 4} + \frac{4s/3}{s^2 + 1} \\
 y(t) &= -\frac{1}{3} \cos(2t) + \frac{4}{3} \cos(t)
 \end{aligned}$$

**Example 31.4.3** Consider the initial value problem

$$y'' + 5y' + 2y = 0, \quad y(0) = 1, \quad y'(0) = 2.$$

Without taking a Laplace transform, we know that since

$$y(t) = 1 + 2t + \mathcal{O}(t^2)$$

the Laplace transform has the behavior

$$\hat{y}(s) \sim \frac{1}{s} + \frac{2}{s^2} + \mathcal{O}(s^{-3}), \quad \text{as } s \rightarrow +\infty.$$

## 31.5 Systems of Constant Coefficient Differential Equations

The Laplace transform can be used to transform a system of constant coefficient differential equations into a system of algebraic equations. This should not be surprising, as a system of differential equations can be written as a single differential equation, and vice versa.

**Example 31.5.1** Consider the set of differential equations

$$y_1' = y_2$$

$$y_2' = y_3$$

$$y_3' = -y_3 - y_2 - y_1 + t^3$$

with the initial conditions

$$y_1(0) = y_2(0) = y_3(0) = 0.$$

We take the Laplace transform of this system.

$$s\hat{y}_1 - y_1(0) = \hat{y}_2$$

$$s\hat{y}_2 - y_2(0) = \hat{y}_3$$

$$s\hat{y}_3 - y_3(0) = -\hat{y}_3 - \hat{y}_2 - \hat{y}_1 + \frac{6}{s^4}$$

The first two equations can be written as

$$\hat{y}_1 = \frac{\hat{y}_3}{s^2}$$

$$\hat{y}_2 = \frac{\hat{y}_3}{s}.$$

We substitute this into the third equation.

$$\begin{aligned}s\hat{y}_3 &= -\hat{y}_3 - \frac{\hat{y}_3}{s} - \frac{\hat{y}_3}{s^2} + \frac{6}{s^4} \\(s^3 + s^2 + s + 1)\hat{y}_3 &= \frac{6}{s^2} \\ \hat{y}_3 &= \frac{6}{s^2(s^3 + s^2 + s + 1)}.\end{aligned}$$

We solve for  $\hat{y}_1$ .

$$\begin{aligned}\hat{y}_1 &= \frac{6}{s^4(s^3 + s^2 + s + 1)} \\ \hat{y}_1 &= \frac{1}{s^4} - \frac{1}{s^3} + \frac{1}{2(s+1)} + \frac{1-s}{2(s^2+1)}\end{aligned}$$

We then take the inverse Laplace transform of  $\hat{y}_1$ .

$$y_1 = \frac{t^3}{6} - \frac{t^2}{2} + \frac{1}{2}e^{-t} + \frac{1}{2}\sin t - \frac{1}{2}\cos t.$$

We can find  $y_2$  and  $y_3$  by differentiating the expression for  $y_1$ .

$$\begin{aligned}y_2 &= \frac{t^2}{2} - t - \frac{1}{2}e^{-t} + \frac{1}{2}\cos t + \frac{1}{2}\sin t \\ y_3 &= t - 1 + \frac{1}{2}e^{-t} - \frac{1}{2}\sin t + \frac{1}{2}\cos t\end{aligned}$$



## 31.6 Exercises

### Exercise 31.1

Find the Laplace transform of the following functions:

1.  $f(t) = e^{at}$

2.  $f(t) = \sin(at)$

3.  $f(t) = \cos(at)$

4.  $f(t) = \sinh(at)$

5.  $f(t) = \cosh(at)$

6.  $f(t) = \frac{\sin(at)}{t}$

7.  $f(t) = \int_0^t \frac{\sin(au)}{u} du$

8.  $f(t) = \begin{cases} 1, & 0 \leq t < \pi \\ 0, & \pi \leq t < 2\pi \end{cases}$

and  $f(t + 2\pi) = f(t)$  for  $t > 0$ . That is,  $f(t)$  is periodic for  $t > 0$ .

**Hint, Solution**

### Exercise 31.2

Show that  $\mathcal{L}[af(t) + bg(t)] = a\mathcal{L}[f(t)] + b\mathcal{L}[g(t)]$ .

**Hint, Solution**

### Exercise 31.3

Show that if  $f(t)$  is of exponential order  $\alpha$ ,

$$\mathcal{L}[e^{ct} f(t)] = \hat{f}(s - c) \text{ for } s > c + \alpha.$$

Hint, Solution

### Exercise 31.4

Show that

$$\mathcal{L}[t^n f(t)] = (-1)^n \frac{d^n}{ds^n} [\hat{f}(s)] \quad \text{for } n = 1, 2, \dots$$

Hint, Solution

### Exercise 31.5

Show that if  $\int_0^\beta \frac{f(t)}{t} dt$  exists for positive  $\beta$  then

$$\mathcal{L}\left[\frac{f(t)}{t}\right] = \int_s^\infty \hat{f}(\sigma) d\sigma.$$

Hint, Solution

### Exercise 31.6

Show that

$$\mathcal{L}\left[\int_0^t f(\tau) d\tau\right] = \frac{\hat{f}(s)}{s}.$$

Hint, Solution

### Exercise 31.7

Show that if  $f(t)$  is periodic with period  $T$  then

$$\mathcal{L}[f(t)] = \frac{\int_0^T e^{-st} f(t) dt}{1 - e^{-sT}}.$$

Hint, Solution

### Exercise 31.8

The function  $f(t)$   $t \geq 0$ , is periodic with period  $2T$ ; i.e.  $f(t + 2T) \equiv f(t)$ , and is also odd with period  $T$ ; i.e.  $f(t + T) = -f(t)$ . Further,

$$\int_0^T f(t) e^{-st} dt = \hat{g}(s).$$

Show that the Laplace transform of  $f(t)$  is  $\hat{f}(s) = \hat{g}(s)/(1 + e^{-sT})$ . Find  $f(t)$  such that  $\hat{f}(s) = s^{-1} \tanh(sT/2)$ .

**Hint, Solution**

### Exercise 31.9

Find the Laplace transform of  $t^\nu$ ,  $\nu > -1$  by two methods.

1. Assume that  $s$  is complex-valued. Make the change of variables  $z = st$  and use integration in the complex plane.
2. Show that the Laplace transform of  $t^\nu$  is an analytic function for  $\Re(s) > 0$ . Assume that  $s$  is real-valued. Make the change of variables  $x = st$  and evaluate the integral. Then use analytic continuation to extend the result to complex-valued  $s$ .

**Hint, Solution**

### Exercise 31.10 (mathematica/ode/laplace/laplace.nb)

Show that the Laplace transform of  $f(t) = \ln t$  is

$$\hat{f}(s) = -\frac{\text{Log } s}{s} - \frac{\gamma}{s}, \quad \text{where } \gamma = -\int_0^\infty e^{-t} \ln t dt.$$

[  $\gamma = 0.5772\dots$  is known as Euler's constant.]

**Hint, Solution**

### Exercise 31.11

Find the Laplace transform of  $t^\nu \ln t$ . Write the answer in terms of the digamma function,  $\psi(\nu) = \Gamma'(\nu)/\Gamma(\nu)$ . What is the answer for  $\nu = 0$ ?

**Hint, Solution**

### Exercise 31.12

Find the inverse Laplace transform of

$$\hat{f}(s) = \frac{1}{s^3 - 2s^2 + s - 2}$$

with the following methods.

1. Expand  $\hat{f}(s)$  using partial fractions and then use the table of Laplace transforms.
2. Factor the denominator into  $(s - 2)(s^2 + 1)$  and then use the convolution theorem.
3. Use Result 31.2.1.

Hint, Solution

### Exercise 31.13

Solve the differential equation

$$y'' + \epsilon y' + y = \sin t, \quad y(0) = y'(0) = 0, \quad 0 < \epsilon \ll 1$$

using the Laplace transform. This equation represents a weakly damped, driven, linear oscillator.

Hint, Solution

### Exercise 31.14

Solve the problem,

$$y'' - ty' + y = 0, \quad y(0) = 0, \quad y'(0) = 1,$$

with the Laplace transform.

Hint, Solution

### Exercise 31.15

Prove the following relation between the inverse Laplace transform and the inverse Fourier transform,

$$\mathcal{L}^{-1}[\hat{f}(s)] = \frac{1}{2\pi} e^{ct} \mathcal{F}^{-1}[\hat{f}(c + i\omega)],$$

where  $c$  is to the right of the singularities of  $\hat{f}(s)$ .

**Hint, Solution**

**Exercise 31.16 (mathematica/ode/laplace/laplace.nb)**

Show by evaluating the Laplace inversion integral that if

$$\hat{f}(s) = \left(\frac{\pi}{s}\right)^{1/2} e^{-2(as)^{1/2}}, \quad s^{1/2} = \sqrt{s} \text{ for } s > 0,$$

then  $f(t) = e^{-a/t} / \sqrt{t}$ . Hint: cut the  $s$ -plane along the negative real axis and deform the contour onto the cut. Remember that  $\int_0^\infty e^{-ax^2} \cos(bx) dx = \sqrt{\pi/4a} e^{-b^2/4a}$ .

**Hint, Solution**

**Exercise 31.17 (mathematica/ode/laplace/laplace.nb)**

Use Laplace transforms to solve the initial value problem

$$\frac{d^4 y}{dt^4} - y = t, \quad y(0) = y'(0) = y''(0) = y'''(0) = 0.$$

**Hint, Solution**

**Exercise 31.18 (mathematica/ode/laplace/laplace.nb)**

Solve, by Laplace transforms,

$$\frac{dy}{dt} = \sin t + \int_0^t y(\tau) \cos(t - \tau) d\tau, \quad y(0) = 0.$$

**Hint, Solution**

**Exercise 31.19 (mathematica/ode/laplace/laplace.nb)**

Suppose  $u(t)$  satisfies the difference-differential equation

$$\frac{du}{dt} + u(t) - u(t - 1) = 0, \quad t \geq 0,$$

and the 'initial condition'  $u(t) = u_0(t)$ ,  $-1 \leq t \leq 0$ , where  $u_0(t)$  is given. Show that the Laplace transform  $\hat{u}(s)$  of  $u(t)$  satisfies

$$\hat{u}(s) = \frac{u_0(0)}{1+s-e^{-s}} + \frac{e^{-s}}{1+s-e^{-s}} \int_{-1}^0 e^{-st} u_0(t) dt.$$

Find  $u(t)$ ,  $t \geq 0$ , when  $u_0(t) = 1$ . Check the result.

**Hint, Solution**

### Exercise 31.20

Let the function  $f(t)$  be defined by

$$f(t) = \begin{cases} 1 & 0 \leq t < \pi \\ 0 & \pi \leq t < 2\pi, \end{cases}$$

and for all positive values of  $t$  so that  $f(t+2\pi) = f(t)$ . That is,  $f(t)$  is periodic with period  $2\pi$ . Find the solution of the initial value problem

$$\frac{d^2y}{dt^2} - y = f(t); \quad y(0) = 1, \quad y'(0) = 0.$$

Examine the continuity of the solution at  $t = n\pi$ , where  $n$  is a positive integer, and verify that the solution is continuous and has a continuous derivative at these points.

**Hint, Solution**

### Exercise 31.21

Use Laplace transforms to solve

$$\frac{dy}{dt} + \int_0^t y(\tau) d\tau = e^{-t}, \quad y(0) = 1.$$

**Hint, Solution**

**Exercise 31.22**

An electric circuit gives rise to the system

$$\begin{aligned}L \frac{di_1}{dt} + Ri_1 + q/C &= E_0 \\L \frac{di_2}{dt} + Ri_2 - q/C &= 0 \\ \frac{dq}{dt} &= i_1 - i_2\end{aligned}$$

with initial conditions

$$i_1(0) = i_2(0) = \frac{E_0}{2R}, \quad q(0) = 0.$$

Solve the system by Laplace transform methods and show that

$$i_1 = \frac{E_0}{2R} + \frac{E_0}{2\omega L} e^{-\alpha t} \sin(\omega t)$$

where

$$\alpha = \frac{R}{2L} \quad \text{and} \quad \omega^2 = \frac{2}{LC} - \alpha^2.$$

**Hint, Solution**

**Exercise 31.23**

Solve the initial value problem,

$$y'' + 4y' + 4y = 4e^{-t}, \quad y(0) = 2, \quad y'(0) = -3.$$

**Hint, Solution**

## 31.7 Hints

### Hint 31.1

Use the differentiation and integration properties of the Laplace transform where appropriate.

### Hint 31.2

### Hint 31.3

### Hint 31.4

If the integral is uniformly convergent and  $\frac{\partial g}{\partial s}$  is continuous then

$$\frac{d}{ds} \int_a^b g(s, t) dt = \int_a^b \frac{\partial}{\partial s} g(s, t) dt$$

### Hint 31.5

$$\int_s^\infty e^{-tx} dt = \frac{1}{x} e^{-sx}$$

### Hint 31.6

Use integration by parts.

### Hint 31.7

$$\int_0^\infty e^{-st} f(t) dt = \int_{n=0}^\infty \sum_{nT}^{(n+1)T} e^{-st} f(t) dt$$



The sum can be put in the form of a geometric series.

$$\sum_{n=0}^{\infty} \alpha^n = \frac{1}{1 - \alpha}, \quad \text{for } |\alpha| < 1$$

**Hint 31.8**

**Hint 31.9**

Write the answer in terms of the Gamma function.

**Hint 31.10**

**Hint 31.11**

**Hint 31.12**

**Hint 31.13**

**Hint 31.14**

**Hint 31.15**

**Hint 31.16**

**Hint 31.17**

**Hint 31.18**

**Hint 31.19**

**Hint 31.20**

**Hint 31.21**

**Hint 31.22**

**Hint 31.23**

## 31.8 Solutions

### Solution 31.1

1.

$$\begin{aligned}\mathcal{L}[e^{at}] &= \int_0^{\infty} e^{-st} e^{at} dt \\ &= \int_0^{\infty} e^{-(s-a)t} dt \\ &= \left[ -\frac{e^{-(s-a)t}}{s-a} \right]_0^{\infty} \quad \text{for } \Re(s) > \Re(a)\end{aligned}$$

$$\boxed{\mathcal{L}[e^{at}] = \frac{1}{s-a} \quad \text{for } \Re(s) > \Re(a)}$$

2.

$$\begin{aligned}\mathcal{L}[\sin(at)] &= \int_0^{\infty} e^{-st} \sin(at) dt \\ &= \frac{1}{i2} \int_0^{\infty} (e^{(-s+ia)t} - e^{(-s-ia)t}) dt \\ &= \frac{1}{i2} \left[ \frac{-e^{(-s+ia)t}}{s-ia} + \frac{e^{(-s-ia)t}}{s+ia} \right]_0^{\infty}, \quad \text{for } \Re(s) > 0 \\ &= \frac{1}{i2} \left( \frac{1}{s-ia} - \frac{1}{s+ia} \right)\end{aligned}$$

$$\boxed{\mathcal{L}[\sin(at)] = \frac{a}{s^2 + a^2} \quad \text{for } \Re(s) > 0}$$

3.

$$\begin{aligned}\mathcal{L}[\cos(at)] &= \mathcal{L}\left[\frac{d}{dt} \frac{\sin(at)}{a}\right] \\ &= s\mathcal{L}\left[\frac{\sin(at)}{a}\right] - \sin(0)\end{aligned}$$

$$\boxed{\mathcal{L}[\cos(at)] = \frac{s}{s^2 + a^2} \quad \text{for } \Re(s) > 0}$$

4.

$$\begin{aligned}\mathcal{L}[\sinh(at)] &= \int_0^{\infty} e^{-st} \sinh(at) dt \\ &= \frac{1}{2} \int_0^{\infty} (e^{(-s+a)t} - e^{(-s-a)t}) dt \\ &= \frac{1}{2} \left[ \frac{-e^{(-s+a)t}}{s-a} + \frac{e^{(-s-a)t}}{s+a} \right]_0^{\infty} \quad \text{for } \Re(s) > |\Re(a)| \\ &= \frac{1}{2} \left( \frac{1}{s-a} - \frac{1}{s+a} \right)\end{aligned}$$

$$\boxed{\mathcal{L}[\sinh(at)] = \frac{a}{s^2 - a^2} \quad \text{for } \Re(s) > |\Re(a)|}$$

5.

$$\begin{aligned}\mathcal{L}[\cosh(at)] &= \mathcal{L}\left[\frac{d}{dt} \frac{\sinh(at)}{a}\right] \\ &= s\mathcal{L}\left[\frac{\sinh(at)}{a}\right] - \sinh(0)\end{aligned}$$

$$\boxed{\mathcal{L}[\cosh(at)] = \frac{s}{s^2 - a^2} \quad \text{for } \Re(s) > |\Re(a)|}$$

6. First note that

$$\mathcal{L}\left[\frac{\sin(at)}{t}\right](s) = \int_s^\infty \mathcal{L}[\sin(at)](\sigma) d\sigma.$$

Now we use the Laplace transform of  $\sin(at)$  to compute the Laplace transform of  $\sin(at)/t$ .

$$\begin{aligned}\mathcal{L}\left[\frac{\sin(at)}{t}\right] &= \int_s^\infty \frac{a}{\sigma^2 + a^2} d\sigma \\ &= \int_s^\infty \frac{1}{(\sigma/a)^2 + 1} \frac{d\sigma}{a} \\ &= \left[\arctan\left(\frac{\sigma}{a}\right)\right]_s^\infty \\ &= \frac{\pi}{2} - \arctan\left(\frac{s}{a}\right)\end{aligned}$$

$$\boxed{\mathcal{L}\left[\frac{\sin(at)}{t}\right] = \arctan\left(\frac{a}{s}\right)}$$

7.

$$\mathcal{L}\left[\int_0^t \frac{\sin(a\tau)}{\tau} d\tau\right] = \frac{1}{s} \mathcal{L}\left[\frac{\sin(at)}{t}\right]$$

$$\boxed{\mathcal{L}\left[\int_0^t \frac{\sin(a\tau)}{\tau} d\tau\right] = \frac{1}{s} \arctan\left(\frac{a}{s}\right)}$$

8.

$$\begin{aligned}\mathcal{L}[f(t)] &= \frac{\int_0^{2\pi} e^{-st} f(t) dt}{1 - e^{-2\pi s}} \\ &= \frac{\int_0^\pi e^{-st} dt}{1 - e^{-2\pi s}} \\ &= \frac{1 - e^{-\pi s}}{s(1 - e^{-2\pi s})}\end{aligned}$$

$$\mathcal{L}[f(t)] = \frac{1}{s(1 + e^{-\pi s})}$$

### Solution 31.2

$$\begin{aligned}\mathcal{L}[af(t) + bg(t)] &= \int_0^{\infty} e^{-st} (af(t) + bg(t)) dt \\ &= a \int_0^{\infty} e^{-st} f(t) dt + b \int_0^{\infty} e^{-st} g(t) dt \\ &= a\mathcal{L}[f(t)] + b\mathcal{L}[g(t)]\end{aligned}$$

### Solution 31.3

If  $f(t)$  is of exponential order  $\alpha$ , then  $e^{ct} f(t)$  is of exponential order  $c + \alpha$ .

$$\begin{aligned}\mathcal{L}[e^{ct} f(t)] &= \int_0^{\infty} e^{-st} e^{ct} f(t) dt \\ &= \int_0^{\infty} e^{-(s-c)t} f(t) dt \\ &= \hat{f}(s - c) \text{ for } s > c + \alpha\end{aligned}$$

### Solution 31.4

First consider the Laplace transform of  $t^0 f(t)$ .

$$\mathcal{L}[t^0 f(t)] = \hat{f}(s)$$

Now consider the Laplace transform of  $t^n f(t)$  for  $n \geq 1$ .

$$\begin{aligned}\mathcal{L}[t^n f(t)] &= \int_0^{\infty} e^{-st} t^n f(t) dt \\ &= -\frac{d}{ds} \int_0^{\infty} e^{-st} t^{n-1} f(t) dt \\ &= -\frac{d}{ds} \mathcal{L}[t^{n-1} f(t)]\end{aligned}$$

Thus we have a difference equation for the Laplace transform of  $t^n f(t)$  with the solution

$$\mathcal{L}[t^n f(t)] = (-1)^n \frac{d^n}{ds^n} \mathcal{L}[t^0 f(t)] \text{ for } n \in \mathbb{Z}^{0+},$$

$$\mathcal{L}[t^n f(t)] = (-1)^n \frac{d^n}{ds^n} \hat{f}(s) \text{ for } n \in \mathbb{Z}^{0+}.$$

### Solution 31.5

If  $\int_0^{\beta} \frac{f(t)}{t} dt$  exists for positive  $\beta$  and  $f(t)$  is of exponential order  $\alpha$  then the Laplace transform of  $f(t)/t$  is defined for  $s > \alpha$ .

$$\begin{aligned}\mathcal{L}\left[\frac{f(t)}{t}\right] &= \int_0^{\infty} e^{-st} \frac{1}{t} f(t) dt \\ &= \int_0^{\infty} \int_s^{\infty} e^{-\sigma t} d\sigma f(t) dt \\ &= \int_s^{\infty} \int_0^{\infty} e^{-\sigma t} f(t) dt d\sigma \\ &= \int_s^{\infty} \hat{f}(\sigma) d\sigma\end{aligned}$$

**Solution 31.6**

$$\begin{aligned}\mathcal{L}\left[\int_0^t f(\tau) d\tau\right] &= \int_0^\infty e^{-st} \int_0^t f(\tau) d\tau dx \\ &= \left[-\frac{e^{-st}}{s} \int_0^t f(\tau) d\tau\right]_0^\infty - \int_0^\infty -\frac{e^{-st}}{s} \frac{d}{dt} \left[\int_0^t f(\tau) d\tau\right] dt \\ &= \frac{1}{s} \int_0^\infty e^{-st} f(t) dt \\ &= \frac{1}{s} \hat{f}(s)\end{aligned}$$



**Solution 31.7**

$f(t)$  is periodic with period  $T$ .

$$\begin{aligned}\mathcal{L}[f(t)] &= \int_0^{\infty} e^{-st} f(t) dt \\ &= \int_0^T e^{-st} f(t) dt + \int_T^{2T} e^{-st} f(t) dt + \cdots \\ &= \sum_{n=0}^{\infty} \int_{nT}^{(n+1)T} e^{-st} f(t) dt \\ &= \sum_{n=0}^{\infty} \int_0^T e^{-s(t+nT)} f(t+nT) dt \\ &= \sum_{n=0}^{\infty} e^{-snT} \int_0^T e^{-st} f(t) dt \\ &= \int_0^T e^{-st} f(t) dt \sum_{n=0}^{\infty} e^{-snT} \\ &= \frac{\int_0^T e^{-st} f(t) dt}{1 - e^{-sT}}\end{aligned}$$

## Solution 31.8

$$\begin{aligned}
 \hat{f}(s) &= \int_0^{\infty} e^{-st} f(t) dt \\
 &= \sum_0^n \int_{nT}^{(n+1)T} e^{-st} f(t) dt \\
 &= \sum_0^n \int_0^T e^{-s(t+nT)} f(t+nT) dt \\
 &= \sum_0^n e^{-snT} \int_0^T e^{-st} (-1)^n f(t) dt \\
 &= \int_0^T e^{-st} f(t) dt \sum_0^n (-1)^n (e^{-sT})^n
 \end{aligned}$$

$$\boxed{\hat{f}(s) = \frac{\hat{g}(s)}{1 + e^{-sT}}, \quad \text{for } \Re(s) > 0}$$

Consider  $\hat{f}(s) = s^{-1} \tanh(sT/2)$ .

$$\begin{aligned}
 s^{-1} \tanh(sT/2) &= s^{-1} \frac{e^{sT/2} - e^{-sT/2}}{e^{sT/2} + e^{-sT/2}} \\
 &= s^{-1} \frac{1 - e^{-sT}}{1 + e^{-sT}}
 \end{aligned}$$

We have

$$\hat{g}(s) \equiv \int_0^T f(t) e^{-st} dt = \frac{1 - e^{-st}}{s}.$$

By inspection we see that this is satisfied for  $f(t) = 1$  for  $0 < t < T$ . We conclude:

$$f(t) = \begin{cases} 1 & \text{for } t \in [2nT \dots (2n+1)T), \\ -1 & \text{for } t \in [(2n+1)T \dots (2n+2)T), \end{cases}$$

where  $n \in \mathbb{Z}$ .

### Solution 31.9

The Laplace transform of  $t^\nu$ ,  $\nu > -1$  is

$$\hat{f}(s) = \int_0^\infty e^{-st} t^\nu dt.$$

Assume  $s$  is complex-valued. The integral converges for  $\Re(s) > 0$  and  $\nu > -1$ .

**Method 1.** We make the change of variables  $z = st$ .

$$\begin{aligned} \hat{f}(s) &= \int_C e^{-z} \left(\frac{z}{s}\right)^\nu \frac{1}{s} dz \\ &= s^{-(\nu+1)} \int_C e^{-z} z^\nu dz \end{aligned}$$

$C$  is the path from 0 to  $\infty$  along  $\arg(z) = \arg(s)$ . (Shown in Figure 31.4).

Since the integrand is analytic in the domain  $\epsilon < r < R$ ,  $0 < \theta < \arg(s)$ , the integral along the boundary of this domain vanishes.

$$\left( \int_\epsilon^R + \int_R^{Re^{i\arg(s)}} + \int_{Re^{i\arg(s)}}^{\epsilon e^{i\arg(s)}} + \int_{\epsilon e^{i\arg(s)}}^\epsilon \right) e^{-z} z^\nu dz = 0$$

We show that the integral along  $C_R$ , the circular arc of radius  $R$ , vanishes as  $R \rightarrow \infty$  with the maximum modulus

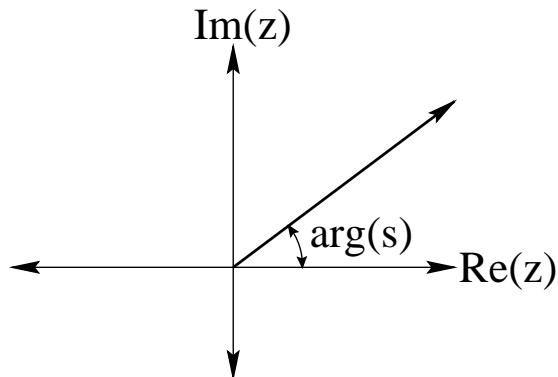

Figure 31.4: The Path of Integration.

integral bound.

$$\begin{aligned}
 \left| \int_{C_R} e^{-z} z^\nu dz \right| &\leq R |\arg(s)| \max_{z \in C_R} |e^{-z} z^\nu| \\
 &= R |\arg(s)| e^{-R \cos(\arg(s))} R^\nu \\
 &\rightarrow 0 \quad \text{as } R \rightarrow \infty.
 \end{aligned}$$

The integral along  $C_\epsilon$ , the circular arc of radius  $\epsilon$ , vanishes as  $\epsilon \rightarrow 0$ . We demonstrate this with the maximum modulus integral bound.

$$\begin{aligned}
 \left| \int_{C_\epsilon} e^{-z} z^\nu dz \right| &\leq \epsilon |\arg(s)| \max_{z \in C_\epsilon} |e^{-z} z^\nu| \\
 &= \epsilon |\arg(s)| e^{-\epsilon \cos(\arg(s))} \epsilon^\nu \\
 &\rightarrow 0 \quad \text{as } \epsilon \rightarrow 0.
 \end{aligned}$$

Taking the limit as  $\epsilon \rightarrow 0$  and  $R \rightarrow \infty$ , we see that the integral along  $C$  is equal to the integral along the real axis.

$$\int_C e^{-z} z^\nu dz = \int_0^\infty e^{-z} z^\nu dz$$

We can evaluate the Laplace transform of  $t^\nu$  in terms of this integral.

$$\mathcal{L}[t^\nu] = s^{-(\nu+1)} \int_0^\infty e^{-t} t^\nu dt$$

$$\boxed{\mathcal{L}[t^\nu] = \frac{\Gamma(\nu+1)}{s^{\nu+1}}}$$

In the case that  $\nu$  is a non-negative integer  $\nu = n > -1$  we can write this in terms of the factorial.

$$\mathcal{L}[t^n] = \frac{n!}{s^{n+1}}$$

**Method 2.** First note that the integral

$$\hat{f}(s) = \int_0^\infty e^{-st} t^\nu dt$$

exists for  $\Re(s) > 0$ . It converges uniformly for  $\Re(s) \geq c > 0$ . On this domain of uniform convergence we can interchange differentiation and integration.

$$\begin{aligned} \frac{d\hat{f}}{ds} &= \frac{d}{ds} \int_0^\infty e^{-st} t^\nu dt \\ &= \int_0^\infty \frac{\partial}{\partial s} (e^{-st} t^\nu) dt \\ &= \int_0^\infty -t e^{-st} t^\nu dt \\ &= - \int_0^\infty e^{-st} t^{\nu+1} dt \end{aligned}$$

Since  $\hat{f}'(s)$  is defined for  $\Re(s) > 0$ ,  $\hat{f}(s)$  is analytic for  $\Re(s) > 0$ .

Let  $\sigma$  be real and positive. We make the change of variables  $x = \sigma t$ .

$$\begin{aligned}\hat{f}(\sigma) &= \int_0^{\infty} e^{-x} \left(\frac{x}{\sigma}\right)^{\nu} \frac{1}{\sigma} dx \\ &= \sigma^{-(\nu+1)} \int_0^{\infty} e^{-x} x^{\nu} dx \\ &= \frac{\Gamma(\nu+1)}{\sigma^{\nu+1}}\end{aligned}$$

Note that the function

$$\hat{f}(s) = \frac{\Gamma(\nu+1)}{s^{\nu+1}}$$

is the analytic continuation of  $\hat{f}(\sigma)$ . Thus we can define the Laplace transform for all complex  $s$  in the right half plane.

$$\boxed{\hat{f}(s) = \frac{\Gamma(\nu+1)}{s^{\nu+1}}}$$

### Solution 31.10

Note that  $\hat{f}(s)$  is an analytic function for  $\Re(s) > 0$ . Consider real-valued  $s > 0$ . By definition,  $\hat{f}(s)$  is

$$\hat{f}(s) = \int_0^{\infty} e^{-st} \ln t dt.$$

We make the change of variables  $x = st$ .

$$\begin{aligned}\hat{f}(s) &= \int_0^{\infty} e^{-x} \ln\left(\frac{x}{s}\right) \frac{dx}{s} \\ &= \frac{1}{s} \int_0^{\infty} e^{-x} (\ln x - \ln s) dx \\ &= -\frac{\ln |s|}{s} \int_0^{\infty} e^{-x} dx + \frac{1}{s} \int_0^{\infty} e^{-x} \ln x dx \\ &= -\frac{\ln s}{s} - \frac{\gamma}{s}, \quad \text{for real } s > 0\end{aligned}$$

The analytic continuation of  $\hat{f}(s)$  into the right half-plane is

$$\hat{f}(s) = -\frac{\text{Log } s}{s} - \frac{\gamma}{s}.$$

### Solution 31.11

Define

$$\hat{f}(s) = \mathcal{L}[t^\nu \ln t] = \int_0^\infty e^{-st} t^\nu \ln t \, dt.$$

This integral defines  $\hat{f}(s)$  for  $\Re(s) > 0$ . Note that the integral converges uniformly for  $\Re(s) \geq c > 0$ . On this domain we can interchange differentiation and integration.

$$\hat{f}'(s) = \int_0^\infty \frac{\partial}{\partial s} (e^{-st} t^\nu \ln t) \, dt = - \int_0^\infty t e^{-st} t^\nu \text{Log } t \, dt$$

Since  $\hat{f}'(s)$  also exists for  $\Re(s) > 0$ ,  $\hat{f}(s)$  is analytic in that domain.

Let  $\sigma$  be real and positive. We make the change of variables  $x = \sigma t$ .

$$\begin{aligned}
 \hat{f}(\sigma) &= \mathcal{L}[t^\nu \ln t] \\
 &= \int_0^\infty e^{-\sigma t} t^\nu \ln t \, dt \\
 &= \int_0^\infty e^{-x} \left(\frac{x}{\sigma}\right)^\nu \ln \frac{x}{\sigma} \frac{1}{\sigma} \, dx \\
 &= \frac{1}{\sigma^{\nu+1}} \int_0^\infty e^{-x} x^\nu (\ln x - \ln \sigma) \, dx \\
 &= \frac{1}{\sigma^{\nu+1}} \left( \int_0^\infty e^{-x} x^\nu \ln x \, dx - \ln \sigma \int_0^\infty e^{-x} x^\nu \, dx \right) \\
 &= \frac{1}{\sigma^{\nu+1}} \left( \int_0^\infty \frac{\partial}{\partial \nu} (e^{-x} x^\nu) \, dx - \ln \sigma \Gamma(\nu + 1) \right) \\
 &= \frac{1}{\sigma^{\nu+1}} \left( \frac{d}{d\nu} \int_0^\infty e^{-x} x^\nu \, dx - \ln \sigma \Gamma(\nu + 1) \right) \\
 &= \frac{1}{\sigma^{\nu+1}} \left( \frac{d}{d\nu} \Gamma(\nu + 1) - \ln \sigma \Gamma(\nu + 1) \right) \\
 &= \frac{1}{\sigma^{\nu+1}} \Gamma(\nu + 1) \left( \frac{\Gamma'(\nu + 1)}{\Gamma(\nu + 1)} - \ln \sigma \right) \\
 &= \frac{1}{\sigma^{\nu+1}} \Gamma(\nu + 1) (\psi(\nu + 1) - \ln \sigma)
 \end{aligned}$$

Note that the function

$$\hat{f}(s) = \frac{1}{s^{\nu+1}} \Gamma(\nu + 1) (\psi(\nu + 1) - \ln s)$$

is an analytic continuation of  $\hat{f}(\sigma)$ . Thus we can define the Laplace transform for all  $s$  in the right half plane.

$$\boxed{\mathcal{L}[t^\nu \ln t] = \frac{1}{s^{\nu+1}} \Gamma(\nu + 1) (\psi(\nu + 1) - \ln s) \quad \text{for } \Re(s) > 0.}$$



For the case  $\nu = 0$ , we have

$$\mathcal{L}[\ln t] = \frac{1}{s^1} \Gamma(1) (\psi(1) - \ln s)$$

$$\boxed{\mathcal{L}[\ln t] = \frac{-\gamma - \ln s}{s}},$$

where  $\gamma$  is Euler's constant

$$\gamma = \int_0^{\infty} e^{-x} \ln x \, dx = 0.5772156629 \dots$$

### Solution 31.12

**Method 1.** We factor the denominator.

$$\hat{f}(s) = \frac{1}{(s-2)(s^2+1)} = \frac{1}{(s-2)(s-i)(s+i)}$$

We expand the function in partial fractions and simplify the result.

$$\begin{aligned} \frac{1}{(s-2)(s-i)(s+i)} &= \frac{1/5}{s-2} - \frac{(1-i2)/10}{s-i} - \frac{(1+i2)/10}{s+i} \\ \hat{f}(s) &= \frac{1}{5} \frac{1}{s-2} - \frac{1}{5} \frac{s+2}{s^2+1} \end{aligned}$$

We use a table of Laplace transforms to do the inversion.

$$\mathcal{L}[e^{2t}] = \frac{1}{s-2}, \quad \mathcal{L}[\cos t] = \frac{s}{s^2+1}, \quad \mathcal{L}[\sin t] = \frac{1}{s^2+1}$$

$$\boxed{f(t) = \frac{1}{5} (e^{2t} - \cos t - 2 \sin t)}$$

**Method 2.** We factor the denominator.

$$\hat{f}(s) = \frac{1}{s-2} \frac{1}{s^2+1}$$

From a table of Laplace transforms we note

$$\mathcal{L}[e^{2t}] = \frac{1}{s-2}, \quad \mathcal{L}[\sin t] = \frac{1}{s^2+1}.$$

We apply the convolution theorem.

$$f(t) = \int_0^t \sin \tau e^{2(t-\tau)} d\tau$$

$$f(t) = \frac{1}{5} (e^{2t} - \cos t - 2 \sin t)$$

**Method 3.** We factor the denominator.

$$\hat{f}(s) = \frac{1}{(s-2)(s-i)(s+i)}$$

$\hat{f}(s)$  is analytic except for poles and vanishes at infinity.

$$\begin{aligned} f(t) &= \sum_{s_n=2, i, -i} \operatorname{Res} \left( \frac{e^{st}}{(s-2)(s-i)(s+i)}, s_n \right) \\ &= \frac{e^{2t}}{(2-i)(2+i)} + \frac{e^{it}}{(i-2)(i2)} + \frac{e^{-it}}{(-i-2)(-i2)} \\ &= \frac{e^{2t}}{5} + \frac{(-1+i2)e^{it}}{10} + \frac{(-1-i2)e^{-it}}{10} \\ &= \frac{e^{2t}}{5} + \frac{e^{it} + e^{-it}}{10} + i \frac{e^{it} - e^{-it}}{5} \end{aligned}$$

$$f(t) = \frac{1}{5} (e^{2t} - \cos t - 2 \sin t)$$

**Solution 31.13**

$$y'' + \epsilon y' + y = \sin t, \quad y(0) = y'(0) = 0, \quad 0 < \epsilon \ll 1$$

We take the Laplace transform of this equation.

$$(s^2 \hat{y}(s) - sy(0) - y'(0)) + \epsilon(s\hat{y}(s) - y(0)) + \hat{y}(s) = \mathcal{L}[\sin(t)]$$

$$(s^2 + \epsilon s + 1)\hat{y}(s) = \mathcal{L}[\sin(t)]$$

$$\hat{y}(s) = \frac{1}{s^2 + \epsilon s + 1} \mathcal{L}[\sin(t)]$$

$$\hat{y}(s) = \frac{1}{(s + \frac{\epsilon}{2})^2 + 1 - \frac{\epsilon^2}{4}} \mathcal{L}[\sin(t)]$$

We use a table of Laplace transforms to find the inverse Laplace transform of the first term.

$$\mathcal{L}^{-1} \left[ \frac{1}{(s + \frac{\epsilon}{2})^2 + 1 - \frac{\epsilon^2}{4}} \right] = \frac{1}{\sqrt{1 - \frac{\epsilon^2}{4}}} e^{-\epsilon t/2} \sin \left( \sqrt{1 - \frac{\epsilon^2}{4}} t \right)$$

We define

$$\alpha = \sqrt{1 - \frac{\epsilon^2}{4}}$$

to get rid of some clutter. Now we apply the convolution theorem to invert <sup>2</sup>  $\hat{y}(s)$ .

$$y(t) = \int_0^t \frac{1}{\alpha} e^{-\epsilon \tau/2} \sin(\alpha \tau) \sin(t - \tau) d\tau$$

$$y(t) = e^{-\epsilon t/2} \left( \frac{1}{\epsilon} \cos(\alpha t) + \frac{1}{2\alpha} \sin(\alpha t) \right) - \frac{1}{\epsilon} \cos t$$

The solution is plotted in Figure 31.5 for  $\epsilon = 0.05$ .

---

<sup>2</sup>Evaluate the convolution integral by inspection.

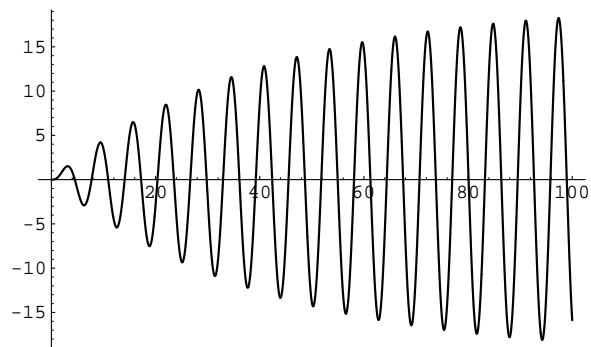

Figure 31.5: The Weakly Damped, Driven Oscillator

### Solution 31.14

We consider the solutions of

$$y'' - ty' + y = 0, \quad y(0) = 0, \quad y'(0) = 1$$

which are of exponential order  $\alpha$  for any  $\alpha > 0$ . We take the Laplace transform of the differential equation.

$$s^2 \hat{y} - 1 + \frac{d}{ds} (s \hat{y}) + \hat{y} = 0$$

$$\hat{y}' + \left( s + \frac{2}{s} \right) \hat{y} = \frac{1}{s}$$

$$\hat{y}(s) = \frac{1}{s^2} + c \frac{e^{-s^2/2}}{s^2}$$

We use that

$$\hat{y}(s) \sim \frac{y(0)}{s} + \frac{y'(0)}{s^2} + \dots$$

to conclude that  $c = 0$ .

$$\hat{y}(s) = \frac{1}{s^2}$$

$$\boxed{y(t) = t}$$

### Solution 31.15

$$\mathcal{L}^{-1}[\hat{f}(s)] = \frac{1}{i2\pi} \int_{c-i\infty}^{c+i\infty} e^{st} \hat{f}(s) ds$$

First we make the change of variable  $s = c + \sigma$ .

$$\mathcal{L}^{-1}[\hat{f}(s)] = \frac{1}{i2\pi} e^{ct} \int_{-i\infty}^{i\infty} e^{\sigma t} \hat{f}(c + \sigma) d\sigma$$

Then we make the change of variable  $\sigma = i\omega$ .

$$\begin{aligned} \mathcal{L}^{-1}[\hat{f}(s)] &= \frac{1}{2\pi} e^{ct} \int_{-\infty}^{\infty} e^{i\omega t} \hat{f}(c + i\omega) d\omega \\ \mathcal{L}^{-1}[\hat{f}(s)] &= \frac{1}{2\pi} e^{ct} \mathcal{F}^{-1}[\hat{f}(c + i\omega)] \end{aligned}$$

### Solution 31.16

We assume that  $\Re(a) \geq 0$ . We are considering the principal branch of the square root:  $s^{1/2} = \sqrt{s}$ . There is a branch cut on the negative real axis.  $\hat{f}(s)$  is singular at  $s = 0$  and along the negative real axis. Let  $\alpha$  be any positive number. The inverse Laplace transform of  $\left(\frac{\pi}{s}\right)^{1/2} e^{-2(as)^{1/2}}$  is

$$f(t) = \frac{1}{i2\pi} \int_{\alpha-i\infty}^{\alpha+i\infty} e^{st} \left(\frac{\pi}{s}\right)^{1/2} e^{-2(as)^{1/2}} ds.$$

We will evaluate the integral by deforming it to wrap around the branch cut. Consider the integral on the contour shown in Figure 31.6.  $C_R^+$  and  $C_R^-$  are circular arcs of radius  $R$ .  $B$  is the vertical line at  $\Re(s) = \alpha$  joining the two arcs.  $C_\epsilon$  is a semi-circle in the right half plane joining  $\epsilon$  and  $-\epsilon$ .  $L^+$  and  $L^-$  are lines joining the circular arcs at  $\Im(s) = \pm\epsilon$ .

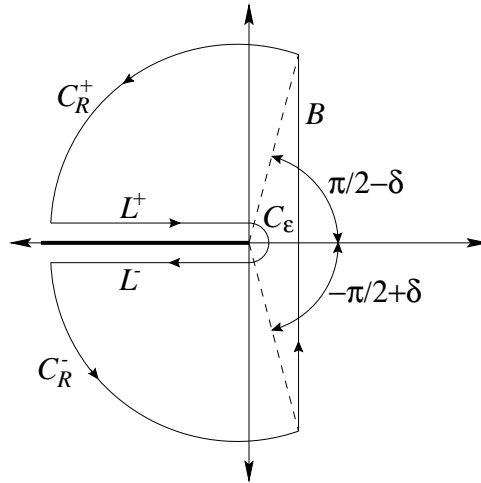

Figure 31.6: Path of Integration

Since there are no residues inside the contour, we have

$$\frac{1}{i2\pi} \left( \int_B + \int_{C_R^+} + \int_{L^+} + \int_{C_\epsilon} + \int_{L^-} + \int_{C_R^-} \right) e^{st} \left( \frac{\pi}{s} \right)^{1/2} e^{-2(as)^{1/2}} ds = 0.$$

We will evaluate the inverse Laplace transform for  $t > 0$ .

First we will show that the integral along  $C_R^+$  vanishes as  $R \rightarrow \infty$ . We parametrize the path of integration with  $s = R e^{i\theta}$  and write the integral along  $C_R^+$  as the sum of two integrals.

$$\int_{C_R^+} \cdots ds = \int_{\pi/2-\delta}^{\pi/2} \cdots d\theta + \int_{\pi/2}^{\pi} \cdots d\theta$$

The first integral vanishes by the maximum modulus bound. Note that the length of the path of integration is less than  $2\alpha$ .

$$\begin{aligned} \left| \int_{\pi/2-\delta}^{\pi/2} \cdots d\theta \right| &\leq \left( \max_{\theta \in [\pi/2-\delta, \pi/2]} \left| e^{st} \left( \frac{\pi}{s} \right)^{1/2} e^{-2(as)^{1/2}} \right| \right) (2\alpha) \\ &= e^{\alpha t} \frac{\sqrt{\pi}}{\sqrt{R}} (2\alpha) \\ &\rightarrow 0 \text{ as } R \rightarrow \infty \end{aligned}$$

The second integral vanishes by Jordan's Lemma.

$$\begin{aligned} \left| \int_{\pi/2}^{\pi} e^{Re^{i\theta}t} \frac{\sqrt{\pi}}{\sqrt{R}e^{i\theta}} e^{-2\sqrt{aR}e^{i\theta}} d\theta \right| &\leq \int_{\pi/2}^{\pi} \left| e^{Re^{i\theta}t} \frac{\sqrt{\pi}}{\sqrt{R}e^{i\theta}} e^{-2\sqrt{aR}e^{i\theta}/2} \right| d\theta \\ &\leq \frac{\sqrt{\pi}}{\sqrt{R}} \int_{\pi/2}^{\pi} e^{R\cos(\theta)t} d\theta \\ &\leq \frac{\sqrt{\pi}}{\sqrt{R}} \int_0^{\pi/2} e^{-Rt\sin(\phi)} d\phi \\ &< \frac{\sqrt{\pi}}{\sqrt{R}} \frac{\pi}{2Rt} \\ &\rightarrow 0 \text{ as } R \rightarrow \infty \end{aligned}$$

We could show that the integral along  $C_R^-$  vanishes by the same method.

Now we have

$$\frac{1}{i2\pi} \left( \int_B + \int_{L^+} + \int_{C_\epsilon} + \int_{L^-} \right) e^{st} \left( \frac{\pi}{s} \right)^{1/2} e^{-2(as)^{1/2}} ds = 0.$$

We show that the integral along  $C_\epsilon$  vanishes as  $\epsilon \rightarrow 0$  with the maximum modulus bound.

$$\begin{aligned} \left| \int_{C_\epsilon} e^{st} \left(\frac{\pi}{s}\right)^{1/2} e^{-2(as)^{1/2}} ds \right| &\leq \left( \max_{s \in C_\epsilon} \left| e^{st} \left(\frac{\pi}{s}\right)^{1/2} e^{-2(as)^{1/2}} \right| \right) (\pi\epsilon) \\ &\leq e^{\epsilon t} \frac{\sqrt{\pi}}{\sqrt{\epsilon}} \pi\epsilon \\ &\rightarrow 0 \quad \text{as } \epsilon \rightarrow 0. \end{aligned}$$

Now we can express the inverse Laplace transform in terms of the integrals along  $L^+$  and  $L^-$

$$\begin{aligned} f(t) &\equiv \frac{1}{i2\pi} \int_{\alpha-i\infty}^{\alpha+i\infty} e^{st} \left(\frac{\pi}{s}\right)^{1/2} e^{-2(as)^{1/2}} ds \\ &= -\frac{1}{i2\pi} \int_{L^+} e^{st} \left(\frac{\pi}{s}\right)^{1/2} e^{-2(as)^{1/2}} ds - \frac{1}{i2\pi} \int_{L^-} e^{st} \left(\frac{\pi}{s}\right)^{1/2} e^{-2(as)^{1/2}} ds. \end{aligned}$$

On  $L^+$ ,  $s = r e^{i\pi}$ ,  $ds = e^{i\pi} dr = -dr$ ; on  $L^-$ ,  $s = r e^{-i\pi}$ ,  $ds = e^{-i\pi} dr = -dr$ . We can combine the integrals along the top and bottom of the branch cut.

$$\begin{aligned} f(t) &= -\frac{1}{i2\pi} \int_{\infty}^0 e^{-rt} \frac{\sqrt{\pi}}{i\sqrt{r}} e^{-i2\sqrt{a}\sqrt{r}} (-dr) - \frac{1}{i2\pi} \int_0^{\infty} e^{-rt} \frac{\sqrt{\pi}}{-i\sqrt{r}} e^{i2\sqrt{a}\sqrt{r}} (-dr) \\ &= \frac{1}{2\sqrt{\pi}} \int_0^{\infty} e^{-rt} \frac{1}{\sqrt{r}} \left( e^{-i2\sqrt{a}\sqrt{r}} + e^{i2\sqrt{a}\sqrt{r}} \right) dr \\ &= \frac{1}{2\sqrt{\pi}} \int_0^{\infty} \frac{1}{\sqrt{r}} e^{-rt} 2 \cos(2\sqrt{a}\sqrt{r}) dr \end{aligned}$$



We make the change of variables  $x = \sqrt{r}$ .

$$\begin{aligned} &= \frac{1}{\sqrt{\pi}} \int_0^{\infty} \frac{1}{x} e^{-tx^2} \cos(2\sqrt{a}x) 2x \, dx \\ &= \frac{2}{\sqrt{\pi}} \int_0^{\infty} e^{-tx^2} \cos(2\sqrt{a}x) \, dx \\ &= \frac{2}{\sqrt{\pi}} \sqrt{\frac{\pi}{4t}} e^{-4a/(4t)} \\ &= \frac{e^{-a/t}}{\sqrt{t}} \end{aligned}$$

Thus the inverse Laplace transform is

$$f(t) = \frac{e^{-a/t}}{\sqrt{t}}$$

### Solution 31.17

We consider the problem

$$\frac{d^4 y}{dt^4} - y = t, \quad y(0) = y'(0) = y''(0) = y'''(0) = 0.$$

We take the Laplace transform of the differential equation.

$$\begin{aligned} s^4 \hat{y}(s) - s^3 y(0) - s^2 y'(0) - s y''(0) - y'''(0) - \hat{y}(s) &= \frac{1}{s^2} \\ s^4 \hat{y}(s) - \hat{y}(s) &= \frac{1}{s^2} \\ \hat{y}(s) &= \frac{1}{s^2(s^4 - 1)} \end{aligned}$$

There are several ways in which we could carry out the inverse Laplace transform to find  $y(t)$ . We could expand the right side in partial fractions and then use a table of Laplace transforms. Since the function is analytic except for

isolated singularities and vanishes as  $s \rightarrow \infty$  we could use the result,

$$\mathcal{L}^{-1}[\hat{f}(s)] = \sum_{n=1}^N \operatorname{Res} \left( e^{st} \hat{f}(s), s_n \right),$$

where  $\{s_k\}_{k=1}^n$  are the singularities of  $\hat{f}(s)$ . Since we can write the function as a product of simpler terms we could also apply the convolution theorem.

We will first do the inverse Laplace transform by expanding the function in partial fractions to obtain simpler rational functions.

$$\begin{aligned} \frac{1}{s^2(s^4 - 1)} &= \frac{1}{s^2(s - 1)(s + 1)(s - \iota)(s + \iota)} \\ &= \frac{a}{s^2} + \frac{b}{s} + \frac{c}{s - 1} + \frac{d}{s + 1} + \frac{e}{s - \iota} + \frac{f}{s + \iota} \end{aligned}$$

$$a = \left[ \frac{1}{s^4 - 1} \right]_{s=0} = -1$$

$$b = \left[ \frac{d}{ds} \frac{1}{s^4 - 1} \right]_{s=0} = 0$$

$$c = \left[ \frac{1}{s^2(s + 1)(s - \iota)(s + \iota)} \right]_{s=1} = \frac{1}{4}$$

$$d = \left[ \frac{1}{s^2(s - 1)(s - \iota)(s + \iota)} \right]_{s=-1} = -\frac{1}{4}$$

$$e = \left[ \frac{1}{s^2(s - 1)(s + 1)(s + \iota)} \right]_{s=\iota} = -\iota \frac{1}{4}$$

$$f = \left[ \frac{1}{s^2(s - 1)(s + 1)(s - \iota)} \right]_{s=-\iota} = \iota \frac{1}{4}$$

Now we have simple functions that we can look up in a table.

$$\hat{y}(s) = -\frac{1}{s^2} + \frac{1/4}{s-1} - \frac{1/4}{s+1} + \frac{1/2}{s^2+1}$$

$$y(t) = \left( -t + \frac{1}{4}e^t - \frac{1}{4}e^{-t} + \frac{1}{2}\sin t \right) H(t)$$

$$y(t) = \left( -t + \frac{1}{2}(\sinh t + \sin t) \right) H(t)$$

We can also do the inversion with the convolution theorem.

$$\frac{1}{s^2(s^4-1)} = \frac{1}{s^2} \frac{1}{s^2+1} \frac{1}{s^2-1}$$

From a table of Laplace transforms we know,

$$\mathcal{L}^{-1} \left[ \frac{1}{s^2} \right] = t,$$

$$\mathcal{L}^{-1} \left[ \frac{1}{s^2+1} \right] = \sin t,$$

$$\mathcal{L}^{-1} \left[ \frac{1}{s^2-1} \right] = \sinh t.$$

Now we use the convolution theorem to find the solution for  $t > 0$ .

$$\mathcal{L}^{-1} \left[ \frac{1}{s^4-1} \right] = \int_0^t \sinh(\tau) \sin(t-\tau) d\tau$$

$$= \frac{1}{2} (\sinh t - \sin t)$$

$$\mathcal{L}^{-1} \left[ \frac{1}{s^2(s^4-1)} \right] = \int_0^t \frac{1}{2} (\sinh \tau - \sin \tau) (t-\tau) d\tau$$

$$= -t + \frac{1}{2} (\sinh t + \sin t)$$

**Solution 31.18**

$$\begin{aligned}\frac{dy}{dt} &= \sin t + \int_0^t y(\tau) \cos(t - \tau) d\tau \\ s\hat{y}(s) - y(0) &= \frac{1}{s^2 + 1} + \hat{y}(s) \frac{s}{s^2 + 1} \\ (s^3 + s)\hat{y}(s) - s\hat{y}(s) &= 1 \\ \hat{y}(s) &= \frac{1}{s^3} \\ \boxed{y(t) = \frac{t^2}{2}}\end{aligned}$$

**Solution 31.19**

The Laplace transform of  $u(t - 1)$  is

$$\begin{aligned}\mathcal{L}[u(t - 1)] &= \int_0^\infty e^{-st} u(t - 1) dt \\ &= \int_{-1}^\infty e^{-s(t+1)} u(t) dt \\ &= e^{-s} \int_{-1}^0 e^{-st} u(t) dt + e^{-s} \int_0^\infty e^{-st} u(t) dt \\ &= e^{-s} \int_{-1}^0 e^{-st} u_0(t) dt + e^{-s} \hat{u}(s).\end{aligned}$$

We take the Laplace transform of the difference-differential equation.

$$s\hat{u}(s) - u(0) + \hat{u}(s) - e^{-s} \int_{-1}^0 e^{-st} u_0(t) dt + e^{-s} \hat{u}(s) = 0$$

$$(1 + s - e^{-s})\hat{u}(s) = u_0(0) + e^{-s} \int_{-1}^0 e^{-st} u_0(t) dt$$

$$\hat{u}(s) = \frac{u_0(0)}{1 + s - e^{-s}} + \frac{e^{-s}}{1 + s - e^{-s}} \int_{-1}^0 e^{-st} u_0(t) dt$$

Consider the case  $u_0(t) = 1$ .

$$\hat{u}(s) = \frac{1}{1 + s - e^{-s}} + \frac{e^{-s}}{1 + s - e^{-s}} \int_{-1}^0 e^{-st} dt$$

$$\hat{u}(s) = \frac{1}{1 + s - e^{-s}} + \frac{e^{-s}}{1 + s - e^{-s}} \left( -\frac{1}{s} + \frac{1}{s} e^s \right)$$

$$\hat{u}(s) = \frac{1/s + 1 - e^{-s}/s}{1 + s - e^{-s}}$$

$$\hat{u}(s) = \frac{1}{s}$$

$$u(t) = 1$$

Clearly this solution satisfies the difference-differential equation.

### Solution 31.20

We consider the problem,

$$\frac{d^2 y}{dt^2} - y = f(t), \quad y(0) = 1, \quad y'(0) = 0,$$

where  $f(t)$  is periodic with period  $2\pi$  and is defined by,

$$f(t) = \begin{cases} 1 & 0 \leq t < \pi, \\ 0 & \pi \leq t < 2\pi. \end{cases}$$

We take the Laplace transform of the differential equation.

$$s^2 \hat{y}(s) - sy(0) - y'(0) - \hat{y}(s) = \hat{f}(s)$$

$$s^2 \hat{y}(s) - s - \hat{y}(s) = \hat{f}(s)$$

$$\hat{y}(s) = \frac{s}{s^2 - 1} + \frac{\hat{f}(s)}{s^2 - 1}$$

By inspection, (of a table of Laplace transforms), we see that

$$\mathcal{L}^{-1} \left[ \frac{s}{s^2 - 1} \right] = \cosh(t)H(t),$$

$$\mathcal{L}^{-1} \left[ \frac{1}{s^2 - 1} \right] = \sinh(t)H(t).$$

Now we use the convolution theorem.

$$\mathcal{L}^{-1} \left[ \frac{\hat{f}(s)}{s^2 - 1} \right] = \int_0^t f(\tau) \sinh(t - \tau) d\tau$$

The solution for positive  $t$  is

$$y(t) = \cosh(t) + \int_0^t f(\tau) \sinh(t - \tau) d\tau.$$

Clearly the solution is continuous because the integral of a bounded function is continuous. The first derivative of the solution is

$$y'(t) = \sinh t + f(t) \sinh(0) + \int_0^t f(\tau) \cosh(t - \tau) d\tau$$

$$y'(t) = \sinh t + \int_0^t f(\tau) \cosh(t - \tau) d\tau$$

We see that the first derivative is also continuous.

**Solution 31.21**

We consider the problem

$$\frac{dy}{dt} + \int_0^t y(\tau) d\tau = e^{-t}, \quad y(0) = 1.$$

We take the Laplace transform of the equation and solve for  $\hat{y}$ .

$$s\hat{y} - y(0) + \frac{\hat{y}}{s} = \frac{1}{s+1}$$

$$\hat{y} = \frac{s(s+2)}{(s+1)(s^2+1)}$$

We expand the right side in partial fractions.

$$\hat{y} = -\frac{1}{2(s+1)} + \frac{1+3s}{2(s^2+1)}$$

We use a table of Laplace transforms to do the inversion.

$$y = -\frac{1}{2}e^{-t} + \frac{1}{2}(\sin(t) + 3\cos(t))$$

**Solution 31.22**

We consider the problem

$$L\frac{di_1}{dt} + Ri_1 + q/C = E_0$$

$$L\frac{di_2}{dt} + Ri_2 - q/C = 0$$

$$\frac{dq}{dt} = i_1 - i_2$$

$$i_1(0) = i_2(0) = \frac{E_0}{2R}, \quad q(0) = 0.$$

We take the Laplace transform of the system of differential equations.

$$\begin{aligned}L\left(s\hat{i}_1 - \frac{E_0}{2R}\right) + R\hat{i}_1 + \frac{\hat{q}}{C} &= \frac{E_0}{s} \\L\left(s\hat{i}_2 - \frac{E_0}{2R}\right) + R\hat{i}_2 - \frac{\hat{q}}{C} &= 0 \\s\hat{q} &= \hat{i}_1 - \hat{i}_2\end{aligned}$$

We solve for  $\hat{i}_1$ ,  $\hat{i}_2$  and  $\hat{q}$ .

$$\begin{aligned}\hat{i}_1 &= \frac{E_0}{2} \left( \frac{1}{Rs} + \frac{1/L}{s^2 + Rs/L + 2/(CL)} \right) \\ \hat{i}_2 &= \frac{E_0}{2} \left( \frac{1}{Rs} - \frac{1/L}{s^2 + Rs/L + 2/(CL)} \right) \\ \hat{q} &= \frac{CE_0}{2} \left( \frac{1}{s} - \frac{s + R/L}{s^2 + Rs/L + 2/(CL)} \right)\end{aligned}$$

We factor the polynomials in the denominators.

$$\begin{aligned}\hat{i}_1 &= \frac{E_0}{2} \left( \frac{1}{Rs} + \frac{1/L}{(s + \alpha - i\omega)(s + \alpha + i\omega)} \right) \\ \hat{i}_2 &= \frac{E_0}{2} \left( \frac{1}{Rs} - \frac{1/L}{(s + \alpha - i\omega)(s + \alpha + i\omega)} \right) \\ \hat{q} &= \frac{CE_0}{2} \left( \frac{1}{s} - \frac{s + 2\alpha}{(s + \alpha - i\omega)(s + \alpha + i\omega)} \right)\end{aligned}$$

Here we have defined

$$\alpha = \frac{R}{2L} \quad \text{and} \quad \omega^2 = \frac{2}{LC} - \alpha^2.$$



We expand the functions in partial fractions.

$$\begin{aligned}\hat{i}_1 &= \frac{E_0}{2} \left( \frac{1}{Rs} + \frac{\imath}{2\omega L} \left( \frac{1}{s + \alpha + \imath\omega} - \frac{1}{s + \alpha - \imath\omega} \right) \right) \\ \hat{i}_2 &= \frac{E_0}{2} \left( \frac{1}{Rs} - \frac{\imath}{2\omega L} \left( \frac{1}{s + \alpha + \imath\omega} - \frac{1}{s + \alpha - \imath\omega} \right) \right) \\ \hat{q} &= \frac{CE_0}{2} \left( \frac{1}{s} + \frac{\imath}{2\omega} \left( \frac{\alpha + \imath\omega}{s + \alpha - \imath\omega} - \frac{\alpha - \imath\omega}{s + \alpha + \imath\omega} \right) \right)\end{aligned}$$

Now we can do the inversion with a table of Laplace transforms.

$$\begin{aligned}i_1 &= \frac{E_0}{2} \left( \frac{1}{R} + \frac{\imath}{2\omega L} (e^{(-\alpha-\imath\omega)t} - e^{(-\alpha+\imath\omega)t}) \right) \\ i_2 &= \frac{E_0}{2} \left( \frac{1}{R} - \frac{\imath}{2\omega L} (e^{(-\alpha-\imath\omega)t} - e^{(-\alpha+\imath\omega)t}) \right) \\ q &= \frac{CE_0}{2} \left( 1 + \frac{\imath}{2\omega} ((\alpha + \imath\omega) e^{(-\alpha+\imath\omega)t} - (\alpha - \imath\omega) e^{(-\alpha-\imath\omega)t}) \right)\end{aligned}$$

We simplify the expressions to obtain the solutions.

$$\begin{aligned}i_1 &= \frac{E_0}{2} \left( \frac{1}{R} + \frac{1}{\omega L} e^{-\alpha t} \sin(\omega t) \right) \\ i_2 &= \frac{E_0}{2} \left( \frac{1}{R} - \frac{1}{\omega L} e^{-\alpha t} \sin(\omega t) \right) \\ q &= \frac{CE_0}{2} \left( 1 - e^{-\alpha t} \left( \cos(\omega t) + \frac{\alpha}{\omega} \sin(\omega t) \right) \right)\end{aligned}$$

### Solution 31.23

We consider the problem

$$y'' + 4y' + 4y = 4e^{-t}, \quad y(0) = 2, \quad y'(0) = -3$$

We take the Laplace transform of the differential equation and solve for  $\hat{y}(s)$ .

$$s^2\hat{y} - sy(0) - y'(0) + 4s\hat{y} - 4y(0) + 4\hat{y} = \frac{4}{s+1}$$

$$s^2\hat{y} - 2s + 3 + 4s\hat{y} - 8 + 4\hat{y} = \frac{4}{s+1}$$

$$\hat{y} = \frac{4}{(s+1)(s+2)^2} + \frac{2s+5}{(s+2)^2}$$

$$\hat{y} = \frac{4}{s+1} - \frac{2}{s+2} - \frac{3}{(s+2)^2}$$

We take the inverse Laplace transform to determine the solution.

$$y = 4e^{-t} - (2 + 3t)e^{-2t}$$

# Chapter 32

## The Fourier Transform

### 32.1 Derivation from a Fourier Series

Consider the eigenvalue problem

$$y'' + \lambda y = 0, \quad y(-L) = y(L), \quad y'(-L) = y'(L).$$

The eigenvalues and eigenfunctions are

$$\lambda_n = \left(\frac{n\pi}{L}\right)^2 \quad \text{for } n \in \mathbb{Z}^{0+}$$
$$\phi_n = \frac{\pi}{L} e^{in\pi x/L}, \quad \text{for } n \in \mathbb{Z}$$

The eigenfunctions form an orthogonal set. A piecewise continuous function defined on  $[-L \dots L]$  can be expanded in a series of the eigenfunctions.

$$f(x) \sim \sum_{n=-\infty}^{\infty} c_n \frac{\pi}{L} e^{in\pi x/L}$$

The Fourier coefficients are

$$c_n = \frac{\left\langle \frac{\pi}{L} e^{in\pi x/L} \middle| f(x) \right\rangle}{\left\langle \frac{\pi}{L} e^{in\pi x/L} \middle| \frac{\pi}{L} e^{in\pi x/L} \right\rangle}$$

$$= \frac{1}{2\pi} \int_{-L}^L e^{-in\pi x/L} f(x) dx.$$

We substitute the expression for  $c_n$  into the series for  $f(x)$ .

$$f(x) \sim \sum_{n=-\infty}^{\infty} \left[ \frac{1}{2L} \int_{-L}^L e^{-in\pi\xi/L} f(\xi) d\xi \right] e^{in\pi x/L}.$$

We let  $\omega_n = n\pi/L$  and  $\Delta\omega = \pi/L$ .

$$f(x) \sim \sum_{\omega_n=-\infty}^{\infty} \left[ \frac{1}{2\pi} \int_{-L}^L e^{-i\omega_n\xi} f(\xi) d\xi \right] e^{i\omega_n x} \Delta\omega.$$

In the limit as  $L \rightarrow \infty$ , (and thus  $\Delta\omega \rightarrow 0$ ), the sum becomes an integral.

$$f(x) \sim \int_{-\infty}^{\infty} \left[ \frac{1}{2\pi} \int_{-\infty}^{\infty} e^{-i\omega\xi} f(\xi) d\xi \right] e^{i\omega x} d\omega.$$

Thus the expansion of  $f(x)$  for finite  $L$

$$f(x) \sim \sum_{n=-\infty}^{\infty} c_n \frac{\pi}{L} e^{in\pi x/L}$$

$$c_n = \frac{1}{2\pi} \int_{-L}^L e^{-in\pi x/L} f(x) dx$$

in the limit as  $L \rightarrow \infty$  becomes

$$f(x) \sim \int_{-\infty}^{\infty} \hat{f}(\omega) e^{i\omega x} d\omega$$

$$\hat{f}(\omega) = \frac{1}{2\pi} \int_{-\infty}^{\infty} f(x) e^{-i\omega x} dx.$$

Of course this derivation is only heuristic. In the next section we will explore these formulas more carefully.

## 32.2 The Fourier Transform

Let  $f(x)$  be piecewise continuous and let  $\int_{-\infty}^{\infty} |f(x)| dx$  exist. We define the function  $I(x, L)$ .

$$I(x, L) = \frac{1}{2\pi} \int_{-L}^L \left( \int_{-\infty}^{\infty} f(\xi) e^{i\omega\xi} d\xi \right) e^{-i\omega x} d\omega.$$

Since the integral in parentheses is uniformly convergent, we can interchange the order of integration.

$$\begin{aligned} &= \frac{1}{2\pi} \int_{-\infty}^{\infty} \left( \int_{-L}^L f(\xi) e^{i\omega(\xi-x)} d\omega \right) d\xi \\ &= \frac{1}{2\pi} \int_{-\infty}^{\infty} \left[ f(\xi) \frac{e^{i\omega(\xi-x)}}{i(\xi-x)} \right]_{-L}^L d\xi \\ &= \frac{1}{2\pi} \int_{-\infty}^{\infty} f(\xi) \frac{1}{i(\xi-x)} (e^{iL(\xi-x)} - e^{-iL(\xi-x)}) d\xi \\ &= \frac{1}{\pi} \int_{-\infty}^{\infty} f(\xi) \frac{\sin(L(\xi-x))}{\xi-x} d\xi \\ &= \frac{1}{\pi} \int_{-\infty}^{\infty} f(\xi+x) \frac{\sin(L\xi)}{\xi} d\xi. \end{aligned}$$

In Example 32.3.3 we will show that

$$\int_0^{\infty} \frac{\sin(L\xi)}{\xi} d\xi = \frac{\pi}{2}.$$

**Continuous Functions.** Suppose that  $f(x)$  is continuous.

$$f(x) = \frac{1}{\pi} \int_{-\infty}^{\infty} f(x) \frac{\sin(L\xi)}{\xi} d\xi$$

$$I(x, L) - f(x) = \frac{1}{\pi} \int_{-\infty}^{\infty} \frac{f(x+\xi) - f(x)}{\xi} \sin(L\xi) d\xi.$$

If  $f(x)$  has a left and right derivative at  $x$  then  $\frac{f(x+\xi)-f(x)}{\xi}$  is bounded and  $\int_{-\infty}^{\infty} \left| \frac{f(x+\xi)-f(x)}{\xi} \right| d\xi < \infty$ . We use the Riemann-Lebesgue lemma to show that the integral vanishes as  $L \rightarrow \infty$ .

$$\frac{1}{\pi} \int_{-\infty}^{\infty} \frac{f(x+\xi) - f(x)}{\xi} \sin(L\xi) d\xi \rightarrow 0 \text{ as } L \rightarrow \infty.$$

Now we have an identity for  $f(x)$ .

$$f(x) = \frac{1}{2\pi} \int_{-\infty}^{\infty} \left( \int_{-\infty}^{\infty} f(\xi) e^{i\omega\xi} d\xi \right) e^{-i\omega x} d\omega.$$

**Piecewise Continuous Functions.** Now consider the case that  $f(x)$  is only piecewise continuous.

$$\frac{f(x^+)}{2} = \frac{1}{\pi} \int_0^{\infty} f(x^+) \frac{\sin(L\xi)}{\xi} d\xi$$

$$\frac{f(x^-)}{2} = \frac{1}{\pi} \int_{-\infty}^0 f(x^-) \frac{\sin(L\xi)}{\xi} d\xi$$

$$I(x, L) - \frac{f(x^+) + f(x^-)}{2} = \int_{-\infty}^0 \left( \frac{f(x + \xi) - f(x^-)}{\xi} \right) \sin(L\xi) \, d\xi \\ - \int_0^{\infty} \left( \frac{f(x + \xi) - f(x^+)}{\xi} \right) \sin(L\xi) \, d\xi$$

If  $f(x)$  has a left and right derivative at  $x$ , then

$$\frac{f(x + \xi) - f(x^-)}{\xi} \text{ is bounded for } \xi \leq 0, \text{ and} \\ \frac{f(x + \xi) - f(x^+)}{\xi} \text{ is bounded for } \xi \geq 0.$$

Again using the Riemann-Lebesgue lemma we see that

$$\frac{f(x^+) + f(x^-)}{2} = \frac{1}{2\pi} \int_{-\infty}^{\infty} \left( \int_{-\infty}^{\infty} f(\xi) e^{i\omega\xi} \, d\xi \right) e^{-i\omega x} \, d\omega.$$

**Result 32.2.1** Let  $f(x)$  be piecewise continuous with  $\int_{-\infty}^{\infty} |f(x)| dx < \infty$ . The Fourier transform of  $f(x)$  is defined

$$\hat{f}(\omega) = \mathcal{F}[f(x)] = \frac{1}{2\pi} \int_{-\infty}^{\infty} f(x) e^{-i\omega x} dx.$$

We see that the integral is uniformly convergent. The inverse Fourier transform is defined

$$\frac{f(x^+) + f(x^-)}{2} = \mathcal{F}^{-1}[\hat{f}(\omega)] = \int_{-\infty}^{\infty} \hat{f}(\omega) e^{i\omega x} d\omega.$$

If  $f(x)$  is continuous then this reduces to

$$f(x) = \mathcal{F}^{-1}[\hat{f}(\omega)] = \int_{-\infty}^{\infty} \hat{f}(\omega) e^{i\omega x} d\omega.$$

### 32.2.1 A Word of Caution

Other texts may define the Fourier transform differently. The important relation is

$$f(x) = \int_{-\infty}^{\infty} \left( \frac{1}{2\pi} \int_{-\infty}^{\infty} f(\xi) e^{\mp i\omega \xi} d\xi \right) e^{\pm i\omega x} d\omega.$$

Multiplying the right side of this equation by  $1 = \frac{1}{\alpha} \alpha$  yields

$$f(x) = \frac{1}{\alpha} \int_{-\infty}^{\infty} \left( \frac{\alpha}{2\pi} \int_{-\infty}^{\infty} f(\xi) e^{\mp i\omega \xi} d\xi \right) e^{\pm i\omega x} d\omega.$$



Setting  $\alpha = \sqrt{2\pi}$  and choosing sign in the exponentials gives us the Fourier transform pair

$$\hat{f}(\omega) = \frac{1}{\sqrt{2\pi}} \int_{-\infty}^{\infty} f(x) e^{-i\omega x} dx$$
$$f(x) = \frac{1}{\sqrt{2\pi}} \int_{-\infty}^{\infty} \hat{f}(\omega) e^{i\omega x} d\omega.$$

Other equally valid pairs are

$$\hat{f}(\omega) = \int_{-\infty}^{\infty} f(x) e^{-i\omega x} dx$$
$$f(x) = \frac{1}{2\pi} \int_{-\infty}^{\infty} \hat{f}(\omega) e^{i\omega x} d\omega,$$

and

$$\hat{f}(\omega) = \int_{-\infty}^{\infty} f(x) e^{i\omega x} dx$$
$$f(x) = \frac{1}{2\pi} \int_{-\infty}^{\infty} \hat{f}(\omega) e^{-i\omega x} d\omega.$$

Be aware of the different definitions when reading other texts or consulting tables of Fourier transforms.

## 32.3 Evaluating Fourier Integrals

### 32.3.1 Integrals that Converge

If the Fourier integral

$$\mathcal{F}[f(x)] = \frac{1}{2\pi} \int_{-\infty}^{\infty} f(x) e^{-i\omega x} dx,$$

converges for real  $\omega$ , then finding the transform of a function is just a matter of direct integration. We will consider several examples of such garden variety functions in this subsection. Later on we will consider the more interesting cases when the integral does not converge for real  $\omega$ .

**Example 32.3.1** Consider the Fourier transform of  $e^{-a|x|}$ , where  $a > 0$ . Since the integral of  $e^{-a|x|}$  is absolutely convergent, we know that the Fourier transform integral converges for real  $\omega$ . We write out the integral.

$$\begin{aligned}\mathcal{F} [e^{-a|x|}] &= \frac{1}{2\pi} \int_{-\infty}^{\infty} e^{-a|x|} e^{-i\omega x} dx \\ &= \frac{1}{2\pi} \int_{-\infty}^0 e^{ax-i\omega x} dx + \frac{1}{2\pi} \int_0^{\infty} e^{-ax-i\omega x} dx \\ &= \frac{1}{2\pi} \int_{-\infty}^0 e^{(a-i\Re(\omega)+\Im(\omega))x} dx + \frac{1}{2\pi} \int_0^{\infty} e^{(-a-i\Re(\omega)+\Im(\omega))x} dx\end{aligned}$$

The integral converges for  $|\Im(\omega)| < a$ . This domain is shown in Figure 32.1.

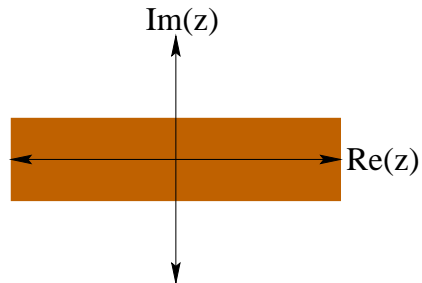

Figure 32.1: The Domain of Convergence

Now We do the integration.

$$\begin{aligned}
 \mathcal{F} [e^{-a|x|}] &= \frac{1}{2\pi} \int_{-\infty}^0 e^{(a-i\omega)x} dx + \frac{1}{2\pi} \int_0^{\infty} e^{-(a+i\omega)x} dx \\
 &= \frac{1}{2\pi} \left[ \frac{e^{(a-i\omega)x}}{a-i\omega} \right]_{-\infty}^0 + \frac{1}{2\pi} \left[ -\frac{e^{-(a+i\omega)x}}{a+i\omega} \right]_0^{\infty} \\
 &= \frac{1}{2\pi} \left( \frac{1}{a-i\omega} + \frac{1}{a+i\omega} \right) \\
 &= \frac{1}{\pi} \frac{a}{\omega^2 + a^2}, \quad \text{for } |\Im(\omega)| < a
 \end{aligned}$$

We can extend the domain of the Fourier transform with analytic continuation.

$$\mathcal{F} [e^{-a|x|}] = \frac{a}{\pi(\omega^2 + a^2)}, \quad \text{for } \omega \neq \pm ia$$

**Example 32.3.2** Consider the Fourier transform of  $f(x) = \frac{1}{x-i\alpha}$ ,  $\alpha > 0$ .

$$\mathcal{F} \left[ \frac{1}{x-i\alpha} \right] = \frac{1}{2\pi} \int_{-\infty}^{\infty} \frac{1}{x-i\alpha} e^{-i\omega x} dx$$

The integral converges for  $\Im(\omega) = 0$ . We will evaluate the integral for positive and negative real values of  $\omega$ .

For  $\omega > 0$ , we will close the path of integration in the lower half-plane. Let  $C_R$  be the contour from  $x = R$  to  $x = -R$  following a semicircular path in the lower half-plane. The integral along  $C_R$  vanishes as  $R \rightarrow \infty$  by Jordan's Lemma.

$$\int_{C_R} \frac{1}{x-i\alpha} e^{-i\omega x} dx \rightarrow 0 \quad \text{as } R \rightarrow \infty.$$

Since the integrand is analytic in the lower half-plane the integral vanishes.

$$\mathcal{F} \left[ \frac{1}{x-i\alpha} \right] = 0$$

For  $\omega < 0$ , we will close the path of integration in the upper half-plane. Let  $C_R$  denote the semicircular contour from  $x = R$  to  $x = -R$  in the upper half-plane. The integral along  $C_R$  vanishes as  $R$  goes to infinity by Jordan's Lemma. We evaluate the Fourier transform integral with the Residue Theorem.

$$\begin{aligned}\mathcal{F}\left[\frac{1}{x - i\alpha}\right] &= \frac{1}{2\pi} 2\pi i \operatorname{Res}\left(\frac{e^{-i\omega x}}{x - i\alpha}, i\alpha\right) \\ &= i e^{\alpha\omega}\end{aligned}$$

We combine the results for positive and negative values of  $\omega$ .

$$\mathcal{F}\left[\frac{1}{x - i\alpha}\right] = \begin{cases} 0 & \text{for } \omega > 0, \\ i e^{\alpha\omega} & \text{for } \omega < 0 \end{cases}$$

### 32.3.2 Cauchy Principal Value and Integrals that are Not Absolutely Convergent.

That the integral of  $f(x)$  is absolutely convergent is a sufficient but not a necessary condition that the Fourier transform of  $f(x)$  exists. The integral  $\int_{-\infty}^{\infty} f(x) e^{-i\omega x} dx$  may converge even if  $\int_{-\infty}^{\infty} |f(x)| dx$  does not. Furthermore, if the Fourier transform integral diverges, its principal value may exist. We will say that the Fourier transform of  $f(x)$  exists if the principal value of the integral exists.

$$\mathcal{F}[f(x)] = \int_{-\infty}^{\infty} f(x) e^{-i\omega x} dx$$

**Example 32.3.3** Consider the Fourier transform of  $f(x) = 1/x$ .

$$\hat{f}(\omega) = \frac{1}{2\pi} \int_{-\infty}^{\infty} \frac{1}{x} e^{-i\omega x} dx$$

If  $\omega > 0$ , we can close the contour in the lower half-plane. The integral along the semi-circle vanishes due to Jordan's Lemma.

$$\lim_{R \rightarrow \infty} \int_{C_R} \frac{1}{x} e^{-i\omega x} dx = 0$$

We can evaluate the Fourier transform with the Residue Theorem.

$$\hat{f}(\omega) = \frac{1}{2\pi} \left( \frac{-1}{2} \right) (2\pi i) \operatorname{Res} \left( \frac{1}{x} e^{-\omega x}, 0 \right)$$

$$\hat{f}(\omega) = -\frac{i}{2}, \quad \text{for } \omega > 0.$$

The factor of  $-1/2$  in the above derivation arises because the path of integration is in the negative, (clockwise), direction and the path of integration crosses through the first order pole at  $x = 0$ . The path of integration is shown in Figure 32.2.

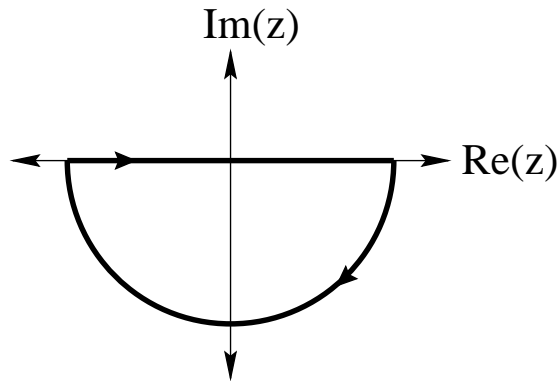

Figure 32.2: The Path of Integration

If  $\omega < 0$ , we can close the contour in the upper half plane to obtain

$$\hat{f}(\omega) = \frac{i}{2}, \quad \text{for } \omega < 0.$$

For  $\omega = 0$  the integral vanishes because  $\frac{1}{x}$  is an odd function.

$$\hat{f}(0) = \frac{1}{2\pi} = \int_{-\infty}^{\infty} \frac{1}{x} dx = 0$$

We collect the results in one formula.

$$\boxed{\hat{f}(\omega) = -\frac{i}{2} \operatorname{sign}(\omega)}$$

We write the integrand for  $\omega > 0$  as the sum of an odd and an even function.

$$\frac{1}{2\pi} \int_{-\infty}^{\infty} \frac{1}{x} e^{-i\omega x} dx = -\frac{i}{2}$$

$$\int_{-\infty}^{\infty} \frac{1}{x} \cos(\omega x) dx + \int_{-\infty}^{\infty} \frac{-i}{x} \sin(\omega x) dx = -i\pi$$

The principal value of the integral of any odd function is zero.

$$\int_{-\infty}^{\infty} \frac{1}{x} \sin(\omega x) dx = \pi$$

If the principal value of the integral of an even function exists, then the integral converges.

$$\int_{-\infty}^{\infty} \frac{1}{x} \sin(\omega x) dx = \pi$$

$$\boxed{\int_0^{\infty} \frac{1}{x} \sin(\omega x) dx = \frac{\pi}{2}}$$

Thus we have evaluated an integral that we used in deriving the Fourier transform.

### 32.3.3 Analytic Continuation

Consider the Fourier transform of  $f(x) = 1$ . The Fourier integral is not convergent, and its principal value does not exist. Thus we will have to be a little creative in order to define the Fourier transform. Define the two functions

$$f_+(x) = \begin{cases} 1 & \text{for } x > 0 \\ 1/2 & \text{for } x = 0 \\ 0 & \text{for } x < 0 \end{cases}, \quad f_-(x) = \begin{cases} 0 & \text{for } x > 0 \\ 1/2 & \text{for } x = 0 \\ 1 & \text{for } x < 0 \end{cases}.$$

Note that  $1 = f_-(x) + f_+(x)$ .

The Fourier transform of  $f_+(x)$  converges for  $\Im(\omega) < 0$ .

$$\begin{aligned}\mathcal{F}[f_+(x)] &= \frac{1}{2\pi} \int_0^{\infty} e^{-i\omega x} dx \\ &= \frac{1}{2\pi} \int_0^{\infty} e^{(-i\Re(\omega) + \Im(\omega))x} dx. \\ &= \frac{1}{2\pi} \left[ \frac{e^{-i\omega x}}{-i\omega} \right]_0^{\infty} \\ &= -\frac{i}{2\pi\omega} \quad \text{for } \Im(\omega) < 0\end{aligned}$$

Using analytic continuation, we can define the Fourier transform of  $f_+(x)$  for all  $\omega$  except the point  $\omega = 0$ .

$$\mathcal{F}[f_+(x)] = -\frac{i}{2\pi\omega}$$

We follow the same procedure for  $f_-(x)$ . The integral converges for  $\Im(\omega) > 0$ .

$$\begin{aligned}\mathcal{F}[f_-(x)] &= \frac{1}{2\pi} \int_{-\infty}^0 e^{-i\omega x} dx \\ &= \frac{1}{2\pi} \int_{-\infty}^0 e^{(-i\Re(\omega) + \Im(\omega))x} dx \\ &= \frac{1}{2\pi} \left[ \frac{e^{-i\omega x}}{-i\omega} \right]_{-\infty}^0 \\ &= \frac{i}{2\pi\omega}.\end{aligned}$$

Using analytic continuation we can define the transform for all nonzero  $\omega$ .

$$\mathcal{F}[f_-(x)] = \frac{i}{2\pi\omega}$$

Now we are prepared to define the Fourier transform of  $f(x) = 1$ .

$$\begin{aligned}\mathcal{F}[1] &= \mathcal{F}[f_-(x)] + \mathcal{F}[f_+(x)] \\ &= -\frac{i}{2\pi\omega} + \frac{i}{2\pi\omega} \\ &= 0, \quad \text{for } \omega \neq 0\end{aligned}$$

When  $\omega = 0$  the integral diverges. When we consider the closure relation for the Fourier transform we will see that

$$\boxed{\mathcal{F}[1] = \delta(\omega).}$$

## 32.4 Properties of the Fourier Transform

In this section we will explore various properties of the Fourier Transform. I would like to avoid stating assumptions on various functions at the beginning of each subsection. Unless otherwise indicated, assume that the integrals converge.

### 32.4.1 Closure Relation.

Recall the closure relation for an orthonormal set of functions  $\{\phi_1, \phi_2, \dots\}$ ,

$$\sum_{n=1}^{\infty} \phi_n(x) \overline{\phi_n(\xi)} \sim \delta(x - \xi).$$

There is a similar closure relation for Fourier integrals. We compute the Fourier transform of  $\delta(x - \xi)$ .

$$\begin{aligned}\mathcal{F}[\delta(x - \xi)] &= \frac{1}{2\pi} \int_{-\infty}^{\infty} \delta(x - \xi) e^{-i\omega x} dx \\ &= \frac{1}{2\pi} e^{-i\omega\xi}\end{aligned}$$



Next we take the inverse Fourier transform.

$$\delta(x - \xi) \sim \int_{-\infty}^{\infty} \frac{1}{2\pi} e^{-i\omega\xi} e^{i\omega x} d\omega$$

$$\delta(x - \xi) \sim \frac{1}{2\pi} \int_{-\infty}^{\infty} e^{i\omega(x-\xi)} d\omega.$$

Note that the integral is divergent, but it would be impossible to represent  $\delta(x - \xi)$  with a convergent integral.

### 32.4.2 Fourier Transform of a Derivative.

Consider the Fourier transform of  $y'(x)$ .

$$\begin{aligned} \mathcal{F}[y'(x)] &= \frac{1}{2\pi} \int_{-\infty}^{\infty} y'(x) e^{-i\omega x} dx \\ &= \left[ \frac{1}{2\pi} y(x) e^{-i\omega x} \right]_{-\infty}^{\infty} - \frac{1}{2\pi} \int_{-\infty}^{\infty} (-i\omega) y(x) e^{-i\omega x} dx \\ &= i\omega \frac{1}{2\pi} \int_{-\infty}^{\infty} y(x) e^{-i\omega x} dx \\ &= i\omega \mathcal{F}[y(x)] \end{aligned}$$

Next consider  $y''(x)$ .

$$\begin{aligned} \mathcal{F}[y''(x)] &= \mathcal{F} \left[ \frac{d}{dx} (y'(x)) \right] \\ &= i\omega \mathcal{F}[y'(x)] \\ &= (i\omega)^2 \mathcal{F}[y(x)] \\ &= -\omega^2 \mathcal{F}[y(x)] \end{aligned}$$

In general,

$$\mathcal{F}[y^{(n)}(x)] = (i\omega)^n \mathcal{F}[y(x)].$$

**Example 32.4.1** *The Dirac delta function can be expressed as the derivative of the Heaviside function.*

$$H(x - c) = \begin{cases} 0 & \text{for } x < c, \\ 1 & \text{for } x > c \end{cases}$$

*Thus we can express the Fourier transform of  $H(x - c)$  in terms of the Fourier transform of the delta function.*

$$\begin{aligned} \mathcal{F}[\delta(x - c)] &= i\omega \mathcal{F}[H(x - c)] \\ \frac{1}{2\pi} \int_{-\infty}^{\infty} \delta(x - c) e^{-i\omega x} dx &= i\omega \mathcal{F}[H(x - c)] \\ \frac{1}{2\pi} e^{-ic\omega} &= i\omega \mathcal{F}[H(x - c)] \end{aligned}$$

$$\boxed{\mathcal{F}[H(x - c)] = \frac{1}{2\pi i\omega} e^{-ic\omega}}$$

### 32.4.3 Fourier Convolution Theorem.

Consider the Fourier transform of a product of two functions.

$$\begin{aligned} \mathcal{F}[f(x)g(x)] &= \frac{1}{2\pi} \int_{-\infty}^{\infty} f(x)g(x) e^{-i\omega x} dx \\ &= \frac{1}{2\pi} \int_{-\infty}^{\infty} \left( \int_{-\infty}^{\infty} \hat{f}(\eta) e^{i\eta x} d\eta \right) g(x) e^{-i\omega x} dx \\ &= \frac{1}{2\pi} \int_{-\infty}^{\infty} \left( \int_{-\infty}^{\infty} \hat{f}(\eta)g(x) e^{i(\eta-\omega)x} dx \right) d\eta \\ &= \int_{-\infty}^{\infty} \hat{f}(\eta) \left( \frac{1}{2\pi} \int_{-\infty}^{\infty} g(x) e^{-i(\omega-\eta)x} dx \right) d\eta \\ &= \int_{-\infty}^{\infty} \hat{f}(\eta)G(\omega - \eta) d\eta \end{aligned}$$

The convolution of two functions is defined

$$f * g(x) = \int_{-\infty}^{\infty} f(\xi)g(x - \xi) d\xi.$$

Thus

$$\mathcal{F}[f(x)g(x)] = \hat{f} * \hat{g}(\omega) = \int_{-\infty}^{\infty} \hat{f}(\eta)\hat{g}(\omega - \eta) d\eta.$$

Now consider the inverse Fourier Transform of a product of two functions.

$$\begin{aligned} \mathcal{F}^{-1}[\hat{f}(\omega)\hat{g}(\omega)] &= \int_{-\infty}^{\infty} \hat{f}(\omega)\hat{g}(\omega) e^{i\omega x} d\omega \\ &= \int_{-\infty}^{\infty} \left( \frac{1}{2\pi} \int_{-\infty}^{\infty} f(\xi) e^{-i\omega\xi} d\xi \right) \hat{g}(\omega) e^{i\omega x} d\omega \\ &= \frac{1}{2\pi} \int_{-\infty}^{\infty} \left( \int_{-\infty}^{\infty} f(\xi)\hat{g}(\omega) e^{i\omega(x-\xi)} d\omega \right) d\xi \\ &= \frac{1}{2\pi} \int_{-\infty}^{\infty} f(\xi) \left( \int_{-\infty}^{\infty} \hat{g}(\omega) e^{i\omega(x-\xi)} d\omega \right) d\xi \\ &= \frac{1}{2\pi} \int_{-\infty}^{\infty} f(\xi)g(x - \xi) d\xi \end{aligned}$$

Thus

$$\mathcal{F}^{-1}[\hat{f}(\omega)\hat{g}(\omega)] = \frac{1}{2\pi} f * g(x) = \frac{1}{2\pi} \int_{-\infty}^{\infty} f(\xi)g(x - \xi) d\xi,$$

$$\mathcal{F}[f * g(x)] = 2\pi \hat{f}(\omega)\hat{g}(\omega).$$

These relations are known as the Fourier convolution theorem.

**Example 32.4.2** Using the convolution theorem and the table of Fourier transform pairs in the appendix, we can find the Fourier transform of

$$f(x) = \frac{1}{x^4 + 5x^2 + 4}.$$

We factor the fraction.

$$f(x) = \frac{1}{(x^2 + 1)(x^2 + 4)}$$

From the table, we know that

$$\mathcal{F}\left[\frac{2c}{x^2 + c^2}\right] = e^{-c|\omega|} \quad \text{for } c > 0.$$

We apply the convolution theorem.

$$\begin{aligned} \mathcal{F}[f(x)] &= \mathcal{F}\left[\frac{1}{8} \frac{2}{x^2 + 1} \frac{4}{x^2 + 4}\right] \\ &= \frac{1}{8} \left( \int_{-\infty}^{\infty} e^{-|\eta|} e^{-2|\omega - \eta|} d\eta \right) \\ &= \frac{1}{8} \left( \int_{-\infty}^0 e^{\eta} e^{-2|\omega - \eta|} d\eta + \int_0^{\infty} e^{-\eta} e^{-2|\omega - \eta|} d\eta \right) \end{aligned}$$

First consider the case  $\omega > 0$ .

$$\begin{aligned} \mathcal{F}[f(x)] &= \frac{1}{8} \left( \int_{-\infty}^0 e^{-2\omega + 3\eta} d\eta + \int_0^{\omega} e^{-2\omega + \eta} d\eta + \int_{\omega}^{\infty} e^{2\omega - 3\eta} d\eta \right) \\ &= \frac{1}{8} \left( \frac{1}{3} e^{-2\omega} + e^{-\omega} - e^{-2\omega} + \frac{1}{3} e^{-\omega} \right) \\ &= \frac{1}{6} e^{-\omega} - \frac{1}{12} e^{-2\omega} \end{aligned}$$

Now consider the case  $\omega < 0$ .

$$\begin{aligned}\mathcal{F}[f(x)] &= \frac{1}{8} \left( \int_{-\infty}^{\omega} e^{-2\omega+3\eta} d\eta + \int_{\omega}^0 e^{2\omega-\eta} d\eta + \int_0^{\infty} e^{2\omega-3\eta} d\eta \right) \\ &= \frac{1}{8} \left( \frac{1}{3} e^{\omega} - e^{2\omega} + e^{\omega} + \frac{1}{3} e^{2\omega} \right) \\ &= \frac{1}{6} e^{\omega} - \frac{1}{12} e^{2\omega}\end{aligned}$$

We collect the result for positive and negative  $\omega$ .

$$\mathcal{F}[f(x)] = \frac{1}{6} e^{-|\omega|} - \frac{1}{12} e^{-2|\omega|}$$

A better way to find the Fourier transform of

$$f(x) = \frac{1}{x^4 + 5x^2 + 4}$$

is to first expand the function in partial fractions.

$$f(x) = \frac{1/3}{x^2 + 1} - \frac{1/3}{x^2 + 4}$$

$$\begin{aligned}\mathcal{F}[f(x)] &= \frac{1}{6} \mathcal{F} \left[ \frac{2}{x^2 + 1} \right] - \frac{1}{12} \mathcal{F} \left[ \frac{4}{x^2 + 4} \right] \\ &= \frac{1}{6} e^{-|\omega|} - \frac{1}{12} e^{-2|\omega|}\end{aligned}$$

### 32.4.4 Parseval's Theorem.

Recall Parseval's theorem for Fourier series. If  $f(x)$  is a complex valued function with the Fourier series  $\sum_{n=-\infty}^{\infty} c_n e^{inx}$  then

$$2\pi \sum_{n=-\infty}^{\infty} |c_n|^2 = \int_{-\pi}^{\pi} |f(x)|^2 dx.$$

Analogous to this result is Parseval's theorem for Fourier transforms.

Let  $f(x)$  be a complex valued function that is both absolutely integrable and square integrable.

$$\int_{-\infty}^{\infty} |f(x)| dx < \infty \quad \text{and} \quad \int_{-\infty}^{\infty} |f(x)|^2 dx < \infty$$

The Fourier transform of  $\overline{f(-x)}$  is  $\widehat{f(\omega)}$ .

$$\begin{aligned} \mathcal{F} \left[ \overline{f(-x)} \right] &= \frac{1}{2\pi} \int_{-\infty}^{\infty} \overline{f(-x)} e^{-i\omega x} dx \\ &= -\frac{1}{2\pi} \int_{\infty}^{-\infty} \overline{f(x)} e^{i\omega x} dx \\ &= \frac{1}{2\pi} \int_{-\infty}^{\infty} \overline{f(x)} e^{-i\omega x} dx \\ &= \widehat{f(\omega)} \end{aligned}$$

We apply the convolution theorem.

$$\begin{aligned} \mathcal{F}^{-1} [2\pi \widehat{f(\omega)} \overline{\widehat{f(\omega)}}] &= \int_{-\infty}^{\infty} f(\xi) \overline{f(-(x-\xi))} d\xi \\ \int_{-\infty}^{\infty} 2\pi \widehat{f(\omega)} \overline{\widehat{f(\omega)}} e^{i\omega x} d\omega &= \int_{-\infty}^{\infty} f(\xi) \overline{f(\xi-x)} d\xi \end{aligned}$$

We set  $x = 0$ .

$$2\pi \int_{-\infty}^{\infty} \widehat{f(\omega)} \overline{\widehat{f(\omega)}} d\omega = \int_{-\infty}^{\infty} f(\xi) \overline{f(\xi)} d\xi$$

$$\boxed{2\pi \int_{-\infty}^{\infty} |\widehat{f(\omega)}|^2 d\omega = \int_{-\infty}^{\infty} |f(x)|^2 dx}$$

This is known as **Parseval's theorem**.

### 32.4.5 Shift Property.

The Fourier transform of  $f(x + c)$  is

$$\begin{aligned}\mathcal{F}[f(x + c)] &= \frac{1}{2\pi} \int_{-\infty}^{\infty} f(x + c) e^{-i\omega x} dx \\ &= \frac{1}{2\pi} \int_{-\infty}^{\infty} f(x) e^{-i\omega(x-c)} dx\end{aligned}$$

$$\boxed{\mathcal{F}[f(x + c)] = e^{i\omega c} \hat{f}(\omega)}$$

The inverse Fourier transform of  $\hat{f}(\omega + c)$  is

$$\begin{aligned}\mathcal{F}^{-1}[\hat{f}(\omega + c)] &= \int_{-\infty}^{\infty} \hat{f}(\omega + c) e^{i\omega x} d\omega \\ &= \int_{-\infty}^{\infty} \hat{f}(\omega) e^{i(\omega-c)x} d\omega\end{aligned}$$

$$\boxed{\mathcal{F}^{-1}[\hat{f}(\omega + c)] = e^{-icx} f(x)}$$

### 32.4.6 Fourier Transform of $x f(x)$ .

The Fourier transform of  $x f(x)$  is

$$\begin{aligned}\mathcal{F}[x f(x)] &= \frac{1}{2\pi} \int_{-\infty}^{\infty} x f(x) e^{-i\omega x} dx \\ &= \frac{1}{2\pi} \int_{-\infty}^{\infty} i f(x) \frac{\partial}{\partial \omega} (e^{-i\omega x}) dx \\ &= i \frac{\partial}{\partial \omega} \left( \frac{1}{2\pi} \int_{-\infty}^{\infty} f(x) e^{-i\omega x} dx \right)\end{aligned}$$

$$\mathcal{F}[xf(x)] = i \frac{\partial \hat{f}}{\partial \omega}.$$

Similarly, you can show that

$$\mathcal{F}[x^n f(x)] = (i)^n \frac{\partial^n \hat{f}}{\partial \omega^n}.$$

## 32.5 Solving Differential Equations with the Fourier Transform

The Fourier transform is useful in solving some differential equations on the domain  $(-\infty \dots \infty)$  with homogeneous boundary conditions at infinity. We take the Fourier transform of the differential equation  $L[y] = f$  and solve for  $\hat{y}$ . We take the inverse transform to determine the solution  $y$ . Note that this process is only applicable if the Fourier transform of  $y$  exists. Hence the requirement for homogeneous boundary conditions at infinity.

We will use the table of Fourier transforms in the appendix in solving the examples in this section.

**Example 32.5.1** Consider the problem

$$y'' - y = e^{-\alpha|x|}, \quad y(\pm\infty) = 0, \quad \alpha > 0, \alpha \neq 1.$$

We take the Fourier transform of this equation.

$$-\omega^2 \hat{y}(\omega) - \hat{y}(\omega) = \frac{\alpha/\pi}{\omega^2 + \alpha^2}$$

We take the inverse Fourier transform to determine the solution.

$$\begin{aligned} \hat{y}(\omega) &= \frac{-\alpha/\pi}{(\omega^2 + \alpha^2)(\omega^2 + 1)} \\ &= \frac{-\alpha}{\pi} \frac{1}{\alpha^2 - 1} \left( \frac{1}{\omega^2 + 1} - \frac{1}{\omega^2 + \alpha^2} \right) \\ &= \frac{1}{\alpha^2 - 1} \left( \frac{\alpha/\pi}{\omega^2 + \alpha^2} - \alpha \frac{1/\pi}{\omega^2 + 1} \right) \end{aligned}$$



$$y(x) = \frac{e^{-\alpha|x|} - \alpha e^{-|x|}}{\alpha^2 - 1}$$

**Example 32.5.2** Consider the Green function problem

$$G'' - G = \delta(x - \xi), \quad y(\pm\infty) = 0.$$

We take the Fourier transform of this equation.

$$-\omega^2 \hat{G} - \hat{G} = \mathcal{F}[\delta(x - \xi)]$$

$$\hat{G} = -\frac{1}{\omega^2 + 1} \mathcal{F}[\delta(x - \xi)]$$

We use the Table of Fourier transforms.

$$\hat{G} = -\pi \mathcal{F}[e^{-|x|}] \mathcal{F}[\delta(x - \xi)]$$

We use the convolution theorem to do the inversion.

$$G = -\pi \frac{1}{2\pi} \int_{-\infty}^{\infty} e^{-|x-\eta|} \delta(\eta - \xi) d\eta$$

$$G(x|\xi) = -\frac{1}{2} e^{-|x-\xi|}$$

The inhomogeneous differential equation

$$y'' - y = f(x), \quad y(\pm\infty) = 0,$$

has the solution

$$y = -\frac{1}{2} \int_{-\infty}^{\infty} f(\xi) e^{-|x-\xi|} d\xi.$$

When solving the differential equation  $L[y] = f$  with the Fourier transform, it is quite common to use the convolution theorem. With this approach we have no need to compute the Fourier transform of the right side. We merely *denote* it as  $\mathcal{F}[f]$  until we use  $f$  in the convolution integral.

## 32.6 The Fourier Cosine and Sine Transform

### 32.6.1 The Fourier Cosine Transform

Suppose  $f(x)$  is an even function. In this case the Fourier transform of  $f(x)$  coincides with the *Fourier cosine transform* of  $f(x)$ .

$$\begin{aligned}\mathcal{F}[f(x)] &= \frac{1}{2\pi} \int_{-\infty}^{\infty} f(x) e^{-i\omega x} dx \\ &= \frac{1}{2\pi} \int_{-\infty}^{\infty} f(x)(\cos(\omega x) - i \sin(\omega x)) dx \\ &= \frac{1}{2\pi} \int_{-\infty}^{\infty} f(x) \cos(\omega x) dx \\ &= \frac{1}{\pi} \int_0^{\infty} f(x) \cos(\omega x) dx\end{aligned}$$

The Fourier cosine transform is defined:

$$\mathcal{F}_c[f(x)] = \hat{f}_c(\omega) = \frac{1}{\pi} \int_0^{\infty} f(x) \cos(\omega x) dx.$$

Note that  $\hat{f}_c(\omega)$  is an even function. The inverse Fourier cosine transform is

$$\begin{aligned}\mathcal{F}_c^{-1}[\hat{f}_c(\omega)] &= \int_{-\infty}^{\infty} \hat{f}_c(\omega) e^{i\omega x} d\omega \\ &= \int_{-\infty}^{\infty} \hat{f}_c(\omega)(\cos(\omega x) + i \sin(\omega x)) d\omega \\ &= \int_{-\infty}^{\infty} \hat{f}_c(\omega) \cos(\omega x) d\omega \\ &= 2 \int_0^{\infty} \hat{f}_c(\omega) \cos(\omega x) d\omega.\end{aligned}$$

Thus we have the Fourier cosine transform pair

$$f(x) = \mathcal{F}_c^{-1}[\hat{f}_c(\omega)] = 2 \int_0^{\infty} \hat{f}_c(\omega) \cos(\omega x) \, d\omega, \quad \hat{f}_c(\omega) = \mathcal{F}_c[f(x)] = \frac{1}{\pi} \int_0^{\infty} f(x) \cos(\omega x) \, dx.$$

### 32.6.2 The Fourier Sine Transform

Suppose  $f(x)$  is an odd function. In this case the Fourier transform of  $f(x)$  coincides with the *Fourier sine transform* of  $f(x)$ .

$$\begin{aligned} \mathcal{F}[f(x)] &= \frac{1}{2\pi} \int_{-\infty}^{\infty} f(x) e^{-i\omega x} \, dx \\ &= \frac{1}{2\pi} \int_{-\infty}^{\infty} f(x) (\cos(\omega x) - i \sin(\omega x)) \, dx \\ &= -\frac{i}{\pi} \int_0^{\infty} f(x) \sin(\omega x) \, dx \end{aligned}$$

Note that  $\hat{f}(\omega) = \mathcal{F}[f(x)]$  is an odd function of  $\omega$ . The inverse Fourier transform of  $\hat{f}(\omega)$  is

$$\begin{aligned} \mathcal{F}^{-1}[\hat{f}(\omega)] &= \int_{-\infty}^{\infty} \hat{f}(\omega) e^{i\omega x} \, d\omega \\ &= 2i \int_0^{\infty} \hat{f}(\omega) \sin(\omega x) \, d\omega. \end{aligned}$$

Thus we have that

$$\begin{aligned} f(x) &= 2i \int_0^{\infty} \left( -\frac{i}{\pi} \int_0^{\infty} f(x) \sin(\omega x) \, dx \right) \sin(\omega x) \, d\omega \\ &= 2 \int_0^{\infty} \left( \frac{1}{\pi} \int_0^{\infty} f(x) \sin(\omega x) \, dx \right) \sin(\omega x) \, d\omega. \end{aligned}$$

This gives us the Fourier sine transform pair

$$f(x) = \mathcal{F}_s^{-1}[\hat{f}_s(\omega)] = 2 \int_0^{\infty} \hat{f}_s(\omega) \sin(\omega x) d\omega, \quad \hat{f}_s(\omega) = \mathcal{F}_s[f(x)] = \frac{1}{\pi} \int_0^{\infty} f(x) \sin(\omega x) dx.$$

**Result 32.6.1** The Fourier cosine transform pair is defined:

$$f(x) = \mathcal{F}_c^{-1}[\hat{f}_c(\omega)] = 2 \int_0^{\infty} \hat{f}_c(\omega) \cos(\omega x) d\omega$$
$$\hat{f}_c(\omega) = \mathcal{F}_c[f(x)] = \frac{1}{\pi} \int_0^{\infty} f(x) \cos(\omega x) dx$$

The Fourier sine transform pair is defined:

$$f(x) = \mathcal{F}_s^{-1}[\hat{f}_s(\omega)] = 2 \int_0^{\infty} \hat{f}_s(\omega) \sin(\omega x) d\omega$$
$$\hat{f}_s(\omega) = \mathcal{F}_s[f(x)] = \frac{1}{\pi} \int_0^{\infty} f(x) \sin(\omega x) dx$$

## 32.7 Properties of the Fourier Cosine and Sine Transform

### 32.7.1 Transforms of Derivatives

**Cosine Transform.** Using integration by parts we can find the Fourier cosine transform of derivatives. Let  $y$  be a function for which the Fourier cosine transform of  $y$  and its first and second derivatives exists. Further assume that  $y$

and  $y'$  vanish at infinity. We calculate the transforms of the first and second derivatives.

$$\begin{aligned}
 \mathcal{F}_c[y'] &= \frac{1}{\pi} \int_0^{\infty} y' \cos(\omega x) \, dx \\
 &= \frac{1}{\pi} [y \cos(\omega x)]_0^{\infty} + \frac{\omega}{\pi} \int_0^{\infty} y \sin(\omega x) \, dx \\
 &= \omega \hat{y}_c(\omega) - \frac{1}{\pi} y(0) \\
 \mathcal{F}_c[y''] &= \frac{1}{\pi} \int_0^{\infty} y'' \cos(\omega x) \, dx \\
 &= \frac{1}{\pi} [y' \cos(\omega x)]_0^{\infty} + \frac{\omega}{\pi} \int_0^{\infty} y' \sin(\omega x) \, dx \\
 &= -\frac{1}{\pi} y'(0) + \frac{\omega}{\pi} [y \sin(\omega x)]_0^{\infty} - \frac{\omega^2}{\pi} \int_0^{\infty} y \cos(\omega x) \, dx \\
 &= -\omega^2 \hat{f}_c(\omega) - \frac{1}{\pi} y'(0)
 \end{aligned}$$

**Sine Transform.** You can show, (see Exercise 32.3), that the Fourier sine transform of the first and second derivatives are

$$\begin{aligned}
 \mathcal{F}_s[y'] &= -\omega \hat{f}_c(\omega) \\
 \mathcal{F}_s[y''] &= -\omega^2 \hat{y}_c(\omega) + \frac{\omega}{\pi} y(0).
 \end{aligned}$$

## 32.7.2 Convolution Theorems

**Cosine Transform of a Product.** Consider the Fourier cosine transform of a product of functions. Let  $f(x)$  and  $g(x)$  be two functions defined for  $x \geq 0$ . Let  $\mathcal{F}_c[f(x)] = \hat{f}_c(\omega)$ , and  $\mathcal{F}_c[g(x)] = \hat{g}_c(\omega)$ .

$$\begin{aligned}\mathcal{F}_c[f(x)g(x)] &= \frac{1}{\pi} \int_0^{\infty} f(x)g(x) \cos(\omega x) \, dx \\ &= \frac{1}{\pi} \int_0^{\infty} \left( 2 \int_0^{\infty} \hat{f}_c(\eta) \cos(\eta x) \, d\eta \right) g(x) \cos(\omega x) \, dx \\ &= \frac{2}{\pi} \int_0^{\infty} \int_0^{\infty} \hat{f}_c(\eta) g(x) \cos(\eta x) \cos(\omega x) \, dx \, d\eta\end{aligned}$$

We use the identity  $\cos a \cos b = \frac{1}{2}(\cos(a - b) + \cos(a + b))$ .

$$\begin{aligned}&= \frac{1}{\pi} \int_0^{\infty} \int_0^{\infty} \hat{f}_c(\eta) g(x) (\cos((\omega - \eta)x) + \cos((\omega + \eta)x)) \, dx \, d\eta \\ &= \int_0^{\infty} \hat{f}_c(\eta) \left[ \frac{1}{\pi} \int_0^{\infty} g(x) \cos((\omega - \eta)x) \, dx + \frac{1}{\pi} \int_0^{\infty} g(x) \cos((\omega + \eta)x) \, dx \right] \, d\eta \\ &= \int_0^{\infty} \hat{f}_c(\eta) (\hat{g}_c(\omega - \eta) + \hat{g}_c(\omega + \eta)) \, d\eta\end{aligned}$$

$\hat{g}_c(\omega)$  is an even function. If we have only defined  $\hat{g}_c(\omega)$  for positive argument, then  $\hat{g}_c(\omega) = \hat{g}_c(|\omega|)$ .

$$= \int_0^{\infty} \hat{f}_c(\eta) (\hat{g}_c(|\omega - \eta|) + \hat{g}_c(\omega + \eta)) \, d\eta$$

**Inverse Cosine Transform of a Product.** Now consider the inverse Fourier cosine transform of a product of functions. Let  $\mathcal{F}_c[f(x)] = \hat{f}_c(\omega)$ , and  $\mathcal{F}_c[g(x)] = \hat{g}_c(\omega)$ .

$$\begin{aligned}
 \mathcal{F}_c^{-1}[\hat{f}_c(\omega)\hat{g}_c(\omega)] &= 2 \int_0^\infty \hat{f}_c(\omega)\hat{g}_c(\omega) \cos(\omega x) \, d\omega \\
 &= 2 \int_0^\infty \left( \frac{1}{\pi} \int_0^\infty f(\xi) \cos(\omega\xi) \, d\xi \right) \hat{g}_c(\omega) \cos(\omega x) \, d\omega \\
 &= \frac{2}{\pi} \int_0^\infty \int_0^\infty f(\xi)\hat{g}_c(\omega) \cos(\omega\xi) \cos(\omega x) \, d\omega \, d\xi \\
 &= \frac{1}{\pi} \int_0^\infty \int_0^\infty f(\xi)\hat{g}_c(\omega) (\cos(\omega(x-\xi)) + \cos(\omega(x+\xi))) \, d\omega \, d\xi \\
 &= \frac{1}{2\pi} \int_0^\infty f(\xi) \left( 2 \int_0^\infty \hat{g}_c(\omega) \cos(\omega(x-\xi)) \, d\omega + 2 \int_0^\infty \hat{g}_c(\omega) \cos(\omega(x+\xi)) \, d\omega \right) \, d\xi \\
 &= \frac{1}{2\pi} \int_0^\infty f(\xi) (g(|x-\xi|) + g(x+\xi)) \, d\xi
 \end{aligned}$$

**Sine Transform of a Product.** You can show, (see Exercise 32.5), that the Fourier sine transform of a product of functions is

$$\mathcal{F}_s[f(x)g(x)] = \int_0^\infty \hat{f}_s(\eta) (\hat{g}_c(|\omega-\eta|) - \hat{g}_c(\omega+\eta)) \, d\eta.$$

**Inverse Sine Transform of a Product.** You can also show, (see Exercise 32.6), that the inverse Fourier sine transform of a product of functions is

$$\mathcal{F}_s^{-1}[\hat{f}_s(\omega)\hat{g}_c(\omega)] = \frac{1}{2\pi} \int_0^\infty f(\xi) (g(|x-\xi|) - g(x+\xi)) \, d\xi.$$

**Result 32.7.1** The Fourier cosine and sine transform convolution theorems are

$$\begin{aligned}\mathcal{F}_c[f(x)g(x)] &= \int_0^\infty \hat{f}_c(\eta) [\hat{g}_c(|\omega - \eta|) + \hat{g}_c(\omega + \eta)] d\eta \\ \mathcal{F}_c^{-1}[\hat{f}_c(\omega)\hat{g}_c(\omega)] &= \frac{1}{2\pi} \int_0^\infty f(\xi) (g(|x - \xi|) + g(x + \xi)) d\xi \\ \mathcal{F}_s[f(x)g(x)] &= \int_0^\infty \hat{f}_s(\eta) (\hat{g}_s(|\omega - \eta|) - \hat{g}_s(\omega + \eta)) d\eta \\ \mathcal{F}_s^{-1}[\hat{f}_s(\omega)\hat{g}_s(\omega)] &= \frac{1}{2\pi} \int_0^\infty f(\xi) (g(|x - \xi|) - g(x + \xi)) d\xi\end{aligned}$$

### 32.7.3 Cosine and Sine Transform in Terms of the Fourier Transform

We can express the Fourier cosine and sine transform in terms of the Fourier transform. First consider the Fourier cosine transform. Let  $f(x)$  be an even function.

$$\mathcal{F}_c[f(x)] = \frac{1}{\pi} \int_0^\infty f(x) \cos(\omega x) dx$$

We extend the domain integration because the integrand is even.

$$= \frac{1}{2\pi} \int_{-\infty}^\infty f(x) \cos(\omega x) dx$$

Note that  $\int_{-\infty}^\infty f(x) \sin(\omega x) dx = 0$  because the integrand is odd.

$$\begin{aligned}&= \frac{1}{2\pi} \int_{-\infty}^\infty f(x) e^{-i\omega x} dx \\ &= \mathcal{F}[f(x)]\end{aligned}$$



$$\mathcal{F}_c[f(x)] = \mathcal{F}[f(x)], \quad \text{for even } f(x).$$

For general  $f(x)$ , use the even extension,  $f(|x|)$  to write the result.

$$\mathcal{F}_c[f(x)] = \mathcal{F}[f(|x|)]$$

There is an analogous result for the inverse Fourier cosine transform.

$$\mathcal{F}_c^{-1}[\hat{f}(\omega)] = \mathcal{F}^{-1}[\hat{f}(|\omega|)]$$

For the sine series, we have

$$\mathcal{F}_s[f(x)] = \imath \mathcal{F}[\text{sign}(x)f(|x|)] \quad \mathcal{F}_s^{-1}[\hat{f}(\omega)] = -\imath \mathcal{F}^{-1}[\text{sign}(\omega)\hat{f}(|\omega|)]$$

**Result 32.7.2** The results:

$$\mathcal{F}_c[f(x)] = \mathcal{F}[f(|x|)] \quad \mathcal{F}_c^{-1}[\hat{f}(\omega)] = \mathcal{F}^{-1}[\hat{f}(|\omega|)]$$

$$\mathcal{F}_s[f(x)] = \imath \mathcal{F}[\text{sign}(x)f(|x|)] \quad \mathcal{F}_s^{-1}[\hat{f}(\omega)] = -\imath \mathcal{F}^{-1}[\text{sign}(\omega)\hat{f}(|\omega|)]$$

allow us to evaluate Fourier cosine and sine transforms in terms of the Fourier transform. This enables us to use contour integration methods to do the integrals.

## 32.8 Solving Differential Equations with the Fourier Cosine and Sine Transforms

**Example 32.8.1** Consider the problem

$$y'' - y = 0, \quad y(0) = 1, \quad y(\infty) = 0.$$

Since the initial condition is  $y(0) = 1$  and the sine transform of  $y''$  is  $-\omega^2 \hat{y}_c(\omega) + \frac{\omega}{\pi} y(0)$  we take the Fourier sine transform of both sides of the differential equation.

$$\begin{aligned} -\omega^2 \hat{y}_c(\omega) + \frac{\omega}{\pi} y(0) - \hat{y}_c(\omega) &= 0 \\ -(\omega^2 + 1) \hat{y}_c(\omega) &= -\frac{\omega}{\pi} \\ \hat{y}_c(\omega) &= \frac{\omega}{\pi(\omega^2 + 1)} \end{aligned}$$

We use the table of Fourier Sine transforms.

$$\boxed{y = e^{-x}}$$

**Example 32.8.2** Consider the problem

$$y'' - y = e^{-2x}, \quad y'(0) = 0, \quad y(\infty) = 0.$$

Since the initial condition is  $y'(0) = 0$ , we take the Fourier cosine transform of the differential equation. From the table of cosine transforms,  $\mathcal{F}_c[e^{-2x}] = 2/(\pi(\omega^2 + 4))$ .

$$-\omega^2 \hat{y}_c(\omega) - \frac{1}{\pi} y'(0) - \hat{y}_c(\omega) = \frac{2}{\pi(\omega^2 + 4)}$$

$$\begin{aligned} \hat{y}_c(\omega) &= -\frac{2}{\pi(\omega^2 + 4)(\omega^2 + 1)} \\ &= \frac{-2}{\pi} \left( \frac{1/3}{\omega^2 + 1} - \frac{1/3}{\omega^2 + 4} \right) \\ &= \frac{1}{3} \frac{2/\pi}{\omega^2 + 4} - \frac{2}{3} \frac{1/\pi}{\omega^2 + 1} \end{aligned}$$

$$\boxed{y = \frac{1}{3} e^{-2x} - \frac{2}{3} e^{-x}}$$

## 32.9 Exercises

### Exercise 32.1

Show that

$$H(x + c) - H(x - c) = \frac{\sin(c\omega)}{\pi\omega}.$$

Hint, Solution

### Exercise 32.2

Using contour integration, find the Fourier transform of

$$f(x) = \frac{1}{x^2 + c^2},$$

where  $\Re(c) \neq 0$

Hint, Solution

### Exercise 32.3

Find the Fourier sine transforms of  $y'(x)$  and  $y''(x)$ .

Hint, Solution

### Exercise 32.4

Prove the following identities.

$$1. \mathcal{F}[f(x - a)] = e^{-i\omega a} \hat{f}(\omega)$$

$$2. \mathcal{F}[f(ax)] = \frac{1}{|a|} \hat{f}\left(\frac{\omega}{a}\right)$$

Hint, Solution

### Exercise 32.5

Show that

$$\mathcal{F}_s[f(x)g(x)] = \int_0^\infty \hat{f}_s(\eta)(\hat{g}_c(|\omega - \eta|) - \hat{g}_c(\omega + \eta)) d\eta.$$

Hint, Solution

### Exercise 32.6

Show that

$$\mathcal{F}_s^{-1}[\hat{f}_s(\omega)\hat{g}_c(\omega)] = \frac{1}{2\pi} \int_0^\infty f(\xi)(g(|x-\xi|) - g(x+\xi)) d\xi.$$

Hint, Solution

### Exercise 32.7

Let  $\hat{f}_c(\omega) = \mathcal{F}_c[f(x)]$ ,  $\hat{f}_s(\omega) = \mathcal{F}_s[f(x)]$ , and assume the cosine and sine transforms of  $xf(x)$  exist. Express  $\mathcal{F}_c[xf(x)]$  and  $\mathcal{F}_s[xf(x)]$  in terms of  $\hat{f}_c(\omega)$  and  $\hat{f}_s(\omega)$ .

Hint, Solution

### Exercise 32.8

Solve the problem

$$y'' - y = e^{-2x}, \quad y(0) = 1, \quad y(\infty) = 0,$$

using the Fourier sine transform.

Hint, Solution

### Exercise 32.9

Prove the following relations between the Fourier sine transform and the Fourier transform.

$$\begin{aligned}\mathcal{F}_s[f(x)] &= \imath \mathcal{F}[\text{sign}(x)f(|x|)] \\ \mathcal{F}_s^{-1}[\hat{f}(\omega)] &= -\imath \mathcal{F}^{-1}[\text{sign}(\omega)\hat{f}(|\omega|)]\end{aligned}$$

Hint, Solution

### Exercise 32.10

Let  $\hat{f}_c(\omega) = \mathcal{F}_c[f(x)]$  and  $\hat{f}_s(\omega) = \mathcal{F}_s[f(x)]$ . Show that

- $\mathcal{F}_c[xf(x)] = \frac{\partial}{\partial \omega} \hat{f}_c(\omega)$

$$2. \mathcal{F}_s[xf(x)] = -\frac{\partial}{\partial \omega} \hat{f}_c(\omega)$$

$$3. \mathcal{F}_c[f(cx)] = \frac{1}{c} \hat{f}_c\left(\frac{\omega}{c}\right) \text{ for } c > 0$$

$$4. \mathcal{F}_s[f(cx)] = \frac{1}{c} \hat{f}_c\left(\frac{\omega}{c}\right) \text{ for } c > 0.$$

Hint, Solution

### Exercise 32.11

Solve the integral equation,

$$\int_{-\infty}^{\infty} u(\xi) e^{-a(x-\xi)^2} d\xi = e^{-bx^2},$$

where  $a, b > 0$ ,  $a \neq b$ , with the Fourier transform.

Hint, Solution

### Exercise 32.12

Evaluate

$$\frac{1}{\pi} \int_0^{\infty} \frac{1}{x} e^{-cx} \sin(\omega x) dx,$$

where  $\omega$  is a positive, real number and  $\Re(c) > 0$ .

Hint, Solution

### Exercise 32.13

Use the Fourier transform to solve the equation

$$y'' - a^2 y = e^{-a|x|}$$

on the domain  $-\infty < x < \infty$  with boundary conditions  $y(\pm\infty) = 0$ .

Hint, Solution

### Exercise 32.14

1. Use the cosine transform to solve

$$y'' - a^2y = 0 \text{ on } x \geq 0 \text{ with } y'(0) = b, y(\infty) = 0.$$

2. Use the cosine transform to show that the Green function for the above with  $b = 0$  is

$$G(x, \xi) = -\frac{1}{2a} e^{-a|x-\xi|} - \frac{1}{2a} e^{-a(x-\xi)}.$$

Hint, Solution

### Exercise 32.15

1. Use the sine transform to solve

$$y'' - a^2y = 0 \text{ on } x \geq 0 \text{ with } y(0) = b, y(\infty) = 0.$$

2. Try using the Laplace transform on this problem. Why isn't it as convenient as the Fourier transform?
3. Use the sine transform to show that the Green function for the above with  $b = 0$  is

$$g(x; \xi) = \frac{1}{2a} (e^{-a(x-\xi)} - e^{-a|x+\xi|})$$

Hint, Solution

### Exercise 32.16

1. Find the Green function which solves the equation

$$y'' + 2\mu y' + (\beta^2 + \mu^2)y = \delta(x - \xi), \quad \mu > 0, \beta > 0,$$

in the range  $-\infty < x < \infty$  with boundary conditions  $y(-\infty) = y(\infty) = 0$ .

2. Use this Green's function to show that the solution of

$$y'' + 2\mu y' + (\beta^2 + \mu^2)y = g(x), \quad \mu > 0, \beta > 0, \quad y(-\infty) = y(\infty) = 0,$$

with  $g(\pm\infty) = 0$  in the limit as  $\mu \rightarrow 0$  is

$$y = \frac{1}{\beta} \int_{-\infty}^x g(\xi) \sin[\beta(x - \xi)] d\xi.$$

You may assume that the interchange of limits is permitted.

**Hint, Solution**

### Exercise 32.17

Using Fourier transforms, find the solution  $u(x)$  to the integral equation

$$\int_{-\infty}^{\infty} \frac{u(\xi)}{[(x - \xi)^2 + a^2]} d\xi = \frac{1}{x^2 + b^2} \quad 0 < a < b.$$

**Hint, Solution**

### Exercise 32.18

The Fourier cosine transform is defined by

$$\hat{f}_c(\omega) = \frac{1}{\pi} \int_0^{\infty} f(x) \cos(\omega x) dx.$$

1. From the Fourier theorem show that the inverse cosine transform is given by

$$f(x) = 2 \int_0^{\infty} \hat{f}_c(\omega) \cos(\omega x) d\omega.$$

2. Show that the cosine transform of  $f''(x)$  is

$$-\omega^2 \hat{f}_c(\omega) - \frac{f'(0)}{\pi}.$$

3. Use the cosine transform to solve the following boundary value problem.

$$y'' - a^2y = 0 \quad \text{on } x > 0 \quad \text{with } y'(0) = b, \quad y(\infty) = 0$$

Hint, Solution

### Exercise 32.19

The Fourier sine transform is defined by

$$\hat{f}_s(\omega) = \frac{1}{\pi} \int_0^{\infty} f(x) \sin(\omega x) \, dx.$$

1. Show that the inverse sine transform is given by

$$f(x) = 2 \int_0^{\infty} \hat{f}_s(\omega) \sin(\omega x) \, d\omega.$$

2. Show that the sine transform of  $f''(x)$  is

$$\frac{\omega}{\pi} f(0) - \omega^2 \hat{f}_s(\omega).$$

3. Use this property to solve the equation

$$y'' - a^2y = 0 \quad \text{on } x > 0 \quad \text{with } y(0) = b, \quad y(\infty) = 0.$$

4. Try using the Laplace transform on this problem. Why isn't it as convenient as the Fourier transform?

Hint, Solution

### Exercise 32.20

Show that

$$\mathcal{F}[f(x)] = \frac{1}{2} (\mathcal{F}_c[f(x) + f(-x)] - i\mathcal{F}_s[f(x) - f(-x)])$$

where  $\mathcal{F}$ ,  $\mathcal{F}_c$  and  $\mathcal{F}_s$  are respectively the Fourier transform, Fourier cosine transform and Fourier sine transform.

Hint, Solution



**Exercise 32.21**

Find  $u(x)$  as the solution to the integral equation:

$$\int_{-\infty}^{\infty} \frac{u(\xi)}{(x - \xi)^2 + a^2} d\xi = \frac{1}{x^2 + b^2}, \quad 0 < a < b.$$

Use Fourier transforms and the inverse transform. Justify the choice of any contours used in the complex plane.

**Hint, Solution**

## 32.10 Hints

### Hint 32.1

$$H(x+c) - H(x-c) = \begin{cases} 1 & \text{for } |x| < c, \\ 0 & \text{for } |x| > c \end{cases}$$

### Hint 32.2

Consider the two cases  $\Re(\omega) < 0$  and  $\Re(\omega) > 0$ , closing the path of integration with a semi-circle in the lower or upper half plane.

### Hint 32.3

### Hint 32.4

### Hint 32.5

### Hint 32.6

### Hint 32.7

### Hint 32.8

### Hint 32.9

**Hint 32.10**

**Hint 32.11**

The left side is the convolution of  $u(x)$  and  $e^{-ax^2}$ .

**Hint 32.12**

**Hint 32.13**

**Hint 32.14**

**Hint 32.15**

**Hint 32.16**

**Hint 32.17**

**Hint 32.18**

**Hint 32.19**

**Hint 32.20**

**Hint 32.21**

## 32.11 Solutions

### Solution 32.1

$$\begin{aligned}\mathcal{F}[H(x+c) - H(x-c)] &= \frac{1}{2\pi} \int_{-\infty}^{\infty} (H(x+c) - H(x-c)) e^{-i\omega x} dx \\ &= \frac{1}{2\pi} \int_{-c}^c e^{-i\omega x} dx \\ &= \frac{1}{2\pi} \left[ \frac{e^{-i\omega x}}{-i\omega} \right]_{-c}^c \\ &= \frac{1}{2\pi} \left( \frac{e^{-i\omega c}}{-i\omega} - \frac{e^{i\omega c}}{-i\omega} \right)\end{aligned}$$

$$\boxed{\mathcal{F}[H(x+c) - H(x-c)] = \frac{\sin(c\omega)}{\pi\omega}}$$

### Solution 32.2

$$\begin{aligned}\mathcal{F} \left[ \frac{1}{x^2 + c^2} \right] &= \frac{1}{2\pi} \int_{-\infty}^{\infty} \frac{1}{x^2 + c^2} e^{-i\omega x} dx \\ &= \frac{1}{2\pi} \int_{-\infty}^{\infty} \frac{e^{-i\omega x}}{(x - ic)(x + ic)} dx\end{aligned}$$

If  $\Re(\omega) < 0$  then we close the path of integration with a semi-circle in the upper half plane.

$$\mathcal{F} \left[ \frac{1}{x^2 + c^2} \right] = \frac{1}{2\pi} 2\pi i \operatorname{Res} \left( \frac{e^{-i\omega x}}{(x - ic)(x + ic)}, x = ic \right) = \frac{1}{2c} e^{c\omega}$$

If  $\omega > 0$  then we close the path of integration in the lower half plane.

$$\mathcal{F} \left[ \frac{1}{x^2 + c^2} \right] = -\frac{1}{2\pi} 2\pi i \operatorname{Res} \left( \frac{e^{-\omega x}}{(x - ic)(x + ic)}, -ic \right) = \frac{1}{2c} e^{-c\omega}$$

Thus we have that

$$\mathcal{F} \left[ \frac{1}{x^2 + c^2} \right] = \frac{1}{2c} e^{-c|\omega|}, \quad \text{for } \Re(c) \neq 0.$$

### Solution 32.3

$$\begin{aligned} \mathcal{F}_s[y'] &= \frac{1}{\pi} \int_0^\infty y' \sin(\omega x) dx \\ &= \frac{1}{\pi} \left[ y \sin(\omega x) \right]_0^\infty - \frac{\omega}{\pi} \int_0^\infty y \cos(\omega x) dx \\ &= -\omega \hat{y}_c(\omega) \\ \mathcal{F}_s[y''] &= \frac{1}{\pi} \int_0^\infty y'' \sin(\omega x) dx \\ &= \frac{1}{\pi} \left[ y' \sin(\omega x) \right]_0^\infty - \frac{\omega}{\pi} \int_0^\infty y' \cos(\omega x) dx \\ &= -\frac{\omega}{\pi} \left[ y \cos(\omega x) \right]_0^\infty - \frac{\omega^2}{\pi} \int_0^\infty y \sin(\omega x) dx \\ &= -\omega^2 \hat{y}_s(\omega) + \frac{\omega}{\pi} y(0). \end{aligned}$$

**Solution 32.4**

1.

$$\begin{aligned}
\mathcal{F}[f(x - a)] &= \frac{1}{2\pi} \int_{-\infty}^{\infty} f(x - a) e^{-i\omega x} dx \\
&= \frac{1}{2\pi} \int_{-\infty}^{\infty} f(x) e^{-i\omega(x+a)} dx \\
&= e^{-i\omega a} \frac{1}{2\pi} \int_{-\infty}^{\infty} f(x) e^{-i\omega x} dx
\end{aligned}$$

$$\boxed{\mathcal{F}[f(x - a)] = e^{-i\omega a} \hat{f}(\omega)}$$

2. If  $a > 0$ , then

$$\begin{aligned}
\mathcal{F}[f(ax)] &= \frac{1}{2\pi} \int_{-\infty}^{\infty} f(ax) e^{-i\omega x} dx \\
&= \frac{1}{2\pi} \int_{-\infty}^{\infty} f(\xi) e^{-i\omega\xi/a} \frac{1}{a} d\xi \\
&= \frac{1}{a} \hat{f}\left(\frac{\omega}{a}\right).
\end{aligned}$$

If  $a < 0$ , then

$$\begin{aligned}
\mathcal{F}[f(ax)] &= \frac{1}{2\pi} \int_{-\infty}^{\infty} f(ax) e^{-i\omega x} dx \\
&= \frac{1}{2\pi} \int_{\infty}^{-\infty} e^{-i\omega\xi/a} \frac{1}{a} d\xi \\
&= -\frac{1}{a} \hat{f}\left(\frac{\omega}{a}\right).
\end{aligned}$$

Thus

$$\boxed{\mathcal{F}[f(ax)] = \frac{1}{|a|} \hat{f}\left(\frac{\omega}{a}\right).}$$

## Solution 32.5

$$\begin{aligned}
 \mathcal{F}_s[f(x)g(x)] &= \frac{1}{\pi} \int_0^{\infty} f(x)g(x) \sin(\omega x) \, dx \\
 &= \frac{1}{\pi} \int_0^{\infty} \left( 2 \int_0^{\infty} \hat{f}_s(\eta) \sin(\eta x) \, d\eta \right) g(x) \sin(\omega x) \, dx \\
 &= \frac{2}{\pi} \int_0^{\infty} \int_0^{\infty} \hat{f}_s(\eta) g(x) \sin(\eta x) \sin(\omega x) \, dx \, d\eta
 \end{aligned}$$

Use the identity,  $\sin a \sin b = \frac{1}{2}[\cos(a - b) - \cos(a + b)]$ .

$$\begin{aligned}
 &= \frac{1}{\pi} \int_0^{\infty} \int_0^{\infty} \hat{f}_s(\eta) g(x) \left[ \cos((\omega - \eta)x) - \cos((\omega + \eta)x) \right] \, dx \, d\eta \\
 &= \int_0^{\infty} \hat{f}_s(\eta) \left[ \frac{1}{\pi} \int_0^{\infty} g(x) \cos((\omega - \eta)x) \, dx - \frac{1}{\pi} \int_0^{\infty} g(x) \cos((\omega + \eta)x) \, dx \right] \, d\eta
 \end{aligned}$$

$$\boxed{\mathcal{F}_s[f(x)g(x)] = \int_0^{\infty} \hat{f}_s(\eta) [G_c(|\omega - \eta|) - G_c(\omega + \eta)] \, d\eta}$$



**Solution 32.6**

$$\begin{aligned}
\mathcal{F}_s^{-1}[\hat{f}_s(\omega)G_c(\omega)] &= 2 \int_0^\infty \hat{f}_s(\omega)G_c(\omega) \sin(\omega x) \, d\omega \\
&= 2 \int_0^\infty \left( \frac{1}{\pi} \int_0^\infty f(\xi) \sin(\omega\xi) \, d\xi \right) G_c(\omega) \sin(\omega x) \, d\omega \\
&= \frac{2}{\pi} \int_0^\infty \int_0^\infty f(\xi)G_c(\omega) \sin(\omega\xi) \sin(\omega x) \, d\omega \, d\xi \\
&= \frac{1}{\pi} \int_0^\infty \int_0^\infty f(\xi)G_c(\omega) \left[ \cos(\omega(x - \xi)) - \cos(\omega(x + \xi)) \right] \, d\omega \, d\xi \\
&= \frac{1}{2\pi} \int_0^\infty f(\xi) \left[ 2 \int_0^\infty G_c(\omega) \cos(\omega(x - \xi)) \, d\omega - 2 \int_0^\infty G_c(\omega) \cos(\omega(x + \xi)) \, d\omega \right] \, d\xi \\
&= \frac{1}{2\pi} \int_0^\infty f(\xi)[g(x - \xi) - g(x + \xi)] \, d\xi
\end{aligned}$$

$\mathcal{F}_s^{-1}[\hat{f}_s(\omega)G_c(\omega)] = \frac{1}{2\pi} \int_0^\infty f(\xi)[g( x - \xi ) - g(x + \xi)] \, d\xi$
---

**Solution 32.7**

$$\begin{aligned}
\mathcal{F}_c[xf(x)] &= \frac{1}{\pi} \int_0^\infty xf(x) \cos(\omega x) \, dx \\
&= \frac{1}{\pi} \int_0^\infty f(x) \frac{\partial}{\partial \omega} (\sin(\omega x)) \, dx \\
&= \frac{\partial}{\partial \omega} \frac{1}{\pi} \int_0^\infty f(x) \sin(\omega x) \, dx \\
&= \frac{\partial}{\partial \omega} \hat{f}_s(\omega)
\end{aligned}$$

$$\begin{aligned}
\mathcal{F}_s[xf(x)] &= \frac{1}{\pi} \int_0^{\infty} xf(x) \sin(\omega x) dx \\
&= \frac{1}{\pi} \int_0^{\infty} f(x) \frac{\partial}{\partial \omega} (-\cos(\omega x)) dx \\
&= -\frac{\partial}{\partial \omega} \frac{1}{\pi} \int_0^{\infty} f(x) \cos(\omega x) dx \\
&= -\frac{\partial}{\partial \omega} \hat{f}_c(\omega)
\end{aligned}$$

### Solution 32.8

$$y'' - y = e^{-2x}, \quad y(0) = 1, \quad y(\infty) = 0$$

We take the Fourier sine transform of the differential equation.

$$-\omega^2 \hat{y}_s(\omega) + \frac{\omega}{\pi} y(0) - \hat{y}_s(\omega) = \frac{2\omega/\pi}{\omega^2 + 4}$$

$$\begin{aligned}
\hat{y}_s(\omega) &= -\frac{\omega/\pi}{(\omega^2 + 4)(\omega^2 + 1)} + \frac{\omega/\pi}{(\omega^2 + 1)} \\
&= \frac{\omega/(3\pi)}{\omega^2 + 4} - \frac{\omega/(3\pi)}{\omega^2 + 1} + \frac{\omega/\pi}{\omega^2 + 1} \\
&= \frac{2}{3} \frac{\omega/\pi}{\omega^2 + 1} + \frac{1}{3} \frac{\omega/\pi}{\omega^2 + 4}
\end{aligned}$$

$$y = \frac{2}{3} e^{-x} + \frac{1}{3} e^{-2x}$$

### Solution 32.9

Consider the Fourier sine transform. Let  $f(x)$  be an odd function.

$$\mathcal{F}_s[f(x)] = \frac{1}{\pi} \int_0^{\infty} f(x) \sin(\omega x) dx$$

Extend the integration because the integrand is even.

$$= \frac{1}{2\pi} \int_{-\infty}^{\infty} f(x) \sin(\omega x) dx$$

Note that  $\int_{-\infty}^{\infty} f(x) \cos(\omega x) dx = 0$  as the integrand is odd.

$$\begin{aligned} &= \frac{1}{2\pi} \int_{-\infty}^{\infty} f(x) i e^{-i\omega x} dx \\ &= i\mathcal{F}[f(x)] \end{aligned}$$

$$\mathcal{F}_s[f(x)] = i\mathcal{F}[f(x)], \quad \text{for odd } f(x).$$

For general  $f(x)$ , use the odd extension,  $\text{sign}(x)f(|x|)$  to write the result.

$$\mathcal{F}_s[f(x)] = i\mathcal{F}[\text{sign}(x)f(|x|)]$$

Now consider the inverse Fourier sine transform. Let  $\hat{f}(\omega)$  be an odd function.

$$\mathcal{F}_s^{-1}[\hat{f}(\omega)] = 2 \int_0^{\infty} \hat{f}(\omega) \sin(\omega x) d\omega$$

Extend the integration because the integrand is even.

$$= \int_{-\infty}^{\infty} \hat{f}(\omega) \sin(\omega x) d\omega$$

Note that  $\int_{-\infty}^{\infty} \hat{f}(\omega) \cos(\omega x) d\omega = 0$  as the integrand is odd.

$$\begin{aligned} &= \int_{-\infty}^{\infty} \hat{f}(\omega) (-i) e^{i\omega x} d\omega \\ &= -i\mathcal{F}^{-1}[\hat{f}(\omega)] \end{aligned}$$

$$\mathcal{F}_s^{-1} [\hat{f}(\omega)] = -i\mathcal{F}^{-1} [\hat{f}(\omega)], \quad \text{for odd } \hat{f}(\omega).$$

For general  $\hat{f}(\omega)$ , use the odd extension,  $\text{sign}(\omega)\hat{f}(|\omega|)$  to write the result.

$$\mathcal{F}_s^{-1} [\hat{f}(\omega)] = -i\mathcal{F}^{-1} [\text{sign}(\omega)\hat{f}(|\omega|)]$$

### Solution 32.10

$$\begin{aligned} \mathcal{F}_c[xf(x)] &= \frac{1}{\pi} \int_0^{\infty} xf(x) \cos(\omega x) \, dx \\ &= \frac{1}{\pi} \int_0^{\infty} f(x) \frac{\partial}{\partial \omega} \sin(\omega x) \, dx \\ &= \frac{\partial}{\partial \omega} \frac{1}{\pi} \int_0^{\infty} f(x) \sin(\omega x) \, dx \\ &= \frac{\partial}{\partial \omega} \hat{f}_s(\omega) \end{aligned}$$

$$\begin{aligned} \mathcal{F}_s[xf(x)] &= \frac{1}{\pi} \int_0^{\infty} xf(x) \sin(\omega x) \, dx \\ &= \frac{1}{\pi} \int_0^{\infty} f(x) \frac{\partial}{\partial \omega} (-\cos(\omega x)) \, dx \\ &= -\frac{\partial}{\partial \omega} \frac{1}{\pi} \int_0^{\infty} f(x) \cos(\omega x) \, dx \\ &= -\frac{\partial}{\partial \omega} \hat{f}_c(\omega) \end{aligned}$$

$$\begin{aligned}
\mathcal{F}_c[f(cx)] &= \frac{1}{\pi} \int_0^{\infty} f(cx) \cos(\omega x) \, dx \\
&= \frac{1}{\pi} \int_0^{\infty} f(\xi) \cos\left(\frac{\omega}{c}\xi\right) \frac{d\xi}{c} \\
&= \frac{1}{c} \hat{f}_c\left(\frac{\omega}{c}\right)
\end{aligned}$$

$$\begin{aligned}
\mathcal{F}_s[f(cx)] &= \frac{1}{\pi} \int_0^{\infty} f(cx) \sin(\omega x) \, dx \\
&= \frac{1}{\pi} \int_0^{\infty} f(\xi) \sin\left(\frac{\omega}{c}\xi\right) \frac{d\xi}{c} \\
&= \frac{1}{c} \hat{f}_s\left(\frac{\omega}{c}\right)
\end{aligned}$$

### Solution 32.11

$$\int_{-\infty}^{\infty} u(\xi) e^{-a(x-\xi)^2} \, d\xi = e^{-bx^2}$$

We take the Fourier transform and solve for  $U(\omega)$ .

$$\begin{aligned}
2\pi U(\omega) \mathcal{F}\left[e^{-ax^2}\right] &= \mathcal{F}\left[e^{-bx^2}\right] \\
2\pi U(\omega) \frac{1}{\sqrt{4\pi a}} e^{-\omega^2/(4a)} &= \frac{1}{\sqrt{4\pi b}} e^{-\omega^2/(4b)} \\
U(\omega) &= \frac{1}{2\pi} \sqrt{\frac{a}{b}} e^{-\omega^2(a-b)/(4ab)}
\end{aligned}$$

Now we take the inverse Fourier transform.

$$U(\omega) = \frac{1}{2\pi} \sqrt{\frac{a}{b}} \frac{\sqrt{4\pi ab/(a-b)}}{\sqrt{4\pi ab/(a-b)}} e^{-\omega^2(a-b)/(4ab)}$$

$$u(x) = \frac{a}{\sqrt{\pi(a-b)}} e^{-abx^2/(a-b)}$$

### Solution 32.12

$$\begin{aligned} I &= \frac{1}{\pi} \int_0^{\infty} \frac{1}{x} e^{-cx} \sin(\omega x) dx \\ &= \frac{1}{\pi} \int_0^{\infty} \left( \int_c^{\infty} e^{-zx} dz \right) \sin(\omega x) dx \\ &= \frac{1}{\pi} \int_c^{\infty} \int_0^{\infty} e^{-zx} \sin(\omega x) dx dz \\ &= \frac{1}{\pi} \int_c^{\infty} \frac{\omega}{z^2 + \omega^2} dz \\ &= \frac{1}{\pi} \left[ \arctan \left( \frac{z}{\omega} \right) \right]_c^{\infty} \\ &= \frac{1}{\pi} \left( \frac{\pi}{2} - \arctan \left( \frac{c}{\omega} \right) \right) \\ &= \frac{1}{\pi} \arctan \left( \frac{\omega}{c} \right) \end{aligned}$$

### Solution 32.13

We consider the differential equation

$$y'' - a^2 y = e^{-a|x|}$$

on the domain  $-\infty < x < \infty$  with boundary conditions  $y(\pm\infty) = 0$ . We take the Fourier transform of the differential equation and solve for  $\hat{y}(\omega)$ .

$$\begin{aligned} -\omega^2 \hat{y} - a^2 \hat{y} &= \frac{a}{\pi(\omega^2 + a^2)} \\ \hat{y}(\omega) &= -\frac{a}{\pi(\omega^2 + a^2)^2} \end{aligned}$$

We take the inverse Fourier transform to find the solution of the differential equation.

$$y(x) = \int_{-\infty}^{\infty} -\frac{a}{\pi(\omega^2 + a^2)^2} e^{ix\omega} d\omega$$

Note that since  $\hat{y}(\omega)$  is a real-valued, even function,  $y(x)$  is a real-valued, even function. Thus we only need to evaluate the integral for positive  $x$ . If we replace  $x$  by  $|x|$  in this expression we will have the solution that is valid for all  $x$ .

For  $x \geq 0$ , we evaluate the integral by closing the path of integration in the upper half plane and using the Residue Theorem and Jordan's Lemma.

$$\begin{aligned} y(x) &= -\frac{a}{\pi} \int_{-\infty}^{\infty} \frac{1}{(\omega - ia)^2(\omega + ia)^2} e^{ix\omega} d\omega \\ &= -i2\pi \frac{a}{\pi} \operatorname{Res} \left( \frac{1}{(\omega - ia)^2(\omega + ia)^2} e^{ix\omega}, \omega = ia \right) \\ &= -i2a \lim_{\omega \rightarrow ia} \frac{d}{d\omega} \left( \frac{e^{ix\omega}}{(\omega + ia)^2} \right) \\ &= -i2a \lim_{\omega \rightarrow ia} \left( \frac{ix e^{ix\omega}}{(\omega + ia)^2} - \frac{2 e^{ix\omega}}{(\omega + ia)^3} \right) \\ &= -i2a \left( \frac{ix e^{-ax}}{-4a^2} - \frac{2 e^{-ax}}{-i8a^3} \right) \\ &= -\frac{(1 + ax) e^{-ax}}{2a^2} \end{aligned}$$

The solution of the differential equation is

$$y(x) = -\frac{1}{2a^2} (1 + a|x|) e^{-a|x|}.$$

**Solution 32.14**

1. We take the Fourier cosine transform of the differential equation.

$$-\omega^2 \hat{y}(\omega) - \frac{b}{\pi} - a^2 \hat{y}(\omega) = 0$$

$$\hat{y}(\omega) = -\frac{b}{\pi(\omega^2 + a^2)}$$

Now we take the inverse Fourier cosine transform. We use the fact that  $\hat{y}(\omega)$  is an even function.

$$y(x) = \mathcal{F}_c^{-1} \left[ -\frac{b}{\pi(\omega^2 + a^2)} \right]$$

$$= \mathcal{F}^{-1} \left[ -\frac{b}{\pi(\omega^2 + a^2)} \right]$$

$$= -\frac{b}{\pi} i 2\pi \operatorname{Res} \left( \frac{1}{\omega^2 + a^2} e^{i\omega x}, \omega = ia \right)$$

$$= -i 2b \lim_{\omega \rightarrow ia} \left( \frac{e^{i\omega x}}{\omega + ia} \right), \quad \text{for } x \geq 0$$

$$y(x) = -\frac{b}{a} e^{-ax}$$

2. The Green function problem is

$$G'' - a^2 G = \delta(x - \xi) \text{ on } x, \xi > 0, \quad G'(0; \xi) = 0, \quad G(\infty; \xi) = 0.$$

We take the Fourier cosine transform and solve for  $\hat{G}(\omega; \xi)$ .

$$-\omega^2 \hat{G} - a^2 \hat{G} = \mathcal{F}_c[\delta(x - \xi)]$$

$$\hat{G}(\omega; \xi) = -\frac{1}{\omega^2 + a^2} \mathcal{F}_c[\delta(x - \xi)]$$



We express the right side as a product of Fourier cosine transforms.

$$\hat{G}(\omega; \xi) = -\frac{\pi}{a} \mathcal{F}_c[e^{-ax}] \mathcal{F}_c[\delta(x - \xi)]$$

Now we can apply the Fourier cosine convolution theorem.

$$\mathcal{F}_c^{-1} [\mathcal{F}_c[f(x)] \mathcal{F}_c[g(x)]] = \frac{1}{2\pi} \int_0^\infty f(t)(g(|x-t|) + g(x+t)) dt$$

$$G(x; \xi) = -\frac{\pi}{a} \frac{1}{2\pi} \int_0^\infty \delta(t - \xi) (e^{-a|x-t|} + e^{-a(x+t)}) dt$$

$$\boxed{G(x; \xi) = -\frac{1}{2a} (e^{-a|x-\xi|} + e^{-a(x+\xi)})}$$

### Solution 32.15

1. We take the Fourier sine transform of the differential equation.

$$-\omega^2 \hat{y}(\omega) + \frac{b\omega}{\pi} - a^2 \hat{y}(\omega) = 0$$

$$\hat{y}(\omega) = \frac{b\omega}{\pi(\omega^2 + a^2)}$$

Now we take the inverse Fourier sine transform. We use the fact that  $\hat{y}(\omega)$  is an odd function.

$$\begin{aligned} y(x) &= \mathcal{F}_s^{-1} \left[ \frac{b\omega}{\pi(\omega^2 + a^2)} \right] \\ &= -i \mathcal{F}^{-1} \left[ \frac{b\omega}{\pi(\omega^2 + a^2)} \right] \\ &= -i \frac{b}{\pi} i 2\pi \operatorname{Res} \left( \frac{\omega}{\omega^2 + a^2} e^{i\omega x}, \omega = ia \right) \\ &= 2b \lim_{\omega \rightarrow ia} \left( \frac{\omega e^{i\omega x}}{\omega + ia} \right) \\ &= b e^{-ax} \quad \text{for } x \geq 0 \end{aligned}$$

$$y(x) = b e^{-ax}$$

2. Now we solve the differential equation with the Laplace transform.

$$y'' - a^2 y = 0$$
$$s^2 \hat{y}(s) - s y(0) - y'(0) - a^2 \hat{y}(s) = 0$$

We don't know the value of  $y'(0)$ , so we treat it as an unknown constant.

$$\hat{y}(s) = \frac{bs + y'(0)}{s^2 - a^2}$$
$$y(x) = b \cosh(ax) + \frac{y'(0)}{a} \sinh(ax)$$

In order to satisfy the boundary condition at infinity we must choose  $y'(0) = -ab$ .

$$y(x) = b e^{-ax}$$

We see that solving the differential equation with the Laplace transform is not as convenient, because the boundary condition at infinity is not automatically satisfied. We had to find a value of  $y'(0)$  so that  $y(\infty) = 0$ .

3. The Green function problem is

$$G'' - a^2 G = \delta(x - \xi) \text{ on } x, \xi > 0, \quad G(0; \xi) = 0, \quad G(\infty; \xi) = 0.$$

We take the Fourier sine transform and solve for  $\hat{G}(\omega; \xi)$ .

$$-\omega^2 \hat{G} - a^2 \hat{G} = \mathcal{F}_s[\delta(x - \xi)]$$
$$\hat{G}(\omega; \xi) = -\frac{1}{\omega^2 + a^2} \mathcal{F}_s[\delta(x - \xi)]$$

We write the right side as a product of Fourier cosine transforms and sine transforms.

$$\hat{G}(\omega; \xi) = -\frac{\pi}{a} \mathcal{F}_c[e^{-ax}] \mathcal{F}_s[\delta(x - \xi)]$$

Now we can apply the Fourier sine convolution theorem.

$$\mathcal{F}_s^{-1}[\mathcal{F}_s[f(x)]\mathcal{F}_c[g(x)]] = \frac{1}{2\pi} \int_0^\infty f(t)(g(|x-t|) - g(x+t)) dt$$

$$G(x; \xi) = -\frac{\pi}{a} \frac{1}{2\pi} \int_0^\infty \delta(t - \xi) (e^{-a|x-t|} - e^{-a(x+t)}) dt$$

$$\boxed{G(x; \xi) = \frac{1}{2a} (e^{-a(x-\xi)} - e^{-a|x+\xi|})}$$

### Solution 32.16

1. We take the Fourier transform of the differential equation, solve for  $\hat{G}$  and then invert.

$$G'' + 2\mu G' + (\beta^2 + \mu^2) G = \delta(x - \xi)$$

$$-\omega^2 \hat{G} + i2\mu\omega \hat{G} + (\beta^2 + \mu^2) \hat{G} = \frac{e^{-i\omega\xi}}{2\pi}$$

$$\hat{G} = -\frac{e^{-i\omega\xi}}{2\pi(\omega^2 - i2\mu\omega - \beta^2 - \mu^2)}$$

$$G = \int_{-\infty}^{\infty} -\frac{e^{-i\omega\xi} e^{i\omega x}}{2\pi(\omega^2 - i2\mu\omega - \beta^2 - \mu^2)} d\omega$$

$$G = -\frac{1}{2\pi} \int_{-\infty}^{\infty} \frac{e^{i\omega(x-\xi)}}{(\omega + \beta - i\mu)(\omega - \beta - i\mu)} d\omega$$

For  $x > \xi$  we close the path of integration in the upper half plane and use the Residue theorem. There are two simple poles in the upper half plane. For  $x < \xi$  we close the path of integration in the lower half plane. Since

the integrand is analytic there, the integral is zero.  $G(x; \xi) = 0$  for  $x < \xi$ . For  $x > \xi$  we have

$$G(x; \xi) = -\frac{1}{2\pi} i 2\pi \left( \operatorname{Res} \left( \frac{e^{i\omega(x-\xi)}}{(\omega + \beta - i\mu)(\omega - \beta - i\mu)}, \omega = -\beta + i\mu \right) + \operatorname{Res} \left( \frac{e^{i\omega(x-\xi)}}{(\omega + \beta - i\mu)(\omega - \beta - i\mu)}, \omega = -\beta - i\mu \right) \right)$$

$$G(x; \xi) = -i \left( \frac{e^{i(-\beta+i\mu)(x-\xi)}}{-2\beta} + \frac{e^{i(\beta+i\mu)(x-\xi)}}{2\beta} \right)$$

$$G(x; \xi) = \frac{1}{\beta} e^{-\mu(x-\xi)} \sin(\beta(x-\xi)).$$

Thus the Green function is

$$G(x; \xi) = \frac{1}{\beta} e^{-\mu(x-\xi)} \sin(\beta(x-\xi)) H(x-\xi).$$

2. We use the Green function to find the solution of the inhomogeneous equation.

$$y'' + 2\mu y' + (\beta^2 + \mu^2) y = g(x), \quad y(-\infty) = y(\infty) = 0$$

$$y(x) = \int_{-\infty}^{\infty} g(\xi) G(x; \xi) d\xi$$

$$y(x) = \int_{-\infty}^{\infty} g(\xi) \frac{1}{\beta} e^{-\mu(x-\xi)} \sin(\beta(x-\xi)) H(x-\xi) d\xi$$

$$y(x) = \frac{1}{\beta} \int_{-\infty}^x g(\xi) e^{-\mu(x-\xi)} \sin(\beta(x-\xi)) d\xi$$

We take the limit  $\mu \rightarrow 0$ .

$$y = \frac{1}{\beta} \int_{-\infty}^x g(\xi) \sin(\beta(x-\xi)) d\xi$$

**Solution 32.17**

First we consider the Fourier transform of  $f(x) = 1/(x^2 + c^2)$  where  $\Re(c) > 0$ .

$$\begin{aligned}\hat{f}(\omega) &= \mathcal{F} \left[ \frac{1}{x^2 + c^2} \right] \\ &= \frac{1}{2\pi} \int_{-\infty}^{\infty} \frac{1}{x^2 + c^2} e^{-i\omega x} dx \\ &= \frac{1}{2\pi} \int_{-\infty}^{\infty} \frac{e^{-i\omega x}}{(x - ic)(x + ic)} dx\end{aligned}$$

If  $\omega < 0$  then we close the path of integration with a semi-circle in the upper half plane.

$$\begin{aligned}\hat{f}(\omega) &= \frac{1}{2\pi} 2\pi i \operatorname{Res} \left( \frac{e^{-i\omega x}}{(x - ic)(x + ic)}, x = ic \right) \\ &= \frac{e^{c\omega}}{2c}, \quad \text{for } \omega < 0\end{aligned}$$

Note that  $f(x) = 1/(x^2 + c^2)$  is an even function of  $x$  so that  $\hat{f}(\omega)$  is an even function of  $\omega$ . If  $\hat{f}(\omega) = g(\omega)$  for  $\omega < 0$  then  $f(\omega) = g(-|\omega|)$  for all  $\omega$ . Thus

$$\boxed{\mathcal{F} \left[ \frac{1}{x^2 + c^2} \right] = \frac{1}{2c} e^{-c|\omega|} .}$$

Now we consider the integral equation

$$\int_{-\infty}^{\infty} \frac{u(\xi)}{[(x - \xi)^2 + a^2]} d\xi = \frac{1}{x^2 + b^2} \quad 0 < a < b.$$

We take the Fourier transform, utilizing the convolution theorem.

$$\begin{aligned}2\pi\hat{u}(\omega)\frac{e^{-a|\omega|}}{2a} &= \frac{e^{-b|\omega|}}{2b} \\ \hat{u}(\omega) &= \frac{ae^{-(b-a)|\omega|}}{2\pi b} \\ u(x) &= \frac{a}{2\pi b}2(b-a)\frac{1}{x^2+(b-a)^2} \\ \boxed{u(x) &= \frac{a(b-a)}{\pi b(x^2+(b-a)^2)}}\end{aligned}$$

### Solution 32.18

1. Note that  $\hat{f}_c(\omega)$  is an even function. We compute the inverse Fourier cosine transform.

$$\begin{aligned}f(x) &= \mathcal{F}_c^{-1}[\hat{f}_c(\omega)] \\ &= \int_{-\infty}^{\infty} \hat{f}_c(\omega) e^{i\omega x} d\omega \\ &= \int_{-\infty}^{\infty} \hat{f}_c(\omega)(\cos(\omega x) + i\sin(\omega x)) d\omega \\ &= \int_{-\infty}^{\infty} \hat{f}_c(\omega) \cos(\omega x) d\omega \\ &= 2 \int_0^{\infty} \hat{f}_c(\omega) \cos(\omega x) d\omega\end{aligned}$$

2.

$$\begin{aligned}\mathcal{F}_c[y''] &= \frac{1}{\pi} \int_0^\infty y'' \cos(\omega x) dx \\ &= \frac{1}{\pi} [y' \cos(\omega x)]_0^\infty + \frac{\omega}{\pi} \int_0^\infty y' \sin(\omega x) dx \\ &= -\frac{1}{\pi} y'(0) + \frac{\omega}{\pi} [y \sin(\omega x)]_0^\infty - \frac{\omega^2}{\pi} \int_0^\infty y \cos(\omega x) dx\end{aligned}$$

$$\boxed{\mathcal{F}_c[y''] = -\omega^2 \hat{y}_c(\omega) - \frac{y'(0)}{\pi}}$$

3. We take the Fourier cosine transform of the differential equation.

$$\begin{aligned}-\omega^2 \hat{y}(\omega) - \frac{b}{\pi} - a^2 \hat{y}(\omega) &= 0 \\ \hat{y}(\omega) &= -\frac{b}{\pi(\omega^2 + a^2)}\end{aligned}$$

Now we take the inverse Fourier cosine transform. We use the fact that  $\hat{y}(\omega)$  is an even function.

$$\begin{aligned}y(x) &= \mathcal{F}_c^{-1} \left[ -\frac{b}{\pi(\omega^2 + a^2)} \right] \\ &= \mathcal{F}^{-1} \left[ -\frac{b}{\pi(\omega^2 + a^2)} \right] \\ &= -\frac{b}{\pi} i 2\pi \operatorname{Res} \left( \frac{1}{\omega^2 + a^2} e^{i\omega x}, \omega = ia \right) \\ &= -i 2b \lim_{\omega \rightarrow ia} \left( \frac{e^{i\omega x}}{\omega + ia} \right), \quad \text{for } x \geq 0\end{aligned}$$

$$\boxed{y(x) = -\frac{b}{a} e^{-ax}}$$

**Solution 32.19**

1. Suppose  $f(x)$  is an odd function. The Fourier transform of  $f(x)$  is

$$\begin{aligned}\mathcal{F}[f(x)] &= \frac{1}{2\pi} \int_{-\infty}^{\infty} f(x) e^{-\omega x} dx \\ &= \frac{1}{2\pi} \int_{-\infty}^{\infty} f(x) (\cos(\omega x) - \imath \sin(\omega x)) dx \\ &= -\frac{\imath}{\pi} \int_0^{\infty} f(x) \sin(\omega x) dx.\end{aligned}$$

Note that  $\hat{f}(\omega) = \mathcal{F}[f(x)]$  is an odd function of  $\omega$ . The inverse Fourier transform of  $\hat{f}(\omega)$  is

$$\begin{aligned}\mathcal{F}^{-1}[\hat{f}(\omega)] &= \int_{-\infty}^{\infty} \hat{f}(\omega) e^{\omega x} d\omega \\ &= 2\imath \int_0^{\infty} \hat{f}(\omega) \sin(\omega x) d\omega.\end{aligned}$$

Thus we have that

$$\begin{aligned}f(x) &= 2\imath \int_0^{\infty} \left( -\frac{\imath}{\pi} \int_0^{\infty} f(x) \sin(\omega x) dx \right) \sin(\omega x) d\omega \\ &= 2 \int_0^{\infty} \left( \frac{1}{\pi} \int_0^{\infty} f(x) \sin(\omega x) dx \right) \sin(\omega x) d\omega.\end{aligned}$$

This gives us the Fourier sine transform pair

$$f(x) = 2 \int_0^{\infty} \hat{f}_s(\omega) \sin(\omega x) d\omega, \quad \hat{f}_s(\omega) = \frac{1}{\pi} \int_0^{\infty} f(x) \sin(\omega x) dx.$$



2.

$$\begin{aligned}\mathcal{F}_s[y''] &= \frac{1}{\pi} \int_0^{\infty} y'' \sin(\omega x) dx \\ &= \frac{1}{\pi} \left[ y' \sin(\omega x) \right]_0^{\infty} - \frac{\omega}{\pi} \int_0^{\infty} y' \cos(\omega x) dx \\ &= -\frac{\omega}{\pi} \left[ y \cos(\omega x) \right]_0^{\infty} - \frac{\omega^2}{\pi} \int_0^{\infty} y \sin(\omega x) dx\end{aligned}$$

$$\boxed{\mathcal{F}_s[y''] = -\omega^2 \hat{y}_s(\omega) + \frac{\omega}{\pi} y(0)}$$

3. We take the Fourier sine transform of the differential equation.

$$\begin{aligned}-\omega^2 \hat{y}(\omega) + \frac{b\omega}{\pi} - a^2 \hat{y}(\omega) &= 0 \\ \hat{y}(\omega) &= \frac{b\omega}{\pi(\omega^2 + a^2)}\end{aligned}$$

Now we take the inverse Fourier sine transform. We use the fact that  $\hat{y}(\omega)$  is an odd function.

$$\begin{aligned}y(x) &= \mathcal{F}_s^{-1} \left[ \frac{b\omega}{\pi(\omega^2 + a^2)} \right] \\ &= -i \mathcal{F}^{-1} \left[ \frac{b\omega}{\pi(\omega^2 + a^2)} \right] \\ &= -i \frac{b}{\pi} i 2\pi \operatorname{Res} \left( \frac{\omega}{\omega^2 + a^2} e^{i\omega x}, \omega = ia \right) \\ &= 2b \lim_{\omega \rightarrow ia} \left( \frac{\omega e^{i\omega x}}{\omega + ia} \right) \\ &= b e^{-ax} \quad \text{for } x \geq 0\end{aligned}$$

$$\boxed{y(x) = b e^{-ax}}$$

4. Now we solve the differential equation with the Laplace transform.

$$y'' - a^2 y = 0$$
$$s^2 \hat{y}(s) - sy(0) - y'(0) - a^2 \hat{y}(s) = 0$$

We don't know the value of  $y'(0)$ , so we treat it as an unknown constant.

$$\hat{y}(s) = \frac{bs + y'(0)}{s^2 - a^2}$$
$$y(x) = b \cosh(ax) + \frac{y'(0)}{a} \sinh(ax)$$

In order to satisfy the boundary condition at infinity we must choose  $y'(0) = -ab$ .

$$y(x) = b e^{-ax}$$

We see that solving the differential equation with the Laplace transform is not as convenient, because the boundary condition at infinity is not automatically satisfied. We had to find a value of  $y'(0)$  so that  $y(\infty) = 0$ .

### Solution 32.20

The Fourier, Fourier cosine and Fourier sine transforms are defined:

$$\mathcal{F}[f(x)] = \frac{1}{2\pi} \int_{-\infty}^{\infty} f(x) e^{-i\omega x} dx,$$
$$\mathcal{F}[f(x)]_c = \frac{1}{\pi} \int_0^{\infty} f(x) \cos(\omega x) dx,$$
$$\mathcal{F}[f(x)]_s = \frac{1}{\pi} \int_0^{\infty} f(x) \sin(\omega x) dx.$$

We start with the right side of the identity and apply the usual tricks of integral calculus to reduce the expression to the left side.

$$\frac{1}{2} (\mathcal{F}_c[f(x) + f(-x)] - i\mathcal{F}_s[f(x) - f(-x)])$$

$$\begin{aligned} & \frac{1}{2\pi} \left( \int_0^\infty f(x) \cos(\omega x) dx + \int_0^\infty f(-x) \cos(\omega x) dx - i \int_0^\infty f(x) \sin(\omega x) dx + i \int_0^\infty f(-x) \sin(\omega x) dx \right) \\ & \frac{1}{2\pi} \left( \int_0^\infty f(x) \cos(\omega x) dx - \int_0^{-\infty} f(x) \cos(-\omega x) dx - i \int_0^\infty f(x) \sin(\omega x) dx - i \int_0^{-\infty} f(x) \sin(-\omega x) dx \right) \\ & \frac{1}{2\pi} \left( \int_0^\infty f(x) \cos(\omega x) dx + \int_{-\infty}^0 f(x) \cos(\omega x) dx - i \int_0^\infty f(x) \sin(\omega x) dx - i \int_{-\infty}^0 f(x) \sin(\omega x) dx \right) \end{aligned}$$

$$\begin{aligned} & \frac{1}{2\pi} \left( \int_{-\infty}^\infty f(x) \cos(\omega x) dx - i \int_{-\infty}^\infty f(x) \sin(\omega x) dx \right) \\ & \frac{1}{2\pi} \int_{-\infty}^\infty f(x) e^{-i\omega x} dx \\ & \mathcal{F}[f(x)] \end{aligned}$$

### Solution 32.21

We take the Fourier transform of the integral equation, noting that the left side is the convolution of  $u(x)$  and  $\frac{1}{x^2+a^2}$ .

$$2\pi \hat{u}(\omega) \mathcal{F} \left[ \frac{1}{x^2 + a^2} \right] = \mathcal{F} \left[ \frac{1}{x^2 + b^2} \right]$$

We find the Fourier transform of  $f(x) = \frac{1}{x^2+c^2}$ . Note that since  $f(x)$  is an even, real-valued function,  $\hat{f}(\omega)$  is an even, real-valued function.

$$\mathcal{F} \left[ \frac{1}{x^2 + c^2} \right] = \frac{1}{2\pi} \int_{-\infty}^\infty \frac{1}{x^2 + c^2} e^{-i\omega x} dx$$

For  $x > 0$  we close the path of integration in the upper half plane and apply Jordan's Lemma to evaluate the integral in terms of the residues.

$$\begin{aligned}
 &= \frac{1}{2\pi} i 2\pi \operatorname{Res} \left( \frac{e^{-i\omega x}}{(x - ic)(x + ic)}, x = ic \right) \\
 &= i \frac{e^{-i\omega c}}{2ic} \\
 &= \frac{1}{2c} e^{-c\omega}
 \end{aligned}$$

Since  $\hat{f}(\omega)$  is an even function, we have

$$\mathcal{F} \left[ \frac{1}{x^2 + c^2} \right] = \frac{1}{2c} e^{-c|\omega|}.$$

Our equation for  $\hat{u}(\omega)$  becomes,

$$\begin{aligned}
 2\pi \hat{u}(\omega) \frac{1}{2a} e^{-a|\omega|} &= \frac{1}{2b} e^{-b|\omega|} \\
 \hat{u}(\omega) &= \frac{a}{2\pi b} e^{-(b-a)|\omega|}.
 \end{aligned}$$

We take the inverse Fourier transform using the transform pair we derived above.

$$u(x) = \frac{a}{2\pi b} \frac{2(b-a)}{x^2 + (b-a)^2}$$

$$u(x) = \frac{a(b-a)}{\pi b(x^2 + (b-a)^2)}$$

# Chapter 33

## The Gamma Function

### 33.1 Euler's Formula

For non-negative, integral  $n$  the factorial function is

$$n! = n(n-1) \cdots (1), \quad \text{with } 0! = 1.$$

We would like to extend the factorial function so it is defined for all complex numbers.

Consider the function  $\Gamma(z)$  defined by Euler's formula

$$\Gamma(z) = \int_0^{\infty} e^{-t} t^{z-1} dt.$$

(Here we take the principal value of  $t^{z-1}$ .) The integral converges for  $\Re(z) > 0$ . If  $\Re(z) \leq 0$  then the integrand will be at least as singular as  $1/t$  at  $t = 0$  and thus the integral will diverge.

**Difference Equation.** Using integration by parts,

$$\begin{aligned}\Gamma(z+1) &= \int_0^{\infty} e^{-t} t^z dt \\ &= \left[ -e^{-t} t^z \right]_0^{\infty} - \int_0^{\infty} -e^{-t} z t^{z-1} dt.\end{aligned}$$

Since  $\Re(z) > 0$  the first term vanishes.

$$\begin{aligned}&= z \int_0^{\infty} e^{-t} t^{z-1} dt \\ &= z\Gamma(z)\end{aligned}$$

Thus  $\Gamma(z)$  satisfies the difference equation

$$\boxed{\Gamma(z+1) = z\Gamma(z).}$$

For general  $z$  it is not possible to express the integral in terms of elementary functions. However, we can evaluate the integral for some  $z$ . The value  $z = 1$  looks particularly simple to do.

$$\Gamma(1) = \int_0^{\infty} e^{-t} dt = \left[ -e^{-t} \right]_0^{\infty} = 1.$$

Using the difference equation we can find the value of  $\Gamma(n)$  for any positive, integral  $n$ .

$$\begin{aligned}\Gamma(1) &= 1 \\ \Gamma(2) &= 1 \\ \Gamma(3) &= (2)(1) = 2 \\ \Gamma(4) &= (3)(2)(1) = 6 \\ &\dots = \dots \\ \Gamma(n+1) &= n!.\end{aligned}$$

Thus the Gamma function,  $\Gamma(z)$ , extends the factorial function to all complex  $z$  in the right half-plane. For non-negative, integral  $n$  we have

$$\boxed{\Gamma(n + 1) = n!}$$

**Analyticity.** The derivative of  $\Gamma(z)$  is

$$\Gamma'(z) = \int_0^{\infty} e^{-t} t^{z-1} \log t \, dt.$$

Since this integral converges for  $\Re(z) > 0$ ,  $\Gamma(z)$  is analytic in that domain.

## 33.2 Hankel's Formula

We would like to find the analytic continuation of the Gamma function into the left half-plane. We accomplish this with Hankel's formula

$$\Gamma(z) = \frac{1}{i2 \sin(\pi z)} \int_C e^t t^{z-1} \, dt.$$

Here  $C$  is the contour starting at  $-\infty$  below the real axis, enclosing the origin and returning to  $-\infty$  above the real axis. A graph of this contour is shown in Figure 33.1. Again we use the principle value of  $t^{z-1}$  so there is a branch cut on the negative real axis.

The integral in Hankel's formula converges for all complex  $z$ . For non-positive, integral  $z$  the integral does not vanish. Thus because of the sine term the Gamma function has simple poles at  $z = 0, -1, -2, \dots$ . For positive, integral  $z$ , the integrand is entire and thus the integral vanishes. Using L'Hospital's rule you can show that the points,  $z = 1, 2, 3, \dots$  are removable singularities and the Gamma function is analytic at these points. Since the only zeroes of  $\sin(\pi z)$  occur for integral  $z$ ,  $\Gamma(z)$  is analytic in the entire plane except for the points,  $z = 0, -1, -2, \dots$

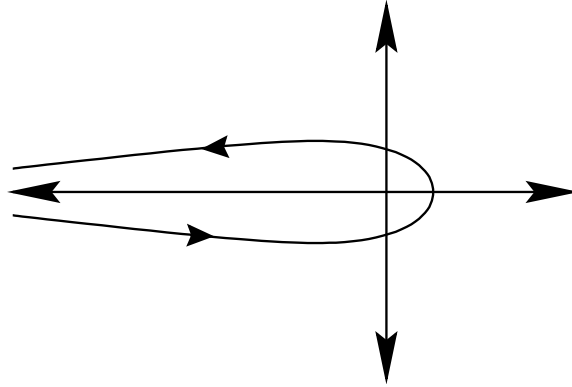

Figure 33.1: The Hankel Contour.

**Difference Equation.** Using integration by parts we can derive the difference equation from Hankel's formula.

$$\begin{aligned}
 \Gamma(z + 1) &= \frac{1}{i2 \sin(\pi(z + 1))} \int_C e^t t^z dt \\
 &= \frac{1}{-i2 \sin(\pi z)} \left( \left[ e^t t^z \right]_{-\infty - i0}^{-\infty + i0} - \int_C e^t z t^{z-1} dt \right) \\
 &= \frac{1}{i2 \sin(\pi z)} z \int_C e^t t^{z-1} dt \\
 &= z\Gamma(z).
 \end{aligned}$$

Evaluating  $\Gamma(1)$ ,

$$\Gamma(1) = \lim_{z \rightarrow 1} \frac{\int_C e^t t^{z-1} dt}{i2 \sin(\pi z)}.$$



Both the numerator and denominator vanish. Using L'Hospital's rule,

$$\begin{aligned} &= \lim_{z \rightarrow 1} \frac{\int_C e^t t^{z-1} \log t \, dt}{i2\pi \cos(\pi z)} \\ &= \frac{\int_C e^t \log t \, dt}{i2\pi} \end{aligned}$$

Let  $C_r$  be the circle of radius  $r$  starting at  $-\pi$  radians and going to  $\pi$  radians.

$$\begin{aligned} &= \frac{1}{i2\pi} \left( \int_{-\infty}^{-r} e^t [\log(-t) - \pi i] \, dt + \int_{C_r} e^t \log t \, dt + \int_{-r}^{-\infty} e^t [\log(-t) + \pi i] \, dt \right) \\ &= \frac{1}{i2\pi} \left( \int_{-r}^{-\infty} e^t [-\log(-t) + \pi i] \, dt + \int_{-r}^{-\infty} e^t [\log(-t) + \pi i] \, dt + \int_{C_r} e^t \log t \, dt \right) \\ &= \frac{1}{i2\pi} \left( \int_{-r}^{-\infty} e^t i2\pi \, dt + \int_{C_r} e^t \log t \, dt \right) \end{aligned}$$

The integral on  $C_r$  vanishes as  $r \rightarrow 0$ .

$$\begin{aligned} &= \frac{1}{i2\pi} i2\pi \int_0^{-\infty} e^t \, dt \\ &= 1. \end{aligned}$$

Thus we obtain the same value as with Euler's formula. It can be shown that Hankel's formula is the analytic continuation of the Gamma function into the left half-plane.

### 33.3 Gauss' Formula

Gauss defined the Gamma function as an infinite product. This form is useful in deriving some of its properties. We can obtain the product form from Euler's formula. First recall that

$$e^{-t} = \lim_{n \rightarrow \infty} \left( 1 - \frac{t}{n} \right)^n.$$

Substituting this into Euler's formula,

$$\begin{aligned}\Gamma(z) &= \int_0^{\infty} e^{-t} t^{z-1} dt \\ &= \lim_{n \rightarrow \infty} \int_0^n \left(1 - \frac{t}{n}\right)^n t^{z-1} dt.\end{aligned}$$

With the substitution  $\tau = t/n$ ,

$$\begin{aligned}&= \lim_{n \rightarrow \infty} \int_0^1 (1 - \tau)^n n^{z-1} \tau^{z-1} n d\tau \\ &= \lim_{n \rightarrow \infty} n^z \int_0^1 (1 - \tau)^n \tau^{z-1} d\tau.\end{aligned}$$

Let  $n$  be an integer. Using integration by parts we can evaluate the integral.

$$\begin{aligned}\int_0^1 (1 - \tau)^n \tau^{z-1} d\tau &= \left[ \frac{(1 - \tau)^n \tau^z}{z} \right]_0^1 - \int_0^1 -n(1 - \tau)^{n-1} \frac{\tau^z}{z} d\tau \\ &= \frac{n}{z} \int_0^1 (1 - \tau)^{n-1} \tau^z d\tau \\ &= \frac{n(n-1)}{z(z+1)} \int_0^1 (1 - \tau)^{n-2} \tau^{z+1} d\tau \\ &= \frac{n(n-1) \cdots (1)}{z(z+1) \cdots (z+n-1)} \int_0^1 \tau^{z+n-1} d\tau \\ &= \frac{n(n-1) \cdots (1)}{z(z+1) \cdots (z+n-1)} \left[ \frac{\tau^{z+n}}{z+n} \right]_0^1 \\ &= \frac{n!}{z(z+1) \cdots (z+n)}\end{aligned}$$

Thus we have that

$$\begin{aligned}
 \Gamma(z) &= \lim_{n \rightarrow \infty} n^z \frac{n!}{z(z+1) \cdots (z+n)} \\
 &= \frac{1}{z} \lim_{n \rightarrow \infty} \frac{(1)(2) \cdots (n)}{(z+1)(z+2) \cdots (z+n)} n^z \\
 &= \frac{1}{z} \lim_{n \rightarrow \infty} \frac{1}{(1+z)(1+z/2) \cdots (1+z/n)} n^z \\
 &= \frac{1}{z} \lim_{n \rightarrow \infty} \frac{1}{(1+z)(1+z/2) \cdots (1+z/n)} \frac{2^z 3^z \cdots n^z}{1^z 2^z \cdots (n-1)^z}
 \end{aligned}$$

Since  $\lim_{n \rightarrow \infty} \frac{(n+1)^z}{n^z} = 1$  we can multiply by that factor.

$$\begin{aligned}
 &= \frac{1}{z} \lim_{n \rightarrow \infty} \frac{1}{(1+z)(1+z/2) \cdots (1+z/n)} \frac{2^z 3^z \cdots (n+1)^z}{1^z 2^z \cdots n^z} \\
 &= \frac{1}{z} \prod_{n=1}^{\infty} \left[ \frac{1}{1+z/n} \frac{(n+1)^z}{n^z} \right]
 \end{aligned}$$

Thus we have Gauss' formula for the Gamma function

$$\boxed{\Gamma(z) = \frac{1}{z} \prod_{n=1}^{\infty} \left[ \left(1 + \frac{1}{n}\right)^z \left(1 + \frac{z}{n}\right)^{-1} \right]}$$

We derived this formula from Euler's formula which is valid only in the left half-plane. However, the product formula is valid for all  $z$  except  $z = 0, -1, -2, \dots$

## 33.4 Weierstrass' Formula

**The Euler-Mascheroni Constant.** Before deriving Weierstrass' product formula for the Gamma function we will need to define the Euler-Mascheroni constant

$$\gamma = \lim_{n \rightarrow \infty} \left[ \left( 1 + \frac{1}{2} + \frac{1}{3} + \cdots + \frac{1}{n} \right) - \log n \right] = 0.5772 \dots$$

In deriving the Euler product formula, we had the equation

$$\begin{aligned} \Gamma(z) &= \lim_{n \rightarrow \infty} \left[ n^z \frac{n!}{z(z+1) \cdots (z+n)} \right] \\ &= \lim_{n \rightarrow \infty} \left[ z^{-1} \left( 1 + \frac{z}{1} \right)^{-1} \left( 1 + \frac{z}{2} \right)^{-1} \cdots \left( 1 + \frac{z}{n} \right)^{-1} n^z \right] \\ \frac{1}{\Gamma(z)} &= \lim_{n \rightarrow \infty} \left[ z \left( 1 + \frac{z}{1} \right) \left( 1 + \frac{z}{2} \right) \cdots \left( 1 + \frac{z}{n} \right) e^{-z \log n} \right] \\ &= \lim_{n \rightarrow \infty} \left[ z \left( 1 + \frac{z}{1} \right) e^{-z} \left( 1 + \frac{z}{2} \right) e^{-z/2} \cdots \left( 1 + \frac{z}{n} \right) e^{-z/n} \exp \left( \left[ 1 + \frac{1}{2} + \cdots + \frac{1}{n} - \log n \right] z \right) \right] \end{aligned}$$

Weierstrass' formula for the Gamma function is then

$$\boxed{\frac{1}{\Gamma(z)} = z e^{\gamma z} \prod_{n=1}^{\infty} \left[ \left( 1 + \frac{z}{n} \right) e^{-z/n} \right].}$$

Since the product is uniformly convergent,  $1/\Gamma(z)$  is an entire function. Since  $1/\Gamma(z)$  has no singularities, we see that  $\Gamma(z)$  has no zeros.

**Result 33.4.1** Euler's formula for the Gamma function is valid for  $\Re(z) > 0$ .

$$\Gamma(z) = \int_0^{\infty} e^{-t} t^{z-1} dt$$

Hankel's formula defines the  $\Gamma(z)$  for the entire complex plane except for the points  $z = 0, -1, -2, \dots$

$$\Gamma(z) = \frac{1}{i2 \sin(\pi z)} \int_C e^t t^{z-1} dt$$

Gauss' and Weierstrass' product formulas are, respectively

$$\Gamma(z) = \frac{1}{z} \prod_{n=1}^{\infty} \left[ \left(1 + \frac{1}{n}\right)^z \left(1 + \frac{z}{n}\right)^{-1} \right] \quad \text{and}$$

$$\frac{1}{\Gamma(z)} = z e^{\gamma z} \prod_{n=1}^{\infty} \left[ \left(1 + \frac{z}{n}\right) e^{-z/n} \right].$$

## 33.5 Stirling's Approximation

In this section we will try to get an approximation to the Gamma function for large positive argument. Euler's formula is

$$\Gamma(x) = \int_0^{\infty} e^{-t} t^{x-1} dt.$$

We could first try to approximate the integral by only looking at the domain where the integrand is large. In Figure 33.2 the integrand in the formula for  $\Gamma(10)$ ,  $e^{-t} t^9$ , is plotted.

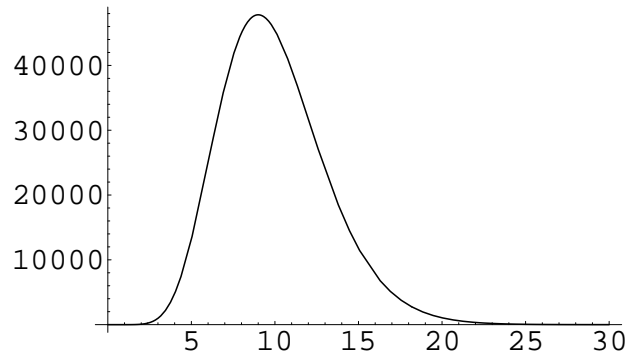

Figure 33.2: Plot of the integrand for  $\Gamma(10)$

We see that the "important" part of the integrand is the hump centered around  $x = 9$ . If we find where the integrand of  $\Gamma(x)$  has its maximum

$$\begin{aligned} \frac{d}{dx} (e^{-t} t^{x-1}) &= 0 \\ -e^{-t} t^{x-1} + (x-1) e^{-t} t^{x-2} &= 0 \\ (x-1) - t &= 0 \\ t &= x-1, \end{aligned}$$

we see that the maximum varies with  $x$ . This could complicate our analysis. To take care of this problem we introduce

the change of variables  $t = xs$ .

$$\begin{aligned}\Gamma(x) &= \int_0^\infty e^{-xs} (xs)^{x-1} x \, ds \\ &= x^x \int_0^\infty e^{-xs} s^x s^{-1} \, ds \\ &= x^x \int_0^\infty e^{-x(s-\log s)} s^{-1} \, ds\end{aligned}$$

The integrands,  $(e^{-x(s-\log s)} s^{-1})$ , for  $\Gamma(5)$  and  $\Gamma(20)$  are plotted in Figure 33.3.

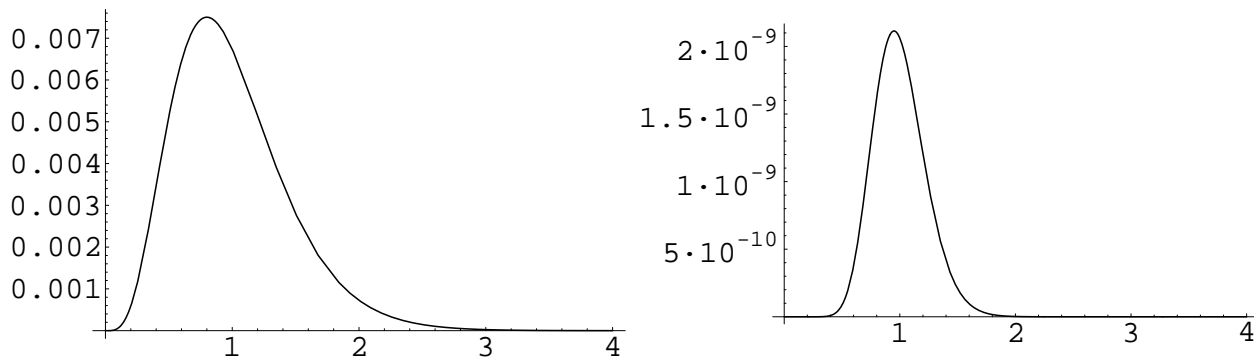

Figure 33.3: Plot of the integrand for  $\Gamma(5)$  and  $\Gamma(20)$ .

We see that the important part of the integrand is the hump that seems to be centered about  $s = 1$ . Also note that the hump becomes narrower with increasing  $x$ . This makes sense as the  $e^{-x(s-\log s)}$  term is the most rapidly varying term. Instead of integrating from zero to infinity, we could get a good approximation to the integral by just integrating over some small neighborhood centered at  $s = 1$ . Since  $s - \log s$  has a minimum at  $s = 1$ ,  $e^{-x(s-\log s)}$  has a maximum there. Because the important part of the integrand is the small area around  $s = 1$ , it makes sense to

approximate  $s - \log s$  with its Taylor series about that point.

$$s - \log s = 1 + \frac{1}{2}(s - 1)^2 + O[(s - 1)^3]$$

Since the hump becomes increasingly narrow with increasing  $x$ , we will approximate the  $1/s$  term in the integrand with its value at  $s = 1$ . Substituting these approximations into the integral, we obtain

$$\begin{aligned}\Gamma(x) &\sim x^x \int_{1-\epsilon}^{1+\epsilon} e^{-x(1+(s-1)^2/2)} ds \\ &= x^x e^{-x} \int_{1-\epsilon}^{1+\epsilon} e^{-x(s-1)^2/2} ds\end{aligned}$$

As  $x \rightarrow \infty$  both of the integrals

$$\int_{-\infty}^{1-\epsilon} e^{-x(s-1)^2/2} ds \quad \text{and} \quad \int_{1+\epsilon}^{\infty} e^{-x(s-1)^2/2} ds$$

are exponentially small. Thus instead of integrating from  $1 - \epsilon$  to  $1 + \epsilon$  we can integrate from  $-\infty$  to  $\infty$ .

$$\begin{aligned}\Gamma(x) &\sim x^x e^{-x} \int_{-\infty}^{\infty} e^{-x(s-1)^2/2} ds \\ &= x^x e^{-x} \int_{-\infty}^{\infty} e^{-xs^2/2} ds \\ &= x^x e^{-x} \sqrt{\frac{2\pi}{x}}\end{aligned}$$

$$\boxed{\Gamma(x) \sim \sqrt{2\pi} x^{x-1/2} e^{-x} \quad \text{as } x \rightarrow \infty.}$$

This is known as Stirling's approximation to the Gamma function. In the table below, we see that the approximation is pretty good even for relatively small argument.



$n$	$\Gamma(n)$	$\sqrt{2\pi}x^{x-1/2}e^{-x}$	relative error
5	24	23.6038	0.0165
15	$8.71783 \cdot 10^{10}$	$8.66954 \cdot 10^{10}$	0.0055
25	$6.20448 \cdot 10^{23}$	$6.18384 \cdot 10^{23}$	0.0033
35	$2.95233 \cdot 10^{38}$	$2.94531 \cdot 10^{38}$	0.0024
45	$2.65827 \cdot 10^{54}$	$2.65335 \cdot 10^{54}$	0.0019

In deriving Stirling's approximation to the Gamma function we did a lot of hand waving. However, all of the steps can be justified and better approximations can be obtained by using Laplace's method for finding the asymptotic behavior of integrals.

## 33.6 Exercises

### Exercise 33.1

Given that

$$\int_{-\infty}^{\infty} e^{-x^2} dx = \sqrt{\pi},$$

deduce the value of  $\Gamma(1/2)$ . Now find the value of  $\Gamma(n + 1/2)$ .

### Exercise 33.2

Evaluate  $\int_0^{\infty} e^{-x^3} dx$  in terms of the gamma function.

### Exercise 33.3

Show that

$$\int_0^{\infty} e^{-x} \sin(\log x) dx = \frac{\Gamma(i) + \Gamma(-i)}{2}.$$

## 33.7 Hints

### Hint 33.1

Use the change of variables,  $\xi = x^2$  in the integral. To find the value of  $\Gamma(n + 1/2)$  use the difference relation.

### Hint 33.2

Make the change of variable  $\xi = x^3$ .

### Hint 33.3

## 33.8 Solutions

### Solution 33.1

$$\int_{-\infty}^{\infty} e^{-x^2} dx = \sqrt{\pi}$$
$$\int_0^{\infty} e^{-x^2} dx = \frac{\sqrt{\pi}}{2}$$

Make the change of variables  $\xi = x^2$ .

$$\int_0^{\infty} e^{-\xi} \frac{1}{2} \xi^{-1/2} d\xi = \frac{\sqrt{\pi}}{2}$$

$$\Gamma(1/2) = \sqrt{\pi}$$

Recall the difference relation for the Gamma function  $\Gamma(z + 1) = z\Gamma(z)$ .

$$\begin{aligned}\Gamma(n + 1/2) &= (n - 1/2)\Gamma(n - 1/2) \\ &= \frac{2n - 1}{2}\Gamma(n - 1/2) \\ &= \frac{(2n - 3)(2n - 1)}{2^2}\Gamma(n - 3/2) \\ &= \frac{(1)(3)(5) \cdots (2n - 1)}{2^n}\Gamma(1/2)\end{aligned}$$

$$\Gamma(n + 1/2) = \frac{(1)(3)(5) \cdots (2n - 1)}{2^n} \sqrt{\pi}$$

**Solution 33.2**

We make the change of variable  $\xi = x^3$ ,  $x = \xi^{1/3}$ ,  $dx = \frac{1}{3}\xi^{-2/3} d\xi$ .

$$\begin{aligned}\int_0^\infty e^{-x^3} dx &= \int_0^\infty e^{-\xi} \frac{1}{3}\xi^{-2/3} d\xi \\ &= \frac{1}{3}\Gamma\left(\frac{1}{3}\right)\end{aligned}$$

**Solution 33.3**

$$\begin{aligned}\int_0^\infty e^{-x} \sin(\log x) dx &= \int_0^\infty e^{-x} \frac{1}{i2} (e^{i \log x} - e^{-i \log x}) dx \\ &= \frac{1}{i2} \int_0^\infty e^{-x} (x^i - x^{-i}) dx \\ &= \frac{1}{i2} (\Gamma(1+i) - \Gamma(1-i)) \\ &= \frac{1}{i2} (i\Gamma(i) - (-i)\Gamma(-i)) \\ &= \frac{\Gamma(i) + \Gamma(-i)}{2}\end{aligned}$$

# Chapter 34

## Bessel Functions

Ideas are angels. Implementations are a bitch.

### 34.1 Bessel's Equation

A commonly encountered differential equation in applied mathematics is *Bessel's equation*

$$y'' + \frac{1}{z}y' + \left(1 - \frac{\nu^2}{z^2}\right)y = 0.$$

For our purposes, we will consider  $\nu \in \mathbb{R}^{0+}$ . This equation arises when solving certain partial differential equations with the method of separation of variables in cylindrical coordinates. For this reason, the solutions of this equation are sometimes called *cylindrical functions*.

This equation cannot be solved directly. However, we can find series representations of the solutions. There is a regular singular point at  $z = 0$ , so the Frobenius method is applicable there. The point at infinity is an irregular singularity, so we will look for asymptotic series about that point. Additionally, we will use Laplace's method to find definite integral representations of the solutions.

Note that Bessel's equation depends only on  $\nu^2$  and not  $\nu$  alone. Thus if we find a solution, (which of course depends on this parameter),  $y_\nu(z)$  we know that  $y_{-\nu}(z)$  is also a solution. For this reason, we will consider  $\nu \in \mathbb{R}^{0+}$ . Whether or not  $y_\nu(z)$  and  $y_{-\nu}(z)$  are linearly independent, (distinct solutions), remains to be seen.

**Example 34.1.1** Consider the differential equation

$$y'' + \frac{1}{z}y' + \frac{\nu^2}{z^2}y = 0$$

One solution is  $y_\nu(z) = z^\nu$ . Since the equation depends only on  $\nu^2$ , another solution is  $y_{-\nu}(z) = z^{-\nu}$ . For  $\nu \neq 0$ , these two solutions are linearly independent.

Now consider the differential equation

$$y'' + \nu^2 y = 0$$

One solution is  $y_\nu(z) = \cos(\nu z)$ . Therefore, another solution is  $y_{-\nu}(z) = \cos(-\nu z) = \cos(\nu z)$ . However, these two solutions are not linearly independent.

## 34.2 Frobenius Series Solution about $z = 0$

We note that  $z = 0$  is a regular singular point, (the only singular point of Bessel's equation in the finite complex plane.) We will use the Frobenius method at that point to analyze the solutions. We assume that  $\nu \geq 0$ .

The indicial equation is

$$\begin{aligned} \alpha(\alpha - 1) + \alpha - \nu^2 &= 0 \\ \alpha &= \pm\nu. \end{aligned}$$

If  $\pm\nu$  do not differ by an integer, (that is if  $\nu$  is not a half-integer), then there will be two series solutions of the Frobenius form.

$$y_1(z) = z^\nu \sum_{k=0}^{\infty} a_k z^k, \quad y_2(z) = z^{-\nu} \sum_{k=0}^{\infty} b_k z^k$$

If  $\nu$  is a half-integer, the second solution may or may not be in the Frobenius form. In any case, there will always be at least one solution in the Frobenius form. We will determine that series solution.  $y(z)$  and its derivatives are

$$y = \sum_{k=0}^{\infty} a_k z^{k+\nu}, \quad y' = \sum_{k=0}^{\infty} (k+\nu) a_k z^{k+\nu-1}, \quad y'' = \sum_{k=0}^{\infty} (k+\nu)(k+\nu-1) a_k z^{k+\nu-2}.$$

We substitute the Frobenius series into the differential equation.

$$\begin{aligned} z^2 y'' + z y' + (z^2 - \nu^2) y &= 0 \\ \sum_{k=0}^{\infty} (k+\nu)(k+\nu-1) a_k z^{k+\nu} + \sum_{k=0}^{\infty} (k+\nu) a_k z^{k+\nu} + \sum_{k=0}^{\infty} a_k z^{k+\nu+2} - \sum_{k=0}^{\infty} \nu^2 a_k z^{k+\nu} &= 0 \\ \sum_{k=0}^{\infty} (k^2 + 2k\nu) a_k z^k + \sum_{k=2}^{\infty} a_{k-2} z^k &= 0 \end{aligned}$$

We equate powers of  $z$  to obtain equations that determine the coefficients. The coefficient of  $z^0$  is the equation  $0 \cdot a_0 = 0$ . This corroborates that  $a_0$  is arbitrary, (but non-zero). The coefficient of  $z^1$  is the equation

$$\begin{aligned} (1 + 2\nu) a_1 &= 0 \\ a_1 &= 0 \end{aligned}$$

The coefficient of  $z^k$  for  $k \geq 2$  gives us

$$\begin{aligned} (k^2 + 2k\nu) a_k + a_{k-2} &= 0. \\ a_k &= -\frac{a_{k-2}}{k^2 + 2k\nu} = -\frac{a_{k-2}}{k(k + 2\nu)} \end{aligned}$$

From the recurrence relation we see that all the odd coefficients are zero,  $a_{2k+1} = 0$ . The even coefficients are

$$a_{2k} = -\frac{a_{2k-2}}{4k(k + \nu)} = \frac{(-1)^k a_0}{2^{2k} k! \Gamma(k + \nu + 1)}$$



Thus we have the series solution

$$y(z) = a_0 \sum_{k=0}^{\infty} \frac{(-1)^k}{2^{2k} k! \Gamma(k + \nu + 1)} z^{2k}.$$

$a_0$  is arbitrary. We choose  $a_0 = 2^{-\nu}$ . We call this solution the *Bessel function of the first kind and order  $\nu$*  and denote it with  $J_\nu(z)$ .

$$J_\nu(z) = \sum_{k=0}^{\infty} \frac{(-1)^k}{k! \Gamma(k + \nu + 1)} \left(\frac{z}{2}\right)^{2k+\nu}$$

Recall that the Gamma function is non-zero and finite for all real arguments except non-positive integers.  $\Gamma(x)$  has singularities at  $x = 0, -1, -2, \dots$ . Therefore,  $J_{-\nu}(z)$  is well-defined when  $\nu$  is not a positive integer. Since  $J_{-\nu}(z) \sim z^{-\nu}$  at  $z = 0$ ,  $J_{-\nu}(z)$  is clear linearly independent to  $J_\nu(z)$  for non-integer  $\nu$ . In particular we note that there are two solutions of the Frobenius form when  $\nu$  is a half odd integer.

$$J_{-\nu}(z) = \sum_{k=0}^{\infty} \frac{(-1)^k}{k! \Gamma(k - \nu + 1)} \left(\frac{z}{2}\right)^{2k-\nu}, \quad \text{for } \nu \notin \mathbb{Z}^+$$

Of course for  $\nu = 0$ ,  $J_\nu(z)$  and  $J_{-\nu}(z)$  are identical. Consider the case that  $\nu = n$  is a positive integer. Since  $\Gamma(x) \rightarrow +\infty$  as  $x \rightarrow 0, -1, -2, \dots$  we see the the coefficients in the series for  $J_{-n}(z)$  vanish for  $k = 0, \dots, n - 1$ .

$$\begin{aligned} J_{-n}(z) &= \sum_{k=n}^{\infty} \frac{(-1)^k}{k! \Gamma(k - n + 1)} \left(\frac{z}{2}\right)^{2k-n} \\ J_{-n}(z) &= \sum_{k=0}^{\infty} \frac{(-1)^{k+n}}{(k+n)! \Gamma(k+1)} \left(\frac{z}{2}\right)^{2k+n} \\ J_{-n}(z) &= (-1)^n \sum_{k=0}^{\infty} \frac{(-1)^k}{k! (k+n)!} \left(\frac{z}{2}\right)^{2k+n} \\ J_{-n}(z) &= (-1)^n J_n(z) \end{aligned}$$

Thus we see that  $J_{-n}(z)$  and  $J_n(z)$  are not linearly independent for integer  $n$ .

### 34.2.1 Behavior at Infinity

With the change of variables  $z = 1/\zeta$ ,  $w(z) = u(\zeta)$  Bessel's equation becomes

$$\zeta^4 u'' + 2\zeta^3 u' + \zeta(-\zeta^2) u' + (1 - \nu^2 \zeta^2) u = 0$$

$$u'' + \frac{1}{\zeta} u' + \left( \frac{1}{\zeta^4} - \frac{\nu^2}{\zeta^2} \right) u = 0.$$

The point  $\zeta = 0$  and hence the point  $z = \infty$  is an irregular singular point. We will find the leading order asymptotic behavior of the solutions as  $z \rightarrow +\infty$ .

**Controlling Factor.** We start with Bessel's equation for real argument.

$$y'' + \frac{1}{x} y' + \left( 1 - \frac{\nu^2}{x^2} \right) y = 0$$

We make the substitution  $y = e^{s(x)}$ .

$$s'' + (s')^2 + \frac{1}{x} s' + 1 - \frac{\nu^2}{x^2} = 0$$

We know that  $\frac{\nu^2}{x^2} \ll 1$  as  $x \rightarrow \infty$ ; we will assume that  $s'' \ll (s')^2$  as  $x \rightarrow \infty$ .

$$(s')^2 + \frac{1}{x} s' + 1 \sim 0 \quad \text{as } x \rightarrow \infty$$

To simplify the equation further, we will try the possible two-term balances.

1.  $(s')^2 + \frac{1}{x} s' \sim 0 \quad \rightarrow \quad s' \sim -\frac{1}{x}$  This balance is not consistent as it violates the assumption that 1 is smaller than the other terms.
2.  $(s')^2 + 1 \sim 0 \quad \rightarrow \quad s' \sim \pm i$  This balance is consistent.
3.  $\frac{1}{x} s' + 1 \sim 0 \quad \rightarrow \quad s' \sim -x$  This balance is inconsistent as  $(s')^2$  isn't smaller than the other terms.

Thus the only dominant balance is  $s' \sim \pm i$ . This balance is consistent with our initial assumption that  $s'' \ll (s')^2$ . Thus  $s \sim \pm ix$  and the controlling factor is  $e^{\pm ix}$ .

**Leading Order Behavior.** In order to find the leading order behavior, we substitute  $s = \pm ix + t(x)$  where  $t(x) \ll x$  as  $x \rightarrow \infty$  into the differential equation for  $s$ . We first consider the case  $s = ix + t(x)$ . We assume that  $t' \ll 1$  and  $t'' \ll 1/x$ .

$$t'' + (i + t')^2 + \frac{1}{x}(i + t') + 1 - \frac{\nu^2}{x^2} = 0$$

$$t'' + i2t' + (t')^2 + \frac{i}{x} + \frac{1}{x}t' - \frac{\nu^2}{x^2} = 0$$

We use our assumptions about the behavior of  $t'$  and  $t''$ .

$$i2t' + \frac{i}{x} \sim 0$$

$$t' \sim -\frac{1}{2x}$$

$$t \sim -\frac{1}{2} \ln x \quad \text{as } x \rightarrow \infty.$$

This asymptotic behavior is consistent with our assumptions.

Substituting  $s = -ix + t(x)$  will also yield  $t \sim -\frac{1}{2} \ln x$ . Thus the leading order behavior of the solutions is

$$y \sim c e^{\pm ix - \frac{1}{2} \ln x + u(x)} = c x^{-1/2} e^{\pm ix + u(x)} \quad \text{as } x \rightarrow \infty,$$

where  $u(x) \ll \ln x$  as  $x \rightarrow \infty$ .

By substituting  $t = -\frac{1}{2} \ln x + u(x)$  into the differential equation for  $t$ , you could show that  $u(x) \rightarrow \text{const}$  as  $x \rightarrow \infty$ . Thus the full leading order behavior of the solutions is

$$y \sim c x^{-1/2} e^{\pm ix + u(x)} \quad \text{as } x \rightarrow \infty$$

where  $u(x) \rightarrow 0$  as  $x \rightarrow \infty$ . Writing this in terms of sines and cosines yields

$$y_1 \sim x^{-1/2} \cos(x + u_1(x)), \quad y_2 \sim x^{-1/2} \sin(x + u_2(x)), \quad \text{as } x \rightarrow \infty,$$

where  $u_1, u_2 \rightarrow 0$  as  $x \rightarrow \infty$ .

**Result 34.2.1** Bessel's equation for real argument is

$$y'' + \frac{1}{x}y' + \left(1 - \frac{\nu^2}{x^2}\right)y = 0.$$

If  $\nu$  is not an integer then the solutions behave as linear combinations of

$$y_1 = x^\nu, \quad \text{and} \quad y_2 = x^{-\nu}$$

at  $x = 0$ . If  $\nu$  is an integer, then the solutions behave as linear combinations of

$$y_1 = x^\nu, \quad \text{and} \quad y_2 = x^{-\nu} + cx^\nu \log x$$

at  $x = 0$ . The solutions are asymptotic to a linear combination of

$$y_1 = x^{-1/2} \sin(x + u_1(x)), \quad \text{and} \quad y_2 = x^{-1/2} \cos(x + u_2(x))$$

as  $x \rightarrow +\infty$ , where  $u_1, u_2 \rightarrow 0$  as  $x \rightarrow \infty$ .

### 34.3 Bessel Functions of the First Kind

Consider the function  $\exp(\frac{1}{2}z(t - 1/t))$ . We can expand this function in a Laurent series in powers of  $t$ ,

$$e^{\frac{1}{2}z(t-1/t)} = \sum_{n=-\infty}^{\infty} J_n(z)t^n,$$

where the coefficient functions  $J_n(z)$  are

$$J_n(z) = \frac{1}{i2\pi} \oint \tau^{-n-1} e^{\frac{1}{2}z(\tau-1/\tau)} d\tau.$$

Here the path of integration is any positive closed path around the origin.  $\exp(\frac{1}{2}z(t-1/t))$  is the **generating function** for Bessel function of the first kind.

### 34.3.1 The Bessel Function Satisfies Bessel's Equation

We would like to expand  $J_n(z)$  in powers of  $z$ . The first step in doing this is to make the substitution  $\tau = 2t/z$ .

$$\begin{aligned} J_n(z) &= \frac{1}{i2\pi} \oint \left(\frac{2t}{z}\right)^{-n-1} \exp\left(\frac{1}{2}z\left(\frac{2t}{z} - \frac{z}{2t}\right)\right) \frac{2}{z} dt \\ &= \frac{1}{i2\pi} \left(\frac{z}{2}\right)^n \oint t^{-n-1} e^{t-z^2/4t} dt \end{aligned}$$

We differentiate the expression for  $J_n(z)$ .

$$\begin{aligned} J'_n(z) &= \frac{1}{i2\pi} \frac{nz^{n-1}}{2^n} \oint t^{-n-1} e^{t-z^2/4t} dt + \frac{1}{i2\pi} \left(\frac{z}{2}\right)^n \oint t^{-n-1} \left(\frac{-2z}{4t}\right) e^{t-z^2/4t} dt \\ &= \frac{1}{i2\pi} \left(\frac{z}{2}\right)^n \oint \left(\frac{n}{z} - \frac{z}{2t}\right) t^{-n-1} e^{t-z^2/4t} dt \end{aligned}$$

$$\begin{aligned} J''_n(z) &= \frac{1}{i2\pi} \left(\frac{z}{2}\right)^n \oint \left[ \frac{n}{z} \left(\frac{n}{z} - \frac{z}{2t}\right) + \left(-\frac{n}{z^2} - \frac{1}{2t}\right) - \frac{z}{2t} \left(\frac{n}{z} - \frac{z}{2t}\right) \right] t^{-n-1} e^{t-z^2/4t} dt \\ &= \frac{1}{i2\pi} \left(\frac{z}{2}\right)^n \oint \left[ \frac{n^2}{z^2} - \frac{nz}{2zt} - \frac{n}{z^2} - \frac{1}{2t} - \frac{nz}{2zt} + \frac{z^2}{4t^2} \right] t^{-n-1} e^{t-z^2/4t} dt \\ &= \frac{1}{i2\pi} \left(\frac{z}{2}\right)^n \oint \left[ \frac{n(n-1)}{z^2} - \frac{2n+1}{2t} + \frac{z^2}{4t^2} \right] t^{-n-1} e^{t-z^2/4t} dt \end{aligned}$$

We substitute  $J_n(z)$  into Bessel's equation.

$$\begin{aligned}
 J_n'' + \frac{1}{z}J_n' + \left(1 - \frac{n^2}{z^2}\right) J_n & \\
 = \frac{1}{i2\pi} \left(\frac{z}{2}\right)^n \oint \left[ \left(\frac{n(n-1)}{z^2} - \frac{2n+1}{2t} + \frac{z^2}{4t^2}\right) + \left(\frac{n}{z^2} - \frac{1}{2t}\right) + \left(1 - \frac{n^2}{z^2}\right) \right] t^{-n-1} e^{t-z^2/4t} dt & \\
 = \frac{1}{i2\pi} \left(\frac{z}{2}\right)^n \oint \left[ 1 - \frac{n+1}{t} + \frac{z^2}{4t^2} \right] t^{-n-1} e^{t-z^2/4t} dt & \\
 = \frac{1}{i2\pi} \left(\frac{z}{2}\right)^n \oint \frac{d}{dt} \left( t^{-n-1} e^{t-z^2/4t} \right) dt &
 \end{aligned}$$

Since  $t^{-n-1} e^{t-z^2/4t}$  is analytic in  $0 < |t| < \infty$  when  $n$  is an integer, the integral vanishes.

$$= 0.$$

Thus for integer  $n$ ,  $J_n(z)$  satisfies Bessel's equation.

$J_n(z)$  is called the Bessel function of the first kind. The subscript is the order. Thus  $J_1(z)$  is a Bessel function of order 1.  $J_0(x)$  and  $J_1(x)$  are plotted in the first graph in Figure 34.1.  $J_5(x)$  is plotted in the second graph in Figure 34.1. Note that for non-negative, integer  $n$ ,  $J_n(z)$  behaves as  $z^n$  at  $z = 0$ .

### 34.3.2 Series Expansion of the Bessel Function

We expand  $\exp(-z^2/4t)$  in the integral expression for  $J_n$ .

$$\begin{aligned}
 J_n(z) &= \frac{1}{i2\pi} \left(\frac{z}{2}\right)^n \oint t^{-n-1} e^{t-z^2/4t} dt \\
 &= \frac{1}{i2\pi} \left(\frac{z}{2}\right)^n \oint t^{-n-1} e^t \left( \sum_{m=0}^{\infty} \left(\frac{-z^2}{4t}\right)^m \frac{1}{m!} \right) dt
 \end{aligned}$$

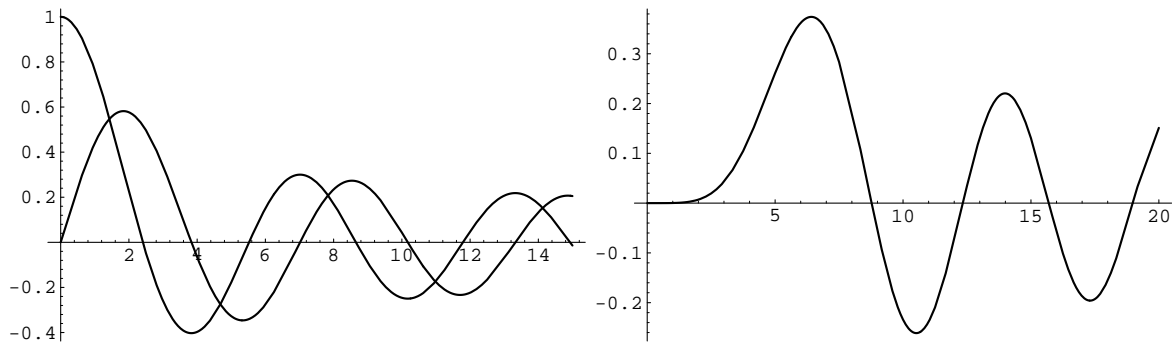

Figure 34.1: Plots of  $J_0(x)$ ,  $J_1(x)$  and  $J_5(x)$ .

For the path of integration, we are free to choose any contour that encloses the origin. Consider the circular path on  $|t| = 1$ . Since the integral is uniformly convergent, we can interchange the order of integration and summation.

$$J_n(z) = \frac{1}{i2\pi} \left(\frac{z}{2}\right)^n \sum_{m=0}^{\infty} \frac{(-1)^m z^{2m}}{2^{2m} m!} \oint t^{-n-m-1} e^t dt$$

Let  $n$  be a non-negative integer.

$$\begin{aligned} \frac{1}{i2\pi} \oint t^{-n-m-1} e^t dt &= \lim_{z \rightarrow 0} \left( \frac{1}{(n+m)!} \frac{d^{n+m}}{dz^{n+m}} (e^z) \right) \\ &= \frac{1}{(n+m)!} \end{aligned}$$

We have the series expansion

$$J_n(z) = \sum_{m=0}^{\infty} \frac{(-1)^m}{m!(n+m)!} \left(\frac{z}{2}\right)^{n+2m} \quad \text{for } n \geq 0.$$

Now consider  $J_{-n}(z)$ , ( $n$  positive).

$$J_{-n}(z) = \frac{1}{i2\pi} \left(\frac{z}{2}\right)^{-n} \sum_{m=1}^{\infty} \frac{(-1)^m z^{2m}}{2^{2m} m!} \oint t^{n-m-1} e^t dt$$

For  $m \geq n$ , the integrand has a pole of order  $m - n + 1$  at the origin.

$$\frac{1}{i2\pi} \oint t^{n-m-1} e^t dt = \begin{cases} \frac{1}{(m-n)!} & \text{for } m \geq n \\ 0 & \text{for } m < n \end{cases}$$

The expression for  $J_{-n}$  is then

$$\begin{aligned} J_{-n}(z) &= \sum_{m=n}^{\infty} \frac{(-1)^m}{m!(m-n)!} \left(\frac{z}{2}\right)^{-n+2m} \\ &= \sum_{m=0}^{\infty} \frac{(-1)^{m+n}}{(m+n)!m!} \left(\frac{z}{2}\right)^{n+2m} \\ &= (-1)^n J_n(z). \end{aligned}$$

Thus we have that

$$J_{-n}(z) = (-1)^n J_n(z) \quad \text{for integer } n.$$



### 34.3.3 Bessel Functions of Non-Integer Order

The generalization of the factorial function is the Gamma function. For integer values of  $n$ ,  $n! = \Gamma(n+1)$ . The Gamma function is defined for all complex-valued arguments. Thus one would guess that if the Bessel function of the first kind were defined for non-integer order, it would have the definition,

$$J_\nu(z) = \sum_{m=0}^{\infty} \frac{(-1)^m}{m! \Gamma(\nu + m + 1)} \left(\frac{z}{2}\right)^{\nu+2m}.$$

**The Integrand for Non-Integer  $\nu$ .** Recall the definition of the Bessel function

$$J_\nu(z) = \frac{1}{i2\pi} \left(\frac{z}{2}\right)^\nu \oint t^{-\nu-1} e^{t-z^2/4t} dt.$$

When  $\nu$  is an integer, the integrand is single valued. Thus if you start at any point and follow any path around the origin, the integrand will return to its original value. This property was the key to  $J_n$  satisfying Bessel's equation. If  $\nu$  is not an integer, then this property does not hold for arbitrary paths around the origin.

**A New Contour.** First, since the integrand is multiple-valued, we need to define what branch of the function we are talking about. We will take the principal value of the integrand and introduce a branch cut on the negative real axis. Let  $C$  be a contour that starts at  $z = -\infty$  below the branch cut, circles the origin, and returns to the point  $z = -\infty$  above the branch cut. This contour is shown in Figure 34.2.

Thus we define

$$J_\nu(z) = \frac{1}{i2\pi} \left(\frac{z}{2}\right)^\nu \oint_C t^{-\nu-1} e^{t-z^2/4t} dt.$$

**Bessel's Equation.** Substituting  $J_\nu(z)$  into Bessel's equation yields

$$J_\nu'' + \frac{1}{z} J_\nu' + \left(1 - \frac{\nu^2}{z^2}\right) J_\nu = \frac{1}{i2\pi} \left(\frac{z}{2}\right)^\nu \oint_C \frac{d}{dt} \left(t^{-\nu-1} e^{t-z^2/4t}\right) dt.$$

Since  $t^{-\nu-1} e^{t-z^2/4t}$  is analytic in  $0 < |z| < \infty$  and  $|\arg(z)| < \pi$ , and it vanishes at  $z = -\infty$ , the integral is zero. Thus the Bessel function of the first kind satisfies Bessel's equation for all complex orders.

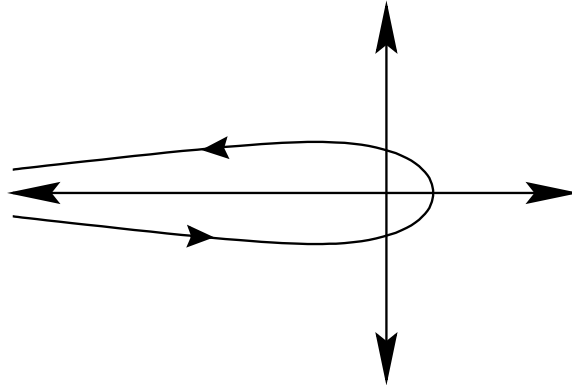

Figure 34.2: The Contour of Integration.

**Series Expansion.** Because of the  $e^t$  factor in the integrand, the integral defining  $J_\nu$  converges uniformly. Expanding  $e^{-z^2/4t}$  in a Taylor series yields

$$J_\nu(z) = \frac{1}{i2\pi} \left(\frac{z}{2}\right)^\nu \sum_{m=0}^{\infty} \frac{(-1)^m z^{2m}}{2^{2m} m!} \oint_C t^{-\nu-m-1} e^t dt$$

Since

$$\frac{1}{\Gamma(\alpha)} = \frac{1}{i2\pi} \oint_C t^{-\alpha-1} e^t dt,$$

we have the series expansion of the Bessel function

$$J_\nu(z) = \sum_{m=0}^{\infty} \frac{(-1)^m}{m! \Gamma(\nu + m + 1)} \left(\frac{z}{2}\right)^{\nu+2m}.$$

**Linear Independence.** We use Abel's formula to compute the Wronskian of Bessel's equation.

$$W(z) = \exp\left(-\int^z \frac{1}{\zeta} d\zeta\right) = e^{-\log z} = \frac{1}{z}$$

Thus to within a function of  $\nu$ , the Wronskian of any two solutions is  $1/z$ . For any given  $\nu$ , there are two linearly independent solutions. Note that Bessel's equation is unchanged under the transformation  $\nu \rightarrow -\nu$ . Thus both  $J_\nu$  and  $J_{-\nu}$  satisfy Bessel's equation. Now we must determine if they are linearly independent. We have already shown that for integer values of  $\nu$  they are not independent. ( $J_{-n} = (-1)^n J_n$ .) Assume that  $\nu$  is not an integer. We compute the Wronskian of  $J_\nu$  and  $J_{-\nu}$ .

$$\begin{aligned} W[J_\nu, J_{-\nu}] &= \begin{vmatrix} J_\nu & J_{-\nu} \\ J'_\nu & J'_{-\nu} \end{vmatrix} \\ &= J_\nu J'_{-\nu} - J_{-\nu} J'_\nu \end{aligned}$$

We substitute in the expansion for  $J_\nu$

$$\begin{aligned} &= \left( \sum_{m=0}^{\infty} \frac{(-1)^m}{m! \Gamma(\nu + m + 1)} \left(\frac{z}{2}\right)^{\nu+2m} \right) \left( \sum_{n=0}^{\infty} \frac{(-1)^n (-\nu + 2n)}{n! \Gamma(-\nu + n + 1) 2} \left(\frac{z}{2}\right)^{-\nu+2n-1} \right) \\ &\quad - \left( \sum_{m=0}^{\infty} \frac{(-1)^m}{m! \Gamma(-\nu + m + 1)} \left(\frac{z}{2}\right)^{-\nu+2m} \right) \left( \sum_{n=0}^{\infty} \frac{(-1)^n (\nu + 2n)}{n! \Gamma(\nu + n + 1) 2} \left(\frac{z}{2}\right)^{\nu+2n-1} \right) \end{aligned}$$

Since the Wronskian is a function of  $\nu$  times  $1/z$  the coefficients of all of the powers of  $z$  except  $1/z$  must vanish.

$$\begin{aligned} &= \frac{-\nu}{z \Gamma(\nu + 1) \Gamma(-\nu + 1)} - \frac{\nu}{z \Gamma(-\nu + 1) \Gamma(\nu + 1)} \\ &= -\frac{2}{z \Gamma(\nu) \Gamma(1 - \nu)} \end{aligned}$$

Using an identity for the Gamma function simplifies this expression.

$$= -\frac{2}{\pi z} \sin(\pi\nu)$$

Since the Wronskian is nonzero for non-integer  $\nu$ ,  $J_\nu$  and  $J_{-\nu}$  are independent functions when  $\nu$  is not an integer. In this case, the general solution of Bessel's equation is  $aJ_\nu + bJ_{-\nu}$ .

### 34.3.4 Recursion Formulas

In showing that  $J_\nu$  satisfies Bessel's equation for arbitrary complex  $\nu$ , we obtained

$$\oint_C \frac{d}{dt} \left( t^{-\nu} e^{t-z^2/4t} \right) dt = 0.$$

Expanding the integral,

$$\begin{aligned} \oint_C \left( t^{-\nu} + \frac{z^2}{4} t^{-\nu-2} - \nu t^{-\nu-1} \right) e^{t-z^2/4t} dt &= 0. \\ \frac{1}{i2\pi} \left( \frac{z}{2} \right)^\nu \oint_C \left( t^{-\nu} + \frac{z^2}{4} t^{-\nu-2} - \nu t^{-\nu-1} \right) e^{t-z^2/4t} dt &= 0. \end{aligned}$$

Since  $J_\nu(z) = \frac{1}{i2\pi} (z/2)^\nu \oint_C t^{-\nu-1} e^{t-z^2/4t} dt$ ,

$$\left[ \left( \frac{2}{z} \right)^{-1} J_{\nu-1} + \left( \frac{2}{z} \right) \frac{z^2}{4} J_{\nu+1} - \nu J_\nu \right] = 0.$$

$$\boxed{J_{\nu-1} + J_{\nu+1} = \frac{2\nu}{z} J_\nu}$$

Differentiating the integral expression for  $J_\nu$ ,

$$J'_\nu(z) = \frac{1}{i2\pi} \frac{\nu z^{\nu-1}}{2^\nu} \oint_C t^{-\nu-1} e^{t-z^2/4t} dt + \frac{1}{i2\pi} \left(\frac{z}{2}\right)^\nu \oint_C t^{-\nu-1} \left(-\frac{z}{2t}\right) e^{t-z^2/4t} dt$$

$$J'_\nu(z) = \frac{\nu}{z} \frac{1}{i2\pi} \left(\frac{z}{2}\right)^\nu \oint_C t^{-\nu-1} e^{t-z^2/4t} dt - \frac{1}{i2\pi} \left(\frac{z}{2}\right)^{\nu+1} \oint_C t^{-\nu-2} e^{t-z^2/4t} dt$$

$$\boxed{J'_\nu = \frac{\nu}{z} J_\nu - J_{\nu+1}}$$

From the two relations we have derived you can show that

$$\boxed{J'_\nu = \frac{1}{2}(J_{\nu-1} + J_{\nu+1})}$$

and

$$\boxed{J'_\nu = J_{\nu-1} - \frac{\nu}{z} J_\nu}$$

**Result 34.3.1** The Bessel function of the first kind,  $J_\nu(z)$ , is defined,

$$J_\nu(z) = \frac{1}{i2\pi} \left(\frac{z}{2}\right)^\nu \oint_C t^{-\nu-1} e^{t-z^2/4t} dt.$$

The Bessel function has the expansion,

$$J_\nu(z) = \sum_{m=0}^{\infty} \frac{(-1)^m}{m!\Gamma(\nu+m+1)} \left(\frac{z}{2}\right)^{\nu+2m}.$$

The asymptotic behavior for large argument is

$$J_\nu(z) \sim \sqrt{\frac{2}{\pi z}} \left( \cos\left(z - \frac{\nu\pi}{2} - \frac{\pi}{4}\right) + e^{|\Im(z)|} \mathcal{O}(|z|^{-1}) \right) \quad \text{as } |z| \rightarrow \infty, \quad |\arg(z)| < \pi.$$

The Wronskian of  $J_\nu(z)$  and  $J_{-\nu}(z)$  is

$$W(z) = -\frac{2}{\pi z} \sin(\pi\nu).$$

Thus  $J_\nu(z)$  and  $J_{-\nu}(z)$  are independent when  $\nu$  is not an integer. The Bessel functions satisfy the recursion relations,

$$\begin{aligned} J_{\nu-1} + J_{\nu+1} &= \frac{2\nu}{z} J_\nu & J'_\nu &= \frac{\nu}{z} J_\nu - J_{\nu+1} \\ J'_\nu &= \frac{1}{2}(J_{\nu-1} - J_{\nu+1}) & J'_\nu &= J_{\nu-1} - \frac{\nu}{z} J_\nu. \end{aligned}$$

### 34.3.5 Bessel Functions of Half-Integer Order

Consider  $J_{1/2}(z)$ . Start with the series expansion

$$J_{1/2}(z) = \sum_{m=0}^{\infty} \frac{(-1)^m}{m! \Gamma(1/2 + m + 1)} \left(\frac{z}{2}\right)^{1/2+2m}.$$

Use the identity  $\Gamma(n + 1/2) = \frac{(1)(3)\cdots(2n-1)}{2^n} \sqrt{\pi}$ .

$$\begin{aligned} &= \sum_{m=0}^{\infty} \frac{(-1)^m 2^{m+1}}{m!(1)(3)\cdots(2m+1)\sqrt{\pi}} \left(\frac{z}{2}\right)^{1/2+2m} \\ &= \sum_{m=0}^{\infty} \frac{(-1)^m 2^{m+1}}{(2)(4)\cdots(2m) \cdot (1)(3)\cdots(2m+1)\sqrt{\pi}} \left(\frac{1}{2}\right)^{1/2+m} z^{1/2+2m} \\ &= \left(\frac{2}{\pi z}\right)^{1/2} \sum_{m=0}^{\infty} \frac{(-1)^m}{(2m+1)!} z^{2m+1} \end{aligned}$$

We recognize the sum as the Taylor series expansion of  $\sin z$ .

$$= \left(\frac{2}{\pi z}\right)^{1/2} \sin z$$

Using the recurrence relations,

$$J_{\nu+1} = \frac{\nu}{z} J_{\nu} - J'_{\nu} \quad \text{and} \quad J_{\nu-1} = \frac{\nu}{z} J_{\nu} + J'_{\nu},$$

we can find  $J_{n+1/2}$  for any integer  $n$ .

**Example 34.3.1** To find  $J_{3/2}(z)$ ,

$$\begin{aligned}
 J_{3/2}(z) &= \frac{1/2}{z} J_{1/2}(z) - J'_{1/2}(z) \\
 &= \frac{1/2}{z} \left(\frac{2}{\pi}\right)^{1/2} z^{-1/2} \sin z - \left(-\frac{1}{2}\right) \left(\frac{2}{\pi}\right)^{1/2} z^{-3/2} \sin z - \left(\frac{2}{\pi}\right)^{1/2} z^{-1/2} \cos z \\
 &= 2^{-1/2} \pi^{-1/2} z^{-3/2} \sin z + 2^{-1/2} \pi^{-1/2} z^{-3/2} \sin z - 2^{-1/2} \pi^{-1/2} \cos z \\
 &= \left(\frac{2}{\pi}\right)^{1/2} z^{-3/2} \sin z - \left(\frac{2}{\pi}\right)^{1/2} z^{-1/2} \cos z \\
 &= \left(\frac{2}{\pi}\right)^{1/2} (z^{-3/2} \sin z - z^{-1/2} \cos z).
 \end{aligned}$$

You can show that

$$J_{-1/2}(z) = \left(\frac{2}{\pi z}\right)^{1/2} \cos z.$$

Note that at a first glance it appears that  $J_{3/2} \sim z^{-1/2}$  as  $z \rightarrow 0$ . However, if you expand the sine and cosine you will see that the  $z^{-1/2}$  and  $z^{1/2}$  terms vanish and thus  $J_{3/2}(z) \sim z^{3/2}$  as  $z \rightarrow 0$  as we showed previously.

Recall that we showed the asymptotic behavior as  $x \rightarrow +\infty$  of Bessel functions to be linear combinations of

$$x^{-1/2} \sin(x + U_1(x)) \quad \text{and} \quad x^{-1/2} \cos(x + U_2(x))$$

where  $U_1, U_2 \rightarrow 0$  as  $x \rightarrow +\infty$ .

## 34.4 Neumann Expansions

Consider expanding an analytic function in a series of Bessel functions of the form

$$f(z) = \sum_{n=0}^{\infty} a_n J_n(z).$$



If  $f(z)$  is analytic in the disk  $|z| \leq r$  then we can write

$$f(z) = \frac{1}{i2\pi} \oint \frac{f(\zeta)}{\zeta - z} d\zeta,$$

where the path of integration is  $|\zeta| = r$  and  $|z| < r$ . If we were able to expand the function  $\frac{1}{\zeta - z}$  in a series of Bessel functions, then we could interchange the order of summation and integration to get a Bessel series expansion of  $f(z)$ .

**The Expansion of  $1/(\zeta - z)$ .** Assume that  $\frac{1}{\zeta - z}$  has the uniformly convergent expansion

$$\frac{1}{\zeta - z} = c_0(\zeta)J_0(z) + 2 \sum_{n=1}^{\infty} c_n(\zeta)J_n(z),$$

where each  $c_n(\zeta)$  is analytic. Note that

$$\left( \frac{\partial}{\partial \zeta} + \frac{\partial}{\partial z} \right) \frac{1}{\zeta - z} = \frac{-1}{(\zeta - z)^2} + \frac{1}{(\zeta - z)^2} = 0.$$

Thus we have

$$\begin{aligned} \left( \frac{\partial}{\partial \zeta} + \frac{\partial}{\partial z} \right) \left[ c_0(\zeta)J_0(z) + 2 \sum_{n=1}^{\infty} c_n(\zeta)J_n(z) \right] &= 0 \\ \left[ c'_0 J_0 + 2 \sum_{n=1}^{\infty} c'_n J_n \right] + \left[ c_0 J'_0 + 2 \sum_{n=1}^{\infty} c_n J'_n \right] &= 0. \end{aligned}$$

Using the identity  $2J'_n = J_{n-1} - J_{n+1}$ ,

$$\left[ c'_0 J_0 + 2 \sum_{n=1}^{\infty} c'_n J_n \right] + \left[ c_0 (-J_1) + \sum_{n=1}^{\infty} c_n (J_{n-1} - J_{n+1}) \right] = 0.$$

Collecting coefficients of  $J_n$ ,

$$(c'_0 + c_1)J_0 + \sum_{n=1}^{\infty} (2c'_n + c_{n+1} - c_{n-1})J_n = 0.$$

Equating the coefficients of  $J_n$ , we see that the  $c_n$  are given by the relations,

$$c_1 = -c'_0, \quad \text{and} \quad c_{n+1} = c_{n-1} - 2c'_n.$$

We can evaluate  $c_0(\zeta)$ . Setting  $z = 0$ ,

$$\begin{aligned} \frac{1}{\zeta} &= c_0(\zeta)J_0(0) + 2 \sum_{n=1}^{\infty} c_n(\zeta)J_n(0) \\ \frac{1}{\zeta} &= c_0(\zeta). \end{aligned}$$

Using the recurrence relations we can calculate the  $c_n$ 's. The first few are:

$$\begin{aligned} c_1 &= -\frac{-1}{\zeta^2} = \frac{1}{\zeta^2} \\ c_2 &= \frac{1}{\zeta} - 2\frac{-2}{\zeta^3} = \frac{1}{\zeta} + \frac{4}{\zeta^3} \\ c_3 &= \frac{1}{\zeta^2} - 2\left(\frac{-1}{\zeta^2} - \frac{12}{\zeta^4}\right) = \frac{3}{\zeta^2} + \frac{24}{\zeta^4}. \end{aligned}$$

We see that  $c_n$  is a polynomial of degree  $n + 1$  in  $1/\zeta$ . One can show that

$$c_n(\zeta) = \begin{cases} \frac{2^{n-1}n!}{\zeta^{n+1}} \left( 1 + \frac{\zeta^2}{2(2n-2)} + \frac{\zeta^4}{2 \cdot 4 \cdot (2n-2)(2n-4)} + \cdots + \frac{\zeta^n}{2 \cdot 4 \cdots n \cdot (2n-2) \cdots (2n-n)} \right) & \text{for even } n \\ \frac{2^{n-1}n!}{\zeta^{n+1}} \left( 1 + \frac{\zeta^2}{2(2n-2)} + \frac{\zeta^4}{2 \cdot 4 \cdot (2n-2)(2n-4)} + \cdots + \frac{\zeta^{n-1}}{2 \cdot 4 \cdots (n-1) \cdot (2n-2) \cdots (2n-(n-1))} \right) & \text{for odd } n \end{cases}$$

**Uniform Convergence of the Series.** We assumed before that the series expansion of  $\frac{1}{\zeta-z}$  is uniformly convergent. The behavior of  $c_n$  and  $J_n$  are

$$c_n(\zeta) = \frac{2^{n-1}n!}{\zeta^{n+1}} + O(\zeta^{-n}), \quad J_n(z) = \frac{z^n}{2^n n!} + O(z^{n+1}).$$

This gives us

$$c_n(\zeta)J_n(z) = \frac{1}{2\zeta} \left(\frac{z}{\zeta}\right)^n + \mathcal{O}\left(\frac{1}{\zeta} \left(\frac{z}{\zeta}\right)^{n+1}\right).$$

If  $\left|\frac{z}{\zeta}\right| = \rho < 1$  we can bound the series with the geometric series  $\sum \rho^n$ . Thus the series is uniformly convergent.

**Neumann Expansion of an Analytic Function.** Let  $f(z)$  be a function that is analytic in the disk  $|z| \leq r$ . Consider  $|z| < r$  and the path of integration along  $|\zeta| = r$ . Cauchy's integral formula tells us that

$$f(z) = \frac{1}{i2\pi} \oint \frac{f(\zeta)}{\zeta - z} d\zeta.$$

Substituting the expansion for  $\frac{1}{\zeta-z}$ ,

$$\begin{aligned} &= \frac{1}{i2\pi} \oint f(\zeta) \left( c_0(\zeta)J_0(z) + 2 \sum_{n=1}^{\infty} c_n(\zeta)J_n(z) \right) d\zeta \\ &= J_0(z) \frac{1}{i2\pi} \oint \frac{f(\zeta)}{\zeta} d\zeta + \sum_{n=1}^{\infty} \frac{J_n(z)}{i\pi} \oint c_n(\zeta) f(\zeta) d\zeta \\ &= J_0(z)f(0) + \sum_{n=1}^{\infty} \frac{J_n(z)}{i\pi} \oint c_n(\zeta) f(\zeta) d\zeta. \end{aligned}$$

**Result 34.4.1** let  $f(z)$  be analytic in the disk,  $|z| \leq r$ . Consider  $|z| < r$  and the path of integration along  $|\zeta| = r$ .  $f(z)$  has the Bessel function series expansion

$$f(z) = J_0(z)f(0) + \sum_{n=1}^{\infty} \frac{J_n(z)}{i\pi} \oint c_n(\zeta)f(\zeta) d\zeta,$$

where the  $c_n$  satisfy

$$\frac{1}{\zeta - z} = c_0(\zeta)J_0(z) + 2 \sum_{n=1}^{\infty} c_n(\zeta)J_n(z).$$

## 34.5 Bessel Functions of the Second Kind

When  $\nu$  is an integer,  $J_\nu$  and  $J_{-\nu}$  are not linearly independent. In order to find an second linearly independent solution, we define the Bessel function of the second kind, (also called **Weber's function**),

$$Y_\nu = \begin{cases} \frac{J_\nu(z) \cos(\nu\pi) - J_{-\nu}(z)}{\sin(\nu\pi)} & \text{when } \nu \text{ is not an integer} \\ \lim_{\mu \rightarrow \nu} \frac{J_\mu(z) \cos(\mu\pi) - J_{-\mu}(z)}{\sin(\mu\pi)} & \text{when } \nu \text{ is an integer.} \end{cases}$$

$J_\nu$  and  $Y_\nu$  are linearly independent for all  $\nu$ .

In Figure 34.3  $Y_0$  and  $Y_1$  are plotted in solid and dashed lines, respectively.

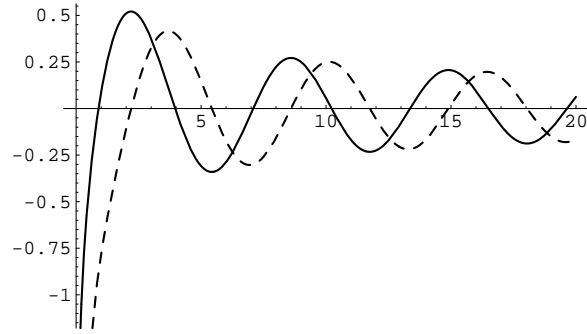

Figure 34.3: Bessel Functions of the Second Kind

**Result 34.5.1** The Bessel function of the second kind,  $Y_\nu(z)$ , is defined,

$$Y_\nu = \begin{cases} \frac{J_\nu(z) \cos(\nu\pi) - J_{-\nu}(z)}{\sin(\nu\pi)} & \text{when } \nu \text{ is not an integer} \\ \lim_{\mu \rightarrow \nu} \frac{J_\mu(z) \cos(\mu\pi) - J_{-\mu}(z)}{\sin(\mu\pi)} & \text{when } \nu \text{ is an integer.} \end{cases}$$

The Wronskian of  $J_\nu(z)$  and  $Y_\nu(z)$  is

$$W[J_\nu, Y_\nu] = \frac{2}{\pi z}.$$

Thus  $J_\nu(z)$  and  $Y_\nu(z)$  are independent for all  $\nu$ . The Bessel functions of the second kind satisfy the recursion relations,

$$Y_{\nu+1} + Y_{\nu-1} = \frac{2\nu}{z} Y_\nu, \quad Y'_{\nu+1} - Y'_{\nu-1} = \frac{\nu}{z} Y_\nu - Y_\nu$$

## 34.6 Hankel Functions

Another set of solutions to Bessel's equation is the Hankel functions,

$$\begin{aligned}H_{\nu}^{(1)}(z) &= J_{\nu}(z) + iY_{\nu}(z), \\H_{\nu}^{(2)}(z) &= J_{\nu}(z) - iY_{\nu}(z)\end{aligned}$$

**Result 34.6.1** The Hankel functions are defined

$$\begin{aligned}H_{\nu}^{(1)}(z) &= J_{\nu}(z) + iY_{\nu}(z), \\H_{\nu}^{(2)}(z) &= J_{\nu}(z) - iY_{\nu}(z)\end{aligned}$$

The Wronskian of  $H_{\nu}^{(1)}(z)$  and  $H_{\nu}^{(2)}(z)$  is

$$W[H_{\nu}^{(1)}, H_{\nu}^{(2)}] = -\frac{i4}{\pi z}.$$

The Hankel functions are independent for all  $\nu$ . The Hankel functions satisfy the same recurrence relations as the other Bessel functions.

## 34.7 The Modified Bessel Equation

The modified Bessel equation is

$$w'' + \frac{1}{z}w' - \left(1 + \frac{\nu^2}{z^2}\right)w = 0.$$

This equation is identical to the Bessel equation except for a sign change in the last term. If we make the change of variables  $\xi = \imath z$ ,  $u(\xi) = w(z)$  we obtain the equation

$$-u'' - \frac{1}{\xi}u' - \left(1 - \frac{\nu^2}{\xi^2}\right)u = 0$$

$$u'' + \frac{1}{\xi}u' + \left(1 - \frac{\nu^2}{\xi^2}\right)u = 0.$$

This is the Bessel equation. Thus  $J_\nu(\imath z)$  is a solution to the modified Bessel equation. This motivates us to define the modified Bessel function of the first kind

$$I_\nu(z) = \imath^{-\nu} J_\nu(\imath z).$$

Since  $J_\nu$  and  $J_{-\nu}$  are linearly independent solutions when  $\nu$  is not an integer,  $I_\nu$  and  $I_{-\nu}$  are linearly independent solutions to the modified Bessel equation when  $\nu$  is not an integer.

The Taylor series expansion of  $I_\nu(z)$  about  $z = 0$  is

$$\begin{aligned} I_\nu(z) &= \imath^{-\nu} J_\nu(\imath z) \\ &= \imath^{-\nu} \sum_{m=0}^{\infty} \frac{(-1)^m}{m! \Gamma(\nu + m + 1)} \left(\frac{\imath z}{2}\right)^{\nu+2m} \\ &= \imath^{-\nu} \sum_{m=0}^{\infty} \frac{(-1)^m \imath^\nu \imath^{2m}}{m! \Gamma(\nu + m + 1)} \left(\frac{z}{2}\right)^{\nu+2m} \\ &= \sum_{m=0}^{\infty} \frac{1}{m! \Gamma(\nu + m + 1)} \left(\frac{z}{2}\right)^{\nu+2m} \end{aligned}$$

**Modified Bessel Functions of the Second Kind.** In order to have a second linearly independent solution when  $\nu$  is an integer, we define the modified Bessel function of the second kind

$$K_\nu(z) = \begin{cases} \frac{\pi}{2} \frac{I_{-\nu} - I_\nu}{\sin(\nu\pi)} & \text{when } \nu \text{ is not an integer,} \\ \lim_{\mu \rightarrow \nu} \frac{\pi}{2} \frac{I_{-\mu} - I_\mu}{\sin(\mu\pi)} & \text{when } \nu \text{ is an integer.} \end{cases}$$

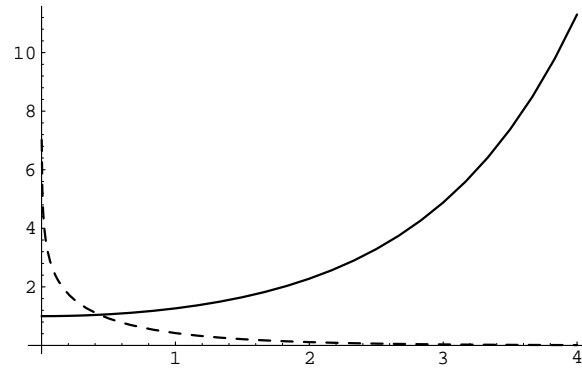

Figure 34.4: Modified Bessel Functions

$I_\nu$  and  $K_\nu$  are linearly independent for all  $\nu$ . In Figure 34.4  $I_0$  and  $K_0$  are plotted in solid and dashed lines, respectively.



**Result 34.7.1** The modified Bessel functions of the first and second kind,  $I_\nu(z)$  and  $K_\nu(z)$ , are defined,

$$I_\nu(z) = i^{-\nu} J_\nu(iz).$$

$$K_\nu(z) = \begin{cases} \frac{\pi}{2} \frac{I_{-\nu} - I_\nu}{\sin(\nu\pi)} & \text{when } \nu \text{ is not an integer,} \\ \lim_{\mu \rightarrow \nu} \frac{\pi}{2} \frac{I_{-\mu} - I_\mu}{\sin(\mu\pi)} & \text{when } \nu \text{ is an integer.} \end{cases}$$

The modified Bessel function of the first kind has the expansion,

$$I_\nu(z) = \sum_{m=0}^{\infty} \frac{1}{m! \Gamma(\nu + m + 1)} \left(\frac{z}{2}\right)^{\nu+2m}$$

The Wronskian of  $I_\nu(z)$  and  $I_{-\nu}(z)$  is

$$W[I_\nu, I_{-\nu}] = -\frac{2}{\pi z} \sin(\pi\nu).$$

$I_\nu(z)$  and  $I_{-\nu}(z)$  are linearly independent when  $\nu$  is not an integer. The Wronskian of  $I_\nu(z)$  and  $K_\nu(z)$  is

$$W[I_\nu, K_\nu] = -\frac{1}{z}.$$

$I_\nu(z)$  and  $K_\nu(z)$  are independent for all  $\nu$ . The modified Bessel functions satisfy the recursion relations,

$$\begin{aligned} A_{\nu-1} - A_{\nu+1} &= \frac{2\nu}{z} A_\nu & A'_\nu &= A_{\nu+1} + \frac{\nu}{z} A_\nu \\ A'_\nu &= \frac{1}{2}(A_{\nu-1} + A_{\nu+1}) & A'_\nu &= A_{\nu-1} - \frac{\nu}{z} A_\nu. \end{aligned}$$

where  $A$  stands for either  $I$  or  $K$ .

## 34.8 Exercises

### Exercise 34.1

Consider Bessel's equation

$$z^2 y''(z) + zy'(z) + (z^2 - \nu^2) y = 0$$

where  $\nu \geq 0$ . Find the Frobenius series solution that is asymptotic to  $t^\nu$  as  $t \rightarrow 0$ . By multiplying this solution by a constant, define the solution

$$J_\nu(z) = \sum_{k=1}^{\infty} \frac{(-1)^k}{k! \Gamma(k + \nu + 1)} \left(\frac{z}{2}\right)^{2k + \nu}.$$

This is called the Bessel function of the first kind and order  $\nu$ . Clearly  $J_{-\nu}(z)$  is defined and is linearly independent to  $J_\nu(z)$  if  $\nu$  is not an integer. What happens when  $\nu$  is an integer?

### Exercise 34.2

Consider Bessel's equation for integer  $n$ ,

$$z^2 y'' + zy' + (z^2 - n^2) y = 0.$$

Using the kernel

$$K(z, t) = e^{\frac{1}{2}z(t - \frac{1}{t})},$$

find two solutions of Bessel's equation. (For  $n = 0$  you will find only one solution.) Are the two solutions linearly independent? Define the Bessel function of the first kind and order  $n$ ,

$$J_n(z) = \frac{1}{i2\pi} \oint_C t^{-n-1} e^{\frac{1}{2}z(t-1/t)} dt,$$

where  $C$  is a simple, closed contour about the origin. Verify that

$$e^{\frac{1}{2}z(t-1/t)} = \sum_{n=-\infty}^{\infty} J_n(z) t^n.$$

This is the *generating function* for the Bessel functions.

**Exercise 34.3**

Use the generating function

$$e^{\frac{1}{2}z(t-1/t)} = \sum_{n=-\infty}^{\infty} J_n(z)t^n$$

to show that  $J_n$  satisfies Bessel's equation

$$z^2 y'' + zy' + (z^2 - n^2)y = 0.$$

**Exercise 34.4**

Using

$$J_{n-1} + J_{n+1} = \frac{2n}{z} J_n \quad \text{and} \quad J'_n = \frac{n}{z} J_n - J_{n+1},$$

show that

$$J'_n = \frac{1}{2}(J_{n-1} - J_{n+1}) \quad \text{and} \quad J'_n = J_{n-1} - \frac{n}{z} J_n.$$

**Exercise 34.5**

Find the general solution of

$$w'' + \frac{1}{z}w' + \left(1 - \frac{1}{4z^2}\right)w = z.$$

**Exercise 34.6**

Show that  $J_\nu(z)$  and  $Y_\nu(z)$  are linearly independent for all  $\nu$ .

**Exercise 34.7**

Compute  $W[I_\nu, I_{-\nu}]$  and  $W[I_\nu, K_\nu]$ .

**Exercise 34.8**

Using the generating function,

$$\exp\left[\frac{z}{2}\left(t - \frac{1}{t}\right)\right] = \sum_{n=-\infty}^{+\infty} J_n(z)t^n,$$

verify the following identities:

1.

$$\frac{2n}{z} J_n(z) = J_{n-1}(z) + J_{n+1}(z).$$

This relation is useful for recursively computing the values of the higher order Bessel functions.

2.

$$J'_n(z) = \frac{1}{2} (J_{n-1}(z) - J_{n+1}(z)).$$

This relation is useful for computing the derivatives of the Bessel functions once you have the values of the Bessel functions of adjacent order.

3.

$$\frac{d}{dz} (z^{-n} J_n(z)) = -z^{-n} J_{n+1}(z).$$

### Exercise 34.9

Use the Wronskian of  $J_\nu(z)$  and  $J_{-\nu}(z)$ ,

$$W [J_\nu(z), J_{-\nu}(z)] = -\frac{2 \sin \nu\pi}{\pi z},$$

to derive the identity

$$J_{-\nu+1}(z)J_\nu(z) + J_{-\nu}(z)J_{\nu-1}(z) = \frac{2}{\pi z} \sin \nu\pi.$$

### Exercise 34.10

Show that, using the generating function or otherwise,

$$J_0(z) + 2J_2(z) + 2J_4(z) + 2J_6(z) + \cdots = 1$$

$$J_0(z) - 2J_2(z) + 2J_4(z) - 2J_6(z) + \cdots = \cos z$$

$$2J_1(z) - 2J_3(z) + 2J_5(z) - \cdots = \sin z$$

$$J_0^2(z) + 2J_1^2(z) + 2J_2^2(z) + 2J_3^2(z) + \cdots = 1$$

**Exercise 34.11**

It is often possible to “solve” certain ordinary differential equations by converting them into the Bessel equation by means of various transformations. For example, show that the solution of

$$y'' + x^{p-2}y = 0,$$

can be written in terms of Bessel functions.

$$y(x) = c_1 x^{1/2} J_{1/p} \left( \frac{2}{p} x^{p/2} \right) + c_2 x^{1/2} Y_{1/p} \left( \frac{2}{p} x^{p/2} \right)$$

Here  $c_1$  and  $c_2$  are arbitrary constants. Thus show that the Airy equation,

$$y'' + xy = 0,$$

can be solved in terms of Bessel functions.

**Exercise 34.12**

The spherical Bessel functions are defined by

$$j_n(z) = \sqrt{\frac{\pi}{2z}} J_{n+1/2}(z),$$

$$y_n(z) = \sqrt{\frac{\pi}{2z}} Y_{n+1/2}(z),$$

$$k_n(z) = \sqrt{\frac{\pi}{2z}} K_{n+1/2}(z),$$

$$i_n(z) = \sqrt{\frac{\pi}{2z}} I_{n+1/2}(z).$$

Show that

$$j_1(z) = \frac{\sin z}{z^2} - \frac{\cos z}{z},$$

$$i_0(z) = \frac{\sinh z}{z},$$

$$k_0(z) = \frac{\pi}{2z} \exp(-z).$$

**Exercise 34.13**

Show that as  $x \rightarrow \infty$ ,

$$K_n(x) \propto \frac{e^{-x}}{\sqrt{x}} \left( 1 + \frac{4n^2 - 1}{8x} + \frac{(4n^2 - 1)(4n^2 - 9)}{128x^2} + \cdots \right).$$

## 34.9 Hints

### Hint 34.2

### Hint 34.3

### Hint 34.4

Use the generating function

$$e^{\frac{1}{2}z(t-1/t)} = \sum_{n=-\infty}^{\infty} J_n(z)t^n$$

to show that  $J_n$  satisfies Bessel's equation

$$z^2 y'' + zy' + (z^2 - n^2)y = 0.$$

### Hint 34.6

Use variation of parameters and the Wronskian that was derived in the text.

### Hint 34.7

Compute the Wronskian of  $J_\nu(z)$  and  $Y_\nu(z)$ . Use the relation

$$W[J_\nu, J_{-\nu}] = -\frac{2}{\pi z} \sin(\pi\nu)$$

### Hint 34.8

Derive  $W[I_\nu, I_{-\nu}]$  from the value of  $W[J_\nu, J_{-\nu}]$ . Derive  $W[I_\nu, K_\nu]$  from the value of  $W[I_\nu, I_{-\nu}]$ .

### Hint 34.9

### Hint 34.10

**Hint 34.11**

**Hint 34.12**

**Hint 34.13**

**Hint 34.14**



## 34.10 Solutions

### Solution 34.1

Bessel's equation is

$$L[y] \equiv z^2 y'' + zy' + (z^2 - n^2)y = 0.$$

We consider a solution of the form

$$y(z) = \int_C e^{\frac{1}{2}z(t-1/t)} v(t) dt.$$

We substitute the form of the solution into Bessel's equation.

$$\begin{aligned} & \int_C L \left[ e^{\frac{1}{2}z(t-1/t)} \right] v(t) dt = 0 \\ & \int_C \left( z^2 \frac{1}{4} \left( t + \frac{1}{t} \right)^2 + z \frac{1}{2} \left( t - \frac{1}{t} \right)^2 + (z^2 - n^2) \right) e^{\frac{1}{2}z(t-1/t)} v(t) dt = 0 \end{aligned} \quad (34.1)$$

By considering

$$\begin{aligned} \frac{d}{dt} t e^{\frac{1}{2}z(t-1/t)} &= \left( \frac{1}{2}x \left( t + \frac{1}{t} \right) + 1 \right) e^{\frac{1}{2}z(t-1/t)} \\ \frac{d^2}{dt^2} t^2 e^{\frac{1}{2}z(t-1/t)} &= \left( \frac{1}{4}x^2 \left( t + \frac{1}{t} \right)^2 + x \left( 2t + \frac{1}{t} \right) + 2 \right) e^{\frac{1}{2}z(t-1/t)} \end{aligned}$$

we see that

$$L \left[ e^{\frac{1}{2}z(t-1/t)} \right] = \left( \frac{d^2}{dt^2} t^2 - 3 \frac{d}{dt} t + (1 - n^2) \right) e^{\frac{1}{2}z(t-1/t)}.$$

Thus Equation 34.1 becomes

$$\int_C \left( \frac{d^2}{dt^2} t^2 e^{\frac{1}{2}z(t-1/t)} - 3 \frac{d}{dt} t e^{\frac{1}{2}z(t-1/t)} + (1 - n^2) e^{\frac{1}{2}z(t-1/t)} \right) v(t) dt = 0$$

We apply integration by parts to move derivatives from the kernel to  $v(t)$ .

$$\begin{aligned} & \left[ t^2 e^{\frac{1}{2}z(t-1/t)} v(t) \right]_C - \left[ t e^{\frac{1}{2}z(t-1/t)} v'(t) \right]_C + \left[ -3t e^{\frac{1}{2}z(t-1/t)} v(t) \right]_C + \int_C e^{\frac{1}{2}z(t-1/t)} (t^2 v''(t) + 3tv(t) + (1-n^2)v(t)) dt = \\ & \left[ e^{\frac{1}{2}z(t-1/t)} ((t^2 - 3t)v(t) - tv'(t)) \right]_C + \int_C e^{\frac{1}{2}z(t-1/t)} (t^2 v''(t) + 3tv(t) + (1-n^2)v(t)) dt = 0 \end{aligned}$$

In order that the integral vanish,  $v(t)$  must be a solution of the differential equation

$$t^2 v'' + 3tv + (1-n^2)v = 0.$$

This is an Euler equation with the solutions  $\{t^{n-1}, t^{-n-1}\}$  for non-zero  $n$  and  $\{t^{-1}, t^{-1} \log t\}$  for  $n = 0$ .

Consider the case of non-zero  $n$ . Since

$$e^{\frac{1}{2}z(t-1/t)} ((t^2 - 3t)v(t) - tv'(t))$$

is single-valued and analytic for  $t \neq 0$  for the functions  $v(t) = t^{n-1}$  and  $v(t) = t^{-n-1}$ , the boundary term will vanish if  $C$  is any closed contour that does not pass through the origin. Note that the integrand in our solution,

$$e^{\frac{1}{2}z(t-1/t)} v(t),$$

is analytic and single-valued except at the origin and infinity where it has essential singularities. Consider a simple closed contour that does not enclose the origin. The integral along such a path would vanish and give us  $y(z) = 0$ . This is not an interesting solution. Since

$$e^{\frac{1}{2}z(t-1/t)} v(t),$$

has non-zero residues for  $v(t) = t^{n-1}$  and  $v(t) = t^{-n-1}$ , choosing any simple, positive, closed contour about the origin will give us a non-trivial solution of Bessel's equation. These solutions are

$$y_1(t) = \int_C t^{n-1} e^{\frac{1}{2}z(t-1/t)} dt, \quad y_2(t) = \int_C t^{-n-1} e^{\frac{1}{2}z(t-1/t)} dt.$$

Now consider the case  $n = 0$ . The two solutions above coincide and we have the solution

$$y(t) = \int_C t^{-1} e^{\frac{1}{2}z(t-1/t)} dt.$$

Choosing  $v(t) = t^{-1} \log t$  would make both the boundary terms and the integrand multi-valued. We do not pursue the possibility of a solution of this form.

The solution  $y_1(t)$  and  $y_2(t)$  are not linearly independent. To demonstrate this we make the change of variables  $t \rightarrow -1/t$  in the integral representation of  $y_1(t)$ .

$$\begin{aligned} y_1(t) &= \int_C t^{n-1} e^{\frac{1}{2}z(t-1/t)} dt \\ &= \int_C (-1/t)^{n-1} e^{\frac{1}{2}z(-1/t+t)} \frac{-1}{t^2} dt \\ &= \int_C (-1)^n t^{-n-1} e^{\frac{1}{2}z(t-1/t)} dt \\ &= (-1)^n y_2(t) \end{aligned}$$

Thus we see that a solution of Bessel's equation for integer  $n$  is

$$y(t) = \int_C t^{-n-1} e^{\frac{1}{2}z(t-1/t)} dt$$

where  $C$  is any simple, closed contour about the origin.

Therefore, the Bessel function of the first kind and order  $n$ ,

$$J_n(z) = \frac{1}{i2\pi} \oint_C t^{-n-1} e^{\frac{1}{2}z(t-1/t)} dt$$

is a solution of Bessel's equation for integer  $n$ . Note that  $J_n(z)$  is the coefficient of  $t^n$  in the Laurent series of  $e^{\frac{1}{2}z(t-1/t)}$ . This establishes the generating function for the Bessel functions.

$$e^{\frac{1}{2}z(t-1/t)} = \sum_{n=-\infty}^{\infty} J_n(z) t^n$$

### Solution 34.2

The generating function is

$$e^{\frac{z}{2}(t-1/t)} = \sum_{n=-\infty}^{\infty} J_n(z)t^n.$$

In order to show that  $J_n$  satisfies Bessel's equation we seek to show that

$$\sum_{n=-\infty}^{\infty} (z^2 J_n''(z) + z J_n'(z) + (z^2 - n^2) J_n(z)) t^n = 0.$$

To get the appropriate terms in the sum we will differentiate the generating function with respect to  $z$  and  $t$ . First we differentiate it with respect to  $z$ .

$$\frac{1}{2} \left( t - \frac{1}{t} \right) e^{\frac{z}{2}(t-1/t)} = \sum_{n=-\infty}^{\infty} J_n'(z) t^n$$

$$\frac{1}{4} \left( t - \frac{1}{t} \right)^2 e^{\frac{z}{2}(t-1/t)} = \sum_{n=-\infty}^{\infty} J_n''(z) t^n$$

Now we differentiate with respect to  $t$  and multiply by  $t$  get the  $n^2 J_n$  term.

$$\frac{z}{2} \left( 1 + \frac{1}{t^2} \right) e^{\frac{z}{2}(t-1/t)} = \sum_{n=-\infty}^{\infty} n J_n(z) t^{n-1}$$

$$\frac{z}{2} \left( t + \frac{1}{t} \right) e^{\frac{z}{2}(t-1/t)} = \sum_{n=-\infty}^{\infty} n J_n(z) t^n$$

$$\frac{z}{2} \left( 1 - \frac{1}{t^2} \right) e^{\frac{z}{2}(t-1/t)} + \frac{z^2}{4} \left( t + \frac{1}{t} \right)^2 e^{\frac{z}{2}(t-1/t)} = \sum_{n=-\infty}^{\infty} n^2 J_n(z) t^{n-1}$$

$$\frac{z}{2} \left( t - \frac{1}{t} \right) e^{\frac{z}{2}(t-1/t)} + \frac{z^2}{4} \left( t + \frac{1}{t} \right)^2 e^{\frac{z}{2}(t-1/t)} = \sum_{n=-\infty}^{\infty} n^2 J_n(z) t^n$$

Now we can evaluate the desired sum.

$$\begin{aligned} \sum_{n=-\infty}^{\infty} (z^2 J_n''(z) + zJ_n(z) + (z^2 - n^2) J_n(z)) t^n \\ = \left( \frac{z^2}{4} \left( t - \frac{1}{t} \right)^2 + \frac{z}{2} \left( t - \frac{1}{t} \right) + z^2 - \frac{z}{2} \left( t - \frac{1}{t} \right) - \frac{z^2}{4} \left( t + \frac{1}{t} \right)^2 \right) e^{\frac{z}{2}(t-1/t)} \end{aligned}$$

$$\sum_{n=-\infty}^{\infty} (z^2 J_n''(z) + zJ_n(z) + (z^2 - n^2) J_n(z)) t^n = 0$$

$$\boxed{z^2 J_n''(z) + zJ_n(z) + (z^2 - n^2) J_n(z) = 0}$$

Thus  $J_n$  satisfies Bessel's equation.

### Solution 34.3

$$\begin{aligned} J_n' &= \frac{n}{z} J_n - J_{n+1} \\ &= \frac{1}{2}(J_{n-1} + J_{n+1}) - J_{n+1} \\ &= \frac{1}{2}(J_{n-1} - J_{n+1}) \end{aligned}$$

$$\begin{aligned} J_n' &= \frac{n}{z} J_n - J_{n+1} \\ &= \frac{n}{z} J_n - \left( \frac{2n}{z} J_n - J_{n-1} \right) \\ &= J_{n-1} - \frac{n}{z} J_n \end{aligned}$$

**Solution 34.4**

The linearly independent homogeneous solutions are  $J_{1/2}$  and  $J_{-1/2}$ . The Wronskian is

$$W[J_{1/2}, J_{-1/2}] = -\frac{2}{\pi z} \sin(\pi/2) = -\frac{2}{\pi z}.$$

Using variation of parameters, a particular solution is

$$\begin{aligned} y_p &= -J_{1/2}(z) \int^z \frac{\zeta J_{-1/2}(\zeta)}{-2/\pi\zeta} d\zeta + J_{-1/2}(z) \int^z \frac{\zeta J_{1/2}(\zeta)}{-2/\pi\zeta} d\zeta \\ &= \frac{\pi}{2} J_{1/2}(z) \int^z \zeta^2 J_{-1/2}(\zeta) d\zeta - \frac{\pi}{2} J_{-1/2}(z) \int^z \zeta^2 J_{1/2}(\zeta) d\zeta. \end{aligned}$$

Thus the general solution is

$$y = c_1 J_{1/2}(z) + c_2 J_{-1/2}(z) + \frac{\pi}{2} J_{1/2}(z) \int^z \zeta^2 J_{-1/2}(\zeta) d\zeta - \frac{\pi}{2} J_{-1/2}(z) \int^z \zeta^2 J_{1/2}(\zeta) d\zeta.$$

We could substitute

$$J_{1/2}(z) = \left(\frac{2}{\pi z}\right)^{1/2} \sin z \quad \text{and} \quad J_{-1/2}(z) = \left(\frac{2}{\pi z}\right)^{1/2} \cos z$$

into the solution, but we cannot evaluate the integrals in terms of elementary functions. (You can write the solution in terms of Fresnel integrals.)

**Solution 34.5**

$$\begin{aligned}
W [J_\nu, Y_\nu] &= \begin{vmatrix} J_\nu & J_\nu \cot(\nu\pi) - J_{-\nu} \csc(\nu\pi) \\ J'_\nu & J'_\nu \cot(\nu\pi) - J'_{-\nu} \csc(\nu\pi) \end{vmatrix} \\
&= \cot(\nu\pi) \begin{vmatrix} J_\nu & J_\nu \\ J'_\nu & J'_\nu \end{vmatrix} - \csc(\nu\pi) \begin{vmatrix} J_\nu & J_{-\nu} \\ J'_\nu & J'_{-\nu} \end{vmatrix} \\
&= -\csc(\nu\pi) \frac{-2}{\pi z} \sin(\pi\nu) \\
&= \frac{2}{\pi z}
\end{aligned}$$

Since the Wronskian does not vanish identically, the functions are independent for all values of  $\nu$ .

**Solution 34.6**

$$I_\nu(z) = i^{-\nu} J_\nu(iz)$$

$$\begin{aligned}
W [I_\nu, I_{-\nu}] &= \begin{vmatrix} I_\nu & I_{-\nu} \\ I'_\nu & I'_{-\nu} \end{vmatrix} \\
&= \begin{vmatrix} i^{-\nu} J_\nu(iz) & i^\nu J_{-\nu}(iz) \\ i^{-\nu} i J'_\nu(iz) & i^\nu i J'_{-\nu}(iz) \end{vmatrix} \\
&= i \begin{vmatrix} J_\nu(iz) & J_{-\nu}(iz) \\ J'_\nu(iz) & J'_{-\nu}(iz) \end{vmatrix} \\
&= i \frac{-2}{i\pi z} \sin(\pi\nu) \\
&= -\frac{2}{\pi z} \sin(\pi\nu)
\end{aligned}$$

$$\begin{aligned}
W [I_\nu, K_\nu] &= \left| \begin{array}{c} I_\nu \quad \frac{\pi}{2} \csc(\pi\nu)(I_{-\nu} - I_\nu) \\ I'_\nu \quad \frac{\pi}{2} \csc(\pi\nu)(I'_{-\nu} - I'_\nu) \end{array} \right| \\
&= \frac{\pi}{2} \csc(\pi\nu) \left( \left| \begin{array}{cc} I_\nu & I_{-\nu} \\ I'_\nu & I'_{-\nu} \end{array} \right| - \left| \begin{array}{cc} I_\nu & I_\nu \\ I'_\nu & I'_\nu \end{array} \right| \right) \\
&= \frac{\pi}{2} \csc(\pi\nu) \frac{-2}{\pi z} \sin(\pi\nu) \\
&= -\frac{1}{z}
\end{aligned}$$

### Solution 34.7

1. We differentiate the generating function with respect to  $t$ .

$$\begin{aligned}
e^{\frac{z}{2}(t-1/t)} &= \sum_{n=-\infty}^{\infty} J_n(z)t^n \\
\frac{z}{2} \left(1 + \frac{1}{t^2}\right) e^{\frac{z}{2}(t-1/t)} &= \sum_{n=-\infty}^{\infty} J_n(z)nt^{n-1} \\
\left(1 + \frac{1}{t^2}\right) \sum_{n=-\infty}^{\infty} J_n(z)t^n &= \frac{2}{z} \sum_{n=-\infty}^{\infty} J_n(z)nt^{n-1} \\
\sum_{n=-\infty}^{\infty} J_n(z)t^n + \sum_{n=-\infty}^{\infty} J_n(z)t^{n-2} &= \frac{2}{z} \sum_{n=-\infty}^{\infty} J_n(z)nt^{n-1} \\
\sum_{n=-\infty}^{\infty} J_{n-1}(z)t^{n-1} + \sum_{n=-\infty}^{\infty} J_{n+1}(z)t^{n-1} &= \frac{2}{z} \sum_{n=-\infty}^{\infty} J_n(z)nt^{n-1} \\
J_{n-1}(z) + J_{n+1}(z) &= \frac{2}{z} J_n(z)n \\
\boxed{\frac{2n}{z} J_n(z) = J_{n-1}(z) + J_{n+1}(z)}
\end{aligned}$$



2. We differentiate the generating function with respect to  $z$ .

$$e^{\frac{z}{2}(t-1/t)} = \sum_{n=-\infty}^{\infty} J_n(z)t^n$$

$$\frac{1}{2} \left( t - \frac{1}{t} \right) e^{\frac{z}{2}(t-1/t)} = \sum_{n=-\infty}^{\infty} J'_n(z)t^n$$

$$\frac{1}{2} \left( t - \frac{1}{t} \right) \sum_{n=-\infty}^{\infty} J_n(z)t^n = \sum_{n=-\infty}^{\infty} J'_n(z)t^n$$

$$\frac{1}{2} \left( \sum_{n=-\infty}^{\infty} J_n(z)t^{n+1} - \sum_{n=-\infty}^{\infty} J_n(z)t^{n-1} \right) = \sum_{n=-\infty}^{\infty} J'_n(z)t^n$$

$$\frac{1}{2} \left( \sum_{n=-\infty}^{\infty} J_{n-1}(z)t^n - \sum_{n=-\infty}^{\infty} J_{n+1}(z)t^n \right) = \sum_{n=-\infty}^{\infty} J'_n(z)t^n$$

$$\frac{1}{2} (J_{n-1}(z) - J_{n+1}(z)) = J'_n(z)$$

$$\boxed{J'_n(z) = \frac{1}{2} (J_{n-1} - J_{n+1})}$$

3.

$$\frac{d}{dz} (z^{-n} J_n(z)) = -nz^{-n-1} J_n(z) + z^{-n} J'_n(z)$$

$$= -\frac{1}{2} z^{-n} \frac{2n}{z} J_n(z) + z^{-n} \frac{1}{2} (J_{n-1}(z) - J_{n+1}(z))$$

$$= -\frac{1}{2} z^{-n} (J_{n+1}(z) + J_{n-1}(z)) + \frac{1}{2} z^{-n} (J_{n-1}(z) - J_{n+1}(z))$$

$$\boxed{\frac{d}{dz} (z^{-n} J_n(z)) = -z^{-n} J_{n+1}(z)}$$

### Solution 34.8

For this part we will use the identities

$$J'_\nu(z) = \frac{\nu}{z} J_\nu(z) - J_{\nu+1}(z), \quad J'_\nu(z) = J_{\nu-1}(z) - \frac{\nu}{z} J_\nu(z).$$

$$\begin{aligned} \left| \begin{array}{cc} J_\nu(z) & J_{-\nu}(z) \\ J'_\nu(z) & J'_{-\nu}(z) \end{array} \right| &= -\frac{2 \sin(\nu\pi)}{\pi z} \\ \left| \begin{array}{cc} J_\nu(z) & J_{-\nu}(z) \\ J_{\nu-1}(z) - \frac{\nu}{z} J_\nu & -\frac{\nu}{z} J_{-\nu}(z) - J_{-\nu+1}(z) \end{array} \right| &= -\frac{2 \sin(\nu\pi)}{\pi z} \\ \left| \begin{array}{cc} J_\nu(z) & J_{-\nu}(z) \\ J_{\nu-1}(z) & -J_{-\nu+1}(z) \end{array} \right| - \frac{\nu}{z} \left| \begin{array}{cc} J_\nu(z) & J_{-\nu}(z) \\ J_\nu(z) & J_{-\nu}(z) \end{array} \right| &= -\frac{2 \sin(\nu\pi)}{\pi z} \\ -J_{\nu+1}(z)J_\nu(z) - J_\nu(z)J_{\nu-1}(z) &= -\frac{2 \sin(\nu\pi)}{\pi z} \\ \boxed{J_{-\nu+1}(z)J_\nu(z) + J_{-\nu}(z)J_{\nu-1}(z) = \frac{2}{\pi z} \sin \nu\pi} \end{aligned}$$

### Solution 34.9

The generating function for the Bessel functions is

$$e^{\frac{1}{2}z(t-1/t)} = \sum_{n=-\infty}^{\infty} J_n(z)t^n. \quad (34.2)$$

1. We substitute  $t = 1$  into the generating function.

$$\begin{aligned} \sum_{n=-\infty}^{\infty} J_n(z) &= 1 \\ J_0(z) + \sum_{n=1}^{\infty} J_n(z) + \sum_{n=1}^{\infty} J_{-n}(z) &= 1 \end{aligned}$$

We use the identity  $J_{-n} = (-1)^n J_n$ .

$$J_0(z) + \sum_{n=1}^{\infty} (1 + (-1)^n) J_n(z) = 1$$

$$J_0(z) + 2 \sum_{\substack{n=2 \\ \text{even } n}}^{\infty} J_n(z) = 1$$

$$J_0(z) + 2 \sum_{n=1}^{\infty} J_{2n}(z) = 1$$

2. We substitute  $t = i$  into the generating function.

$$\begin{aligned} \sum_{n=-\infty}^{\infty} J_n(z) i^n &= e^{iz} \\ J_0(z) + \sum_{n=1}^{\infty} J_n(z) i^n + \sum_{n=1}^{\infty} J_{-n}(z) i^{-n} &= e^{iz} \\ J_0(z) + \sum_{n=1}^{\infty} J_n(z) i^n + \sum_{n=1}^{\infty} (-1)^n J_n(z) (-i)^n &= e^{iz} \end{aligned}$$

$$J_0(z) + 2 \sum_{n=1}^{\infty} J_n(z) i^n = e^{iz} \tag{34.3}$$

Next we substitute  $t = -i$  into the generating function.

$$J_0(z) + 2 \sum_{n=1}^{\infty} (-1)^n J_n(z) i^n = e^{-iz} \tag{34.4}$$

Dividing the sum of Equation 34.3 and Equation 34.4 by 2 gives us the desired identity.

$$J_0(z) + \sum_{n=1}^{\infty} (1 + (-1)^n) J_n(z) i^n = \cos z$$

$$J_0(z) + 2 \sum_{\substack{n=2 \\ \text{even } n}}^{\infty} J_n(z) i^n = \cos z$$

$$J_0(z) + 2 \sum_{\substack{n=2 \\ \text{even } n}}^{\infty} (-1)^{n/2} J_n(z) = \cos z$$

$$J_0(z) + 2 \sum_{n=1}^{\infty} (-1)^n J_{2n}(z) = \cos z$$

3. Dividing the difference of Equation 34.3 and Equation 34.4 by  $i2$  gives us the other identity.

$$-i \sum_{n=1}^{\infty} (1 - (-1)^n) J_n(z) i^n = \sin z$$

$$2 \sum_{\substack{n=1 \\ \text{odd } n}}^{\infty} J_n(z) i^{n-1} = \sin z$$

$$2 \sum_{\substack{n=1 \\ \text{odd } n}}^{\infty} (-1)^{(n-1)/2} J_n(z) = \sin z$$

$$2 \sum_{n=0}^{\infty} (-1)^n J_{2n+1}(z) = \sin z$$

4. We substitute  $-t$  for  $t$  in the generating function.

$$e^{-\frac{1}{2}z(t-1/t)} = \sum_{n=-\infty}^{\infty} J_n(z)(-t)^n. \quad (34.5)$$

We take the product of Equation 34.2 and Equation 34.5 to obtain the final identity.

$$\left( \sum_{n=-\infty}^{\infty} J_n(z)t^n \right) \left( \sum_{m=-\infty}^{\infty} J_m(z)(-t)^m \right) = e^{\frac{1}{2}z(t-1/t)} e^{-\frac{1}{2}z(t-1/t)} = 1$$

Note that the coefficients of all powers of  $t$  except  $t^0$  in the product of sums must vanish.

$$\sum_{n=-\infty}^{\infty} J_n(z)t^n J_{-n}(z)(-t)^{-n} = 1$$

$$\sum_{n=-\infty}^{\infty} J_n^2(z) = 1$$

$$\boxed{J_0^2(z) + 2 \sum_{n=1}^{\infty} J_n^2(z) = 1}$$

### Solution 34.10

First we make the change of variables  $y(x) = x^{1/2}v(x)$ . We compute the derivatives of  $y(x)$ .

$$y' = x^{1/2}v' + \frac{1}{2}x^{-1/2}v,$$

$$y'' = x^{1/2}v'' + x^{-1/2}v' - \frac{1}{4}x^{-3/2}v.$$

We substitute these into the differential equation for  $y$ .

$$y'' + x^{p-2}y = 0$$

$$x^{1/2}v'' + x^{-1/2}v' - \frac{1}{4}x^{-3/2}v + x^{p-3/2}v = 0$$

$$x^2v'' + xv' + \left(x^p - \frac{1}{4}\right)v = 0$$

Then we make the change of variables  $v(x) = u(\xi)$ ,  $\xi = \frac{2}{p}x^{p/2}$ . We write the derivatives in terms of  $\xi$ .

$$x \frac{d}{dx} = x \frac{d\xi}{dx} \frac{d}{d\xi} = xx^{p/2-1} \frac{d}{d\xi} = \frac{p}{2}\xi \frac{d}{d\xi}$$

$$x^2 \frac{d^2}{dx^2} + x \frac{d}{dx} = x \frac{d}{dx} x \frac{d}{dx} = \frac{p}{2}\xi \frac{d}{d\xi} \frac{p}{2}\xi \frac{d}{d\xi} = \frac{p^2}{4}\xi^2 \frac{d^2}{d\xi^2} + \frac{p^2}{4}\xi \frac{d}{d\xi}$$

We write the differential equation for  $u(\xi)$ .

$$\frac{p^2}{4}\xi^2 u'' + \frac{p^2}{4}\xi u' + \left(\frac{p^2}{4}\xi^2 - \frac{1}{4}\right)u = 0$$

$$u'' + \frac{1}{\xi}u' + \left(1 - \frac{1}{p^2\xi^2}\right)u = 0$$

This is the Bessel equation of order  $1/p$ . We can write the general solution for  $u$  in terms of Bessel functions of the first kind if  $p \neq \pm 1$ . Otherwise, we use a Bessel function of the second kind.

$$u(\xi) = c_1 J_{1/p}(\xi) + c_2 J_{-1/p}(\xi) \text{ for } p \neq 0, \pm 1$$

$$u(\xi) = c_1 J_{1/p}(\xi) + c_2 Y_{1/p}(\xi) \text{ for } p \neq 0$$

We write the solution in terms of  $y(x)$ .

$$y(x) = c_1 \sqrt{x} J_{1/p} \left( \frac{2}{p} x^{p/2} \right) + c_2 \sqrt{x} J_{-1/p} \left( \frac{2}{p} x^{p/2} \right) \text{ for } p \neq 0, \pm 1$$

$$y(x) = c_1 \sqrt{x} J_{1/p} \left( \frac{2}{p} x^{p/2} \right) + c_2 \sqrt{x} Y_{1/p} \left( \frac{2}{p} x^{p/2} \right) \text{ for } p \neq 0$$

The Airy equation  $y'' + xy = 0$  is the case  $p = 3$ . The general solution of the Airy equation is

$$y(x) = c_1 \sqrt{x} J_{1/3} \left( \frac{2}{3} x^{3/2} \right) + c_2 \sqrt{x} J_{-1/3} \left( \frac{2}{3} x^{3/2} \right).$$

### Solution 34.11

Consider  $J_{1/2}(z)$ . We start with the series expansion.

$$J_{1/2}(z) = \sum_{m=0}^{\infty} \frac{(-1)^m}{m! \Gamma(1/2 + m + 1)} \left( \frac{z}{2} \right)^{1/2+2m}.$$

Use the identity  $\Gamma(n + 1/2) = \frac{(1)(3)\cdots(2n-1)}{2^n} \sqrt{\pi}$ .

$$\begin{aligned} &= \sum_{m=0}^{\infty} \frac{(-1)^m 2^{m+1}}{m! (1)(3) \cdots (2m+1) \sqrt{\pi}} \left( \frac{z}{2} \right)^{1/2+2m} \\ &= \sum_{m=0}^{\infty} \frac{(-1)^m 2^{m+1}}{(2)(4) \cdots (2m) \cdot (1)(3) \cdots (2m+1) \sqrt{\pi}} \left( \frac{1}{2} \right)^{1/2+m} z^{1/2+2m} \\ &= \left( \frac{2}{\pi z} \right)^{1/2} \sum_{m=0}^{\infty} \frac{(-1)^m}{(2m+1)!} z^{2m+1} \end{aligned}$$

We recognize the sum as the Taylor series expansion of  $\sin z$ .

$$= \left( \frac{2}{\pi z} \right)^{1/2} \sin z$$

Using the recurrence relations,

$$J_{\nu+1} = \frac{\nu}{z} J_{\nu} - J'_{\nu} \quad \text{and} \quad J_{\nu-1} = \frac{\nu}{z} J_{\nu} + J'_{\nu},$$

we can find  $J_{n+1/2}$  for any integer  $n$ .

We need  $J_{3/2}(z)$  to determine  $j_1(z)$ . To find  $J_{3/2}(z)$ ,

$$\begin{aligned} J_{3/2}(z) &= \frac{1/2}{z} J_{1/2}(z) - J'_{1/2}(z) \\ &= \frac{1/2}{z} \left( \frac{2}{\pi} \right)^{1/2} z^{-1/2} \sin z - \left( -\frac{1}{2} \right) \left( \frac{2}{\pi} \right)^{1/2} z^{-3/2} \sin z - \left( \frac{2}{\pi} \right)^{1/2} z^{-1/2} \cos z \\ &= 2^{-1/2} \pi^{-1/2} z^{-3/2} \sin z + 2^{-1/2} \pi^{-1/2} z^{-3/2} \sin z - 2^{-1/2} \pi^{-1/2} \cos z \\ &= \left( \frac{2}{\pi} \right)^{1/2} z^{-3/2} \sin z - \left( \frac{2}{\pi} \right)^{1/2} z^{-1/2} \cos z \\ &= \left( \frac{2}{\pi} \right)^{1/2} (z^{-3/2} \sin z - z^{-1/2} \cos z). \end{aligned}$$

The spherical Bessel function  $j_1(z)$  is

$$j_1(z) = \frac{\sin z}{z^2} - \frac{\cos z}{z}.$$

The modified Bessel function of the first kind is

$$I_{\nu}(z) = i^{-\nu} J_{\nu}(iz).$$



We can determine  $I_{1/2}(z)$  from  $J_{1/2}(z)$ .

$$\begin{aligned} I_{1/2}(z) &= i^{-1/2} \sqrt{\frac{2}{i\pi z}} \sin(iz) \\ &= -i \sqrt{\frac{2}{\pi z}} i \sinh(z) \\ &= \sqrt{\frac{2}{\pi z}} \sinh(z) \end{aligned}$$

The spherical Bessel function  $i_0(z)$  is

$$i_0(z) = \frac{\sinh z}{z}.$$

The modified Bessel function of the second kind is

$$K_\nu(z) = \lim_{\mu \rightarrow \nu} \frac{\pi}{2} \frac{I_{-\mu} - I_\mu}{\sin(\mu\pi)}$$

Thus  $K_{1/2}(z)$  can be determined in terms of  $I_{-1/2}(z)$  and  $I_{1/2}(z)$ .

$$K_{1/2}(z) = \frac{\pi}{2} (I_{-1/2} - I_{1/2})$$

We determine  $I_{-1/2}$  with the recursion relation

$$I_{\nu-1}(z) = I'_\nu(z) + \frac{\nu}{z} I_\nu(z).$$

$$\begin{aligned} I_{-1/2}(z) &= I'_{1/2}(z) + \frac{1}{2z} I_{1/2}(z) \\ &= \sqrt{\frac{2}{\pi}} z^{-1/2} \cosh(z) - \frac{1}{2} \sqrt{\frac{2}{\pi}} z^{-3/2} \sinh(z) + \frac{1}{2z} \sqrt{\frac{2}{\pi}} z^{-1/2} \sinh(z) \\ &= \sqrt{\frac{2}{\pi z}} \cosh(z) \end{aligned}$$

Now we can determine  $K_{1/2}(z)$ .

$$\begin{aligned} K_{1/2}(z) &= \frac{\pi}{2} \left( \sqrt{\frac{2}{\pi z}} \cosh(z) - \sqrt{\frac{2}{\pi z}} \sinh(z) \right) \\ &= \sqrt{\frac{\pi}{2z}} e^{-z} \end{aligned}$$

The spherical Bessel function  $k_0(z)$  is

$$k_0(z) = \frac{\pi}{2z} e^{-z}.$$

### Solution 34.12

**The Point at Infinity.** With the change of variables  $z = 1/\zeta$ ,  $w(z) = u(\zeta)$  the modified Bessel equation becomes

$$\begin{aligned} w'' + \frac{1}{z} w' - \left(1 + \frac{n^2}{z^2}\right) w &= 0 \\ \zeta^4 u'' + 2\zeta^3 u' + \zeta(-\zeta^2) u' - (1 + n^2 \zeta^2) u &= 0 \\ u'' + \frac{1}{\zeta} u' - \left(\frac{1}{\zeta^4} - \frac{n^2}{\zeta^2}\right) u &= 0. \end{aligned}$$

The point  $\zeta = 0$  and hence the point  $z = \infty$  is an irregular singular point. We will find the leading order asymptotic behavior of the solutions as  $z \rightarrow +\infty$ .

**Controlling Factor.** Starting with the modified Bessel equation for real argument

$$y'' + \frac{1}{x} y' - \left(1 + \frac{n^2}{x^2}\right) y = 0,$$

we make the substitution  $y = e^{s(x)}$  to obtain

$$s'' + (s')^2 + \frac{1}{x} s' - 1 - \frac{n^2}{x^2} = 0.$$

We know that  $\frac{n^2}{x^2} \ll 1$  as  $x \rightarrow \infty$ ; we will assume that  $s'' \ll (s')^2$  as  $x \rightarrow \infty$ . This gives us

$$(s')^2 + \frac{1}{x}s' - 1 \sim 0 \quad \text{as } x \rightarrow \infty.$$

To simplify the equation further, we will try the possible two-term balances.

1.  $(s')^2 + \frac{1}{x}s' \sim 0 \rightarrow s' \sim -\frac{1}{x}$  This balance is not consistent as it violates the assumption that 1 is smaller than the other terms.
2.  $(s')^2 - 1 \sim 0 \rightarrow s' \sim \pm 1$  This balance is consistent.
3.  $\frac{1}{x}s' - 1 \sim 0 \rightarrow s' \sim x$  This balance is inconsistent as  $(s')^2$  isn't smaller than the other terms.

Thus the only dominant balance is  $s' \sim \pm 1$ . This balance is consistent with our initial assumption that  $s'' \ll (s')^2$ . Thus  $s \sim \pm x$  and the controlling factor is  $e^{\pm x}$ . We are interested in the decaying solution, so we will work with the controlling factor  $e^{-x}$ .

**Leading Order Behavior.** In order to find the leading order behavior, we substitute  $s = -x + t(x)$  where  $t(x) \ll x$  as  $x \rightarrow \infty$  into the differential equation for  $s$ . We assume that  $t' \ll 1$  and  $t'' \ll 1/x$ .

$$t'' + (-1 + t')^2 + \frac{1}{x}(-1 + t') - 1 - \frac{n^2}{x^2} = 0$$

$$t'' - 2t' + (t')^2 - \frac{1}{x} + \frac{1}{x}t' - \frac{n^2}{x^2} = 0$$

Using our assumptions about the behavior of  $t'$  and  $t''$ ,

$$-2t' - \frac{1}{x} \sim 0$$

$$t' \sim -\frac{1}{2x}$$

$$t \sim -\frac{1}{2} \ln x \quad \text{as } x \rightarrow \infty.$$

This asymptotic behavior is consistent with our assumptions.

Thus the leading order behavior of the decaying solution is

$$y \sim c e^{-x - \frac{1}{2} \ln x + u(x)} = c x^{-1/2} e^{-x + u(x)} \quad \text{as } x \rightarrow \infty,$$

where  $u(x) \ll \ln x$  as  $x \rightarrow \infty$ .

By substituting  $t = -\frac{1}{2} \ln x + u(x)$  into the differential equation for  $t$ , you could show that  $u(x) \rightarrow \text{const}$  as  $x \rightarrow \infty$ . Thus the full leading order behavior of the decaying solution is

$$y \sim c x^{-1/2} e^{-x} \quad \text{as } x \rightarrow \infty$$

where  $u(x) \rightarrow 0$  as  $x \rightarrow \infty$ . It turns out that the asymptotic behavior of the modified Bessel function of the second kind is

$$K_n(x) \sim \sqrt{\frac{\pi}{2x}} e^{-x} \quad \text{as } x \rightarrow \infty$$

**Asymptotic Series.** Now we find the full asymptotic series for  $K_n(x)$  as  $x \rightarrow \infty$ . We substitute

$$K_n(x) \sim \sqrt{\frac{\pi}{2x}} e^{-x} w(x) K_n(x) \propto \frac{e^{-x}}{\sqrt{x}}$$

into the modified Bessel equation, where  $w(x)$  is a Taylor series about  $x = \infty$ , i.e.,

$$K_n(x) \sim \sqrt{\frac{\pi}{2x}} e^{-x} \sum_{k=0}^{\infty} a_k x^{-k}, \quad a_0 = 1.$$

First we differentiate the expression for  $K_n(x)$ .

$$K_n'(x) \sim \sqrt{\frac{\pi}{2x}} e^{-x} \left( w' - \left( 1 + \frac{1}{2x} \right) w \right)$$

$$K_n''(x) \sim \sqrt{\frac{\pi}{2x}} e^{-x} \left( w'' - \left( 2 + \frac{1}{x} \right) w' + \left( 1 + \frac{1}{x} + \frac{3}{4x^2} \right) w \right)$$

We substitute these expressions into the modified Bessel equation.

$$\begin{aligned}
 x^2 y'' + xy' - (x^2 + n^2) y &= 0 \\
 x^2 w'' - (2x^2 + x) w' + \left(x^2 + x + \frac{3}{4}\right) w + xw' - \left(x + \frac{1}{2}\right) w - (x^2 + n^2) w &= 0 \\
 x^2 w'' - 2x^2 w' + \left(\frac{1}{4} - n^2\right) w &= 0
 \end{aligned}$$

We compute the derivatives of the Taylor series.

$$\begin{aligned}
 w' &= \sum_{k=1}^{\infty} (-k) a_k x^{-k-1} \\
 &= \sum_{k=0}^{\infty} (-k-1) a_{k+1} x^{-k-2} \\
 w'' &= \sum_{k=1}^{\infty} (-k)(-k-1) a_k x^{-k-2} \\
 &= \sum_{k=0}^{\infty} (-k)(-k-1) a_k x^{-k-2}
 \end{aligned}$$

We substitute these expression into the differential equation.

$$\begin{aligned}
 x^2 \sum_{k=0}^{\infty} k(k+1) a_k x^{-k-2} + 2x^2 \sum_{k=0}^{\infty} (k+1) a_{k+1} x^{-k-2} + \left(\frac{1}{4} - n^2\right) \sum_{k=0}^{\infty} a_k x^{-k} &= 0 \\
 \sum_{k=0}^{\infty} k(k+1) a_k x^{-k} + 2 \sum_{k=0}^{\infty} (k+1) a_{k+1} x^{-k} + \left(\frac{1}{4} - n^2\right) \sum_{k=0}^{\infty} a_k x^{-k} &= 0
 \end{aligned}$$

We equate coefficients of  $x$  to obtain a recurrence relation for the coefficients.

$$k(k+1)a_k + 2(k+1)a_{k+1} + \left(\frac{1}{4} - n^2\right)a_k = 0$$

$$a_{k+1} = \frac{n^2 - 1/4 - k(k+1)}{2(k+1)}a_k$$

$$a_{k+1} = \frac{n^2 - (k+1/2)^2}{2(k+1)}a_k$$

$$a_{k+1} = \frac{4n^2 - (2k+1)^2}{8(k+1)}a_k$$

We set  $a_0 = 1$ . We use the recurrence relation to determine the rest of the coefficients.

$$a_k = \frac{\prod_{j=1}^k (4n^2 - (2j-1)^2)}{8^k k!}$$

Now we have the asymptotic expansion of the modified Bessel function of the second kind.

$$K_n(x) \sim \sqrt{\frac{\pi}{2x}} e^{-x} \sum_{k=0}^{\infty} \frac{\prod_{j=1}^k (4n^2 - (2j-1)^2)}{8^k k!} x^{-k}, \quad \text{as } x \rightarrow \infty$$

**Convergence.** We determine the domain of convergence of the series with the ratio test. The Taylor series about infinity will converge outside of some circle.

$$\lim_{k \rightarrow \infty} \left| \frac{a_{k+1}(x)}{a_k(x)} \right| < 1$$

$$\lim_{k \rightarrow \infty} \left| \frac{a_{k+1}x^{-k-1}}{a_kx^{-k}} \right| < 1$$

$$\lim_{k \rightarrow \infty} \left| \frac{4n^2 - (2k+1)^2}{8(k+1)} \right| |x|^{-1} < 1$$

$$\infty < |x|$$

The series does not converge for any  $x$  in the finite complex plane. However, if we take only a finite number of terms in the series, it gives a good approximation of  $K_n(x)$  for large, positive  $x$ . At  $x = 10$ , the one, two and three term approximations give relative errors of 0.01, 0.0006 and 0.00006, respectively.

# Part V

## Partial Differential Equations



# Chapter 35

## Transforming Equations

I'm about two beers away from fine.

Let  $\{x_i\}$  denote rectangular coordinates. Let  $\{\mathbf{a}_i\}$  be unit basis vectors in the orthogonal coordinate system  $\{\xi_i\}$ . The *distance metric coefficients*  $h_i$  can be defined

$$h_i = \sqrt{\left(\frac{\partial x_1}{\partial \xi_i}\right)^2 + \left(\frac{\partial x_2}{\partial \xi_i}\right)^2 + \left(\frac{\partial x_3}{\partial \xi_i}\right)^2}.$$

The gradient, divergence, etc., follow.

$$\begin{aligned}\nabla u &= \frac{\mathbf{a}_1}{h_1} \frac{\partial u}{\partial \xi_1} + \frac{\mathbf{a}_2}{h_2} \frac{\partial u}{\partial \xi_2} + \frac{\mathbf{a}_3}{h_3} \frac{\partial u}{\partial \xi_3} \\ \nabla \cdot \mathbf{v} &= \frac{1}{h_1 h_2 h_3} \left( \frac{\partial}{\partial \xi_1} (h_2 h_3 v_1) + \frac{\partial}{\partial \xi_2} (h_3 h_1 v_2) + \frac{\partial}{\partial \xi_3} (h_1 h_2 v_3) \right) \\ \nabla^2 u &= \frac{1}{h_1 h_2 h_3} \left( \frac{\partial}{\partial \xi_1} \left( \frac{h_2 h_3}{h_1} \frac{\partial u}{\partial \xi_1} \right) + \frac{\partial}{\partial \xi_2} \left( \frac{h_3 h_1}{h_2} \frac{\partial u}{\partial \xi_2} \right) + \frac{\partial}{\partial \xi_3} \left( \frac{h_1 h_2}{h_3} \frac{\partial u}{\partial \xi_3} \right) \right)\end{aligned}$$

## 35.1 Exercises

### Exercise 35.1

Find the Laplacian in cylindrical coordinates  $(r, \theta, z)$ .

$$x = r \cos \theta, \quad y = r \sin \theta, \quad z$$

Hint, Solution

### Exercise 35.2

Find the Laplacian in spherical coordinates  $(r, \phi, \theta)$ .

$$x = r \sin \phi \cos \theta, \quad y = r \sin \phi \sin \theta, \quad z = r \cos \phi$$

Hint, Solution

## 35.2 Hints

Hint 35.1

Hint 35.2

## 35.3 Solutions

### Solution 35.1

$$h_1 = \sqrt{(\cos \theta)^2 + (\sin \theta)^2 + 0} = 1$$

$$h_2 = \sqrt{(-r \sin \theta)^2 + (r \cos \theta)^2 + 0} = r$$

$$h_3 = \sqrt{0 + 0 + 1^2} = 1$$

$$\nabla^2 u = \frac{1}{r} \left( \frac{\partial}{\partial r} \left( r \frac{\partial u}{\partial r} \right) + \frac{\partial}{\partial \theta} \left( \frac{1}{r} \frac{\partial u}{\partial \theta} \right) + \frac{\partial}{\partial z} \left( r \frac{\partial u}{\partial z} \right) \right)$$

$$\nabla^2 u = \frac{1}{r} \frac{\partial}{\partial r} \left( r \frac{\partial u}{\partial r} \right) + \frac{1}{r^2} \frac{\partial^2 u}{\partial \theta^2} + \frac{\partial^2 u}{\partial z^2}$$

### Solution 35.2

$$h_1 = \sqrt{(\sin \phi \cos \theta)^2 + (\sin \phi \sin \theta)^2 + (\cos \phi)^2} = 1$$

$$h_2 = \sqrt{(r \cos \phi \cos \theta)^2 + (r \cos \phi \sin \theta)^2 + (-r \sin \phi)^2} = r$$

$$h_3 = \sqrt{(-r \sin \phi \sin \theta)^2 + (r \sin \phi \cos \theta)^2 + 0} = r \sin \phi$$

$$\nabla^2 u = \frac{1}{r^2 \sin \phi} \left( \frac{\partial}{\partial r} \left( r^2 \sin \phi \frac{\partial u}{\partial r} \right) + \frac{\partial}{\partial \phi} \left( \sin \phi \frac{\partial u}{\partial \phi} \right) + \frac{\partial}{\partial \theta} \left( \frac{1}{\sin \phi} \frac{\partial u}{\partial \theta} \right) \right)$$

$$\nabla^2 u = \frac{1}{r^2} \frac{\partial}{\partial r} \left( r^2 \frac{\partial u}{\partial r} \right) + \frac{1}{r^2 \sin \phi} \frac{\partial}{\partial \phi} \left( \sin \phi \frac{\partial u}{\partial \phi} \right) + \frac{1}{r^2 \sin \phi} \frac{\partial^2 u}{\partial \theta^2}$$

# Chapter 36

## Classification of Partial Differential Equations

### 36.1 Classification of Second Order Quasi-Linear Equations

Consider the general second order quasi-linear partial differential equation in two variables.

$$a(x, y)u_{xx} + 2b(x, y)u_{xy} + c(x, y)u_{yy} = F(x, y, u, u_x, u_y) \quad (36.1)$$

We classify the equation by the sign of the discriminant. At a given point  $x_0, y_0$ , the equation is classified as one of the following types:

$$\begin{aligned} b^2 - ac > 0 &: \quad \text{hyperbolic} \\ b^2 - ac = 0 &: \quad \text{parabolic} \\ b^2 - ac < 0 &: \quad \text{elliptic} \end{aligned}$$

If an equation has a particular type for all points  $x, y$  in a domain then the equation is said to be of that type in the domain. Each of these types has a canonical form that can be obtained through a change of independent variables. The type of an equation indicates much about the nature of its solution.

We seek a change of independent variables, (a different coordinate system), such that Equation 36.1 has a simpler form. We will find that a second order quasi-linear partial differential equation in two variables can be transformed to

one of the canonical forms:

$$\begin{aligned} u_{\xi\psi} &= G(\xi, \psi, u, u_\xi, u_\psi), & \text{hyperbolic} \\ u_{\xi\xi} &= G(\xi, \psi, u, u_\xi, u_\psi), & \text{parabolic} \\ u_{\xi\xi} + u_{\psi\psi} &= G(\xi, \psi, u, u_\xi, u_\psi), & \text{elliptic} \end{aligned}$$

Consider the change of independent variables

$$\xi = \xi(x, y), \quad \psi = \psi(x, y).$$

We calculate the partial derivatives of  $u$ .

$$\begin{aligned} u_x &= \xi_x u_\xi + \psi_x u_\psi \\ u_y &= \xi_y u_\xi + \psi_y u_\psi \\ u_{xx} &= \xi_x^2 u_{\xi\xi} + 2\xi_x \psi_x u_{\xi\psi} + \psi_x^2 u_{\psi\psi} + \xi_{xx} u_\xi + \psi_{xx} u_\psi \\ u_{xy} &= \xi_x \xi_y u_{\xi\xi} + (\xi_x \psi_y + \xi_y \psi_x) u_{\xi\psi} + \psi_x \psi_y u_{\psi\psi} + \xi_{xy} u_\xi + \psi_{xy} u_\psi \\ u_{yy} &= \xi_y^2 u_{\xi\xi} + 2\xi_y \psi_y u_{\xi\psi} + \psi_y^2 u_{\psi\psi} + \xi_{yy} u_\xi + \psi_{yy} u_\psi \end{aligned}$$

Substituting these into Equation 36.1 yields an equation in  $\xi$  and  $\psi$ .

$$\begin{aligned} (a\xi_x^2 + 2b\xi_x\xi_y + c\xi_y^2) u_{\xi\xi} + 2(a\xi_x\psi_x + b(\xi_x\psi_y + \xi_y\psi_x) + c\xi_y\psi_y) u_{\xi\psi} \\ + (a\psi_x^2 + 2b\psi_x\psi_y + c\psi_y^2) u_{\psi\psi} = H(\xi, \psi, u, u_\xi, u_\psi) \end{aligned}$$

$$\alpha(\xi, \psi) u_{\xi\xi} + \beta(\xi, \psi) u_{\xi\psi} + \gamma(\xi, \psi) u_{\psi\psi} = H(\xi, \psi, u, u_\xi, u_\psi) \quad (36.2)$$

### 36.1.1 Hyperbolic Equations

We start with a hyperbolic equation, ( $b^2 - ac > 0$ ). We seek a change of independent variables that will put Equation 36.1 in the form

$$u_{\xi\psi} = G(\xi, \psi, u, u_\xi, u_\psi) \quad (36.3)$$

We require that the  $u_{\xi\xi}$  and  $u_{\psi\psi}$  terms vanish. That is  $\alpha = \gamma = 0$  in Equation 36.2. This gives us two constraints on  $\xi$  and  $\psi$ .

$$\begin{aligned} a\xi_x^2 + 2b\xi_x\xi_y + c\xi_y^2 &= 0, & a\psi_x^2 + 2b\psi_x\psi_y + c\psi_y^2 &= 0 \\ \frac{\xi_x}{\xi_y} &= \frac{-b + \sqrt{b^2 - ac}}{a}, & \frac{\psi_x}{\psi_y} &= \frac{-b - \sqrt{b^2 - ac}}{a} \\ \xi_x + \frac{b - \sqrt{b^2 - ac}}{a}\xi_y &= 0, & \psi_x + \frac{b + \sqrt{b^2 - ac}}{a}\psi_y &= 0 \end{aligned} \quad (36.4)$$

Here we chose the signs in the quadratic formulas to get different solutions for  $\xi$  and  $\psi$ .

Now we have first order quasi-linear partial differential equations for the coordinates  $\xi$  and  $\psi$ . We solve these equations with the method of characteristics. The characteristic equations for  $\xi$  are

$$\frac{dy}{dx} = \frac{b - \sqrt{b^2 - ac}}{a}, \quad \frac{d}{dx}\xi(x, y(x)) = 0$$

Solving the differential equation for  $y(x)$  determines  $\xi(x, y)$ . We just write the solution for  $y(x)$  in the form  $F(x, y(x)) = \text{const}$ . Since the solution of the differential equation for  $\xi$  is  $\xi(x, y(x)) = \text{const}$ , we then have  $\xi = F(x, y)$ . Upon solving for  $\xi$  and  $\psi$  we divide Equation 36.2 by  $\beta(\xi, \psi)$  to obtain the canonical form.

Note that we could have solved for  $\xi_y/\xi_x$  in Equation 36.4.

$$\frac{dx}{dy} = -\frac{\xi_y}{\xi_x} = \frac{b - \sqrt{b^2 - ac}}{c}$$

This form is useful if  $a$  vanishes.

Another canonical form for hyperbolic equations is

$$u_{\sigma\sigma} - u_{\tau\tau} = K(\sigma, \tau, u, u_\sigma, u_\tau). \quad (36.5)$$

We can transform Equation 36.3 to this form with the change of variables

$$\sigma = \xi + \psi, \quad \tau = \xi - \psi.$$

Equation 36.3 becomes

$$u_{\sigma\sigma} - u_{\tau\tau} = G \left( \frac{\sigma + \tau}{2}, \frac{\sigma - \tau}{2}, u, u_{\sigma} + u_{\tau}, u_{\sigma} - u_{\tau} \right).$$

**Example 36.1.1** Consider the wave equation with a source.

$$u_{tt} - c^2 u_{xx} = s(x, t)$$

Since  $0 - (1)(-c^2) > 0$ , the equation is hyperbolic. We find the new variables.

$$\begin{aligned} \frac{dx}{dt} = -c, \quad x = -ct + \text{const}, \quad \xi = x + ct \\ \frac{dx}{dt} = c, \quad x = ct + \text{const}, \quad \psi = x - ct \end{aligned}$$

Then we determine  $t$  and  $x$  in terms of  $\xi$  and  $\psi$ .

$$t = \frac{\xi - \psi}{2c}, \quad x = \frac{\xi + \psi}{2}$$

We calculate the derivatives of  $\xi$  and  $\psi$ .

$$\begin{aligned} \xi_t = c \quad \xi_x = 1 \\ \psi_t = -c \quad \psi_x = 1 \end{aligned}$$

Then we calculate the derivatives of  $u$ .

$$\begin{aligned} u_{tt} &= c^2 u_{\xi\xi} - 2c^2 u_{\xi\psi} + c^2 u_{\psi\psi} \\ u_{xx} &= u_{\xi\xi} + u_{\psi\psi} \end{aligned}$$



Finally we transform the equation to canonical form.

$$-2c^2 u_{\xi\psi} = s \left( \frac{\xi + \psi}{2}, \frac{\xi - \psi}{2c} \right)$$

$$u_{\xi\psi} = -\frac{1}{2c^2} s \left( \frac{\xi + \psi}{2}, \frac{\xi - \psi}{2c} \right)$$

If  $s(x, t) = 0$ , then the equation is  $u_{\xi\psi} = 0$  we can integrate with respect to  $\xi$  and  $\psi$  to obtain the solution,  $u = f(\xi) + g(\psi)$ . Here  $f$  and  $g$  are arbitrary  $C^2$  functions. In terms of  $t$  and  $x$ , we have

$$u(x, t) = f(x + ct) + g(x - ct).$$

To put the wave equation in the form of Equation 36.5 we make a change of variables

$$\sigma = \xi + \psi = 2x, \quad \tau = \xi - \psi = 2ct$$

$$u_{tt} - c^2 u_{xx} = s(x, t)$$

$$4c^2 u_{\tau\tau} - 4c^2 u_{\sigma\sigma} = s \left( \frac{\sigma}{2}, \frac{\tau}{2c} \right)$$

$$u_{\sigma\sigma} - u_{\tau\tau} = -\frac{1}{4c^2} s \left( \frac{\sigma}{2}, \frac{\tau}{2c} \right)$$

**Example 36.1.2** Consider

$$y^2 u_{xx} - x^2 u_{yy} = 0.$$

For  $x \neq 0$  and  $y \neq 0$  this equation is hyperbolic. We find the new variables.

$$\frac{dy}{dx} = -\frac{\sqrt{y^2 x^2}}{y^2} = -\frac{x}{y}, \quad y dy = -x dx, \quad \frac{y^2}{2} = -\frac{x^2}{2} + \text{const}, \quad \xi = y^2 + x^2$$

$$\frac{dy}{dx} = \frac{\sqrt{y^2 x^2}}{y^2} = \frac{x}{y}, \quad y dy = x dx, \quad \frac{y^2}{2} = \frac{x^2}{2} + \text{const}, \quad \psi = y^2 - x^2$$

We calculate the derivatives of  $\xi$  and  $\psi$ .

$$\begin{aligned}\xi_x &= 2x & \xi_y &= 2y \\ \psi_x &= -2x & \psi_y &= 2y\end{aligned}$$

Then we calculate the derivatives of  $u$ .

$$\begin{aligned}u_x &= 2x(u_\xi - u_\psi) \\ u_y &= 2y(u_\xi + u_\psi) \\ u_{xx} &= 4x^2(u_{\xi\xi} - 2u_{\xi\psi} + u_{\psi\psi}) + 2(u_\xi - u_\psi) \\ u_{yy} &= 4y^2(u_{\xi\xi} + 2u_{\xi\psi} + u_{\psi\psi}) + 2(u_\xi + u_\psi)\end{aligned}$$

Finally we transform the equation to canonical form.

$$\begin{aligned}y^2 u_{xx} - x^2 u_{yy} &= 0 \\ -8x^2 y^2 u_{\xi\psi} - 8x^2 y^2 u_{\xi\psi} + 2y^2(u_\xi - u_\psi) + 2x^2(u_\xi + u_\psi) &= 0 \\ 16\frac{1}{2}(\xi - \psi)\frac{1}{2}(\xi + \psi)u_{\xi\psi} &= 2\xi u_\xi - 2\psi u_\psi \\ \boxed{u_{\xi\psi} = \frac{\xi u_\xi - \psi u_\psi}{2(\xi^2 - \psi^2)}}\end{aligned}$$

**Example 36.1.3** Consider Laplace's equation.

$$u_{xx} + u_{yy} = 0$$

Since  $0 - (1)(1) < 0$ , the equation is elliptic. We will transform this equation to the canonical form of Equation 36.3. We find the new variables.

$$\begin{aligned}\frac{dy}{dx} &= -i, & y &= -ix + \text{const}, & \xi &= x + iy \\ \frac{dy}{dx} &= i, & y &= ix + \text{const}, & \psi &= x - iy\end{aligned}$$

We calculate the derivatives of  $\xi$  and  $\psi$ .

$$\begin{aligned}\xi_x &= 1 & \xi_y &= i \\ \psi_x &= 1 & \psi_y &= -i\end{aligned}$$

Then we calculate the derivatives of  $u$ .

$$\begin{aligned}u_{xx} &= u_{\xi\xi} + 2u_{\xi\psi} + u_{\psi\psi} \\ u_{yy} &= -u_{\xi\xi} + 2u_{\xi\psi} - u_{\psi\psi}\end{aligned}$$

Finally we transform the equation to canonical form.

$$\begin{aligned}4u_{\xi\psi} &= 0 \\ \boxed{u_{\xi\psi} &= 0}\end{aligned}$$

We integrate with respect to  $\xi$  and  $\psi$  to obtain the solution,  $u = f(\xi) + g(\psi)$ . Here  $f$  and  $g$  are arbitrary  $C^2$  functions. In terms of  $x$  and  $y$ , we have

$$\boxed{u(x, y) = f(x + iy) + g(x - iy)}.$$

This solution makes a lot of sense, because the real and imaginary parts of an analytic function are harmonic.

### 36.1.2 Parabolic equations

Now we consider a parabolic equation, ( $b^2 - ac = 0$ ). We seek a change of independent variables that will put Equation 36.1 in the form

$$u_{\xi\xi} = G(\xi, \psi, u, u_\xi, u_\psi). \quad (36.6)$$

We require that the  $u_{\xi\psi}$  and  $u_{\psi\psi}$  terms vanish. That is  $\beta = \gamma = 0$  in Equation 36.2. This gives us two constraints on  $\xi$  and  $\psi$ .

$$a\xi_x\psi_x + b(\xi_x\psi_y + \xi_y\psi_x) + c\xi_y\psi_y = 0, \quad a\psi_x^2 + 2b\psi_x\psi_y + c\psi_y^2 = 0$$

We consider the case  $a \neq 0$ . The latter constraint allows us to solve for  $\psi_x/\psi_y$ .

$$\frac{\psi_x}{\psi_y} = \frac{-b - \sqrt{b^2 - ac}}{a} = -\frac{b}{a}$$

With this information, the former constraint is trivial.

$$\begin{aligned} a\xi_x\psi_x + b(\xi_x\psi_y + \xi_y\psi_x) + c\xi_y\psi_y &= 0 \\ a\xi_x(-b/a) + b(\xi_x + \xi_y(-b/a)) + c\xi_y &= 0 \\ (ac - b^2)\xi_y &= 0 \\ 0 &= 0 \end{aligned}$$

Thus we have a first order partial differential equation for the  $\psi$  coordinate which we can solve with the method of characteristics.

$$\psi_x + \frac{b}{a}\psi_y = 0$$

The  $\xi$  coordinate is chosen to be anything linearly independent of  $\psi$ . The characteristic equations for  $\psi$  are

$$\frac{dy}{dx} = \frac{b}{a}, \quad \frac{d}{dx}\psi(x, y(x)) = 0$$

Solving the differential equation for  $y(x)$  determines  $\psi(x, y)$ . We just write the solution for  $y(x)$  in the form  $F(x, y(x)) = \text{const}$ . Since the solution of the differential equation for  $\psi$  is  $\psi(x, y(x)) = \text{const}$ , we then have  $\psi = F(x, y)$ . Upon solving for  $\psi$  and choosing a linearly independent  $\xi$ , we divide Equation 36.2 by  $\alpha(\xi, \psi)$  to obtain the canonical form.

In the case that  $a = 0$ , we would instead have the constraint,

$$\psi_x + \frac{b}{c}\psi_y = 0.$$

### 36.1.3 Elliptic Equations

We start with an elliptic equation, ( $b^2 - ac < 0$ ). We seek a change of independent variables that will put Equation 36.1 in the form

$$u_{\sigma\sigma} + u_{\tau\tau} = G(\sigma, \tau, u, u_\sigma, u_\tau) \tag{36.7}$$

If we make the change of variables determined by

$$\frac{\xi_x}{\xi_y} = \frac{-b + i\sqrt{ac - b^2}}{a}, \quad \frac{\psi_x}{\psi_y} = \frac{-b - i\sqrt{ac - b^2}}{a},$$

the equation will have the form

$$u_{\xi\psi} = G(\xi, \psi, u, u_\xi, u_\psi).$$

$\xi$  and  $\psi$  are complex-valued. If we then make the change of variables

$$\sigma = \frac{\xi + \psi}{2}, \quad \tau = \frac{\xi - \psi}{2i}$$

we will obtain the canonical form of Equation 36.7. Note that since  $\xi$  and  $\psi$  are complex conjugates,  $\sigma$  and  $\tau$  are real-valued.

**Example 36.1.4** Consider

$$y^2 u_{xx} + x^2 u_{yy} = 0. \quad (36.8)$$

For  $x \neq 0$  and  $y \neq 0$  this equation is elliptic. We find new variables that will put this equation in the form  $u_{\xi\psi} = G(\cdot)$ . From Example 36.1.2 we see that they are

$$\begin{aligned} \frac{dy}{dx} = -i \frac{\sqrt{y^2 x^2}}{y^2} = -i \frac{x}{y}, \quad y dy = -ix dx, \quad \frac{y^2}{2} = -i \frac{x^2}{2} + \text{const}, \quad \xi = y^2 + ix^2 \\ \frac{dy}{dx} = i \frac{\sqrt{y^2 x^2}}{y^2} = i \frac{x}{y}, \quad y dy = ix dx, \quad \frac{y^2}{2} = i \frac{x^2}{2} + \text{const}, \quad \psi = y^2 - ix^2 \end{aligned}$$

The variables that will put Equation 36.8 in canonical form are

$$\sigma = \frac{\xi + \psi}{2} = y^2, \quad \tau = \frac{\xi - \psi}{2i} = x^2$$

We calculate the derivatives of  $\sigma$  and  $\tau$ .

$$\begin{aligned}\sigma_x &= 0 & \sigma_y &= 2y \\ \tau_x &= 2x & \tau_y &= 0\end{aligned}$$

Then we calculate the derivatives of  $u$ .

$$\begin{aligned}u_x &= 2xu_\tau \\ u_y &= 2yu_\sigma \\ u_{xx} &= 4x^2u_{\tau\tau} + 2u_\tau \\ u_{yy} &= 4y^2u_{\sigma\sigma} + 2u_\sigma\end{aligned}$$

Finally we transform the equation to canonical form.

$$\begin{aligned}y^2u_{xx} + x^2u_{yy} &= 0 \\ \sigma(4\tau u_{\tau\tau} + 2u_\tau) + \tau(4\sigma u_{\sigma\sigma} + 2u_\sigma) &= 0\end{aligned}$$

$$\boxed{u_{\sigma\sigma} + u_{\tau\tau} = -\frac{1}{2\sigma}u_\sigma - \frac{1}{2\tau}u_\tau}$$

## 36.2 Equilibrium Solutions

**Example 36.2.1** Consider the equilibrium solution for the following problem.

$$u_t = u_{xx}, \quad u(x, 0) = x, \quad u_x(0, t) = u_x(1, t) = 0$$

Setting  $u_t = 0$  we have an ordinary differential equation.

$$\frac{d^2u}{dx^2} = 0$$

This equation has the solution,

$$u = ax + b.$$

Applying the boundary conditions we see that

$$u = b.$$

To determine the constant, we note that the heat energy in the rod is constant in time.

$$\begin{aligned}\int_0^1 u(x, t) \, dx &= \int_0^1 u(x, 0) \, dx \\ \int_0^1 b \, dx &= \int_0^1 x \, dx\end{aligned}$$

Thus the equilibrium solution is

$$u(x) = \frac{1}{2}.$$

## 36.3 Exercises

### Exercise 36.1

Classify and transform the following equation into canonical form.

$$u_{xx} + (1 + y)^2 u_{yy} = 0$$

Hint, Solution

### Exercise 36.2

Classify as hyperbolic, parabolic, or elliptic in a region  $R$  each of the equations:

1.  $u_t = (pu_x)_x$
2.  $u_{tt} = c^2 u_{xx} - \gamma u$
3.  $(qu_x)_x + (qu_t)_t = 0$

where  $p(x)$ ,  $c(x, t)$ ,  $q(x, t)$ , and  $\gamma(x)$  are given functions that take on only positive values in a region  $R$  of the  $(x, t)$  plane.

Hint, Solution

### Exercise 36.3

Transform each of the following equations for  $\phi(x, y)$  into canonical form in appropriate regions

1.  $\phi_{xx} - y^2 \phi_{yy} + \phi_x - \phi + x^2 = 0$
2.  $\phi_{xx} + x \phi_{yy} = 0$

The equation in part (b) is known as *Tricomi's equation* and is a model for transonic fluid flow in which the flow speed changes from supersonic to subsonic.

Hint, Solution



## 36.4 Hints

**Hint 36.1**

**Hint 36.2**

**Hint 36.3**

## 36.5 Solutions

### Solution 36.1

For  $y = -1$ , the equation is parabolic. For this case it is already in the canonical form,  $u_{xx} = 0$ .

For  $y \neq -1$ , the equation is elliptic. We find new variables that will put the equation in the form  $u_{\xi\psi} = G(\xi, \psi, u, u_\xi, u_\psi)$ .

$$\frac{dy}{dx} = \iota\sqrt{(1+y)^2} = \iota(1+y)$$

$$\frac{dy}{1+y} = \iota dx$$

$$\log(1+y) = \iota x + c$$

$$1+y = c e^{\iota x}$$

$$(1+y) e^{-\iota x} = c$$

$$\xi = (1+y) e^{-\iota x}$$

$$\psi = \bar{\xi} = (1+y) e^{\iota x}$$

The variables that will put the equation in canonical form are

$$\sigma = \frac{\xi + \psi}{2} = (1+y) \cos x, \quad \tau = \frac{\xi - \psi}{\iota 2} = (1+y) \sin x.$$

We calculate the derivatives of  $\sigma$  and  $\tau$ .

$$\sigma_x = -(1+y) \sin x \quad \sigma_y = \cos x$$

$$\tau_x = (1+y) \cos x \quad \tau_y = \sin x$$

Then we calculate the derivatives of  $u$ .

$$u_x = -(1+y) \sin(x) u_\sigma + (1+y) \cos(x) u_\tau$$

$$u_y = \cos(x) u_\sigma + \sin(x) u_\tau$$

$$u_{xx} = (1+y)^2 \sin^2(x) u_{\sigma\sigma} + (1+y)^2 \cos^2(x) u_{\tau\tau} - (1+y) \cos(x) u_\sigma - (1+y) \sin(x) u_\tau$$

$$u_{yy} = \cos^2(x) u_{\sigma\sigma} + \sin^2(x) u_{\tau\tau}$$

We substitute these results into the differential equation to obtain the canonical form.

$$\begin{aligned}
 u_{xx} + (1+y)^2 u_{yy} &= 0 \\
 (1+y)^2 (u_{\sigma\sigma} + u_{\tau\tau}) - (1+y) \cos(x) u_\sigma - (1+y) \sin(x) u_\tau &= 0 \\
 (\sigma^2 + \tau^2) (u_{\sigma\sigma} + u_{\tau\tau}) - \sigma u_\sigma - \tau u_\tau &= 0 \\
 \boxed{u_{\sigma\sigma} + u_{\tau\tau} = \frac{\sigma u_\sigma + \tau u_\tau}{\sigma^2 + \tau^2}}
 \end{aligned}$$

### Solution 36.2

1.

$$\begin{aligned}
 u_t &= (pu_x)_x \\
 pu_{xx} + 0u_{xt} + 0u_{tt} + p_x u_x - u_t &= 0
 \end{aligned}$$

Since  $0^2 - p \cdot 0 = 0$ , the equation is parabolic.

2.

$$\begin{aligned}
 u_{tt} &= c^2 u_{xx} - \gamma u \\
 u_{tt} + 0u_{tx} - c^2 u_{xx} + \gamma u &= 0
 \end{aligned}$$

Since  $0^2 - (1)(-c^2) > 0$ , the equation is hyperbolic.

3.

$$\begin{aligned}
 (qu_x)_x + (qu_t)_t &= 0 \\
 qu_{xx} + 0u_{xt} + qu_{tt} + q_x u_x + q_t u_t &= 0
 \end{aligned}$$

Since  $0^2 - qq < 0$ , the equation is elliptic.

### Solution 36.3

1. For  $y \neq 0$ , the equation is hyperbolic. We find the new independent variables.

$$\frac{dy}{dx} = \frac{\sqrt{y^2}}{1} = y, \quad y = ce^x, \quad e^{-x}y = c, \quad \xi = e^{-x}y$$
$$\frac{dy}{dx} = \frac{-\sqrt{y^2}}{1} = -y, \quad y = ce^{-x}, \quad e^xy = c, \quad \psi = e^xy$$

Next we determine  $x$  and  $y$  in terms of  $\xi$  and  $\psi$ .

$$\xi\psi = y^2, \quad y = \sqrt{\xi\psi}$$
$$\psi = e^x \sqrt{\xi\psi}, \quad e^x = \sqrt{\psi/\xi}, \quad x = \frac{1}{2} \log \left( \frac{\psi}{\xi} \right)$$

We calculate the derivatives of  $\xi$  and  $\psi$ .

$$\xi_x = -e^{-x}y = -\xi$$
$$\xi_y = e^{-x} = \sqrt{\xi/\psi}$$
$$\psi_x = e^xy = \psi$$
$$\psi_y = e^x = \sqrt{\psi/\xi}$$

Then we calculate the derivatives of  $\phi$ .

$$\frac{\partial}{\partial x} = -\xi \frac{\partial}{\partial \xi} + \psi \frac{\partial}{\partial \psi}, \quad \frac{\partial}{\partial y} = \sqrt{\frac{\xi}{\psi}} \frac{\partial}{\partial \xi} + \sqrt{\frac{\psi}{\xi}} \frac{\partial}{\partial \psi}$$
$$\phi_x = -\xi \phi_\xi + \psi \phi_\psi, \quad \phi_y = \sqrt{\frac{\xi}{\psi}} \phi_\xi + \sqrt{\frac{\psi}{\xi}} \phi_\psi$$
$$\phi_{xx} = \xi^2 \phi_{\xi\xi} - 2\xi\psi \phi_{\xi\psi} + \psi^2 \phi_{\psi\psi} + \xi \phi_\xi + \psi \phi_\psi, \quad \phi_{yy} = \frac{\xi}{\psi} \phi_{\xi\xi} + 2\phi_{\xi\psi} + \frac{\psi}{\xi} \phi_{\psi\psi}$$

Finally we transform the equation to canonical form.

$$\begin{aligned} \phi_{xx} - y^2 \phi_{yy} + \phi_x - \phi + x^2 &= 0 \\ -4\xi\psi\phi_{\xi\psi} + \xi\phi_{\xi} + \psi\phi_{\psi} - \xi\phi_{\xi} + \psi\phi_{\psi} - \phi + \log\left(\frac{\psi}{\xi}\right) &= 0 \end{aligned}$$

$$\boxed{\phi_{\xi\psi} = \frac{1}{2\xi}\phi_{\psi} + \phi - \log\left(\frac{\psi}{\xi}\right)}$$

For  $y = 0$  we have the ordinary differential equation

$$\phi_{xx} + \phi_x - \phi + x^2 = 0.$$

2. For  $x < 0$ , the equation is hyperbolic. We find the new independent variables.

$$\begin{aligned} \frac{dy}{dx} = \sqrt{-x}, \quad y = \frac{2}{3}x\sqrt{-x} + c, \quad \xi = \frac{2}{3}x\sqrt{-x} - y \\ \frac{dy}{dx} = -\sqrt{-x}, \quad y = -\frac{2}{3}x\sqrt{-x} + c, \quad \psi = \frac{2}{3}x\sqrt{-x} + y \end{aligned}$$

Next we determine  $x$  and  $y$  in terms of  $\xi$  and  $\psi$ .

$$x = -\left(\frac{3}{4}(\xi + \psi)\right)^{1/3}, \quad y = \frac{\psi - \xi}{2}$$

We calculate the derivatives of  $\xi$  and  $\psi$ .

$$\begin{aligned} \xi_x = \sqrt{-x} = \left(\frac{3}{4}(\xi + \psi)\right)^{1/6}, \quad \xi_y = -1 \\ \psi_x = \left(\frac{3}{4}(\xi + \psi)\right)^{1/6}, \quad \psi_y = 1 \end{aligned}$$

Then we calculate the derivatives of  $\phi$ .

$$\begin{aligned}\phi_x &= \left(\frac{3}{4}(\xi + \psi)\right)^{1/6} (\phi_\xi + \phi_\psi) \\ \phi_y &= -\phi_\xi + \phi_\psi \\ \phi_{xx} &= \left(\frac{3}{4}(\xi + \psi)\right)^{1/3} (\phi_{\xi\xi} + \phi_{\psi\psi}) + (6(\xi + \psi))^{1/3} \phi_{\xi\psi} + (6(\xi + \psi))^{-2/3} (\phi_\xi + \phi_\psi) \\ \phi_{yy} &= \phi_{\xi\xi} - 2\phi_{\xi\psi} + \phi_{\psi\psi}\end{aligned}$$

Finally we transform the equation to canonical form.

$$\begin{aligned}\phi_{xx} + x\phi_{yy} &= 0 \\ (6(\xi + \psi))^{1/3} \phi_{\xi\psi} + (6(\xi + \psi))^{1/3} \phi_{\xi\psi} + (6(\xi + \psi))^{-2/3} (\phi_\xi + \phi_\psi) &= 0 \\ \boxed{\phi_{\xi\psi} = -\frac{\phi_\xi + \phi_\psi}{12(\xi + \psi)}}\end{aligned}$$

For  $x > 0$ , the equation is elliptic. The variables we defined before are complex-valued.

$$\xi = \imath \frac{2}{3} x^{3/2} - y, \quad \psi = \imath \frac{2}{3} x^{3/2} + y$$

We choose the new real-valued variables.

$$\alpha = \xi - \psi, \quad \beta = -\imath(\xi + \psi)$$

We write the derivatives in terms of  $\alpha$  and  $\beta$ .

$$\begin{aligned}\phi_\xi &= \phi_\alpha - \imath\phi_\beta \\ \phi_\psi &= -\phi_\alpha - \imath\phi_\beta \\ \phi_{\xi\psi} &= -\phi_{\alpha\alpha} - \phi_{\beta\beta}\end{aligned}$$

We transform the equation to canonical form.

$$\phi_{\xi\psi} = -\frac{\phi_{\xi} + \phi_{\psi}}{12(\xi + \psi)}$$
$$-\phi_{\alpha\alpha} - \phi_{\beta\beta} = -\frac{-2i\phi_{\beta}}{12i\beta}$$

$$\boxed{\phi_{\alpha\alpha} + \phi_{\beta\beta} = -\frac{\phi_{\beta}}{6\beta}}$$

# Chapter 37

## Separation of Variables

### 37.1 Eigensolutions of Homogeneous Equations

### 37.2 Homogeneous Equations with Homogeneous Boundary Conditions

The method of separation of variables is a useful technique for finding special solutions of partial differential equations. We can combine these special solutions to solve certain problems. Consider the temperature of a one-dimensional rod of length  $h$ <sup>1</sup>. The left end is held at zero temperature, the right end is insulated and the initial temperature distribution is known at time  $t = 0$ . To find the temperature we solve the problem:

$$\begin{aligned}\frac{\partial u}{\partial t} &= \kappa \frac{\partial^2 u}{\partial x^2}, & 0 < x < h, & \quad t > 0 \\ u(0, t) &= u_x(h, t) = 0 \\ u(x, 0) &= f(x)\end{aligned}$$

---

<sup>1</sup>Why  $h$ ? Because  $l$  looks like 1 and we use  $L$  to denote linear operators



We look for special solutions of the form,  $u(x, t) = X(x)T(t)$ . Substituting this into the partial differential equation yields

$$\begin{aligned} X(x)T'(t) &= \kappa X''(x)T(t) \\ \frac{T'(t)}{\kappa T(t)} &= \frac{X''(x)}{X(x)} \end{aligned}$$

Since the left side is only dependent on  $t$ , the right side is only dependent on  $x$ , and the relation is valid for all  $t$  and  $x$ , both sides of the equation must be constant.

$$\frac{T'}{\kappa T} = \frac{X''}{X} = -\lambda$$

Here  $-\lambda$  is an arbitrary constant. (You'll see later that this form is convenient.)  $u(x, t) = X(x)T(t)$  will satisfy the partial differential equation if  $X(x)$  and  $T(t)$  satisfy the ordinary differential equations,

$$T' = -\kappa\lambda T \quad \text{and} \quad X'' = -\lambda X.$$

Now we see how lucky we are that this problem happens to have homogeneous boundary conditions <sup>2</sup>. If the left boundary condition had been  $u(0, t) = 1$ , this would imply  $X(0)T(t) = 1$  which tells us nothing very useful about either  $X$  or  $T$ . However the boundary condition  $u(0, t) = X(0)T(t) = 0$ , tells us that either  $X(0) = 0$  or  $T(t) = 0$ . Since the latter case would give us the trivial solution, we must have  $X(0) = 0$ . Likewise by looking at the right boundary condition we obtain  $X'(h) = 0$ .

We have a regular Sturm-Liouville problem for  $X(x)$ .

$$X'' + \lambda X = 0, \quad X(0) = X'(h) = 0$$

The eigenvalues and orthonormal eigenfunctions are

$$\lambda_n = \left( \frac{(2n-1)\pi}{2h} \right)^2, \quad X_n = \sqrt{\frac{2}{h}} \sin \left( \frac{(2n-1)\pi}{2h} x \right), \quad n \in \mathbb{Z}^+.$$

---

<sup>2</sup>Actually luck has nothing to do with it. I planned it that way.

Now we solve the equation for  $T(t)$ .

$$\begin{aligned} T' &= -\kappa\lambda_n T \\ T &= c e^{-\kappa\lambda_n t} \end{aligned}$$

The eigen-solutions of the partial differential equation that satisfy the homogeneous boundary conditions are

$$u_n(x, t) = \sqrt{\frac{2}{h}} \sin(\sqrt{\lambda_n} x) e^{-\kappa\lambda_n t}.$$

We seek a solution of the problem that is a linear combination of these eigen-solutions.

$$u(x, t) = \sum_{n=1}^{\infty} a_n \sqrt{\frac{2}{h}} \sin(\sqrt{\lambda_n} x) e^{-\kappa\lambda_n t}$$

We apply the initial condition to find the coefficients in the expansion.

$$u(x, 0) = \sum_{n=1}^{\infty} a_n \sqrt{\frac{2}{h}} \sin(\sqrt{\lambda_n} x) = f(x)$$

$$a_n = \sqrt{\frac{2}{h}} \int_0^h \sin(\sqrt{\lambda_n} x) f(x) dx$$

### 37.3 Time-Independent Sources and Boundary Conditions

Consider the temperature in a one-dimensional rod of length  $h$ . The ends are held at temperatures  $\alpha$  and  $\beta$ , respectively, and the initial temperature is known at time  $t = 0$ . Additionally, there is a heat source,  $s(x)$ , that is independent of time. We find the temperature by solving the problem,

$$u_t = \kappa u_{xx} + s(x), \quad u(0, t) = \alpha, \quad u(h, t) = \beta, \quad u(x, 0) = f(x). \quad (37.1)$$

Because of the source term, the equation is not separable, so we cannot directly apply separation of variables. Furthermore, we have the added complication of inhomogeneous boundary conditions. Instead of attacking this problem directly, we seek a transformation that will yield a homogeneous equation and homogeneous boundary conditions.

Consider the equilibrium temperature,  $\mu(x)$ . It satisfies the problem,

$$\mu''(x) = -\frac{s(x)}{\kappa} = 0, \quad \mu(0) = \alpha, \quad \mu(h) = \beta.$$

The Green function for this problem is,

$$G(x; \xi) = \frac{x_{<}(x_{>} - h)}{h}.$$

The equilibrium temperature distribution is

$$\mu(x) = \alpha \frac{x-h}{h} + \beta \frac{x}{h} - \frac{1}{\kappa h} \int_0^h x_{<}(x_{>} - h) s(\xi) d\xi,$$

$$\mu(x) = \alpha + (\beta - \alpha) \frac{x}{h} - \frac{1}{\kappa h} \left( (x-h) \int_0^x \xi s(\xi) d\xi + x \int_x^h (\xi - h) s(\xi) d\xi \right).$$

Now we substitute  $u(x, t) = v(x, t) + \mu(x)$  into Equation 37.1.

$$\begin{aligned} \frac{\partial}{\partial t}(v + \mu(x)) &= \kappa \frac{\partial^2}{\partial x^2}(v + \mu(x)) + s(x) \\ v_t &= \kappa v_{xx} + \kappa \mu''(x) + s(x) \\ v_t &= \kappa v_{xx} \end{aligned} \tag{37.2}$$

Since the equilibrium solution satisfies the inhomogeneous boundary conditions,  $v(x, t)$  satisfies homogeneous boundary conditions.

$$v(0, t) = v(h, t) = 0.$$

The initial value of  $v$  is

$$v(x, 0) = f(x) - \mu(x).$$

We seek a solution for  $v(x, t)$  that is a linear combination of eigen-solutions of the heat equation. We substitute the separation of variables,  $v(x, t) = X(x)T(t)$  into Equation 37.2

$$\frac{T'}{\kappa T} = \frac{X''}{X} = -\lambda$$

This gives us two ordinary differential equations.

$$\begin{aligned} X'' + \lambda X &= 0, & X(0) &= X(h) = 0 \\ T' &= -\kappa\lambda T. \end{aligned}$$

The Sturm-Liouville problem for  $X(x)$  has the eigenvalues and orthonormal eigenfunctions,

$$\lambda_n = \left(\frac{n\pi}{h}\right)^2, \quad X_n = \sqrt{\frac{2}{h}} \sin\left(\frac{n\pi x}{h}\right), \quad n \in \mathbf{Z}^+.$$

We solve for  $T(t)$ .

$$T_n = c e^{-\kappa(n\pi/h)^2 t}.$$

The eigen-solutions of the partial differential equation are

$$v_n(x, t) = \sqrt{\frac{2}{h}} \sin\left(\frac{n\pi x}{h}\right) e^{-\kappa(n\pi/h)^2 t}.$$

The solution for  $v(x, t)$  is a linear combination of these.

$$v(x, t) = \sum_{n=1}^{\infty} a_n \sqrt{\frac{2}{h}} \sin\left(\frac{n\pi x}{h}\right) e^{-\kappa(n\pi/h)^2 t}$$

We determine the coefficients in the series with the initial condition.

$$v(x, 0) = \sum_{n=1}^{\infty} a_n \sqrt{\frac{2}{h}} \sin\left(\frac{n\pi x}{h}\right) = f(x) - \mu(x)$$

$$a_n = \sqrt{\frac{2}{h}} \int_0^h \sin\left(\frac{n\pi x}{h}\right) (f(x) - \mu(x)) dx$$

The temperature of the rod is

$$u(x, t) = \mu(x) + \sum_{n=1}^{\infty} a_n \sqrt{\frac{2}{h}} \sin\left(\frac{n\pi x}{h}\right) e^{-\kappa(n\pi/h)^2 t}$$

## 37.4 Inhomogeneous Equations with Homogeneous Boundary Conditions

Now consider the heat equation with a time dependent source,  $s(x, t)$ .

$$u_t = \kappa u_{xx} + s(x, t), \quad u(0, t) = u(h, t) = 0, \quad u(x, 0) = f(x). \quad (37.3)$$

In general we cannot transform the problem to one with a homogeneous differential equation. Thus we cannot represent the solution in a series of the eigen-solutions of the partial differential equation. Instead, we will do the next best thing and expand the solution in a series of eigenfunctions in  $X_n(x)$  where the coefficients depend on time.

$$u(x, t) = \sum_{n=1}^{\infty} u_n(t) X_n(x)$$

We will find these eigenfunctions with the separation of variables,  $u(x, t) = X(x)T(t)$  applied to the homogeneous equation,  $u_t = \kappa u_{xx}$ , which yields,

$$X_n(x) = \sqrt{\frac{2}{h}} \sin\left(\frac{n\pi x}{h}\right), \quad n \in \mathbb{Z}^+.$$

We expand the heat source in the eigenfunctions.

$$s(x, t) = \sum_{n=1}^{\infty} s_n(t) \sqrt{\frac{2}{h}} \sin\left(\frac{n\pi x}{h}\right)$$

$$s_n(t) = \sqrt{\frac{2}{h}} \int_0^h \sin\left(\frac{n\pi x}{h}\right) s(x, t) dx,$$

We substitute the series solution into Equation 37.3.

$$\sum_{n=1}^{\infty} u'_n(t) \sqrt{\frac{2}{h}} \sin\left(\frac{n\pi x}{h}\right) = -\kappa \sum_{n=1}^{\infty} u_n(t) \left(\frac{n\pi}{h}\right)^2 \sqrt{\frac{2}{h}} \sin\left(\frac{n\pi x}{h}\right) + \sum_{n=1}^{\infty} s_n(t) \sqrt{\frac{2}{h}} \sin\left(\frac{n\pi x}{h}\right)$$

$$u'_n(t) + \kappa \left(\frac{n\pi}{h}\right)^2 u_n(t) = s_n(t)$$

Now we have a first order, ordinary differential equation for each of the  $u_n(t)$ . We obtain initial conditions from the initial condition for  $u(x, t)$ .

$$u(x, 0) = \sum_{n=1}^{\infty} u_n(0) \sqrt{\frac{2}{h}} \sin\left(\frac{n\pi x}{h}\right) = f(x)$$

$$u_n(0) = \sqrt{\frac{2}{h}} \int_0^h \sin\left(\frac{n\pi x}{h}\right) f(x) dx \equiv f_n$$

The temperature is given by

$$u(x, t) = \sum_{n=1}^{\infty} u_n(t) \sqrt{\frac{2}{h}} \sin\left(\frac{n\pi x}{h}\right),$$

$$u_n(t) = f_n e^{-\kappa(n\pi/h)^2 t} + \int_0^t e^{-\kappa(n\pi/h)^2(t-\tau)} s_n(\tau) d\tau.$$

## 37.5 Inhomogeneous Boundary Conditions

Consider the temperature of a one-dimensional rod of length  $h$ . The left end is held at the temperature  $\alpha(t)$ , the heat flow at right end is specified, there is a time-dependent source and the initial temperature distribution is known at time  $t = 0$ . To find the temperature we solve the problem:

$$u_t = \kappa u_{xx} + s(x, t), \quad 0 < x < h, \quad t > 0$$

$$u(0, t) = \alpha(t), \quad u_x(h, t) = \beta(t) \quad u(x, 0) = f(x) \tag{37.4}$$

**Transformation to a homogeneous equation.** Because of the inhomogeneous boundary conditions, we cannot directly apply the method of separation of variables. However we can transform the problem to an inhomogeneous equation with homogeneous boundary conditions. To do this, we first find a function,  $\mu(x, t)$  which satisfies the boundary conditions. We note that

$$\mu(x, t) = \alpha(t) + x\beta(t)$$

does the trick. We make the change of variables

$$u(x, t) = v(x, t) + \mu(x, t)$$

in Equation 37.4.

$$\begin{aligned} v_t + \mu_t &= \kappa(v_{xx} + \mu_{xx}) + s(x, t) \\ v_t &= \kappa v_{xx} + s(x, t) - \mu_t \end{aligned}$$

The boundary and initial conditions become

$$v(0, t) = 0, \quad v_x(h, t) = 0, \quad v(x, 0) = f(x) - \mu(x, 0).$$

Thus we have a heat equation with the source  $s(x, t) - \mu_t(x, t)$ . We could apply separation of variables to find a solution of the form

$$u(x, t) = \mu(x, t) + \sum_{n=1}^{\infty} u_n(t) \sqrt{\frac{2}{h}} \sin\left(\frac{(2n-1)\pi x}{2h}\right).$$

**Direct eigenfunction expansion.** Alternatively we could seek a direct eigenfunction expansion of  $u(x, t)$ .

$$u(x, t) = \sum_{n=1}^{\infty} u_n(t) \sqrt{\frac{2}{h}} \sin\left(\frac{(2n-1)\pi x}{2h}\right).$$

Note that the eigenfunctions satisfy the homogeneous boundary conditions while  $u(x, t)$  does not. If we choose any fixed time  $t = t_0$  and form the periodic extension of the function  $u(x, t_0)$  to define it for  $x$  outside the range  $(0, h)$ , then

this function will have jump discontinuities. This means that our eigenfunction expansion will not converge uniformly. We are not allowed to differentiate the series with respect to  $x$ . We can't just plug the series into the partial differential equation to determine the coefficients. Instead, we will multiply Equation 37.4, by an eigenfunction and integrate from  $x = 0$  to  $x = h$ . To avoid differentiating the series with respect to  $x$ , we will use integration by parts to move derivatives from  $u(x, t)$  to the eigenfunction. (We will denote  $\lambda_n = \left(\frac{(2n-1)\pi}{2h}\right)^2$ .)

$$\begin{aligned} \sqrt{\frac{2}{h}} \int_0^h \sin(\sqrt{\lambda_n}x)(u_t - \kappa u_{xx}) \, dx &= \sqrt{\frac{2}{h}} \int_0^h \sin(\sqrt{\lambda_n}x)s(x, t) \, dx \\ u'_n(t) - \sqrt{\frac{2}{h}}\kappa \left[ u_x \sin(\sqrt{\lambda_n}x) \right]_0^h + \sqrt{\frac{2}{h}}\kappa\sqrt{\lambda_n} \int_0^h u_x \cos(\sqrt{\lambda_n}x) \, dx &= s_n(t) \\ u'_n(t) - \sqrt{\frac{2}{h}}\kappa(-1)^n u_x(h, t) + \sqrt{\frac{2}{h}}\kappa\sqrt{\lambda_n} \left[ u \cos(\sqrt{\lambda_n}x) \right]_0^h + \sqrt{\frac{2}{h}}\kappa\lambda_n \int_0^h u \sin(\sqrt{\lambda_n}x) \, dx &= s_n(t) \\ u'_n(t) - \sqrt{\frac{2}{h}}\kappa(-1)^n \beta(t) - \sqrt{\frac{2}{h}}\kappa\sqrt{\lambda_n}u(0, t) + \kappa\lambda_n u_n(t) &= s_n(t) \\ u'_n(t) + \kappa\lambda_n u_n(t) &= \sqrt{\frac{2}{h}}\kappa \left( \sqrt{\lambda_n}\alpha(t) + (-1)^n \beta(t) \right) + s_n(t) \end{aligned}$$

Now we have an ordinary differential equation for each of the  $u_n(t)$ . We obtain initial conditions for them using the initial condition for  $u(x, t)$ .

$$\begin{aligned} u(x, 0) &= \sum_{n=1}^{\infty} u_n(0) \sqrt{\frac{2}{h}} \sin(\sqrt{\lambda_n}x) = f(x) \\ u_n(0) &= \sqrt{\frac{2}{h}} \int_0^h \sin(\sqrt{\lambda_n}x) f(x) \, dx \equiv f_n \end{aligned}$$



Thus the temperature is given by

$$u(x, t) = \sqrt{\frac{2}{h}} \sum_{n=1}^{\infty} u_n(t) \sin(\sqrt{\lambda_n} x),$$

$$u_n(t) = f_n e^{-\kappa \lambda_n t} + \sqrt{\frac{2}{h}} \kappa \int_0^t e^{-\kappa \lambda_n (t-\tau)} \left( \sqrt{\lambda_n} \alpha(\tau) + (-1)^n \beta(\tau) \right) d\tau.$$

## 37.6 The Wave Equation

Consider an elastic string with a free end at  $x = 0$  and attached to a massless spring at  $x = 1$ . The partial differential equation that models this problem is

$$u_{tt} = u_{xx}$$

$$u_x(0, t) = 0, \quad u_x(1, t) = -u(1, t), \quad u(x, 0) = f(x), \quad u_t(x, 0) = g(x).$$

We make the substitution  $u(x, t) = \psi(x)\phi(t)$  to obtain

$$\frac{\phi''}{\phi} = \frac{\psi''}{\psi} = -\lambda.$$

First we consider the problem for  $\psi$ .

$$\psi'' + \lambda\psi = 0, \quad \psi'(0) = \psi(1) + \psi'(1) = 0.$$

To find the eigenvalues we consider the following three cases:

$\lambda < 0$ . The general solution is

$$\psi = a \cosh(\sqrt{-\lambda} x) + b \sinh(\sqrt{-\lambda} x).$$

$$\begin{aligned}\psi'(0) = 0 &\Rightarrow b = 0. \\ \psi(1) + \psi'(1) = 0 &\Rightarrow a \cosh(\sqrt{-\lambda}) + a\sqrt{-\lambda} \sinh(\sqrt{-\lambda}) = 0 \\ &\Rightarrow a = 0.\end{aligned}$$

Since there is only the trivial solution, there are no negative eigenvalues.

$\lambda = 0$ . The general solution is

$$\psi = ax + b.$$

$$\begin{aligned}\psi'(0) = 0 &\Rightarrow a = 0. \\ \psi(1) + \psi'(1) = 0 &\Rightarrow b + 0 = 0.\end{aligned}$$

Thus  $\lambda = 0$  is not an eigenvalue.

$\lambda > 0$ . The general solution is

$$\psi = a \cos(\sqrt{\lambda}x) + b \sin(\sqrt{\lambda}x).$$

$$\begin{aligned}\psi'(0) &\Rightarrow b = 0. \\ \psi(1) + \psi'(1) = 0 &\Rightarrow a \cos(\sqrt{\lambda}) - a\sqrt{\lambda} \sin(\sqrt{\lambda}) = 0 \\ &\Rightarrow \cos(\sqrt{\lambda}) = \sqrt{\lambda} \sin(\sqrt{\lambda}) \\ &\Rightarrow \sqrt{\lambda} = \cot(\sqrt{\lambda})\end{aligned}$$

By looking at Figure 37.1, (the plot shows the functions  $f(x) = x$ ,  $f(x) = \cot x$  and has lines at  $x = n\pi$ ), we see that there are an infinite number of positive eigenvalues and that

$$\lambda_n \rightarrow (n\pi)^2 \text{ as } n \rightarrow \infty.$$

The eigenfunctions are

$$\psi_n = \cos(\sqrt{\lambda_n}x).$$

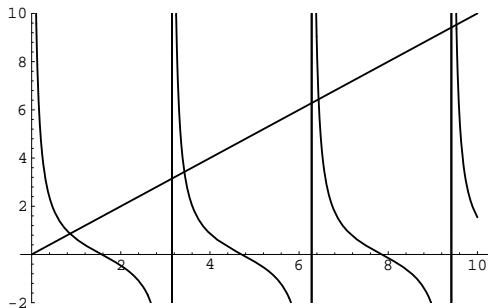

Figure 37.1: Plot of  $x$  and  $\cot x$ .

The solution for  $\phi$  is

$$\phi_n = a_n \cos(\sqrt{\lambda_n t}) + b_n \sin(\sqrt{\lambda_n t}).$$

Thus the solution to the differential equation is

$$u(x, t) = \sum_{n=1}^{\infty} \cos(\sqrt{\lambda_n} x) [a_n \cos(\sqrt{\lambda_n} t) + b_n \sin(\sqrt{\lambda_n} t)].$$

Let

$$f(x) = \sum_{n=1}^{\infty} f_n \cos(\sqrt{\lambda_n} x)$$

$$g(x) = \sum_{n=1}^{\infty} g_n \cos(\sqrt{\lambda_n} x).$$

From the initial value we have

$$\sum_{n=1}^{\infty} \cos(\sqrt{\lambda_n}x) a_n = \sum_{n=1}^{\infty} f_n \cos(\sqrt{\lambda_n}x)$$
$$a_n = f_n.$$

The initial velocity condition gives us

$$\sum_{n=1}^{\infty} \cos(\sqrt{\lambda_n}x) \sqrt{\lambda_n} b_n = \sum_{n=1}^{\infty} g_n \cos(\sqrt{\lambda_n}x)$$
$$b_n = \frac{g_n}{\sqrt{\lambda_n}}.$$

Thus the solution is

$$u(x, t) = \sum_{n=1}^{\infty} \cos(\sqrt{\lambda_n}x) \left[ f_n \cos(\sqrt{\lambda_n}t) + \frac{g_n}{\sqrt{\lambda_n}} \sin(\sqrt{\lambda_n}t) \right].$$

## 37.7 General Method

Here is an outline detailing the method of separation of variables for a linear partial differential equation for  $u(x, y, z, \dots)$ .

1. Substitute  $u(x, y, z, \dots) = X(x)Y(y)Z(z) \cdots$  into the partial differential equation. Separate the equation into ordinary differential equations.
2. Translate the boundary conditions for  $u$  into boundary conditions for  $X, Y, Z, \dots$ . The continuity of  $u$  may give additional boundary conditions and boundedness conditions.
3. Solve the differential equation(s) that determine the eigenvalues. Make sure to consider all cases. The eigenfunctions will be determined up to a multiplicative constant.

- Solve the rest of the differential equations subject to the homogeneous boundary conditions. The eigenvalues will be a parameter in the solution. The solutions will be determined up to a multiplicative constant.
- The eigen-solutions are the product of the solutions of the ordinary differential equations.  $\phi_n = X_n Y_n Z_n \dots$ . The solution of the partial differential equation is a linear combination of the eigen-solutions.

$$u(x, y, z, \dots) = \sum a_n \phi_n$$

- Solve for the coefficients,  $a_n$  using the inhomogeneous boundary conditions.

## 37.8 Exercises

### Exercise 37.1

Solve the following problem with separation of variables.

$$u_t - \kappa(u_{xx} + u_{yy}) = q(x, y, t), \quad 0 < x < a, \quad 0 < y < b$$
$$u(x, y, 0) = f(x, y), \quad u(0, y, t) = u(a, y, t) = u(x, 0, t) = u(x, b, t) = 0$$

Hint, Solution

### Exercise 37.2

Consider a thin half pipe of unit radius laying on the ground. It is heated by radiation from above. We take the initial temperature of the pipe and the temperature of the ground to be zero. We model this problem with a heat equation with a source term.

$$u_t = \kappa u_{xx} + A \sin(x)$$
$$u(0, t) = u(\pi, t) = 0, \quad u(x, 0) = 0$$

Hint, Solution

### Exercise 37.3

Consider Laplace's Equation  $\nabla^2 u = 0$  inside the quarter circle of radius 1 ( $0 \leq \theta \leq \frac{\pi}{2}$ ,  $0 \leq r \leq 1$ ). Write the problem in polar coordinates  $u = u(r, \theta)$  and use separation of variables to find the solution subject to the following boundary conditions.

1.

$$\frac{\partial u}{\partial \theta}(r, 0) = 0, \quad u\left(r, \frac{\pi}{2}\right) = 0, \quad u(1, \theta) = f(\theta)$$

2.

$$\frac{\partial u}{\partial \theta}(r, 0) = 0, \quad \frac{\partial u}{\partial \theta}\left(r, \frac{\pi}{2}\right) = 0, \quad \frac{\partial u}{\partial r}(1, \theta) = g(\theta)$$

Under what conditions does this solution exist?

Hint, Solution

### Exercise 37.4

Consider the 2-D heat equation

$$u_t = \nu(u_{xx} + u_{yy}),$$

on a square plate  $0 < x < 1$ ,  $0 < y < 1$  with two sides insulated

$$u_x(0, y, t) = 0 \quad u_x(1, y, t) = 0,$$

two sides with fixed temperature

$$u(x, 0, t) = 0 \quad u(x, 1, t) = 0,$$

and initial temperature

$$u(x, y, 0) = f(x, y).$$

1. Reduce this to a set of 3 ordinary differential equations using separation of variables.
2. Find the corresponding set of eigenfunctions and give the solution satisfying the given initial condition.

Hint, Solution

### Exercise 37.5

Solve the 1-D heat equation

$$u_t = \nu u_{xx},$$

on the domain  $0 < x < \pi$  subject to conditions that the ends are insulated (i.e. zero flux)

$$u_x(0, t) = 0 \quad u_x(\pi, t) = 0,$$

and the initial temperature distribution is  $u(x, 0) = x$ .

Hint, Solution

**Exercise 37.6**

Obtain Poisson's formula to solve the Dirichlet problem for the circular region  $0 \leq r < R$ ,  $0 \leq \theta < 2\pi$ . That is, determine a solution  $\phi(r, \theta)$  to Laplace's equation

$$\nabla^2 \phi = 0$$

in polar coordinates given  $\phi(R, \theta)$ . Show that

$$\phi(r, \theta) = \frac{1}{2\pi} \int_0^{2\pi} \phi(R, \alpha) \frac{R^2 - r^2}{R^2 + r^2 - 2Rr \cos(\theta - \alpha)} d\alpha$$

**Hint, Solution**

**Exercise 37.7**

Consider the temperature of a ring of unit radius. Solve the problem

$$u_t = \kappa u_{\theta\theta}, \quad u(\theta, 0) = f(\theta)$$

with separation of variables.

**Hint, Solution**

**Exercise 37.8**

Solve the Laplace's equation by separation of variables.

$$\begin{aligned} \Delta u &\equiv u_{xx} + u_{yy} = 0, & 0 < x < 1, & \quad 0 < y < 1, \\ u(x, 0) &= f(x), & u(x, 1) &= 0, & \quad u(0, y) = 0, & \quad u(1, y) = 0 \end{aligned}$$

Here  $f(x)$  is an arbitrary function which is known.

**Hint, Solution**

**Exercise 37.9**

Solve Laplace's equation in the unit disk with separation of variables.

$$\begin{aligned} \Delta u &= 0, & 0 < r < 1 \\ u(1, \theta) &= f(\theta) \end{aligned}$$



The Laplacian in circular coordinates is

$$\Delta u \equiv \frac{\partial^2 u}{\partial r^2} + \frac{1}{r} \frac{\partial u}{\partial r} + \frac{1}{r^2} \frac{\partial^2 u}{\partial \theta^2}.$$

**Hint, Solution**

### Exercise 37.10

Find the normal modes of oscillation of a drum head of unit radius. The drum head obeys the wave equation with zero displacement on the boundary.

$$\Delta v \equiv \frac{1}{r} \frac{\partial}{\partial r} \left( r \frac{\partial v}{\partial r} \right) + \frac{1}{r^2} \frac{\partial^2 v}{\partial \theta^2} = \frac{1}{c^2} \frac{\partial^2 v}{\partial t^2}, \quad v(1, \theta, t) = 0$$

**Hint, Solution**

### Exercise 37.11

Solve the equation

$$\phi_t = a^2 \phi_{xx}, \quad 0 < x < l, \quad t > 0$$

with boundary conditions  $\phi(0, t) = \phi(l, t) = 0$ , and initial conditions

$$\phi(x, 0) = \begin{cases} x, & 0 \leq x \leq l/2, \\ l - x, & l/2 < x \leq l. \end{cases}$$

Comment on the differentiability ( that is the number of finite derivatives with respect to  $x$  ) at time  $t = 0$  and at time  $t = \epsilon$ , where  $\epsilon > 0$  and  $\epsilon \ll 1$ .

**Hint, Solution**

### Exercise 37.12

Consider a one-dimensional rod of length  $L$  with initial temperature distribution  $f(x)$ . The temperatures at the left and right ends of the rod are held at  $T_0$  and  $T_1$ , respectively. To find the temperature of the rod for  $t > 0$ , solve

$$u_t = \kappa u_{xx}, \quad 0 < x < L, \quad t > 0 \\ u(0, t) = T_0, \quad u(L, t) = T_1, \quad u(x, 0) = f(x),$$

with separation of variables.

**Hint, Solution**

### Exercise 37.13

For  $0 < x < l$  solve the problem

$$\begin{aligned}\phi_t &= a^2 \phi_{xx} + w(x, t) \\ \phi(0, t) &= 0, \quad \phi_x(l, t) = 0, \quad \phi(x, 0) = f(x)\end{aligned}\tag{37.5}$$

by means of a series expansion involving the eigenfunctions of

$$\begin{aligned}\frac{d^2\beta(x)}{dx^2} + \lambda\beta(x) &= 0, \\ \beta(0) &= \beta'(l) = 0.\end{aligned}$$

Here  $w(x, t)$  and  $f(x)$  are prescribed functions.

**Hint, Solution**

### Exercise 37.14

Solve the heat equation of Exercise 37.13 with the same initial conditions but with the boundary conditions

$$\phi(0, t) = 0, \quad c\phi(l, t) + \phi_x(l, t) = 0.$$

Here  $c > 0$  is a constant. Although it is not possible to solve for the eigenvalues  $\lambda$  in closed form, show that the eigenvalues assume a simple form for large values of  $\lambda$ .

**Hint, Solution**

### Exercise 37.15

Use a series expansion technique to solve the problem

$$\phi_t = a^2 \phi_{xx} + 1, \quad t > 0, \quad 0 < x < l$$

with boundary and initial conditions given by

$$\phi(x, 0) = 0, \quad \phi(0, t) = t, \quad \phi_x(l, t) = -c\phi(l, t)$$

where  $c > 0$  is a constant.

**Hint, Solution**

### Exercise 37.16

Let  $\phi(x, t)$  satisfy the equation

$$\phi_t = a^2 \phi_{xx}$$

for  $0 < x < l$ ,  $t > 0$  with initial conditions  $\phi(x, 0) = 0$  for  $0 < x < l$ , with boundary conditions  $\phi(0, t) = 0$  for  $t > 0$ , and  $\phi(l, t) + \phi_x(l, t) = 1$  for  $t > 0$ . Obtain two series solutions for this problem, one which is useful for large  $t$  and the other useful for small  $t$ .

**Hint, Solution**

### Exercise 37.17

A rod occupies the portion  $1 < x < 2$  of the  $x$ -axis. The thermal conductivity depends on  $x$  in such a manner that the temperature  $\phi(x, t)$  satisfies the equation

$$\phi_t = A^2 (x^2 \phi_x)_x \quad (37.6)$$

where  $A$  is a constant. For  $\phi(1, t) = \phi(2, t) = 0$  for  $t > 0$ , with  $\phi(x, 0) = f(x)$  for  $1 < x < 2$ , show that the appropriate series expansion involves the eigenfunctions

$$\beta_n(x) = \frac{1}{\sqrt{x}} \sin\left(\frac{\pi n \ln x}{\ln 2}\right).$$

Work out the series expansion for the given boundary and initial conditions.

**Hint, Solution**

### Exercise 37.18

Consider a string of length  $L$  with a fixed left end a free right end. Initially the string is at rest with displacement  $f(x)$ . Find the motion of the string by solving,

$$\begin{aligned} u_{tt} &= c^2 u_{xx}, & 0 < x < L, & \quad t > 0, \\ u(0, t) &= 0, & u_x(L, t) &= 0, \\ u(x, 0) &= f(x), & u_t(x, 0) &= 0, \end{aligned}$$

with separation of variables.

[Hint](#), [Solution](#)

### Exercise 37.19

Consider the equilibrium temperature distribution in a two-dimensional block of width  $a$  and height  $b$ . There is a heat source given by the function  $f(x, y)$ . The vertical sides of the block are held at zero temperature; the horizontal sides are insulated. To find this equilibrium temperature distribution, solve the potential equation,

$$\begin{aligned}u_{xx} + u_{yy} &= f(x, y), & 0 < x < a, & \quad 0 < y < b, \\u(0, y) = u(a, y) &= 0, & u_y(x, 0) = u_y(x, b) &= 0,\end{aligned}$$

with separation of variables.

[Hint](#), [Solution](#)

### Exercise 37.20

Consider the vibrations of a stiff beam of length  $L$ . More precisely, consider the transverse vibrations of an unloaded beam, whose weight can be neglected compared to its stiffness. The beam is simply supported at  $x = 0, L$ . (That is, it is resting on fulcrums there.  $u(0, t) = 0$  means that the beam is resting on the fulcrum;  $u_{xx}(0, t) = 0$  indicates that there is no bending force at that point.) The beam has initial displacement  $f(x)$  and velocity  $g(x)$ . To determine the motion of the beam, solve

$$\begin{aligned}u_{tt} + a^2 u_{xxxx} &= 0, & 0 < x < L, & \quad t > 0, \\u(x, 0) &= f(x), & u_t(x, 0) &= g(x), \\u(0, t) = u_{xx}(0, t) &= 0, & u(L, t) = u_{xx}(L, t) &= 0,\end{aligned}$$

with separation of variables.

[Hint](#), [Solution](#)

### Exercise 37.21

The temperature along a magnet winding of length  $L$  carrying a current  $I$  satisfies, (for some  $\alpha > 0$ ):

$$u_t = \kappa u_{xx} + I^2 \alpha u.$$

The ends of the winding are kept at zero, i.e.,

$$u(0, t) = u(L, t) = 0;$$

and the initial temperature distribution is

$$u(x, 0) = g(x).$$

Find  $u(x, t)$  and determine the critical current  $I_{CR}$  which is defined as the least current at which the winding begins to heat up exponentially. Suppose that  $\alpha < 0$ , so that the winding has a negative coefficient of resistance with respect to temperature. What can you say about the critical current in this case?

**Hint, Solution**

### Exercise 37.22

The "e-folding" time of a decaying function of time is the time interval,  $\Delta_e$ , in which the magnitude of the function is reduced by at least  $\frac{1}{e}$ . Thus if  $u(x, t) = e^{-\alpha t} f(x) + e^{-\beta t} g(x)$  with  $\alpha > \beta > 0$  then  $\Delta_e = \frac{1}{\beta}$ . A body with heat conductivity  $\kappa$  has its exterior surface maintained at temperature zero. Initially the interior of the body is at the uniform temperature  $T > 0$ . Find the e-folding time of the body if it is:

- a) An infinite slab of thickness  $a$ .
- b) An infinite cylinder of radius  $a$ .
- c) A sphere of radius  $a$ .

Note that in (a) the temperature varies only in the  $z$  direction and in time; in (b) and (c) the temperature varies only in the radial direction and in time.

- d) What are the e-folding times if the surfaces are perfectly insulated, (i.e.,  $\frac{\partial u}{\partial n} = 0$ , where  $n$  is the exterior normal at the surface)?

**Hint, Solution**

### Exercise 37.23

Solve the heat equation with a time-dependent diffusivity in the rectangle  $0 < x < a$ ,  $0 < y < b$ . The top and bottom sides are held at temperature zero; the lateral sides are insulated. We have the initial-boundary value problem:

$$\begin{aligned}u_t &= \kappa(t)(u_{xx} + u_{yy}), & 0 < x < a, & \quad 0 < y < b, & \quad t > 0, \\u(x, 0, t) &= u(x, b, t) = 0, \\u_x(0, y, t) &= u_x(a, y, t) = 0, \\u(x, y, 0) &= f(x, y).\end{aligned}$$

The diffusivity,  $\kappa(t)$ , is a known, positive function.

[Hint](#), [Solution](#)

### Exercise 37.24

A semi-circular rod of infinite extent is maintained at temperature  $T = 0$  on the flat side and at  $T = 1$  on the curved surface:

$$x^2 + y^2 = 1, \quad y > 0.$$

Find the steady state temperature in a cross section of the rod using separation of variables.

[Hint](#), [Solution](#)

### Exercise 37.25

Use separation of variables to find the steady state temperature  $u(x, y)$  in a slab:  $x \geq 0$ ,  $0 \leq y \leq 1$ , which has zero temperature on the faces  $y = 0$  and  $y = 1$  and has a given distribution:  $u(y, 0) = f(y)$  on the edge  $x = 0$ ,  $0 \leq y \leq 1$ .

[Hint](#), [Solution](#)

### Exercise 37.26

Find the solution of Laplace's equation subject to the boundary conditions.

$$\begin{aligned}\Delta u &= 0, & 0 < \theta < \alpha, & \quad a < r < b, \\u(r, 0) &= u(r, \alpha) = 0, & u(a, \theta) &= 0, & u(b, \theta) &= f(\theta).\end{aligned}$$

[Hint](#), [Solution](#)

### Exercise 37.27

**a)** A piano string of length  $L$  is struck, at time  $t = 0$ , by a flat hammer of width  $2d$  centered at a point  $\xi$ , having velocity  $v$ . Find the ensuing motion,  $u(x, t)$ , of the string for which the wave speed is  $c$ .

**b)** Suppose the hammer is curved, rather than flat as above, so that the initial velocity distribution is

$$u_t(x, 0) = \begin{cases} v \cos\left(\frac{\pi(x-\xi)}{2d}\right), & |x - \xi| < d \\ 0 & |x - \xi| > d. \end{cases}$$

Find the ensuing motion.

**c)** Compare the kinetic energies of each harmonic in the two solutions. Where should the string be struck in order to maximize the energy in the  $n^{\text{th}}$  harmonic in each case?

**Hint, Solution**

### Exercise 37.28

If the striking hammer is not perfectly rigid, then its effect must be included as a time dependent forcing term of the form:

$$s(x, t) = \begin{cases} v \cos\left(\frac{\pi(x-\xi)}{2d}\right) \sin\left(\frac{\pi t}{\delta}\right), & \text{for } |x - \xi| < d, \quad 0 < t < \delta, \\ 0 & \text{otherwise.} \end{cases}$$

Find the motion of the string for  $t > \delta$ . Discuss the effects of the width of the hammer and duration of the blow with regard to the energy in overtones.

**Hint, Solution**

### Exercise 37.29

Find the propagating modes in a square waveguide of side  $L$  for harmonic signals of frequency  $\omega$  when the propagation speed of the medium is  $c$ . That is, we seek those solutions of

$$u_{tt} - c^2 \Delta u = 0,$$

where  $u = u(x, y, z, t)$  has the form  $u(x, y, z, t) = v(x, y, z) e^{i\omega t}$ , which satisfy the conditions:

$$u(x, y, z, t) = 0 \quad \text{for} \quad x = 0, L, \quad y = 0, L, \quad z > 0,$$
$$\lim_{z \rightarrow \infty} |u| \neq \infty \quad \text{and} \quad \neq 0.$$

Indicate in terms of inequalities involving  $k = \omega/c$  and appropriate eigenvalues,  $\lambda_{n,m}$  say, for which  $n$  and  $m$  the solutions  $u_{n,m}$  satisfy the conditions.

**Hint, Solution**

### Exercise 37.30

Find the modes of oscillation and their frequencies for a rectangular drum head of width  $a$  and height  $b$ . The modes of oscillation are eigensolutions of

$$u_{tt} = c^2 \Delta u, \quad 0 < x < a, \quad 0 < y < b,$$
$$u(0, y) = u(a, y) = u(x, 0) = u(x, b) = 0.$$

**Hint, Solution**

### Exercise 37.31

Using separation of variables solve the heat equation

$$\phi_t = a^2 (\phi_{xx} + \phi_{yy})$$

in the rectangle  $0 < x < l_x, 0 < y < l_y$  with initial conditions

$$\phi(x, y, 0) = 1,$$

and boundary conditions

$$\phi(0, y, t) = \phi(l_x, y, t) = 0, \quad \phi_y(x, 0, t) = \phi_y(x, l_y, t) = 0.$$

**Hint, Solution**



### Exercise 37.32

Using polar coordinates and separation of variables solve the heat equation

$$\phi_t = a^2 \nabla^2 \phi$$

in the circle  $0 < r < R_0$  with initial conditions

$$\phi(r, \theta, 0) = V$$

where  $V$  is a constant, and boundary conditions

$$\phi(R_0, \theta, t) = 0.$$

1. Show that for  $t > 0$ ,

$$\phi(r, \theta, t) = 2V \sum_{n=1}^{\infty} \exp\left(-\frac{a^2 j_{0,n}^2 t}{R_0^2}\right) \frac{J_0(j_{0,n} r / R_0)}{j_{0,n} J_1(j_{0,n})},$$

where  $j_{0,n}$  are the roots of  $J_0(x)$ :

$$J_0(j_{0,n}) = 0, \quad n = 1, 2, \dots$$

*Hint: The following identities may be of some help:*

$$\begin{aligned} \int_0^{R_0} r J_0(j_{0,n} r / R_0) J_0(j_{0,m} r / R_0) dr &= 0, & m \neq n, \\ \int_0^{R_0} r J_0^2(j_{0,n} r / R_0) dr &= \frac{R_0^2}{2} J_1^2(j_{0,n}), \\ \int_0^r r J_0(\beta r) dr &= \frac{r}{\beta} J_1(\beta r) & \text{for any } \beta. \end{aligned}$$

2. For any fixed  $r$ ,  $0 < r < R_0$ , use the asymptotic approximation for the  $J_n$  Bessel functions for large argument (this can be found in any standard math tables) to determine the rate of decay of the terms of the series solution for  $\phi$  at time  $t = 0$ .

**Hint, Solution**

### Exercise 37.33

Consider the solution of the diffusion equation in spherical coordinates given by

$$\begin{aligned}x &= r \sin \theta \cos \phi, \\y &= r \sin \theta \sin \phi, \\z &= r \cos \theta,\end{aligned}$$

where  $r$  is the radius,  $\theta$  is the polar angle, and  $\phi$  is the azimuthal angle. We wish to solve the equation on the surface of the sphere given by  $r = R$ ,  $0 < \theta < \pi$ , and  $0 < \phi < 2\pi$ . The diffusion equation for the solution  $\Psi(\theta, \phi, t)$  in these coordinates on the surface of the sphere becomes

$$\frac{\partial \Psi}{\partial t} = \frac{a^2}{R^2} \left( \frac{1}{\sin \theta} \frac{\partial}{\partial \theta} \left( \sin \theta \frac{\partial \Psi}{\partial \theta} \right) + \frac{1}{\sin^2 \theta} \frac{\partial^2 \Psi}{\partial \phi^2} \right). \quad (37.7)$$

where  $a$  is a positive constant.

1. Using separation of variables show that a solution  $\Psi$  can be found in the form

$$\Psi(\theta, \phi, t) = T(t)\Theta(\theta)\Phi(\phi),$$

where  $T, \Theta, \Phi$  obey ordinary differential equations in  $t, \theta$ , and  $\phi$  respectively. Derive the ordinary differential equations for  $T$  and  $\Theta$ , and show that the differential equation obeyed by  $\Phi$  is given by

$$\frac{d^2 \Phi}{d\phi^2} - c\Phi = 0,$$

where  $c$  is a constant.

2. Assuming that  $\Psi(\theta, \phi, t)$  is determined over the full range of the azimuthal angle,  $0 < \phi < 2\pi$ , determine the allowable values of the separation constant  $c$  and the corresponding allowable functions  $\Phi$ . Using these values of  $c$  and letting  $x = \cos \theta$  rewrite in terms of the variable  $x$  the differential equation satisfied by  $\Theta$ . What are appropriate boundary conditions for  $\Theta$ ? The resulting equation is known as the generalized or associated Legendre equation.

3. Assume next that the initial conditions for  $\Psi$  are chosen such that

$$\Psi(\theta, \phi, t = 0) = f(\theta),$$

where  $f(\theta)$  is a specified function which is regular at the north and south poles (that is  $\theta = 0$  and  $\theta = \pi$ ). Note that the initial condition is independent of the azimuthal angle  $\phi$ . Show that in this case the method of separation of variables gives a series solution for  $\Psi$  of the form

$$\Psi(\theta, t) = \sum_{l=0}^{\infty} A_l \exp(-\lambda_l^2 t) P_l(\cos \theta),$$

where  $P_l(x)$  is the  $l$ 'th Legendre polynomial, and determine the constants  $\lambda_l$  as a function of the index  $l$ .

4. Solve for  $\Psi(\theta, t)$ ,  $t > 0$  given that  $f(\theta) = 2 \cos^2 \theta - 1$ .

*Useful facts:*

$$\frac{d}{dx} \left[ (1 - x^2) \frac{dP_l(x)}{dx} \right] + l(l + 1)P_l(x) = 0$$

$$P_0(x) = 1$$

$$P_1(x) = x$$

$$P_2(x) = \frac{3}{2}x^2 - \frac{1}{2}$$

$$\int_{-1}^1 dx P_l(x) P_m(x) = \begin{cases} 0 & \text{if } l \neq m \\ \frac{2}{2l + 1} & \text{if } l = m \end{cases}$$

**Hint, Solution**

### Exercise 37.34

Let  $\phi(x, y)$  satisfy Laplace's equation

$$\phi_{xx} + \phi_{yy} = 0$$

in the rectangle  $0 < x < 1$ ,  $0 < y < 2$ , with  $\phi(x, 2) = x(1 - x)$ , and with  $\phi = 0$  on the other three sides. Use a series solution to determine  $\phi$  inside the rectangle. How many terms are required to give  $\phi(\frac{1}{2}, 1)$  with about 1% (also 0.1%) accuracy; how about  $\phi_x(\frac{1}{2}, 1)$ ?

**Hint, Solution**

### Exercise 37.35

Let  $\psi(r, \theta, \phi)$  satisfy Laplace's equation in spherical coordinates in each of the two regions  $r < a$ ,  $r > a$ , with  $\psi \rightarrow 0$  as  $r \rightarrow \infty$ . Let

$$\begin{aligned} \lim_{r \rightarrow a^+} \psi(r, \theta, \phi) - \lim_{r \rightarrow a^-} \psi(r, \theta, \phi) &= 0, \\ \lim_{r \rightarrow a^+} \psi_r(r, \theta, \phi) - \lim_{r \rightarrow a^-} \psi_r(r, \theta, \phi) &= P_n^m(\cos \theta) \sin(m\phi), \end{aligned}$$

where  $m$  and  $n \geq m$  are integers. Find  $\psi$  in  $r < a$  and  $r > a$ . In electrostatics, this problem corresponds to that of determining the potential of a spherical harmonic type charge distribution over the surface of the sphere. In this way one can determine the potential due to an arbitrary surface charge distribution since any charge distribution can be expressed as a series of spherical harmonics.

**Hint, Solution**

### Exercise 37.36

Obtain a formula analogous to the Poisson formula to solve the Neumann problem for the circular region  $0 \leq r < R$ ,  $0 \leq \theta < 2\pi$ . That is, determine a solution  $\phi(r, \theta)$  to Laplace's equation

$$\nabla^2 \phi = 0$$

in polar coordinates given  $\phi_r(R, \theta)$ . Show that

$$\phi(r, \theta) = -\frac{R}{2\pi} \int_0^{2\pi} \phi_r(R, \alpha) \ln \left[ 1 - \frac{2r}{R} \cos(\theta - \alpha) + \frac{r^2}{R^2} \right] d\alpha$$

within an arbitrary additive constant.

**Hint, Solution**

**Exercise 37.37**

Investigate solutions of

$$\phi_t = a^2 \phi_{xx}$$

obtained by setting the separation constant  $C = (\alpha + i\beta)^2$  in the equations obtained by assuming  $\phi = X(x)T(t)$ :

$$\frac{T'}{T} = C, \quad \frac{X''}{X} = \frac{C}{a^2}.$$

Hint, Solution

## 37.9 Hints

**Hint 37.1**

**Hint 37.2**

**Hint 37.3**

**Hint 37.4**

**Hint 37.5**

**Hint 37.6**

**Hint 37.7**

Impose the boundary conditions

$$u(0, t) = u(2\pi, t), \quad u_\theta(0, t) = u_\theta(2\pi, t).$$

**Hint 37.8**

Apply the separation of variables  $u(x, y) = X(x)Y(y)$ . Solve an eigenvalue problem for  $X(x)$ .

**Hint 37.9**

**Hint 37.10**

**Hint 37.11****Hint 37.12**

There are two ways to solve the problem. For the first method, expand the solution in a series of the form

$$u(x, t) = \sum_{n=1}^{\infty} a_n(t) \sin\left(\frac{n\pi x}{L}\right).$$

Because of the inhomogeneous boundary conditions, the convergence of the series will not be uniform. You can differentiate the series with respect to  $t$ , but not with respect to  $x$ . Multiply the partial differential equation by the eigenfunction  $\sin(n\pi x/L)$  and integrate from  $x = 0$  to  $x = L$ . Use integration by parts to move derivatives in  $x$  from  $u$  to the eigenfunctions. This process will yield a first order, ordinary differential equation for each of the  $a_n$ 's.

For the second method: Make the change of variables  $v(x, t) = u(x, t) - \mu(x)$ , where  $\mu(x)$  is the equilibrium temperature distribution to obtain a problem with homogeneous boundary conditions.

**Hint 37.13****Hint 37.14****Hint 37.15****Hint 37.16****Hint 37.17**

**Hint 37.18**

Use separation of variables to find eigen-solutions of the partial differential equation that satisfy the homogeneous boundary conditions. There will be two eigen-solutions for each eigenvalue. Expand  $u(x, t)$  in a series of the eigen-solutions. Use the two initial conditions to determine the constants.

**Hint 37.19**

Expand the solution in a series of eigenfunctions in  $x$ . Determine these eigenfunctions by using separation of variables on the homogeneous partial differential equation. You will find that the answer has the form,

$$u(x, y) = \sum_{n=1}^{\infty} u_n(y) \sin\left(\frac{n\pi x}{a}\right).$$

Substitute this series into the partial differential equation to determine ordinary differential equations for each of the  $u_n$ 's. The boundary conditions on  $u(x, y)$  will give you boundary conditions for the  $u_n$ 's. Solve these ordinary differential equations with Green functions.

**Hint 37.20**

Solve this problem by expanding the solution in a series of eigen-solutions that satisfy the partial differential equation and the homogeneous boundary conditions. Use the initial conditions to determine the coefficients in the expansion.

**Hint 37.21**

Use separation of variables to find eigen-solutions that satisfy the partial differential equation and the homogeneous boundary conditions. The solution is a linear combination of the eigen-solutions. The whole solution will be exponentially decaying if each of the eigen-solutions is exponentially decaying.

**Hint 37.22**

For parts (a), (b) and (c) use separation of variables. For part (b) the eigen-solutions will involve Bessel functions. For part (c) the eigen-solutions will involve spherical Bessel functions. Part (d) is trivial.

**Hint 37.23**

The solution is a linear combination of eigen-solutions of the partial differential equation that satisfy the homogeneous boundary conditions. Determine the coefficients in the expansion with the initial condition.



**Hint 37.24**

The problem is

$$u_{rr} + \frac{1}{r}u_r + \frac{1}{r^2}u_{\theta\theta} = 0, \quad 0 < r < 1, \quad 0 < \theta < \pi$$
$$u(r, 0) = u(r, \pi) = 0, \quad u(0, \theta) = 0, \quad u(1, \theta) = 1$$

The solution is a linear combination of eigen-solutions that satisfy the partial differential equation and the three homogeneous boundary conditions.

**Hint 37.25****Hint 37.26****Hint 37.27****Hint 37.28****Hint 37.29****Hint 37.30****Hint 37.31****Hint 37.32**

**Hint 37.33**

**Hint 37.34**

**Hint 37.35**

**Hint 37.36**

**Hint 37.37**

## 37.10 Solutions

### Solution 37.1

We expand the solution in eigenfunctions in  $x$  and  $y$  which satisfy the boundary conditions.

$$u = \sum_{m,n=1}^{\infty} u_{mn}(t) \sin\left(\frac{m\pi x}{a}\right) \sin\left(\frac{n\pi y}{b}\right)$$

We expand the inhomogeneities in the eigenfunctions.

$$\begin{aligned} q(x, y, t) &= \sum_{m,n=1}^{\infty} q_{mn}(t) \sin\left(\frac{m\pi x}{a}\right) \sin\left(\frac{n\pi y}{b}\right) \\ q_{mn}(t) &= \frac{4}{ab} \int_0^a \int_0^b q(x, y, t) \sin\left(\frac{m\pi x}{a}\right) \sin\left(\frac{n\pi y}{b}\right) dy dx \\ f(x, y) &= \sum_{m,n=1}^{\infty} f_{mn} \sin\left(\frac{m\pi x}{a}\right) \sin\left(\frac{n\pi y}{b}\right) \\ f_{mn} &= \frac{4}{ab} \int_0^a \int_0^b f(x, y) \sin\left(\frac{m\pi x}{a}\right) \sin\left(\frac{n\pi y}{b}\right) dy dx \end{aligned}$$

We substitute the expansion of the solution into the diffusion equation and the initial condition to determine initial value problems for the coefficients in the expansion.

$$\begin{aligned}
 u_t - \kappa(u_{xx} + u_{yy}) &= q(x, y, t) \\
 \sum_{m,n=1}^{\infty} \left( u'_{mn}(t) + \kappa \left( \left( \frac{m\pi}{a} \right)^2 + \left( \frac{n\pi}{b} \right)^2 \right) u_{mn}(t) \right) \sin \left( \frac{m\pi x}{a} \right) \sin \left( \frac{n\pi y}{b} \right) &= \sum_{m,n=1}^{\infty} q_{mn}(t) \sin \left( \frac{m\pi x}{a} \right) \sin \left( \frac{n\pi y}{b} \right) \\
 u'_{mn}(t) + \kappa \left( \left( \frac{m\pi}{a} \right)^2 + \left( \frac{n\pi}{b} \right)^2 \right) u_{mn}(t) &= q_{mn}(t) \\
 u(x, y, 0) &= f(x, y) \\
 \sum_{m,n=1}^{\infty} u_{mn}(0) \sin \left( \frac{m\pi x}{a} \right) \sin \left( \frac{n\pi y}{b} \right) &= \sum_{m,n=1}^{\infty} f_{mn} \sin \left( \frac{m\pi x}{a} \right) \sin \left( \frac{n\pi y}{b} \right) \\
 u_{mn}(0) &= f_{mn}
 \end{aligned}$$

We solve the ordinary differential equations for the coefficients  $u_{mn}(t)$  subject to their initial conditions.

$$u_{mn}(t) = \int_0^t \exp \left( -\kappa \left( \left( \frac{m\pi}{a} \right)^2 + \left( \frac{n\pi}{b} \right)^2 \right) (t - \tau) \right) q_{mn}(\tau) d\tau + f_{mn} \exp \left( -\kappa \left( \left( \frac{m\pi}{a} \right)^2 + \left( \frac{n\pi}{b} \right)^2 \right) t \right)$$

### Solution 37.2

After looking at this problem for a minute or two, it seems like the answer would have the form

$$u = \sin(x)T(t).$$

This form satisfies the boundary conditions. We substitute it into the heat equation and the initial condition to determine

$T$

$$\sin(x)T' = -\kappa \sin(x)T + A \sin(x), \quad T(0) = 0$$

$$T' + \kappa T = A, \quad T(0) = 0$$

$$T = \frac{A}{\kappa} + c e^{-\kappa t}$$

$$T = \frac{A}{\kappa} (1 - e^{-\kappa t})$$

Now we have the solution of the heat equation.

$$u = \frac{A}{\kappa} \sin(x) (1 - e^{-\kappa t})$$

### Solution 37.3

First we write the Laplacian in polar coordinates.

$$u_{rr} + \frac{1}{r}u_r + \frac{1}{r^2}u_{\theta\theta} = 0$$

1. We introduce the separation of variables  $u(r, \theta) = R(r)\Theta(\theta)$ .

$$R''\Theta + \frac{1}{r}R'\Theta + \frac{1}{r^2}R\Theta'' = 0$$

$$r^2 \frac{R''}{R} + r \frac{R'}{R} = -\frac{\Theta''}{\Theta} = \lambda$$

We have a regular Sturm-Liouville problem for  $\Theta$  and a differential equation for  $R$ .

$$\begin{aligned} \Theta'' + \lambda\Theta &= 0, & \Theta'(0) &= \Theta(\pi/2) = 0 \\ r^2 R'' + rR' - \lambda R &= 0, & R &\text{ is bounded} \end{aligned} \tag{37.8}$$

First we solve the problem for  $\Theta$  to determine the eigenvalues and eigenfunctions. The Rayleigh quotient is

$$\lambda = \frac{\int_0^{\pi/2} (\Theta')^2 d\theta}{\int_0^{\pi/2} \Theta^2 d\theta}$$

Immediately we see that the eigenvalues are non-negative. If  $\Theta' = 0$ , then the right boundary condition implies that  $\Theta = 0$ . Thus  $\lambda = 0$  is not an eigenvalue. We find the general solution of Equation 37.8 for positive  $\lambda$ .

$$\Theta = c_1 \cos(\sqrt{\lambda}\theta) + c_2 \sin(\sqrt{\lambda}\theta)$$

The solution that satisfies the left boundary condition is

$$\Theta = c \cos(\sqrt{\lambda}\theta).$$

We apply the right boundary condition to determine the eigenvalues.

$$\begin{aligned} \cos\left(\sqrt{\lambda}\frac{\pi}{2}\right) &= 0 \\ \lambda_n &= (2n-1)^2, \quad \Theta_n = \cos((2n-1)\theta), \quad n \in \mathbb{Z}^+ \end{aligned}$$

Now we solve the differential equation for  $R$ . Since this is an Euler equation, we make the substitution  $R = r^\alpha$ .

$$\begin{aligned} r^2 R_n'' + r R_n' - (2n-1)^2 R_n &= 0 \\ \alpha(\alpha-1) + \alpha - (2n-1)^2 &= 0 \\ \alpha &= \pm(2n-1) \\ R_n &= c_1 r^{2n-1} + c_2 r^{1-2n} \end{aligned}$$

The solution which is bounded in  $0 \leq r \leq 1$  is

$$R_n = r^{2n-1}.$$

The solution of Laplace's equation is a linear combination of the eigensolutions.

$$u = \sum_{n=1}^{\infty} u_n r^{2n-1} \cos((2n-1)\theta)$$

We use the boundary condition at  $r = 1$  to determine the coefficients.

$$u(1, \theta) = f(\theta) = \sum_{n=1}^{\infty} u_n \cos((2n-1)\theta)$$

$$u_n = \frac{4}{\pi} \int_0^{\pi/2} f(\theta) \cos((2n-1)\theta) d\theta$$

2. We introduce the separation of variables  $u(r, \theta) = R(r)\Theta(\theta)$ .

$$R''\Theta + \frac{1}{r}R'\Theta + \frac{1}{r^2}R\Theta'' = 0$$

$$r^2 \frac{R''}{R} + r \frac{R'}{R} = -\frac{\Theta''}{\Theta} = \lambda$$

We have a regular Sturm-Liouville problem for  $\Theta$  and a differential equation for  $R$ .

$$\Theta'' + \lambda\Theta = 0, \quad \Theta'(0) = \Theta'(\pi/2) = 0 \tag{37.9}$$

$$r^2 R'' + rR' - \lambda R = 0, \quad R \text{ is bounded}$$

First we solve the problem for  $\Theta$  to determine the eigenvalues and eigenfunctions. We recognize this problem as the generator of the Fourier cosine series.

$$\lambda_n = (2n)^2, \quad n \in \mathbb{Z}^{0+},$$

$$\Theta_0 = \frac{1}{2}, \quad \Theta_n = \cos(2n\theta), \quad n \in \mathbb{Z}^+$$

Now we solve the differential equation for  $R$ . Since this is an Euler equation, we make the substitution  $R = r^\alpha$ .

$$r^2 R_n'' + r R_n' - (2n)^2 R_n = 0$$

$$\alpha(\alpha - 1) + \alpha - (2n)^2 = 0$$

$$\alpha = \pm 2n$$

$$R_0 = c_1 + c_2 \ln(r), \quad R_n = c_1 r^{2n} + c_2 r^{-2n}, \quad n \in \mathbb{Z}^+$$

The solutions which are bounded in  $0 \leq r \leq 1$  are

$$R_n = r^{2n}.$$

The solution of Laplace's equation is a linear combination of the eigensolutions.

$$u = \frac{u_0}{2} + \sum_{n=1}^{\infty} u_n r^{2n} \cos(2n\theta)$$

We use the boundary condition at  $r = 1$  to determine the coefficients.

$$u_r(1, \theta) = \sum_{n=1}^{\infty} 2n u_n \cos(2n\theta) = g(\theta)$$

Note that the constant term is missing in this cosine series.  $g(\theta)$  has such a series expansion only if

$$\int_0^{\pi/2} g(\theta) d\theta = 0.$$

This is the condition for the existence of a solution of the problem. If this is satisfied, we can solve for the coefficients in the expansion.  $u_0$  is arbitrary.

$$u_n = \frac{4}{\pi} \int_0^{\pi/2} g(\theta) \cos(2n\theta) d\theta, \quad n \in \mathbb{Z}^+$$



## Solution 37.4

1.

$$\begin{aligned}u_t &= \nu(u_{xx} + u_{yy}) \\XYT' &= \nu(X''YT + XY''T) \\ \frac{T'}{\nu T} &= \frac{X''}{X} + \frac{Y''}{Y} = -\lambda \\ \frac{X''}{X} &= -\frac{Y''}{Y} - \lambda = -\mu\end{aligned}$$

We have boundary value problems for  $X(x)$  and  $Y(y)$  and a differential equation for  $T(t)$ .

$$\begin{aligned}X'' + \mu X &= 0, & X'(0) &= X'(1) = 0 \\ Y'' + (\lambda - \mu)Y &= 0, & Y(0) &= Y(1) = 0 \\ T' &= -\lambda\nu T\end{aligned}$$

2. The solutions for  $X(x)$  form a cosine series.

$$\mu_m = m^2\pi^2, \quad m \in \mathbb{Z}^{0+}, \quad X_0 = \frac{1}{2}, \quad X_m = \cos(m\pi x)$$

The solutions for  $Y(y)$  form a sine series.

$$\lambda_{mn} = (m^2 + n^2)\pi^2, \quad n \in \mathbb{Z}^+, \quad Y_n = \sin(n\pi x)$$

We solve the ordinary differential equation for  $T(t)$ .

$$T_{mn} = e^{-\nu(m^2+n^2)\pi^2 t}$$

We expand the solution of the heat equation in a series of the eigensolutions.

$$u(x, y, t) = \frac{1}{2} \sum_{n=1}^{\infty} u_{0n} \sin(n\pi y) e^{-\nu n^2 \pi^2 t} + \sum_{m=1}^{\infty} \sum_{n=1}^{\infty} u_{mn} \cos(m\pi x) \sin(n\pi y) e^{-\nu(m^2+n^2)\pi^2 t}$$

We use the initial condition to determine the coefficients.

$$u(x, y, 0) = f(x, y) = \frac{1}{2} \sum_{n=1}^{\infty} u_{0n} \sin(n\pi y) + \sum_{m=1}^{\infty} \sum_{n=1}^{\infty} u_{mn} \cos(m\pi x) \sin(n\pi y)$$

$$u_{mn} = 4 \int_0^1 \int_0^1 f(x, y) \cos(m\pi x) \sin(n\pi y) \, dx \, dy$$

### Solution 37.5

We use the separation of variables  $u(x, t) = X(x)T(t)$  to find eigensolutions of the heat equation that satisfy the boundary conditions at  $x = 0, \pi$ .

$$u_t = \nu u_{xx}$$

$$XT' = \nu X''T$$

$$\frac{T'}{\nu T} = \frac{X''}{X} = -\lambda$$

The problem for  $X(x)$  is

$$X'' + \lambda X = 0, \quad X'(0) = X'(\pi) = 0.$$

The eigenfunctions form the familiar cosine series.

$$\lambda_n = n^2, \quad n \in \mathbb{Z}^{0+}, \quad X_0 = \frac{1}{2}, \quad X_n = \cos(nx)$$

Next we solve the differential equation for  $T(t)$ .

$$T'_n = -\nu n^2 T_n$$

$$T_0 = 1, \quad T_n = e^{-\nu n^2 t}$$

We expand the solution of the heat equation in a series of the eigensolutions.

$$u(x, t) = \frac{1}{2} u_0 + \sum_{n=1}^{\infty} u_n \cos(nx) e^{-\nu n^2 t}$$

We use the initial condition to determine the coefficients in the series.

$$u(x, 0) = x = \frac{1}{2}u_0 + \sum_{n=1}^{\infty} u_n \cos(nx)$$

$$u_0 = \frac{2}{\pi} \int_0^{\pi} x \, dx = \pi$$

$$u_n = \frac{2}{\pi} \int_0^{\pi} x \cos(nx) \, dx = \begin{cases} 0 & \text{even } n \\ -\frac{4}{\pi n^2} & \text{odd } n \end{cases}$$

$$u(x, t) = \frac{\pi}{2} - \sum_{\substack{n=1 \\ \text{odd } n}}^{\infty} \frac{4}{\pi n^2} \cos(nx) e^{-\nu n^2 t}$$

### Solution 37.6

We expand the solution in a Fourier series.

$$\phi = \frac{1}{2}a_0(r) + \sum_{n=1}^{\infty} a_n(r) \cos(n\theta) + \sum_{n=1}^{\infty} b_n(r) \sin(n\theta)$$

We substitute the series into the Laplace's equation to determine ordinary differential equations for the coefficients.

$$\frac{\partial}{\partial r} \left( r \frac{\partial \phi}{\partial r} \right) + \frac{1}{r^2} \frac{\partial^2 \phi}{\partial \theta^2} = 0$$

$$a_0'' + \frac{1}{r} a_0' = 0, \quad a_n'' + \frac{1}{r} a_n' - n^2 a_n = 0, \quad b_n'' + \frac{1}{r} b_n' - n^2 b_n = 0$$

The solutions that are bounded at  $r = 0$  are, (to within multiplicative constants),

$$a_0(r) = 1, \quad a_n(r) = r^n, \quad b_n(r) = r^n.$$

Thus  $\phi(r, \theta)$  has the form

$$\phi(r, \theta) = \frac{1}{2}c_0 + \sum_{n=1}^{\infty} c_n r^n \cos(n\theta) + \sum_{n=1}^{\infty} d_n r^n \sin(n\theta)$$

We apply the boundary condition at  $r = R$ .

$$\phi(R, \theta) = \frac{1}{2}c_0 + \sum_{n=1}^{\infty} c_n R^n \cos(n\theta) + \sum_{n=1}^{\infty} d_n R^n \sin(n\theta)$$

The coefficients are

$$c_0 = \frac{1}{\pi} \int_0^{2\pi} \phi(R, \alpha) \, d\alpha, \quad c_n = \frac{1}{\pi R^n} \int_0^{2\pi} \phi(R, \alpha) \cos(n\alpha) \, d\alpha, \quad d_n = \frac{1}{\pi R^n} \int_0^{2\pi} \phi(R, \alpha) \sin(n\alpha) \, d\alpha.$$

We substitute the coefficients into our series solution.

$$\begin{aligned} \phi(r, \theta) &= \frac{1}{2\pi} \int_0^{2\pi} \phi(R, \alpha) \, d\alpha + \frac{1}{\pi} \sum_{n=1}^{\infty} \left(\frac{r}{R}\right)^n \int_0^{2\pi} \phi(R, \alpha) \cos(n(\theta - \alpha)) \, d\alpha \\ \phi(r, \theta) &= \frac{1}{2\pi} \int_0^{2\pi} \phi(R, \alpha) \, d\alpha + \frac{1}{\pi} \int_0^{2\pi} \phi(R, \alpha) \Re \left( \sum_{n=1}^{\infty} \left(\frac{r}{R}\right)^n e^{in(\theta - \alpha)} \right) \, d\alpha \\ \phi(r, \theta) &= \frac{1}{2\pi} \int_0^{2\pi} \phi(R, \alpha) \, d\alpha + \frac{1}{\pi} \int_0^{2\pi} \phi(R, \alpha) \Re \left( \frac{\frac{r}{R} e^{i(\theta - \alpha)}}{1 - \frac{r}{R} e^{i(\theta - \alpha)}} \right) \, d\alpha \\ \phi(r, \theta) &= \frac{1}{2\pi} \int_0^{2\pi} \phi(R, \alpha) \, d\alpha + \frac{1}{\pi} \int_0^{2\pi} \phi(R, \alpha) \Re \left( \frac{\frac{r}{R} e^{i(\theta - \alpha)} - \left(\frac{r}{R}\right)^2}{1 - 2\frac{r}{R} \cos(\theta - \alpha) + \left(\frac{r}{R}\right)^2} \right) \, d\alpha \\ \phi(r, \theta) &= \frac{1}{2\pi} \int_0^{2\pi} \phi(R, \alpha) \, d\alpha + \frac{1}{\pi} \int_0^{2\pi} \phi(R, \alpha) \frac{Rr \cos(\theta - \alpha) - r^2}{R^2 + r^2 - 2Rr \cos(\theta - \alpha)} \, d\alpha \\ \phi(r, \theta) &= \frac{1}{2\pi} \int_0^{2\pi} \phi(R, \alpha) \frac{R^2 - r^2}{R^2 + r^2 - 2Rr \cos(\theta - \alpha)} \, d\alpha \end{aligned}$$

### Solution 37.7

In order that the solution is continuously differentiable, (which it must be in order to satisfy the differential equation), we impose the boundary conditions

$$u(0, t) = u(2\pi, t), \quad u_\theta(0, t) = u_\theta(2\pi, t).$$

We apply the separation of variables  $u(\theta, t) = \Theta(\theta)T(t)$ .

$$\begin{aligned}u_t &= \kappa u_{\theta\theta} \\ \Theta T' &= \kappa \Theta'' T \\ \frac{T'}{\kappa T} &= \frac{\Theta''}{\Theta} = -\lambda\end{aligned}$$

We have the self-adjoint eigenvalue problem

$$\Theta'' + \lambda\Theta = 0, \quad \Theta(0) = \Theta(2\pi), \quad \Theta'(0) = \Theta'(2\pi)$$

which has the eigenvalues and orthonormal eigenfunctions

$$\lambda_n = n^2, \quad \Theta_n = \frac{1}{\sqrt{2\pi}} e^{in\theta}, \quad n \in \mathbb{Z}.$$

Now we solve the problems for  $T_n(t)$  to obtain eigen-solutions of the heat equation.

$$\begin{aligned}T_n' &= -n^2 \kappa T_n \\ T_n &= e^{-n^2 \kappa t}\end{aligned}$$

The solution is a linear combination of the eigen-solutions.

$$u(\theta, t) = \sum_{n=-\infty}^{\infty} u_n \frac{1}{\sqrt{2\pi}} e^{in\theta} e^{-n^2 \kappa t}$$

We use the initial conditions to determine the coefficients.

$$u(\theta, 0) = \sum_{n=-\infty}^{\infty} u_n \frac{1}{\sqrt{2\pi}} e^{in\theta} = f(\theta)$$

$$u_n = \frac{1}{\sqrt{2\pi}} \int_0^{2\pi} e^{-in\theta} f(\theta) d\theta$$

**Solution 37.8**

Substituting  $u(x, y) = X(x)Y(y)$  into the partial differential equation yields

$$\frac{X''}{X} = -\frac{Y''}{Y} = -\lambda.$$

With the homogeneous boundary conditions, we have the two problems

$$\begin{aligned} X'' + \lambda X &= 0, & X(0) &= X(1) = 0, \\ Y'' - \lambda Y &= 0, & Y(1) &= 0. \end{aligned}$$

The eigenvalues and orthonormal eigenfunctions for  $X(x)$  are

$$\lambda_n = (n\pi)^2, \quad X_n = \sqrt{2} \sin(n\pi x).$$

The general solution for  $Y$  is

$$Y_n = a \cosh(n\pi y) + b \sinh(n\pi y).$$

The solution for that satisfies the right homogeneous boundary condition, (up to a multiplicative constant), is

$$Y_n = \sinh(n\pi(1 - y))$$

$u(x, y)$  is a linear combination of the eigen-solutions.

$$u(x, y) = \sum_{n=1}^{\infty} u_n \sqrt{2} \sin(n\pi x) \sinh(n\pi(1 - y))$$

We use the inhomogeneous boundary condition to determine coefficients.

$$u(x, 0) = \sum_{n=1}^{\infty} u_n \sqrt{2} \sin(n\pi x) \sinh(n\pi) = f(x)$$

$$u_n = \sqrt{2} \int_0^1 \sin(n\pi\xi) f(\xi) \, d\xi$$

### Solution 37.9

We substitute  $u(r, \theta) = R(r)\Theta(\theta)$  into the partial differential equation.

$$\begin{aligned}\frac{\partial^2 u}{\partial r^2} + \frac{1}{r} \frac{\partial u}{\partial r} + \frac{1}{r^2} \frac{\partial^2 u}{\partial \theta^2} &= 0 \\ R''\Theta + \frac{1}{r}R'\Theta + \frac{1}{r^2}R\Theta'' &= 0 \\ r^2 \frac{R''}{R} + r \frac{R'}{R} &= -\frac{\Theta''}{\Theta} = \lambda \\ r^2 R'' + rR' - \lambda R &= 0, \quad \Theta'' + \lambda\Theta = 0\end{aligned}$$

We assume that  $u$  is a strong solution of the partial differential equation and is thus twice continuously differentiable, ( $u \in C^2$ ). In particular, this implies that  $R$  and  $\Theta$  are bounded and that  $\Theta$  is continuous and has a continuous first derivative along  $\theta = 0$ . This gives us a boundary value problem for  $\Theta$  and a differential equation for  $R$ .

$$\begin{aligned}\Theta'' + \lambda\Theta &= 0, \quad \Theta(0) = \Theta(2\pi), \quad \Theta'(0) = \Theta'(2\pi) \\ r^2 R'' + rR' - \lambda R &= 0, \quad R \text{ is bounded}\end{aligned}$$

The eigensolutions for  $\Theta$  form the familiar Fourier series.

$$\begin{aligned}\lambda_n &= n^2, \quad n \in \mathbb{Z}^{0+} \\ \Theta_0^{(1)} &= \frac{1}{2}, \quad \Theta_n^{(1)} = \cos(n\theta), \quad n \in \mathbb{Z}^+ \\ \Theta_n^{(2)} &= \sin(n\theta), \quad n \in \mathbb{Z}^+\end{aligned}$$

Now we find the bounded solutions for  $R$ . The equation for  $R$  is an Euler equation so we use the substitution  $R = r^\alpha$ .

$$\begin{aligned}r^2 R_n'' + rR_n' - \lambda_n R_n &= 0 \\ \alpha(\alpha - 1) + \alpha - \lambda_n &= 0 \\ \alpha &= \pm\sqrt{\lambda_n}\end{aligned}$$

First we consider the case  $\lambda_0 = 0$ . The solution is

$$R = a + b \ln r.$$

Boundedness demands that  $b = 0$ . Thus we have the solution

$$R = 1.$$

Now we consider the case  $\lambda_n = n^2 > 0$ . The solution is

$$R_n = ar^n + br^{-n}.$$

Boundedness demands that  $b = 0$ . Thus we have the solution

$$R_n = r^n.$$

The solution for  $u$  is a linear combination of the eigensolutions.

$$u(r, \theta) = \frac{a_0}{2} + \sum_{n=1}^{\infty} (a_n \cos(n\theta) + b_n \sin(n\theta)) r^n$$

The boundary condition at  $r = 1$  determines the coefficients in the expansion.

$$u(1, \theta) = \frac{a_0}{2} + \sum_{n=1}^{\infty} [a_n \cos(n\theta) + b_n \sin(n\theta)] = f(\theta)$$
$$a_n = \frac{1}{\pi} \int_0^{2\pi} f(\theta) \cos(n\theta) d\theta, \quad b_n = \frac{1}{\pi} \int_0^{2\pi} f(\theta) \sin(n\theta) d\theta$$

### Solution 37.10

A normal mode of frequency  $\omega$  is periodic in time.

$$v(r, \theta, t) = u(r, \theta) e^{i\omega t}$$



We substitute this form into the wave equation to obtain a Helmholtz equation, (also called a reduced wave equation).

$$\frac{1}{r} \frac{\partial}{\partial r} \left( r \frac{\partial u}{\partial r} \right) + \frac{1}{r^2} \frac{\partial^2 u}{\partial \theta^2} = -\frac{\omega^2}{c^2} u, \quad u(1, \theta) = 0,$$

$$\frac{\partial^2 u}{\partial r^2} + \frac{1}{r} \frac{\partial u}{\partial r} + \frac{1}{r^2} \frac{\partial^2 u}{\partial \theta^2} + k^2 u = 0, \quad u(1, \theta) = 0$$

Here we have defined  $k = \frac{\omega}{c}$ . We apply the separation of variables  $u = R(r)\Theta(\theta)$  to the Helmholtz equation.

$$r^2 R'' \Theta + r R' \Theta + R \Theta'' + k^2 r^2 R \Theta = 0,$$

$$r^2 \frac{R''}{R} + r \frac{R'}{R} + k^2 r^2 = -\frac{\Theta''}{\Theta} = \lambda^2$$

Now we have an ordinary differential equation for  $R(r)$  and an eigenvalue problem for  $\Theta(\theta)$ .

$$R'' + \frac{1}{r} R' + \left( k^2 - \frac{\lambda^2}{r^2} \right) R = 0, \quad R(0) \text{ is bounded}, \quad R(1) = 0,$$

$$\Theta'' + \lambda^2 \Theta = 0, \quad \Theta(-\pi) = \Theta(\pi), \quad \Theta'(-\pi) = \Theta'(\pi).$$

We compute the eigenvalues and eigenfunctions for  $\Theta$ .

$$\lambda_n = n, \quad n \in \mathbb{Z}^{0+}$$

$$\Theta_0 = \frac{1}{2}, \quad \Theta_n^{(1)} = \cos(n\theta), \quad \Theta_n^{(2)} = \sin(n\theta), \quad n \in \mathbb{Z}^+$$

The differential equations for the  $R_n$  are Bessel equations.

$$R_n'' + \frac{1}{r} R_n' + \left( k^2 - \frac{n^2}{r^2} \right) R_n = 0, \quad R_n(0) \text{ is bounded}, \quad R_n(1) = 0$$

The general solution is a linear combination of order  $n$  Bessel functions of the first and second kind.

$$R_n(r) = c_1 J_n(kr) + c_2 Y_n(kr)$$

Since the Bessel function of the second kind,  $Y_n(kr)$ , is unbounded at  $r = 0$ , the solution has the form

$$R_n(r) = cJ_n(kr).$$

Applying the second boundary condition gives us the admissible frequencies.

$$J_n(k) = 0$$

$$k_{nm} = j_{nm}, \quad R_{nm} = J_n(j_{nm}r), \quad n \in \mathbb{Z}^{0+}, \quad m \in \mathbb{Z}^+$$

Here  $j_{nm}$  is the  $m^{\text{th}}$  positive root of  $J_n$ . We combining the above results to obtain the normal modes of oscillation.

$$v_{0m} = \frac{1}{2}J_0(j_{0m}r) e^{icj_{0m}t}, \quad m \in \mathbb{Z}^+$$

$$v_{nm} = \cos(n\theta + \alpha)J_{nm}(j_{nm}r) e^{icj_{nm}t}, \quad n, m \in \mathbb{Z}^+$$

Some normal modes are plotted in Figure 37.2. Note that  $\cos(n\theta + \alpha)$  represents a linear combination of  $\cos(n\theta)$  and  $\sin(n\theta)$ . This form is preferable as it illustrates the circular symmetry of the problem.

### Solution 37.11

We will expand the solution in a complete, orthogonal set of functions  $\{X_n(x)\}$ , where the coefficients are functions of  $t$ .

$$\phi = \sum_n T_n(t)X_n(x)$$

We will use separation of variables to determine a convenient set  $\{X_n\}$ . We substitute  $\phi = T(t)X(x)$  into the diffusion equation.

$$\phi_t = a^2\phi_{xx}$$

$$XT' = a^2X''T$$

$$\frac{T'}{a^2T} = \frac{X''}{X} = -\lambda$$

$$T' = -a^2\lambda T, \quad X'' + \lambda X = 0$$

Note that in order to satisfy  $\phi(0, t) = \phi(l, t) = 0$ , the  $X_n$  must satisfy the same homogeneous boundary conditions,  $X_n(0) = X_n(l) = 0$ . This gives us a Sturm-Liouville problem for  $X(x)$ .

$$X'' + \lambda X = 0, \quad X(0) = X(l) = 0$$

$$\lambda_n = \left(\frac{n\pi}{l}\right)^2, \quad X_n = \sin\left(\frac{n\pi x}{l}\right), \quad n \in \mathbb{Z}^+$$

Thus we seek a solution of the form

$$\phi = \sum_{n=1}^{\infty} T_n(t) \sin\left(\frac{n\pi x}{l}\right). \quad (37.10)$$

This solution automatically satisfies the boundary conditions. We will assume that we can differentiate it. We will substitute this form into the diffusion equation and the initial condition to determine the coefficients in the series,  $T_n(t)$ . First we substitute Equation 37.10 into the partial differential equation for  $\phi$  to determine ordinary differential equations for the  $T_n$ .

$$\phi_t = a^2 \phi_{xx}$$

$$\sum_{n=1}^{\infty} T_n'(t) \sin\left(\frac{n\pi x}{l}\right) = -a^2 \sum_{n=1}^{\infty} \left(\frac{n\pi}{l}\right)^2 T_n(t) \sin\left(\frac{n\pi x}{l}\right)$$

$$T_n' = -\left(\frac{an\pi}{l}\right)^2 T_n$$

Now we substitute Equation 37.10 into the initial condition for  $\phi$  to determine initial conditions for the  $T_n$ .

$$\begin{aligned} \sum_{n=1}^{\infty} T_n(0) \sin\left(\frac{n\pi x}{l}\right) &= \phi(x, 0) \\ T_n(0) &= \frac{\int_0^l \sin\left(\frac{n\pi x}{l}\right) \phi(x, 0) dx}{\int_0^l \sin^2\left(\frac{n\pi x}{l}\right) dx} \\ T_n(0) &= \frac{2}{l} \int_0^l \sin\left(\frac{n\pi x}{l}\right) \phi(x, 0) dx \\ T_n(0) &= \frac{2}{l} \int_0^{l/2} \sin\left(\frac{n\pi x}{l}\right) x dx + \frac{2}{l} \int_0^{l/2} \sin\left(\frac{n\pi x}{l}\right) (l-x) dx \\ T_n(0) &= \frac{4l}{n^2\pi^2} \sin\left(\frac{n\pi}{2}\right) \\ T_{2n-1}(0) &= (-1)^n \frac{4l}{(2n-1)^2\pi^2}, \quad T_{2n}(0) = 0, \quad n \in \mathbb{Z}^+ \end{aligned}$$

We solve the ordinary differential equations for  $T_n$  subject to the initial conditions.

$$T_{2n-1}(t) = (-1)^n \frac{4l}{(2n-1)^2\pi^2} \exp\left(-\left(\frac{(2n-1)\pi}{l}\right)^2 t\right), \quad T_{2n}(t) = 0, \quad n \in \mathbb{Z}^+$$

This determines the series representation of the solution.

$$\boxed{\phi = \frac{4}{l} \sum_{n=1}^{\infty} (-1)^n \left(\frac{l}{(2n-1)\pi}\right)^2 \exp\left(-\left(\frac{(2n-1)\pi}{l}\right)^2 t\right) \sin\left(\frac{(2n-1)\pi x}{l}\right)}$$

From the initial condition, we know that the the solution at  $t = 0$  is  $C^0$ . That is, it is continuous, but not differentiable. The series representation of the solution at  $t = 0$  is

$$\phi = \frac{4}{l} \sum_{n=1}^{\infty} (-1)^n \left(\frac{l}{(2n-1)\pi}\right)^2 \sin\left(\frac{(2n-1)\pi x}{l}\right).$$

That the coefficients decay as  $1/n^2$  corroborates that  $\phi(x, 0)$  is  $C^0$ .

The derivatives of  $\phi$  with respect to  $x$  are

$$\frac{\partial^{2m-1}}{\partial x^{2m-1}} \phi = \frac{4(-1)^{m+1}}{l} \sum_{n=1}^{\infty} (-1)^n \left( \frac{(2n-1)\pi}{l} \right)^{2m-3} \exp \left( - \left( \frac{a(2n-1)\pi}{l} \right)^2 t \right) \cos \left( \frac{(2n-1)\pi x}{l} \right)$$

$$\frac{\partial^{2m}}{\partial x^{2m}} \phi = \frac{4(-1)^m}{l} \sum_{n=1}^{\infty} (-1)^n \left( \frac{(2n-1)\pi}{l} \right)^{2m-2} \exp \left( - \left( \frac{a(2n-1)\pi}{l} \right)^2 t \right) \sin \left( \frac{(2n-1)\pi x}{l} \right)$$

For any fixed  $t > 0$ , the coefficients in the series for  $\frac{\partial^n}{\partial x} \phi$  decay exponentially. These series are uniformly convergent in  $x$ . Thus for any fixed  $t > 0$ ,  $\phi$  is  $C^\infty$  in  $x$ .

### Solution 37.12

$$u_t = \kappa u_{xx}, \quad 0 < x < L, \quad t > 0$$

$$u(0, t) = T_0, \quad u(L, t) = T_1, \quad u(x, 0) = f(x),$$

**Method 1.** We solve this problem with an eigenfunction expansion in  $x$ . To find an appropriate set of eigenfunctions, we apply the separation of variables,  $u(x, t) = X(x)T(t)$  to the partial differential equation with the homogeneous boundary conditions,  $u(0, t) = u(L, t) = 0$ .

$$(XT)_t = (XT)_{xx}$$

$$XT' = X''T$$

$$\frac{T'}{T} = \frac{X''}{X} = -\lambda^2$$

We have the eigenvalue problem,

$$X'' + \lambda^2 X = 0, \quad X(0) = X(L) = 0,$$

which has the solutions,

$$\lambda_n = \frac{n\pi}{L}, \quad X_n = \sin \left( \frac{n\pi x}{L} \right), \quad n \in \mathbb{N}.$$

We expand the solution of the partial differential equation in terms of these eigenfunctions.

$$u(x, t) = \sum_{n=1}^{\infty} a_n(t) \sin\left(\frac{n\pi x}{L}\right)$$

Because of the inhomogeneous boundary conditions, the convergence of the series will not be uniform. We can differentiate the series with respect to  $t$ , but not with respect to  $x$ . We multiply the partial differential equation by an eigenfunction and integrate from  $x = 0$  to  $x = L$ . We use integration by parts to move derivatives from  $u$  to the eigenfunction.

$$\begin{aligned}
 u_t - \kappa u_{xx} &= 0 \\
 \int_0^L (u_t - \kappa u_{xx}) \sin\left(\frac{m\pi x}{L}\right) dx &= 0 \\
 \int_0^L \left( \sum_{n=1}^{\infty} a'_n(t) \sin\left(\frac{n\pi x}{L}\right) \right) \sin\left(\frac{m\pi x}{L}\right) dx - \kappa \left[ u_x \sin\left(\frac{m\pi x}{L}\right) \right]_0^L + \kappa \frac{m\pi}{L} \int_0^L u_x \cos\left(\frac{m\pi x}{L}\right) dx &= 0 \\
 \frac{L}{2} a'_m(t) + \kappa \frac{m\pi}{L} \left[ u \cos\left(\frac{m\pi x}{L}\right) \right]_0^L + \kappa \left(\frac{m\pi}{L}\right)^2 \int_0^L u \sin\left(\frac{m\pi x}{L}\right) dx &= 0 \\
 \frac{L}{2} a'_m(t) + \kappa \frac{m\pi}{L} ((-1)^m u(L, t) - u(0, t)) + \kappa \left(\frac{m\pi}{L}\right)^2 \int_0^L \left( \sum_{n=1}^{\infty} a_n(t) \sin\left(\frac{n\pi x}{L}\right) \right) \sin\left(\frac{m\pi x}{L}\right) dx &= 0 \\
 \frac{L}{2} a'_m(t) + \kappa \frac{m\pi}{L} ((-1)^m T_1 - T_0) + \kappa \frac{L}{2} \left(\frac{m\pi}{L}\right)^2 a_m(t) &= 0 \\
 a'_m(t) + \kappa \left(\frac{m\pi}{L}\right)^2 a_m(t) &= \kappa \frac{2m\pi}{L^2} (T_0 - (-1)^m T_1)
 \end{aligned}$$

Now we have a first order differential equation for each of the  $a_n$ 's. We obtain initial conditions for each of the  $a_n$ 's from the initial condition for  $u(x, t)$ .

$$u(x, 0) = f(x)$$

$$\sum_{n=1}^{\infty} a_n(0) \sin\left(\frac{n\pi x}{L}\right) = f(x)$$

$$a_n(0) = \frac{2}{L} \int_0^L f(x) \sin\left(\frac{n\pi x}{L}\right) dx \equiv f_n$$

By solving the first order differential equation for  $a_n(t)$ , we obtain

$$a_n(t) = \frac{2(T_0 - (-1)^n T_1)}{n\pi} + e^{-\kappa(n\pi/L)^2 t} \left( f_n - \frac{2(T_0 - (-1)^n T_1)}{n\pi} \right).$$

Note that the series does not converge uniformly due to the  $1/n$  term.

**Method 2.** For our second method we transform the problem to one with homogeneous boundary conditions so that we can use the partial differential equation to determine the time dependence of the eigen-solutions. We make the change of variables  $v(x, t) = u(x, t) - \mu(x)$  where  $\mu(x)$  is some function that satisfies the inhomogeneous boundary conditions. If possible, we want  $\mu(x)$  to satisfy the partial differential equation as well. For this problem we can choose  $\mu(x)$  to be the equilibrium solution which satisfies

$$\mu''(x) = 0, \quad \mu(0) = T_0, \quad \mu(L) = T_1.$$

This has the solution

$$\mu(x) = T_0 + \frac{T_1 - T_0}{L} x.$$

With the change of variables,

$$v(x, t) = u(x, t) - \left( T_0 + \frac{T_1 - T_0}{L} x \right),$$

we obtain the problem

$$v_t = \kappa v_{xx}, \quad 0 < x < L, \quad t > 0$$
$$v(0, t) = 0, \quad v(L, t) = 0, \quad v(x, 0) = f(x) - \left( T_0 + \frac{T_1 - T_0}{L} x \right).$$

Now we substitute the separation of variables  $v(x, t) = X(x)T(t)$  into the partial differential equation.

$$(XT)_t = \kappa(XT)_{xx}$$
$$\frac{T'}{\kappa T} = \frac{X''}{X} = -\lambda^2$$

Utilizing the boundary conditions at  $x = 0, L$  we obtain the two ordinary differential equations,

$$T' = -\kappa\lambda^2 T,$$
$$X'' = -\lambda^2 X, \quad X(0) = X(L) = 0.$$

The problem for  $X$  is a regular Sturm-Liouville problem and has the solutions

$$\lambda_n = \frac{n\pi}{L}, \quad X_n = \sin\left(\frac{n\pi x}{L}\right), \quad n \in \mathbb{N}.$$

The ordinary differential equation for  $T$  becomes,

$$T'_n = -\kappa\left(\frac{n\pi}{L}\right)^2 T_n,$$

which, (up to a multiplicative constant), has the solution,

$$T_n = e^{-\kappa(n\pi/L)^2 t}.$$

Thus the eigenvalues and eigen-solutions of the partial differential equation are,

$$\lambda_n = \frac{n\pi}{L}, \quad v_n = \sin\left(\frac{n\pi x}{L}\right) e^{-\kappa(n\pi/L)^2 t}, \quad n \in \mathbb{N}.$$



Let  $v(x, t)$  have the series expansion,

$$v(x, t) = \sum_{n=1}^{\infty} a_n \sin\left(\frac{n\pi x}{L}\right) e^{-\kappa(n\pi/L)^2 t}.$$

We determine the coefficients in the expansion from the initial condition,

$$v(x, 0) = \sum_{n=1}^{\infty} a_n \sin\left(\frac{n\pi x}{L}\right) = f(x) - \left(T_0 + \frac{T_1 - T_0}{L}x\right).$$

The coefficients in the expansion are the Fourier sine coefficients of  $f(x) - \left(T_0 + \frac{T_1 - T_0}{L}x\right)$ .

$$a_n = \frac{2}{L} \int_0^L \left( f(x) - \left(T_0 + \frac{T_1 - T_0}{L}x\right) \right) \sin\left(\frac{n\pi x}{L}\right) dx$$

$$a_n = f_n - \frac{2(T_0 - (-1)^n T_1)}{n\pi}$$

With the coefficients defined above, the solution for  $u(x, t)$  is

$$u(x, t) = T_0 + \frac{T_1 - T_0}{L}x + \sum_{n=1}^{\infty} \left( f_n - \frac{2(T_0 - (-1)^n T_1)}{n\pi} \right) \sin\left(\frac{n\pi x}{L}\right) e^{-\kappa(n\pi/L)^2 t}.$$

Since the coefficients in the sum decay exponentially for  $t > 0$ , we see that the series is uniformly convergent for positive  $t$ . It is clear that the two solutions we have obtained are equivalent.

### Solution 37.13

First we solve the eigenvalue problem for  $\beta(x)$ , which is the problem we would obtain if we applied separation of variables to the partial differential equation,  $\phi_t = \phi_{xx}$ . We have the eigenvalues and orthonormal eigenfunctions

$$\lambda_n = \left(\frac{(2n-1)\pi}{2l}\right)^2, \quad \beta_n(x) = \sqrt{\frac{2}{l}} \sin\left(\frac{(2n-1)\pi x}{2l}\right), \quad n \in \mathbb{Z}^+.$$

We expand the solution and inhomogeneity in Equation 37.5 in a series of the eigenvalues.

$$\phi(x, t) = \sum_{n=1}^{\infty} T_n(t)\beta_n(x)$$

$$w(x, t) = \sum_{n=1}^{\infty} w_n(t)\beta_n(x), \quad w_n(t) = \int_0^l \beta_n(x)w(x, t) dx$$

Since  $\phi$  satisfies the same homogeneous boundary conditions as  $\beta$ , we substitute the series into Equation 37.5 to determine differential equations for the  $T_n(t)$ .

$$\sum_{n=1}^{\infty} T_n'(t)\beta_n(x) = a^2 \sum_{n=1}^{\infty} T_n(t)(-\lambda_n)\beta_n(x) + \sum_{n=1}^{\infty} w_n(t)\beta_n(x)$$

$$T_n'(t) = -a^2 \left( \frac{(2n-1)\pi}{2l} \right)^2 T_n(t) + w_n(t)$$

Now we substitute the series for  $\phi$  into its initial condition to determine initial conditions for the  $T_n$ .

$$\phi(x, 0) = \sum_{n=1}^{\infty} T_n(0)\beta_n(x) = f(x)$$

$$T_n(0) = \int_0^l \beta_n(x)f(x) dx$$

We solve for  $T_n(t)$  to determine the solution,  $\phi(x, t)$ .

$$T_n(t) = \exp\left(-\left(\frac{(2n-1)a\pi}{2l}\right)^2 t\right) \left( T_n(0) + \int_0^t w_n(\tau) \exp\left(\left(\frac{(2n-1)a\pi}{2l}\right)^2 \tau\right) d\tau \right)$$

### Solution 37.14

Separation of variables leads to the eigenvalue problem

$$\beta'' + \lambda\beta = 0, \quad \beta(0) = 0, \quad \beta(l) + c\beta'(l) = 0.$$

First we consider the case  $\lambda = 0$ . A set of solutions of the differential equation is  $\{1, x\}$ . The solution that satisfies the left boundary condition is  $\beta(x) = x$ . The right boundary condition imposes the constraint  $l + c = 0$ . Since  $c$  is positive, this has no solutions.  $\lambda = 0$  is not an eigenvalue.

Now we consider  $\lambda \neq 0$ . A set of solutions of the differential equation is  $\{\cos(\sqrt{\lambda}x), \sin(\sqrt{\lambda}x)\}$ . The solution that satisfies the left boundary condition is  $\beta = \sin(\sqrt{\lambda}x)$ . The right boundary condition imposes the constraint

$$c \sin(\sqrt{\lambda}l) + \sqrt{\lambda} \cos(\sqrt{\lambda}l) = 0$$

$$\tan(\sqrt{\lambda}l) = -\frac{\sqrt{\lambda}}{c}$$

For large  $\lambda$ , the we can determine approximate solutions.

$$\sqrt{\lambda_n}l \approx \frac{(2n-1)\pi}{2}, n \in \mathbb{Z}^+$$

$$\lambda_n \approx \left(\frac{(2n-1)\pi}{2l}\right)^2, n \in \mathbb{Z}^+$$

The eigenfunctions are

$$\beta_n(x) = \frac{\sin(\sqrt{\lambda_n}x)}{\sqrt{\int_0^l \sin^2(\sqrt{\lambda_n}x) dx}}, n \in \mathbb{Z}^+.$$

We expand  $\phi(x, t)$  and  $w(x, t)$  in series of the eigenfunctions.

$$\phi(x, t) = \sum_{n=1}^{\infty} T_n(t)\beta_n(x)$$

$$w(x, t) = \sum_{n=1}^{\infty} w_n(t)\beta_n(x), \quad w_n(t) = \int_0^l \beta_n(x)w(x, t) dx$$

Since  $\phi$  satisfies the same homogeneous boundary conditions as  $\beta$ , we substitute the series into Equation 37.5 to determine differential equations for the  $T_n(t)$ .

$$\sum_{n=1}^{\infty} T_n'(t)\beta_n(x) = a^2 \sum_{n=1}^{\infty} T_n(t)(-\lambda_n)\beta_n(x) + \sum_{n=1}^{\infty} w_n(t)\beta_n(x)$$

$$T_n'(t) = -a^2\lambda_n T_n(t) + w_n(t)$$

Now we substitute the series for  $\phi$  into its initial condition to determine initial conditions for the  $T_n$ .

$$\phi(x, 0) = \sum_{n=1}^{\infty} T_n(0)\beta_n(x) = f(x)$$

$$T_n(0) = \int_0^l \beta_n(x)f(x) dx$$

We solve for  $T_n(t)$  to determine the solution,  $\phi(x, t)$ .

$$T_n(t) = \exp(-a^2\lambda_n t) \left( T_n(0) + \int_0^t w_n(\tau) \exp(a^2\lambda_n \tau) d\tau \right)$$

### Solution 37.15

First we seek a function  $u(x, t)$  that satisfies the boundary conditions  $u(0, t) = t$ ,  $u_x(l, t) = -cu(l, t)$ . We try a function of the form  $u = (ax + b)t$ . The left boundary condition imposes the constraint  $b = 1$ . We then apply the right boundary condition to determine  $u$ .

$$at = -c(al + 1)t$$

$$a = -\frac{c}{1 + cl}$$

$$u(x, t) = \left( 1 - \frac{cx}{1 + cl} \right) t$$

Now we define  $\psi$  to be the difference of  $\phi$  and  $u$ .

$$\psi(x, t) = \phi(x, t) - u(x, t)$$

$\psi$  satisfies an inhomogeneous diffusion equation with homogeneous boundary conditions.

$$\begin{aligned}(\psi + u)_t &= a^2(\psi + u)_{xx} + 1 \\ \psi_t &= a^2\psi_{xx} + 1 + a^2u_{xx} - u_t \\ \psi_t &= a^2\psi_{xx} + \frac{cx}{1 + ct}\end{aligned}$$

The initial and boundary conditions for  $\psi$  are

$$\psi(x, 0) = 0, \quad \psi(0, t) = 0, \quad \psi_x(l, t) = -c\psi(l, t).$$

We solved this system in problem 2. Just take

$$w(x, t) = \frac{cx}{1 + ct}, \quad f(x) = 0.$$

The solution is

$$\begin{aligned}\psi(x, t) &= \sum_{n=1}^{\infty} T_n(t)\beta_n(x), \\ T_n(t) &= \int_0^t w_n \exp(-a^2\lambda_n(t - \tau)) \, d\tau, \\ w_n(t) &= \int_0^l \beta_n(x) \frac{cx}{1 + ct} \, dx.\end{aligned}$$

This determines the solution for  $\phi$ .

**Solution 37.16**

First we solve this problem with a series expansion. We transform the problem to one with homogeneous boundary conditions. Note that

$$u(x) = \frac{x}{l+1}$$

satisfies the boundary conditions. (It is the equilibrium solution.) We make the change of variables  $\psi = \phi - u$ . The problem for  $\psi$  is

$$\begin{aligned} \psi_t &= a^2 \psi_{xx}, \\ \psi(0, t) &= \psi(l, t) + \psi_x(l, t) = 0, \quad \psi(x, 0) = \frac{x}{l+1}. \end{aligned}$$

This is a particular case of what we solved in Exercise 37.14. We apply the result of that problem. The solution for  $\phi(x, t)$  is

$$\begin{aligned} \phi(x, t) &= \frac{x}{l+1} + \sum_{n=1}^{\infty} T_n(t) \beta_n(x) \\ \beta_n(x) &= \frac{\sin(\sqrt{\lambda_n} x)}{\sqrt{\int_0^l \sin^2(\sqrt{\lambda_n} x) dx}}, \quad n \in \mathbb{Z}^+ \\ \tan(\sqrt{\lambda} l) &= -\sqrt{\lambda} \\ T_n(t) &= T_n(0) \exp(-a^2 \lambda_n t) \\ T_n(0) &= \int_0^l \beta_n(x) \frac{x}{l+1} dx \end{aligned}$$

This expansion is useful for large  $t$  because the coefficients decay exponentially with increasing  $t$ .

Now we solve this problem with the Laplace transform.

$$\begin{aligned}\phi_t &= a^2 \phi_{xx}, & \phi(0, t) &= 0, & \phi(l, t) + \phi_x(l, t) &= 1, & \phi(x, 0) &= 0 \\ s\hat{\phi} &= a^2 \hat{\phi}_{xx}, & \hat{\phi}(0, s) &= 0, & \hat{\phi}(l, s) + \hat{\phi}_x(l, s) &= \frac{1}{s} \\ \hat{\phi}_{xx} - \frac{s}{a^2} \hat{\phi} &= 0, & \hat{\phi}(0, s) &= 0, & \hat{\phi}(l, s) + \hat{\phi}_x(l, s) &= \frac{1}{s}\end{aligned}$$

The solution that satisfies the left boundary condition is

$$\hat{\phi} = c \sinh\left(\frac{\sqrt{sx}}{a}\right).$$

We apply the right boundary condition to determine the constant.

$$\hat{\phi} = \frac{\sinh\left(\frac{\sqrt{sx}}{a}\right)}{s \left( \sinh\left(\frac{\sqrt{sl}}{a}\right) + \frac{\sqrt{s}}{a} \cosh\left(\frac{\sqrt{sl}}{a}\right) \right)}$$

We expand this in a series of simpler functions of  $s$ .

$$\hat{\phi} = \frac{2 \sinh\left(\frac{\sqrt{s}x}{a}\right)}{s \left( \exp\left(\frac{\sqrt{s}l}{a}\right) - \exp\left(-\frac{\sqrt{s}l}{a}\right) + \frac{\sqrt{s}}{a} \left( \exp\left(\frac{\sqrt{s}l}{a}\right) + \exp\left(-\frac{\sqrt{s}l}{a}\right) \right) \right)}$$

$$\hat{\phi} = \frac{2 \sinh\left(\frac{\sqrt{s}x}{a}\right)}{s \exp\left(\frac{\sqrt{s}l}{a}\right)} \frac{1}{1 + \frac{\sqrt{s}}{a} - \left(1 - \frac{\sqrt{s}}{a}\right) \exp\left(-\frac{2\sqrt{s}l}{a}\right)}$$

$$\hat{\phi} = \frac{\exp\left(\frac{\sqrt{s}x}{a}\right) - \exp\left(-\frac{\sqrt{s}x}{a}\right)}{s \left(1 + \frac{\sqrt{s}}{a}\right) \exp\left(\frac{\sqrt{s}l}{a}\right)} \frac{1}{1 - \left(\frac{1 - \sqrt{s}/a}{1 + \sqrt{s}/a}\right) \exp\left(-\frac{2\sqrt{s}l}{a}\right)}$$

$$\hat{\phi} = \frac{\exp\left(\frac{\sqrt{s}(x-l)}{a}\right) - \exp\left(\frac{\sqrt{s}(-x-l)}{a}\right)}{s \left(1 + \frac{\sqrt{s}}{a}\right)} \sum_{n=0}^{\infty} \left(\frac{1 - \sqrt{s}/a}{1 + \sqrt{s}/a}\right)^n \exp\left(-\frac{2\sqrt{s}ln}{a}\right)$$

$$\hat{\phi} = \frac{1}{s} \left( \sum_{n=0}^{\infty} \frac{(1 - \sqrt{s}/a)^n}{(1 + \sqrt{s}/a)^{n+1}} \exp\left(-\frac{\sqrt{s}((2n+1)l - x)}{a}\right) - \sum_{n=0}^{\infty} \frac{(1 - \sqrt{s}/a)^n}{(1 + \sqrt{s}/a)^{n+1}} \exp\left(-\frac{\sqrt{s}((2n+1)l + x)}{a}\right) \right)$$

By expanding

$$\frac{(1 - \sqrt{s}/a)^n}{(1 + \sqrt{s}/a)^{n+1}}$$

in binomial series all the terms would be of the form

$$s^{-m/2-3/2} \exp\left(-\frac{\sqrt{s}((2n \pm 1)l \mp x)}{a}\right).$$



Taking the first term in each series yields

$$\hat{\phi} \sim \frac{a}{s^{3/2}} \left( \exp\left(-\frac{\sqrt{s}(l-x)}{a}\right) - \exp\left(-\frac{\sqrt{s}(l+x)}{a}\right) \right), \quad \text{as } s \rightarrow \infty.$$

We take the inverse Laplace transform to obtain an approximation of the solution for  $t \ll 1$ .

$$\phi(x, t) \sim 2a^2 \sqrt{\pi t} \left( \frac{\exp\left(-\frac{(l-x)^2}{4a^2 t}\right)}{l-x} - \frac{\exp\left(-\frac{(l+x)^2}{4a^2 t}\right)}{l+x} \right) - \pi \left( \operatorname{erfc}\left(\frac{l-x}{2a\sqrt{t}}\right) - \operatorname{erfc}\left(\frac{l+x}{2a\sqrt{t}}\right) \right), \quad \text{for } t \ll 1$$

### Solution 37.17

We apply the separation of variables  $\phi(x, t) = X(x)T(t)$ .

$$\begin{aligned} \phi_t &= A^2 (x^2 \phi_x)_x \\ XT' &= TA^2 (x^2 X')' \\ \frac{T'}{A^2 T} &= \frac{(x^2 X')'}{X} = -\lambda \end{aligned}$$

This gives us a regular Sturm-Liouville problem.

$$(x^2 X')' + \lambda X = 0, \quad X(1) = X(2) = 0$$

This is an Euler equation. We make the substitution  $X = x^\alpha$  to find the solutions.

$$\begin{aligned} x^2 X'' + 2xX' + \lambda X &= 0 \\ \alpha(\alpha - 1) + 2\alpha + \lambda &= 0 \\ \alpha &= \frac{-1 \pm \sqrt{1 - 4\lambda}}{2} \\ \alpha &= -\frac{1}{2} \pm i\sqrt{\lambda - 1/4} \end{aligned} \tag{37.11}$$

First we consider the case of a double root when  $\lambda = 1/4$ . The solutions of Equation 37.11 are  $\{x^{-1/2}, x^{-1/2} \ln x\}$ . The solution that satisfies the left boundary condition is  $X = x^{-1/2} \ln x$ . Since this does not satisfy the right boundary condition,  $\lambda = 1/4$  is not an eigenvalue.

Now we consider  $\lambda \neq 1/4$ . The solutions of Equation 37.11 are

$$\left\{ \frac{1}{\sqrt{x}} \cos\left(\sqrt{\lambda - 1/4} \ln x\right), \frac{1}{\sqrt{x}} \sin\left(\sqrt{\lambda - 1/4} \ln x\right) \right\}.$$

The solution that satisfies the left boundary condition is

$$\frac{1}{\sqrt{x}} \sin\left(\sqrt{\lambda - 1/4} \ln x\right).$$

The right boundary condition imposes the constraint

$$\sqrt{\lambda - 1/4} \ln 2 = n\pi, \quad n \in \mathbb{Z}^+.$$

This gives us the eigenvalues and eigenfunctions.

$$\lambda_n = \frac{1}{4} + \left(\frac{n\pi}{\ln 2}\right)^2, \quad X_n(x) = \frac{1}{\sqrt{x}} \sin\left(\frac{n\pi \ln x}{\ln 2}\right), \quad n \in \mathbb{Z}^+.$$

We normalize the eigenfunctions.

$$\int_1^2 \frac{1}{x} \sin^2\left(\frac{n\pi \ln x}{\ln 2}\right) dx = \ln 2 \int_0^1 \sin^2(n\pi\xi) d\xi = \frac{\ln 2}{2}$$

$$X_n(x) = \sqrt{\frac{2}{\ln 2}} \frac{1}{\sqrt{x}} \sin\left(\frac{n\pi \ln x}{\ln 2}\right), \quad n \in \mathbb{Z}^+.$$

From separation of variables, we have differential equations for the  $T_n$ .

$$T_n' = -A^2 \left(\frac{1}{4} + \left(\frac{n\pi}{\ln 2}\right)^2\right) T_n$$

$$T_n(t) = \exp\left(-A^2 \left(\frac{1}{4} + \left(\frac{n\pi}{\ln 2}\right)^2\right) t\right)$$

We expand  $\phi$  in a series of the eigensolutions.

$$\phi(x, t) = \sum_{n=1}^{\infty} \phi_n X_n(x) T_n(t)$$

We substitute the expansion for  $\phi$  into the initial condition to determine the coefficients.

$$\begin{aligned}\phi(x, 0) &= \sum_{n=1}^{\infty} \phi_n X_n(x) = f(x) \\ \phi_n &= \int_1^2 X_n(x) f(x) dx\end{aligned}$$

### Solution 37.18

$$\begin{aligned}u_{tt} &= c^2 u_{xx}, \quad 0 < x < L, \quad t > 0, \\ u(0, t) &= 0, \quad u_x(L, t) = 0, \\ u(x, 0) &= f(x), \quad u_t(x, 0) = 0,\end{aligned}$$

We substitute the separation of variables  $u(x, t) = X(x)T(t)$  into the partial differential equation.

$$\begin{aligned}(XT)_{tt} &= c^2 (XT)_{xx} \\ \frac{T''}{c^2 T} &= \frac{X''}{X} = -\lambda^2\end{aligned}$$

With the boundary conditions at  $x = 0, L$ , we have the ordinary differential equations,

$$\begin{aligned}T'' &= -c^2 \lambda^2 T, \\ X'' &= -\lambda^2 X, \quad X(0) = X'(L) = 0.\end{aligned}$$

The problem for  $X$  is a regular Sturm-Liouville eigenvalue problem. From the Rayleigh quotient,

$$\lambda^2 = \frac{-[\phi\phi']_0^L + \int_0^L (\phi')^2 dx}{\int_0^L \phi^2 dx} = \frac{\int_0^L (\phi')^2 dx}{\int_0^L \phi^2 dx}$$

we see that there are only positive eigenvalues. For  $\lambda^2 > 0$  the general solution of the ordinary differential equation is

$$X = a_1 \cos(\lambda x) + a_2 \sin(\lambda x).$$

The solution that satisfies the left boundary condition is

$$X = a \sin(\lambda x).$$

For non-trivial solutions, the right boundary condition imposes the constraint,

$$\cos(\lambda L) = 0,$$

$$\lambda = \frac{\pi}{L} \left( n - \frac{1}{2} \right), \quad n \in \mathbb{N}.$$

The eigenvalues and eigenfunctions are

$$\lambda_n = \frac{(2n-1)\pi}{2L}, \quad X_n = \sin\left(\frac{(2n-1)\pi x}{2L}\right), \quad n \in \mathbb{N}.$$

The differential equation for  $T$  becomes

$$T'' = -c^2 \left( \frac{(2n-1)\pi}{2L} \right)^2 T,$$

which has the two linearly independent solutions,

$$T_n^{(1)} = \cos\left(\frac{(2n-1)c\pi t}{2L}\right), \quad T_n^{(2)} = \sin\left(\frac{(2n-1)c\pi t}{2L}\right).$$

The eigenvalues and eigen-solutions of the partial differential equation are,

$$\lambda_n = \frac{(2n-1)\pi}{2L}, \quad n \in \mathbb{N},$$

$$u_n^{(1)} = \sin\left(\frac{(2n-1)\pi x}{2L}\right) \cos\left(\frac{(2n-1)c\pi t}{2L}\right), \quad u_n^{(2)} = \sin\left(\frac{(2n-1)\pi x}{2L}\right) \sin\left(\frac{(2n-1)c\pi t}{2L}\right).$$

We expand  $u(x, t)$  in a series of the eigen-solutions.

$$u(x, t) = \sum_{n=1}^{\infty} \sin\left(\frac{(2n-1)\pi x}{2L}\right) \left( a_n \cos\left(\frac{(2n-1)c\pi t}{2L}\right) + b_n \sin\left(\frac{(2n-1)c\pi t}{2L}\right) \right).$$

We impose the initial condition  $u_t(x, 0) = 0$ ,

$$u_t(x, 0) = \sum_{n=1}^{\infty} b_n \frac{(2n-1)c\pi}{2L} \sin\left(\frac{(2n-1)\pi x}{2L}\right) = 0,$$

$$b_n = 0.$$

The initial condition  $u(x, 0) = f(x)$  allows us to determine the remaining coefficients,

$$u(x, 0) = \sum_{n=1}^{\infty} a_n \sin\left(\frac{(2n-1)\pi x}{2L}\right) = f(x),$$

$$a_n = \frac{2}{L} \int_0^L f(x) \sin\left(\frac{(2n-1)\pi x}{2L}\right) dx.$$

The series solution for  $u(x, t)$  is,

$$u(x, t) = \sum_{n=1}^{\infty} a_n \sin\left(\frac{(2n-1)\pi x}{2L}\right) \cos\left(\frac{(2n-1)c\pi t}{2L}\right).$$

### Solution 37.19

$$\begin{aligned}u_{xx} + u_{yy} &= f(x, y), & 0 < x < a, & \quad 0 < y < b, \\u(0, y) = u(a, y) &= 0, & u_y(x, 0) = u_y(x, b) &= 0\end{aligned}$$

We will solve this problem with an eigenfunction expansion in  $x$ . To determine a suitable set of eigenfunctions, we substitute the separation of variables  $u(x, y) = X(x)Y(y)$  into the homogeneous partial differential equation.

$$\begin{aligned}u_{xx} + u_{yy} &= 0 \\(XY)_{xx} + (XY)_{yy} &= 0 \\ \frac{X''}{X} &= -\frac{Y''}{Y} = -\lambda^2\end{aligned}$$

With the boundary conditions at  $x = 0, a$ , we have the regular Sturm-Liouville problem,

$$X'' = -\lambda^2 X, \quad X(0) = X(a) = 0,$$

which has the solutions,

$$\lambda_n = \frac{n\pi}{a}, \quad X_n = \sin\left(\frac{n\pi x}{a}\right), \quad n \in \mathbb{Z}^+.$$

We expand  $u(x, y)$  in a series of the eigenfunctions.

$$u(x, y) = \sum_{n=1}^{\infty} u_n(y) \sin\left(\frac{n\pi x}{a}\right)$$

We substitute this series into the partial differential equation and boundary conditions at  $y = 0, b$ .

$$\begin{aligned}\sum_{n=1}^{\infty} \left( -\left(\frac{n\pi}{a}\right)^2 u_n(y) \sin\left(\frac{n\pi x}{a}\right) + u_n''(y) \sin\left(\frac{n\pi x}{a}\right) \right) &= f(x) \\ \sum_{n=1}^{\infty} u_n'(0) \sin\left(\frac{n\pi x}{a}\right) &= \sum_{n=1}^{\infty} u_n'(b) \sin\left(\frac{n\pi x}{a}\right) = 0\end{aligned}$$

We expand  $f(x, y)$  in a Fourier sine series.

$$f(x, y) = \sum_{n=1}^{\infty} f_n(y) \sin\left(\frac{n\pi x}{a}\right)$$

$$f_n(y) = \frac{2}{a} \int_0^a f(x, y) \sin\left(\frac{n\pi x}{a}\right) dx$$

We obtain the ordinary differential equations for the coefficients in the expansion.

$$u_n''(y) - \left(\frac{n\pi}{a}\right)^2 u_n(y) = f_n(y), \quad u_n'(0) = u_n'(b) = 0, \quad n \in \mathbb{Z}^+.$$

We will solve these ordinary differential equations with Green functions.

Consider the Green function problem,

$$g_n''(y; \eta) - \left(\frac{n\pi}{a}\right)^2 g_n(y; \eta) = \delta(y - \eta), \quad g_n'(0; \eta) = g_n'(b; \eta) = 0.$$

The homogeneous solutions

$$\cosh\left(\frac{n\pi y}{a}\right) \quad \text{and} \quad \cosh\left(\frac{n\pi(y-b)}{a}\right)$$

satisfy the left and right boundary conditions, respectively. We compute the Wronskian of these two solutions.

$$\begin{aligned} W(y) &= \begin{vmatrix} \cosh(n\pi y/a) & \cosh(n\pi(y-b)/a) \\ \frac{n\pi}{a} \sinh(n\pi y/a) & \frac{n\pi}{a} \sinh(n\pi(y-b)/a) \end{vmatrix} \\ &= \frac{n\pi}{a} \left( \cosh\left(\frac{n\pi y}{a}\right) \sinh\left(\frac{n\pi(y-b)}{a}\right) - \sinh\left(\frac{n\pi y}{a}\right) \cosh\left(\frac{n\pi(y-b)}{a}\right) \right) \\ &= -\frac{n\pi}{a} \sinh\left(\frac{n\pi b}{a}\right) \end{aligned}$$

The Green function is

$$g_n(y; \eta) = -\frac{a \cosh(n\pi y_{<}/a) \cosh(n\pi(y_{>} - b)/a)}{n\pi \sinh(n\pi b/a)}.$$

The solutions for the coefficients in the expansion are

$$u_n(y) = \int_0^b g_n(y; \eta) f_n(\eta) d\eta.$$

### Solution 37.20

$$\begin{aligned}u_{tt} + a^2 u_{xxxx} &= 0, & 0 < x < L, t > 0, \\u(x, 0) &= f(x), & u_t(x, 0) &= g(x), \\u(0, t) = u_{xx}(0, t) &= 0, & u(L, t) = u_{xx}(L, t) &= 0,\end{aligned}$$

We will solve this problem by expanding the solution in a series of eigen-solutions that satisfy the partial differential equation and the homogeneous boundary conditions. We will use the initial conditions to determine the coefficients in the expansion. We substitute the separation of variables,  $u(x, t) = X(x)T(t)$  into the partial differential equation.

$$\begin{aligned}(XT)_{tt} + a^2(XT)_{xxxx} &= 0 \\ \frac{T''}{a^2 T} &= -\frac{X''''}{X} = -\lambda^4\end{aligned}$$

Here we make the assumption that  $0 \leq \arg(\lambda) < \pi/2$ , i.e.,  $\lambda$  lies in the first quadrant of the complex plane. Note that  $\lambda^4$  covers the entire complex plane. We have the ordinary differential equation,

$$T'' = -a^2 \lambda^4 T,$$

and with the boundary conditions at  $x = 0, L$ , the eigenvalue problem,

$$X'''' = \lambda^4 X, \quad X(0) = X''(0) = X(L) = X''(L) = 0.$$

For  $\lambda = 0$ , the general solution of the differential equation is

$$X = c_1 + c_2 x + c_3 x^2 + c_4 x^3.$$



Only the trivial solution satisfies the boundary conditions.  $\lambda = 0$  is not an eigenvalue. For  $\lambda \neq 0$ , a set of linearly independent solutions is

$$\{e^{\lambda x}, e^{i\lambda x}, e^{-\lambda x}, e^{-i\lambda x}\}.$$

Another linearly independent set, (which will be more useful for this problem), is

$$\{\cos(\lambda x), \sin(\lambda x), \cosh(\lambda x), \sinh(\lambda x)\}.$$

Both  $\sin(\lambda x)$  and  $\sinh(\lambda x)$  satisfy the left boundary conditions. Consider the linear combination  $c_1 \cos(\lambda x) + c_2 \cosh(\lambda x)$ . The left boundary conditions impose the two constraints  $c_1 + c_2 = 0$ ,  $c_1 - c_2 = 0$ . Only the trivial linear combination of  $\cos(\lambda x)$  and  $\cosh(\lambda x)$  can satisfy the left boundary condition. Thus the solution has the form,

$$X = c_1 \sin(\lambda x) + c_2 \sinh(\lambda x).$$

The right boundary conditions impose the constraints,

$$\begin{cases} c_1 \sin(\lambda L) + c_2 \sinh(\lambda L) = 0, \\ -c_1 \lambda^2 \sin(\lambda L) + c_2 \lambda^2 \sinh(\lambda L) = 0 \end{cases}$$

$$\begin{cases} c_1 \sin(\lambda L) + c_2 \sinh(\lambda L) = 0, \\ -c_1 \sin(\lambda L) + c_2 \sinh(\lambda L) = 0 \end{cases}$$

This set of equations has a nontrivial solution if and only if the determinant is zero,

$$\begin{vmatrix} \sin(\lambda L) & \sinh(\lambda L) \\ -\sin(\lambda L) & \sinh(\lambda L) \end{vmatrix} = 2 \sin(\lambda L) \sinh(\lambda L) = 0.$$

Since  $\sinh(z)$  is nonzero in  $0 \leq \arg(z) < \pi/2$ ,  $z \neq 0$ , and  $\sin(z)$  has the zeros  $z = n\pi$ ,  $n \in \mathbb{N}$  in this domain, the eigenvalues and eigenfunctions are,

$$\lambda_n = \frac{n\pi}{L}, \quad X_n = \sin\left(\frac{n\pi x}{L}\right), \quad n \in \mathbb{N}.$$

The differential equation for  $T$  becomes,

$$T'' = -a^2 \left(\frac{n\pi}{L}\right)^4 T,$$

which has the solutions,

$$\left\{ \cos \left( a \left( \frac{n\pi}{L} \right)^2 t \right), \sin \left( a \left( \frac{n\pi}{L} \right)^2 t \right) \right\}.$$

The eigen-solutions of the partial differential equation are,

$$u_n^{(1)} = \sin \left( \frac{n\pi x}{L} \right) \cos \left( a \left( \frac{n\pi}{L} \right)^2 t \right), \quad u_n^{(2)} = \sin \left( \frac{n\pi x}{L} \right) \sin \left( a \left( \frac{n\pi}{L} \right)^2 t \right), \quad n \in \mathbb{N}.$$

We expand the solution of the partial differential equation in a series of the eigen-solutions.

$$u(x, t) = \sum_{n=1}^{\infty} \sin \left( \frac{n\pi x}{L} \right) \left( c_n \cos \left( a \left( \frac{n\pi}{L} \right)^2 t \right) + d_n \sin \left( a \left( \frac{n\pi}{L} \right)^2 t \right) \right)$$

The initial condition for  $u(x, t)$  and  $u_t(x, t)$  allow us to determine the coefficients in the expansion.

$$u(x, 0) = \sum_{n=1}^{\infty} c_n \sin \left( \frac{n\pi x}{L} \right) = f(x)$$
$$u_t(x, 0) = \sum_{n=1}^{\infty} d_n a \left( \frac{n\pi}{L} \right)^2 \sin \left( \frac{n\pi x}{L} \right) = g(x)$$

$c_n$  and  $d_n$  are coefficients in Fourier sine series.

$$c_n = \frac{2}{L} \int_0^L f(x) \sin \left( \frac{n\pi x}{L} \right) dx$$

$$d_n = \frac{2L}{a\pi^2 n^2} \int_0^L g(x) \sin \left( \frac{n\pi x}{L} \right) dx$$

### Solution 37.21

$$\begin{aligned}u_t &= \kappa u_{xx} + I^2 \alpha u, & 0 < x < L, & \quad t > 0, \\u(0, t) &= u(L, t) = 0, & u(x, 0) &= g(x).\end{aligned}$$

We will solve this problem with an expansion in eigen-solutions of the partial differential equation. We substitute the separation of variables  $u(x, t) = X(x)T(t)$  into the partial differential equation.

$$\begin{aligned}(XT)_t &= \kappa(XT)_{xx} + I^2 \alpha XT \\ \frac{T'}{\kappa T} - \frac{I^2 \alpha}{\kappa} &= \frac{X''}{X} = -\lambda^2\end{aligned}$$

Now we have an ordinary differential equation for  $T$  and a Sturm-Liouville eigenvalue problem for  $X$ . (Note that we have followed the rule of thumb that the problem will be easier if we move all the parameters out of the eigenvalue problem.)

$$\begin{aligned}T' &= -(\kappa \lambda^2 - I^2 \alpha) T \\ X'' &= -\lambda^2 X, \quad X(0) = X(L) = 0\end{aligned}$$

The eigenvalues and eigenfunctions for  $X$  are

$$\lambda_n = \frac{n\pi}{L}, \quad X_n = \sin\left(\frac{n\pi x}{L}\right), \quad n \in \mathbb{N}.$$

The differential equation for  $T$  becomes,

$$T'_n = -\left(\kappa \left(\frac{n\pi}{L}\right)^2 - I^2 \alpha\right) T_n,$$

which has the solution,

$$T_n = c \exp\left(-\left(\kappa \left(\frac{n\pi}{L}\right)^2 - I^2 \alpha\right) t\right).$$

From this solution, we see that the critical current is

$$I_{CR} = \sqrt{\frac{\kappa \pi}{\alpha L}}.$$

If  $I$  is greater than this, then the eigen-solution for  $n = 1$  will be exponentially growing. This would make the whole solution exponentially growing. For  $I < I_{CR}$ , each of the  $T_n$  is exponentially decaying. The eigen-solutions of the partial differential equation are,

$$u_n = \exp\left(-\left(\kappa\left(\frac{n\pi}{L}\right)^2 - I^2\alpha\right)t\right) \sin\left(\frac{n\pi x}{L}\right), \quad n \in \mathbb{N}.$$

We expand  $u(x, t)$  in its eigen-solutions,  $u_n$ .

$$u(x, t) = \sum_{n=1}^{\infty} a_n \exp\left(-\left(\kappa\left(\frac{n\pi}{L}\right)^2 - I^2\alpha\right)t\right) \sin\left(\frac{n\pi x}{L}\right)$$

We determine the coefficients  $a_n$  from the initial condition.

$$u(x, 0) = \sum_{n=1}^{\infty} a_n \sin\left(\frac{n\pi x}{L}\right) = g(x)$$

$$a_n = \frac{2}{L} \int_0^L g(x) \sin\left(\frac{n\pi x}{L}\right) dx.$$

If  $\alpha < 0$ , then the solution is exponentially decaying regardless of current. Thus there is no critical current.

### Solution 37.22

a) The problem is

$$u_t(x, y, z, t) = \kappa \Delta u(x, y, z, t), \quad -\infty < x < \infty, \quad -\infty < y < \infty, \quad 0 < z < a, \quad t > 0,$$
$$u(x, y, z, 0) = T, \quad u(x, y, 0, t) = u(x, y, a, t) = 0.$$

Because of symmetry, the partial differential equation in four variables is reduced to a problem in two variables,

$$u_t(z, t) = \kappa u_{zz}(z, t), \quad 0 < z < a, \quad t > 0,$$
$$u(z, 0) = T, \quad u(0, t) = u(a, t) = 0.$$

We will solve this problem with an expansion in eigen-solutions of the partial differential equation that satisfy the homogeneous boundary conditions. We substitute the separation of variables  $u(z, t) = Z(z)T(t)$  into the partial differential equation.

$$ZT' = \kappa Z''T$$
$$\frac{T'}{\kappa T} = \frac{Z''}{Z} = -\lambda^2$$

With the boundary conditions at  $z = 0, a$  we have the Sturm-Liouville eigenvalue problem,

$$Z'' = -\lambda^2 Z, \quad Z(0) = Z(a) = 0,$$

which has the solutions,

$$\lambda_n = \frac{n\pi}{a}, \quad Z_n = \sin\left(\frac{n\pi z}{a}\right), \quad n \in \mathbb{N}.$$

The problem for  $T$  becomes,

$$T'_n = -\kappa \left(\frac{n\pi}{a}\right)^2 T_n,$$

with the solution,

$$T_n = \exp\left(-\kappa \left(\frac{n\pi}{a}\right)^2 t\right).$$

The eigen-solutions are

$$u_n(z, t) = \sin\left(\frac{n\pi z}{a}\right) \exp\left(-\kappa\left(\frac{n\pi}{a}\right)^2 t\right).$$

The solution for  $u$  is a linear combination of the eigen-solutions. The slowest decaying eigen-solution is

$$u_1(z, t) = \sin\left(\frac{\pi z}{a}\right) \exp\left(-\kappa\left(\frac{\pi}{a}\right)^2 t\right).$$

Thus the e-folding time is

$$\Delta_e = \frac{a^2}{\kappa\pi^2}.$$

b) The problem is

$$\begin{aligned} u_t(r, \theta, z, t) &= \kappa \Delta u(r, \theta, z, t), & 0 < r < a, & \quad 0 < \theta < 2\pi, & \quad -\infty < z < \infty, & \quad t > 0, \\ u(r, \theta, z, 0) &= T, & u(0, \theta, z, t) & \text{is bounded,} & \quad u(a, \theta, z, t) &= 0. \end{aligned}$$

The Laplacian in cylindrical coordinates is

$$\Delta u = u_{rr} + \frac{1}{r}u_r + \frac{1}{r^2}u_{\theta\theta} + u_{zz}.$$

Because of symmetry, the solution does not depend on  $\theta$  or  $z$ .

$$\begin{aligned} u_t(r, t) &= \kappa \left( u_{rr}(r, t) + \frac{1}{r}u_r(r, t) \right), & 0 < r < a, & \quad t > 0, \\ u(r, 0) &= T, & u(0, t) & \text{is bounded,} & \quad u(a, t) &= 0. \end{aligned}$$

We will solve this problem with an expansion in eigen-solutions of the partial differential equation that satisfy the homogeneous boundary conditions at  $r = 0$  and  $r = a$ . We substitute the separation of variables  $u(r, t) =$

$R(r)T(t)$  into the partial differential equation.

$$RT' = \kappa \left( R''T + \frac{1}{r}R'T \right)$$
$$\frac{T'}{\kappa T} = \frac{R''}{R} + \frac{R'}{rR} = -\lambda^2$$

We have the eigenvalue problem,

$$R'' + \frac{1}{r}R' + \lambda^2 R = 0, \quad R(0) \text{ is bounded}, R(a) = 0.$$

Recall that the Bessel equation,

$$y'' + \frac{1}{x}y' + \left( \lambda^2 - \frac{\nu^2}{x^2} \right) y = 0,$$

has the general solution  $y = c_1 J_\nu(\lambda x) + c_2 Y_\nu(\lambda x)$ . We discard the Bessel function of the second kind,  $Y_\nu$ , as it is unbounded at the origin. The solution for  $R(r)$  is

$$R(r) = J_0(\lambda r).$$

Applying the boundary condition at  $r = a$ , we see that the eigenvalues and eigenfunctions are

$$\lambda_n = \frac{\beta_n}{a}, \quad R_n = J_0 \left( \frac{\beta_n r}{a} \right), \quad n \in \mathbb{N},$$

where  $\{\beta_n\}$  are the positive roots of the Bessel function  $J_0$ .

The differential equation for  $T$  becomes,

$$T'_n = -\kappa \left( \frac{\beta_n}{a} \right)^2 T_n,$$

which has the solutions,

$$T_n = \exp \left( -\kappa \left( \frac{\beta_n}{a} \right)^2 t \right).$$

The eigen-solutions of the partial differential equation for  $u(r, t)$  are,

$$u_n(r, t) = J_0 \left( \frac{\beta_n r}{a} \right) \exp \left( -\kappa \left( \frac{\beta_n}{a} \right)^2 t \right).$$

The solution  $u(r, t)$  is a linear combination of the eigen-solutions,  $u_n$ . The slowest decaying eigenfunction is,

$$u_1(r, t) = J_0 \left( \frac{\beta_1 r}{a} \right) \exp \left( -\kappa \left( \frac{\beta_1}{a} \right)^2 t \right).$$

Thus the e-folding time is

$$\Delta_e = \frac{a^2}{\kappa \beta_1^2}.$$

c) The problem is

$$\begin{aligned} u_t(r, \theta, \phi, t) &= \kappa \Delta u(r, \theta, \phi, t), & 0 < r < a, & \quad 0 < \theta < 2\pi, & \quad 0 < \phi < \pi, & \quad t > 0, \\ u(r, \theta, \phi, 0) &= T, & u(0, \theta, \phi, t) & \text{is bounded,} & u(a, \theta, \phi, t) &= 0. \end{aligned}$$

The Laplacian in spherical coordinates is,

$$\Delta u = u_{rr} + \frac{2}{r} u_r + \frac{1}{r^2} u_{\theta\theta} + \frac{\cos \theta}{r^2 \sin \theta} u_\theta + \frac{1}{r^2 \sin^2 \theta} u_{\phi\phi}.$$

Because of symmetry, the solution does not depend on  $\theta$  or  $\phi$ .

$$\begin{aligned} u_t(r, t) &= \kappa \left( u_{rr}(r, t) + \frac{2}{r} u_r(r, t) \right), & 0 < r < a, & \quad t > 0, \\ u(r, 0) &= T, & u(0, t) & \text{is bounded,} & u(a, t) &= 0 \end{aligned}$$



We will solve this problem with an expansion in eigen-solutions of the partial differential equation that satisfy the homogeneous boundary conditions at  $r = 0$  and  $r = a$ . We substitute the separation of variables  $u(r, t) = R(r)T(t)$  into the partial differential equation.

$$RT' = \kappa \left( R''T + \frac{2}{r}R'T \right)$$

$$\frac{T'}{\kappa T} = \frac{R''}{R} + \frac{2}{r} \frac{R'}{R} = -\lambda^2$$

We have the eigenvalue problem,

$$R'' + \frac{2}{r}R' + \lambda^2 R = 0, \quad R(0) \text{ is bounded}, \quad R(a) = 0.$$

Recall that the equation,

$$y'' + \frac{2}{x}y' + \left( \lambda^2 - \frac{\nu(\nu+1)}{x^2} \right) y = 0,$$

has the general solution  $y = c_1 j_\nu(\lambda x) + c_2 y_\nu(\lambda x)$ , where  $j_\nu$  and  $y_\nu$  are the spherical Bessel functions of the first and second kind. We discard  $y_\nu$  as it is unbounded at the origin. (The spherical Bessel functions are related to the Bessel functions by

$$j_\nu(x) = \sqrt{\frac{\pi}{2x}} J_{\nu+1/2}(x).$$

The solution for  $R(r)$  is

$$R_n = j_0(\lambda r).$$

Applying the boundary condition at  $r = a$ , we see that the eigenvalues and eigenfunctions are

$$\lambda_n = \frac{\gamma_n}{a}, \quad R_n = j_0 \left( \frac{\gamma_n r}{a} \right), \quad n \in \mathbb{N}.$$

The problem for  $T$  becomes

$$T'_n = -\kappa \left( \frac{\gamma_n}{a} \right)^2 T_n,$$

which has the solutions,

$$T_n = \exp\left(-\kappa\left(\frac{\gamma_n}{a}\right)^2 t\right).$$

The eigen-solutions of the partial differential equation are,

$$u_n(r, t) = j_0\left(\frac{\gamma_n r}{a}\right) \exp\left(-\kappa\left(\frac{\gamma_n}{a}\right)^2 t\right).$$

The slowest decaying eigen-solution is,

$$u_1(r, t) = j_0\left(\frac{\gamma_1 r}{a}\right) \exp\left(-\kappa\left(\frac{\gamma_1}{a}\right)^2 t\right).$$

Thus the e-folding time is

$$\Delta_e = \frac{a^2}{\kappa\gamma_1^2}.$$

- d) If the edges are perfectly insulated, then no heat escapes through the boundary. The temperature is constant for all time. There is no e-folding time.

### Solution 37.23

We will solve this problem with an eigenfunction expansion. Since the partial differential equation is homogeneous, we will find eigenfunctions in both  $x$  and  $y$ . We substitute the separation of variables  $u(x, y, t) = X(x)Y(y)T(t)$  into the partial differential equation.

$$XYT' = \kappa(t)(X''YT + XY''T)$$

$$\frac{T'}{\kappa(t)T} = \frac{X''}{X} + \frac{Y''}{Y} = -\lambda^2$$

$$\frac{X''}{X} = -\frac{Y''}{Y} - \lambda^2 = -\mu^2$$

First we have a Sturm-Liouville eigenvalue problem for  $X$ ,

$$X'' = \mu^2 X, \quad X'(0) = X'(a) = 0,$$

which has the solutions,

$$\mu_m = \frac{m\pi}{a}, \quad X_m = \cos\left(\frac{m\pi x}{a}\right), \quad m = 0, 1, 2, \dots$$

Now we have a Sturm-Liouville eigenvalue problem for  $Y$ ,

$$Y'' = -\left(\lambda^2 - \left(\frac{m\pi}{a}\right)^2\right)Y, \quad Y(0) = Y(b) = 0,$$

which has the solutions,

$$\lambda_{mn} = \sqrt{\left(\frac{m\pi}{a}\right)^2 + \left(\frac{n\pi}{b}\right)^2}, \quad Y_n = \sin\left(\frac{n\pi y}{b}\right), \quad m = 0, 1, 2, \dots, \quad n = 1, 2, 3, \dots$$

A few of the eigenfunctions,  $\cos\left(\frac{m\pi x}{a}\right)\sin\left(\frac{n\pi y}{b}\right)$ , are shown in Figure 37.3.

The differential equation for  $T$  becomes,

$$T'_{mn} = -\left(\left(\frac{m\pi}{a}\right)^2 + \left(\frac{n\pi}{b}\right)^2\right)\kappa(t)T_{mn},$$

which has the solutions,

$$T_{mn} = \exp\left(-\left(\left(\frac{m\pi}{a}\right)^2 + \left(\frac{n\pi}{b}\right)^2\right)\int_0^t \kappa(\tau) d\tau\right).$$

The eigen-solutions of the partial differential equation are,

$$u_{mn} = \cos\left(\frac{m\pi x}{a}\right)\sin\left(\frac{n\pi y}{b}\right)\exp\left(-\left(\left(\frac{m\pi}{a}\right)^2 + \left(\frac{n\pi}{b}\right)^2\right)\int_0^t \kappa(\tau) d\tau\right).$$

The solution of the partial differential equation is,

$$u(x, y, t) = \sum_{m=0}^{\infty} \sum_{n=1}^{\infty} c_{mn} \cos\left(\frac{m\pi x}{a}\right) \sin\left(\frac{n\pi y}{b}\right) \exp\left(-\left(\left(\frac{m\pi}{a}\right)^2 + \left(\frac{n\pi}{b}\right)^2\right)\int_0^t \kappa(\tau) d\tau\right).$$

We determine the coefficients from the initial condition.

$$u(x, y, 0) = \sum_{m=0}^{\infty} \sum_{n=1}^{\infty} c_{mn} \cos\left(\frac{m\pi x}{a}\right) \sin\left(\frac{n\pi y}{b}\right) = f(x, y)$$

$$c_{0n} = \frac{2}{ab} \int_0^a \int_0^b f(x, y) \sin\left(\frac{n\pi y}{b}\right) dy dx$$

$$c_{mn} = \frac{4}{ab} \int_0^a \int_0^b f(x, y) \cos\left(\frac{m\pi x}{a}\right) \sin\left(\frac{n\pi y}{b}\right) dy dx$$

### Solution 37.24

The steady state temperature satisfies Laplace's equation,  $\Delta u = 0$ . The Laplacian in cylindrical coordinates is,

$$\Delta u(r, \theta, z) = u_{rr} + \frac{1}{r}u_r + \frac{1}{r^2}u_{\theta\theta} + u_{zz}.$$

Because of the homogeneity in the  $z$  direction, we reduce the partial differential equation to,

$$u_{rr} + \frac{1}{r}u_r + \frac{1}{r^2}u_{\theta\theta} = 0, \quad 0 < r < 1, \quad 0 < \theta < \pi.$$

The boundary conditions are,

$$u(r, 0) = u(r, \pi) = 0, \quad u(0, \theta) = 0, \quad u(1, \theta) = 1.$$

We will solve this problem with an eigenfunction expansion. We substitute the separation of variables  $u(r, \theta) = R(r)T(\theta)$  into the partial differential equation.

$$\begin{aligned} R''T + \frac{1}{r}R'T + \frac{1}{r^2}RT'' &= 0 \\ r^2\frac{R''}{R} + r\frac{R'}{R} &= -\frac{T''}{T} = \lambda^2 \end{aligned}$$

We have the regular Sturm-Liouville eigenvalue problem,

$$T'' = -\lambda^2 T, \quad T(0) = T(\pi) = 0,$$

which has the solutions,

$$\lambda_n = n, \quad T_n = \sin(n\theta), \quad n \in \mathbb{N}.$$

The problem for  $R$  becomes,

$$r^2 R'' + rR' - n^2 R = 0, \quad R(0) = 0.$$

This is an Euler equation. We substitute  $R = r^\alpha$  into the differential equation to obtain,

$$\begin{aligned} \alpha(\alpha - 1) + \alpha - n^2 &= 0, \\ \alpha &= \pm n. \end{aligned}$$

The general solution of the differential equation for  $R$  is

$$R_n = c_1 r^n + c_2 r^{-n}.$$

The solution that vanishes at  $r = 0$  is

$$R_n = c r^n.$$

The eigen-solutions of the differential equation are,

$$u_n = r^n \sin(n\theta).$$

The solution of the partial differential equation is

$$u(r, \theta) = \sum_{n=1}^{\infty} a_n r^n \sin(n\theta).$$

We determine the coefficients from the boundary condition at  $r = 1$ .

$$\begin{aligned} u(1, \theta) &= \sum_{n=1}^{\infty} a_n \sin(n\theta) = 1 \\ a_n &= \frac{2}{\pi} \int_0^\pi \sin(n\theta) \, d\theta = \frac{2}{\pi n} (1 - (-1)^n) \end{aligned}$$

The solution of the partial differential equation is

$$u(r, \theta) = \frac{4}{\pi} \sum_{\substack{n=1 \\ \text{odd } n}}^{\infty} r^n \sin(n\theta).$$

### Solution 37.25

The problem is

$$\begin{aligned} u_{xx} + u_{yy} &= 0, & 0 < x, & \quad 0 < y < 1, \\ u(x, 0) = u(x, 1) &= 0, & u(0, y) &= f(y). \end{aligned}$$

We substitute the separation of variables  $u(x, y) = X(x)Y(y)$  into the partial differential equation.

$$\begin{aligned} X''Y + XY'' &= 0 \\ \frac{X''}{X} &= -\frac{Y''}{Y} = \lambda^2 \end{aligned}$$

We have the regular Sturm-Liouville problem,

$$Y'' = -\lambda^2 Y, \quad Y(0) = Y(1) = 0,$$

which has the solutions,

$$\lambda_n = n\pi, \quad Y_n = \sin(n\pi y), \quad n \in \mathbb{N}.$$

The problem for  $X$  becomes,

$$X_n'' = (n\pi)^2 X,$$

which has the general solution,

$$X_n = c_1 e^{n\pi x} + c_2 e^{-n\pi x}.$$

The solution that is bounded as  $x \rightarrow \infty$  is,

$$X_n = c e^{-n\pi x}.$$

The eigen-solutions of the partial differential equation are,

$$u_n = e^{-n\pi x} \sin(n\pi y), \quad n \in \mathbb{N}.$$

The solution of the partial differential equation is,

$$u(x, y) = \sum_{n=1}^{\infty} a_n e^{-n\pi x} \sin(n\pi y).$$

We find the coefficients from the boundary condition at  $x = 0$ .

$$u(0, y) = \sum_{n=1}^{\infty} a_n \sin(n\pi y) = f(y)$$

$$a_n = 2 \int_0^1 f(y) \sin(n\pi y) dy$$

### Solution 37.26

The Laplacian in polar coordinates is

$$\Delta u \equiv u_{rr} + \frac{1}{r}u_r + \frac{1}{r^2}u_{\theta\theta}.$$

Since we have homogeneous boundary conditions at  $\theta = 0$  and  $\theta = \alpha$ , we will solve this problem with an eigenfunction expansion. We substitute the separation of variables  $u(r, \theta) = R(r)\Theta(\theta)$  into Laplace's equation.

$$\begin{aligned} R''\Theta + \frac{1}{r}R'\Theta + \frac{1}{r^2}R\Theta'' &= 0 \\ r^2\frac{R''}{R} + r\frac{R'}{R} &= -\frac{\Theta''}{\Theta} = \lambda^2. \end{aligned}$$

We have a regular Sturm-Liouville eigenvalue problem for  $\Theta$ .

$$\Theta'' = -\lambda^2\Theta, \quad \Theta(0) = \Theta(\alpha) = 0$$

$$\lambda_n = \frac{n\pi}{\alpha}, \quad \Theta_n = \sin\left(\frac{n\pi\theta}{\alpha}\right), \quad n \in \mathbb{Z}^+.$$

We have Euler equations for  $R_n$ . We solve them with the substitution  $R = r^\beta$ .

$$r^2 R_n'' + r R_n' - \left(\frac{n\pi}{\alpha}\right)^2 R_n = 0, \quad R_n(a) = 0$$

$$\beta(\beta - 1) + \beta - \left(\frac{n\pi}{\alpha}\right)^2 = 0$$

$$\beta = \pm \frac{n\pi}{\alpha}$$

$$R_n = c_1 r^{n\pi/\alpha} + c_2 r^{-n\pi/\alpha}.$$

The solution, (up to a multiplicative constant), that vanishes at  $r = a$  is

$$R_n = r^{n\pi/\alpha} - a^{2n\pi/\alpha} r^{-n\pi/\alpha}.$$

Thus the series expansion of our solution is,

$$u(r, \theta) = \sum_{n=1}^{\infty} u_n \left( r^{n\pi/\alpha} - a^{2n\pi/\alpha} r^{-n\pi/\alpha} \right) \sin\left(\frac{n\pi\theta}{\alpha}\right).$$

We determine the coefficients from the boundary condition at  $r = b$ .

$$u(b, \theta) = \sum_{n=1}^{\infty} u_n \left( b^{n\pi/\alpha} - a^{2n\pi/\alpha} b^{-n\pi/\alpha} \right) \sin\left(\frac{n\pi\theta}{\alpha}\right) = f(\theta)$$

$$u_n = \frac{2}{\alpha \left( b^{n\pi/\alpha} - a^{2n\pi/\alpha} b^{-n\pi/\alpha} \right)} \int_0^\alpha f(\theta) \sin\left(\frac{n\pi\theta}{\alpha}\right) d\theta$$



### Solution 37.27

a) The mathematical statement of the problem is

$$\begin{aligned}u_{tt} &= c^2 u_{xx}, & 0 < x < L, & \quad t > 0, \\u(0, t) &= u(L, t) = 0, \\u(x, 0) &= 0, \quad u_t(x, 0) = \begin{cases} v & \text{for } |x - \xi| < d \\ 0 & \text{for } |x - \xi| > d. \end{cases}\end{aligned}$$

Because we are interested in the harmonics of the motion, we will solve this problem with an eigenfunction expansion in  $x$ . We substitute the separation of variables  $u(x, t) = X(x)T(t)$  into the wave equation.

$$\begin{aligned}XT'' &= c^2 X''T \\ \frac{T''}{c^2 T} &= \frac{X''}{X} = -\lambda^2\end{aligned}$$

The eigenvalue problem for  $X$  is,

$$X'' = -\lambda^2 X, \quad X(0) = X(L) = 0,$$

which has the solutions,

$$\lambda_n = \frac{n\pi}{L}, \quad X_n = \sin\left(\frac{n\pi x}{L}\right), \quad n \in \mathbb{N}.$$

The ordinary differential equation for the  $T_n$  are,

$$T_n'' = -\left(\frac{n\pi c}{L}\right)^2 T_n,$$

which have the linearly independent solutions,

$$\cos\left(\frac{n\pi ct}{L}\right), \quad \sin\left(\frac{n\pi ct}{L}\right).$$

The solution for  $u(x, t)$  is a linear combination of the eigen-solutions.

$$u(x, t) = \sum_{n=1}^{\infty} \sin\left(\frac{n\pi x}{L}\right) \left( a_n \cos\left(\frac{n\pi ct}{L}\right) + b_n \sin\left(\frac{n\pi ct}{L}\right) \right)$$

Since the string initially has zero displacement, each of the  $a_n$  are zero.

$$u(x, t) = \sum_{n=1}^{\infty} b_n \sin\left(\frac{n\pi x}{L}\right) \sin\left(\frac{n\pi ct}{L}\right)$$

Now we use the initial velocity to determine the coefficients in the expansion. Because the position is a continuous function of  $x$ , and there is a jump discontinuity in the velocity as a function of  $x$ , the coefficients in the expansion will decay as  $1/n^2$ .

$$u_t(x, 0) = \sum_{n=1}^{\infty} \frac{n\pi c}{L} b_n \sin\left(\frac{n\pi x}{L}\right) = \begin{cases} v & \text{for } |x - \xi| < d \\ 0 & \text{for } |x - \xi| > d. \end{cases}$$

$$\frac{n\pi c}{L} b_n = \frac{2}{L} \int_0^L u_t(x, 0) \sin\left(\frac{n\pi x}{L}\right) dx$$

$$\begin{aligned} b_n &= \frac{2}{n\pi c} \int_{\xi-d}^{\xi+d} v \sin\left(\frac{n\pi x}{L}\right) dx \\ &= \frac{4Lv}{n^2\pi^2 c} \sin\left(\frac{n\pi d}{L}\right) \sin\left(\frac{n\pi \xi}{L}\right) \end{aligned}$$

The solution for  $u(x, t)$  is,

$$u(x, t) = \frac{4Lv}{\pi^2 c} \sum_{n=1}^{\infty} \frac{1}{n^2} \sin\left(\frac{n\pi d}{L}\right) \sin\left(\frac{n\pi \xi}{L}\right) \sin\left(\frac{n\pi x}{L}\right) \sin\left(\frac{n\pi ct}{L}\right).$$

**b)** The form of the solution is again,

$$u(x, t) = \sum_{n=1}^{\infty} b_n \sin\left(\frac{n\pi x}{L}\right) \sin\left(\frac{n\pi ct}{L}\right)$$

We determine the coefficients in the expansion from the initial velocity.

$$u_t(x, 0) = \sum_{n=1}^{\infty} \frac{n\pi c}{L} b_n \sin\left(\frac{n\pi x}{L}\right) = \begin{cases} v \cos\left(\frac{\pi(x-\xi)}{2d}\right) & \text{for } |x - \xi| < d \\ 0 & \text{for } |x - \xi| > d. \end{cases}$$

$$\frac{n\pi c}{L} b_n = \frac{2}{L} \int_0^L u_t(x, 0) \sin\left(\frac{n\pi x}{L}\right) dx$$

$$b_n = \frac{2}{n\pi c} \int_{\xi-d}^{\xi+d} v \cos\left(\frac{\pi(x-\xi)}{2d}\right) \sin\left(\frac{n\pi x}{L}\right) dx$$

$$b_n = \begin{cases} \frac{8dL^2v}{n\pi^2c(L^2-4d^2n^2)} \cos\left(\frac{n\pi d}{L}\right) \sin\left(\frac{n\pi\xi}{L}\right) & \text{for } d \neq \frac{L}{2n}, \\ \frac{v}{n^2\pi^2c} (2n\pi d + L \sin\left(\frac{2n\pi d}{L}\right)) \sin\left(\frac{n\pi\xi}{L}\right) & \text{for } d = \frac{L}{2n} \end{cases}$$

The solution for  $u(x, t)$  is,

$$u(x, t) = \frac{8dL^2v}{\pi^2c} \sum_{n=1}^{\infty} \frac{1}{n(L^2 - 4d^2n^2)} \cos\left(\frac{n\pi d}{L}\right) \sin\left(\frac{n\pi\xi}{L}\right) \sin\left(\frac{n\pi x}{L}\right) \sin\left(\frac{n\pi ct}{L}\right) \quad \text{for } d \neq \frac{L}{2n},$$

$$u(x, t) = \frac{v}{\pi^2c} \sum_{n=1}^{\infty} \frac{1}{n^2} \left(2n\pi d + L \sin\left(\frac{2n\pi d}{L}\right)\right) \sin\left(\frac{n\pi\xi}{L}\right) \sin\left(\frac{n\pi x}{L}\right) \sin\left(\frac{n\pi ct}{L}\right) \quad \text{for } d = \frac{L}{2n}.$$

**c)** The kinetic energy of the string is

$$E = \frac{1}{2} \int_0^L \rho (u_t(x, t))^2 dx,$$

where  $\rho$  is the density of the string per unit length.

**Flat Hammer.** The  $n^{\text{th}}$  harmonic is

$$u_n = \frac{4Lv}{n^2\pi^2c} \sin\left(\frac{n\pi d}{L}\right) \sin\left(\frac{n\pi\xi}{L}\right) \sin\left(\frac{n\pi x}{L}\right) \sin\left(\frac{n\pi ct}{L}\right).$$

The kinetic energy of the  $n^{\text{th}}$  harmonic is

$$E_n = \frac{\rho}{2} \int_0^L \left(\frac{\partial u_n}{\partial t}\right)^2 dx = \frac{4Lv^2}{n^2\pi^2} \sin^2\left(\frac{n\pi d}{L}\right) \sin^2\left(\frac{n\pi\xi}{L}\right) \cos^2\left(\frac{n\pi ct}{L}\right).$$

This will be maximized if

$$\begin{aligned} \sin^2\left(\frac{n\pi\xi}{L}\right) &= 1, \\ \frac{n\pi\xi}{L} &= \frac{\pi(2m-1)}{2}, \quad m = 1, \dots, n, \\ \xi &= \frac{(2m-1)L}{2n}, \quad m = 1, \dots, n \end{aligned}$$

We note that the kinetic energies of the  $n^{\text{th}}$  harmonic decay as  $1/n^2$ .

**Curved Hammer.** We assume that  $d \neq \frac{L}{2n}$ . The  $n^{\text{th}}$  harmonic is

$$u_n = \frac{8dL^2v}{n\pi^2c(L^2 - 4d^2n^2)} \cos\left(\frac{n\pi d}{L}\right) \sin\left(\frac{n\pi\xi}{L}\right) \sin\left(\frac{n\pi x}{L}\right) \sin\left(\frac{n\pi ct}{L}\right).$$

The kinetic energy of the  $n^{\text{th}}$  harmonic is

$$E_n = \frac{\rho}{2} \int_0^L \left(\frac{\partial u_n}{\partial t}\right)^2 dx = \frac{16d^2L^3v^2}{\pi^2(L^2 - 4d^2n^2)^2} \cos^2\left(\frac{n\pi d}{L}\right) \sin^2\left(\frac{n\pi\xi}{L}\right) \cos^2\left(\frac{n\pi ct}{L}\right).$$

This will be maximized if

$$\sin^2\left(\frac{n\pi\xi}{L}\right) = 1,$$

$$\xi = \frac{(2m-1)L}{2n}, \quad m = 1, \dots, n$$

We note that the kinetic energies of the  $n^{\text{th}}$  harmonic decay as  $1/n^4$ .

### Solution 37.28

In mathematical notation, the problem is

$$\begin{aligned}u_{tt} - c^2 u_{xx} &= s(x, t), \quad 0 < x < L, \quad t > 0, \\u(0, t) &= u(L, t) = 0, \\u(x, 0) &= u_t(x, 0) = 0.\end{aligned}$$

Since this is an inhomogeneous partial differential equation, we will expand the solution in a series of eigenfunctions in  $x$  for which the coefficients are functions of  $t$ . The solution for  $u$  has the form,

$$u(x, t) = \sum_{n=1}^{\infty} u_n(t) \sin\left(\frac{n\pi x}{L}\right).$$

Substituting this expression into the inhomogeneous partial differential equation will give us ordinary differential equations for each of the  $u_n$ .

$$\sum_{n=1}^{\infty} \left( u_n'' + c^2 \left(\frac{n\pi}{L}\right)^2 u_n \right) \sin\left(\frac{n\pi x}{L}\right) = s(x, t).$$

We expand the right side in a series of the eigenfunctions.

$$s(x, t) = \sum_{n=1}^{\infty} s_n(t) \sin\left(\frac{n\pi x}{L}\right).$$

For  $0 < t < \delta$  we have

$$\begin{aligned}
 s_n(t) &= \frac{2}{L} \int_0^L s(x, t) \sin\left(\frac{n\pi x}{L}\right) dx \\
 &= \frac{2}{L} \int_0^L v \cos\left(\frac{\pi(x - \xi)}{2d}\right) \sin\left(\frac{\pi t}{\delta}\right) \sin\left(\frac{n\pi x}{L}\right) dx \\
 &= \frac{8dLv}{\pi(L^2 - 4d^2n^2)} \cos\left(\frac{n\pi d}{L}\right) \sin\left(\frac{n\pi \xi}{L}\right) \sin\left(\frac{\pi t}{\delta}\right).
 \end{aligned}$$

For  $t > \delta$ ,  $s_n(t) = 0$ . Substituting this into the partial differential equation yields,

$$u_n'' + \left(\frac{n\pi c}{L}\right)^2 u_n = \begin{cases} \frac{8dLv}{\pi(L^2 - 4d^2n^2)} \cos\left(\frac{n\pi d}{L}\right) \sin\left(\frac{n\pi \xi}{L}\right) \sin\left(\frac{\pi t}{\delta}\right), & \text{for } t < \delta, \\ 0 & \text{for } t > \delta. \end{cases}$$

Since the initial position and velocity of the string is zero, we have

$$u_n(0) = u_n'(0) = 0.$$

First we solve the differential equation on the range  $0 < t < \delta$ . The homogeneous solutions are

$$\cos\left(\frac{n\pi ct}{L}\right), \quad \sin\left(\frac{n\pi ct}{L}\right).$$

Since the right side of the ordinary differential equation is a constant times  $\sin(\pi t/\delta)$ , which is an eigenfunction of the differential operator, we can guess the form of a particular solution,  $p_n(t)$ .

$$p_n(t) = d \sin\left(\frac{\pi t}{\delta}\right)$$

We substitute this into the ordinary differential equation to determine the multiplicative constant  $d$ .

$$p_n(t) = -\frac{8d\delta^2 L^3 v}{\pi^3(L^2 - c^2\delta^2 n^2)(L^2 - 4d^2 n^2)} \cos\left(\frac{n\pi d}{L}\right) \sin\left(\frac{n\pi \xi}{L}\right) \sin\left(\frac{\pi t}{\delta}\right)$$

The general solution for  $u_n(t)$  is

$$u_n(t) = a \cos\left(\frac{n\pi ct}{L}\right) + b \sin\left(\frac{n\pi ct}{L}\right) - \frac{8d\delta^2 L^3 v}{\pi^3(L^2 - c^2\delta^2 n^2)(L^2 - 4d^2 n^2)} \cos\left(\frac{n\pi d}{L}\right) \sin\left(\frac{n\pi \xi}{L}\right) \sin\left(\frac{\pi t}{\delta}\right).$$

We use the initial conditions to determine the constants  $a$  and  $b$ . The solution for  $0 < t < \delta$  is

$$u_n(t) = \frac{8d\delta^2 L^3 v}{\pi^3(L^2 - c^2\delta^2 n^2)(L^2 - 4d^2 n^2)} \cos\left(\frac{n\pi d}{L}\right) \sin\left(\frac{n\pi \xi}{L}\right) \left(\frac{L}{\delta cn} \sin\left(\frac{n\pi ct}{L}\right) - \sin\left(\frac{\pi t}{\delta}\right)\right).$$

The solution for  $t > \delta$ , the solution is a linear combination of the homogeneous solutions. This linear combination is determined by the position and velocity at  $t = \delta$ . We use the above solution to determine these quantities.

$$u_n(\delta) = \frac{8d\delta^2 L^4 v}{\pi^3 \delta cn(L^2 - c^2\delta^2 n^2)(L^2 - 4d^2 n^2)} \cos\left(\frac{n\pi d}{L}\right) \sin\left(\frac{n\pi \xi}{L}\right) \sin\left(\frac{n\pi c\delta}{L}\right)$$

$$u'_n(\delta) = \frac{8d\delta^2 L^3 v}{\pi^2 \delta(L^2 - c^2\delta^2 n^2)(L^2 - 4d^2 n^2)} \cos\left(\frac{n\pi d}{L}\right) \sin\left(\frac{n\pi \xi}{L}\right) \left(1 + \cos\left(\frac{n\pi c\delta}{L}\right)\right)$$

The fundamental set of solutions at  $t = \delta$  is

$$\left\{ \cos\left(\frac{n\pi c(t - \delta)}{L}\right), \frac{L}{n\pi c} \sin\left(\frac{n\pi c(t - \delta)}{L}\right) \right\}$$

From the initial conditions at  $t = \delta$ , we see that the solution for  $t > \delta$  is

$$u_n(t) = \frac{8d\delta^2 L^3 v}{\pi^3(L^2 - c^2\delta^2 n^2)(L^2 - 4d^2 n^2)} \cos\left(\frac{n\pi d}{L}\right) \sin\left(\frac{n\pi \xi}{L}\right) \left(\frac{L}{\delta cn} \sin\left(\frac{n\pi c\delta}{L}\right) \cos\left(\frac{n\pi c(t - \delta)}{L}\right) + \frac{\pi}{\delta} \left(1 + \cos\left(\frac{n\pi c\delta}{L}\right)\right) \sin\left(\frac{n\pi c(t - \delta)}{L}\right)\right).$$

**Width of the Hammer.** The  $n^{\text{th}}$  harmonic has the width dependent factor,

$$\frac{d}{L^2 - 4d^2n^2} \cos\left(\frac{n\pi d}{L}\right).$$

Differentiating this expression and trying to find zeros to determine extrema would give us an equation with both algebraic and transcendental terms. Thus we don't attempt to find the maxima exactly. We know that  $d < L$ . The cosine factor is large when

$$\begin{aligned}\frac{n\pi d}{L} &\approx m\pi, \quad m = 1, 2, \dots, n-1, \\ d &\approx \frac{mL}{n}, \quad m = 1, 2, \dots, n-1.\end{aligned}$$

Substituting  $d = mL/n$  into the width dependent factor gives us

$$\frac{d}{L^2(1 - 4m^2)}(-1)^m.$$

Thus we see that the amplitude of the  $n^{\text{th}}$  harmonic and hence its kinetic energy will be maximized for

$$\boxed{d \approx \frac{L}{n}}$$

The cosine term in the width dependent factor vanishes when

$$d = \frac{(2m-1)L}{2n}, \quad m = 1, 2, \dots, n.$$

The kinetic energy of the  $n^{\text{th}}$  harmonic is minimized for these widths.

For the lower harmonics,  $n \ll \frac{L}{2d}$ , the kinetic energy is proportional to  $d^2$ ; for the higher harmonics,  $n \gg \frac{L}{2d}$ , the kinetic energy is proportional to  $1/d^2$ .



**Duration of the Blow.** The  $n^{\text{th}}$  harmonic has the duration dependent factor,

$$\frac{\delta^2}{L^2 - n^2 c^2 \delta^2} \left( \frac{L}{nc\delta} \sin\left(\frac{n\pi c\delta}{L}\right) \cos\left(\frac{n\pi c(t-\delta)}{L}\right) + \frac{\pi}{\delta} \left(1 + \cos\left(\frac{n\pi c\delta}{L}\right)\right) \sin\left(\frac{n\pi c(t-\delta)}{L}\right) \right).$$

If we assume that  $\delta$  is small, then

$$\frac{L}{nc\delta} \sin\left(\frac{n\pi c\delta}{L}\right) \approx \pi.$$

and

$$\frac{\pi}{\delta} \left(1 + \cos\left(\frac{n\pi c\delta}{L}\right)\right) \approx \frac{2\pi}{\delta}.$$

Thus the duration dependent factor is about,

$$\frac{\delta}{L^2 - n^2 c^2 \delta^2} \sin\left(\frac{n\pi c(t-\delta)}{L}\right).$$

Thus for the lower harmonics, (those satisfying  $n \ll \frac{L}{c\delta}$ ), the amplitude is proportional to  $\delta$ , which means that the kinetic energy is proportional to  $\delta^2$ . For the higher harmonics, (those with  $n \gg \frac{L}{c\delta}$ ), the amplitude is proportional to  $1/\delta$ , which means that the kinetic energy is proportional to  $1/\delta^2$ .

### Solution 37.29

Substituting  $u(x, y, z, t) = v(x, y, z) e^{i\omega t}$  into the wave equation will give us a Helmholtz equation.

$$\begin{aligned} -\omega^2 v e^{i\omega t} - c^2 (v_{xx} + v_{yy} + v_{zz}) e^{i\omega t} &= 0 \\ v_{xx} + v_{yy} + v_{zz} + k^2 v &= 0. \end{aligned}$$

We find the propagating modes with separation of variables. We substitute  $v = X(x)Y(y)Z(z)$  into the Helmholtz equation.

$$\begin{aligned} X''YZ + XY''Z + XYZ'' + k^2XYZ &= 0 \\ -\frac{X''}{X} &= \frac{Y''}{Y} + \frac{Z''}{Z} + k^2 = \nu^2 \end{aligned}$$

The eigenvalue problem in  $x$  is

$$X'' = -\nu^2 X, \quad X(0) = X(L) = 0,$$

which has the solutions,

$$\nu_n = \frac{n\pi}{L}, \quad X_n = \sin\left(\frac{n\pi x}{L}\right).$$

We continue with the separation of variables.

$$-\frac{Y''}{Y} = \frac{Z''}{Z} + k^2 - \left(\frac{n\pi}{L}\right)^2 = \mu^2$$

The eigenvalue problem in  $y$  is

$$Y'' = -\mu^2 Y, \quad Y(0) = Y(L) = 0,$$

which has the solutions,

$$\mu_n = \frac{m\pi}{L}, \quad Y_m = \sin\left(\frac{m\pi y}{L}\right).$$

Now we have an ordinary differential equation for  $Z$ ,

$$Z'' + \left(k^2 - \left(\frac{\pi}{L}\right)^2 (n^2 + m^2)\right) Z = 0.$$

We define the eigenvalues,

$$\lambda_{n,m}^2 = k^2 - \left(\frac{\pi}{L}\right)^2 (n^2 + m^2).$$

If  $k^2 - \left(\frac{\pi}{L}\right)^2 (n^2 + m^2) < 0$ , then the solutions for  $Z$  are,

$$\exp\left(\pm\sqrt{\left(\left(\frac{\pi}{L}\right)^2 (n^2 + m^2) - k^2\right)}z\right).$$

We discard this case, as the solutions are not bounded as  $z \rightarrow \infty$ .

If  $k^2 - \left(\frac{\pi}{L}\right)^2 (n^2 + m^2) = 0$ , then the solutions for  $Z$  are,

$$\{1, z\}$$

The solution  $Z = 1$  satisfies the boundedness and nonzero condition at infinity. This corresponds to a standing wave.

If  $k^2 - \left(\frac{\pi}{L}\right)^2 (n^2 + m^2) > 0$ , then the solutions for  $Z$  are,

$$e^{\pm i\lambda_{n,m}z}.$$

These satisfy the boundedness and nonzero conditions at infinity. For values of  $n, m$  satisfying  $k^2 - \left(\frac{\pi}{L}\right)^2 (n^2 + m^2) \geq 0$ , there are the propagating modes,

$$u_{n,m} = \sin\left(\frac{n\pi x}{L}\right) \sin\left(\frac{m\pi y}{L}\right) e^{i(\omega t \pm \lambda_{n,m}z)}.$$

### Solution 37.30

$$\begin{aligned} u_{tt} &= c^2 \Delta u, & 0 < x < a, & 0 < y < b, \\ u(0, y) &= u(a, y) = u(x, 0) = u(x, b) = 0. \end{aligned} \tag{37.12}$$

We substitute the separation of variables  $u(x, y, t) = X(x)Y(y)T(t)$  into Equation 37.12.

$$\begin{aligned} \frac{T''}{c^2 T} &= \frac{X''}{X} + \frac{Y''}{Y} = -\nu \\ \frac{X''}{X} &= -\frac{Y''}{Y} - \nu = -\mu \end{aligned}$$

This gives us differential equations for  $X(x)$ ,  $Y(y)$  and  $T(t)$ .

$$\begin{aligned} X'' &= -\mu X, & X(0) &= X(a) = 0 \\ Y'' &= -(\nu - \mu)Y, & Y(0) &= Y(b) = 0 \\ T'' &= -c^2 \nu T \end{aligned}$$

First we solve the problem for  $X$ .

$$\mu_m = \left(\frac{m\pi}{a}\right)^2, \quad X_m = \sin\left(\frac{m\pi x}{a}\right)$$

Then we solve the problem for  $Y$ .

$$\nu_{m,n} = \left(\frac{m\pi}{a}\right)^2 + \left(\frac{n\pi}{b}\right)^2, \quad Y_{m,n} = \sin\left(\frac{n\pi y}{b}\right)$$

Finally we determine  $T$ .

$$T_{m,n} = \frac{\cos}{\sin} \left( c\pi \sqrt{\left(\frac{m}{a}\right)^2 + \left(\frac{n}{b}\right)^2} t \right)$$

The modes of oscillation are

$$u_{m,n} = \sin\left(\frac{m\pi x}{a}\right) \sin\left(\frac{n\pi y}{b}\right) \frac{\cos}{\sin} \left( c\pi \sqrt{\left(\frac{m}{a}\right)^2 + \left(\frac{n}{b}\right)^2} t \right).$$

The frequencies are

$$\omega_{m,n} = c\pi \sqrt{\left(\frac{m}{a}\right)^2 + \left(\frac{n}{b}\right)^2}.$$

Figure 37.4 shows a few of the modes of oscillation in surface and density plots.

### Solution 37.31

We substitute the separation of variables  $\phi = X(x)Y(y)T(t)$  into the differential equation.

$$\begin{aligned} \phi_t &= a^2(\phi_{xx} + \phi_{yy}) & (37.13) \\ XYT' &= a^2(X''YT + XY''T) \\ \frac{T'}{a^2T} &= \frac{X''}{X} + \frac{Y''}{Y} = -\nu \\ \frac{T'}{a^2T} &= -\nu, \quad \frac{X''}{X} = -\nu - \frac{Y''}{Y} = -\mu \end{aligned}$$

First we solve the eigenvalue problem for  $X$ .

$$X'' + \mu X = 0, \quad X(0) = X(l_x) = 0$$

$$\mu_m = \left(\frac{m\pi}{l_x}\right)^2, \quad X_m(x) = \sin\left(\frac{m\pi x}{l_x}\right), \quad m \in \mathbb{Z}^+$$

Then we solve the eigenvalue problem for  $Y$ .

$$Y'' + (\nu - \mu_m)Y = 0, \quad Y'(0) = Y'(l_y) = 0$$

$$\nu_{mn} = \mu_m + \left(\frac{n\pi}{l_y}\right)^2, \quad Y_{mn}(y) = \cos\left(\frac{n\pi y}{l_y}\right), \quad n \in \mathbb{Z}^{0+}$$

Next we solve the differential equation for  $T$ , (up to a multiplicative constant).

$$T' = -a^2 \nu_{mn} T$$

$$T(t) = \exp(-a^2 \nu_{mn} t)$$

The eigensolutions of Equation 37.13 are

$$\sin(\mu_m x) \cos(\nu_{mn} y) \exp(-a^2 \nu_{mn} t), \quad m \in \mathbb{Z}^+, \quad n \in \mathbb{Z}^{0+}.$$

We choose the eigensolutions  $\phi_{mn}$  to be orthonormal on the  $xy$  domain at  $t = 0$ .

$$\phi_{m0}(x, y, t) = \sqrt{\frac{2}{l_x l_y}} \sin(\mu_m x) \exp(-a^2 \nu_{mn} t), \quad m \in \mathbb{Z}^+$$

$$\phi_{mn}(x, y, t) = \frac{2}{\sqrt{l_x l_y}} \sin(\mu_m x) \cos(\nu_{mn} y) \exp(-a^2 \nu_{mn} t), \quad m \in \mathbb{Z}^+, \quad n \in \mathbb{Z}^+$$

The solution of Equation 37.13 is a linear combination of the eigensolutions.

$$\phi(x, y, t) = \sum_{\substack{m=1 \\ n=0}}^{\infty} c_{mn} \phi_{mn}(x, y, t)$$

We determine the coefficients from the initial condition.

$$\phi(x, y, 0) = 1$$

$$\sum_{\substack{m=1 \\ n=0}}^{\infty} c_{mn} \phi_{mn}(x, y, 0) = 1$$

$$c_{mn} = \int_0^{l_x} \int_0^{l_y} \phi_{mn}(x, y, 0) \, dy \, dx$$

$$c_{m0} = \sqrt{\frac{2}{l_x l_y}} \int_0^{l_x} \int_0^{l_y} \sin(\mu_m x) \, dy \, dx$$

$$c_{m0} = \sqrt{2l_x l_y} \frac{1 - (-1)^m}{m\pi}, \quad m \in \mathbb{Z}^+$$

$$c_{mn} = \frac{2}{\sqrt{l_x l_y}} \int_0^{l_x} \int_0^{l_y} \sin(\mu_m x) \cos(\nu_{mn} y) \, dy \, dx$$

$$c_{mn} = 0, \quad m \in \mathbb{Z}^+, \quad n \in \mathbb{Z}^+$$

$$\phi(x, y, t) = \sum_{m=1}^{\infty} c_{m0} \phi_{m0}(x, y, t)$$

$$\phi(x, y, t) = \sum_{\substack{m=1 \\ \text{odd } m}}^{\infty} \frac{2\sqrt{2l_x l_y}}{m\pi} \sin(\mu_m x) \exp(-a^2 \nu_{mn} t)$$

**Addendum.** Note that an equivalent problem to the one specified is

$$\phi_t = a^2 (\phi_{xx} + \phi_{yy}), \quad 0 < x < l_x, \quad -\infty < y < \infty,$$

$$\phi(x, y, 0) = 1, \quad \phi(0, y, t) = \phi(l_y, y, t) = 0.$$

Here we have done an even periodic continuation of the problem in the  $y$  variable. Thus the boundary conditions

$$\phi_y(x, 0, t) = \phi_y(x, l_y, t) = 0$$

are automatically satisfied. Note that this problem does not depend on  $y$ . Thus we only had to solve

$$\begin{aligned}\phi_t &= a^2 \phi_{xx}, & 0 < x < l_x \\ \phi(x, 0) &= 1, & \phi(0, t) = \phi(l_y, t) = 0.\end{aligned}$$

### Solution 37.32

1. Since the initial and boundary conditions do not depend on  $\theta$ , neither does  $\phi$ . We apply the separation of variables  $\phi = u(r)T(t)$ .

$$\phi_t = a^2 \Delta \phi \tag{37.14}$$

$$\phi_t = a^2 \frac{1}{r} (r\phi_r)_r \tag{37.15}$$

$$\frac{T'}{a^2 T} = \frac{1}{r} (ru')' = -\lambda \tag{37.16}$$

We solve the eigenvalue problem for  $u(r)$ .

$$(ru')' + \lambda u = 0, \quad u(0) \text{ bounded}, \quad u(R) = 0$$

First we write the general solution.

$$u(r) = c_1 J_0(\sqrt{\lambda}r) + c_2 Y_0(\sqrt{\lambda}r)$$

The Bessel function of the second kind,  $Y_0$ , is not bounded at  $r = 0$ , so  $c_2 = 0$ . We use the boundary condition at  $r = R$  to determine the eigenvalues.

$$\lambda_n = \left( \frac{j_{0,n}}{R} \right)^2, \quad u_n(r) = c J_0 \left( \frac{j_{0,n} r}{R} \right)$$

We choose the constant  $c$  so that the eigenfunctions are orthonormal with respect to the weighting function  $r$ .

$$\begin{aligned} u_n(r) &= \frac{J_0\left(\frac{j_{0,n}r}{R}\right)}{\sqrt{\int_0^R r J_0^2\left(\frac{j_{0,n}r}{R}\right)}} \\ &= \frac{\sqrt{2}}{RJ_1(j_{0,n})} J_0\left(\frac{j_{0,n}r}{R}\right) \end{aligned}$$

Now we solve the differential equation for  $T$ .

$$\begin{aligned} T' &= -a^2 \lambda_n T \\ T_n &= \exp\left(-\left(\frac{aj_{0,n}}{R^2}\right)^2 t\right) \end{aligned}$$

The eigensolutions of Equation 37.14 are

$$\phi_n(r, t) = \frac{\sqrt{2}}{RJ_1(j_{0,n})} J_0\left(\frac{j_{0,n}r}{R}\right) \exp\left(-\left(\frac{aj_{0,n}}{R^2}\right)^2 t\right)$$

The solution is a linear combination of the eigensolutions.

$$\phi = \sum_{n=1}^{\infty} c_n \frac{\sqrt{2}}{RJ_1(j_{0,n})} J_0\left(\frac{j_{0,n}r}{R}\right) \exp\left(-\left(\frac{aj_{0,n}}{R^2}\right)^2 t\right)$$



We determine the coefficients from the initial condition.

$$\begin{aligned}\phi(r, \theta, 0) &= V \\ \sum_{n=1}^{\infty} c_n \frac{\sqrt{2}}{R J_1(j_{0,n})} J_0\left(\frac{j_{0,n} r}{R}\right) &= V \\ c_n &= \int_0^R V r \frac{\sqrt{2}}{R J_1(j_{0,n})} J_0\left(\frac{j_{0,n} r}{R}\right) dr \\ c_n &= V \frac{\sqrt{2}}{R J_1(j_{0,n})} \frac{R}{j_{0,n}/R} J_1(j_{0,n}) \\ c_n &= \frac{\sqrt{2} V R}{j_{0,n}}\end{aligned}$$

$$\phi(r, \theta, t) = 2V \sum_{n=1}^{\infty} \frac{J_0\left(\frac{j_{0,n} r}{R}\right)}{j_{0,n} J_1(j_{0,n})} \exp\left(-\left(\frac{a j_{0,n}}{R^2}\right)^2 t\right)$$

2.

$$\begin{aligned}J_\nu(r) &\sim \sqrt{\frac{2}{\pi r}} \cos\left(r - \frac{\pi \nu}{2} - \frac{\pi}{4}\right), \quad r \rightarrow +\infty \\ j_{\nu,n} &\sim \left(n + \frac{\nu}{2} - \frac{1}{4}\right) \pi\end{aligned}$$

For large  $n$ , the terms in the series solution at  $t = 0$  are

$$\begin{aligned}\frac{J_0\left(\frac{j_{0,n} r}{R}\right)}{j_{0,n} J_1(j_{0,n})} &\sim \frac{\sqrt{\frac{2R}{\pi j_{0,n} r}} \cos\left(\frac{j_{0,n} r}{R} - \frac{\pi}{4}\right)}{j_{0,n} \sqrt{\frac{2}{\pi j_{0,n}}} \cos\left(j_{0,n} - \frac{3\pi}{4}\right)} \\ &\sim \frac{R}{r(n - 1/4)\pi} \frac{\cos\left(\frac{(n-1/4)\pi r}{R} - \frac{\pi}{4}\right)}{\cos((n-1)\pi)}.\end{aligned}$$

The coefficients decay as  $1/n$ .

### Solution 37.33

1. We substitute the separation of variables  $\Psi = T(t)\Theta(\theta)\Phi(\phi)$  into Equation 37.7

$$\begin{aligned} T'\Theta\Phi &= \frac{a^2}{R^2} \left( \frac{1}{\sin\theta} \frac{\partial}{\partial\theta} (\sin\theta T\Theta'\Phi) + \frac{1}{\sin^2\theta} T\Theta\Phi'' \right) \\ \frac{R^2 T'}{a^2 T} &= \left( \frac{1}{\sin\theta} (\sin\theta \Theta')' + \frac{1}{\sin^2\theta} \frac{\Phi''}{\Phi} \right) = -\mu \\ \frac{\sin\theta}{\Theta} (\sin\theta \Theta')' + \mu \sin^2\theta &= -\frac{\Phi''}{\Phi} = \nu \end{aligned}$$

We have differential equations for each of  $T$ ,  $\Theta$  and  $\Phi$ .

$$T' = -\mu \frac{a^2}{R^2} T, \quad \frac{1}{\sin\theta} (\sin\theta \Theta')' + \left( \mu - \frac{\nu}{\sin^2\theta} \right) \Theta = 0, \quad \Phi'' + \nu\Phi = 0$$

2. In order that the solution be continuously differentiable, we need the periodic boundary conditions

$$\Phi(0) = \Phi(2\pi), \quad \Phi'(0) = \Phi'(2\pi).$$

The eigenvalues and eigenfunctions for  $\Phi$  are

$$\nu_n = n^2, \quad \Phi_n = \frac{1}{\sqrt{2\pi}} e^{in\phi}, \quad n \in \mathbb{Z}.$$

Now we deal with the equation for  $\Theta$ .

$$\begin{aligned} x = \cos\theta, \quad \Theta(\theta) = P(x), \quad \sin^2\theta = 1 - x^2, \quad \frac{d}{dx} &= \frac{1}{\sin\theta} \frac{d}{d\theta} \\ \frac{1}{\sin\theta} (\sin^2\theta \frac{1}{\sin\theta} \Theta')' + \left( \mu - \frac{\nu}{\sin^2\theta} \right) \Theta &= 0 \\ ((1 - x^2) P')' + \left( \mu - \frac{n^2}{1 - x^2} \right) P &= 0 \end{aligned}$$

$P(x)$  should be bounded at the endpoints,  $x = -1$  and  $x = 1$ .

3. If the solution does not depend on  $\theta$ , then the only one of the  $\Phi_n$  that will appear in the solution is  $\Phi_0 = 1/\sqrt{2\pi}$ . The equations for  $T$  and  $P$  become

$$\begin{aligned}((1-x^2)P')' + \mu P &= 0, & P(\pm 1) \text{ bounded,} \\ T' &= -\mu \frac{a^2}{R^2} T.\end{aligned}$$

The solutions for  $P$  are the Legendre polynomials.

$$\mu_l = l(l+1), \quad P_l(\cos \theta), \quad l \in \mathbb{Z}^{0+}$$

We solve the differential equation for  $T$ .

$$\begin{aligned}T' &= -l(l+1) \frac{a^2}{R^2} T \\ T_l &= \exp\left(-\frac{a^2 l(l+1)}{R^2} t\right)\end{aligned}$$

The eigensolutions of the partial differential equation are

$$\Psi_l = P_l(\cos \theta) \exp\left(-\frac{a^2 l(l+1)}{R^2} t\right).$$

The solution is a linear combination of the eigensolutions.

$$\Psi = \sum_{l=0}^{\infty} A_l P_l(\cos \theta) \exp\left(-\frac{a^2 l(l+1)}{R^2} t\right)$$

4. We determine the coefficients in the expansion from the initial condition.

$$\Psi(\theta, 0) = 2 \cos^2 \theta - 1$$

$$\sum_{l=0}^{\infty} A_l P_l(\cos \theta) = 2 \cos^2 \theta - 1$$

$$A_0 + A_1 \cos \theta + A_2 \left( \frac{3}{2} \cos^2 \theta - \frac{1}{2} \right) + \cdots = 2 \cos^2 \theta - 1$$

$$A_0 = -\frac{1}{3}, \quad A_1 = 0, \quad A_2 = \frac{4}{3}, \quad A_3 = A_4 = \cdots = 0$$

$$\Psi(\theta, t) = -\frac{1}{3} P_0(\cos \theta) + \frac{4}{3} P_2(\cos \theta) \exp\left(-\frac{6a^2}{R^2} t\right)$$

$$\boxed{\Psi(\theta, t) = -\frac{1}{3} + \left(2 \cos^2 \theta - \frac{2}{3}\right) \exp\left(-\frac{6a^2}{R^2} t\right)}$$

### Solution 37.34

Since we have homogeneous boundary conditions at  $x = 0$  and  $x = 1$ , we will expand the solution in a series of eigenfunctions in  $x$ . We determine a suitable set of eigenfunctions with the separation of variables,  $\phi = X(x)Y(y)$ .

$$\begin{aligned} \phi_{xx} + \phi_{yy} &= 0 & (37.17) \\ \frac{X''}{X} &= -\frac{Y''}{Y} = -\lambda \end{aligned}$$

We have differential equations for  $X$  and  $Y$ .

$$\begin{aligned} X'' + \lambda X &= 0, & X(0) = X(1) &= 0 \\ Y'' - \lambda Y &= 0, & Y(0) &= 0 \end{aligned}$$

The eigenvalues and orthonormal eigenfunctions for  $X$  are

$$\lambda_n = (n\pi)^2, \quad X_n(x) = \sqrt{2} \sin(n\pi x), \quad n \in \mathbb{Z}^+.$$

The solutions for  $Y$  are, (up to a multiplicative constant),

$$Y_n(y) = \sinh(n\pi y).$$

The solution of Equation 37.17 is a linear combination of the eigensolutions.

$$\phi(x, y) = \sum_{n=1}^{\infty} a_n \sqrt{2} \sin(n\pi x) \sinh(n\pi y)$$

We determine the coefficients from the boundary condition at  $y = 2$ .

$$\begin{aligned} x(1-x) &= \sum_{n=1}^{\infty} a_n \sqrt{2} \sin(n\pi x) \sinh(n\pi 2) \\ a_n \sinh(2n\pi) &= \sqrt{2} \int_0^1 x(1-x) \sin(n\pi x) dx \\ a_n &= \frac{2\sqrt{2}(1-(-1)^n)}{n^3 \pi^3 \sinh(2n\pi)} \end{aligned}$$

$$\phi(x, y) = \frac{8}{\pi^3} \sum_{\substack{n=1 \\ \text{odd } n}}^{\infty} \frac{1}{n^3} \sin(n\pi x) \frac{\sinh(n\pi y)}{\sinh(2n\pi)}$$

The solution at  $x = 1/2$ ,  $y = 1$  is

$$\phi(1/2, 1) = -\frac{8}{\pi^3} \sum_{\substack{n=1 \\ \text{odd } n}}^{\infty} \frac{1}{n^3} \frac{\sinh(n\pi)}{\sinh(2n\pi)}.$$

Let  $R_k$  be the relative error at that point incurred by taking  $k$  terms.

$$R_k = \left| \frac{-\frac{8}{\pi^3} \sum_{\substack{n=k+2 \\ \text{odd } n}}^{\infty} \frac{1}{n^3} \frac{\sinh(n\pi)}{\sinh(2n\pi)}}{-\frac{8}{\pi^3} \sum_{\substack{n=1 \\ \text{odd } n}}^{\infty} \frac{1}{n^3} \frac{\sinh(n\pi)}{\sinh(2n\pi)}} \right|$$

$$R_k = \frac{\sum_{\substack{n=k+2 \\ \text{odd } n}}^{\infty} \frac{1}{n^3} \frac{\sinh(n\pi)}{\sinh(2n\pi)}}{\sum_{\substack{n=1 \\ \text{odd } n}}^{\infty} \frac{1}{n^3} \frac{\sinh(n\pi)}{\sinh(2n\pi)}}$$

Since  $R_1 \approx 0.0000693169$  we see that one term is sufficient for 1% or 0.1% accuracy.

Now consider  $\phi_x(1/2, 1)$ .

$$\phi_x(x, y) = \frac{8}{\pi^2} \sum_{\substack{n=1 \\ \text{odd } n}}^{\infty} \frac{1}{n^2} \cos(n\pi x) \frac{\sinh(n\pi y)}{\sinh(2n\pi)}$$

$$\phi_x(1/2, 1) = 0$$

Since all the terms in the series are zero, accuracy is not an issue.

### Solution 37.35

The solution has the form

$$\psi = \begin{cases} \alpha r^{-n-1} P_n^m(\cos \theta) \sin(m\phi), & r > a \\ \beta r^n P_n^m(\cos \theta) \sin(m\phi), & r < a. \end{cases}$$

The boundary condition on  $\psi$  at  $r = a$  gives us the constraint

$$\alpha a^{-n-1} - \beta a^n = 0$$

$$\beta = \alpha a^{-2n-1}.$$

Then we apply the boundary condition on  $\psi_r$  at  $r = a$ .

$$-(n+1)\alpha a^{-n-2} - n\alpha a^{-2n-1}a^{n-1} = 1$$

$$\alpha = -\frac{a^{n+2}}{2n+1}$$

$$\psi = \begin{cases} -\frac{a^{n+2}}{2n+1}r^{-n-1}P_n^m(\cos\theta)\sin(m\phi), & r > a \\ -\frac{a^{-n+1}}{2n+1}r^n P_n^m(\cos\theta)\sin(m\phi), & r < a \end{cases}$$

### Solution 37.36

We expand the solution in a Fourier series.

$$\phi = \frac{1}{2}a_0(r) + \sum_{n=1}^{\infty} a_n(r) \cos(n\theta) + \sum_{n=1}^{\infty} b_n(r) \sin(n\theta)$$

We substitute the series into the Laplace's equation to determine ordinary differential equations for the coefficients.

$$\frac{\partial}{\partial r} \left( r \frac{\partial \phi}{\partial r} \right) + \frac{1}{r^2} \frac{\partial^2 \phi}{\partial \theta^2} = 0$$

$$a_0'' + \frac{1}{r}a_0' = 0, \quad a_n'' + \frac{1}{r}a_n' - n^2 a_n = 0, \quad b_n'' + \frac{1}{r}b_n' - n^2 b_n = 0$$

The solutions that are bounded at  $r = 0$  are, (to within multiplicative constants),

$$a_0(r) = 1, \quad a_n(r) = r^n, \quad b_n(r) = r^n.$$

Thus  $\phi(r, \theta)$  has the form

$$\phi(r, \theta) = \frac{1}{2}c_0 + \sum_{n=1}^{\infty} c_n r^n \cos(n\theta) + \sum_{n=1}^{\infty} d_n r^n \sin(n\theta)$$

We apply the boundary condition at  $r = R$ .

$$\phi_r(R, \theta) = \sum_{n=1}^{\infty} n c_n R^{n-1} \cos(n\theta) + \sum_{n=1}^{\infty} n d_n R^{n-1} \sin(n\theta)$$

In order that  $\phi_r(R, \theta)$  have a Fourier series of this form, it is necessary that

$$\int_0^{2\pi} \phi_r(R, \theta) d\theta = 0.$$

In that case  $c_0$  is arbitrary in our solution. The coefficients are

$$c_n = \frac{1}{\pi n R^{n-1}} \int_0^{2\pi} \phi_r(R, \alpha) \cos(n\alpha) d\alpha, \quad d_n = \frac{1}{\pi n R^{n-1}} \int_0^{2\pi} \phi_r(R, \alpha) \sin(n\alpha) d\alpha.$$

We substitute the coefficients into our series solution to determine it up to the additive constant.

$$\phi(r, \theta) = \frac{R}{\pi} \sum_{n=1}^{\infty} \frac{1}{n} \left(\frac{r}{R}\right)^n \int_0^{2\pi} \phi_r(R, \alpha) \cos(n(\theta - \alpha)) d\alpha$$

$$\phi(r, \theta) = \frac{R}{\pi} \int_0^{2\pi} \phi_r(R, \alpha) \sum_{n=1}^{\infty} \frac{1}{n} \left(\frac{r}{R}\right)^n \cos(n(\theta - \alpha)) d\alpha$$

$$\phi(r, \theta) = \frac{R}{\pi} \int_0^{2\pi} \phi_r(R, \alpha) \sum_{n=1}^{\infty} \int_0^r \frac{\rho^{n-1}}{R^n} d\rho \Re(e^{in(\theta-\alpha)}) d\alpha$$

$$\phi(r, \theta) = \frac{R}{\pi} \int_0^{2\pi} \phi_r(R, \alpha) \Re \left( \int_0^r \frac{1}{\rho} \sum_{n=1}^{\infty} \frac{\rho^n}{R^n} e^{in(\theta-\alpha)} d\rho \right) d\alpha$$

$$\phi(r, \theta) = \frac{R}{\pi} \int_0^{2\pi} \phi_r(R, \alpha) \Re \left( \int_0^r \frac{1}{\rho} \frac{\rho e^{i(\theta-\alpha)}}{1 - \frac{\rho}{R} e^{i(\theta-\alpha)}} d\rho \right) d\alpha$$

$$\phi(r, \theta) = -\frac{R}{\pi} \int_0^{2\pi} \phi_r(R, \alpha) \Re \left( \ln \left( 1 - \frac{r}{R} e^{i(\theta-\alpha)} \right) \right) d\alpha$$

$$\phi(r, \theta) = -\frac{R}{\pi} \int_0^{2\pi} \phi_r(R, \alpha) \ln \left| 1 - \frac{r}{R} e^{i(\theta-\alpha)} \right| d\alpha$$

$$\phi(r, \theta) = -\frac{R}{2\pi} \int_0^{2\pi} \phi_r(R, \alpha) \ln \left( 1 - 2\frac{r}{R} \cos(\theta - \alpha) + \frac{r^2}{R^2} \right) d\alpha$$



**Solution 37.37**

We will assume that both  $\alpha$  and  $\beta$  are nonzero. The cases of real and pure imaginary have already been covered. We solve the ordinary differential equations, (up to a multiplicative constant), to find special solutions of the diffusion equation.

$$\begin{aligned}\frac{T'}{T} &= (\alpha + i\beta)^2, & \frac{X''}{X} &= \frac{(\alpha + i\beta)^2}{a^2} \\ T &= \exp((\alpha + i\beta)^2 t), & X &= \exp\left(\pm \frac{\alpha + i\beta}{a} x\right) \\ T &= \exp((\alpha^2 - \beta^2)t + i2\alpha\beta t), & X &= \exp\left(\pm \frac{\alpha}{a} x \pm i \frac{\beta}{a} x\right) \\ \phi &= \exp\left((\alpha^2 - \beta^2)t \pm \frac{\alpha}{a} x + i\left(2\alpha\beta t \pm \frac{\beta}{a} x\right)\right)\end{aligned}$$

We take the sum and difference of these solutions to obtain

$$\phi = \exp\left((\alpha^2 - \beta^2)t \pm \frac{\alpha}{a} x\right) \begin{matrix} \cos \\ \sin \end{matrix} \left(2\alpha\beta t \pm \frac{\beta}{a} x\right)$$

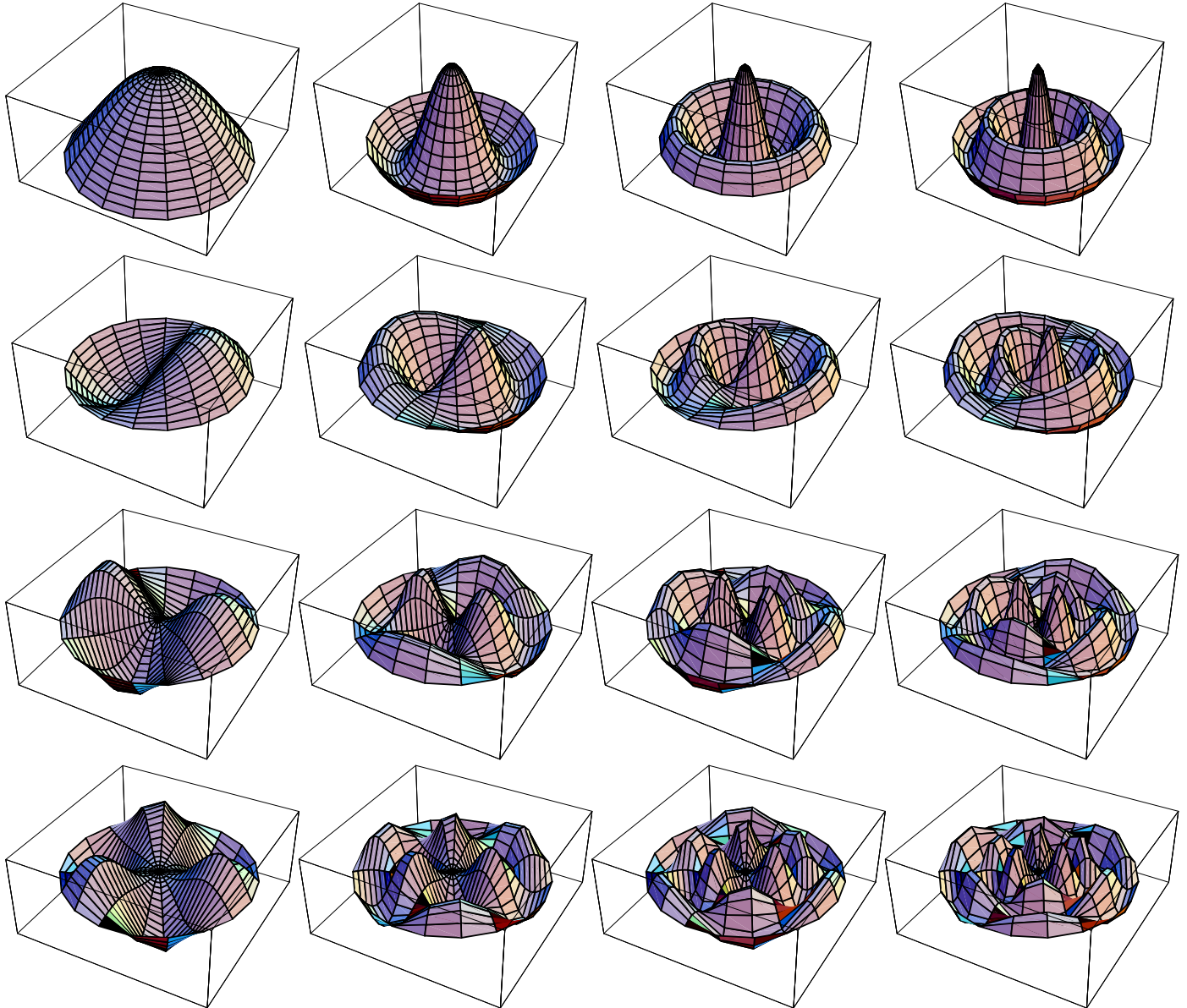

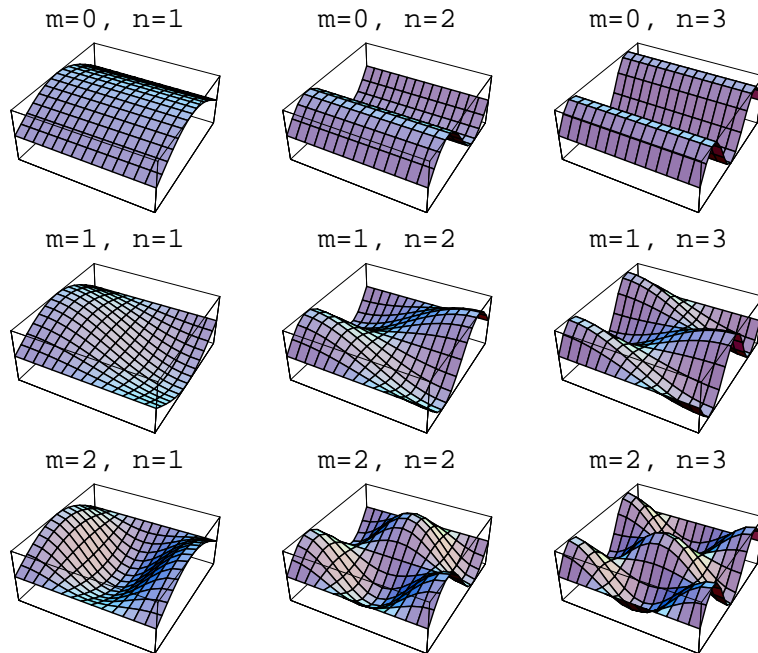

Figure 37.3: The eigenfunctions  $\cos\left(\frac{m\pi x}{a}\right) \sin\left(\frac{n\pi y}{b}\right)$

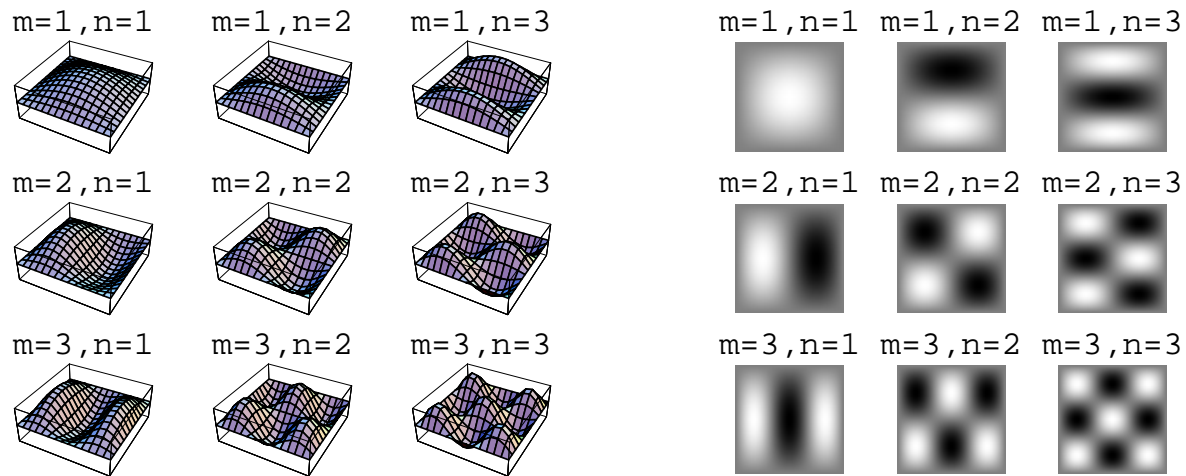

Figure 37.4: The modes of oscillation of a rectangular drum head.

# Chapter 38

## Finite Transforms

**Example 38.0.1** Consider the problem

$$\Delta u - \frac{1}{c^2} \frac{\partial^2 u}{\partial t^2} = \delta(x - \xi)\delta(y - \eta) e^{-\omega t} \quad \text{on } -\infty < x < \infty, 0 < y < b,$$

with

$$u_y(x, 0, t) = u_y(x, b, t) = 0.$$

Substituting  $u(x, y, t) = v(x, y) e^{-\omega t}$  into the partial differential equation yields the problem

$$\Delta v + k^2 v = \delta(x - \xi)\delta(y - \eta) \quad \text{on } -\infty < x < \infty, 0 < y < b,$$

with

$$v_y(x, 0) = v_y(x, b) = 0.$$

We assume that the solution has the form

$$v(x, y) = \frac{1}{2} c_0(x) + \sum_{n=1}^{\infty} c_n(x) \cos\left(\frac{n\pi y}{b}\right), \quad (38.1)$$

and apply a finite cosine transform in the  $y$  direction. Integrating from 0 to  $b$  yields

$$\int_0^b v_{xx} + v_{yy} + k^2 v \, dy = \int_0^b \delta(x - \xi) \delta(y - \eta) \, dy,$$

$$[v_y]_0^b + \int_0^b v_{xx} + k^2 v \, dy = \delta(x - \xi),$$

$$\int_0^b v_{xx} + k^2 v \, dy = \delta(x - \xi).$$

Substituting in Equation 38.1 and using the orthogonality of the cosines gives us

$$\boxed{c_0''(x) + k^2 c_0(x) = \frac{2}{b} \delta(x - \xi).}$$

Multiplying by  $\cos(n\pi y/b)$  and integrating from 0 to  $b$  yields

$$\int_0^b (v_{xx} + v_{yy} + k^2 v) \cos\left(\frac{n\pi y}{b}\right) \, dy = \int_0^b \delta(x - \xi) \delta(y - \eta) \cos\left(\frac{n\pi y}{b}\right) \, dy.$$

The  $v_{yy}$  term becomes

$$\begin{aligned} \int_0^b v_{yy} \cos\left(\frac{n\pi y}{b}\right) \, dy &= \left[ v_y \cos\left(\frac{n\pi y}{b}\right) \right]_0^b - \int_0^b -\frac{n\pi}{b} v_y \sin\left(\frac{n\pi y}{b}\right) \, dy \\ &= \left[ \frac{n\pi}{b} v \sin\left(\frac{n\pi y}{b}\right) \right]_0^b - \int_0^b \left(\frac{n\pi}{b}\right)^2 v \cos\left(\frac{n\pi y}{b}\right) \, dy. \end{aligned}$$

The right-hand-side becomes

$$\int_0^b \delta(x - \xi) \delta(y - \eta) \cos\left(\frac{n\pi y}{b}\right) \, dy = \delta(x - \xi) \cos\left(\frac{n\pi \eta}{b}\right).$$

Thus the partial differential equation becomes

$$\int_0^b \left( v_{xx} - \left( \frac{n\pi}{b} \right)^2 v + k^2 v \right) \cos \left( \frac{n\pi y}{b} \right) dy = \delta(x - \xi) \cos \left( \frac{n\pi \eta}{b} \right).$$

Substituting in Equation 38.1 and using the orthogonality of the cosines gives us

$$c_n''(x) + \left[ k^2 - \left( \frac{n\pi}{b} \right)^2 \right] c_n(x) = \frac{2}{b} \delta(x - \xi) \cos \left( \frac{n\pi \eta}{b} \right).$$

Now we need to solve for the coefficients in the expansion of  $v(x, y)$ . The homogeneous solutions for  $c_0(x)$  are  $e^{\pm ikx}$ . The solution for  $u(x, y, t)$  must satisfy the radiation condition. The waves at  $x = -\infty$  travel to the left and the waves at  $x = +\infty$  travel to the right. The two solutions of that will satisfy these conditions are, respectively,

$$y_1 = e^{-ikx}, \quad y_2 = e^{ikx}.$$

The Wronskian of these two solutions is  $i2k$ . Thus the solution for  $c_0(x)$  is

$$c_0(x) = \frac{e^{-ikx} < e^{ikx} >}{ibk}$$

We need to consider three cases for the equation for  $c_n$ .

$k > n\pi/b$  Let  $\alpha = \sqrt{k^2 - (n\pi/b)^2}$ . The homogeneous solutions that satisfy the radiation condition are

$$y_1 = e^{-i\alpha x}, \quad y_2 = e^{i\alpha x}.$$

The Wronskian of the two solutions is  $i2\alpha$ . Thus the solution is

$$c_n(x) = \frac{e^{-i\alpha x} < e^{i\alpha x} >}{ib\alpha} \cos \left( \frac{n\pi \eta}{b} \right).$$

In the case that  $\cos \left( \frac{n\pi \eta}{b} \right) = 0$  this reduces to the trivial solution.

$k = n\pi/b$  The homogeneous solutions that are bounded at infinity are

$$y_1 = 1, \quad y_2 = 1.$$

If the right-hand-side is nonzero there is no way to combine these solutions to satisfy both the continuity and the derivative jump conditions. Thus if  $\cos\left(\frac{n\pi\eta}{b}\right) \neq 0$  there is no bounded solution. If  $\cos\left(\frac{n\pi\eta}{b}\right) = 0$  then the solution is not unique.

$$c_n(x) = \text{const.}$$

$k < n\pi/b$  Let  $\beta = \sqrt{(n\pi/b)^2 - k^2}$ . The homogeneous solutions that are bounded at infinity are

$$y_1 = e^{\beta x}, \quad y_2 = e^{-\beta x}.$$

The Wronskian of these solutions is  $-2\beta$ . Thus the solution is

$$c_n(x) = -\frac{e^{\beta x} < e^{-\beta x} >}{b\beta} \cos\left(\frac{n\pi\eta}{b}\right)$$

In the case that  $\cos\left(\frac{n\pi\eta}{b}\right) = 0$  this reduces to the trivial solution.



## 38.1 Exercises

### Exercise 38.1

A slab is perfectly insulated at the surface  $x = 0$  and has a specified time varying temperature  $f(t)$  at the surface  $x = L$ . Initially the temperature is zero. Find the temperature  $u(x, t)$  if the heat conductivity in the slab is  $\kappa = 1$ .

### Exercise 38.2

Solve

$$\begin{aligned}u_{xx} + u_{yy} &= 0, & 0 < x < L, & \quad y > 0, \\u(x, 0) &= f(x), & u(0, y) &= g(y), & \quad u(L, y) = h(y),\end{aligned}$$

with an eigenfunction expansion.

## 38.2 Hints

Hint 38.1

Hint 38.2

## 38.3 Solutions

### Solution 38.1

The problem is

$$\begin{aligned}u_t &= u_{xx}, & 0 < x < L, t > 0, \\u_x(0, t) &= 0, & u(L, t) = f(t), & u(x, 0) = 0.\end{aligned}$$

We will solve this problem with an eigenfunction expansion. We find these eigenfunction by replacing the inhomogeneous boundary condition with the homogeneous one,  $u(L, t) = 0$ . We substitute the separation of variables  $v(x, t) = X(x)T(t)$  into the homogeneous partial differential equation.

$$\begin{aligned}XT' &= X''T \\ \frac{T'}{T} &= \frac{X''}{X} = -\lambda^2.\end{aligned}$$

This gives us the regular Sturm-Liouville eigenvalue problem,

$$X'' = -\lambda^2 X, \quad X'(0) = X(L) = 0,$$

which has the solutions,

$$\lambda_n = \frac{\pi(2n-1)}{2L}, \quad X_n = \cos\left(\frac{\pi(2n-1)x}{2L}\right), \quad n \in \mathbb{N}.$$

Our solution for  $u(x, t)$  will be an eigenfunction expansion in these eigenfunctions. Since the inhomogeneous boundary condition is a function of  $t$ , the coefficients will be functions of  $t$ .

$$u(x, t) = \sum_{n=1}^{\infty} a_n(t) \cos(\lambda_n x)$$

Since  $u(x, t)$  does not satisfy the homogeneous boundary conditions of the eigenfunctions, the series is not uniformly convergent and we are not allowed to differentiate it with respect to  $x$ . We substitute the expansion into the partial

differential equation, multiply by the eigenfunction and integrate from  $x = 0$  to  $x = L$ . We use integration by parts to move derivatives from  $u$  to the eigenfunctions.

$$\begin{aligned}
 u_t &= u_{xx} \\
 \int_0^L u_t \cos(\lambda_m x) dx &= \int_0^L u_{xx} \cos(\lambda_m x) dx \\
 \int_0^L \left( \sum_{n=1}^{\infty} a'_n(t) \cos(\lambda_n x) \right) \cos(\lambda_m x) dx &= [u_x \cos(\lambda_m x)]_0^L + \int_0^L u_x \lambda_m \sin(\lambda_m x) dx \\
 \frac{L}{2} a'_m(t) &= [u \lambda_m \sin(\lambda_m x)]_0^L - \int_0^L u \lambda_m^2 \cos(\lambda_m x) dx \\
 \frac{L}{2} a'_m(t) &= \lambda_m u(L, t) \sin(\lambda_m L) - \lambda_m^2 \int_0^L \left( \sum_{n=1}^{\infty} a_n(t) \cos(\lambda_n x) \right) \cos(\lambda_m x) dx \\
 \frac{L}{2} a'_m(t) &= \lambda_m (-1)^n f(t) - \lambda_m^2 \frac{L}{2} a_m(t) \\
 a'_m(t) + \lambda_m^2 a_m(t) &= (-1)^n \lambda_m f(t)
 \end{aligned}$$

From the initial condition  $u(x, 0) = 0$  we see that  $a_m(0) = 0$ . Thus we have a first order differential equation and an initial condition for each of the  $a_m(t)$ .

$$a'_m(t) + \lambda_m^2 a_m(t) = (-1)^n \lambda_m f(t), \quad a_m(0) = 0$$

This equation has the solution,

$$a_m(t) = (-1)^n \lambda_m \int_0^t e^{-\lambda_m^2(t-\tau)} f(\tau) d\tau.$$

## Solution 38.2

$$\begin{aligned}
 u_{xx} + u_{yy} &= 0, \quad 0 < x < L, \quad y > 0, \\
 u(x, 0) &= f(x), \quad u(0, y) = g(y), \quad u(L, y) = h(y),
 \end{aligned}$$

We seek a solution of the form,

$$u(x, y) = \sum_{n=1}^{\infty} u_n(y) \sin\left(\frac{n\pi x}{L}\right).$$

Since we have inhomogeneous boundary conditions at  $x = 0, L$ , we cannot differentiate the series representation with respect to  $x$ . We multiply Laplace's equation by the eigenfunction and integrate from  $x = 0$  to  $x = L$ .

$$\int_0^L (u_{xx} + u_{yy}) \sin\left(\frac{m\pi x}{L}\right) dx = 0$$

We use integration by parts to move derivatives from  $u$  to the eigenfunctions.

$$\begin{aligned} \left[ u_x \sin\left(\frac{m\pi x}{L}\right) \right]_0^L - \frac{m\pi}{L} \int_0^L u_x \cos\left(\frac{m\pi x}{L}\right) dx + \frac{L}{2} u_m''(y) &= 0 \\ \left[ -\frac{m\pi}{L} u \cos\left(\frac{m\pi x}{L}\right) \right]_0^L - \left(\frac{m\pi}{L}\right)^2 \int_0^L u \sin\left(\frac{m\pi x}{L}\right) dx + \frac{L}{2} u_m''(y) &= 0 \\ -\frac{m\pi}{L} h(y)(-1)^m + \frac{m\pi}{L} g(y) - \frac{L}{2} \left(\frac{m\pi}{L}\right)^2 u_m(y) + \frac{L}{2} u_m''(y) &= 0 \\ u_m''(y) - \left(\frac{m\pi}{L}\right)^2 u_m(y) &= 2m\pi ((-1)^m h(y) - g(y)) \end{aligned}$$

Now we have an ordinary differential equation for the  $u_n(y)$ . In order that the solution is bounded, we require that each  $u_n(y)$  is bounded as  $y \rightarrow \infty$ . We use the boundary condition  $u(x, 0) = f(x)$  to determine boundary conditions for the  $u_m(y)$  at  $y = 0$ .

$$\begin{aligned} u(x, 0) &= \sum_{n=1}^{\infty} u_n(0) \sin\left(\frac{n\pi x}{L}\right) = f(x) \\ u_n(0) = f_n &\equiv \frac{2}{L} \int_0^L f(x) \sin\left(\frac{n\pi x}{L}\right) dx \end{aligned}$$

Thus we have the problems,

$$u_n''(y) - \left(\frac{n\pi}{L}\right)^2 u_n(y) = 2n\pi ((-1)^n h(y) - g(y)), \quad u_n(0) = f_n, \quad u_n(+\infty) \text{ bounded,}$$

for the coefficients in the expansion. We will solve these with Green functions. Consider the associated Green function problem

$$G_n''(y; \eta) - \left(\frac{n\pi}{L}\right)^2 G_n(y; \eta) = \delta(y - \eta), \quad G_n(0; \eta) = 0, \quad G_n(+\infty; \eta) \text{ bounded.}$$

The homogeneous solutions that satisfy the boundary conditions are

$$\sinh\left(\frac{n\pi y}{L}\right) \quad \text{and} \quad e^{-n\pi y/L},$$

respectively. The Wronskian of these solutions is

$$\begin{vmatrix} \sinh\left(\frac{n\pi y}{L}\right) & e^{-n\pi y/L} \\ \frac{n\pi}{L} \sinh\left(\frac{n\pi y}{L}\right) & -\frac{n\pi}{L} e^{-n\pi y/L} \end{vmatrix} = -\frac{n\pi}{L} e^{-2n\pi y/L}.$$

Thus the Green function is

$$G_n(y; \eta) = -\frac{L \sinh\left(\frac{n\pi y_{<}}{L}\right) e^{-n\pi y_{>}/L}}{n\pi e^{-2n\pi \eta/L}}.$$

Using the Green function we determine the  $u_n(y)$  and thus the solution of Laplace's equation.

$$u_n(y) = f_n e^{-n\pi y/L} + 2n\pi \int_0^{\infty} G_n(y; \eta) ((-1)^n h(\eta) - g(\eta)) d\eta$$

$$u(x, y) = \sum_{n=1}^{\infty} u_n(y) \sin\left(\frac{n\pi x}{L}\right).$$

# Chapter 39

## The Diffusion Equation

## 39.1 Exercises

### Exercise 39.1

Is the solution of the Cauchy problem for the heat equation unique?

$$\begin{aligned}u_t - \kappa u_{xx} &= q(x, t), & -\infty < x < \infty, & \quad t > 0 \\u(x, 0) &= f(x)\end{aligned}$$

### Exercise 39.2

Consider the heat equation with a time-independent source term and inhomogeneous boundary conditions.

$$\begin{aligned}u_t &= \kappa u_{xx} + q(x) \\u(0, t) &= a, \quad u(h, t) = b, \quad u(x, 0) = f(x)\end{aligned}$$

### Exercise 39.3

Is the Cauchy problem for the backward heat equation

$$u_t + \kappa u_{xx} = 0, \quad u(x, 0) = f(x) \tag{39.1}$$

well posed?

### Exercise 39.4

Derive the heat equation for a general 3 dimensional body, with non-uniform density  $\rho(\mathbf{x})$ , specific heat  $c(\mathbf{x})$ , and conductivity  $k(\mathbf{x})$ . Show that

$$\frac{\partial u(\mathbf{x}, t)}{\partial t} = \frac{1}{c\rho} \nabla \cdot (k \nabla u(\mathbf{x}, t))$$

where  $u$  is the temperature, and you may assume there are no internal sources or sinks.

### Exercise 39.5

Verify Duhamel's Principal: If  $u(x, t, \tau)$  is the solution of the initial value problem:

$$u_t = \kappa u_{xx}, \quad u(x, 0, \tau) = f(x, \tau),$$



then the solution of

$$w_t = \kappa w_{xx} + f(x, t), \quad w(x, 0) = 0$$

is

$$w(x, t) = \int_0^t u(x, t - \tau, \tau) d\tau.$$

### Exercise 39.6

Modify the derivation of the diffusion equation

$$\phi_t = a^2 \phi_{xx}, \quad a^2 = \frac{k}{c\rho}, \quad (39.2)$$

so that it is valid for diffusion in a non-homogeneous medium for which  $c$  and  $k$  are functions of  $x$  and  $\phi$  and so that it is valid for a geometry in which  $A$  is a function of  $x$ . Show that Equation (39.2) above is in this case replaced by

$$c\rho A\phi_t = (kA\phi_x)_x.$$

Recall that  $c$  is the specific heat,  $k$  is the thermal conductivity,  $\rho$  is the density,  $\phi$  is the temperature and  $A$  is the cross-sectional area.

## 39.2 Hints

**Hint 39.1**

**Hint 39.2**

**Hint 39.3**

**Hint 39.4**

**Hint 39.5**

Check that the expression for  $w(x, t)$  satisfies the partial differential equation and initial condition. Recall that

$$\frac{\partial}{\partial x} \int_a^x h(x, \xi) \, d\xi = \int_a^x h_x(x, \xi) \, d\xi + h(x, x).$$

**Hint 39.6**

## 39.3 Solutions

### Solution 39.1

Let  $u$  and  $v$  both be solutions of the Cauchy problem for the heat equation. Let  $w$  be the difference of these solutions.  $w$  satisfies the problem

$$\begin{aligned}w_t - \kappa w_{xx} &= 0, & -\infty < x < \infty, & \quad t > 0, \\w(x, 0) &= 0.\end{aligned}$$

We can solve this problem with the Fourier transform.

$$\begin{aligned}\hat{w}_t + \kappa\omega^2\hat{w} &= 0, & \hat{w}(\omega, 0) &= 0 \\ \hat{w} &= 0 \\ w &= 0\end{aligned}$$

Since  $u - v = 0$ , we conclude that the solution of the Cauchy problem for the heat equation is unique.

### Solution 39.2

Let  $\mu(x)$  be the equilibrium temperature. It satisfies an ordinary differential equation boundary value problem.

$$\mu'' = -\frac{q(x)}{\kappa}, \quad \mu(0) = a, \quad \mu(h) = b$$

To solve this boundary value problem we find a particular solution  $\mu_p$  that satisfies homogeneous boundary conditions and then add on a homogeneous solution  $\mu_h$  that satisfies the inhomogeneous boundary conditions.

$$\begin{aligned}\mu_p'' &= -\frac{q(x)}{\kappa}, & \mu_p(0) &= \mu_p(h) = 0 \\ \mu_h'' &= 0, & \mu_h(0) &= a, \quad \mu_h(h) = b\end{aligned}$$

We find the particular solution  $\mu_p$  with the method of Green functions.

$$G'' = \delta(x - \xi), \quad G(0|\xi) = G(h|\xi) = 0.$$

We find homogeneous solutions which respectively satisfy the left and right homogeneous boundary conditions.

$$y_1 = x, \quad y_2 = h - x$$

Then we compute the Wronskian of these solutions and write down the Green function.

$$W = \begin{vmatrix} x & h - x \\ 1 & -1 \end{vmatrix} = -h$$

$$G(x|\xi) = -\frac{1}{h}x_{<}(h - x_{>})$$

The homogeneous solution that satisfies the inhomogeneous boundary conditions is

$$\mu_h = a + \frac{b - a}{h}x$$

Now we have the equilibrium temperature.

$$\mu = a + \frac{b - a}{h}x + \int_0^h -\frac{1}{h}x_{<}(h - x_{>}) \left( -\frac{q(\xi)}{\kappa} \right) d\xi$$

$$\mu = a + \frac{b - a}{h}x + \frac{h - x}{h\kappa} \int_0^x \xi q(\xi) d\xi + \frac{x}{h\kappa} \int_x^h (h - \xi)q(\xi) d\xi$$

Let  $v$  denote the deviation from the equilibrium temperature.

$$u = \mu + v$$

$v$  satisfies a heat equation with homogeneous boundary conditions and no source term.

$$v_t = \kappa v_{xx}, \quad v(0, t) = v(h, t) = 0, \quad v(x, 0) = f(x) - \mu(x)$$

We solve the problem for  $v$  with separation of variables.

$$v = X(x)T(t)$$

$$XT' = \kappa X''T$$

$$\frac{T'}{\kappa T} = \frac{X''}{X} = -\lambda$$

We have a regular Sturm-Liouville problem for  $X$  and a differential equation for  $T$ .

$$\begin{aligned} X'' + \lambda X &= 0, & X(0) &= X(\lambda) = 0 \\ \lambda_n &= \left(\frac{n\pi}{h}\right)^2, & X_n &= \sin\left(\frac{n\pi x}{h}\right), & n &\in \mathbb{Z}^+ \\ T' &= -\lambda\kappa T \\ T_n &= \exp\left(-\kappa\left(\frac{n\pi}{h}\right)^2 t\right) \end{aligned}$$

$v$  is a linear combination of the eigensolutions.

$$v = \sum_{n=1}^{\infty} v_n \sin\left(\frac{n\pi x}{h}\right) \exp\left(-\kappa\left(\frac{n\pi}{h}\right)^2 t\right)$$

The coefficients are determined from the initial condition,  $v(x, 0) = f(x) - \mu(x)$ .

$$v_n = \frac{2}{h} \int_0^h (f(x) - \mu(x)) \sin\left(\frac{n\pi x}{h}\right) dx$$

We have determined the solution of the original problem in terms of the equilibrium temperature and the deviation from the equilibrium.  $u = \mu + v$ .

### Solution 39.3

A problem is well posed if there exists a unique solution that depends continuously on the nonhomogeneous data.

First we find some solutions of the differential equation with the separation of variables  $u = X(x)T(t)$ .

$$\begin{aligned} u_t + \kappa u_{xx} &= 0, & \kappa &> 0 \\ XT' + \kappa X''T &= 0 \\ \frac{T'}{\kappa T} &= -\frac{X''}{X} = \lambda \\ X'' + \lambda X &= 0, & T' &= \lambda\kappa T \\ u &= \cos(\sqrt{\lambda}x) e^{\lambda\kappa t}, & u &= \sin(\sqrt{\lambda}x) e^{\lambda\kappa t} \end{aligned}$$

Note that

$$u = \epsilon \cos(\sqrt{\lambda}x) e^{\lambda\kappa t}$$

satisfies the Cauchy problem

$$u_t + \kappa u_{xx} = 0, \quad u(x, 0) = \epsilon \cos(\sqrt{\lambda}x)$$

Consider  $\epsilon \ll 1$ . The initial condition is small, it satisfies  $|u(x, 0)| < \epsilon$ . However the solution for any positive time can be made arbitrarily large by choosing a sufficiently large, positive value of  $\lambda$ . We can make the solution exceed the value  $M$  at time  $t$  by choosing a value of  $\lambda$  such that

$$\begin{aligned} \epsilon e^{\lambda\kappa t} &> M \\ \lambda &> \frac{1}{\kappa t} \ln\left(\frac{M}{\epsilon}\right). \end{aligned}$$

Thus we see that Equation 39.1 is ill posed because the solution does not depend continuously on the initial data. A small change in the initial condition can produce an arbitrarily large change in the solution for any fixed time.

#### Solution 39.4

Consider a Region of material,  $R$ . Let  $u$  be the temperature and  $\phi$  be the heat flux. The amount of heat energy in the region is

$$\int_R c\rho u \, d\mathbf{x}.$$

We equate the rate of change of heat energy in the region with the heat flux across the boundary of the region.

$$\frac{d}{dt} \int_R c\rho u \, d\mathbf{x} = - \int_{\partial R} \phi \cdot \mathbf{n} \, ds$$

We apply the divergence theorem to change the surface integral to a volume integral.

$$\begin{aligned} \frac{d}{dt} \int_R c\rho u \, d\mathbf{x} &= - \int_R \nabla \cdot \phi \, d\mathbf{x} \\ \int_R \left( c\rho \frac{\partial u}{\partial t} + \nabla \cdot \phi \right) d\mathbf{x} &= 0 \end{aligned}$$

Since the region is arbitrary, the integral must vanish identically.

$$c\rho \frac{\partial u}{\partial t} = -\nabla \cdot \phi$$

We apply Fourier's law of heat conduction,  $\phi = -k\nabla u$ , to obtain the heat equation.

$$\frac{\partial u}{\partial t} = \frac{1}{c\rho} \nabla \cdot (k\nabla u)$$

### Solution 39.5

We verify Duhamel's principal by showing that the integral expression for  $w(x, t)$  satisfies the partial differential equation and the initial condition. Clearly the initial condition is satisfied.

$$w(x, 0) = \int_0^0 u(x, 0 - \tau, \tau) d\tau = 0$$

Now we substitute the expression for  $w(x, t)$  into the partial differential equation.

$$\begin{aligned} \frac{\partial}{\partial t} \int_0^t u(x, t - \tau, \tau) d\tau &= \kappa \frac{\partial^2}{\partial x^2} \int_0^t u(x, t - \tau, \tau) d\tau + f(x, t) \\ u(x, t - t, t) + \int_0^t u_t(x, t - \tau, \tau) d\tau &= \kappa \int_0^t u_{xx}(x, t - \tau, \tau) d\tau + f(x, t) \\ f(x, t) + \int_0^t u_t(x, t - \tau, \tau) d\tau &= \kappa \int_0^t u_{xx}(x, t - \tau, \tau) d\tau + f(x, t) \\ &\int_0^t (u_t(x, t - \tau, \tau) d\tau - \kappa u_{xx}(x, t - \tau, \tau)) d\tau \end{aligned}$$

Since  $u_t(x, t - \tau, \tau) d\tau - \kappa u_{xx}(x, t - \tau, \tau) = 0$ , this equation is an identity.

**Solution 39.6**

We equate the rate of change of thermal energy in the segment  $(\alpha \dots \beta)$  with the heat entering the segment through the endpoints.

$$\int_{\alpha}^{\beta} \phi_t c \rho A \, dx = k(\beta, \phi(\beta)) A(\beta) \phi_x(\beta, t) - k(\alpha, \phi(\alpha)) A(\alpha) \phi_x(\alpha, t)$$

$$\int_{\alpha}^{\beta} \phi_t c \rho A \, dx = [k A \phi_x]_{\alpha}^{\beta}$$
$$\int_{\alpha}^{\beta} \phi_t c \rho A \, dx = \int_{\alpha}^{\beta} (k A \phi_x)_x \, dx$$

$$\int_{\alpha}^{\beta} c \rho A \phi_t - (k A \phi_x)_x \, dx = 0$$

Since the domain is arbitrary, we conclude that

$$\boxed{c \rho A \phi_t = (k A \phi_x)_x .}$$



# Chapter 40

## Laplace's Equation

### 40.1 Introduction

Laplace's equation in  $n$  dimensions is

$$\Delta u = 0$$

where

$$\Delta = \frac{\partial^2}{\partial x_1^2} + \cdots + \frac{\partial^2}{\partial x_n^2}.$$

The inhomogeneous analog is called **Poisson's Equation**.

$$-\Delta u = f(\mathbf{x})$$

CONTINUE

### 40.2 Fundamental Solution

The fundamental solution of Poisson's equation in  $\mathbb{R}^n$  satisfies

$$-\Delta G = \delta(\mathbf{x} - \boldsymbol{\xi}).$$

## 40.2.1 Two Dimensional Space

If  $n = 2$  then the fundamental solution satisfies

$$-\left(\frac{\partial^2}{\partial x^2} + \frac{\partial^2}{\partial y^2}\right)G = \delta(x - \xi)\delta(y - \psi).$$

Since the product of delta functions,  $\delta(x - \xi)\delta(y - \psi)$  is circularly symmetric about the point  $(\xi, \psi)$ , we look for a solution in the form  $u(x, y) = v(r)$  where  $r = \sqrt{(x - \xi)^2 + (y - \psi)^2}$ .

CONTINUE

## 40.3 Exercises

### Exercise 40.1

Is the solution of the following Dirichlet problem unique?

$$\begin{aligned}u_{xx} + u_{yy} &= q(x, y), & -\infty < x < \infty, & \quad y > 0 \\u(x, 0) &= f(x)\end{aligned}$$

### Exercise 40.2

Is the solution of the following Dirichlet problem unique?

$$\begin{aligned}u_{xx} + u_{yy} &= q(x, y), & -\infty < x < \infty, & \quad y > 0 \\u(x, 0) &= f(x), & u \text{ bounded as } x^2 + y^2 &\rightarrow \infty\end{aligned}$$

### Exercise 40.3

Not all combinations of boundary conditions/initial conditions lead to so called well-posed problems. Essentially, a well posed problem is one where the solutions depend continuously on the boundary data. Otherwise it is considered "ill posed".

Consider Laplace's equation on the unit-square

$$u_{xx} + u_{yy} = 0,$$

with  $u(0, y) = u(1, y) = 0$  and  $u(x, 0) = 0$ ,  $u_y(x, 0) = \epsilon \sin(n\pi x)$ .

1. Show that even as  $\epsilon \rightarrow 0$ , you can find  $n$  so that the solution can attain any finite value for any  $y > 0$ . Use this to then show that this problem is ill posed.
2. Contrast this with the case where  $u(0, y) = u(1, y) = 0$  and  $u(x, 0) = 0$ ,  $u(x, 1) = \epsilon \sin(n\pi x)$ . Is this well posed?

### Exercise 40.4

Use the fundamental solutions for the Laplace equation

$$\nabla^2 G = \delta(\mathbf{x} - \boldsymbol{\xi})$$

in three dimensions

$$G(\mathbf{x}|\boldsymbol{\xi}) = -\frac{1}{4\pi|\mathbf{x} - \boldsymbol{\xi}|}$$

to derive the mean value theorem for harmonic functions

$$u(\mathbf{p}) = \frac{1}{4\pi R^2} \int_{\partial S_R} u(\boldsymbol{\xi}) \, dA_{\boldsymbol{\xi}},$$

that relates the value of any harmonic function  $u(\mathbf{x})$  at the point  $\mathbf{x} = \mathbf{p}$  to the average of its value on the boundary of the sphere of radius  $R$  with center at  $\mathbf{p}$ ,  $(\partial S_R)$ .

### Exercise 40.5

Use the fundamental solutions for the modified Helmholtz equation

$$\nabla^2 u - \lambda u = \delta(\mathbf{x} - \boldsymbol{\xi})$$

in three dimensions

$$u_{\pm}(\mathbf{x}|\boldsymbol{\xi}) = \frac{-1}{4\pi|\mathbf{x} - \boldsymbol{\xi}|} e^{\pm\sqrt{\lambda}|\mathbf{x}-\boldsymbol{\xi}|},$$

to derive a “generalized” mean value theorem:

$$\frac{\sinh(\sqrt{\lambda}R)}{\sqrt{\lambda}R} u(\mathbf{p}) = \frac{1}{4\pi R^2} \int_{\partial S} u(\mathbf{x}) \, dA$$

that relates the value of any solution  $u(\mathbf{x})$  at a point  $P$  to the average of its value on the sphere of radius  $R$   $(\partial S)$  with center at  $P$ .

### Exercise 40.6

Consider the uniqueness of solutions of  $\nabla^2 u(\mathbf{x}) = 0$  in a two dimensional region  $R$  with boundary curve  $C$  and a boundary condition  $\mathbf{n} \cdot \nabla u(\mathbf{x}) = -a(\mathbf{x})u(\mathbf{x})$  on  $C$ . State a non-trivial condition on the function  $a(\mathbf{x})$  on  $C$  for which solutions are unique, and justify your answer.

**Exercise 40.7**

Solve Laplace's equation on the surface of a semi-infinite cylinder of unit radius,  $0 < \theta < 2\pi$ ,  $z > 0$ , where the solution,  $u(\theta, z)$  is prescribed at  $z = 0$ :  $u(\theta, 0) = f(\theta)$ .

**Exercise 40.8**

Solve Laplace's equation in a rectangle.

$$\begin{aligned}w_{xx} + w_{yy} &= 0, & 0 < x < a, & \quad 0 < y < b, \\w(0, y) &= f_1(y), & w(a, y) &= f_2(y), \\w_y(x, 0) &= g_1(x), & w(x, b) &= g_2(x)\end{aligned}$$

Proceed by considering  $w = u + v$  where  $u$  and  $v$  are harmonic and satisfy

$$\begin{aligned}u(0, y) = u(a, y) &= 0, & u_y(x, 0) &= g_1(x), & u(x, b) &= g_2(x), \\v(0, y) &= f_1(y), & v(a, y) &= f_2(y), & v_y(x, 0) &= v(x, b) = 0.\end{aligned}$$

## 40.4 Hints

**Hint 40.1**

**Hint 40.2**

**Hint 40.3**

**Hint 40.4**

**Hint 40.5**

**Hint 40.6**

**Hint 40.7**

**Hint 40.8**

## 40.5 Solutions

### Solution 40.1

Let  $u$  and  $v$  both be solutions of the Dirichlet problem. Let  $w$  be the difference of these solutions.  $w$  satisfies the problem

$$\begin{aligned}w_{xx} + w_{yy} &= 0, & -\infty < x < \infty, & \quad y > 0 \\w(x, 0) &= 0.\end{aligned}$$

Since  $w = cy$  is a solution. We conclude that the solution of the Dirichlet problem is not unique.

### Solution 40.2

Let  $u$  and  $v$  both be solutions of the Dirichlet problem. Let  $w$  be the difference of these solutions.  $w$  satisfies the problem

$$\begin{aligned}w_{xx} + w_{yy} &= 0, & -\infty < x < \infty, & \quad y > 0 \\w(x, 0) &= 0, & w \text{ bounded as } x^2 + y^2 &\rightarrow \infty.\end{aligned}$$

We solve this problem with a Fourier transform in  $x$ .

$$\begin{aligned}-\omega^2 \hat{w} + \hat{w}_{yy} &= 0, & \hat{w}(\omega, 0) &= 0, & \hat{w} \text{ bounded as } y &\rightarrow \infty \\ \hat{w} &= \begin{cases} c_1 \cosh \omega y + c_2 \sinh(\omega y), & \omega \neq 0 \\ c_1 + c_2 y, & \omega = 0 \end{cases} \\ \hat{w} &= 0 \\ w &= 0\end{aligned}$$

Since  $u - v = 0$ , we conclude that the solution of the Dirichlet problem is unique.

### Solution 40.3

1. We seek a solution of the form  $u(x, y) = \sin(n\pi x)Y(y)$ . This form satisfies the boundary conditions at  $x = 0, 1$ .

$$\begin{aligned}u_{xx} + u_{yy} &= 0 \\ -(n\pi)^2 Y + Y'' &= 0, \quad Y(0) = 0 \\ Y &= c \sinh(n\pi y)\end{aligned}$$

Now we apply the inhomogeneous boundary condition.

$$\begin{aligned}u_y(x, 0) &= \epsilon \sin(n\pi x) = cn\pi \sin(n\pi x) \\ u(x, y) &= \frac{\epsilon}{n\pi} \sin(n\pi x) \sinh(n\pi y)\end{aligned}$$

For  $\epsilon = 0$  the solution is  $u = 0$ . Now consider any  $\epsilon > 0$ . For any  $y > 0$  and any finite value  $M$ , we can choose a value of  $n$  such that the solution along  $y = 0$  takes on all values in the range  $[-M \dots M]$ . We merely choose a value of  $n$  such that

$$\frac{\sinh(n\pi y)}{n\pi} \geq \frac{M}{\epsilon}.$$

Since the solution does not depend continuously on boundary data, this problem is ill posed.

2. We seek a solution of the form  $u(x, y) = c \sin(n\pi x) \sinh(n\pi y)$ . This form satisfies the differential equation and the boundary conditions at  $x = 0, 1$  and at  $y = 0$ . We apply the inhomogeneous boundary condition at  $y = 1$ .

$$\begin{aligned}u(x, 1) &= \epsilon \sin(n\pi x) = c \sin(n\pi x) \sinh(n\pi) \\ u(x, y) &= \epsilon \sin(n\pi x) \frac{\sinh(n\pi y)}{\sinh(n\pi)}\end{aligned}$$

For  $\epsilon = 0$  the solution is  $u = 0$ . Now consider any  $\epsilon > 0$ . Note that  $|u| \leq \epsilon$  for  $(x, y) \in [0 \dots 1] \times [0 \dots 1]$ . The solution depends continuously on the given boundary data. This problem is well posed.

### Solution 40.4

The Green function problem for a sphere of radius  $R$  centered at the point  $\xi$  is

$$\Delta G = \delta(\mathbf{x} - \xi), \quad G|_{|\mathbf{x} - \xi| = R} = 0. \quad (40.1)$$



We will solve Laplace's equation,  $\Delta u = 0$ , where the value of  $u$  is known on the boundary of the sphere of radius  $R$  in terms of this Green function.

First we solve for  $u(\mathbf{x})$  in terms of the Green function.

$$\int_S (u\Delta G - G\Delta u) d\xi = \int_S u\delta(\mathbf{x} - \xi) d\xi = u(\mathbf{x})$$

$$\begin{aligned} \int_S (u\Delta G - G\Delta u) d\xi &= \int_{\partial S} \left( u \frac{\partial G}{\partial n} - G \frac{\partial u}{\partial n} \right) dA_\xi \\ &= \int_{\partial S} u \frac{\partial G}{\partial n} dA_\xi \end{aligned}$$

$$u(\mathbf{x}) = \int_{\partial S} u \frac{\partial G}{\partial n} dA_\xi$$

We are interested in the value of  $u$  at the center of the sphere. Let  $\rho = |\mathbf{p} - \xi|$

$$u(\mathbf{p}) = \int_{\partial S} u(\xi) \frac{\partial G}{\partial \rho}(\mathbf{p}|\xi) dA_\xi$$

We do not need to compute the general solution of Equation 40.1. We only need the Green function at the point  $\mathbf{x} = \mathbf{p}$ . We know that the general solution of the equation  $\Delta G = \delta(\mathbf{x} - \xi)$  is

$$G(\mathbf{x}|\xi) = -\frac{1}{4\pi|\mathbf{x} - \xi|} + v(\mathbf{x}),$$

where  $v(\mathbf{x})$  is an arbitrary harmonic function. The Green function at the point  $\mathbf{x} = \mathbf{p}$  is

$$G(\mathbf{p}|\xi) = -\frac{1}{4\pi|\mathbf{p} - \xi|} + \text{const.}$$

We add the constraint that the Green function vanishes at  $\rho = R$ . This determines the constant.

$$G(\mathbf{p}|\boldsymbol{\xi}) = -\frac{1}{4\pi|\mathbf{p} - \boldsymbol{\xi}|} + \frac{1}{4\pi R}$$

$$G(\mathbf{p}|\boldsymbol{\xi}) = -\frac{1}{4\pi\rho} + \frac{1}{4\pi R}$$

$$G_\rho(\mathbf{p}|\boldsymbol{\xi}) = \frac{1}{4\pi\rho^2}$$

Now we are prepared to write  $u(\mathbf{p})$  in terms of the Green function.

$$u(\mathbf{p}) = \int_{\partial S} u(\boldsymbol{\xi}) \frac{1}{4\pi\rho^2} dA_\boldsymbol{\xi}$$

$$u(\mathbf{p}) = \frac{1}{4\pi R^2} \int_{\partial S} u(\boldsymbol{\xi}) dA_\boldsymbol{\xi}$$

This is the Mean Value Theorem for harmonic functions.

### Solution 40.5

The Green function problem for a sphere of radius  $R$  centered at the point  $\boldsymbol{\xi}$  is

$$\Delta G - \lambda G = \delta(\mathbf{x} - \boldsymbol{\xi}), \quad G|_{|\mathbf{x} - \boldsymbol{\xi}|=R} = 0. \quad (40.2)$$

We will solve the modified Helmholtz equation,

$$\Delta u - \lambda u = 0,$$

where the value of  $u$  is known on the boundary of the sphere of radius  $R$  in terms of this Green function.  
in terms of this Green function.

Let  $L[u] = \Delta u - \lambda u$ .

$$\int_S (uL[G] - GL[u]) d\boldsymbol{\xi} = \int_S u\delta(\mathbf{x} - \boldsymbol{\xi}) d\boldsymbol{\xi} = u(\mathbf{x})$$

$$\begin{aligned}
\int_S (uL[G] - GL[u]) \, d\xi &= \int_S (u\Delta G - G\Delta u) \, d\xi \\
&= \int_{\partial S} \left( u \frac{\partial G}{\partial n} - G \frac{\partial u}{\partial n} \right) \, dA_\xi \\
&= \int_{\partial S} u \frac{\partial G}{\partial n} \, dA_\xi
\end{aligned}$$

$$u(\mathbf{x}) = \int_{\partial S} u \frac{\partial G}{\partial n} \, dA_\xi$$

We are interested in the value of  $u$  at the center of the sphere. Let  $\rho = |\mathbf{p} - \xi|$

$$u(\mathbf{p}) = \int_{\partial S} u(\xi) \frac{\partial G}{\partial \rho}(\mathbf{p}|\xi) \, dA_\xi$$

We do not need to compute the general solution of Equation 40.2. We only need the Green function at the point  $\mathbf{x} = \mathbf{p}$ . We know that the Green function there is a linear combination of the fundamental solutions,

$$G(\mathbf{p}|\xi) = c_1 \frac{-1}{4\pi|\mathbf{p} - \xi|} e^{\sqrt{\lambda}|\mathbf{p} - \xi|} + c_2 \frac{-1}{4\pi|\mathbf{p} - \xi|} e^{-\sqrt{\lambda}|\mathbf{p} - \xi|},$$

such that  $c_1 + c_2 = 1$ . The Green function is symmetric with respect to  $\mathbf{x}$  and  $\xi$ . We add the constraint that the Green

function vanishes at  $\rho = R$ . This gives us two equations for  $c_1$  and  $c_2$ .

$$c_1 + c_2 = 1, \quad -\frac{c_1}{4\pi R} e^{\sqrt{\lambda}R} - \frac{c_2}{4\pi R} e^{-\sqrt{\lambda}R} = 0$$

$$c_1 = -\frac{1}{e^{2\sqrt{\lambda}R} - 1}, \quad c_2 = \frac{e^{2\sqrt{\lambda}R}}{e^{2\sqrt{\lambda}R} - 1}$$

$$G(\mathbf{p}|\boldsymbol{\xi}) = \frac{\sinh(\sqrt{\lambda}(\rho - R))}{4\pi\rho \sinh(\sqrt{\lambda}R)}$$

$$G_\rho(\mathbf{p}|\boldsymbol{\xi}) = \frac{\sqrt{\lambda} \cosh(\sqrt{\lambda}(\rho - R))}{4\pi\rho \sinh(\sqrt{\lambda}R)} - \frac{\sinh(\sqrt{\lambda}(\rho - R))}{4\pi\rho^2 \sinh(\sqrt{\lambda}R)}$$

$$G_\rho(\mathbf{p}|\boldsymbol{\xi})|_{|\boldsymbol{\xi}|=R} = \frac{\sqrt{\lambda}}{4\pi R \sinh(\sqrt{\lambda}R)}$$

Now we are prepared to write  $u(\mathbf{p})$  in terms of the Green function.

$$u(\mathbf{p}) = \int_{\partial S} u(\boldsymbol{\xi}) \frac{\sqrt{\lambda}}{4\pi\rho \sinh(\sqrt{\lambda}R)} dA_{\boldsymbol{\xi}}$$

$$u(\mathbf{p}) = \int_{\partial S} u(\mathbf{x}) \frac{\sqrt{\lambda}}{4\pi R \sinh(\sqrt{\lambda}R)} dA$$

Rearranging this formula gives us the generalized mean value theorem.

$$\frac{\sinh(\sqrt{\lambda}R)}{\sqrt{\lambda}R} u(\mathbf{p}) = \frac{1}{4\pi R^2} \int_{\partial S} u(\mathbf{x}) dA$$

### Solution 40.6

First we think of this problem in terms of the the equilibrium solution of the heat equation. The boundary condition expresses Newton's law of cooling. Where  $a = 0$ , the boundary is insulated. Where  $a > 0$ , the rate of heat loss is proportional to the temperature. The case  $a < 0$  is non-physical and we do not consider this scenario further. We know that if the boundary is entirely insulated,  $a = 0$ , then the equilibrium temperature is a constant that depends on the initial temperature distribution. Thus for  $a = 0$  the solution of Laplace's equation is not unique. If there is any point on the boundary where  $a$  is positive then eventually, all of the heat will flow out of the domain. The equilibrium temperature is zero, and the solution of Laplace's equation is unique,  $u = 0$ . Therefore the solution of Laplace's equation is unique if  $a$  is continuous, non-negative and not identically zero.

Now we prove our assertion. First note that if we substitute  $\mathbf{f} = v\nabla u$  in the divergence theorem,

$$\int_R \nabla \cdot \mathbf{f} \, d\mathbf{x} = \int_{\partial R} \mathbf{f} \cdot \mathbf{n} \, ds,$$

we obtain the identity,

$$\int_R (v\Delta u + \nabla v \nabla u) \, d\mathbf{x} = \int_{\partial R} v \frac{\partial u}{\partial n} \, ds. \quad (40.3)$$

Let  $u$  be a solution of Laplace's equation subject to the Robin boundary condition with our restrictions on  $a$ . We take  $v = u$  in Equation 40.3.

$$\int_R (\nabla u)^2 \, d\mathbf{x} = \int_C u \frac{\partial u}{\partial n} \, ds = - \int_C au^2 \, ds$$

Since the first integral is non-negative and the last is non-positive, the integrals vanish. This implies that  $\nabla u = 0$ .  $u$  is a constant. In order to satisfy the boundary condition where  $a$  is non-zero,  $u$  must be zero. Thus the unique solution in this scenario is  $u = 0$ .

### Solution 40.7

The mathematical statement of the problem is

$$\begin{aligned} \Delta u \equiv u_{\theta\theta} + u_{zz} &= 0, & 0 < \theta < 2\pi, & \quad z > 0, \\ u(\theta, 0) &= f(\theta). \end{aligned}$$

We have the implicit boundary conditions,

$$u(0, z) = u(2\pi, z), \quad u_\theta(0, z) = u_\theta(0, z)$$

and the boundedness condition,

$$u(\theta, +\infty) \text{ bounded.}$$

We expand the solution in a Fourier series. (This ensures that the boundary conditions at  $\theta = 0, 2\pi$  are satisfied.)

$$u(\theta, z) = \sum_{n=-\infty}^{\infty} u_n(z) e^{in\theta}$$

We substitute the series into the partial differential equation to obtain ordinary differential equations for the  $u_n$ .

$$-n^2 u_n(z) + u_n''(z) = 0$$

The general solutions of this equation are

$$u_n(z) = \begin{cases} c_1 + c_2 z, & \text{for } n = 0, \\ c_1 e^{nz} + c_2 e^{-nz} & \text{for } n \neq 0. \end{cases}$$

The bounded solutions are

$$u_n(z) = \begin{cases} c e^{-nz}, & \text{for } n > 0, \\ c, & \text{for } n = 0, \\ c e^{nz}, & \text{for } n < 0, \end{cases} = c e^{-|n|z}.$$

We substitute the series into the initial condition at  $z = 0$  to determine the multiplicative constants.

$$u(\theta, 0) = \sum_{n=-\infty}^{\infty} u_n(0) e^{in\theta} = f(\theta)$$
$$u_n(0) = \frac{1}{2\pi} \int_0^{2\pi} f(\theta) e^{-in\theta} d\theta \equiv f_n$$

Thus the solution is

$$u(\theta, z) = \sum_{n=-\infty}^{\infty} f_n e^{in\theta} e^{-|n|z}.$$

Note that

$$u(\theta, z) \rightarrow f_0 = \frac{1}{2\pi} \int_0^{2\pi} f(\theta) d\theta$$

as  $z \rightarrow +\infty$ .

### Solution 40.8

The decomposition of the problem is shown in Figure 40.1.

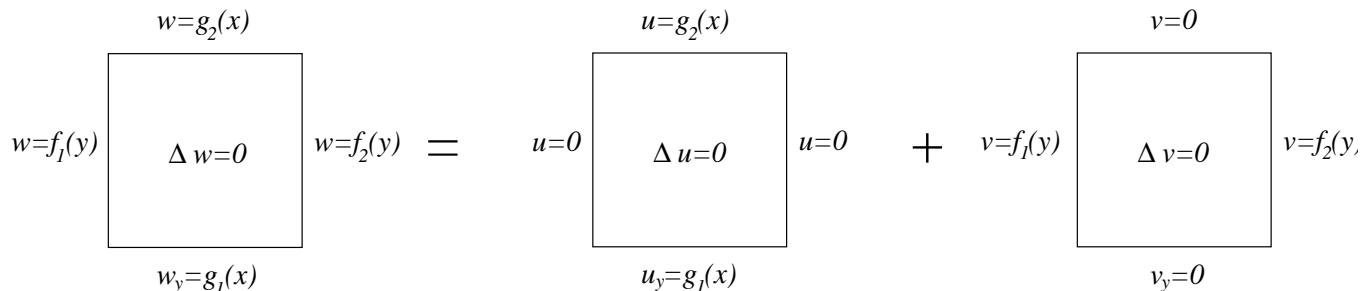

Figure 40.1: Decomposition of the problem.

First we solve the problem for  $u$ .

$$\begin{aligned} u_{xx} + u_{yy} &= 0, & 0 < x < a, & \quad 0 < y < b, \\ u(0, y) &= u(a, y) = 0, \\ u_y(x, 0) &= g_1(x), & u(x, b) &= g_2(x) \end{aligned}$$

We substitute the separation of variables  $u(x, y) = X(x)Y(y)$  into Laplace's equation.

$$\frac{X''}{X} = -\frac{Y''}{Y} = -\lambda^2$$

We have the eigenvalue problem,

$$X'' = -\lambda^2 X, \quad X(0) = X(a) = 0,$$

which has the solutions,

$$\lambda_n = \frac{n\pi}{a}, \quad X_n = \sin\left(\frac{n\pi x}{a}\right), \quad n \in \mathbb{N}.$$

The equation for  $Y(y)$  becomes,

$$Y_n'' = \left(\frac{n\pi}{a}\right)^2 Y_n,$$

which has the solutions,

$$\left\{e^{n\pi y/a}, e^{-n\pi y/a}\right\} \quad \text{or} \quad \left\{\cosh\left(\frac{n\pi y}{a}\right), \sinh\left(\frac{n\pi y}{a}\right)\right\}.$$

It will be convenient to choose solutions that satisfy the conditions,  $Y(b) = 0$  and  $Y'(0) = 0$ , respectively.

$$\left\{\sinh\left(\frac{n\pi(b-y)}{a}\right), \cosh\left(\frac{n\pi y}{a}\right)\right\}$$

The solution for  $u(x, y)$  has the form,

$$u(x, y) = \sum_{n=1}^{\infty} \sin\left(\frac{n\pi x}{a}\right) \left(\alpha_n \sinh\left(\frac{n\pi(b-y)}{a}\right) + \beta_n \cosh\left(\frac{n\pi y}{a}\right)\right).$$

We determine the coefficients from the inhomogeneous boundary conditions. (Here we see how our choice of solutions



for  $Y(y)$  is convenient.)

$$u_y(x, 0) = \sum_{n=1}^{\infty} -\frac{n\pi}{a} \alpha_n \sin\left(\frac{n\pi x}{a}\right) \cosh\left(\frac{n\pi b}{a}\right) = g_1(x)$$

$$\alpha_n = -\frac{a}{n\pi} \operatorname{sech}\left(\frac{n\pi b}{a}\right) \frac{2}{a} \int_0^a g_1(x) \sin\left(\frac{n\pi x}{a}\right) dx$$

$$u(x, y) = \sum_{n=1}^{\infty} \beta_n \sin\left(\frac{n\pi x}{a}\right) \cosh\left(\frac{n\pi y}{a}\right)$$

$$\beta_n = \operatorname{sech}\left(\frac{n\pi b}{a}\right) \frac{2}{a} \int_0^a g_2(x) \sin\left(\frac{n\pi x}{a}\right) dx$$

Now we solve the problem for  $v$ .

$$v_{xx} + v_{yy} = 0, \quad 0 < x < a, \quad 0 < y < b,$$

$$v(0, y) = f_1(y), \quad v(a, y) = f_2(y),$$

$$v_y(x, 0) = 0, \quad v(x, b) = 0$$

We substitute the separation of variables  $u(x, y) = X(x)Y(y)$  into Laplace's equation.

$$\frac{X''}{X} = -\frac{Y''}{Y} = \lambda^2$$

We have the eigenvalue problem,

$$Y'' = -\lambda^2 Y, \quad Y'(0) = Y(b) = 0,$$

which has the solutions,

$$\lambda_n = \frac{(2n-1)\pi}{2b}, \quad Y_n = \cos\left(\frac{(2n-1)\pi y}{2b}\right), \quad n \in \mathbb{N}.$$

The equation for  $X(y)$  becomes,

$$X_n'' = \left(\frac{(2n-1)\pi}{2b}\right)^2 X_n.$$

We choose solutions that satisfy the conditions,  $X(a) = 0$  and  $X(0) = 0$ , respectively.

$$\left\{ \sinh \left( \frac{(2n-1)\pi(a-x)}{2b} \right), \sinh \left( \frac{(2n-1)\pi x}{2b} \right) \right\}$$

The solution for  $v(x, y)$  has the form,

$$v(x, y) = \sum_{n=1}^{\infty} \cos \left( \frac{(2n-1)\pi y}{2b} \right) \left( \gamma_n \sinh \left( \frac{(2n-1)\pi(a-x)}{2b} \right) + \delta_n \sinh \left( \frac{(2n-1)\pi x}{2b} \right) \right).$$

We determine the coefficients from the inhomogeneous boundary conditions.

$$v(0, y) = \sum_{n=1}^{\infty} \gamma_n \cos \left( \frac{(2n-1)\pi y}{2b} \right) \sinh \left( \frac{(2n-1)\pi a}{2b} \right) = f_1(y)$$

$$\gamma_n = \operatorname{csch} \left( \frac{(2n-1)\pi a}{2b} \right) \frac{2}{b} \int_0^b f_1(y) \cos \left( \frac{(2n-1)\pi y}{2b} \right) dy$$

$$v(a, y) = \sum_{n=1}^{\infty} \delta_n \cos \left( \frac{(2n-1)\pi y}{2b} \right) \sinh \left( \frac{(2n-1)\pi a}{2b} \right) = f_2(y)$$

$$\delta_n = \operatorname{csch} \left( \frac{(2n-1)\pi a}{2b} \right) \frac{2}{b} \int_0^b f_2(y) \cos \left( \frac{(2n-1)\pi y}{2b} \right) dy$$

With  $u$  and  $v$  determined, the solution of the original problem is  $w = u + v$ .

# Chapter 41

## Waves

## 41.1 Exercises

### Exercise 41.1

Consider the 1-D wave equation

$$u_{tt} - u_{xx} = 0$$

on the domain  $0 < x < 4$  with initial displacement

$$u(x, 0) = \begin{cases} 1, & 1 < x < 2 \\ 0, & \text{otherwise,} \end{cases}$$

initial velocity  $u_t(x, 0) = 0$ , and subject to the following boundary conditions

1.

$$u(0, t) = u(4, t) = 0$$

2.

$$u_x(0, t) = u_x(4, t) = 0$$

In each case plot  $u(x, t)$  for  $t = \frac{1}{2}, 1, \frac{3}{2}, 2$  and combine onto a general plot in the  $x, t$  plane (up to a sufficiently large time) so the behavior of  $u$  is clear for arbitrary  $x, t$ .

### Exercise 41.2

Sketch the solution to the wave equation:

$$u(x, t) = \frac{1}{2} (u(x + ct, 0) + u(x - ct, 0)) + \frac{1}{2c} \int_{x-ct}^{x+ct} u_t(\tau, 0) d\tau,$$

for various values of  $t$  corresponding to the initial conditions:

1.  $u(x, 0) = 0, \quad u_t(x, 0) = \sin \omega x$  where  $\omega$  is a constant,

$$2. \quad u(x, 0) = 0, \quad u_t(x, 0) = \begin{cases} 1 & \text{for } 0 < x < 1 \\ -1 & \text{for } -1 < x < 0 \\ 0 & \text{for } |x| > 1. \end{cases}$$

### Exercise 41.3

1. Consider the solution of the wave equation for  $u(x, t)$ :

$$u_{tt} = c^2 u_{xx}$$

on the infinite interval  $-\infty < x < \infty$  with initial displacement of the form

$$u(x, 0) = \begin{cases} h(x) & \text{for } x > 0, \\ -h(-x) & \text{for } x < 0, \end{cases}$$

and with initial velocity

$$u_t(x, 0) = 0.$$

Show that the solution of the wave equation satisfying these initial conditions also solves the following semi-infinite problem: Find  $u(x, t)$  satisfying the wave equation  $u_{tt} = c^2 u_{xx}$  in  $0 < x < \infty$ ,  $t > 0$ , with initial conditions  $u(x, 0) = h(x)$ ,  $u_t(x, 0) = 0$ , and with the fixed end condition  $u(0, t) = 0$ . Here  $h(x)$  is any given function with  $h(0) = 0$ .

2. Use a similar idea to explain how you could use the general solution of the wave equation to solve the finite interval problem ( $0 < x < l$ ) in which  $u(0, t) = u(l, t) = 0$  for all  $t$ , with  $u(x, 0) = h(x)$  and  $u_t(x, 0) = 0$ . Take  $h(0) = h(l) = 0$ .

### Exercise 41.4

The deflection  $u(x, T) = \phi(x)$  and velocity  $u_t(x, T) = \psi(x)$  for an infinite string (governed by  $u_{tt} = c^2 u_{xx}$ ) are measured at time  $T$ , and we are asked to determine what the initial displacement and velocity profiles  $u(x, 0)$  and  $u_t(x, 0)$  must have been. An alert student suggests that this problem is equivalent to that of determining the solution of the wave equation at time  $T$  when initial conditions  $u(x, 0) = \phi(x)$ ,  $u_t(x, 0) = -\psi(x)$  are prescribed. Is she correct? If not, can you rescue her idea?

### Exercise 41.5

In obtaining the general solution of the wave equation the interval was chosen to be infinite in order to simplify the evaluation of the functions  $\alpha(\xi)$  and  $\beta(\xi)$  in the general solution

$$u(x, t) = \alpha(x + ct) + \beta(x - ct).$$

But this general solution is in fact valid for any interval be it infinite or finite. We need only choose appropriate functions  $\alpha(\xi)$ ,  $\beta(\xi)$  to satisfy the appropriate initial and boundary conditions. This is not always convenient but there are other situations besides the solution for  $u(x, t)$  in an infinite domain in which the general solution is of use. Consider the “whip-cracking” problem,

$$u_{tt} = c^2 u_{xx},$$

(with  $c$  a constant) in the domain  $x > 0, t > 0$  with initial conditions

$$u(x, 0) = u_t(x, 0) = 0 \quad x > 0,$$

and boundary conditions

$$u(0, t) = \gamma(t)$$

prescribed for all  $t > 0$ . Here  $\gamma(0) = 0$ . Find  $\alpha$  and  $\beta$  so as to determine  $u$  for  $x > 0, t > 0$ .

*Hint:* (From physical considerations conclude that you can take  $\alpha(\xi) = 0$ . Your solution will corroborate this.) Use the initial conditions to determine  $\alpha(\xi)$  and  $\beta(\xi)$  for  $\xi > 0$ . Then use the initial condition to determine  $\beta(\xi)$  for  $\xi < 0$ .

### Exercise 41.6

Let  $u(x, t)$  satisfy the equation

$$u_{tt} = c^2 u_{xx};$$

(with  $c$  a constant) in some region of the  $(x, t)$  plane.

1. Show that the quantity  $(u_t - cu_x)$  is constant along each straight line defined by  $x - ct = \text{constant}$ , and that  $(u_t + cu_x)$  is constant along each straight line of the form  $x + ct = \text{constant}$ . These straight lines are called *characteristics*; we will refer to typical members of the two families as  $C_+$  and  $C_-$  characteristics, respectively. Thus the line  $x - ct = \text{constant}$  is a  $C_+$  characteristic.

2. Let  $u(x, 0)$  and  $u_t(x, 0)$  be prescribed for all values of  $x$  in  $-\infty < x < \infty$ , and let  $(x_0, t_0)$  be some point in the  $(x, t)$  plane, with  $t_0 > 0$ . Draw the  $C_+$  and  $C_-$  characteristics through  $(x_0, t_0)$  and let them intersect the  $x$ -axis at the points  $A, B$ . Use the properties of these curves derived in part (a) to determine  $u_t(x_0, t_0)$  in terms of initial data at points  $A$  and  $B$ . Using a similar technique to obtain  $u_t(x_0, \tau)$  with  $0 < \tau < t$ , determine  $u(x_0, t_0)$  by integration with respect to  $\tau$ , and compare this with the solution derived in class:

$$u(x, t) = \frac{1}{2} (u(x + ct, 0) + u(x - ct, 0)) + \frac{1}{2c} \int_{x-ct}^{x+ct} u_t(\tau, 0) d\tau.$$

Observe that this “method of characteristics” again shows that  $u(x_0, t_0)$  depends only on that part of the initial data between points  $A$  and  $B$ .

### Exercise 41.7

The temperature  $u(x, t)$  at a depth  $x$  below the Earth’s surface at time  $t$  satisfies

$$u_t = \kappa u_{xx}.$$

The surface  $x = 0$  is heated by the sun according to the periodic rule:

$$u(0, t) = T \cos(\omega t).$$

Seek a solution of the form

$$u(x, t) = \Re (A e^{\omega t - \alpha x}).$$

- Find  $u(x, t)$  satisfying  $u \rightarrow 0$  as  $x \rightarrow +\infty$ , (i.e. deep into the Earth).
- Find the temperature variation at a fixed depth,  $h$ , below the surface.
- Find the phase lag  $\delta(x)$  such that when the maximum temperature occurs at  $t_0$  on the surface, the maximum at depth  $x$  occurs at  $t_0 + \delta(x)$ .
- Show that the seasonal, (i.e. yearly), temperature changes and daily temperature changes penetrate to depths in the ratio:

$$\frac{x_{\text{year}}}{x_{\text{day}}} = \sqrt{365},$$

where  $x_{\text{year}}$  and  $x_{\text{day}}$  are the depths of same temperature variation caused by the different periods of the source.

### Exercise 41.8

An infinite cylinder of radius  $a$  produces an external acoustic pressure field  $u$  satisfying:

$$u_{tt} = c^2 \delta u,$$

by a pure harmonic oscillation of its surface at  $r = a$ . That is, it moves so that

$$u(a, \theta, t) = f(\theta) e^{i\omega t}$$

where  $f(\theta)$  is a known function. Note that the waves must be outgoing at infinity, (radiation condition at infinity). Find the solution,  $u(r, \theta, t)$ . We seek a periodic solution of the form,

$$u(r, \theta, t) = v(r, \theta) e^{i\omega t}.$$

### Exercise 41.9

Plane waves are incident on a “soft” cylinder of radius  $a$  whose axis is parallel to the plane of the waves. Find the field scattered by the cylinder. In particular, examine the leading term of the solution when  $a$  is much smaller than the wavelength of the incident waves. If  $v(x, y, t)$  is the scattered field it must satisfy:

$$\text{Wave Equation: } v_{tt} = c^2 \Delta v, \quad x^2 + y^2 > a^2;$$

$$\text{Soft Cylinder: } v(x, y, t) = -e^{i(ka \cos \theta - \omega t)}, \quad \text{on } r = a, \quad 0 \leq \theta < 2\pi;$$

$$\text{Scattered: } v \text{ is outgoing as } r \rightarrow \infty.$$

Here  $k = \omega/c$ . Use polar coordinates in the  $(x, y)$  plane.

### Exercise 41.10

Consider the flow of electricity in a transmission line. The current,  $I(x, t)$ , and the voltage,  $V(x, t)$ , obey the telegrapher’s system of equations:

$$-I_x = CV_t + GV,$$

$$-V_x = LI_t + RI,$$



where  $C$  is the capacitance,  $G$  is the conductance,  $L$  is the inductance and  $R$  is the resistance.

**a)** Show that both  $I$  and  $V$  satisfy a damped wave equation.

**b)** Find the relationship between the physical constants,  $C$ ,  $G$ ,  $L$  and  $R$  such that there exist damped traveling wave solutions of the form:

$$V(x, t) = e^{-\gamma t}(f(x - at) + g(x + at)).$$

What is the wave speed?

## 41.2 Hints

### Hint 41.1

### Hint 41.2

### Hint 41.3

### Hint 41.4

### Hint 41.5

From physical considerations conclude that you can take  $\alpha(\xi) = 0$ . Your solution will corroborate this. Use the initial conditions to determine  $\alpha(\xi)$  and  $\beta(\xi)$  for  $\xi > 0$ . Then use the initial condition to determine  $\beta(\xi)$  for  $\xi < 0$ .

### Hint 41.6

### Hint 41.7

- a) Substitute  $u(x, t) = \Re(A e^{i\omega t - \alpha x})$  into the partial differential equation and solve for  $\alpha$ . Assume that  $\alpha$  has positive real part so that the solution vanishes as  $x \rightarrow +\infty$ .

### Hint 41.8

Seek a periodic solution of the form,

$$u(r, \theta, t) = v(r, \theta) e^{i\omega t}.$$

Solve the Helmholtz equation for  $v$  with a Fourier series expansion,

$$v(r, \theta) = \sum_{n=-\infty}^{\infty} v_n(r) e^{in\theta}.$$

You will find that the  $v_n$  satisfy Bessel's equation. Choose the  $v_n$  so that  $u$  satisfies the boundary condition at  $r = a$  and the radiation condition at infinity.

The Bessel functions have the asymptotic behavior,

$$J_n(\rho) \sim \sqrt{\frac{2}{\pi\rho}} \cos(\rho - n\pi/2 - \pi/4), \quad \text{as } \rho \rightarrow \infty,$$

$$Y_n(\rho) \sim \sqrt{\frac{2}{\pi\rho}} \sin(\rho - n\pi/2 - \pi/4), \quad \text{as } \rho \rightarrow \infty,$$

$$H_n^{(1)}(\rho) \sim \sqrt{\frac{2}{\pi\rho}} e^{i(\rho - n\pi/2 - \pi/4)}, \quad \text{as } \rho \rightarrow \infty,$$

$$H_n^{(2)}(\rho) \sim \sqrt{\frac{2}{\pi\rho}} e^{-i(\rho - n\pi/2 - \pi/4)}, \quad \text{as } \rho \rightarrow \infty.$$

**Hint 41.9**

**Hint 41.10**

## 41.3 Solutions

### Solution 41.1

1. The initial position is

$$u(x, 0) = H\left(\frac{1}{2} - \left|x - \frac{3}{2}\right|\right).$$

We extend the domain of the problem to  $(-\infty \dots \infty)$  and add image sources in the initial condition so that  $u(x, 0)$  is odd about  $x = 0$  and  $x = 4$ . This enforces the boundary conditions at these two points.

$$u_{tt} - u_{xx} = 0, \quad x \in (-\infty \dots \infty), \quad t \in (0 \dots \infty)$$

$$u(x, 0) = \sum_{n=-\infty}^{\infty} \left( H\left(\frac{1}{2} - \left|x - \frac{3}{2} - 8n\right|\right) - H\left(\frac{1}{2} - \left|x - \frac{13}{2} - 8n\right|\right) \right), \quad u_t(x, 0) = 0$$

We use D'Alembert's solution to solve this problem.

$$u(x, t) = \frac{1}{2} \sum_{n=-\infty}^{\infty} \left( H\left(\frac{1}{2} - \left|x - \frac{3}{2} - 8n - t\right|\right) + H\left(\frac{1}{2} - \left|x - \frac{3}{2} - 8n + t\right|\right) \right. \\ \left. - H\left(\frac{1}{2} - \left|x - \frac{13}{2} - 8n - t\right|\right) - H\left(\frac{1}{2} - \left|x - \frac{13}{2} - 8n + t\right|\right) \right)$$

The solution for several times is plotted in Figure 41.1. Note that the solution is periodic in time with period 8. Figure 41.3 shows the solution in the phase plane for  $0 < t < 8$ . Note the odd reflections at the boundaries.

2. The initial position is

$$u(x, 0) = H\left(\frac{1}{2} - \left|x - \frac{3}{2}\right|\right).$$

We extend the domain of the problem to  $(-\infty \dots \infty)$  and add image sources in the initial condition so that

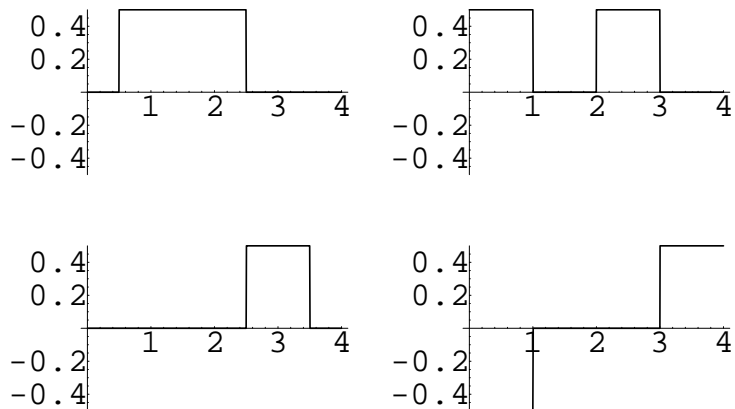

Figure 41.1: The solution at  $t = 1/2, 1, 3/2, 2$  for the boundary conditions  $u(0, t) = u(4, t) = 0$ .

$u(x, 0)$  is even about  $x = 0$  and  $x = 4$ . This enforces the boundary conditions at these two points.

$$u_{tt} - u_{xx} = 0, \quad x \in (-\infty \dots \infty), \quad t \in (0 \dots \infty)$$

$$u(x, 0) = \sum_{n=-\infty}^{\infty} \left( H \left( \frac{1}{2} - \left| x - \frac{3}{2} - 8n \right| \right) + H \left( \frac{1}{2} - \left| x - \frac{13}{2} - 8n \right| \right) \right), \quad u_t(x, 0) = 0$$

We use D'Alemberts solution to solve this problem.

$$u(x, t) = \frac{1}{2} \sum_{n=-\infty}^{\infty} \left( H \left( \frac{1}{2} - \left| x - \frac{3}{2} - 8n - t \right| \right) + H \left( \frac{1}{2} - \left| x - \frac{3}{2} - 8n + t \right| \right) \right. \\ \left. + H \left( \frac{1}{2} - \left| x - \frac{13}{2} - 8n - t \right| \right) + H \left( \frac{1}{2} - \left| x - \frac{13}{2} - 8n + t \right| \right) \right)$$

The solution for several times is plotted in Figure 41.2. Note that the solution is periodic in time with period 8. Figure 41.3 shows the solution in the phase plane for  $0 < t < 8$ . Note the even reflections at the boundaries.

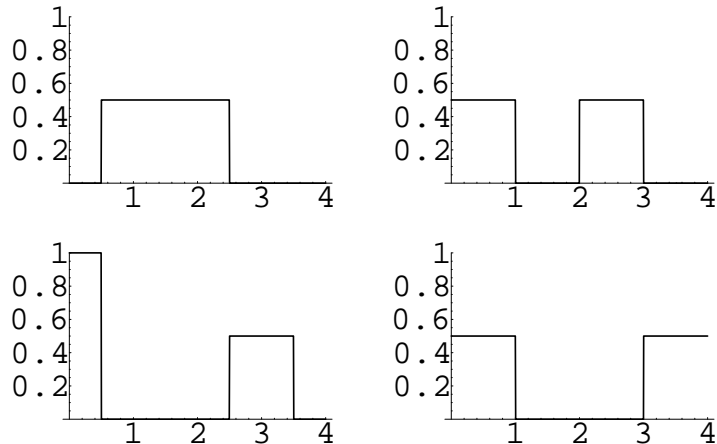

Figure 41.2: The solution at  $t = 1/2, 1, 3/2, 2$  for the boundary conditions  $u_x(0, t) = u_x(4, t) = 0$ .

## Solution 41.2

1.

$$u(x, t) = \frac{1}{2} (u(x + ct, 0) + u(x - ct, 0)) + \frac{1}{2c} \int_{x-ct}^{x+ct} u_t(\tau, 0) d\tau$$

$$u(x, t) = \frac{1}{2c} \int_{x-ct}^{x+ct} \sin(\omega\tau) d\tau$$

$$u(x, t) = \frac{\sin(\omega x) \sin(\omega ct)}{\omega c}$$

Figure 41.4 shows the solution for  $c = \omega = 1$ .

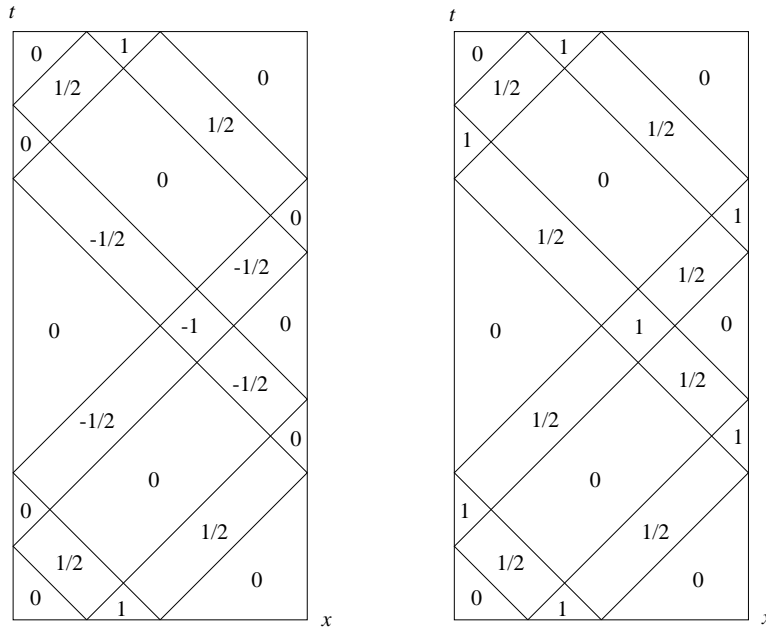

Figure 41.3: The solution in the phase plane for the boundary conditions  $u(0, t) = u(4, t) = 0$  and  $u_x(0, t) = u_x(4, t) = 0$ .

2. We can write the initial velocity in terms of the Heaviside function.

$$u_t(x, 0) = \begin{cases} 1 & \text{for } 0 < x < 1 \\ -1 & \text{for } -1 < x < 0 \\ 0 & \text{for } |x| > 1. \end{cases}$$

$$u_t(x, 0) = -H(x + 1) + 2H(x) - H(x - 1)$$

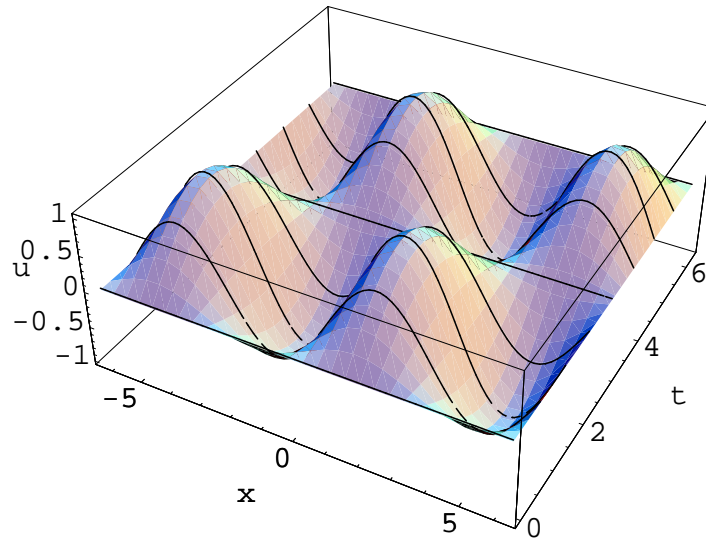

Figure 41.4: Solution of the wave equation.

We integrate the Heaviside function.

$$\int_a^b H(x - c) dx = \begin{cases} 0 & \text{for } b < c \\ b - a & \text{for } a > c \\ b - c & \text{otherwise} \end{cases}$$

If  $a < b$ , we can express this as

$$\int_a^b H(x - c) dx = \min(b - a, \max(b - c, 0)).$$



Now we find an expression for the solution.

$$u(x, t) = \frac{1}{2} (u(x + ct, 0) + u(x - ct, 0)) + \frac{1}{2c} \int_{x-ct}^{x+ct} u_t(\tau, 0) d\tau$$

$$u(x, t) = \frac{1}{2c} \int_{x-ct}^{x+ct} (-H(\tau + 1) + 2H(\tau) - H(\tau - 1)) d\tau$$

$$u(x, t) = -\min(2ct, \max(x + ct + 1, 0)) + 2\min(2ct, \max(x + ct, 0)) - \min(2ct, \max(x + ct - 1, 0))$$

Figure 41.5 shows the solution for  $c = 1$ .

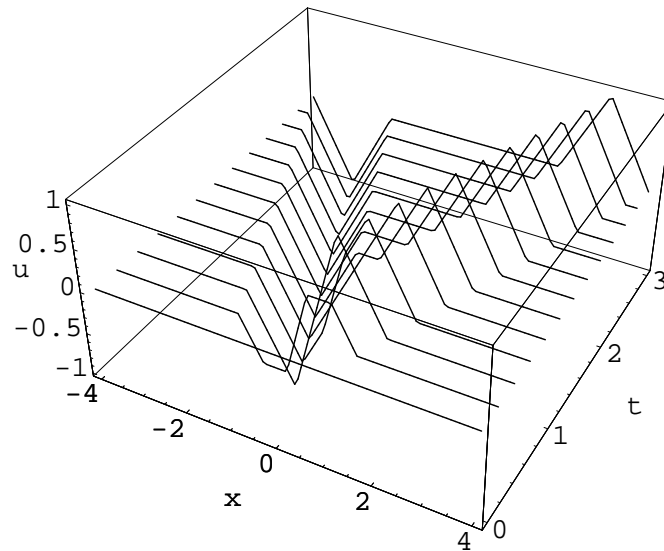

Figure 41.5: Solution of the wave equation.

### Solution 41.3

1. The solution on the interval  $(-\infty \dots \infty)$  is

$$u(x, t) = \frac{1}{2}(h(x + ct) + h(x - ct)).$$

Now we solve the problem on  $(0 \dots \infty)$ . We define the odd extension of  $h(x)$ .

$$\hat{h}(x) = \begin{cases} h(x) & \text{for } x > 0, \\ -h(-x) & \text{for } x < 0, \end{cases} = \text{sign}(x)h(|x|)$$

Note that

$$\hat{h}'(0^-) = \frac{d}{dx}(-h(-x))\Big|_{x \rightarrow 0^+} = h'(0^+) = \hat{h}'(0^+).$$

Thus  $\hat{h}(x)$  is piecewise  $C^2$ . Clearly

$$u(x, t) = \frac{1}{2}(\hat{h}(x + ct) + \hat{h}(x - ct))$$

satisfies the differential equation on  $(0 \dots \infty)$ . We verify that it satisfies the initial condition and boundary condition.

$$\begin{aligned} u(x, 0) &= \frac{1}{2}(\hat{h}(x) + \hat{h}(x)) = h(x) \\ u(0, t) &= \frac{1}{2}(\hat{h}(ct) + \hat{h}(-ct)) = \frac{1}{2}(h(ct) - h(ct)) = 0 \end{aligned}$$

2. First we define the odd extension of  $h(x)$  on the interval  $(-l \dots l)$ .

$$\hat{h}(x) = \text{sign}(x)h(|x|), \quad x \in (-l \dots l)$$

Then we form the odd periodic extension of  $h(x)$  defined on  $(-\infty \dots \infty)$ .

$$\hat{h}(x) = \text{sign}\left(x - 2l \left\lfloor \frac{x+l}{2l} \right\rfloor\right) h\left(\left|x - 2l \left\lfloor \frac{x+l}{2l} \right\rfloor\right|\right), \quad x \in (-\infty \dots \infty)$$

We note that  $\hat{h}(x)$  is piecewise  $C^2$ . Also note that  $\hat{h}(x)$  is odd about the points  $x = nl$ ,  $n \in \mathbb{Z}$ . That is,  $\hat{h}(nl - x) = -\hat{h}(nl + x)$ . Clearly

$$u(x, t) = \frac{1}{2}(\hat{h}(x + ct) + \hat{h}(x - ct))$$

satisfies the differential equation on  $(0 \dots l)$ . We verify that it satisfies the initial condition and boundary conditions.

$$u(x, 0) = \frac{1}{2}(\hat{h}(x) + \hat{h}(x))$$

$$u(x, 0) = \hat{h}(x)$$

$$u(x, 0) = \text{sign} \left( x - 2l \left\lfloor \frac{x+l}{2l} \right\rfloor \right) h \left( \left| x - 2l \left\lfloor \frac{x+l}{2l} \right\rfloor \right| \right)$$

$$u(x, 0) = h(x)$$

$$u(0, t) = \frac{1}{2}(\hat{h}(ct) + \hat{h}(-ct)) = \frac{1}{2}(\hat{h}(ct) - \hat{h}(ct)) = 0$$

$$u(l, t) = \frac{1}{2}(\hat{h}(l + ct) + \hat{h}(l - ct)) = \frac{1}{2}(\hat{h}(l + ct) - \hat{h}(l + ct)) = 0$$

#### Solution 41.4

**Change of Variables.** Let  $u(x, t)$  be the solution of the problem with deflection  $u(x, T) = \phi(x)$  and velocity  $u_t(x, T) = \psi(x)$ . Define

$$v(x, \tau) = u(x, T - \tau).$$

We note that  $u(x, 0) = v(x, T)$ .  $v(\tau)$  satisfies the wave equation.

$$v_{\tau\tau} = c^2 v_{xx}$$

The initial conditions for  $v$  are

$$v(x, 0) = u(x, T) = \phi(x), \quad v_\tau(x, 0) = -u_t(x, T) = -\psi(x).$$

Thus we see that the student was correct.

**Direct Solution.** D'Alembert's solution is valid for all  $x$  and  $t$ . We formally substitute  $t - T$  for  $t$  in this solution to solve the problem with deflection  $u(x, T) = \phi(x)$  and velocity  $u_t(x, T) = \psi(x)$ .

$$u(x, t) = \frac{1}{2} (\phi(x + c(t - T)) + \phi(x - c(t - T))) + \frac{1}{2c} \int_{x-c(t-T)}^{x+c(t-T)} \psi(\tau) d\tau$$

This satisfies the wave equation, because the equation is shift-invariant. It also satisfies the initial conditions.

$$\begin{aligned} u(x, T) &= \frac{1}{2} (\phi(x) + \phi(x)) + \frac{1}{2c} \int_x^x \psi(\tau) d\tau = \phi(x) \\ u_t(x, t) &= \frac{1}{2} (c\phi'(x + c(t - T)) - c\phi'(x - c(t - T))) + \frac{1}{2} (\psi(x + c(t - T)) + \psi(x - c(t - T))) \\ u_t(x, T) &= \frac{1}{2} (c\phi'(x) - c\phi'(x)) + \frac{1}{2} (\psi(x) + \psi(x)) = \psi(x) \end{aligned}$$

### Solution 41.5

Since the solution is a wave moving to the right, we conclude that we could take  $\alpha(\xi) = 0$ . Our solution will corroborate this.

The form of the solution is

$$u(x, t) = \alpha(x + ct) + \beta(x - ct).$$

We substitute the solution into the initial conditions.

$$\begin{aligned} u(x, 0) &= \alpha(\xi) + \beta(\xi) = 0, \quad \xi > 0 \\ u_t(x, 0) &= c\alpha'(\xi) - c\beta'(\xi) = 0, \quad \xi > 0 \end{aligned}$$

We integrate the second equation to obtain the system

$$\begin{aligned} \alpha(\xi) + \beta(\xi) &= 0, \quad \xi > 0, \\ \alpha(\xi) - \beta(\xi) &= 2k, \quad \xi > 0, \end{aligned}$$

which has the solution

$$\alpha(\xi) = k, \quad \beta(\xi) = -k, \quad \xi > 0.$$

Now we substitute the solution into the initial condition.

$$\begin{aligned}u(0, t) &= \alpha(ct) + \beta(-ct) = \gamma(t), \quad t > 0 \\ \alpha(\xi) + \beta(-\xi) &= \gamma(\xi/c), \quad \xi > 0 \\ \beta(\xi) &= \gamma(-\xi/c) - k, \quad \xi < 0\end{aligned}$$

This determines  $u(x, t)$  for  $x > 0$  as it depends on  $\alpha(\xi)$  only for  $\xi > 0$ . The constant  $k$  is arbitrary. Changing  $k$  does not change  $u(x, t)$ . For simplicity, we take  $k = 0$ .

$$\begin{aligned}u(x, t) &= \beta(x - ct) \\ u(x, t) &= \begin{cases} 0 & \text{for } x - ct < 0 \\ \gamma(t - x/c) & \text{for } x - ct > 0 \end{cases} \\ \boxed{u(x, t) = \gamma(t - x/c)H(ct - x)}\end{aligned}$$

### Solution 41.6

1. We write the value of  $u$  along the line  $x - ct = k$  as a function of  $t$ :  $u(k + ct, t)$ . We differentiate  $u_t - cu_x$  with respect to  $t$  to see how the quantity varies.

$$\begin{aligned}\frac{d}{dt} (u_t(k + ct, t) - cu_x(k + ct, t)) &= cu_{xt} + u_{tt} - c^2u_{xx} - cu_{xt} \\ &= u_{tt} - c^2u_{xx} \\ &= 0\end{aligned}$$

Thus  $u_t - cu_x$  is constant along the line  $x - ct = k$ . Now we examine  $u_t + cu_x$  along the line  $x + ct = k$ .

$$\begin{aligned}\frac{d}{dt} (u_t(k - ct, t) + cu_x(k - ct, t)) &= -cu_{xt} + u_{tt} - c^2u_{xx} + cu_{xt} \\ &= u_{tt} - c^2u_{xx} \\ &= 0\end{aligned}$$

$u_t + cu_x$  is constant along the line  $x + ct = k$ .

2. From part (a) we know

$$\begin{aligned}u_t(x_0, t_0) - cu_x(x_0, t_0) &= u_t(x_0 - ct_0, 0) - cu_x(x_0 - ct_0, 0) \\u_t(x_0, t_0) + cu_x(x_0, t_0) &= u_t(x_0 + ct_0, 0) + cu_x(x_0 + ct_0, 0).\end{aligned}$$

We add these equations to find  $u_t(x_0, t_0)$ .

$$u_t(x_0, t_0) = \frac{1}{2} (u_t(x_0 - ct_0, 0) - cu_x(x_0 - ct_0, 0) + u_t(x_0 + ct_0, 0) + cu_x(x_0 + ct_0, 0))$$

Since  $t_0$  was arbitrary, we have

$$u_t(x_0, \tau) = \frac{1}{2} (u_t(x_0 - c\tau, 0) - cu_x(x_0 - c\tau, 0) + u_t(x_0 + c\tau, 0) + cu_x(x_0 + c\tau, 0))$$

for  $0 < \tau < t_0$ . We integrate with respect to  $\tau$  to determine  $u(x_0, t_0)$ .

$$\begin{aligned}u(x_0, t_0) &= u(x_0, 0) + \int_0^{t_0} \frac{1}{2} (u_t(x_0 - c\tau, 0) - cu_x(x_0 - c\tau, 0) + u_t(x_0 + c\tau, 0) + cu_x(x_0 + c\tau, 0)) d\tau \\&= u(x_0, 0) + \frac{1}{2} \int_0^{t_0} (-cu_x(x_0 - c\tau, 0) + cu_x(x_0 + c\tau, 0)) d\tau \\&\quad + \frac{1}{2} \int_0^{t_0} (u_t(x_0 - c\tau, 0) + u_t(x_0 + c\tau, 0)) d\tau \\&= u(x_0, 0) + \frac{1}{2} (u(x_0 - ct_0, 0) - u(x_0, 0) + u(x_0 + ct_0, 0) - u(x_0, 0)) \\&\quad + \frac{1}{2c} \int_{x_0}^{x_0 - ct_0} -u_t(\tau, 0) d\tau + \frac{1}{2c} \int_{x_0}^{x_0 + ct_0} u_t(\tau, 0) d\tau \\&= \frac{1}{2} (u(x_0 - ct_0, 0) + u(x_0 + ct_0, 0)) + \frac{1}{2c} \int_{x_0 - ct_0}^{x_0 + ct_0} u_t(\tau, 0) d\tau\end{aligned}$$

We have D'Alembert's solution.

$$u(x, t) = \frac{1}{2} (u(x - ct, 0) + u(x + ct, 0)) + \frac{1}{2c} \int_{x-ct}^{x+ct} u_t(\tau, 0) d\tau$$

### Solution 41.7

- a) We substitute  $u(x, t) = A e^{i\omega t - \alpha x}$  into the partial differential equation and take the real part as the solution. We assume that  $\alpha$  has positive real part so the solution vanishes as  $x \rightarrow +\infty$ .

$$i\omega A e^{i\omega t - \alpha x} = \kappa \alpha^2 A e^{i\omega t - \alpha x}$$

$$i\omega = \kappa \alpha^2$$

$$\alpha = (1 + i) \sqrt{\frac{\omega}{2\kappa}}$$

A solution of the partial differential equation is,

$$u(x, t) = \Re \left( A \exp \left( i\omega t - (1 + i) \sqrt{\frac{\omega}{2\kappa}} x \right) \right),$$

$$u(x, t) = A \exp \left( -\sqrt{\frac{\omega}{2\kappa}} x \right) \cos \left( \omega t - \sqrt{\frac{\omega}{2\kappa}} x \right).$$

Applying the initial condition,  $u(0, t) = T \cos(\omega t)$ , we obtain,

$$u(x, t) = T \exp \left( -\sqrt{\frac{\omega}{2\kappa}} x \right) \cos \left( \omega t - \sqrt{\frac{\omega}{2\kappa}} x \right).$$

- b) At a fixed depth  $x = h$ , the temperature is

$$u(h, t) = T \exp \left( -\sqrt{\frac{\omega}{2\kappa}} h \right) \cos \left( \omega t - \sqrt{\frac{\omega}{2\kappa}} h \right).$$

Thus the temperature variation is

$$-T \exp \left( -\sqrt{\frac{\omega}{2\kappa}} h \right) \leq u(h, t) \leq T \exp \left( -\sqrt{\frac{\omega}{2\kappa}} h \right).$$

- c) The solution is an exponentially decaying, traveling wave that propagates into the Earth with speed  $\omega/\sqrt{\omega/(2\kappa)} = \sqrt{2\kappa\omega}$ . More generally, the wave

$$e^{-bt} \cos(\omega t - ax)$$

travels in the positive direction with speed  $\omega/a$ . Figure 41.6 shows such a wave for a sequence of times.

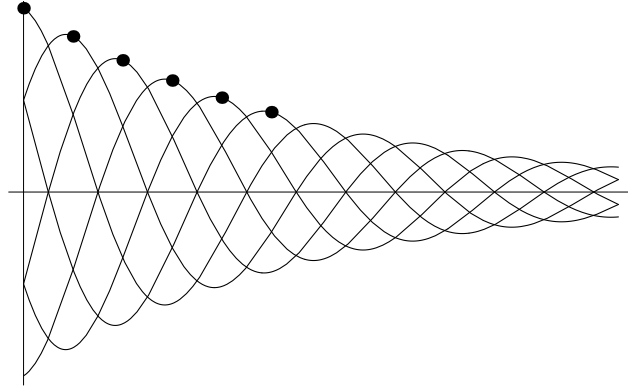

Figure 41.6: An Exponentially Decaying, Traveling Wave

The phase lag,  $\delta(x)$  is the time that it takes for the wave to reach a depth of  $x$ . It satisfies,

$$\omega\delta(x) - \sqrt{\frac{\omega}{2\kappa}}x = 0,$$

$$\delta(x) = \frac{x}{\sqrt{2\kappa\omega}}.$$

- d) Let  $\omega_{\text{year}}$  be the frequency for annual temperature variation, then  $\omega_{\text{day}} = 365\omega_{\text{year}}$ . If  $x_{\text{year}}$  is the depth that a particular yearly temperature variation reaches and  $x_{\text{day}}$  is the depth that this same variation in daily temperature reaches, then

$$\exp\left(-\sqrt{\frac{\omega_{\text{year}}}{2\kappa}}x_{\text{year}}\right) = \exp\left(-\sqrt{\frac{\omega_{\text{day}}}{2\kappa}}x_{\text{day}}\right),$$



$$\sqrt{\frac{\omega_{\text{year}}}{2\kappa}} x_{\text{year}} = \sqrt{\frac{\omega_{\text{day}}}{2\kappa}} x_{\text{day}},$$

$$\boxed{\frac{x_{\text{year}}}{x_{\text{day}}} = \sqrt{365}.}$$

### Solution 41.8

We seek a periodic solution of the form,

$$u(r, \theta, t) = v(r, \theta) e^{i\omega t}.$$

Substituting this into the wave equation will give us a Helmholtz equation for  $v$ .

$$-\omega^2 v = c^2 \Delta v$$

$$v_{rr} + \frac{1}{r} v_r + \frac{1}{r^2} v_{\theta\theta} + \frac{\omega^2}{c^2} v = 0$$

We have the boundary condition  $v(a, \theta) = f(\theta)$  and the radiation condition at infinity. We expand  $v$  in a Fourier series in  $\theta$  in which the coefficients are functions of  $r$ . You can check that  $e^{in\theta}$  are the eigenfunctions obtained with separation of variables.

$$v(r, \theta) = \sum_{n=-\infty}^{\infty} v_n(r) e^{in\theta}$$

We substitute this expression into the Helmholtz equation to obtain ordinary differential equations for the coefficients  $v_n$ .

$$\sum_{n=-\infty}^{\infty} \left( v_n'' + \frac{1}{r} v_n' + \left( \frac{\omega^2}{c^2} - \frac{n^2}{r^2} \right) v_n \right) e^{in\theta} = 0$$

The differential equations for the  $v_n$  are

$$v_n'' + \frac{1}{r} v_n' + \left( \frac{\omega^2}{c^2} - \frac{n^2}{r^2} \right) v_n = 0.$$

which has as linearly independent solutions the Bessel and Neumann functions,

$$J_n\left(\frac{\omega r}{c}\right), \quad Y_n\left(\frac{\omega r}{c}\right),$$

or the Hankel functions,

$$H_n^{(1)}\left(\frac{\omega r}{c}\right), \quad H_n^{(2)}\left(\frac{\omega r}{c}\right).$$

The functions have the asymptotic behavior,

$$J_n(\rho) \sim \sqrt{\frac{2}{\pi\rho}} \cos(\rho - n\pi/2 - \pi/4), \quad \text{as } \rho \rightarrow \infty,$$

$$Y_n(\rho) \sim \sqrt{\frac{2}{\pi\rho}} \sin(\rho - n\pi/2 - \pi/4), \quad \text{as } \rho \rightarrow \infty,$$

$$H_n^{(1)}(\rho) \sim \sqrt{\frac{2}{\pi\rho}} e^{i(\rho - n\pi/2 - \pi/4)}, \quad \text{as } \rho \rightarrow \infty,$$

$$H_n^{(2)}(\rho) \sim \sqrt{\frac{2}{\pi\rho}} e^{-i(\rho - n\pi/2 - \pi/4)}, \quad \text{as } \rho \rightarrow \infty.$$

$u(r, \theta, t)$  will be an outgoing wave at infinity if it is the sum of terms of the form  $e^{i(\omega t - \text{const}r)}$ . Thus the  $v_n$  must have the form

$$v_n(r) = b_n H_n^{(2)}\left(\frac{\omega r}{c}\right)$$

for some constants,  $b_n$ . The solution for  $v(r, \theta)$  is

$$v(r, \theta) = \sum_{n=-\infty}^{\infty} b_n H_n^{(2)}\left(\frac{\omega r}{c}\right) e^{in\theta}.$$

We determine the constants  $b_n$  from the boundary condition at  $r = a$ .

$$v(a, \theta) = \sum_{n=-\infty}^{\infty} b_n H_n^{(2)}\left(\frac{\omega a}{c}\right) e^{in\theta} = f(\theta)$$

$$b_n = \frac{1}{2\pi H_n^{(2)}(\omega a/c)} \int_0^{2\pi} f(\theta) e^{-in\theta} d\theta$$

$$u(r, \theta, t) = e^{i\omega t} \sum_{n=-\infty}^{\infty} b_n H_n^{(2)}\left(\frac{\omega r}{c}\right) e^{in\theta}$$

### Solution 41.9

We substitute the form  $v(x, y, t) = u(r, \theta) e^{-i\omega t}$  into the wave equation to obtain a Helmholtz equation.

$$\begin{aligned} c^2 \Delta u + \omega^2 u &= 0 \\ u_{rr} + \frac{1}{r} u_r + \frac{1}{r^2} u_{\theta\theta} + k^2 u &= 0 \end{aligned}$$

We solve the Helmholtz equation with separation of variables. We expand  $u$  in a Fourier series.

$$u(r, \theta) = \sum_{n=-\infty}^{\infty} u_n(r) e^{in\theta}$$

We substitute the sum into the Helmholtz equation to determine ordinary differential equations for the coefficients.

$$u_n'' + \frac{1}{r} u_n' + \left(k^2 - \frac{n^2}{r^2}\right) u_n = 0$$

This is Bessel's equation, which has as solutions the Bessel and Neumann functions,  $\{J_n(kr), Y_n(kr)\}$  or the Hankel functions,  $\{H_n^{(1)}(kr), H_n^{(2)}(kr)\}$ .

Recall that the solutions of the Bessel equation have the asymptotic behavior,

$$J_n(\rho) \sim \sqrt{\frac{2}{\pi\rho}} \cos(\rho - n\pi/2 - \pi/4), \quad \text{as } \rho \rightarrow \infty,$$

$$Y_n(\rho) \sim \sqrt{\frac{2}{\pi\rho}} \sin(\rho - n\pi/2 - \pi/4), \quad \text{as } \rho \rightarrow \infty,$$

$$H_n^{(1)}(\rho) \sim \sqrt{\frac{2}{\pi\rho}} e^{i(\rho - n\pi/2 - \pi/4)}, \quad \text{as } \rho \rightarrow \infty,$$

$$H_n^{(2)}(\rho) \sim \sqrt{\frac{2}{\pi\rho}} e^{-i(\rho - n\pi/2 - \pi/4)}, \quad \text{as } \rho \rightarrow \infty.$$

From this we see that only the Hankel function of the first kind will give us outgoing waves as  $\rho \rightarrow \infty$ . Our solution for  $u$  becomes,

$$u(r, \theta) = \sum_{n=-\infty}^{\infty} b_n H_n^{(1)}(kr) e^{in\theta}.$$

We determine the coefficients in the expansion from the boundary condition at  $r = a$ .

$$u(a, \theta) = \sum_{n=-\infty}^{\infty} b_n H_n^{(1)}(ka) e^{in\theta} = -e^{ika \cos \theta}$$

$$b_n = -\frac{1}{2\pi H_n^{(1)}(ka)} \int_0^{2\pi} e^{ika \cos \theta} e^{-in\theta} d\theta$$

We evaluate the integral with the identities,

$$J_n(x) = \frac{1}{2\pi i^n} \int_0^{2\pi} e^{ix \cos \theta} e^{in\theta} d\theta,$$

$$J_{-n}(x) = (-1)^n J_n(x).$$

Thus we obtain,

$$u(r, \theta) = - \sum_{n=-\infty}^{\infty} \frac{(-i)^n J_n(ka)}{H_n^{(1)}(ka)} H_n^{(1)}(kr) e^{in\theta}.$$

When  $a \ll 1/k$ , i.e.  $ka \ll 1$ , the Bessel function has the behavior,

$$J_n(ka) \sim \frac{(ka/2)^n}{n!}.$$

In this case, the  $n \neq 0$  terms in the sum are much smaller than the  $n = 0$  term. The approximate solution is,

$$u(r, \theta) \sim - \frac{H_0^{(1)}(kr)}{H_0^{(1)}(ka)},$$

$$v(r, \theta, t) \sim - \frac{H_0^{(1)}(kr)}{H_0^{(1)}(ka)} e^{-i\omega t}.$$

## Solution 41.10

a)

$$\begin{cases} -I_x = CV_t + GV, \\ -V_x = LI_t + RI \end{cases}$$

First we derive a single partial differential equation for  $I$ . We differentiate the two partial differential equations with respect to  $x$  and  $t$ , respectively and then eliminate the  $V_{xt}$  terms.

$$\begin{cases} -I_{xx} = CV_{tx} + GV_x, \\ -V_{xt} = LI_{tt} + RI_t \end{cases}$$

$$-I_{xx} + LCI_{tt} + RCI_t = GV_x$$

We use the initial set of equations to write  $V_x$  in terms of  $I$ .

$$-I_{xx} + LC I_{tt} + RC I_t + G(LI_t + RI) = 0$$

$$\boxed{I_{tt} + \frac{RC + GL}{LC} I_t + \frac{GR}{LC} I - \frac{1}{LC} I_{xx} = 0}$$

Now we derive a single partial differential equation for  $V$ . We differentiate the two partial differential equations with respect to  $t$  and  $x$ , respectively and then eliminate the  $I_{xt}$  terms.

$$\begin{cases} -I_{xt} = CV_{tt} + GV_t, \\ -V_{xx} = LI_{tx} + RI_x \end{cases}$$

$$-V_{xx} = RI_x - LCV_{tt} - LGV_t$$

We use the initial set of equations to write  $I_x$  in terms of  $V$ .

$$LCV_{tt} + LGV_t - V_{xx} + R(CV_t + GV) = 0$$

$$\boxed{V_{tt} + \frac{RC + LG}{LC} V_t + \frac{RG}{LC} V - \frac{1}{LC} V_{xx} = 0.}$$

Thus we see that  $I$  and  $V$  both satisfy the same damped wave equation.

**b)** We substitute  $V(x, t) = e^{-\gamma t}(f(x - at) + g(x + at))$  into the damped wave equation for  $V$ .

$$\left(\gamma^2 - \frac{RC + LG}{LC}\gamma + \frac{RG}{LC}\right) e^{-\gamma t}(f + g) + \left(-2\gamma + \frac{RC + LG}{LC}\right) a e^{-\gamma t}(-f' + g')$$

$$+ a^2 e^{-\gamma t}(f'' + g'') - \frac{1}{LC} e^{-\gamma t}(f'' + g'') = 0$$

Since  $f$  and  $g$  are arbitrary functions, the coefficients of  $e^{-\gamma t}(f + g)$ ,  $e^{-\gamma t}(-f' + g')$  and  $e^{-\gamma t}(f'' + g'')$  must vanish. This gives us three constraints.

$$a^2 - \frac{1}{LC} = 0, \quad -2\gamma + \frac{RC + LG}{LC} = 0, \quad \gamma^2 - \frac{RC + LG}{LC}\gamma + \frac{RG}{LC} = 0$$

The first equation determines the wave speed to be  $a = 1/\sqrt{LC}$ . We substitute the value of  $\gamma$  from the second equation into the third equation.

$$\gamma = \frac{RC + LG}{2LC}, \quad -\gamma^2 + \frac{RG}{LC} = 0$$

In order for damped waves to propagate, the physical constants must satisfy,

$$\frac{RG}{LC} - \left( \frac{RC + LG}{2LC} \right)^2 = 0,$$

$$4RGLC - (RC + LG)^2 = 0,$$

$$(RC - LG)^2 = 0,$$

$$\boxed{RC = LG.}$$

# Chapter 42

## Similarity Methods

**Introduction.** Consider the partial differential equation (not necessarily linear)

$$F\left(\frac{\partial u}{\partial t}, \frac{\partial u}{\partial x}, u, t, x\right) = 0.$$

Say the solution is

$$u(x, t) = \frac{x}{t} \sin\left(\frac{t^{1/2}}{x^{1/2}}\right).$$

Making the change of variables  $\xi = x/t$ ,  $f(\xi) = u(x, t)$ , we could rewrite this equation as

$$f(\xi) = \xi \sin(\xi^{-1/2}).$$

We see now that if we had guessed that the solution of this partial differential equation was only dependent on powers of  $x/t$  we could have changed variables to  $\xi$  and  $f$  and instead solved the ordinary differential equation

$$G\left(\frac{df}{d\xi}, f, \xi\right) = 0.$$

By using similarity methods one can reduce the number of independent variables in some PDE's.



**Example 42.0.1** Consider the partial differential equation

$$x \frac{\partial u}{\partial t} + t \frac{\partial u}{\partial x} - u = 0.$$

One way to find a similarity variable is to introduce a transformation to the temporary variables  $u'$ ,  $t'$ ,  $x'$ , and the parameter  $\lambda$ .

$$\begin{aligned} u &= u' \lambda \\ t &= t' \lambda^m \\ x &= x' \lambda^n \end{aligned}$$

where  $n$  and  $m$  are unknown. Rewriting the partial differential equation in terms of the temporary variables,

$$\begin{aligned} x' \lambda^n \frac{\partial u'}{\partial t'} \lambda^{1-m} + t' \lambda^m \frac{\partial u'}{\partial x'} \lambda^{1-n} - u' \lambda &= 0 \\ x' \frac{\partial u'}{\partial t'} \lambda^{-m+n} + t' \frac{\partial u'}{\partial x'} \lambda^{m-n} - u' &= 0 \end{aligned}$$

There is a similarity variable if  $\lambda$  can be eliminated from the equation. Equating the coefficients of the powers of  $\lambda$  in each term,

$$-m + n = m - n = 0.$$

This has the solution  $m = n$ . The similarity variable,  $\xi$ , will be unchanged under the transformation to the temporary variables. One choice is

$$\xi = \frac{t}{x} = \frac{t' \lambda^n}{x' \lambda^m} = \frac{t'}{x'}.$$

Writing the two partial derivative in terms of  $\xi$ ,

$$\begin{aligned} \frac{\partial}{\partial t} &= \frac{\partial \xi}{\partial t} \frac{d}{d\xi} = \frac{1}{x} \frac{d}{d\xi} \\ \frac{\partial}{\partial x} &= \frac{\partial \xi}{\partial x} \frac{d}{d\xi} = -\frac{t}{x^2} \frac{d}{d\xi} \end{aligned}$$

The partial differential equation becomes

$$\frac{du}{d\xi} - \xi^2 \frac{du}{d\xi} - u = 0$$
$$\frac{du}{d\xi} = \frac{u}{1 - \xi^2}$$

Thus we have reduced the partial differential equation to an ordinary differential equation that is much easier to solve.

$$u(\xi) = \exp\left(\int^\xi \frac{d\xi}{1 - \xi^2}\right)$$
$$u(\xi) = \exp\left(\int^\xi \frac{1/2}{1 - \xi} + \frac{1/2}{1 + \xi} d\xi\right)$$
$$u(\xi) = \exp\left(-\frac{1}{2} \log(1 - \xi) + \frac{1}{2} \log(1 + \xi)\right)$$
$$u(\xi) = (1 - \xi)^{-1/2} (1 + \xi)^{1/2}$$
$$u(x, t) = \left(\frac{1 + t/x}{1 - t/x}\right)^{1/2}$$

Thus we have found a similarity solution to the partial differential equation. Note that the existence of a similarity solution does not mean that all solutions of the differential equation are similarity solutions.

**Another Method.** Another method is to substitute  $\xi = x^\alpha t$  and determine if there is an  $\alpha$  that makes  $\xi$  a similarity variable. The partial derivatives become

$$\frac{\partial}{\partial t} = \frac{\partial \xi}{\partial t} \frac{d}{d\xi} = x^\alpha \frac{d}{d\xi}$$
$$\frac{\partial}{\partial x} = \frac{\partial \xi}{\partial x} \frac{d}{d\xi} = \alpha x^{\alpha-1} t \frac{d}{d\xi}$$

The partial differential equation becomes

$$x^{\alpha+1} \frac{du}{d\xi} + \alpha x^{\alpha-1} t^2 \frac{du}{d\xi} - u = 0.$$

If there is a value of  $\alpha$  such that we can write this equation in terms of  $\xi$ , then  $\xi = x^\alpha t$  is a similarity variable. If  $\alpha = -1$  then the coefficient of the first term is trivially in terms of  $\xi$ . The coefficient of the second term then becomes  $-x^{-2}t^2$ . Thus we see  $\xi = x^{-1}t$  is a similarity variable.

**Example 42.0.2** To see another application of similarity variables, any partial differential equation of the form

$$F\left(tx, u, \frac{u_t}{x}, \frac{u_x}{t}\right) = 0$$

is equivalent to the ODE

$$F\left(\xi, u, \frac{du}{d\xi}, \frac{du}{d\xi}\right) = 0$$

where  $\xi = tx$ . Performing the change of variables,

$$\begin{aligned} \frac{1}{x} \frac{\partial u}{\partial t} &= \frac{1}{x} \frac{\partial \xi}{\partial t} \frac{du}{d\xi} = \frac{1}{x} \frac{du}{d\xi} = \frac{du}{d\xi} \\ \frac{1}{t} \frac{\partial u}{\partial x} &= \frac{1}{t} \frac{\partial \xi}{\partial x} \frac{du}{d\xi} = \frac{1}{t} \frac{du}{d\xi} = \frac{du}{d\xi}. \end{aligned}$$

For example the partial differential equation

$$u \frac{\partial u}{\partial t} + \frac{x}{t} \frac{\partial u}{\partial x} + tx^2 u = 0$$

which can be rewritten

$$u \frac{1}{x} \frac{\partial u}{\partial t} + \frac{1}{t} \frac{\partial u}{\partial x} + txu = 0,$$

is equivalent to

$$u \frac{du}{d\xi} + \frac{du}{d\xi} + \xi u = 0$$

where  $\xi = tx$ .

## 42.1 Exercises

### Exercise 42.1

Consider the 1-D heat equation

$$u_t = \nu u_{xx}$$

Assume that there exists a function  $\eta(x, t)$  such that it is possible to write  $u(x, t) = F(\eta(x, t))$ . Re-write the PDE in terms of  $F(\eta)$ , its derivatives and (partial) derivatives of  $\eta$ . By guessing that this transformation takes the form  $\eta = xt^\alpha$ , find a value of  $\alpha$  so that this reduces to an ODE for  $F(\eta)$  (i.e.  $x$  and  $t$  are explicitly removed). Find the general solution and use this to find the corresponding solution  $u(x, t)$ . Is this the general solution of the PDE?

### Exercise 42.2

With  $\xi = x^\alpha t$ , find  $\alpha$  such that for some function  $f$ ,  $\phi = f(\xi)$  is a solution of

$$\phi_t = a^2 \phi_{xx}.$$

Find  $f(\xi)$  as well.

## 42.2 Hints

Hint 42.1

Hint 42.2

## 42.3 Solutions

### Solution 42.1

We write the derivatives of  $u(x, t)$  in terms of derivatives of  $F(\eta)$ .

$$u_t = \alpha x t^{\alpha-1} F' = \alpha \frac{\eta}{t} F'$$

$$u_x = t^\alpha F'$$

$$u_{xx} = t^{2\alpha} F'' = \frac{\eta^2}{x^2} F''$$

We substitute these expressions into the heat equation.

$$\alpha \frac{\eta}{t} F' = \nu \frac{\eta^2}{x^2} F''$$

$$F'' = \frac{\alpha x^2}{\nu t} \frac{1}{\eta} F'$$

We can write this equation in terms of  $F$  and  $\eta$  only if  $\alpha = -1/2$ . We make this substitution and solve the ordinary differential equation for  $F(\eta)$ .

$$\frac{F''}{F'} = -\frac{\eta}{2\nu}$$

$$\log(F') = -\frac{\eta^2}{4\nu} + c$$

$$F' = c \exp\left(-\frac{\eta^2}{4\nu}\right)$$

$$F = c_1 \int \exp\left(-\frac{\eta^2}{4\nu}\right) d\eta + c_2$$

We can write  $F$  in terms of the error function.

$$F = c_1 \operatorname{erf}\left(\frac{\eta}{2\sqrt{\nu}}\right) + c_2$$

We write this solution in terms of  $x$  and  $t$ .

$$u(x, t) = c_1 \operatorname{erf} \left( \frac{x}{2\sqrt{\nu t}} \right) + c_2$$

This is not the general solution of the heat equation. There are many other solutions. Note that since  $x$  and  $t$  do not explicitly appear in the heat equation,

$$u(x, t) = c_1 \operatorname{erf} \left( \frac{x - x_0}{2\sqrt{\nu(t - t_0)}} \right) + c_2$$

is a solution.

### Solution 42.2

We write the derivatives of  $\phi$  in terms of  $f$ .

$$\begin{aligned} \phi_t &= \frac{\partial \xi}{\partial t} \frac{\partial}{\partial \xi} f = x^\alpha f' = t^{-1} \xi f' \\ \phi_x &= \frac{\partial \xi}{\partial x} \frac{\partial}{\partial \xi} f = \alpha x^{\alpha-1} t f' \\ \phi_{xx} &= f' \frac{\partial}{\partial x} (\alpha x^{\alpha-1} t) + \alpha x^{\alpha-1} t \alpha x^{\alpha-1} t \frac{\partial}{\partial \xi} f' \\ \phi_{xx} &= \alpha^2 x^{2\alpha-2} t^2 f'' + \alpha(\alpha-1) x^{\alpha-2} t f' \\ \phi_{xx} &= x^{-2} (\alpha^2 \xi^2 f'' + \alpha(\alpha-1) \xi f') \end{aligned}$$

We substitute these expressions into the diffusion equation.

$$\xi f' = x^{-2} t (\alpha^2 \xi^2 f'' + \alpha(\alpha-1) \xi f')$$

In order for this equation to depend only on the variable  $\xi$ , we must have  $\alpha = -2$ . For this choice we obtain an ordinary

differential equation for  $f(\xi)$ .

$$f' = 4\xi^2 f'' + 6\xi f'$$

$$\frac{f''}{f'} = \frac{1}{4\xi^2} - \frac{3}{2\xi}$$

$$\log(f') = -\frac{1}{4\xi} - \frac{3}{2} \log \xi + c$$

$$f' = c_1 \xi^{-3/2} e^{-1/(4\xi)}$$

$$f(\xi) = c_1 \int^\xi t^{-3/2} e^{-1/(4t)} dt + c_2$$

$$f(\xi) = c_1 \int^{1/(2\sqrt{\xi})} e^{-t^2} dt + c_2$$

$$f(\xi) = c_1 \operatorname{erf} \left( \frac{1}{2\sqrt{\xi}} \right) + c_2$$



# Chapter 43

## Method of Characteristics

### 43.1 First Order Linear Equations

Consider the following first order wave equation.

$$u_t + cu_x = 0 \quad (43.1)$$

Let  $x(t)$  be some path in the phase plane. Perhaps  $x(t)$  describes the position of an observer who is noting the value of the solution  $u(x(t), t)$  at their current location. We differentiate with respect to  $t$  to see how the solution varies for the observer.

$$\frac{d}{dt}u(x(t), t) = u_t + x'(t)u_x \quad (43.2)$$

We note that if the observer is moving with velocity  $c$ ,  $x'(t) = c$ , then the solution at their current location does not change because  $u_t + cu_x = 0$ . We will examine this more carefully.

By comparing Equations 43.1 and 43.2 we obtain ordinary differential equations representing the position of an observer and the value of the solution at that position.

$$\frac{dx}{dt} = c, \quad \frac{du}{dt} = 0$$

Let the observer start at the position  $x_0$ . Then we have an initial value problem for  $x(t)$ .

$$\begin{aligned}\frac{dx}{dt} &= c, & x(0) &= x_0 \\ x(t) &= x_0 + ct\end{aligned}$$

These lines  $x(t)$  are called *characteristics* of Equation 43.1.

Let the initial condition be  $u(x, 0) = f(x)$ . We have an initial value problem for  $u(x(t), t)$ .

$$\begin{aligned}\frac{du}{dt} &= 0, & u(0) &= f(x_0) \\ u(x(t), t) &= f(x_0)\end{aligned}$$

Again we see that the solution is constant along the characteristics. We substitute the equation for the characteristics into this expression.

$$\begin{aligned}u(x_0 + ct, t) &= f(x_0) \\ u(x, t) &= f(x - ct)\end{aligned}$$

Now we see that the solution of Equation 43.1 is a wave moving with velocity  $c$ . The solution at time  $t$  is the initial condition translated a distance of  $ct$ .

## 43.2 First Order Quasi-Linear Equations

Consider the following quasi-linear equation.

$$u_t + a(x, t, u)u_x = 0 \tag{43.3}$$

We will solve this equation with the method of characteristics. We differentiate the solution along a path  $x(t)$ .

$$\frac{d}{dt}u(x(t), t) = u_t + x'(t)u_x \tag{43.4}$$

By comparing Equations 43.3 and 43.4 we obtain ordinary differential equations for the characteristics  $x(t)$  and the solution along the characteristics  $u(x(t), t)$ .

$$\frac{dx}{dt} = a(x, t, u), \quad \frac{du}{dt} = 0$$

Suppose an initial condition is specified,  $u(x, 0) = f(x)$ . Then we have ordinary differential equation, initial value problems.

$$\begin{aligned} \frac{dx}{dt} &= a(x, t, u), & x(0) &= x_0 \\ \frac{du}{dt} &= 0, & u(0) &= f(x_0) \end{aligned}$$

We see that the solution is constant along the characteristics. The solution of Equation 43.3 is a wave moving with velocity  $a(x, t, u)$ .

**Example 43.2.1** Consider the inviscid Burger equation,

$$u_t + uu_x = 0, \quad u(x, 0) = f(x).$$

We write down the differential equations for the solution along a characteristic.

$$\begin{aligned} \frac{dx}{dt} &= u, & x(0) &= x_0 \\ \frac{du}{dt} &= 0, & u(0) &= f(x_0) \end{aligned}$$

First we solve the equation for  $u$ .  $u = f(x_0)$ . Then we solve for  $x$ .  $x = x_0 + f(x_0)t$ . This gives us an implicit solution of the Burger equation.

$$u(x_0 + f(x_0)t, t) = f(x_0)$$

### 43.3 The Method of Characteristics and the Wave Equation

Consider the one dimensional wave equation,

$$u_{tt} = c^2 u_{xx}.$$

We make the change of variables,  $a = u_x$ ,  $b = u_t$ , to obtain a coupled system of first order equations.

$$\begin{aligned} a_t - b_x &= 0 \\ b_t - c^2 a_x &= 0 \end{aligned}$$

We write this as a matrix equation.

$$\begin{pmatrix} a \\ b \end{pmatrix}_t + \begin{pmatrix} 0 & -1 \\ -c^2 & 0 \end{pmatrix} \begin{pmatrix} a \\ b \end{pmatrix}_x = 0$$

The eigenvalues and eigenvectors of the matrix are

$$\lambda_1 = -c, \quad \lambda_2 = c, \quad \boldsymbol{\xi}_1 = \begin{pmatrix} 1 \\ c \end{pmatrix}, \quad \boldsymbol{\xi}_2 = \begin{pmatrix} 1 \\ -c \end{pmatrix}.$$

The matrix is diagonalized by a similarity transformation.

$$\begin{pmatrix} -c & 0 \\ 0 & c \end{pmatrix} = \begin{pmatrix} 1 & 1 \\ c & -c \end{pmatrix}^{-1} \begin{pmatrix} 0 & -1 \\ -c^2 & 0 \end{pmatrix} \begin{pmatrix} 1 & 1 \\ c & -c \end{pmatrix}$$

We make a change of variables to diagonalize the system.

$$\begin{aligned} \begin{pmatrix} a \\ b \end{pmatrix} &= \begin{pmatrix} 1 & 1 \\ c & -c \end{pmatrix} \begin{pmatrix} \alpha \\ \beta \end{pmatrix} \\ \begin{pmatrix} 1 & 1 \\ c & -c \end{pmatrix} \begin{pmatrix} \alpha \\ \beta \end{pmatrix}_t + \begin{pmatrix} 0 & -1 \\ -c^2 & 0 \end{pmatrix} \begin{pmatrix} 1 & 1 \\ c & -c \end{pmatrix} \begin{pmatrix} \alpha \\ \beta \end{pmatrix}_x &= 0 \end{aligned}$$

Now we left multiply by the inverse of the matrix of eigenvectors to obtain an uncoupled system that we can solve directly.

$$\begin{pmatrix} \alpha \\ \beta \end{pmatrix}_t + \begin{pmatrix} -c & 0 \\ 0 & c \end{pmatrix} \begin{pmatrix} \alpha \\ \beta \end{pmatrix}_x = 0.$$

$$\alpha(x, t) = p(x + ct), \quad \beta(x, t) = q(x - ct),$$

Here  $p, q \in C^2$  are arbitrary functions. We change variables back to  $a$  and  $b$ .

$$a(x, t) = p(x + ct) + q(x - ct), \quad b(x, t) = cp(x + ct) - cq(x - ct)$$

We could integrate either  $a = u_x$  or  $b = u_t$  to obtain the solution of the wave equation.

$$u = F(x - ct) + G(x + ct)$$

Here  $F, G \in C^2$  are arbitrary functions. We see that  $u(x, t)$  is the sum of a waves moving to the right and left with speed  $c$ . This is the general solution of the one-dimensional wave equation. Note that for any given problem,  $F$  and  $G$  are only determined to within an additive constant. For any constant  $k$ , adding  $k$  to  $F$  and subtracting it from  $G$  does not change the solution.

$$u = (F(x - ct) + k) + (G(x - ct) - k)$$

## 43.4 The Wave Equation for an Infinite Domain

Consider the Cauchy problem for the wave equation on  $-\infty < x < \infty$ .

$$\begin{aligned} u_{tt} &= c^2 u_{xx}, & -\infty < x < \infty, & t > 0 \\ u(x, 0) &= f(x), & u_t(x, 0) &= g(x) \end{aligned}$$

We know that the solution is the sum of right-moving and left-moving waves.

$$u(x, t) = F(x - ct) + G(x + ct) \tag{43.5}$$

The initial conditions give us two constraints on  $F$  and  $G$ .

$$F(x) + G(x) = f(x), \quad -cF'(x) + cG'(x) = g(x).$$

We integrate the second equation.

$$-F(x) + G(x) = \frac{1}{c} \int g(x) dx + \text{const}$$

Here  $Q(x) = \int q(x) dx$ . We solve the system of equations for  $F$  and  $G$ .

$$F(x) = \frac{1}{2}f(x) - \frac{1}{2c} \int g(x) dx - k, \quad G(x) = \frac{1}{2}f(x) + \frac{1}{2c} \int g(x) dx + k$$

Note that the value of the constant  $k$  does not affect the solution,  $u(x, t)$ . For simplicity we take  $k = 0$ . We substitute  $F$  and  $G$  into Equation 43.5 to determine the solution.

$$u(x, t) = \frac{1}{2} (f(x - ct) + f(x + ct)) + \frac{1}{2c} \left( \int^{x+ct} g(x) dx - \int^{x-ct} g(x) dx \right)$$

$$u(x, t) = \frac{1}{2} (f(x - ct) + f(x + ct)) + \frac{1}{2c} \int_{x-ct}^{x+ct} g(\xi) d\xi$$

$$u(x, t) = \frac{1}{2} (u(x - ct, 0) + u(x + ct, 0)) + \frac{1}{2c} \int_{x-ct}^{x+ct} u_t(\xi, 0) d\xi$$

## 43.5 The Wave Equation for a Semi-Infinite Domain

Consider the wave equation for a semi-infinite domain.

$$u_{tt} = c^2 u_{xx}, \quad 0 < x < \infty, \quad t > 0$$

$$u(x, 0) = f(x), \quad u_t(x, 0) = g(x), \quad u(0, t) = h(t)$$

Again the solution is the sum of a right-moving and a left-moving wave.

$$u(x, t) = F(x - ct) + G(x + ct)$$

For  $x > ct$ , the boundary condition at  $x = 0$  does not affect the solution. Thus we know the solution in this domain from our work on the wave equation in the infinite domain.

$$u(x, t) = \frac{1}{2} (f(x - ct) + f(x + ct)) + \frac{1}{2c} \int_{x-ct}^{x+ct} g(\xi) d\xi, \quad x > ct$$

From this,  $F(\xi)$  and  $G(\xi)$  are determined for  $\xi > 0$ .

$$F(\xi) = \frac{1}{2} f(\xi) - \frac{1}{2c} \int g(\xi) d\xi, \quad \xi > 0$$

$$G(\xi) = \frac{1}{2} f(\xi) + \frac{1}{2c} \int g(\xi) d\xi, \quad \xi > 0$$

In order to determine the solution  $u(x, t)$  for  $x, t > 0$  we also need to determine  $F(\xi)$  for  $\xi < 0$ . To do this, we substitute the form of the solution into the boundary condition at  $x = 0$ .

$$u(0, t) = h(t), \quad t > 0$$

$$F(-ct) + G(ct) = h(t), \quad t > 0$$

$$F(\xi) = -G(-\xi) + h(-\xi/c), \quad \xi < 0$$

$$F(\xi) = -\frac{1}{2} f(-\xi) - \frac{1}{2c} \int^{-\xi} g(\psi) d\psi + h(-\xi/c), \quad \xi < 0$$

We determine the solution of the wave equation for  $x < ct$ .

$$u(x, t) = F(x - ct) + G(x + ct)$$

$$u(x, t) = -\frac{1}{2} f(-x + ct) - \frac{1}{2c} \int^{-x+ct} g(\xi) d\xi + h(t - x/c) + \frac{1}{2} f(x + ct) + \frac{1}{2c} \int_{x+ct}^{x+ct} g(\xi) d\xi, \quad x < ct$$

$$u(x, t) = \frac{1}{2} (-f(-x + ct) + f(x + ct)) + \frac{1}{2c} \int_{-x+ct}^{x+ct} g(\xi) d\xi + h(t - x/c), \quad x < ct$$

Finally, we collect the solutions in the two domains.

$$u(x, t) = \begin{cases} \frac{1}{2} (f(x - ct) + f(x + ct)) + \frac{1}{2c} \int_{x-ct}^{x+ct} g(\xi) d\xi, & x > ct \\ \frac{1}{2} (-f(-x + ct) + f(x + ct)) + \frac{1}{2c} \int_{-x+ct}^{x+ct} g(\xi) d\xi + h(t - x/c), & x < ct \end{cases}$$

## 43.6 The Wave Equation for a Finite Domain

Consider the wave equation for the infinite domain.

$$\begin{aligned} u_{tt} &= c^2 u_{xx}, & -\infty < x < \infty, & t > 0 \\ u(x, 0) &= f(x), & u_t(x, 0) &= g(x) \end{aligned}$$

If  $f(x)$  and  $g(x)$  are odd about  $x = 0$ , ( $f(x) = -f(-x)$ ,  $g(x) = -g(-x)$ ), then  $u(x, t)$  is also odd about  $x = 0$ . We can demonstrate this with D'Alembert's solution.

$$\begin{aligned} u(x, t) &= \frac{1}{2} (f(x - ct) + f(x + ct)) + \frac{1}{2c} \int_{x-ct}^{x+ct} g(\xi) d\xi \\ -u(-x, t) &= -\frac{1}{2} (f(-x - ct) + f(-x + ct)) - \frac{1}{2c} \int_{-x-ct}^{-x+ct} g(\xi) d\xi \\ &= \frac{1}{2} (f(x + ct) + f(x - ct)) - \frac{1}{2c} \int_{x+ct}^{x-ct} g(-\xi) (-d\xi) \\ &= \frac{1}{2} (f(x - ct) + f(x + ct)) + \frac{1}{2c} \int_{x-ct}^{x+ct} g(\xi) d\xi \\ &= u(x, t) \end{aligned}$$

Thus if the initial conditions  $f(x)$  and  $g(x)$  are odd about a point then the solution of the wave equation  $u(x, t)$  is also odd about that point. The analogous result holds if the initial conditions are even about a point. These results are useful in solving the wave equation on a finite domain.



Consider a string of length  $L$  with fixed ends.

$$u_{tt} = c^2 u_{xx}, \quad 0 < x < L, \quad t > 0$$

$$u(x, 0) = f(x), \quad u_t(x, 0) = g(x), \quad u(0, t) = u(L, t) = 0$$

We extend the domain of the problem to  $x \in (-\infty \dots \infty)$ . We form the odd periodic extensions  $\tilde{f}$  and  $\tilde{g}$  which are odd about the points  $x = 0, L$ .

If a function  $h(x)$  is defined for positive  $x$ , then  $\text{sign}(x)h(|x|)$  is the odd extension of the function. If  $h(x)$  is defined for  $x \in (-L \dots L)$  then its periodic extension is

$$h\left(x - 2L \left\lfloor \frac{x + L}{2L} \right\rfloor\right).$$

We combine these two formulas to form odd periodic extensions.

$$\tilde{f}(x) = \text{sign}\left(x - 2L \left\lfloor \frac{x + L}{2L} \right\rfloor\right) f\left(\left|x - 2L \left\lfloor \frac{x + L}{2L} \right\rfloor\right|\right)$$

$$\tilde{g}(x) = \text{sign}\left(x - 2L \left\lfloor \frac{x + L}{2L} \right\rfloor\right) g\left(\left|x - 2L \left\lfloor \frac{x + L}{2L} \right\rfloor\right|\right)$$

Now we can write the solution for the vibrations of a string with fixed ends.

$$u(x, t) = \frac{1}{2} \left( \tilde{f}(x - ct) + \tilde{f}(x + ct) \right) + \frac{1}{2c} \int_{x-ct}^{x+ct} \tilde{g}(\xi) d\xi$$

## 43.7 Envelopes of Curves

Consider the tangent lines to the parabola  $y = x^2$ . The slope of the tangent at the point  $(x, x^2)$  is  $2x$ . The set of tangents form a one parameter family of lines,

$$f(x, t) = t^2 + (x - t)2t = 2tx - t^2.$$

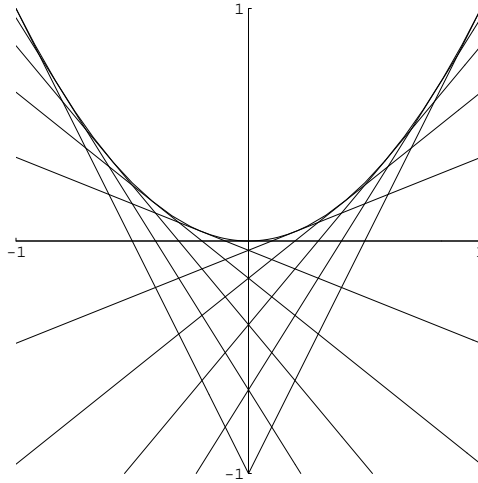

Figure 43.1: A parabola and its tangents.

The parabola and some of its tangents are plotted in Figure 43.1.

The parabola is the *envelope* of the family of tangent lines. Each point on the parabola is tangent to one of the lines. Given a curve, we can generate a family of lines that envelope the curve. We can also do the opposite, given a family of lines, we can determine the curve that they envelope. More generally, given a family of curves, we can determine the curve that they envelope. Let the one parameter family of curves be given by the equation  $F(x, y, t) = 0$ . For the example of the tangents to the parabola this equation would be  $y - 2tx + t^2 = 0$ .

Let  $y(x)$  be the envelope of  $F(x, y, t) = 0$ . Then the points on  $y(x)$  must lie on the family of curves. Thus  $y(x)$  must satisfy the equation  $F(x, y, t) = 0$ . The points that lie on the envelope have the property,

$$\frac{\partial}{\partial t} F(x, y, t) = 0.$$

We can solve this equation for  $t$  in terms of  $x$  and  $y$ ,  $t = t(x, y)$ . The equation for the envelope is then

$$F(x, y, t(x, y)) = 0.$$

Consider the example of the tangents to the parabola. The equation of the one-parameter family of curves is

$$F(x, y, t) \equiv y - 2tx + t^2 = 0.$$

The condition  $F_t(x, y, t) = 0$  gives us the constraint,

$$-2x + 2t = 0.$$

Solving this for  $t$  gives us  $t(x, y) = x$ . The equation for the envelope is then,

$$y - 2xx + x^2 = 0,$$

$$y = x^2.$$

**Example 43.7.1** Consider the one parameter family of curves,

$$(x - t)^2 + (y - t)^2 - 1 = 0.$$

These are circles of unit radius and center  $(t, t)$ . To determine the envelope of the family, we first use the constraint  $F_t(x, y, t)$  to solve for  $t(x, y)$ .

$$F_t(x, y, t) = -2(x - t) - 2(y - t) = 0$$

$$t(x, y) = \frac{x + y}{2}$$

Now we substitute this into the equation  $F(x, y, t) = 0$  to determine the envelope.

$$F\left(x, y, \frac{x + y}{2}\right) = \left(x - \frac{x + y}{2}\right)^2 + \left(y - \frac{x + y}{2}\right)^2 - 1 = 0$$

$$\left(\frac{x - y}{2}\right)^2 + \left(\frac{y - x}{2}\right)^2 - 1 = 0$$

$$(x - y)^2 = 2$$

$$\boxed{y = x \pm \sqrt{2}}$$

The one parameter family of curves and its envelope is shown in Figure 43.2.

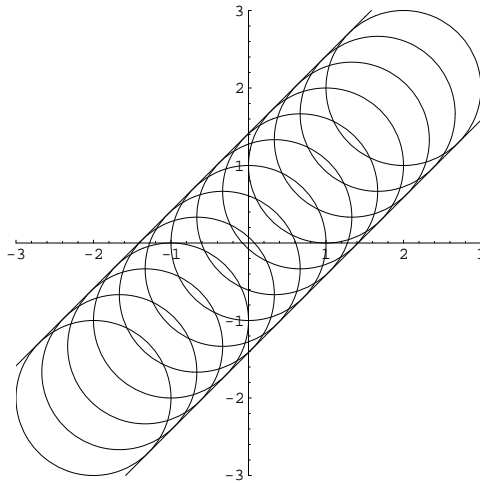

Figure 43.2: The envelope of  $(x - t)^2 + (y - t)^2 - 1 = 0$ .

## 43.8 Exercises

### Exercise 43.1

Consider the small transverse vibrations of a composite string of infinite extent, made up of two homogeneous strings of different densities joined at  $x = 0$ . In each region 1)  $x < 0$ , 2)  $x > 0$  we have

$$u_{tt} - c_j^2 u_{xx} = 0 \quad j = 1, 2 \quad c_1 \neq c_2,$$

and we require continuity of  $u$  and  $u_x$  at  $x = 0$ . Suppose for  $t < 0$  a wave approaches the junction  $x = 0$  from the left, i.e. as  $t$  approaches 0 from negative values:

$$u(x, t) = \begin{cases} F(x - c_1 t) & x < 0, t \leq 0 \\ 0 & x > 0, t \leq 0 \end{cases}$$

As  $t$  increases further, the wave reaches  $x = 0$  and gives rise to reflected and transmitted waves.

1. Formulate the appropriate initial values for  $u$  at  $t = 0$ .
2. Solve the initial-value problem for  $-\infty < x < \infty$ ,  $t > 0$ .
3. Identify the incident, reflected and transmitted waves in your solution and determine the reflection and transmission coefficients for the junction in terms of  $c_1$  and  $c_2$ . Comment also on their values in the limit  $c_1 \rightarrow c_2$ .

### Exercise 43.2

Consider a semi-infinite string,  $x > 0$ . For all time the end of the string is displaced according to  $u(0, t) = f(t)$ . Find the motion of the string,  $u(x, t)$  with the method of characteristics and then with a Fourier transform in time. The wave speed is  $c$ .

### Exercise 43.3

Solve using characteristics:

$$uu_x + u_y = 1, \quad u|_{x=y} = \frac{x}{2}.$$

### Exercise 43.4

Solve using characteristics:

$$(y + u)u_x + yu_y = x - y, \quad u|_{y=1} = 1 + x.$$

## 43.9 Hints

### Hint 43.1

### Hint 43.2

1. Because the left end of the string is being displaced, there will only be right-moving waves. Assume a solution of the form

$$u(x, t) = F(x - ct).$$

2. Take a Fourier transform in time. Use that there are only outgoing waves.

### Hint 43.3

### Hint 43.4

## 43.10 Solutions

### Solution 43.1

1.

$$u(x, 0) = \begin{cases} F(x), & x < 0 \\ 0, & x > 0 \end{cases}$$
$$u_t(x, 0) = \begin{cases} -c_1 F'(x), & x < 0 \\ 0, & x > 0 \end{cases}$$

2. Regardless of the initial condition, the solution has the following form.

$$u(x, t) = \begin{cases} f_1(x - c_1 t) + g_1(x + c_1 t), & x < 0 \\ f_2(x - c_2 t) + g_1(x + c_2 t), & x > 0 \end{cases}$$

For  $x < 0$ , the right-moving wave is  $F(x - c_1 t)$  and the left-moving wave is zero for  $x < -c_1 t$ . For  $x > 0$ , there is no left-moving wave and the right-moving wave is zero for  $x > c_2 t$ . We apply these restrictions to the solution.

$$u(x, t) = \begin{cases} F(x - c_1 t) + g(x + c_1 t), & x < 0 \\ f(x - c_2 t), & x > 0 \end{cases}$$

We use the continuity of  $u$  and  $u_x$  at  $x = 0$  to solve for  $f$  and  $g$ .

$$F(-c_1 t) + g(c_1 t) = f(-c_2 t)$$
$$F'(-c_1 t) + g'(c_1 t) = f'(-c_2 t)$$

We integrate the second equation.

$$F(-t) + g(t) = f(-c_2 t/c_1)$$
$$-F(-t) + g(t) = -\frac{c_1}{c_2} f(-c_2 t/c_1) + a$$

We solve for  $f$  for  $x < c_2t$  and for  $g$  for  $x > -c_1t$ .

$$f(-c_2t/c_1) = \frac{2c_2}{c_1 + c_2}F(-t) + b, \quad g(t) = \frac{c_2 - c_1}{c_1 + c_2}F(-t) + b$$

By considering the case that the solution is continuous,  $F(0) = 0$ , we conclude that  $b = 0$  since  $f(0) = g(0) = 0$ .

$$f(t) = \frac{2c_2}{c_1 + c_2}F(c_1t/c_2), \quad g(t) = \frac{c_2 - c_1}{c_1 + c_2}F(-t)$$

Now we can write the solution for  $u(x, t)$  for  $t > 0$ .

$$u(x, t) = \begin{cases} F(x - c_1t) + \frac{c_2 - c_1}{c_1 + c_2}F(-x - c_1t)H(x + c_1t), & x < 0 \\ \frac{2c_2}{c_1 + c_2}F\left(\frac{c_1}{c_2}(x - c_2t)\right)H(c_2t - x), & x > 0 \end{cases}$$

3. The incident, reflected and transmitted waves are, respectively,

$$F(x - c_1t), \quad \frac{c_2 - c_1}{c_1 + c_2}F(-x - c_1t)H(x + c_1t), \quad \frac{2c_2}{c_1 + c_2}F\left(\frac{c_1}{c_2}(x - c_2t)\right)H(c_2t - x).$$

The reflection and transmission coefficients are, respectively,

$$\frac{c_1 - c_2}{c_1 + c_2}, \quad \frac{2c_2}{c_1 + c_2}.$$

In the limit as  $c_1 \rightarrow c_2$ , the reflection coefficient vanishes and the transmission coefficient tends to unity.

## Solution 43.2

1. **Method of characteristics.** The problem is

$$u_{tt} - c^2u_{xx} = 0, \quad x > 0, \quad -\infty < t < \infty, \\ u(0, t) = f(t).$$



Because the left end of the string is being displaced, there will only be right-moving waves. The solution has the form

$$u(x, t) = F(x - ct).$$

We substitute this into the boundary condition.

$$F(-ct) = f(t)$$

$$F(\xi) = f\left(-\frac{\xi}{c}\right)$$

$$\boxed{u(x, t) = f(t - x/c)}$$

2. **Fourier transform.** We take the Fourier transform in time of the wave equation and the boundary condition.

$$u_{tt} = c^2 u_{xx}, \quad u(0, t) = f(t)$$

$$-\omega^2 \hat{u} = c^2 \hat{u}_{xx}, \quad \hat{u}(0, \omega) = \hat{f}(\omega)$$

$$\hat{u}_{xx} + \frac{\omega^2}{c^2} \hat{u} = 0, \quad \hat{u}(0, \omega) = \hat{f}(\omega)$$

The general solution of this ordinary differential equation is

$$\hat{u}(x, \omega) = a(\omega) e^{i\omega x/c} + b(\omega) e^{-i\omega x/c}.$$

The radiation condition, ( $u(x, t)$  must be a wave traveling in the positive direction), and the boundary condition at  $x = 0$  will determine the constants  $a$  and  $b$ . Consider the solution  $u(x, t)$  we will obtain by taking the inverse Fourier transform of  $\hat{u}$ .

$$u(x, t) = \int_{-\infty}^{\infty} (a(\omega) e^{i\omega x/c} + b(\omega) e^{-i\omega x/c}) e^{i\omega t} d\omega$$

$$u(x, t) = \int_{-\infty}^{\infty} (a(\omega) e^{i\omega(t+x/c)} + b(\omega) e^{i\omega(t-x/c)}) d\omega$$

The first and second terms in the integrand are left and right traveling waves, respectively. In order that  $u$  is a right traveling wave, it must be a superposition of right traveling waves. We conclude that  $a(\omega) = 0$ . We apply the boundary condition at  $x = 0$ , we solve for  $\hat{u}$ .

$$\hat{u}(x, \omega) = \hat{f}(\omega) e^{-i\omega x/c}$$

Finally we take the inverse Fourier transform.

$$u(x, t) = \int_{-\infty}^{\infty} \hat{f}(\omega) e^{i\omega(t-x/c)} d\omega$$

$$\boxed{u(x, t) = f(t - x/c)}$$

### Solution 43.3

$$uu_x + u_y = 1, \quad u|_{x=y} = \frac{x}{2} \tag{43.6}$$

We form  $\frac{du}{dy}$ .

$$\frac{du}{dy} = u_x \frac{dx}{dy} + u_y$$

We compare this with Equation 43.6 to obtain differential equations for  $x$  and  $u$ .

$$\frac{dx}{dy} = u, \quad \frac{du}{dy} = 1. \tag{43.7}$$

The initial data is

$$x(y = \alpha) = \alpha, \quad u(y = \alpha) = \frac{\alpha}{2}. \tag{43.8}$$

We solve the differential equation for  $u$  (43.7) subject to the initial condition (43.8).

$$u(x(y), y) = y - \frac{\alpha}{2}$$

The differential equation for  $x$  becomes

$$\frac{dx}{dy} = y - \frac{\alpha}{2}.$$

We solve this subject to the initial condition (43.8).

$$x(y) = \frac{1}{2}(y^2 + \alpha(2 - y))$$

This defines the characteristic starting at the point  $(\alpha, \alpha)$ . We solve for  $\alpha$ .

$$\alpha = \frac{y^2 - 2x}{y - 2}$$

We substitute this value for  $\alpha$  into the solution for  $u$ .

$$u(x, y) = \frac{y(y - 4) + 2x}{2(y - 2)}$$

This solution is defined for  $y \neq 2$ . This is because at  $(x, y) = (2, 2)$ , the characteristic is parallel to the line  $x = y$ . Figure 43.3 has a plot of the solution that shows the singularity at  $y = 2$ .

#### Solution 43.4

$$(y + u)u_x + yu_y = x - y, \quad u|_{y=1} = 1 + x \quad (43.9)$$

We differentiate  $u$  with respect to  $s$ .

$$\frac{du}{ds} = u_x \frac{dx}{ds} + u_y \frac{dy}{ds}$$

We compare this with Equation 43.9 to obtain differential equations for  $x$ ,  $y$  and  $u$ .

$$\frac{dx}{ds} = y + u, \quad \frac{dy}{ds} = y, \quad \frac{du}{ds} = x - y$$

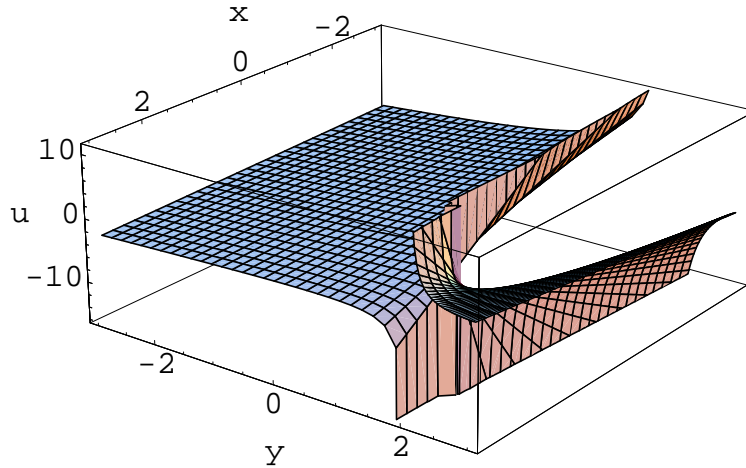

Figure 43.3: The solution  $u(x, y)$ .

We parametrize the initial data in terms of  $s$ .

$$x(s=0) = \alpha, \quad y(s=0) = 1, \quad u(s=0) = 1 + \alpha$$

We solve the equation for  $y$  subject to the initial condition.

$$y(s) = e^s$$

This gives us a coupled set of differential equations for  $x$  and  $u$ .

$$\frac{dx}{ds} = e^s + u, \quad \frac{du}{ds} = x - e^s$$

The solutions subject to the initial conditions are

$$x(s) = (\alpha + 1)e^s - e^{-s}, \quad u(s) = \alpha e^s + e^{-s}.$$

We substitute  $y(s) = e^s$  into these solutions.

$$x(s) = (\alpha + 1)y - \frac{1}{y}, \quad u(s) = \alpha y + \frac{1}{y}$$

We solve the first equation for  $\alpha$  and substitute it into the second equation to obtain the solution.

$$u(x, y) = \frac{2 + xy - y^2}{y}$$

This solution is valid for  $y > 0$ . The characteristic passing through  $(\alpha, 1)$  is

$$x(s) = (\alpha + 1)e^s - e^{-s}, \quad y(s) = e^s.$$

Hence we see that the characteristics satisfy  $y(s) \geq 0$  for all real  $s$ . Figure 43.4 shows some characteristics in the  $(x, y)$  plane with starting points from  $(-5, 1)$  to  $(5, 1)$  and a plot of the solution.

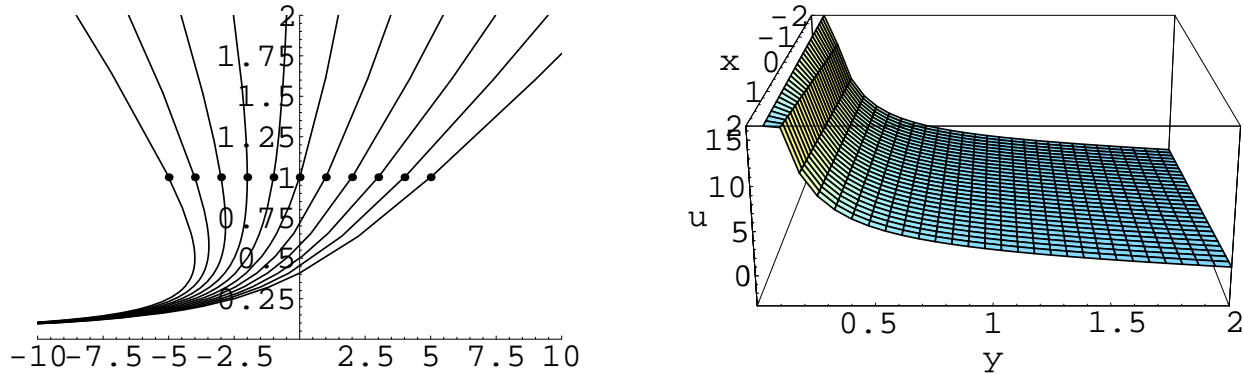

Figure 43.4: Some characteristics and the solution  $u(x, y)$ .

# Chapter 44

## Transform Methods

### 44.1 Fourier Transform for Partial Differential Equations

Solve Laplace's equation in the upper half plane

$$\begin{aligned}\nabla^2 u &= 0 & -\infty < x < \infty, y > 0 \\ u(x, 0) &= f(x) & -\infty < x < \infty\end{aligned}$$

Taking the Fourier transform in the  $x$  variable of the equation and the boundary condition,

$$\begin{aligned}\mathcal{F}\left[\frac{\partial^2 u}{\partial x^2} + \frac{\partial^2 u}{\partial y^2}\right] &= 0, & \mathcal{F}[u(x, 0)] &= \mathcal{F}[f(x)] \\ -\omega^2 U(\omega, y) + \frac{\partial^2}{\partial y^2} U(\omega, y) &= 0, & U(\omega, 0) &= F(\omega).\end{aligned}$$

The general solution to the equation is

$$U(\omega, y) = a e^{\omega y} + b e^{-\omega y}.$$

Remember that in solving the differential equation here we consider  $\omega$  to be a parameter. Requiring that the solution be bounded for  $y \in [0, \infty)$  yields

$$U(\omega, y) = a e^{-|\omega|y}.$$

Applying the boundary condition,

$$U(\omega, y) = F(\omega) e^{-|\omega|y}.$$

The inverse Fourier transform of  $e^{-|\omega|y}$  is

$$\mathcal{F}^{-1} [e^{-|\omega|y}] = \frac{2y}{x^2 + y^2}.$$

Thus

$$\begin{aligned} U(\omega, y) &= F(\omega) \mathcal{F} \left[ \frac{2y}{x^2 + y^2} \right] \\ \mathcal{F} [u(x, y)] &= \mathcal{F} [f(x)] \mathcal{F} \left[ \frac{2y}{x^2 + y^2} \right]. \end{aligned}$$

Recall that the convolution theorem is

$$\mathcal{F} \left[ \frac{1}{2\pi} \int_{-\infty}^{\infty} f(x - \xi)g(\xi) d\xi \right] = F(\omega)G(\omega).$$

Applying the convolution theorem to the equation for  $U$ ,

$$u(x, y) = \frac{1}{2\pi} \int_{-\infty}^{\infty} \frac{f(x - \xi)2y}{\xi^2 + y^2} d\xi$$

$$\boxed{u(x, y) = \frac{y}{\pi} \int_{-\infty}^{\infty} \frac{f(x - \xi)}{\xi^2 + y^2} d\xi.}$$

## 44.2 The Fourier Sine Transform

Consider the problem

$$\begin{aligned}u_t &= \kappa u_{xx}, & x > 0, & \quad t > 0 \\u(0, t) &= 0, & u(x, 0) &= f(x)\end{aligned}$$

Since we are given the position at  $x = 0$  we apply the Fourier sine transform.

$$\begin{aligned}\hat{u}_t &= \kappa \left( -\omega^2 \hat{u} + \frac{2}{\pi} \omega u(0, t) \right) \\ \hat{u}_t &= -\kappa \omega^2 \hat{u} \\ \hat{u}(\omega, t) &= c(\omega) e^{-\kappa \omega^2 t}\end{aligned}$$

The initial condition is

$$\hat{u}(\omega, 0) = \hat{f}(\omega).$$

We solve the first order differential equation to determine  $\hat{u}$ .

$$\begin{aligned}\hat{u}(\omega, t) &= \hat{f}(\omega) e^{-\kappa \omega^2 t} \\ \hat{u}(\omega, t) &= \hat{f}(\omega) \mathcal{F}_c \left[ \frac{1}{\sqrt{4\pi\kappa t}} e^{-x^2/(4\kappa t)} \right]\end{aligned}$$

We take the inverse sine transform with the convolution theorem.

$$u(x, t) = \frac{1}{4\pi^{3/2}\sqrt{\kappa t}} \int_0^\infty f(\xi) \left( e^{-|x-\xi|^2/(4\kappa t)} - e^{-(x+\xi)^2/(4\kappa t)} \right) d\xi$$

## 44.3 Fourier Transform

Consider the problem

$$\frac{\partial u}{\partial t} - \frac{\partial u}{\partial x} + u = 0, \quad -\infty < x < \infty, \quad t > 0,$$



$$u(x, 0) = f(x).$$

Taking the Fourier Transform of the partial differential equation and the initial condition yields

$$\frac{\partial U}{\partial t} - i\omega U + U = 0,$$

$$U(\omega, 0) = F(\omega) = \frac{1}{2\pi} \int_{-\infty}^{\infty} f(x) e^{-i\omega x} dx.$$

Now we have a first order differential equation for  $U(\omega, t)$  with the solution

$$U(\omega, t) = F(\omega) e^{(-1+i\omega)t}.$$

Now we apply the inverse Fourier transform.

$$u(x, t) = \int_{-\infty}^{\infty} F(\omega) e^{(-1+i\omega)t} e^{i\omega x} d\omega$$

$$u(x, t) = e^{-t} \int_{-\infty}^{\infty} F(\omega) e^{i\omega(x+t)} d\omega$$

$$\boxed{u(x, t) = e^{-t} f(x + t)}$$

## 44.4 Exercises

### Exercise 44.1

Find an integral representation of the solution  $u(x, y)$ , of

$$u_{xx} + u_{yy} = 0 \text{ in } -\infty < x < \infty, 0 < y < \infty,$$

subject to the boundary conditions:

$$u(x, 0) = f(x), \quad -\infty < x < \infty;$$

$$u(x, y) \rightarrow 0 \text{ as } x^2 + y^2 \rightarrow \infty.$$

### Exercise 44.2

Solve the Cauchy problem for the one-dimensional heat equation in the domain  $-\infty < x < \infty, t > 0$ ,

$$u_t = \kappa u_{xx}, \quad u(x, 0) = f(x),$$

with the Fourier transform.

### Exercise 44.3

Solve the Cauchy problem for the one-dimensional heat equation in the domain  $-\infty < x < \infty, t > 0$ ,

$$u_t = \kappa u_{xx}, \quad u(x, 0) = f(x),$$

with the Laplace transform.

### Exercise 44.4

1. In Exercise ?? above, let  $f(-x) = -f(x)$  for all  $x$  and verify that  $\phi(x, t)$  so obtained is the solution, for  $x > 0$ , of the following problem: find  $\phi(x, t)$  satisfying

$$\phi_t = a^2 \phi_{xx}$$

in  $0 < x < \infty, t > 0$ , with boundary condition  $\phi(0, t) = 0$  and initial condition  $\phi(x, 0) = f(x)$ . This technique, in which the solution for a semi-infinite interval is obtained from that for an infinite interval, is an example of what is called the *method of images*.

2. How would you modify the result of part (a) if the boundary condition  $\phi(0, t) = 0$  was replaced by  $\phi_x(0, t) = 0$ ?

### Exercise 44.5

Solve the Cauchy problem for the one-dimensional wave equation in the domain  $-\infty < x < \infty, t > 0$ ,

$$u_{tt} = c^2 u_{xx}, \quad u(x, 0) = f(x), \quad u_t(x, 0) = g(x),$$

with the Fourier transform.

### Exercise 44.6

Solve the Cauchy problem for the one-dimensional wave equation in the domain  $-\infty < x < \infty, t > 0$ ,

$$u_{tt} = c^2 u_{xx}, \quad u(x, 0) = f(x), \quad u_t(x, 0) = g(x),$$

with the Laplace transform.

### Exercise 44.7

Consider the problem of determining  $\phi(x, t)$  in the region  $0 < x < \infty, 0 < t < \infty$ , such that

$$\phi_t = a^2 \phi_{xx}, \tag{44.1}$$

with initial and boundary conditions

$$\phi(x, 0) = 0 \quad \text{for all } x > 0,$$

$$\phi(0, t) = f(t) \quad \text{for all } t > 0,$$

where  $f(t)$  is a given function.

1. Obtain the formula for the Laplace transform of  $\phi(x, t)$ ,  $\Phi(x, s)$  and use the convolution theorem for Laplace transforms to show that

$$\phi(x, t) = \frac{x}{2a\sqrt{\pi}} \int_0^t f(t - \tau) \frac{1}{\tau^{3/2}} \exp\left(-\frac{x^2}{4a^2\tau}\right) d\tau.$$

2. Discuss the special case obtained by setting  $f(t) = 1$  and also that in which  $f(t) = 1$  for  $0 < t < T$ , with  $f(t) = 0$  for  $t > T$ . Here  $T$  is some positive constant.

### Exercise 44.8

Solve the radiating half space problem:

$$\begin{aligned} u_t &= \kappa u_{xx}, & x > 0, & \quad t > 0, \\ u_x(0, t) - \alpha u(0, t) &= 0, & u(x, 0) &= f(x). \end{aligned}$$

To do this, define

$$v(x, t) = u_x(x, t) - \alpha u(x, t)$$

and find the half space problem that  $v$  satisfies. Solve this problem and then show that

$$u(x, t) = - \int_x^\infty e^{-\alpha(\xi-x)} v(\xi, t) d\xi.$$

### Exercise 44.9

Show that

$$\int_0^\infty \omega e^{-c\omega^2} \sin(\omega x) d\omega = \frac{x\sqrt{\pi}}{4c^{3/2}} e^{-x^2/(4c)}.$$

Use the sine transform to solve:

$$\begin{aligned} u_t &= u_{xx}, & x > 0, & \quad t > 0, \\ u(0, t) &= g(t), & u(x, 0) &= 0. \end{aligned}$$

### Exercise 44.10

Use the Fourier sine transform to find the steady state temperature  $u(x, y)$  in a slab:  $x \geq 0$ ,  $0 \leq y \leq 1$ , which has zero temperature on the faces  $y = 0$  and  $y = 1$  and has a given distribution:  $u(y, 0) = f(y)$  on the edge  $x = 0$ ,  $0 \leq y \leq 1$ .

### Exercise 44.11

Find a harmonic function  $u(x, y)$  in the upper half plane which takes on the value  $g(x)$  on the  $x$ -axis. Assume that  $u$  and  $u_x$  vanish as  $|x| \rightarrow \infty$ . Use the Fourier transform with respect to  $x$ . Express the solution as a single integral by using the convolution formula.

**Exercise 44.12**

Find the bounded solution of

$$\begin{aligned} u_t &= \kappa u_{xx} - a^2 u, & 0 < x < \infty, t > 0, \\ -u_x(0, t) &= f(t), & u(x, 0) = 0. \end{aligned}$$

**Exercise 44.13**

The left end of a taut string of length  $L$  is displaced according to  $u(0, t) = f(t)$ . The right end is fixed,  $u(L, t) = 0$ . Initially the string is at rest with no displacement. If  $c$  is the wave speed for the string, find its motion for all  $t > 0$ .

**Exercise 44.14**

Let  $\nabla^2 \phi = 0$  in the  $(x, y)$ -plane region defined by  $0 < y < l$ ,  $-\infty < x < \infty$ , with  $\phi(x, 0) = \delta(x - \xi)$ ,  $\phi(x, l) = 0$ , and  $\phi \rightarrow 0$  as  $|x| \rightarrow \infty$ . Solve for  $\phi$  using Fourier transforms. You may leave your answer in the form of an integral but in fact it is possible to use techniques of contour integration to show that

$$\phi(x, y|\xi) = \frac{1}{2l} \left[ \frac{\sin(\pi y/l)}{\cosh[\pi(x - \xi)/l] - \cos(\pi y/l)} \right].$$

Note that as  $l \rightarrow \infty$  we recover the result derived in class:

$$\phi \rightarrow \frac{1}{\pi} \frac{y}{(x - \xi)^2 + y^2},$$

which clearly approaches  $\delta(x - \xi)$  as  $y \rightarrow 0$ .

## 44.5 Hints

### Hint 44.1

The desired solution form is:  $u(x, y) = \int_{-\infty}^{\infty} K(x - \xi, y) f(\xi) d\xi$ . You must find the correct  $K$ . Take the Fourier transform with respect to  $x$  and solve for  $\hat{u}(\omega, y)$  recalling that  $\hat{u}_{xx} = -\omega^2 \hat{u}$ . By  $\hat{u}_{xx}$  we denote the Fourier transform with respect to  $x$  of  $u_{xx}(x, y)$ .

### Hint 44.2

Use the Fourier convolution theorem and the table of Fourier transforms in the appendix.

### Hint 44.3

### Hint 44.4

### Hint 44.5

Use the Fourier convolution theorem. The transform pairs,

$$\begin{aligned}\mathcal{F}[\pi(\delta(x + \tau) + \delta(x - \tau))] &= \cos(\omega\tau), \\ \mathcal{F}[\pi(H(x + \tau) - H(x - \tau))] &= \frac{\sin(\omega\tau)}{\omega},\end{aligned}$$

will be useful.

### Hint 44.6

### Hint 44.7

### Hint 44.8

$v(x, t)$  satisfies the same partial differential equation. You can solve the problem for  $v(x, t)$  with the Fourier sine

transform. Use the convolution theorem to invert the transform.

To show that

$$u(x, t) = - \int_x^\infty e^{-\alpha(\xi-x)} v(\xi, t) d\xi,$$

find the solution of

$$u_x - \alpha u = v$$

that is bounded as  $x \rightarrow \infty$ .

#### Hint 44.9

Note that

$$\int_0^\infty \omega e^{-c\omega^2} \sin(\omega x) d\omega = -\frac{\partial}{\partial x} \int_0^\infty e^{-c\omega^2} \cos(\omega x) d\omega.$$

Write the integral as a Fourier transform.

Take the Fourier sine transform of the heat equation to obtain a first order, ordinary differential equation for  $\hat{u}(\omega, t)$ . Solve the differential equation and do the inversion with the convolution theorem.

#### Hint 44.10

#### Hint 44.11

#### Hint 44.12

#### Hint 44.13

#### Hint 44.14

## 44.6 Solutions

### Solution 44.1

1. We take the Fourier transform of the integral equation, noting that the left side is the convolution of  $u(x)$  and  $\frac{1}{x^2+a^2}$ .

$$2\pi\hat{u}(\omega)\mathcal{F}\left[\frac{1}{x^2+a^2}\right] = \mathcal{F}\left[\frac{1}{x^2+b^2}\right]$$

We find the Fourier transform of  $f(x) = \frac{1}{x^2+c^2}$ . Note that since  $f(x)$  is an even, real-valued function,  $\hat{f}(\omega)$  is an even, real-valued function.

$$\mathcal{F}\left[\frac{1}{x^2+c^2}\right] = \frac{1}{2\pi} \int_{-\infty}^{\infty} \frac{1}{x^2+c^2} e^{-i\omega x} dx$$

For  $x > 0$  we close the path of integration in the upper half plane and apply Jordan's Lemma to evaluate the integral in terms of the residues.

$$\begin{aligned} &= \frac{1}{2\pi} i2\pi \operatorname{Res}\left(\frac{e^{-i\omega x}}{(x-ic)(x+ic)}, x=ic\right) \\ &= i \frac{e^{-i\omega ic}}{i2c} \\ &= \frac{1}{2c} e^{-c\omega} \end{aligned}$$

Since  $\hat{f}(\omega)$  is an even function, we have

$$\mathcal{F}\left[\frac{1}{x^2+c^2}\right] = \frac{1}{2c} e^{-c|\omega|}.$$

Our equation for  $\hat{u}(\omega)$  becomes,

$$\begin{aligned} 2\pi\hat{u}(\omega) \frac{1}{2a} e^{-a|\omega|} &= \frac{1}{2b} e^{-b|\omega|} \\ \hat{u}(\omega) &= \frac{a}{2\pi b} e^{-(b-a)|\omega|}. \end{aligned}$$



We take the inverse Fourier transform using the transform pair we derived above.

$$u(x) = \frac{a}{2\pi b} \frac{2(b-a)}{x^2 + (b-a)^2}$$

$$u(x) = \frac{a(b-a)}{\pi b(x^2 + (b-a)^2)}$$

2. We take the Fourier transform of the partial differential equation and the boundary condition.

$$\begin{aligned} u_{xx} + u_{yy} &= 0, & u(x, 0) &= f(x) \\ -\omega^2 \hat{u}(\omega, y) + \hat{u}_{yy}(\omega, y) &= 0, & \hat{u}(\omega, 0) &= \hat{f}(\omega) \end{aligned}$$

This is an ordinary differential equation for  $\hat{u}$  in which  $\omega$  is a parameter. The general solution is

$$\hat{u} = c_1 e^{\omega y} + c_2 e^{-\omega y}.$$

We apply the boundary conditions that  $\hat{u}(\omega, 0) = \hat{f}(\omega)$  and  $\hat{u} \rightarrow 0$  and  $y \rightarrow \infty$ .

$$\hat{u}(\omega, y) = \hat{f}(\omega) e^{-\omega y}$$

We take the inverse transform using the convolution theorem.

$$u(x, y) = \frac{1}{2\pi} \int_{-\infty}^{\infty} e^{-(x-\xi)y} f(\xi) d\xi$$

## Solution 44.2

$$u_t = \kappa u_{xx}, \quad u(x, 0) = f(x),$$

We take the Fourier transform of the heat equation and the initial condition.

$$\hat{u}_t = -\kappa \omega^2 \hat{u}, \quad \hat{u}(\omega, 0) = \hat{f}(\omega)$$

This is a first order ordinary differential equation which has the solution,

$$\hat{u}(\omega, t) = \hat{f}(\omega) e^{-\kappa\omega^2 t}.$$

Using a table of Fourier transforms we can write this in a form that is conducive to applying the convolution theorem.

$$\hat{u}(\omega, t) = \hat{f}(\omega) \mathcal{F} \left[ \sqrt{\frac{\pi}{\kappa t}} e^{-x^2/(4\kappa t)} \right]$$

$$u(x, t) = \frac{1}{2\sqrt{\pi\kappa t}} \int_{-\infty}^{\infty} e^{-(x-\xi)^2/(4\kappa t)} f(\xi) d\xi$$

### Solution 44.3

We take the Laplace transform of the heat equation.

$$u_t = \kappa u_{xx}$$

$$s\hat{u} - u(x, 0) = \kappa \hat{u}_{xx}$$

$$\hat{u}_{xx} - \frac{s}{\kappa} \hat{u} = -\frac{f(x)}{\kappa} \tag{44.2}$$

The Green function problem for Equation 44.2 is

$$G'' - \frac{s}{\kappa} G = \delta(x - \xi), \quad G(\pm\infty; \xi) \text{ is bounded.}$$

The homogeneous solutions that satisfy the left and right boundary conditions are, respectively,

$$\exp\left(\frac{\sqrt{s}a}{x}\right), \quad \exp\left(-\frac{\sqrt{s}a}{x}\right).$$

We compute the Wronskian of these solutions.

$$W = \begin{vmatrix} \exp\left(\frac{\sqrt{s}}{a}x\right) & \exp\left(-\frac{\sqrt{s}}{a}x\right) \\ \frac{\sqrt{s}}{a} \exp\left(\frac{\sqrt{s}a}{x}\right) & -\frac{\sqrt{s}}{a} \exp\left(-\frac{\sqrt{s}a}{x}\right) \end{vmatrix} = -2\sqrt{\frac{s}{\kappa}}$$

The Green function is

$$G(x; \xi) = \frac{\exp(\sqrt{\frac{s}{\kappa}}x_{<}) \exp(-\sqrt{\frac{s}{\kappa}}x_{>})}{-2\sqrt{\frac{s}{\kappa}}}$$
$$G(x; \xi) = -\frac{\sqrt{\kappa}}{2\sqrt{s}} \exp\left(-\sqrt{\frac{s}{\kappa}}|x - \xi|\right).$$

Now we solve Equation 44.2 using the Green function.

$$\hat{u}(x, s) = \int_{-\infty}^{\infty} -\frac{f(\xi)}{\kappa} G(x; \xi) d\xi$$
$$\hat{u}(x, s) = \frac{1}{2\sqrt{\kappa s}} \int_{-\infty}^{\infty} f(\xi) \exp\left(-\sqrt{\frac{s}{\kappa}}|x - \xi|\right) d\xi$$

Finally we take the inverse Laplace transform to obtain the solution of the heat equation.

$$u(x, t) = \frac{1}{2\sqrt{\pi\kappa t}} \int_{-\infty}^{\infty} f(\xi) \exp\left(-\frac{(x - \xi)^2}{4\kappa t}\right) d\xi$$

#### Solution 44.4

1. Clearly the solution satisfies the differential equation. We must verify that it satisfies the boundary condition,

$$\phi(0, t) = 0.$$

$$\begin{aligned} \phi(x, t) &= \frac{1}{2a\sqrt{\pi t}} \int_{-\infty}^{\infty} f(\xi) \exp\left(-\frac{(x-\xi)^2}{4a^2t}\right) d\xi \\ \phi(x, t) &= \frac{1}{2a\sqrt{\pi t}} \int_{-\infty}^0 f(\xi) \exp\left(-\frac{(x-\xi)^2}{4a^2t}\right) d\xi + \frac{1}{2a\sqrt{\pi t}} \int_0^{\infty} f(\xi) \exp\left(-\frac{(x-\xi)^2}{4a^2t}\right) d\xi \\ \phi(x, t) &= \frac{1}{2a\sqrt{\pi t}} \int_0^{\infty} f(-\xi) \exp\left(-\frac{(x+\xi)^2}{4a^2t}\right) d\xi + \frac{1}{2a\sqrt{\pi t}} \int_0^{\infty} f(\xi) \exp\left(-\frac{(x-\xi)^2}{4a^2t}\right) d\xi \\ \phi(x, t) &= -\frac{1}{2a\sqrt{\pi t}} \int_0^{\infty} f(\xi) \exp\left(-\frac{(x+\xi)^2}{4a^2t}\right) d\xi + \frac{1}{2a\sqrt{\pi t}} \int_0^{\infty} f(\xi) \exp\left(-\frac{(x-\xi)^2}{4a^2t}\right) d\xi \\ \phi(x, t) &= \frac{1}{2a\sqrt{\pi t}} \int_0^{\infty} f(\xi) \left( \exp\left(-\frac{(x-\xi)^2}{4a^2t}\right) - \exp\left(-\frac{(x+\xi)^2}{4a^2t}\right) \right) d\xi \\ \phi(x, t) &= \frac{1}{2a\sqrt{\pi t}} \int_0^{\infty} f(\xi) \exp\left(-\frac{x^2 + \xi^2}{4a^2t}\right) \left( \exp\left(\frac{x\xi}{2a^2t}\right) - \exp\left(-\frac{x\xi}{2a^2t}\right) \right) d\xi \\ \phi(x, t) &= \frac{1}{a\sqrt{\pi t}} \int_0^{\infty} f(\xi) \exp\left(-\frac{x^2 + \xi^2}{4a^2t}\right) \sinh\left(\frac{x\xi}{2a^2t}\right) d\xi \end{aligned}$$

Since the integrand is zero for  $x = 0$ , the solution satisfies the boundary condition there.

2. For the boundary condition  $\phi_x(0, t) = 0$  we would choose  $f(x)$  to be even.  $f(-x) = f(x)$ . The solution is

$$\phi(x, t) = \frac{1}{a\sqrt{\pi t}} \int_0^{\infty} f(\xi) \exp\left(-\frac{x^2 + \xi^2}{4a^2t}\right) \cosh\left(\frac{x\xi}{2a^2t}\right) d\xi$$

The derivative with respect to  $x$  is

$$\phi_x(x, t) = \frac{1}{2a^3\sqrt{\pi t^{3/2}}} \int_0^{\infty} f(\xi) \exp\left(-\frac{x^2 + \xi^2}{4a^2t}\right) \left( \xi \sinh\left(\frac{x\xi}{2a^2t}\right) - x \cosh\left(\frac{x\xi}{2a^2t}\right) \right) d\xi.$$

Since the integrand is zero for  $x = 0$ , the solution satisfies the boundary condition there.

## Solution 44.5

$$u_{tt} = c^2 u_{xx}, \quad u(x, 0) = f(x), \quad u_t(x, 0) = g(x),$$

With the change of variables

$$\tau = ct, \quad \frac{\partial}{\partial \tau} = \frac{\partial t}{\partial \tau} \frac{\partial}{\partial t} = \frac{1}{c} \frac{\partial}{\partial t}, \quad v(x, \tau) = u(x, t),$$

the problem becomes

$$v_{\tau\tau} = v_{xx}, \quad v(x, 0) = f(x), \quad v_\tau(x, 0) = \frac{1}{c} g(x).$$

(This change of variables isn't necessary, it just gives us fewer constants to carry around.) We take the Fourier transform in  $x$  of the equation and the initial conditions, (we consider  $\tau$  to be a parameter).

$$\hat{v}_{\tau\tau}(\omega, \tau) = -\omega^2 \hat{v}(\omega, \tau), \quad \hat{v}(\omega, 0) = \hat{f}(\omega), \quad \hat{v}_\tau(\omega, 0) = \frac{1}{c} \hat{g}(\omega)$$

Now we have an ordinary differential equation for  $\hat{v}(\omega, \tau)$ , (now we consider  $\omega$  to be a parameter). The general solution of this constant coefficient differential equation is,

$$\hat{v}(\omega, \tau) = a(\omega) \cos(\omega\tau) + b(\omega) \sin(\omega\tau),$$

where  $a$  and  $b$  are constants that depend on the parameter  $\omega$ . We apply the initial conditions to obtain  $\hat{v}(\omega, \tau)$ .

$$\hat{v}(\omega, \tau) = \hat{f}(\omega) \cos(\omega\tau) + \frac{1}{c\omega} \hat{g}(\omega) \sin(\omega\tau)$$

With the Fourier transform pairs

$$\mathcal{F}[\pi(\delta(x + \tau) + \delta(x - \tau))] = \cos(\omega\tau),$$

$$\mathcal{F}[\pi(H(x + \tau) - H(x - \tau))] = \frac{\sin(\omega\tau)}{\omega},$$

we can write  $\hat{v}(\omega, \tau)$  in a form that is conducive to applying the Fourier convolution theorem.

$$\hat{v}(\omega, \tau) = \mathcal{F}[f(x)] \mathcal{F}[\pi(\delta(x + \tau) + \delta(x - \tau))] + \frac{1}{c} \mathcal{F}[g(x)] \mathcal{F}[\pi(H(x + \tau) - H(x - \tau))]$$

$$v(x, \tau) = \frac{1}{2\pi} \int_{-\infty}^{\infty} f(\xi) \pi (\delta(x - \xi + \tau) + \delta(x - \xi - \tau)) d\xi$$

$$+ \frac{1}{c} \frac{1}{2\pi} \int_{-\infty}^{\infty} g(\xi) \pi (H(x - \xi + \tau) - H(x - \xi - \tau)) d\xi$$

$$v(x, \tau) = \frac{1}{2} (f(x + \tau) + f(x - \tau)) + \frac{1}{2c} \int_{x-\tau}^{x+\tau} g(\xi) d\xi$$

Finally we make the change of variables  $t = \tau/c$ ,  $u(x, t) = v(x, \tau)$  to obtain D'Alembert's solution of the wave equation,

$$u(x, t) = \frac{1}{2} (f(x - ct) + f(x + ct)) + \frac{1}{2c} \int_{x-ct}^{x+ct} g(\xi) d\xi.$$

### Solution 44.6

With the change of variables

$$\tau = ct, \quad \frac{\partial}{\partial \tau} = \frac{\partial t}{\partial \tau} \frac{\partial}{\partial t} = \frac{1}{c} \frac{\partial}{\partial t}, \quad v(x, \tau) = u(x, t),$$

the problem becomes

$$v_{\tau\tau} = v_{xx}, \quad v(x, 0) = f(x), \quad v_{\tau}(x, 0) = \frac{1}{c} g(x).$$

We take the Laplace transform in  $\tau$  of the equation, (we consider  $x$  to be a parameter),

$$s^2 V(x, s) - sv(x, 0) - v_{\tau}(x, 0) = V_{xx}(x, s),$$

$$V_{xx}(x, s) - s^2 V(x, s) = -sf(x) - \frac{1}{c} g(x),$$

Now we have an ordinary differential equation for  $V(x, s)$ , (now we consider  $s$  to be a parameter). We impose the boundary conditions that the solution is bounded at  $x = \pm\infty$ . Consider the Green's function problem

$$g_{xx}(x; \xi) - s^2 g(x; \xi) = \delta(x - \xi), \quad g(\pm\infty; \xi) \text{ bounded.}$$

$e^{sx}$  is a homogeneous solution that is bounded at  $x = -\infty$ .  $e^{-sx}$  is a homogeneous solution that is bounded at  $x = +\infty$ . The Wronskian of these solutions is

$$W(x) = \begin{vmatrix} e^{sx} & e^{-sx} \\ s e^{sx} & -s e^{-sx} \end{vmatrix} = -2s.$$

Thus the Green's function is

$$g(x; \xi) = \begin{cases} -\frac{1}{2s} e^{sx} e^{-s\xi} & \text{for } x < \xi, \\ -\frac{1}{2s} e^{s\xi} e^{-sx} & \text{for } x > \xi, \end{cases} = -\frac{1}{2s} e^{-s|x-\xi|}.$$

The solution for  $V(x, s)$  is

$$\begin{aligned} V(x, s) &= -\frac{1}{2s} \int_{-\infty}^{\infty} e^{-s|x-\xi|} (-sf(\xi) - \frac{1}{c}g(\xi)) d\xi, \\ V(x, s) &= \frac{1}{2} \int_{-\infty}^{\infty} e^{-s|x-\xi|} f(\xi) d\xi + \frac{1}{2cs} \int_{-\infty}^{\infty} e^{-s|x-\xi|} g(\xi) d\xi, \\ V(x, s) &= \frac{1}{2} \int_{-\infty}^{\infty} e^{-s|\xi|} f(x - \xi) d\xi + \frac{1}{2c} \int_{-\infty}^{\infty} \frac{e^{-s|\xi|}}{s} g(x - \xi) d\xi. \end{aligned}$$

Now we take the inverse Laplace transform and interchange the order of integration.

$$\begin{aligned} v(x, \tau) &= \frac{1}{2} \mathcal{L}^{-1} \left[ \int_{-\infty}^{\infty} e^{-s|\xi|} f(x - \xi) d\xi \right] + \frac{1}{2c} \mathcal{L}^{-1} \left[ \int_{-\infty}^{\infty} \frac{e^{-s|\xi|}}{s} g(x - \xi) d\xi \right] \\ v(x, \tau) &= \frac{1}{2} \int_{-\infty}^{\infty} \mathcal{L}^{-1} [e^{-s|\xi|}] f(x - \xi) d\xi + \frac{1}{2c} \int_{-\infty}^{\infty} \mathcal{L}^{-1} \left[ \frac{e^{-s|\xi|}}{s} \right] g(x - \xi) d\xi \\ v(x, \tau) &= \frac{1}{2} \int_{-\infty}^{\infty} \delta(\tau - |\xi|) f(x - \xi) d\xi + \frac{1}{2c} \int_{-\infty}^{\infty} H(\tau - |\xi|) g(x - \xi) d\xi \\ v(x, \tau) &= \frac{1}{2} (f(x - \tau) + f(x + \tau)) + \frac{1}{2c} \int_{-\tau}^{\tau} g(x - \xi) d\xi \end{aligned}$$

$$v(x, \tau) = \frac{1}{2}(f(x - \tau) + f(x + \tau)) + \frac{1}{2c} \int_{-x-\tau}^{-x+\tau} g(-\xi) d\xi$$

$$v(x, \tau) = \frac{1}{2}(f(x - \tau) + f(x + \tau)) + \frac{1}{2c} \int_{x-\tau}^{x+\tau} g(\xi) d\xi$$

Now we write make the change of variables  $t = \tau/c$ ,  $u(x, t) = v(x, \tau)$  to obtain D'Alembert's solution of the wave equation,

$$u(x, t) = \frac{1}{2}(f(x - ct) + f(x + ct)) + \frac{1}{2c} \int_{x-ct}^{x+ct} g(\xi) d\xi.$$

### Solution 44.7

1. We take the Laplace transform of Equation 44.1.

$$\begin{aligned} s\hat{\phi} - \phi(x, 0) &= a^2 \hat{\phi}_{xx} \\ \hat{\phi}_{xx} - \frac{s}{a^2} \hat{\phi} &= 0 \end{aligned} \tag{44.3}$$

We take the Laplace transform of the initial condition,  $\phi(0, t) = f(t)$ , and use that  $\hat{\phi}(x, s)$  vanishes as  $x \rightarrow \infty$  to obtain boundary conditions for  $\hat{\phi}(x, s)$ .

$$\hat{\phi}(0, s) = \hat{f}(s), \quad \hat{\phi}(\infty, s) = 0$$

The solutions of Equation 44.3 are

$$\exp\left(\pm \frac{\sqrt{s}}{a} x\right).$$

The solution that satisfies the boundary conditions is

$$\hat{\phi}(x, s) = \hat{f}(s) \exp\left(-\frac{\sqrt{s}}{a} x\right).$$



We write this as the product of two Laplace transforms.

$$\hat{\phi}(x, s) = \hat{f}(s) \mathcal{L} \left[ \frac{x}{2a\sqrt{\pi}t^{3/2}} \exp\left(-\frac{x^2}{4a^2t}\right) \right]$$

We invert using the convolution theorem.

$$\phi(x, t) = \frac{x}{2a\sqrt{\pi}} \int_0^t f(t - \tau) \frac{1}{\tau^{3/2}} \exp\left(-\frac{x^2}{4a^2\tau}\right) d\tau.$$

2. Consider the case  $f(t) = 1$ .

$$\phi(x, t) = \frac{x}{2a\sqrt{\pi}} \int_0^t \frac{1}{\tau^{3/2}} \exp\left(-\frac{x^2}{4a^2\tau}\right) d\tau$$

$$\xi = \frac{x}{2a\sqrt{\tau}}, \quad d\xi = -\frac{x}{4a\tau^{3/2}}$$

$$\phi(x, t) = -\frac{2}{\sqrt{\pi}} \int_{\infty}^{x/(2a\sqrt{t})} e^{-\xi^2} d\xi$$

$$\phi(x, t) = \operatorname{erfc}\left(\frac{x}{2a\sqrt{t}}\right)$$

Now consider the case in which  $f(t) = 1$  for  $0 < t < T$ , with  $f(t) = 0$  for  $t > T$ . For  $t < T$ ,  $\phi$  is the same as before.

$$\phi(x, t) = \operatorname{erfc}\left(\frac{x}{2a\sqrt{t}}\right), \quad \text{for } 0 < t < T$$

Consider  $t > T$ .

$$\phi(x, t) = \frac{x}{2a\sqrt{\pi}} \int_{t-T}^t \frac{1}{\tau^{3/2}} \exp\left(-\frac{x^2}{4a^2\tau}\right) d\tau$$

$$\phi(x, t) = -\frac{2}{\sqrt{\pi}} \int_{x/(2a\sqrt{t-T})}^{x/(2a\sqrt{t})} e^{-\xi^2} d\xi$$

$$\phi(x, t) = \operatorname{erf}\left(\frac{x}{2a\sqrt{t-T}}\right) - \operatorname{erf}\left(\frac{x}{2a\sqrt{t}}\right)$$

### Solution 44.8

$$u_t = \kappa u_{xx}, \quad x > 0, \quad t > 0,$$

$$u_x(0, t) - \alpha u(0, t) = 0, \quad u(x, 0) = f(x).$$

First we find the partial differential equation that  $v$  satisfies. We start with the partial differential equation for  $u$ ,

$$u_t = \kappa u_{xx}.$$

Differentiating this equation with respect to  $x$  yields,

$$u_{tx} = \kappa u_{xxx}.$$

Subtracting  $\alpha$  times the former equation from the latter yields,

$$u_{tx} - \alpha u_t = \kappa u_{xxx} - \alpha \kappa u_{xx},$$

$$\frac{\partial}{\partial t} (u_x - \alpha u) = \kappa \frac{\partial^2}{\partial x^2} (u_x - \alpha u),$$

$$v_t = \kappa v_{xx}.$$

Thus  $v$  satisfies the same partial differential equation as  $u$ . This is because the equation for  $u$  is linear and homogeneous and  $v$  is a linear combination of  $u$  and its derivatives. The problem for  $v$  is,

$$\begin{aligned}v_t &= \kappa v_{xx}, \quad x > 0, \quad t > 0, \\v(0, t) &= 0, \quad v(x, 0) = f'(x) - \alpha f(x).\end{aligned}$$

With this new boundary condition, we can solve the problem with the Fourier sine transform. We take the sine transform of the partial differential equation and the initial condition.

$$\begin{aligned}\hat{v}_t(\omega, t) &= \kappa \left( -\omega^2 \hat{v}(\omega, t) + \frac{1}{\pi} \omega v(0, t) \right), \\ \hat{v}(\omega, 0) &= \mathcal{F}_s [f'(x) - \alpha f(x)]\end{aligned}$$

$$\begin{aligned}\hat{v}_t(\omega, t) &= -\kappa \omega^2 \hat{v}(\omega, t) \\ \hat{v}(\omega, 0) &= \mathcal{F}_s [f'(x) - \alpha f(x)]\end{aligned}$$

Now we have a first order, ordinary differential equation for  $\hat{v}$ . The general solution is,

$$\hat{v}(\omega, t) = c e^{-\kappa \omega^2 t}.$$

The solution subject to the initial condition is,

$$\hat{v}(\omega, t) = \mathcal{F}_s [f'(x) - \alpha f(x)] e^{-\kappa \omega^2 t}.$$

Now we take the inverse sine transform to find  $v$ . We utilize the Fourier cosine transform pair,

$$\mathcal{F}_c^{-1} [e^{-\kappa \omega^2 t}] = \sqrt{\frac{\pi}{\kappa t}} e^{-x^2/(4\kappa t)},$$

to write  $\hat{v}$  in a form that is suitable for the convolution theorem.

$$\hat{v}(\omega, t) = \mathcal{F}_s [f'(x) - \alpha f(x)] \mathcal{F}_c \left[ \sqrt{\frac{\pi}{\kappa t}} e^{-x^2/(4\kappa t)} \right]$$

Recall that the Fourier sine convolution theorem is,

$$\mathcal{F}_s \left[ \frac{1}{2\pi} \int_0^\infty f(\xi) (g(|x - \xi|) - g(x + \xi)) d\xi \right] = \mathcal{F}_s[f(x)]\mathcal{F}_c[g(x)].$$

Thus  $v(x, t)$  is

$$v(x, t) = \frac{1}{2\sqrt{\pi\kappa t}} \int_0^\infty (f'(\xi) - \alpha f(\xi)) \left( e^{-|x-\xi|^2/(4\kappa t)} - e^{-(x+\xi)^2/(4\kappa t)} \right) d\xi.$$

With  $v$  determined, we have a first order, ordinary differential equation for  $u$ ,

$$u_x - \alpha u = v.$$

We solve this equation by multiplying by the integrating factor and integrating.

$$\begin{aligned} \frac{\partial}{\partial x} (e^{-\alpha x} u) &= e^{-\alpha x} v \\ e^{-\alpha x} u &= \int^x e^{-\alpha \xi} v(x, t) d\xi + c(t) \\ u &= \int^x e^{-\alpha(\xi-x)} v(x, t) d\xi + e^{\alpha x} c(t) \end{aligned}$$

The solution that vanishes as  $x \rightarrow \infty$  is

$$u(x, t) = - \int_x^\infty e^{-\alpha(\xi-x)} v(\xi, t) d\xi.$$

## Solution 44.9

$$\begin{aligned}
 \int_0^{\infty} \omega e^{-c\omega^2} \sin(\omega x) d\omega &= -\frac{\partial}{\partial x} \int_0^{\infty} e^{-c\omega^2} \cos(\omega x) d\omega \\
 &= -\frac{1}{2} \frac{\partial}{\partial x} \int_{-\infty}^{\infty} e^{-c\omega^2} \cos(\omega x) d\omega \\
 &= -\frac{1}{2} \frac{\partial}{\partial x} \int_{-\infty}^{\infty} e^{-c\omega^2 + i\omega x} d\omega \\
 &= -\frac{1}{2} \frac{\partial}{\partial x} \int_{-\infty}^{\infty} e^{-c(\omega + ix/(2c))^2} e^{-x^2/(4c)} d\omega \\
 &= -\frac{1}{2} \frac{\partial}{\partial x} e^{-x^2/(4c)} \int_{-\infty}^{\infty} e^{-c\omega^2} d\omega \\
 &= -\frac{1}{2} \sqrt{\frac{\pi}{c}} \frac{\partial}{\partial x} e^{-x^2/(4c)} \\
 &= \frac{x\sqrt{\pi}}{4c^{3/2}} e^{-x^2/(4c)}
 \end{aligned}$$

$$\begin{aligned}
 u_t &= u_{xx}, \quad x > 0, \quad t > 0, \\
 u(0, t) &= g(t), \quad u(x, 0) = 0.
 \end{aligned}$$

We take the Fourier sine transform of the partial differential equation and the initial condition.

$$\hat{u}_t(\omega, t) = -\omega^2 \hat{u}(\omega, t) + \frac{\omega}{\pi} g(t), \quad \hat{u}(\omega, 0) = 0$$

Now we have a first order, ordinary differential equation for  $\hat{u}(\omega, t)$ .

$$\begin{aligned}
 \frac{\partial}{\partial t} \left( e^{\omega^2 t} \hat{u}_t(\omega, t) \right) &= \frac{\omega}{\pi} g(t) e^{\omega^2 t} \\
 \hat{u}(\omega, t) &= \frac{\omega}{\pi} e^{-\omega^2 t} \int_0^t g(\tau) e^{\omega^2 \tau} d\tau + c(\omega) e^{-\omega^2 t}
 \end{aligned}$$

The initial condition is satisfied for  $c(\omega) = 0$ .

$$\hat{u}(\omega, t) = \frac{\omega}{\pi} \int_0^t g(\tau) e^{-\omega^2(t-\tau)} d\tau$$

We take the inverse sine transform to find  $u$ .

$$u(x, t) = \mathcal{F}_s^{-1} \left[ \frac{\omega}{\pi} \int_0^t g(\tau) e^{-\omega^2(t-\tau)} d\tau \right]$$

$$u(x, t) = \int_0^t g(\tau) \mathcal{F}_s^{-1} \left[ \frac{\omega}{\pi} e^{-\omega^2(t-\tau)} \right] d\tau$$

$$u(x, t) = \int_0^t g(\tau) \frac{x}{2\sqrt{\pi}(t-\tau)^{3/2}} e^{-x^2/(4(t-\tau))} d\tau$$

$$u(x, t) = \frac{x}{2\sqrt{\pi}} \int_0^t g(\tau) \frac{e^{-x^2/(4(t-\tau))}}{(t-\tau)^{3/2}} d\tau$$

### Solution 44.10

The problem is

$$\begin{aligned} u_{xx} + u_{yy} &= 0, & 0 < x, 0 < y < 1, \\ u(x, 0) = u(x, 1) &= 0, & u(0, y) = f(y). \end{aligned}$$

We take the Fourier sine transform of the partial differential equation and the boundary conditions.

$$\begin{aligned} -\omega^2 \hat{u}(\omega, y) + \frac{k}{\pi} u(0, y) + \hat{u}_{yy}(\omega, y) &= 0 \\ \hat{u}_{yy}(\omega, y) - \omega^2 \hat{u}(\omega, y) &= -\frac{k}{\pi} f(y), \quad \hat{u}(\omega, 0) = \hat{u}(\omega, 1) = 0 \end{aligned}$$

This is an inhomogeneous, ordinary differential equation that we can solve with Green functions. The homogeneous solutions are

$$\{\cosh(\omega y), \sinh(\omega y)\}.$$

The homogeneous solutions that satisfy the left and right boundary conditions are

$$y_1 = \sinh(\omega y), \quad y_2 = \sinh(\omega(y - 1)).$$

The Wronskian of these two solutions is,

$$\begin{aligned} W(x) &= \begin{vmatrix} \sinh(\omega y) & \sinh(\omega(y - 1)) \\ \omega \cosh(\omega y) & \omega \cosh(\omega(y - 1)) \end{vmatrix} \\ &= \omega (\sinh(\omega y) \cosh(\omega(y - 1)) - \cosh(\omega y) \sinh(\omega(y - 1))) \\ &= \omega \sinh(\omega). \end{aligned}$$

The Green function is

$$G(y|\eta) = \frac{\sinh(\omega y_{<}) \sinh(\omega(y_{>} - 1))}{\omega \sinh(\omega)}.$$

The solution of the ordinary differential equation for  $\hat{u}(\omega, y)$  is

$$\begin{aligned} \hat{u}(\omega, y) &= -\frac{\omega}{\pi} \int_0^1 f(\eta) G(y|\eta) d\eta \\ &= -\frac{1}{\pi} \int_0^y f(\eta) \frac{\sinh(\omega \eta) \sinh(\omega(y - 1))}{\sinh(\omega)} d\eta - \frac{1}{\pi} \int_y^1 f(\eta) \frac{\sinh(\omega y) \sinh(\omega(\eta - 1))}{\sinh(\omega)} d\eta. \end{aligned}$$

With some uninteresting grunge, you can show that,

$$2 \int_0^\infty \frac{\sinh(\omega \eta) \sinh(\omega(y - 1))}{\sinh(\omega)} \sin(\omega x) d\omega = -2 \frac{\sin(\pi \eta) \sin(\pi y)}{(\cosh(\pi x) - \cos(\pi(y - \eta)))(\cosh(\pi x) - \cos(\pi(y + \eta)))}.$$

Taking the inverse Fourier sine transform of  $\hat{u}(\omega, y)$  and interchanging the order of integration yields,

$$u(x, y) = \frac{2}{\pi} \int_0^y f(\eta) \frac{\sin(\pi\eta) \sin(\pi y)}{(\cosh(\pi x) - \cos(\pi(y - \eta)))(\cosh(\pi x) - \cos(\pi(y + \eta)))} d\eta \\ + \frac{2}{\pi} \int_y^1 f(\eta) \frac{\sin(\pi y) \sin(\pi\eta)}{(\cosh(\pi x) - \cos(\pi(\eta - y)))(\cosh(\pi x) - \cos(\pi(\eta + y)))} d\eta.$$

$$u(x, y) = \frac{2}{\pi} \int_0^1 f(\eta) \frac{\sin(\pi\eta) \sin(\pi y)}{(\cosh(\pi x) - \cos(\pi(y - \eta)))(\cosh(\pi x) - \cos(\pi(y + \eta)))} d\eta$$

### Solution 44.11

The problem for  $u(x, y)$  is,

$$u_{xx} + u_{yy} = 0, \quad -\infty < x < \infty, y > 0, \\ u(x, 0) = g(x).$$

We take the Fourier transform of the partial differential equation and the boundary condition.

$$-\omega^2 \hat{u}(\omega, y) + \hat{u}_{yy}(\omega, y) = 0, \quad \hat{u}(\omega, 0) = \hat{g}(\omega).$$

This is an ordinary differential equation for  $\hat{u}(\omega, y)$ . So far we only have one boundary condition. In order that  $u$  is bounded we impose the second boundary condition  $\hat{u}(\omega, y)$  is bounded as  $y \rightarrow \infty$ . The general solution of the differential equation is

$$\hat{u}(\omega, y) = \begin{cases} c_1(\omega) e^{\omega y} + c_2(\omega) e^{-\omega y}, & \text{for } \omega \neq 0, \\ c_1(\omega) + c_2(\omega)y, & \text{for } \omega = 0. \end{cases}$$

Note that  $e^{\omega y}$  is the bounded solution for  $\omega < 0$ , 1 is the bounded solution for  $\omega = 0$  and  $e^{-\omega y}$  is the bounded solution for  $\omega > 0$ . Thus the bounded solution is

$$\hat{u}(\omega, y) = c(\omega) e^{-|\omega|y}.$$



The boundary condition at  $y = 0$  determines the constant of integration.

$$\hat{u}(\omega, y) = \hat{g}(\omega) e^{-|\omega|y}$$

Now we take the inverse Fourier transform to obtain the solution for  $u(x, y)$ . To do this we use the Fourier transform pair,

$$\mathcal{F} \left[ \frac{2c}{x^2 + c^2} \right] = e^{-c|\omega|},$$

and the convolution theorem,

$$\mathcal{F} \left[ \frac{1}{2\pi} \int_{-\infty}^{\infty} f(\xi)g(x - \xi) d\xi \right] = \hat{f}(\omega)\hat{g}(\omega).$$

$$u(x, y) = \frac{1}{2\pi} \int_{-\infty}^{\infty} g(\xi) \frac{2y}{(x - \xi)^2 + y^2} d\xi.$$

### Solution 44.12

Since the derivative of  $u$  is specified at  $x = 0$ , we take the cosine transform of the partial differential equation and the initial condition.

$$\begin{aligned} \hat{u}_t(\omega, t) &= \kappa \left( -\omega^2 \hat{u}(\omega, t) - \frac{1}{\pi} u_x(0, t) \right) - a^2 \hat{u}(\omega, t), \quad \hat{u}(\omega, 0) = 0 \\ \hat{u}_t + (\kappa\omega^2 + a^2) \hat{u} &= \frac{\kappa}{\pi} f(t), \quad \hat{u}(\omega, 0) = 0 \end{aligned}$$

This first order, ordinary differential equation for  $\hat{u}(\omega, t)$  has the solution,

$$\hat{u}(\omega, t) = \frac{\kappa}{\pi} \int_0^t e^{-(\kappa\omega^2 + a^2)(t-\tau)} f(\tau) d\tau.$$

We take the inverse Fourier cosine transform to find the solution  $u(x, t)$ .

$$u(x, t) = \frac{\kappa}{\pi} \mathcal{F}_c^{-1} \left[ \int_0^t e^{-(\kappa\omega^2 + a^2)(t-\tau)} f(\tau) d\tau \right]$$

$$u(x, t) = \frac{\kappa}{\pi} \int_0^t \mathcal{F}_c^{-1} \left[ e^{-\kappa\omega^2(t-\tau)} \right] e^{-a^2(t-\tau)} f(\tau) d\tau$$

$$u(x, t) = \frac{\kappa}{\pi} \int_0^t \sqrt{\frac{\pi}{\kappa(t-\tau)}} e^{-x^2/(4\kappa(t-\tau))} e^{-a^2(t-\tau)} f(\tau) d\tau$$

$$u(x, t) = \sqrt{\frac{\kappa}{\pi}} \int_0^t \frac{e^{-x^2/(4\kappa(t-\tau)) - a^2(t-\tau)}}{\sqrt{t-\tau}} f(\tau) d\tau$$

### Solution 44.13

Mathematically stated we have

$$u_{tt} = c^2 u_{xx}, \quad 0 < x < L, \quad t > 0,$$

$$u(x, 0) = u_t(x, 0) = 0,$$

$$u(0, t) = f(t), \quad u(L, t) = 0.$$

We take the Laplace transform of the partial differential equation and the boundary conditions.

$$s^2 \hat{u}(x, s) - su(x, 0) - u_t(x, 0) = c^2 \hat{u}_{xx}(x, s)$$

$$\hat{u}_{xx} = \frac{s^2}{c^2} \hat{u}, \quad \hat{u}(0, s) = \hat{f}(s), \quad \hat{u}(L, s) = 0$$

Now we have an ordinary differential equation. A set of solutions is

$$\left\{ \cosh\left(\frac{sx}{c}\right), \sinh\left(\frac{sx}{c}\right) \right\}.$$

The solution that satisfies the right boundary condition is

$$\hat{u} = a \sinh\left(\frac{s(L-x)}{c}\right).$$

The left boundary condition determines the multiplicative constant.

$$\hat{u}(x, s) = \hat{f}(s) \frac{\sinh(s(L-x)/c)}{\sinh(sL/c)}$$

If we can find the inverse Laplace transform of

$$\hat{u}(x, s) = \frac{\sinh(s(L-x)/c)}{\sinh(sL/c)}$$

then we can use the convolution theorem to write  $u$  in terms of a single integral. We proceed by expanding this function in a sum.

$$\begin{aligned} \frac{\sinh(s(L-x)/c)}{\sinh(sL/c)} &= \frac{e^{s(L-x)/c} - e^{-s(L-x)/c}}{e^{sL/c} - e^{-sL/c}} \\ &= \frac{e^{-sx/c} - e^{-s(2L-x)/c}}{1 - e^{-2sL/c}} \\ &= (e^{-sx/c} - e^{-s(2L-x)/c}) \sum_{n=0}^{\infty} e^{-2nsL/c} \\ &= \sum_{n=0}^{\infty} e^{-s(2nL+x)/c} - \sum_{n=0}^{\infty} e^{-s(2(n+1)L-x)/c} \\ &= \sum_{n=0}^{\infty} e^{-s(2nL+x)/c} - \sum_{n=1}^{\infty} e^{-s(2nL-x)/c} \end{aligned}$$

Now we use the Laplace transform pair:

$$\mathcal{L}[\delta(x-a)] = e^{-sa}.$$

$$\mathcal{L}^{-1} \left[ \frac{\sinh(s(L-x)/c)}{\sinh(sL/c)} \right] = \sum_{n=0}^{\infty} \delta(t - (2nL+x)/c) - \sum_{n=1}^{\infty} \delta(t - (2nL-x)/c)$$

We write  $\hat{u}$  in the form,

$$\hat{u}(x, s) = \mathcal{L}[f(t)]\mathcal{L}\left[\sum_{n=0}^{\infty} \delta(t - (2nL + x)/c) - \sum_{n=1}^{\infty} \delta(t - (2nL - x)/c)\right].$$

By the convolution theorem we have

$$u(x, t) = \int_0^t f(\tau) \left( \sum_{n=0}^{\infty} \delta(t - \tau - (2nL + x)/c) - \sum_{n=1}^{\infty} \delta(t - \tau - (2nL - x)/c) \right) d\tau.$$

We can simplify this a bit. First we determine which Dirac delta functions have their singularities in the range  $\tau \in (0..t)$ . For the first sum, this condition is

$$0 < t - (2nL + x)/c < t.$$

The right inequality is always satisfied. The left inequality becomes

$$\begin{aligned} (2nL + x)/c &< t, \\ n &< \frac{ct - x}{2L}. \end{aligned}$$

For the second sum, the condition is

$$0 < t - (2nL - x)/c < t.$$

Again the right inequality is always satisfied. The left inequality becomes

$$n < \frac{ct + x}{2L}.$$

We change the index range to reflect the nonzero contributions and do the integration.

$$u(x, t) = \int_0^t f(\tau) \left( \sum_{n=0}^{\lfloor \frac{ct-x}{2L} \rfloor} \delta(t - \tau - (2nL + x)/c) - \sum_{n=1}^{\lfloor \frac{ct+x}{2L} \rfloor} \delta(t - \tau - (2nL - x)/c) \right) d\tau.$$

$$u(x, t) = \sum_{n=0}^{\lfloor \frac{ct-x}{2L} \rfloor} f(t - (2nL + x)/c) + \sum_{n=1}^{\lfloor \frac{ct+x}{2L} \rfloor} f(t - (2nL - x)/c)$$

### Solution 44.14

We take the Fourier transform of the partial differential equation and the boundary conditions.

$$-\omega^2 \hat{\phi} + \hat{\phi}_{yy} = 0, \quad \hat{\phi}(\omega, 0) = \frac{1}{2\pi} e^{-i\omega\xi}, \quad \hat{\phi}(\omega, l) = 0$$

We solve this boundary value problem.

$$\begin{aligned} \hat{\phi}(\omega, y) &= c_1 \cosh(\omega(l - y)) + c_2 \sinh(\omega(l - y)) \\ \hat{\phi}(\omega, y) &= \frac{1}{2\pi} e^{-i\omega\xi} \frac{\sinh(\omega(l - y))}{\sinh(\omega l)} \end{aligned}$$

We take the inverse Fourier transform to obtain an expression for the solution.

$$\phi(x, y) = \frac{1}{2\pi} \int_{-\infty}^{\infty} e^{i\omega(x-\xi)} \frac{\sinh(\omega(l - y))}{\sinh(\omega l)} d\omega$$

# Chapter 45

## Green Functions

### 45.1 Inhomogeneous Equations and Homogeneous Boundary Conditions

Consider a linear differential equation on the domain  $\Omega$  subject to homogeneous boundary conditions.

$$L[u(\mathbf{x})] = f(\mathbf{x}) \quad \text{for } \mathbf{x} \in \Omega, \quad B[u(\mathbf{x})] = 0 \quad \text{for } \mathbf{x} \in \partial\Omega \quad (45.1)$$

For example,  $L[u]$  might be

$$L[u] = u_t - \kappa\Delta u, \quad \text{or} \quad L[u] = u_{tt} - c^2\Delta u.$$

and  $B[u]$  might be  $u = 0$ , or  $\nabla u \cdot \hat{n} = 0$ .

If we find a Green function  $G(\mathbf{x}; \mathbf{x}i)$  that satisfies

$$L[G(\mathbf{x}; \mathbf{x}i)] = \delta(\mathbf{x} - \mathbf{x}i), \quad B[G(\mathbf{x}; \mathbf{x}i)] = 0$$

then the solution to Equation 45.1 is

$$u(\mathbf{x}) = \int_{\Omega} G(\mathbf{x}; \mathbf{x}i) f(\mathbf{x}i) \, d\mathbf{x}i.$$

We verify that this solution satisfies the equation and boundary condition.

$$\begin{aligned}L[u(\mathbf{x})] &= \int_{\Omega} L[G(\mathbf{x}; \mathbf{x}i)]f(\mathbf{x}i) \, d\mathbf{x}i \\ &= \int_{\Omega} \delta(\mathbf{x} - \mathbf{x}i)f(\mathbf{x}i) \, d\mathbf{x}i \\ &= f(\mathbf{x}) \\ B[u(\mathbf{x})] &= \int_{\Omega} B[G(\mathbf{x}; \mathbf{x}i)]f(\mathbf{x}i) \, d\mathbf{x}i \\ &= \int_{\Omega} 0 f(\mathbf{x}i) \, d\mathbf{x}i \\ &= 0\end{aligned}$$

## 45.2 Homogeneous Equations and Inhomogeneous Boundary Conditions

Consider a homogeneous linear differential equation on the domain  $\Omega$  subject to inhomogeneous boundary conditions,

$$L[u(\mathbf{x})] = 0 \quad \text{for } \mathbf{x} \in \Omega, \quad B[u(\mathbf{x})] = h(\mathbf{x}) \quad \text{for } \mathbf{x} \in \partial\Omega. \quad (45.2)$$

If we find a Green function  $g(\mathbf{x}; \mathbf{x}i)$  that satisfies

$$L[g(\mathbf{x}; \mathbf{x}i)] = 0, \quad B[g(\mathbf{x}; \mathbf{x}i)] = \delta(\mathbf{x} - \mathbf{x}i)$$

then the solution to Equation 45.2 is

$$u(\mathbf{x}) = \int_{\partial\Omega} g(\mathbf{x}; \mathbf{x}i)h(\mathbf{x}i) \, d\mathbf{x}i.$$

We verify that this solution satisfies the equation and boundary condition.

$$\begin{aligned}L[u(\mathbf{x})] &= \int_{\partial\Omega} L[g(\mathbf{x}; \mathbf{x}_i)]h(\mathbf{x}_i) \, d\mathbf{x}_i \\ &= \int_{\partial\Omega} 0 h(\mathbf{x}_i) \, d\mathbf{x}_i \\ &= 0\end{aligned}$$

$$\begin{aligned}B[u(\mathbf{x})] &= \int_{\partial\Omega} B[g(\mathbf{x}; \mathbf{x}_i)]h(\mathbf{x}_i) \, d\mathbf{x}_i \\ &= \int_{\partial\Omega} \delta(\mathbf{x} - \mathbf{x}_i)h(\mathbf{x}_i) \, d\mathbf{x}_i \\ &= h(\mathbf{x})\end{aligned}$$

**Example 45.2.1** Consider the Cauchy problem for the homogeneous heat equation.

$$\begin{aligned}u_t &= \kappa u_{xx}, \quad -\infty < x < \infty, \quad t > 0 \\ u(x, 0) &= h(x), \quad u(\pm\infty, t) = 0\end{aligned}$$

We find a Green function that satisfies

$$\begin{aligned}g_t &= \kappa g_{xx}, \quad -\infty < x < \infty, \quad t > 0 \\ g(x, 0; \xi) &= \delta(x - \xi), \quad g(\pm\infty, t; \xi) = 0.\end{aligned}$$

Then we write the solution

$$u(x, t) = \int_{-\infty}^{\infty} g(x, t; \xi)h(\xi) \, d\xi.$$

To find the Green function for this problem, we apply a Fourier transform to the equation and boundary condition



for  $g$ .

$$\begin{aligned}\hat{g}_t &= -\kappa\omega^2\hat{g}, & \hat{g}(\omega, 0; \xi) &= \mathcal{F}[\delta(x - \xi)] \\ \hat{g}(\omega, t; \xi) &= \mathcal{F}[\delta(x - \xi)] e^{-\kappa\omega^2 t} \\ \hat{g}(\omega, t; \xi) &= \mathcal{F}[\delta(x - \xi)] \mathcal{F} \left[ \sqrt{\frac{\pi}{\kappa t}} \exp\left(-\frac{x^2}{4\kappa t}\right) \right]\end{aligned}$$

We invert using the convolution theorem.

$$\begin{aligned}g(x, t; \xi) &= \frac{1}{2\pi} \int_{-\infty}^{\infty} \delta(\psi - \xi) \sqrt{\frac{\pi}{\kappa t}} \exp\left(-\frac{(x - \psi)^2}{4\kappa t}\right) d\psi \\ &= \frac{1}{\sqrt{4\pi\kappa t}} \exp\left(-\frac{(x - \xi)^2}{4\kappa t}\right)\end{aligned}$$

The solution of the heat equation is

$$u(x, t) = \frac{1}{\sqrt{4\pi\kappa t}} \int_{-\infty}^{\infty} \exp\left(-\frac{(x - \xi)^2}{4\kappa t}\right) h(\xi) d\xi.$$

## 45.3 Eigenfunction Expansions for Elliptic Equations

Consider a Green function problem for an elliptic equation on a finite domain.

$$\begin{aligned}L[G] &= \delta(\mathbf{x} - \mathbf{x}_i), & \mathbf{x} &\in \Omega \\ B[G] &= 0, & \mathbf{x} &\in \partial\Omega\end{aligned}\tag{45.3}$$

Let the set of functions  $\{\phi_{\mathbf{n}}\}$  be orthonormal and complete on  $\Omega$ . (Here  $\mathbf{n}$  is the multi-index  $\mathbf{n} = n_1, \dots, n_d$ .)

$$\int_{\Omega} \overline{\phi_{\mathbf{n}}(\mathbf{x})} \phi_{\mathbf{m}}(\mathbf{x}) d\mathbf{x} = \delta_{\mathbf{nm}}$$

In addition, let the  $\phi_{\mathbf{n}}$  be eigenfunctions of  $L$  subject to the homogeneous boundary conditions.

$$L[\phi_{\mathbf{n}}] = \lambda_{\mathbf{n}}\phi_{\mathbf{n}}, \quad B[\phi_{\mathbf{n}}] = 0$$

We expand the Green function in the eigenfunctions.

$$G = \sum_{\mathbf{n}} g_{\mathbf{n}}\phi_{\mathbf{n}}(\mathbf{x})$$

Then we expand the Dirac Delta function.

$$\begin{aligned} \delta(\mathbf{x} - \mathbf{x}i) &= \sum_{\mathbf{n}} d_{\mathbf{n}}\phi_{\mathbf{n}}(\mathbf{x}) \\ d_{\mathbf{n}} &= \int_{\Omega} \overline{\phi_{\mathbf{n}}(\mathbf{x})}\delta(\mathbf{x} - \mathbf{x}i) \, d\mathbf{x} \\ d_{\mathbf{n}} &= \overline{\phi_{\mathbf{n}}(\mathbf{x}i)} \end{aligned}$$

We substitute the series expansions for the Green function and the Dirac Delta function into Equation 45.3.

$$\sum_{\mathbf{n}} g_{\mathbf{n}}\lambda_{\mathbf{n}}\phi_{\mathbf{n}}(\mathbf{x}) = \sum_{\mathbf{n}} \overline{\phi_{\mathbf{n}}(\mathbf{x}i)}\phi_{\mathbf{n}}(\mathbf{x})$$

We equate coefficients to solve for the  $g_{\mathbf{n}}$  and hence determine the Green function.

$$\begin{aligned} g_{\mathbf{n}} &= \frac{\overline{\phi_{\mathbf{n}}(\mathbf{x}i)}}{\lambda_{\mathbf{n}}} \\ G(\mathbf{x}; \mathbf{x}i) &= \sum_{\mathbf{n}} \frac{\overline{\phi_{\mathbf{n}}(\mathbf{x}i)}\phi_{\mathbf{n}}(\mathbf{x})}{\lambda_{\mathbf{n}}} \end{aligned}$$

**Example 45.3.1** Consider the Green function for the reduced wave equation,  $\Delta u - k^2u$  in the rectangle,  $0 \leq x \leq a$ ,  $0 \leq y \leq b$ , and vanishing on the sides.

First we find the eigenfunctions of the operator  $L = \Delta - k^2 = 0$ . Note that  $\phi = X(x)Y(y)$  is an eigenfunction of  $L$  if  $X$  is an eigenfunction of  $\frac{\partial^2}{\partial x^2}$  and  $Y$  is an eigenfunction of  $\frac{\partial^2}{\partial y^2}$ . Thus we consider the two regular Sturm-Liouville eigenvalue problems:

$$\begin{aligned} X'' &= \lambda X, & X(0) &= X(a) = 0 \\ Y'' &= \lambda Y, & Y(0) &= Y(b) = 0 \end{aligned}$$

This leads us to the eigenfunctions

$$\phi_{mn} = \sin\left(\frac{m\pi x}{a}\right) \sin\left(\frac{n\pi y}{b}\right).$$

We use the orthogonality relation

$$\int_0^{2\pi} \sin\left(\frac{m\pi x}{a}\right) \sin\left(\frac{n\pi x}{a}\right) dx = \frac{a}{2} \delta_{mn}$$

to make the eigenfunctions orthonormal.

$$\phi_{mn} = \frac{2}{\sqrt{ab}} \sin\left(\frac{m\pi x}{a}\right) \sin\left(\frac{n\pi y}{b}\right), \quad m, n \in \mathbb{Z}^+$$

The  $\phi_{mn}$  are eigenfunctions of  $L$ .

$$L[\phi_{mn}] = -\left(\left(\frac{m\pi}{a}\right)^2 + \left(\frac{n\pi}{b}\right)^2 + k^2\right) \phi_{mn}$$

By expanding the Green function and the Dirac Delta function in the  $\phi_{mn}$  and substituting into the differential equation we obtain the solution.

$$G = \sum_{m,n=1}^{\infty} \frac{\frac{2}{\sqrt{ab}} \sin\left(\frac{m\pi\xi}{a}\right) \sin\left(\frac{n\pi\psi}{b}\right) \frac{2}{\sqrt{ab}} \sin\left(\frac{m\pi x}{a}\right) \sin\left(\frac{n\pi y}{b}\right)}{-\left(\left(\frac{m\pi}{a}\right)^2 + \left(\frac{n\pi}{b}\right)^2 + k^2\right)}$$

$$G(x, y; \xi, \psi) = -4ab \sum_{m,n=1}^{\infty} \frac{\sin\left(\frac{m\pi x}{a}\right) \sin\left(\frac{m\pi\xi}{a}\right) \sin\left(\frac{n\pi y}{b}\right) \sin\left(\frac{n\pi\psi}{b}\right)}{(m\pi b)^2 + (n\pi a)^2 + (kab)^2}$$

**Example 45.3.2** Consider the Green function for Laplace's equation,  $\Delta u = 0$  in the disk,  $|r| < a$ , and vanishing at  $r = a$ .

First we find the eigenfunctions of the operator

$$\Delta = \frac{\partial^2}{\partial r^2} + \frac{1}{r} \frac{\partial}{\partial r} + \frac{1}{r^2} \frac{\partial^2}{\partial \theta^2}.$$

We will look for eigenfunctions of the form  $\phi = \Theta(\theta)R(r)$ . We choose the  $\Theta$  to be eigenfunctions of  $\frac{d^2}{d\theta^2}$  subject to the periodic boundary conditions in  $\theta$ .

$$\begin{aligned} \Theta'' &= \lambda\Theta, & \Theta(0) &= \Theta(2\pi), & \Theta'(0) &= \Theta'(2\pi) \\ \Theta_n &= e^{in\theta}, & n &\in \mathbb{Z} \end{aligned}$$

We determine  $R(r)$  by requiring that  $\phi$  be an eigenfunction of  $\Delta$ .

$$\begin{aligned} \Delta\phi &= \lambda\phi \\ (\Theta_n R)_{rr} + \frac{1}{r}(\Theta_n R)_r + \frac{1}{r^2}(\Theta_n R)_{\theta\theta} &= \lambda\Theta_n R \\ \Theta_n R'' + \frac{1}{r}\Theta_n R' + \frac{1}{r^2}(-n^2)\Theta_n R &= \lambda\Theta_n R \end{aligned}$$

For notational convenience, we denote  $\lambda = -\mu^2$ .

$$R'' + \frac{1}{r}R' + \left(\mu^2 - \frac{n^2}{r^2}\right)R = 0, \quad R(0) \text{ bounded}, \quad R(a) = 0$$

The general solution for  $R$  is

$$R = c_1 J_n(\mu r) + c_2 Y_n(\mu r).$$

The left boundary condition demands that  $c_2 = 0$ . The right boundary condition determines the eigenvalues.

$$R_{nm} = J_n\left(\frac{j_{n,m}r}{a}\right), \quad \mu_{nm} = \frac{j_{n,m}}{a}$$

Here  $j_{n,m}$  is the  $m^{\text{th}}$  positive root of  $J_n$ . This leads us to the eigenfunctions

$$\phi_{nm} = e^{in\theta} J_n \left( \frac{j_{n,m}r}{a} \right)$$

We use the orthogonality relations

$$\int_0^{2\pi} e^{-im\theta} e^{in\theta} d\theta = 2\pi\delta_{mn},$$

$$\int_0^1 r J_\nu(j_{\nu,m}r) J_\nu(j_{\nu,n}r) dr = \frac{1}{2} (J'_\nu(j_{\nu,n}))^2 \delta_{mn}$$

to make the eigenfunctions orthonormal.

$$\phi_{nm} = \frac{1}{\sqrt{\pi a} |J'_n(j_{n,m})|} e^{in\theta} J_n \left( \frac{j_{n,m}r}{a} \right), \quad n \in \mathbb{Z}, \quad m \in \mathbb{Z}^+$$

The  $\phi_{nm}$  are eigenfunctions of  $L$ .

$$\Delta\phi_{nm} = - \left( \frac{j_{n,m}}{a} \right)^2 \phi_{nm}$$

By expanding the Green function and the Dirac Delta function in the  $\phi_{nm}$  and substituting into the differential equation we obtain the solution.

$$G = \sum_{n=-\infty}^{\infty} \sum_{m=1}^{\infty} \frac{\frac{1}{\sqrt{\pi a} |J'_n(j_{n,m})|} e^{-in\vartheta} J_n \left( \frac{j_{n,m}\rho}{a} \right) \frac{1}{\sqrt{\pi a} |J'_n(j_{n,m})|} e^{in\theta} J_n \left( \frac{j_{n,m}r}{a} \right)}{- \left( \frac{j_{n,m}}{a} \right)^2}$$

$$G(r, \theta; \rho, \vartheta) = - \sum_{n=-\infty}^{\infty} \sum_{m=1}^{\infty} \frac{1}{\pi (j_{n,m} J'_n(j_{n,m}))^2} e^{in(\theta-\vartheta)} J_n \left( \frac{j_{n,m}\rho}{a} \right) J_n \left( \frac{j_{n,m}r}{a} \right)$$

## 45.4 The Method of Images

Consider Poisson's equation in the upper half plane.

$$\begin{aligned}\nabla^2 u &= f(x, y), & -\infty < x < \infty, & \quad y > 0 \\ u(x, 0) &= 0, & u(x, y) &\rightarrow 0 \text{ as } x^2 + y^2 \rightarrow \infty\end{aligned}$$

The associated Green function problem is

$$\begin{aligned}\nabla^2 G &= \delta(x - \xi)\delta(y - \psi), & -\infty < x < \infty, & \quad y > 0 \\ G(x, 0|\xi, \psi) &= 0, & G(x, y|\xi, \psi) &\rightarrow 0 \text{ as } x^2 + y^2 \rightarrow \infty.\end{aligned}$$

We will solve the Green function problem with the method of images. We expand the domain to include the lower half plane. We place a negative image of the source in the lower half plane. This will make the Green function odd about  $y = 0$ , i.e.  $G(x, 0|\xi, \psi) = 0$ .

$$\begin{aligned}\nabla^2 G &= \delta(x - \xi)\delta(y - \psi) - \delta(x - \xi)\delta(y + \psi), & -\infty < x < \infty, & \quad y > 0 \\ G(x, y|\xi, \psi) &\rightarrow 0 \text{ as } x^2 + y^2 \rightarrow \infty\end{aligned}$$

Recall that the infinite space Green function which satisfies  $\Delta F = \delta(x - \xi)\delta(y - \psi)$  is

$$F(x, y|\xi, \psi) = \frac{1}{4\pi} \ln \left( (x - \xi)^2 + (y - \psi)^2 \right).$$

We solve for  $G$  by using the infinite space Green function.

$$\begin{aligned}G &= F(x, y|\xi, \psi) - F(x, y|\xi, -\psi) \\ &= \frac{1}{4\pi} \ln \left( (x - \xi)^2 + (y - \psi)^2 \right) - \frac{1}{4\pi} \ln \left( (x - \xi)^2 + (y + \psi)^2 \right) \\ &= \frac{1}{4\pi} \ln \left( \frac{(x - \xi)^2 + (y - \psi)^2}{(x - \xi)^2 + (y + \psi)^2} \right)\end{aligned}$$

We write the solution of Poisson's equation using the Green function.

$$u(x, y) = \int_0^\infty \int_{-\infty}^\infty G(x, y|\xi, \psi) f(\xi, \psi) d\xi d\psi$$

$$u(x, y) = \int_0^\infty \int_{-\infty}^\infty \frac{1}{4\pi} \ln \left( \frac{(x - \xi)^2 + (y - \psi)^2}{(x - \xi)^2 + (y + \psi)^2} \right) f(\xi, \psi) d\xi d\psi$$

## 45.5 Exercises

### Exercise 45.1

Consider the Cauchy problem for the diffusion equation with a source.

$$u_t - \kappa u_{xx} = s(x, t), \quad u(x, 0) = f(x), \quad u \rightarrow 0 \text{ as } x \rightarrow \pm\infty$$

Find the Green function for this problem and use it to determine the solution.

### Exercise 45.2

Consider the 2-dimensional wave equation

$$u_{tt} - c^2(u_{xx} + u_{yy}) = 0.$$

1. Determine the fundamental solution for this equation. (i.e. response to source at  $t = \tau$ ,  $\mathbf{x} = \boldsymbol{\xi}$ ). You may find the following information useful about the Bessel function:

$$J_0(x) = \frac{1}{\pi} \int_0^\pi e^{ix \cos \theta} d\theta,$$
$$\int_0^\infty J_0(ax) \sin(bx) dx = \begin{cases} 0, & 0 < b < a \\ \frac{1}{\sqrt{b^2 - a^2}}, & 0 < a < b \end{cases}$$

2. Use the “method of descents” to recover the 1-D fundamental solution.

### Exercise 45.3

Consider the linear wave equation

$$u_{tt} = c^2 u_{xx},$$

with constant  $c$ , on the infinite domain  $-\infty < x < \infty$ .

1. By using the Fourier transform find the solution of  $G_{tt} = c^2 G_{xx}$  subject to initial conditions  $G(x, 0) = 0$ ,  $G_t(x, 0) = \delta(x - \xi)$ .



2. Now use this to find  $u$  in the case where  $c = 1$ ,  $u(x, 0) = 0$ , and

$$u_t(x, 0) = \begin{cases} 0 & |x| > 1 \\ 1 - |x| & |x| < 1 \end{cases}$$

Sketch the solution in  $x$  for fixed times  $t < 1$  and  $t > 1$  and also indicate on the  $x, t$  ( $t > 0$ ) plane the regions of qualitatively different behavior of  $u$ .

#### Exercise 45.4

Consider a generalized Laplace equation with non-constant coefficients of the form:

$$\nabla^2 u + \mathbf{A}(\mathbf{x}) \cdot \nabla u + h(\mathbf{x})u = q(\mathbf{x}),$$

on a region  $V$  with  $u = 0$  on the boundary  $S$ . Suppose we find a Green function which satisfies

$$\nabla^2 G + \mathbf{A}(\mathbf{x}) \cdot \nabla G + h(\mathbf{x})G = \delta(\mathbf{x} - \boldsymbol{\xi}).$$

Use the divergence theorem to derive an appropriate generalized Green's identity and show that

$$u(\boldsymbol{\xi}) \neq \int_V G(\mathbf{x}|\boldsymbol{\xi})q(\mathbf{x}) \, d\mathbf{x}.$$

What equation should the Green function satisfy? Note: this equation is called the *adjoint* of the original partial differential equation.

#### Exercise 45.5

Consider Laplace's equation in the infinite three dimensional domain with two sources of equal strength  $C$ , opposite sign and separated by a distance  $\epsilon$ .

$$\nabla^2 u = C\delta(\mathbf{x} - \boldsymbol{\xi}_+) - C\delta(\mathbf{x} - \boldsymbol{\xi}_-),$$

where  $\boldsymbol{\xi}_\pm = (\pm \frac{\epsilon}{2}, 0, 0)$ .

1. Find the solution in terms of the fundamental solutions.

2. Now consider the limit in which the distance between sources goes to zero ( $\epsilon \rightarrow 0$ ) and the strength increases in such a way that  $C\epsilon = D$  remains fixed. Show that the solution can be written

$$u = -\frac{Dx}{4\pi r^3},$$

where  $r = |\mathbf{x}|$ . This is called the response to a *dipole* located at the origin, with strength  $D$ , and oriented in the positive  $x$  direction.

3. Show that in general the response to a unit ( $D = 1$ ) dipole at an arbitrary point  $\xi_0$  and oriented in the direction of the unit vector  $\mathbf{a}$  is

$$u(\mathbf{x}) = -\frac{1}{4\pi} \nabla_{\xi} \left( \frac{1}{|\mathbf{x} - \xi|} \right) \Big|_{\xi=\xi_0} \cdot \vec{a}$$

### Exercise 45.6

Consider Laplace's equation

$$\nabla^2 u = 0,$$

inside the unit circle with boundary condition  $u = f(\theta)$ . By using the Green function for the Dirichlet problem on the circle:

$$G(\mathbf{x}|\xi) = \frac{1}{2\pi} \ln \left( \frac{|\mathbf{x} - \xi|}{|\xi||\mathbf{x} - \xi^*|} \right),$$

where  $\xi$  and  $\xi^*$  have the same polar angle and  $|\xi^*| = \frac{1}{|\xi|}$ , show that the solution may be expressed in polar coordinates as

$$u(r, \theta) = \frac{1 - r^2}{2\pi} \int_0^{2\pi} \frac{f(\vartheta)}{1 + r^2 - 2r \cos(\theta - \vartheta)} d\vartheta.$$

### Exercise 45.7

Consider an alternate derivation of the fundamental solution of Laplace's equation

$$\nabla^2 u = \delta(\mathbf{x}),$$

with  $u \rightarrow 0$  as  $|\mathbf{x}| \rightarrow \infty$  in three dimensions.

1. Convert this equation to spherical coordinates. You may define a new delta function

$$\delta_3(r) = \delta(x)\delta(y)\delta(z) \quad \text{such that} \quad \int_B \delta_3(r) dV = \begin{cases} 1 & \text{if } B \text{ contains the origin} \\ 0 & \text{otherwise} \end{cases}$$

2. Show, by symmetry, that this can be reduced to an ordinary differential equation. Solve to find the general solution of the homogeneous equation. Now determine the constants by using the constraint that  $u \rightarrow 0$  as  $|\mathbf{x}| \rightarrow \infty$ , and by integrating the partial differential equation over a small ball around the origin (and using Gauss' theorem).
3. Now use similar ideas to re-derive the fundamental solution in two dimensions. Can we still say  $u \rightarrow 0$  as  $|\mathbf{x}| \rightarrow \infty$ ? Use instead the constraint that  $u = 0$  when  $|\mathbf{x}| = 1$ .
4. Finally derive the 2-D solution from the 3-D one using the "method of descent". Consider Laplace's equation in three dimensions with a line source at  $x = 0, y = 0, -\infty < z < \infty$ ,

$$u_{xx} + u_{yy} + u_{zz} = \delta(x)\delta(y).$$

Use the fundamental solution to find  $u(r)$  where  $r = \sqrt{x^2 + y^2}$ , and without loss of generality we have taken the plane at  $z = 0$ . Then evaluate this integral to find  $u$ . (*Hint*: first try to compute  $u_r$ )

### Exercise 45.8

Consider the heat equation on the bounded domain  $0 < x < L$  with fixed temperature at each end. Use Laplace transforms to determine the Green Function which satisfies

$$\begin{aligned} G_t - \nu G_{xx} &= \delta(x - \xi)\delta(t), \\ G(0, t) &= 0 \quad G(L, t) = 0, \\ G(x, 0^-) &= 0. \end{aligned}$$

1. First show that

$$\mathcal{L}[G(x, t)] = \frac{\cosh\left(\sqrt{\frac{s}{\nu}}(L - x_> + x_<)\right) - \cosh\left(\sqrt{\frac{s}{\nu}}(L - x_> - x_<)\right)}{2\sqrt{\nu s} \sinh\left(\sqrt{\frac{s}{\nu}}L\right)}$$

2. Show that this can be re-written as

$$\mathcal{L}[G(x, t)] = \sum_{k=-\infty}^{\infty} \frac{1}{2\sqrt{\nu s}} e^{-\sqrt{\frac{s}{\nu}}|x-\xi-2kL|} - \frac{1}{2\sqrt{\nu s}} e^{-\sqrt{\frac{s}{\nu}}|x+\xi-2kL|}.$$

3. Use this to find  $G$  in terms of fundamental solutions

$$f(x, t) = \frac{1}{2\sqrt{\nu\pi t}} e^{-\frac{x^2}{4\nu t}},$$

and comment on how this Green's function corresponds to "real" and "image" sources. Additionally compare this to the alternative expression,

$$G(x, t) = \frac{2}{L} \sum_{n=1}^{\infty} e^{-\frac{\nu n^2 \pi^2}{L^2} t} \sin \frac{n\pi x}{L} \sin \frac{n\pi \xi}{L},$$

and comment on the convergence of the respective formulations for small and large time.

### Exercise 45.9

Consider the Green function for the 1-D heat equation

$$G_t - \nu G_{xx} = \delta(x - \xi)\delta(t - \tau),$$

on the semi-infinite domain with insulated end

$$G_x(0, t) = 0, \quad G \rightarrow 0 \text{ as } x \rightarrow \infty,$$

and subject to the initial condition

$$G(x, \tau^-) = 0.$$

1. Solve for  $G$  with the Fourier cosine transform.

2. (15 points) Relate this to the fundamental solution on the infinite domain, and discuss in terms of responses to “real” and “image” sources. Give the solution for  $x > 0$  of

$$\begin{aligned} u_t - \nu u_{xx} &= q(x, t), \\ u_x(0, t) &= 0, \quad u \rightarrow 0 \text{ as } x \rightarrow \infty, \\ u(x, 0) &= f(x). \end{aligned}$$

### Exercise 45.10

Consider the heat equation

$$u_t = \nu u_{xx} + \delta(x - \xi)\delta(t),$$

on the infinite domain  $-\infty < x < \infty$ , where we assume  $u \rightarrow 0$  as  $x \rightarrow \pm\infty$  and initially  $u(x, 0^-) = 0$ .

1. First convert this to a problem where there is no forcing, so that

$$u_t = \nu u_{xx}$$

with an appropriately modified initial condition.

2. Now use Laplace transforms to convert this to an ordinary differential equation in  $\hat{u}(x, s)$ , where  $\hat{u}(x, s) = \mathcal{L}[u(x, t)]$ . Solve this ordinary differential equation and show that

$$\hat{u}(x, s) = \frac{1}{2\sqrt{\nu s}} e^{-\sqrt{\frac{s}{\nu}}|x-\xi|}.$$

Recall  $\hat{f}(s) = \mathcal{L}[f(t)] = \int_0^\infty e^{-st} f(t) dt$ .

3. Finally use the Laplace inversion formula and Cauchy’s Theorem on an appropriate contour to compute  $u(x, t)$ . Recall

$$f(t) = \mathcal{L}^{-1}[F(s)] = \frac{1}{i2\pi} \int_{\Gamma} F(s) e^{st} ds,$$

where  $\Gamma$  is the Bromwich contour ( $s = a + it$  where  $t \in (-\infty \dots \infty)$  and  $a$  is a non-negative constant such that the contour lies to the right of all poles of  $\hat{f}$ ).

**Exercise 45.11**

Derive the causal Green function for the one dimensional wave equation on  $(-\infty.. \infty)$ . That is, solve

$$G_{tt} - c^2 G_{xx} = \delta(x - \xi)\delta(t - \tau),$$

$$G(x, t; \xi, \tau) = 0 \quad \text{for } t < \tau.$$

Use the Green function to find the solution of the following wave equation with a source term.

$$u_{tt} - c^2 u_{xx} = q(x, t), \quad u(x, 0) = u_t(x, 0) = 0$$

**Exercise 45.12**

By reducing the problem to a series of one dimensional Green function problems, determine  $G(\mathbf{x}, \mathbf{x}_i)$  if

$$\nabla^2 G = \delta(\mathbf{x} - \mathbf{x}_i)$$

(a) on the rectangle  $0 < x < L$ ,  $0 < y < H$  and

$$G(0, y; \xi, \psi) = G_x(L, y; \xi, \psi) = G_y(x, 0; \xi, \psi) = G_y(x, H; \xi, \psi) = 0$$

(b) on the box  $0 < x < L$ ,  $0 < y < H$ ,  $0 < z < W$  with  $G = 0$  on the boundary.

(c) on the semi-circle  $0 < r < a$ ,  $0 < \theta < \pi$  with  $G = 0$  on the boundary.

(d) on the quarter-circle  $0 < r < a$ ,  $0 < \theta < \pi/2$  with  $G = 0$  on the straight sides and  $G_r = 0$  at  $r = a$ .

**Exercise 45.13**

Using the method of multi-dimensional eigenfunction expansions, determine  $G(\mathbf{x}, \mathbf{x}_0)$  if

$$\nabla^2 G = \delta(\mathbf{x} - \mathbf{x}_0)$$

and

(a) on the rectangle ( $0 < x < L$ ,  $0 < y < H$ )

$$\begin{array}{ll} \text{at } x = 0, & G = 0 \\ \text{at } x = L, & \frac{\partial G}{\partial x} = 0 \end{array} \quad \begin{array}{ll} \text{at } y = 0, & \frac{\partial G}{\partial y} = 0 \\ \text{at } y = H, & \frac{\partial G}{\partial y} = 0 \end{array}$$

(b) on the rectangular shaped box ( $0 < x < L$ ,  $0 < y < H$ ,  $0 < z < W$ ) with  $G = 0$  on the six sides.

(c) on the semi-circle ( $0 < r < a$ ,  $0 < \theta < \pi$ ) with  $G = 0$  on the entire boundary.

(d) on the quarter-circle ( $0 < r < a$ ,  $0 < \theta < \pi/2$ ) with  $G = 0$  on the straight sides and  $\partial G/\partial r = 0$  at  $r = a$ .

### Exercise 45.14

Using the method of images solve

$$\nabla^2 G = \delta(\mathbf{x} - \mathbf{x}_0)$$

in the first quadrant ( $x \geq 0$  and  $y \geq 0$ ) with  $G = 0$  at  $x = 0$  and  $\partial G/\partial y = 0$  at  $y = 0$ . Use the Green function to solve in the first quadrant

$$\begin{aligned} \nabla^2 u &= 0 \\ u(0, y) &= g(y) \\ \frac{\partial u}{\partial y}(x, 0) &= h(x). \end{aligned}$$

**Exercise 45.15**

Consider the wave equation defined on the half-line  $x > 0$ :

$$\begin{aligned}\frac{\partial^2 u}{\partial t^2} &= c^2 \frac{\partial^2 u}{\partial x^2} + Q(x, t), \\ u(x, 0) &= f(x) \\ \frac{\partial u}{\partial t}(x, 0) &= g(x) \\ u(0, t) &= h(t)\end{aligned}$$

- Determine the appropriate Green's function using the method of images.
- Solve for  $u(x, t)$  if  $Q(x, t) = 0$ ,  $f(x) = 0$ , and  $g(x) = 0$ .
- For what values of  $t$  does  $h(t)$  influence  $u(x_1, t_1)$ . Interpret this result physically.

**Exercise 45.16**

Derive the Green functions for the one dimensional wave equation on  $(-\infty.. \infty)$  for non-homogeneous initial conditions. Solve the two problems

$$\begin{aligned}g_{tt} - c^2 g_{xx} &= 0, & g(x, 0; \xi, \tau) &= \delta(x - \xi), & g_t(x, 0; \xi, \tau) &= 0, \\ \gamma_{tt} - c^2 \gamma_{xx} &= 0, & \gamma(x, 0; \xi, \tau) &= 0, & \gamma_t(x, 0; \xi, \tau) &= \delta(x - \xi),\end{aligned}$$

using the Fourier transform.

**Exercise 45.17**

Use the Green functions from Problem [45.11](#) and Problem [45.16](#) to solve

$$\begin{aligned}u_{tt} - c^2 u_{xx} &= f(x, t), & x > 0, & & -\infty < t < \infty \\ u(x, 0) &= p(x), & u_t(x, 0) &= q(x).\end{aligned}$$

Use the solution to determine the domain of dependence of the solution.



**Exercise 45.18**

Show that the Green function for the reduced wave equation,  $\Delta u - k^2 u = 0$  in the rectangle,  $0 \leq x \leq a$ ,  $0 \leq y \leq b$ , and vanishing on the sides is:

$$G(x, y; \xi, \psi) = \frac{2}{a} \sum_{n=1}^{\infty} \frac{\sinh(\sigma_n y_{<}) \sinh(\sigma_n (y_{>} - b))}{\sigma_n \sinh(\sigma_n b)} \sin\left(\frac{n\pi x}{a}\right) \sin\left(\frac{n\pi \xi}{a}\right),$$

where

$$\sigma_n = \sqrt{k^2 + \frac{n^2 \pi^2}{a^2}}.$$

**Exercise 45.19**

Find the Green function for the reduced wave equation  $\Delta u - k^2 u = 0$ , in the quarter plane:  $0 < x < \infty$ ,  $0 < y < \infty$  subject to the mixed boundary conditions:

$$u(x, 0) = 0, \quad u_x(0, y) = 0.$$

Find two distinct integral representations for  $G(x, y; \xi, \psi)$ .

**Exercise 45.20**

Show that in polar coordinates the Green function for  $\Delta u = 0$  in the infinite sector,  $0 < \theta < \alpha$ ,  $0 < r < \infty$ , and vanishing on the sides is given by,

$$G(r, \theta, \rho, \vartheta) = \frac{1}{4\pi} \ln \left( \frac{\cosh\left(\frac{\pi}{\alpha} \ln \frac{r}{\rho}\right) - \cos\left(\frac{\pi}{\alpha}(\theta - \vartheta)\right)}{\cosh\left(\frac{\pi}{\alpha} \ln \frac{r}{\rho}\right) - \cos\left(\frac{\pi}{\alpha}(\theta + \vartheta)\right)} \right).$$

Use this to find the harmonic function  $u(r, \theta)$  in the given sector which takes on the boundary values:

$$u(r, \theta) = u(r, \alpha) = \begin{cases} 0 & \text{for } r < c \\ 1 & \text{for } r > c. \end{cases}$$

**Exercise 45.21**

The Green function for the initial value problem,

$$u_t - \kappa u_{xx} = 0, \quad u(x, 0) = f(x),$$

on  $-\infty < x < \infty$  is

$$G(x, t; \xi) = \frac{1}{\sqrt{4\pi\kappa t}} e^{-(x-\xi)^2/(4\kappa t)}.$$

Use the method of images to find the corresponding Green function for the mixed initial-boundary problems:

$$1. \quad u_t = \kappa u_{xx}, \quad u(x, 0) = f(x) \text{ for } x > 0, \quad u(0, t) = 0,$$

$$2. \quad u_t = \kappa u_{xx}, \quad u(x, 0) = f(x) \text{ for } x > 0, \quad u_x(0, t) = 0.$$

**Exercise 45.22**

Find the Green function (expansion) for the one dimensional wave equation  $u_{tt} - c^2 u_{xx} = 0$  on the interval  $0 < x < L$ , subject to the boundary conditions:

$$a) \quad u(0, t) = u_x(L, t) = 0,$$

$$b) \quad u_x(0, t) = u_x(L, t) = 0.$$

Write the final forms in terms showing the propagation properties of the wave equation, i.e., with arguments  $((x \pm \xi) \pm (t - \tau))$ .

**Exercise 45.23**

Solve, using the above determined Green function,

$$u_{tt} - c^2 u_{xx} = 0, \quad 0 < x < 1, \quad t > 0,$$

$$u_x(0, t) = u_x(1, t) = 0,$$

$$u(x, 0) = x^2(1-x)^2, \quad u_t(x, 0) = 1.$$

For  $c = 1$ , find  $u(x, t)$  at  $x = 3/4$ ,  $t = 7/2$ .

## 45.6 Hints

**Hint 45.1**

**Hint 45.2**

**Hint 45.3**

**Hint 45.4**

**Hint 45.5**

**Hint 45.6**

**Hint 45.7**

**Hint 45.8**

**Hint 45.9**

**Hint 45.10**

**Hint 45.11****Hint 45.12**

Take a Fourier transform in  $x$ . This will give you an ordinary differential equation Green function problem for  $\hat{G}$ . Find the continuity and jump conditions at  $t = \tau$ . After solving for  $\hat{G}$ , do the inverse transform with the aid of a table.

**Hint 45.13****Hint 45.14****Hint 45.15****Hint 45.16****Hint 45.17****Hint 45.18**

Use Fourier sine and cosine transforms.

**Hint 45.19**

The the conformal mapping  $z = w^{\pi/\alpha}$  to map the sector to the upper half plane. The new problem will be

$$G_{xx} + G_{yy} = \delta(x - \xi)\delta(y - \psi), \quad -\infty < x < \infty, \quad 0 < y < \infty,$$

$$G(x, 0, \xi, \psi) = 0,$$

$$G(x, y, \xi, \psi) \rightarrow 0 \text{ as } x, y \rightarrow \infty.$$

Solve this problem with the image method.

**Hint 45.20**

**Hint 45.21**

**Hint 45.22**

## 45.7 Solutions

### Solution 45.1

The Green function problem is

$$G_t - \kappa G_{xx} = \delta(x - \xi)\delta(t - \tau), \quad G(x, t|\xi, \tau) = 0 \text{ for } t < \tau, \quad G \rightarrow 0 \text{ as } x \rightarrow \pm\infty$$

We take the Fourier transform of the differential equation.

$$\hat{G}_t + \kappa\omega^2\hat{G} = \mathcal{F}[\delta(x - \xi)]\delta(t - \tau), \quad \hat{G}(\omega, t|\xi, \tau) = 0 \text{ for } t < \tau$$

Now we have an ordinary differential equation Green function problem for  $\hat{G}$ . The homogeneous solution of the ordinary differential equation is

$$e^{-\kappa\omega^2 t}$$

The jump condition is

$$\hat{G}(\omega, 0; \xi, \tau^+) = \mathcal{F}[\delta(x - \xi)].$$

We write the solution for  $\hat{G}$  and invert using the convolution theorem.

$$\begin{aligned} \hat{G} &= \mathcal{F}[\delta(x - \xi)] e^{-\kappa\omega^2(t-\tau)} H(t - \tau) \\ \hat{G} &= \mathcal{F}[\delta(x - \xi)] \mathcal{F} \left[ \sqrt{\frac{\pi}{\kappa(t - \tau)}} e^{-x^2/(4\kappa(t-\tau))} \right] H(t - \tau) \\ G &= \frac{1}{2\pi} \int_{-\infty}^{\infty} \delta(x - y - \xi) \sqrt{\frac{\pi}{\kappa(t - \tau)}} e^{-y^2/(4\kappa(t-\tau))} dy H(t - \tau) \end{aligned}$$

$$G = \frac{1}{\sqrt{4\pi\kappa(t - \tau)}} e^{-(x-\xi)^2/(4\kappa(t-\tau))} H(t - \tau)$$

We write the solution of the diffusion equation using the Green function.

$$u = \int_0^\infty \int_{-\infty}^\infty G(x, t|\xi, \tau) s(\xi, \tau) d\xi d\tau + \int_{-\infty}^\infty G(x, t|\xi, 0) f(\xi) d\xi$$

$$u = \int_0^t \frac{1}{\sqrt{4\pi\kappa(t - \tau)}} \int_{-\infty}^\infty e^{-(x-\xi)^2/(4\kappa(t-\tau))} s(\xi, \tau) d\xi d\tau + \frac{1}{\sqrt{4\pi\kappa t}} \int_{-\infty}^\infty e^{-(x-\xi)^2/(4\kappa t)} f(\xi) d\xi$$

## Solution 45.2

1. We apply Fourier transforms in  $x$  and  $y$  to the Green function problem.

$$\begin{aligned}G_{tt} - c^2(G_{xx} + G_{yy}) &= \delta(t - \tau)\delta(x - \xi)\delta(y - \eta) \\ \hat{G}_{tt} + c^2(\alpha^2 + \beta^2)\hat{G} &= \delta(t - \tau)\frac{1}{2\pi}e^{-i\alpha\xi}\frac{1}{2\pi}e^{-i\beta\eta}\end{aligned}$$

This gives us an ordinary differential equation Green function problem for  $\hat{G}(\alpha, \beta, t)$ . We find the causal solution. That is, the solution that satisfies  $\hat{G}(\alpha, \beta, t) = 0$  for  $t < \tau$ .

$$\hat{G} = \frac{\sin\left(\sqrt{\alpha^2 + \beta^2}c(t - \tau)\right)}{c\sqrt{\alpha^2 + \beta^2}}\frac{1}{4\pi^2}e^{-i(\alpha\xi + \beta\eta)}H(t - \tau)$$

Now we take inverse Fourier transforms in  $\alpha$  and  $\beta$ .

$$G = \int_{-\infty}^{\infty} \int_{-\infty}^{\infty} \frac{e^{i(\alpha(x-\xi) + \beta(y-\eta))}}{4\pi^2 c \sqrt{\alpha^2 + \beta^2}} \sin\left(\sqrt{\alpha^2 + \beta^2}c(t - \tau)\right) d\alpha d\beta H(t - \tau)$$

We make the change of variables  $\alpha = \rho \cos \phi$ ,  $\beta = \rho \sin \phi$  and do the integration in polar coordinates.

$$G = \frac{1}{4\pi^2 c} \int_0^{2\pi} \int_0^{\infty} \frac{e^{i\rho((x-\xi)\cos\phi + (y-\eta)\sin\phi)}}{\rho} \sin(\rho c(t - \tau)) \rho d\rho d\phi H(t - \tau)$$

Next we introduce polar coordinates for  $x$  and  $y$ .

$$\begin{aligned}
 x - \xi &= r \cos \theta, & y - \eta &= r \sin \theta \\
 G &= \frac{1}{4\pi^2 c} \int_0^\infty \int_0^{2\pi} e^{i r \rho (\cos \theta \cos \phi + \sin \theta \sin \phi)} d\phi \sin(\rho c(t - \tau)) d\rho H(t - \tau) \\
 G &= \frac{1}{4\pi^2 c} \int_0^\infty \int_0^{2\pi} e^{i r \rho \cos(\phi - \theta)} d\phi \sin(\rho c(t - \tau)) d\rho H(t - \tau) \\
 G &= \frac{1}{2\pi c} \int_0^\infty J_0(r\rho) \sin(\rho c(t - \tau)) d\rho H(t - \tau) \\
 G &= \frac{1}{2\pi c} \frac{1}{\sqrt{(c(t - \tau))^2 - r^2}} H(c(t - \tau) - r) H(t - \tau) \\
 \boxed{G(\mathbf{x}, t | \boldsymbol{\xi}, \tau) &= \frac{H(c(t - \tau) - |\mathbf{x} - \boldsymbol{\xi}|)}{2\pi c \sqrt{(c(t - \tau))^2 - |\mathbf{x} - \boldsymbol{\xi}|^2}}
 \end{aligned}$$

2. To find the 1D Green function, we consider a line source,  $\delta(x)\delta(t)$ . Without loss of generality, we have taken the



source to be at  $x = 0, t = 0$ . We use the 2D Green function and integrate over space and time.

$$g_{tt} - c^2 \Delta g = \delta(x)\delta(t)$$

$$g = \int_{-\infty}^{\infty} \int_{-\infty}^{\infty} \int_{-\infty}^{\infty} \frac{H\left(c(t-\tau) - \sqrt{(x-\xi)^2 + (y-\eta)^2}\right)}{2\pi c \sqrt{(c(t-\tau))^2 - (x-\xi)^2 - (y-\eta)^2}} \delta(\xi)\delta(\tau) d\xi d\eta d\tau$$

$$g = \frac{1}{2\pi c} \int_{-\infty}^{\infty} \frac{H\left(ct - \sqrt{x^2 + \eta^2}\right)}{\sqrt{(ct)^2 - x^2 - \eta^2}} d\eta$$

$$g = \frac{1}{2\pi c} \int_{-\sqrt{(ct)^2 - x^2}}^{\sqrt{(ct)^2 - x^2}} \frac{1}{\sqrt{(ct)^2 - x^2 - \eta^2}} d\eta H(ct - |x|)$$

$$g(x, t|0, 0) = \frac{1}{2c} H(ct - |x|)$$

$$g(x, t|\xi, \tau) = \frac{1}{2c} H(c(t-\tau) - |x-\xi|)$$

### Solution 45.3

1.

$$G_{tt} = c^2 G_{xx}, \quad G(x, 0) = 0, \quad G_t(x, 0) = \delta(x - \xi)$$

$$\hat{G}_{tt} = -c^2 \omega^2 \hat{G}, \quad \hat{G}(\omega, 0) = 0, \quad \hat{G}_t(\omega, 0) = \mathcal{F}[\delta(x - \xi)]$$

$$\hat{G} = \mathcal{F}[\delta(x - \xi)] \frac{1}{c\omega} \sin(c\omega t)$$

$$\hat{G} = \frac{\pi}{c} \mathcal{F}[\delta(x - \xi)] \mathcal{F}[H(ct - |x|)]$$

$$G(x, t) = \frac{\pi}{c} \frac{1}{2\pi} \int_{-\infty}^{\infty} \delta(x - \xi - \eta) H(ct - |\eta|) d\eta$$

$$G(x, t) = \frac{1}{2c} H(ct - |x - \xi|)$$

2. We can write the solution of

$$u_{tt} = c^2 u_{xx}, \quad u(x, 0) = 0, \quad u_t(x, 0) = f(x)$$

in terms of the Green function we found in the previous part.

$$u = \int_{-\infty}^{\infty} G(x, t|\xi) f(\xi) d\xi$$

We consider  $c = 1$  with the initial condition  $f(x) = (1 - |x|)H(1 - |x|)$ .

$$u(x, t) = \frac{1}{2} \int_{x-t}^{x+t} (1 - |\xi|) H(1 - |\xi|) d\xi$$

First we consider the case  $t < 1/2$ . We will use fact that the solution is symmetric in  $x$ .

$$u(x, t) = \begin{cases} 0, & x + t < -1 \\ \frac{1}{2} \int_{-1}^{x+t} (1 - |\xi|) d\xi, & x - t < -1 < x + t \\ \frac{1}{2} \int_{x-t}^{x+t} (1 - |\xi|) d\xi, & -1 < x - t, x + t < 1 \\ \frac{1}{2} \int_{x-t}^1 (1 - |\xi|) d\xi, & x - t < 1 < x + t \\ 0, & 1 < x - t \end{cases}$$

$$u(x, t) = \begin{cases} 0, & x + t < -1 \\ \frac{1}{4}(1 + t + x)^2 & x - t < -1 < x + t \\ (1 + x)t & -1 < x - t, x + t < 0 \\ \frac{1}{2}(2t - t^2 - x^2) & x - t < 0 < x + t \\ (1 - x)t & 0 < x - t, x + t < 1 \\ \frac{1}{4}(1 + t - x)^2 & x - t < 1 < x + t \\ 0, & 1 < x - t \end{cases}$$

Next we consider the case  $1/2 < t < 1$ .

$$u(x, t) = \begin{cases} 0, & x + t < -1 \\ \frac{1}{2} \int_{-1}^{x+t} (1 - |\xi|) d\xi, & x - t < -1 < x + t \\ \frac{1}{2} \int_{x-t}^{x+t} (1 - |\xi|) d\xi, & -1 < x - t, x + t < 1 \\ \frac{1}{2} \int_{x-t}^1 (1 - |\xi|) d\xi, & x - t < 1 < x + t \\ 0, & 1 < x - t \end{cases}$$

$$u(x, t) = \begin{cases} 0, & x + t < -1 \\ \frac{1}{4}(1 + t + x)^2 & -1 < x + t < 0 \\ \frac{1}{4}(1 - t^2 + 2t(1 - x) + x(2 - x)) & x - t < -1, 0 < x + t \\ \frac{1}{2}(2t - t^2 - x^2) & -1 < x - t, x + t < 1 \\ \frac{1}{4}(1 - t^2 + 2t(1 + x) - x(2 + x)) & x - t < 0, 1 < x + t \\ \frac{1}{4}(1 + t - x)^2 & 0 < x - t < 1 \\ 0, & 1 < x - t \end{cases}$$

Finally we consider the case  $1 < t$ .

$$u(x, t) = \begin{cases} 0, & x + t < -1 \\ \frac{1}{2} \int_{-1}^{x+t} (1 - |\xi|) d\xi, & -1 < x + t < 1 \\ \frac{1}{2} \int_{-1}^1 (1 - |\xi|) d\xi, & x - t < -1, 1 < x + t \\ \frac{1}{2} \int_{x-t}^1 (1 - |\xi|) d\xi, & -1 < x - t < 1 \\ 0, & 1 < x - t \end{cases}$$

$$u(x, t) = \begin{cases} 0, & x + t < -1 \\ \frac{1}{4}(1 + t + x)^2 & -1 < x + t < 0 \\ \frac{1}{4}(1 - (t + x - 2)(t + x)) & 0 < x + t < 1 \\ \frac{1}{2} & x - t < -1, 1 < x + t \\ \frac{1}{4}(1 - (t - x - 2)(t - x)) & -1 < x - t < 0 \\ \frac{1}{4}(1 + t - x)^2 & 0 < x - t < 1 \\ 0, & 1 < x - t \end{cases}$$

Figure 45.1 shows the solution at  $t = 1/2$  and  $t = 2$ .

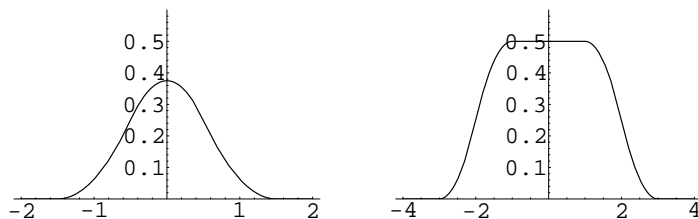

Figure 45.1: The solution at  $t = 1/2$  and  $t = 2$ .

Figure 45.2 shows the behavior of the solution in the phase plane. There are lines emanating from  $x = -1, 0, 1$  showing the range of influence of these points.

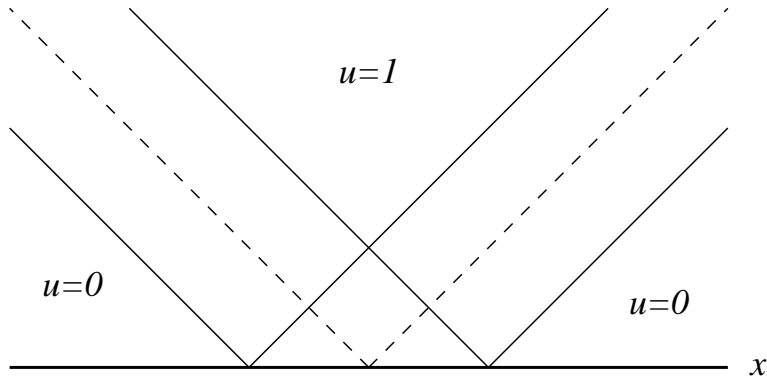

Figure 45.2: The behavior of the solution in the phase plane.

#### Solution 45.4

We define

$$L[u] \equiv \nabla^2 u + \mathbf{a}(\mathbf{x}) \cdot \nabla u + h(\mathbf{x})u.$$

We use the Divergence Theorem to derive a generalized Green's Theorem.

$$\begin{aligned} \int_V uL[v] \, d\mathbf{x} &= \int_V u(\nabla^2 v + \mathbf{a} \cdot \nabla v + hv) \, d\mathbf{x} \\ \int_V uL[v] \, d\mathbf{x} &= \int_V (u\nabla^2 v + \nabla \cdot (uva) - v\nabla \cdot (\mathbf{a}u) + huv) \, d\mathbf{x} \\ \int_V uL[v] \, d\mathbf{x} &= \int_V v(\nabla^2 u - \nabla \cdot (\mathbf{a}u) + hu) \, d\mathbf{x} + \int_{\partial V} (u\nabla v - v\nabla u + uva) \cdot \mathbf{n} \, dA \\ \int_V (uL[v] - vL^*[u]) \, d\mathbf{x} &= \int_{\partial V} (u\nabla v - v\nabla u + uva) \cdot \mathbf{n} \, dA \end{aligned}$$

We define the adjoint operator  $L^*$ .

$$L^*[u] = \nabla^2 u - \nabla \cdot (\mathbf{a}u) + hu$$

We substitute the solution  $u$  and the adjoint Green function  $G^*$  into the generalized Green's Theorem.

$$\int_V (G^* L[u] - u L^*[G^*]) \, d\mathbf{x} = \int_{\partial V} (G^* \nabla u - u \nabla G^* + v G^* \mathbf{a}) \cdot \mathbf{n} \, dA$$

$$\int_V (G^* q - u L^*[G^*]) \, d\mathbf{x} = 0$$

If the adjoint Green function satisfies  $L^*[G^*] = \delta(\mathbf{x} - \boldsymbol{\xi})$  then we can write  $u$  as an integral of the adjoint Green function and the inhomogeneity.

$$u(\boldsymbol{\xi}) = \int_V G^*(\mathbf{x}|\boldsymbol{\xi}) q(\mathbf{x}) \, d\mathbf{x}$$

Thus we see that the adjoint Green function problem is the appropriate one to consider. For  $L[G] = \delta(\mathbf{x} - \boldsymbol{\xi})$ ,

$$u(\boldsymbol{\xi}) \neq \int_V G(\mathbf{x}|\boldsymbol{\xi}) q(\mathbf{x}) \, d\mathbf{x}$$

### Solution 45.5

1.

$$\nabla^2 u = C \delta(\mathbf{x} - \boldsymbol{\xi}_+) - C \delta(\mathbf{x} - \boldsymbol{\xi}_-)$$

$$u = -\frac{C}{4\pi|\mathbf{x} - \boldsymbol{\xi}_+|} + \frac{C}{4\pi|\mathbf{x} - \boldsymbol{\xi}_-|}$$

2. We take  $c = D/\epsilon$  and consider the limit  $\epsilon \rightarrow 0$ .

$$\begin{aligned}
 u &= \lim_{\epsilon \rightarrow 0} -\frac{D}{4\pi\epsilon} \left( \frac{1}{\sqrt{(x - \epsilon/2)^2 + y^2 + z^2}} - \frac{1}{\sqrt{(x + \epsilon/2)^2 + y^2 + z^2}} \right) \\
 u &= \lim_{\epsilon \rightarrow 0} -\frac{D}{4\pi\epsilon} \frac{\sqrt{(x + \epsilon/2)^2 + y^2 + z^2} - \sqrt{(x - \epsilon/2)^2 + y^2 + z^2}}{\sqrt{((x - \epsilon/2)^2 + y^2 + z^2)((x + \epsilon/2)^2 + y^2 + z^2)}} \\
 u &= \lim_{\epsilon \rightarrow 0} -\frac{D}{4\pi\epsilon} \frac{\left(r + \frac{\epsilon x}{2r} + \mathcal{O}(\epsilon^2)\right) - \left(r - \frac{\epsilon x}{2r} + \mathcal{O}(\epsilon^2)\right)}{r^2 + \mathcal{O}(\epsilon)} \\
 u &= \lim_{\epsilon \rightarrow 0} -\frac{D}{4\pi} \frac{\frac{x}{r} + \mathcal{O}(\epsilon)}{r^2 + \mathcal{O}(\epsilon)} \\
 u &= -\frac{Dx}{4\pi r^3}
 \end{aligned}$$

3. Let  $\boldsymbol{\xi}_{\pm} = \boldsymbol{\xi}_0 \pm \epsilon \mathbf{a}/2$ .

$$\begin{aligned}
 \nabla^2 u &= \lim_{\epsilon \rightarrow 0} \frac{1}{\epsilon} (\delta(\mathbf{x} - \boldsymbol{\xi}_+) - \delta(\mathbf{x} - \boldsymbol{\xi}_-)) \\
 u &= -\frac{1}{4\pi} \lim_{\epsilon \rightarrow 0} \frac{1}{\epsilon} \left( \frac{1}{|\mathbf{x} - (\boldsymbol{\xi}_0 + \epsilon \mathbf{a}/2)|} - \frac{1}{|\mathbf{x} - (\boldsymbol{\xi}_0 - \epsilon \mathbf{a}/2)|} \right)
 \end{aligned}$$

We note that this is the definition of a directional derivative.

$$u(\mathbf{x}) = -\frac{1}{4\pi} \nabla_{\boldsymbol{\xi}} \left( \frac{1}{|\mathbf{x} - \boldsymbol{\xi}|} \right) \Big|_{\boldsymbol{\xi}=\boldsymbol{\xi}_0} \cdot \vec{a}$$

### Solution 45.6

The Green function is

$$G(\mathbf{x}|\boldsymbol{\xi}) = \frac{1}{2\pi} \ln \left( \frac{|\mathbf{x} - \boldsymbol{\xi}|}{|\boldsymbol{\xi}| |\mathbf{x} - \boldsymbol{\xi}^*|} \right).$$

We write this in polar coordinates. Denote  $\mathbf{x} = r e^{i\theta}$  and  $\boldsymbol{\xi} = \rho e^{i\vartheta}$ . Let  $\phi = \theta - \vartheta$  be the difference in angle between  $\mathbf{x}$  and  $\boldsymbol{\xi}$ .

$$G(\mathbf{x}|\boldsymbol{\xi}) = \frac{1}{2\pi} \ln \left( \frac{\sqrt{r^2 + \rho^2 - 2r\rho \cos \phi}}{\rho \sqrt{r^2 + 1/\rho^2 - 2(r/\rho) \cos \phi}} \right)$$

$$G(\mathbf{x}|\boldsymbol{\xi}) = \frac{1}{4\pi} \ln \left( \frac{r^2 + \rho^2 - 2r\rho \cos \phi}{r^2\rho^2 + 1 - 2r\rho \cos \phi} \right)$$

We solve Laplace's equation with the Green function.

$$u(\mathbf{x}) = \oint f(\boldsymbol{\xi}) \nabla_{\boldsymbol{\xi}} G(\mathbf{x}|\boldsymbol{\xi}) \cdot \mathbf{n} \, ds$$

$$u(r, \theta) = \int_0^{2\pi} f(\vartheta) G_{\rho}(r, \theta|1, \vartheta) \, d\vartheta$$

$$G_{\rho} = \frac{1}{2\pi} \frac{\rho - r^4\rho + r(r^2 - 1)(\rho^2 + 1) \cos \phi}{(r^2 + \rho^2 - 2r\rho \cos \phi)(r^2\rho^2 + 1 - 2r\rho \cos \phi)}$$

$$G_{\rho}(r, \theta|1, \vartheta) = \frac{1}{2\pi} \frac{1 - r^2}{1 + r^2 - 2r \cos \phi}$$

$$u(r, \theta) = \frac{1 - r^2}{2\pi} \int_0^{2\pi} \frac{f(\vartheta)}{1 + r^2 - 2r \cos(\theta - \vartheta)} \, d\vartheta$$

### Solution 45.7

1.

$$\Delta G = \delta(x - \xi)\delta(y - \eta)\delta(z - \zeta)$$

$$\frac{1}{r^2} \frac{\partial}{\partial r} \left( r^2 \frac{\partial G}{\partial r} \right) + \frac{1}{r^2 \sin \phi} \frac{\partial}{\partial \phi} \left( \sin(\phi) \frac{\partial G}{\partial \phi} \right) + \frac{1}{r^2 \sin \phi} \frac{\partial^2 G}{\partial \theta^2} = \delta_3(r)$$

2. Since the Green function has spherical symmetry,  $G_{\phi} = G_{\theta} = 0$ . This reduces the problem to an ordinary differential equation.

$$\frac{1}{r^2} \frac{\partial}{\partial r} \left( r^2 \frac{\partial G}{\partial r} \right) = \delta_3(r)$$



We find the homogeneous solutions.

$$\begin{aligned}u_{rr} + \frac{2}{r}u_r &= 0 \\u_r &= ce^{-2\ln r} = cr^{-2} \\u &= \frac{c_1}{r} + c_2\end{aligned}$$

We consider the solution that vanishes at infinity.

$$u = \frac{c}{r}$$

Thus we see that  $G = c/r$ . We determine the constant by integrating  $\Delta G$  over a sphere about the origin,  $R$ .

$$\begin{aligned}\iiint_R \Delta G \, d\mathbf{x} &= 1 \\ \iint_{\partial R} \nabla G \cdot \mathbf{n} \, ds &= 1 \\ \iint_{\partial R} G_r \, ds &= 1 \\ \int_0^\pi \int_0^{2\pi} -\frac{c}{r^2} r^2 \sin(\phi) \, d\theta d\phi &= 1 \\ -4\pi c &= 1 \\ c &= -\frac{1}{4\pi} \\ \boxed{G = -\frac{1}{4\pi r}}\end{aligned}$$

3. We write the Laplacian in circular coordinates.

$$\Delta G = \delta(x - \xi)\delta(y - \eta)$$
$$\frac{1}{r} \frac{\partial}{\partial r} \left( r \frac{\partial G}{\partial r} \right) + \frac{1}{r^2} \frac{\partial^2 G}{\partial \theta^2} = \delta_2(r)$$

Since the Green function has circular symmetry,  $G_\theta = 0$ . This reduces the problem to an ordinary differential equation.

$$\frac{1}{r} \frac{\partial}{\partial r} \left( r \frac{\partial G}{\partial r} \right) = \delta_2(r)$$

We find the homogeneous solutions.

$$u_{rr} + \frac{1}{r} u_r = 0$$
$$u_r = c e^{-\ln r} = c r^{-1}$$
$$u = c_1 \ln r + c_2$$

There are no solutions that vanishes at infinity. Instead we take the solution that vanishes at  $r = 1$ .

$$u = c \ln r$$

Thus we see that  $G = c \ln r$ . We determine the constant by integrating  $\Delta G$  over a ball about the origin,  $R$ .

$$\begin{aligned}\iint_R \Delta G \, d\mathbf{x} &= 1 \\ \int_{\partial R} \nabla G \cdot \mathbf{n} \, ds &= 1 \\ \int_{\partial R} G_r \, ds &= 1 \\ \int_0^{2\pi} \frac{c}{r} \, d\theta &= 1 \\ 2\pi c &= 1 \\ \boxed{G = \frac{1}{2\pi} \ln r}\end{aligned}$$

4.

$$\begin{aligned}
 u &= \int_{-\infty}^{\infty} \int_{-\infty}^{\infty} \int_{-\infty}^{\infty} -\frac{1}{4\pi(r-\rho)} \delta(\xi)\delta(\eta) \, d\xi \, d\eta \, d\zeta \\
 u &= -\frac{1}{4\pi} \int_{-\infty}^{\infty} \int_{-\infty}^{\infty} \int_{-\infty}^{\infty} \frac{\delta(\xi)\delta(\eta)}{\sqrt{(x-\xi)^2 + (y-\eta)^2 + (z-\zeta)^2}} \, d\xi \, d\eta \, d\zeta \\
 u &= -\frac{1}{4\pi} \int_{-\infty}^{\infty} \frac{1}{\sqrt{x^2 + y^2 + (z-\zeta)^2}} \, d\zeta \\
 u &= -\frac{1}{4\pi} \int_{-\infty}^{\infty} \frac{1}{\sqrt{r^2 + \zeta^2}} \, d\zeta \\
 u_r &= \frac{1}{4\pi} \int_{-\infty}^{\infty} \frac{r}{(r^2 + \zeta^2)^{3/2}} \, d\zeta \\
 u_r &= \frac{1}{4\pi} \frac{2}{r} \\
 u &= \frac{1}{2\pi} \ln r
 \end{aligned}$$

### Solution 45.8

1. We take the Laplace transform of the differential equation and the boundary conditions in  $x$ .

$$\begin{aligned}
 G_t - \nu G_{xx} &= \delta(x-\xi)\delta(t-\tau) \\
 s\hat{G} - \nu\hat{G}_{xx} &= \delta(x-\xi) \\
 \hat{G}_{xx} - \frac{s}{\nu}\hat{G} &= -\frac{1}{\nu}\delta(x-\xi), \quad \hat{G}(0,t) = \hat{G}(L,t) = 0
 \end{aligned}$$

Now we have an ordinary differential equation Green function problem. We find homogeneous solutions which respectively satisfy the left and right boundary conditions and compute their Wronskian.

$$y_1 = \sinh\left(\sqrt{\frac{s}{\nu}}x\right), \quad y_2 = \sinh\left(\sqrt{\frac{s}{\nu}}(L-x)\right)$$

$$\begin{aligned}
W &= \begin{vmatrix} \sinh\left(\sqrt{\frac{s}{\nu}}x\right) & \sinh\left(\sqrt{\frac{s}{\nu}}(L-x)\right) \\ \sqrt{\frac{s}{\nu}}\cosh\left(\sqrt{\frac{s}{\nu}}x\right) & -\sqrt{\frac{s}{\nu}}\cosh\left(\sqrt{\frac{s}{\nu}}(L-x)\right) \end{vmatrix} \\
&= -2\sqrt{\frac{s}{\nu}}\left(\sinh\left(\sqrt{\frac{s}{\nu}}x\right)\cosh\left(\sqrt{\frac{s}{\nu}}(L-x)\right) + \cosh\left(\sqrt{\frac{s}{\nu}}x\right)\sinh\left(\sqrt{\frac{s}{\nu}}(L-x)\right)\right) \\
&= -2\sqrt{\frac{s}{\nu}}\sinh\left(\sqrt{\frac{s}{\nu}}L\right)
\end{aligned}$$

We write the Green function in terms of the homogeneous solutions of the Wronskian.

$$\begin{aligned}
\hat{G} &= -\frac{1}{\nu} \frac{1}{-2\sqrt{\frac{s}{\nu}}\sinh\left(\sqrt{\frac{s}{\nu}}L\right)} \sinh\left(\sqrt{\frac{s}{\nu}}x_{<}\right) \sinh\left(\sqrt{\frac{s}{\nu}}(L-x_{>})\right) \\
\hat{G} &= \frac{\sinh\left(\sqrt{\frac{s}{\nu}}x_{<}\right) \sinh\left(\sqrt{\frac{s}{\nu}}(L-x_{>})\right)}{2\sqrt{\nu s}\sinh\left(\sqrt{\frac{s}{\nu}}L\right)} \\
\hat{G} &= \frac{\cosh\left(\sqrt{\frac{s}{\nu}}(L-x_{>}+x_{<})\right) - \cosh\left(\sqrt{\frac{s}{\nu}}(L-x_{>} - x_{<})\right)}{2\sqrt{\nu s}\sinh\left(\sqrt{\frac{s}{\nu}}L\right)}
\end{aligned}$$

2. We expand  $1/\sinh(x)$  in a series.

$$\begin{aligned}
\frac{1}{\sinh(x)} &= \frac{2}{e^x - e^{-x}} \\
&= \frac{2e^{-x}}{1 - e^{-2x}} \\
&= 2e^{-x} \sum_{n=0}^{\infty} e^{-2nx} \\
&= 2 \sum_{n=0}^{\infty} e^{-(2n+1)x}
\end{aligned}$$

We use the expansion of the hyperbolic cosecant in our expression for the Green function.

$$\hat{G} = \frac{e^{\sqrt{s/\nu}(L-x_>+x_<)} + e^{-\sqrt{s/\nu}(L-x_>+x_<)} - e^{\sqrt{s/\nu}(L-x_>-x_<)} - e^{-\sqrt{s/\nu}(L-x_>-x_<)}}{4\sqrt{\nu s} \sinh\left(\sqrt{\frac{s}{\nu}}L\right)}$$

$$\hat{G} = \frac{1}{2\sqrt{\nu s}} \left( e^{\sqrt{\nu/s}(L-x_>+x_<)} + e^{-\sqrt{\nu/s}(L-x_>+x_<)} - e^{\sqrt{\nu/s}(L-x_>-x_<)} - e^{-\sqrt{\nu/s}(L-x_>-x_<)} \right) \sum_{n=0}^{\infty} e^{-(2n+1)\sqrt{s/\nu}L}$$

$$\hat{G} = \frac{1}{2\sqrt{\nu s}} \left( \sum_{n=0}^{\infty} e^{\sqrt{s/\nu}(-x_>+x_<-2nL)} + \sum_{n=0}^{\infty} e^{\sqrt{s/\nu}(x_>-x_<-2(n+1)L)} - \sum_{n=0}^{\infty} e^{\sqrt{s/\nu}(-x_>-x_<-2nL)} - \sum_{n=0}^{\infty} e^{\sqrt{s/\nu}(x_>+x_<-2(n+1)L)} \right)$$

$$\hat{G} = \frac{1}{2\sqrt{\nu s}} \left( \sum_{n=0}^{\infty} e^{\sqrt{s/\nu}(-x_>+x_<-2nL)} + \sum_{n=-\infty}^{-1} e^{\sqrt{s/\nu}(x_>-x_<+2nL)} - \sum_{n=0}^{\infty} e^{\sqrt{s/\nu}(-x_>-x_<-2nL)} - \sum_{n=-\infty}^{-1} e^{\sqrt{s/\nu}(x_>+x_<+2nL)} \right)$$

$$\hat{G} = \frac{1}{2\sqrt{\nu s}} \left( \sum_{n=-\infty}^{\infty} e^{-\sqrt{s/\nu}|x_<-x_>-2nL|} - \sum_{n=-\infty}^{\infty} e^{-\sqrt{s/\nu}|x_<+x_>-2nL|} \right)$$

$$\hat{G} = \frac{1}{2\sqrt{\nu s}} \left( \sum_{n=-\infty}^{\infty} e^{-\sqrt{s/\nu}|x-\xi-2nL|} - \sum_{n=-\infty}^{\infty} e^{-\sqrt{s/\nu}|x+\xi-2nL|} \right)$$

3. We take the inverse Laplace transform to find the Green function for the diffusion equation.

$$G = \frac{1}{2\sqrt{\pi\nu t}} \left( \sum_{n=-\infty}^{\infty} e^{(x-\xi-2nL)^2/(4\nu t)} - \sum_{n=-\infty}^{\infty} e^{(x+\xi-2nL)^2/(4\nu t)} \right)$$

$$G = \sum_{n=-\infty}^{\infty} f(x - \xi - 2nL, t) - \sum_{n=-\infty}^{\infty} f(x + \xi - 2nL, t)$$

On the interval  $(-L \dots L)$ , there is a real source at  $x = \xi$  and a negative image source at  $x = -\xi$ . This pattern is repeated periodically.

The above formula is useful when approximating the solution for small time,  $t \ll 1$ . For such small  $t$ , the terms decay very quickly away from  $n = 0$ . A small number of terms could be used for an accurate approximation.

The alternate formula is useful when approximating the solution for large time,  $t \gg 1$ . For such large  $t$ , the terms in the sine series decay exponentially. Again, a small number of terms could be used for an accurate approximation.

### Solution 45.9

1. We take the Fourier cosine transform of the differential equation.

$$G_t - \nu G_{xx} = \delta(x - \xi)\delta(t - \tau)$$

$$\hat{G}_t - \nu \left( -\omega^2 \hat{G} - \frac{1}{\pi} G_x(0, t) \right) = \mathcal{F}_c[\delta(x - \xi)]\delta(t - \tau)$$

$$\hat{G}_t + \nu\omega^2 \hat{G} = \mathcal{F}_c[\delta(x - \xi)]\delta(t - \tau)$$

$$\hat{G} = \mathcal{F}_c[\delta(x - \xi)] e^{-\nu\omega^2(t-\tau)} H(t - \tau)$$

$$\hat{G} = \mathcal{F}_c[\delta(x - \xi)] \mathcal{F}_c \left[ \sqrt{\frac{\pi}{\nu(t-\tau)}} e^{-x^2/(4\nu(t-\tau))} \right] H(t - \tau)$$

We do the inversion with the convolution theorem.

$$G = \frac{1}{2\pi} \int_0^\infty \delta(\eta - \xi) \sqrt{\frac{\pi}{\nu(t-\tau)}} \left( e^{-|x-\eta|^2/(4\nu(t-\tau))} + e^{-(x+\eta)^2/(4\nu(t-\tau))} \right) d\eta H(t-\tau)$$

$$\boxed{G(x, t; \xi, \tau) = \frac{1}{\sqrt{4\pi\nu(t-\tau)}} \left( e^{-(x-\xi)^2/(4\nu(t-\tau))} + e^{-(x+\xi)^2/(4\nu(t-\tau))} \right) H(t-\tau)}$$

2. The fundamental solution on the infinite domain is

$$F(x, t; \xi, \tau) = \frac{1}{\sqrt{4\pi\nu(t-\tau)}} e^{-(x-\xi)^2/(4\nu(t-\tau))} H(t-\tau).$$

We see that the Green function on the semi-infinite domain that we found above is a sum of fundamental solutions.

$$G(x, t; \xi, \tau) = F(x, t; \xi, \tau) + F(x, t; -\xi, \tau)$$

Now we solve the inhomogeneous problem.

$$u(x, t) = \int_0^t \int_0^\infty G(x, t; \xi, \tau) q(\xi, \tau) d\xi d\tau + \int_0^\infty G(x, t; \xi, 0) f(\xi) d\xi$$

$$u(x, t) = \frac{1}{\sqrt{4\pi\nu}} \int_0^t \int_0^\infty \frac{1}{\sqrt{t-\tau}} \left( e^{-(x-\xi)^2/(4\nu(t-\tau))} + e^{-(x+\xi)^2/(4\nu(t-\tau))} \right) q(\xi, \tau) d\xi d\tau$$

$$+ \frac{1}{\sqrt{4\pi\nu t}} \int_0^\infty \left( e^{-(x-\xi)^2/(4\nu t)} + e^{-(x+\xi)^2/(4\nu t)} \right) f(\xi) d\xi$$

### Solution 45.10

1. We integrate the heat equation from  $t = 0^-$  to  $t = 0^+$  to determine an initial condition.

$$u_t = \nu u_{xx} + \delta(x - \xi)\delta(t)$$

$$u(x, 0^+) - u(x, 0^-) = \delta(x - \xi)$$



Now we have an initial value problem with no forcing.

$$u_t = \nu u_{xx}, \quad \text{for } t > 0, \quad u(x, 0) = \delta(x - \xi)$$

2. We take the Laplace transform of the initial value problem.

$$\begin{aligned} s\hat{u} - u(x, 0) &= \nu\hat{u}_{xx} \\ \hat{u}_{xx} - \frac{s}{\nu}\hat{u} &= -\frac{1}{\nu}\delta(x - \xi), \quad \hat{u}(\pm\infty, s) = 0 \end{aligned}$$

The solutions that satisfy the left and right boundary conditions are, respectively,

$$u_1 = e^{\sqrt{s/\nu}x}, \quad u_2 = e^{-\sqrt{s/\nu}x}$$

We compute the Wronskian of these solutions and then write the solution for  $\hat{u}$ .

$$\begin{aligned} W &= \begin{vmatrix} e^{\sqrt{s/\nu}x} & e^{-\sqrt{s/\nu}x} \\ \sqrt{s/\nu}e^{\sqrt{s/\nu}x} & -\sqrt{s/\nu}e^{-\sqrt{s/\nu}x} \end{vmatrix} = -2\sqrt{\frac{s}{\nu}} \\ \hat{u} &= -\frac{1}{\nu} \frac{e^{\sqrt{s/\nu}x} e^{-\sqrt{s/\nu}x}}{-2\sqrt{\frac{s}{\nu}}} \\ \hat{u} &= \frac{1}{2\sqrt{\nu s}} e^{-\sqrt{s/\nu}|x-\xi|} \end{aligned}$$

3. In Exercise 31.16, we showed that

$$\mathcal{L}^{-1} \left[ \sqrt{\frac{\pi}{s}} e^{-2\sqrt{as}} \right] = \frac{e^{-a/t}}{\sqrt{t}}.$$

We use this result to do the inverse Laplace transform.

$$u(x, t) = \frac{1}{2\sqrt{\pi\nu t}} e^{-(x-\xi)^2/(4\nu t)}$$

## Solution 45.11

$$G_{tt} - c^2 G_{xx} = \delta(x - \xi)\delta(t - \tau),$$

$$G(x, t; \xi, \tau) = 0 \quad \text{for } t < \tau.$$

We take the Fourier transform in  $x$ .

$$\hat{G}_{tt} + c^2 \omega^2 G = \mathcal{F}[\delta(x - \xi)]\delta(t - \tau), \quad \hat{G}(\omega, 0; \xi, \tau^-) = \hat{G}_t(\omega, 0; \xi, \tau^-) = 0$$

Now we have an ordinary differential equation Green function problem for  $\hat{G}$ . We have written the causality condition, the Green function is zero for  $t < \tau$ , in terms of initial conditions. The homogeneous solutions of the ordinary differential equation are

$$\{\cos(c\omega t), \sin(c\omega t)\}.$$

It will be handy to use the fundamental set of solutions at  $t = \tau$ :

$$\left\{ \cos(c\omega(t - \tau)), \frac{1}{c\omega} \sin(c\omega(t - \tau)) \right\}.$$

The continuity and jump conditions are

$$\hat{G}(\omega, 0; \xi, \tau^+) = 0, \quad \hat{G}_t(\omega, 0; \xi, \tau^+) = \mathcal{F}[\delta(x - \xi)]$$

We write the solution for  $\hat{G}$  and invert using the convolution theorem.

$$\hat{G} = \mathcal{F}[\delta(x - \xi)]H(t - \tau)\frac{1}{c\omega} \sin(c\omega(t - \tau))$$

$$\hat{G} = H(t - \tau)\mathcal{F}[\delta(x - \xi)]\mathcal{F}\left[\frac{\pi}{c}H(c(t - \tau) - |x|)\right]$$

$$G = H(t - \tau)\frac{\pi}{c}\frac{1}{2\pi} \int_{-\infty}^{\infty} \delta(y - \xi)H(c(t - \tau) - |x - y|) dy$$

$$G = \frac{1}{2c}H(t - \tau)H(c(t - \tau) - |x - \xi|)$$

$$G = \frac{1}{2c}H(c(t - \tau) - |x - \xi|)$$

The Green function for  $\xi = \tau = 0$  and  $c = 1$  is plotted in Figure 45.3 on the domain  $x \in (-1..1)$ ,  $t \in (0..1)$ . The Green function is a displacement of height  $\frac{1}{2c}$  that propagates out from the point  $x = \xi$  in both directions with speed  $c$ . The Green function shows the *range of influence* of a disturbance at the point  $x = \xi$  and time  $t = \tau$ . The disturbance influences the solution for all  $\xi - ct < x < \xi + ct$  and  $t > \tau$ .

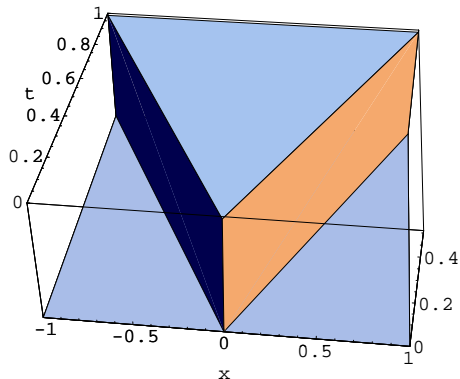

Figure 45.3: Green function for the wave equation.

Now we solve the wave equation with a source.

$$\begin{aligned}
 u_{tt} - c^2 u_{xx} &= q(x, t), \quad u(x, 0) = u_t(x, 0) = 0 \\
 u &= \int_0^\infty \int_{-\infty}^\infty G(x, t | \xi, \tau) q(\xi, \tau) \, d\xi \, d\tau \\
 u &= \int_0^\infty \int_{-\infty}^\infty \frac{1}{2c} H(c(t - \tau) - |x - \xi|) q(\xi, \tau) \, d\xi \, d\tau \\
 u &= \frac{1}{2c} \int_0^t \int_{x-c(t-\tau)}^{x+c(t-\tau)} q(\xi, \tau) \, d\xi \, d\tau
 \end{aligned}$$

**Solution 45.12**

1. We expand the Green function in eigenfunctions in  $x$ .

$$G(\mathbf{x}; \mathbf{x}i) = \sum_{n=1}^{\infty} a_n(y) \sin\left(\frac{(2n-1)\pi x}{2L}\right)$$

We substitute the expansion into the differential equation.

$$\nabla^2 \sum_{n=1}^{\infty} a_n(y) \sqrt{\frac{2}{L}} \sin\left(\frac{(2n-1)\pi x}{2L}\right) = \delta(x-\xi)\delta(y-\psi)$$

$$\begin{aligned} \sum_{n=1}^{\infty} \left( a_n''(y) - \left(\frac{(2n-1)\pi}{2L}\right)^2 a_n(y) \right) \sqrt{\frac{2}{L}} \sin\left(\frac{(2n-1)\pi x}{2L}\right) \\ = \delta(y-\psi) \sum_{n=1}^{\infty} \sqrt{\frac{2}{L}} \sin\left(\frac{(2n-1)\pi \xi}{2L}\right) \sqrt{\frac{2}{L}} \sin\left(\frac{(2n-1)\pi x}{2L}\right) \\ a_n''(y) - \left(\frac{(2n-1)\pi}{2L}\right)^2 a_n(y) = \sqrt{\frac{2}{L}} \sin\left(\frac{(2n-1)\pi \xi}{2L}\right) \delta(y-\psi) \end{aligned}$$

From the boundary conditions at  $y = 0$  and  $y = H$ , we obtain boundary conditions for the  $a_n(y)$ .

$$a_n'(0) = a_n'(H) = 0.$$

The solutions that satisfy the left and right boundary conditions are

$$a_{n1} = \cosh\left(\frac{(2n-1)\pi y}{2L}\right), \quad a_{n2} = \cosh\left(\frac{(2n-1)\pi(H-y)}{2L}\right).$$

The Wronskian of these solutions is

$$W = -\frac{(2n-1)\pi}{2L} \sinh\left(\frac{(2n-1)\pi}{2}\right).$$

Thus the solution for  $a_n(y)$  is

$$a_n(y) = \sqrt{\frac{2}{L}} \sin\left(\frac{(2n-1)\pi\xi}{2L}\right) \frac{\cosh\left(\frac{(2n-1)\pi y_{<}}{2L}\right) \cosh\left(\frac{(2n-1)\pi(H-y_{>})}{2L}\right)}{-\frac{(2n-1)\pi}{2L} \sinh\left(\frac{(2n-1)\pi}{2}\right)}$$

$$a_n(y) = -\frac{2\sqrt{2L}}{(2n-1)\pi} \operatorname{csch}\left(\frac{(2n-1)\pi}{2}\right) \cosh\left(\frac{(2n-1)\pi y_{<}}{2L}\right) \cosh\left(\frac{(2n-1)\pi(H-y_{>})}{2L}\right) \sin\left(\frac{(2n-1)\pi\xi}{2L}\right).$$

This determines the Green function.

$$G(\mathbf{x}; \mathbf{x}i) = -\frac{2\sqrt{2L}}{\pi} \sum_{n=1}^{\infty} \frac{1}{2n-1} \operatorname{csch}\left(\frac{(2n-1)\pi}{2}\right) \cosh\left(\frac{(2n-1)\pi y_{<}}{2L}\right) \cosh\left(\frac{(2n-1)\pi(H-y_{>})}{2L}\right) \sin\left(\frac{(2n-1)\pi\xi}{2L}\right) \sin\left(\frac{(2n-1)\pi x}{2L}\right)$$

2. We seek a solution of the form

$$G(\mathbf{x}; \mathbf{x}i) = \sum_{\substack{m=1 \\ n=1}}^{\infty} a_{mn}(z) \frac{2}{\sqrt{LH}} \sin\left(\frac{m\pi x}{L}\right) \sin\left(\frac{n\pi y}{H}\right).$$

We substitute this into the differential equation.

$$\nabla^2 \sum_{\substack{m=1 \\ n=1}}^{\infty} a_{mn}(z) \frac{2}{\sqrt{LH}} \sin\left(\frac{m\pi x}{L}\right) \sin\left(\frac{n\pi y}{H}\right) = \delta(x-\xi)\delta(y-\psi)\delta(z-\zeta)$$

$$\begin{aligned}
& \sum_{\substack{m=1 \\ n=1}}^{\infty} \left( a''_{mn}(z) - \left( \left( \frac{m\pi}{L} \right)^2 + \left( \frac{n\pi}{H} \right)^2 \right) a_{mn}(z) \right) \frac{2}{\sqrt{LH}} \sin \left( \frac{m\pi x}{L} \right) \sin \left( \frac{n\pi y}{H} \right) \\
&= \delta(z - \zeta) \sum_{\substack{m=1 \\ n=1}}^{\infty} \frac{2}{\sqrt{LH}} \sin \left( \frac{m\pi \xi}{L} \right) \sin \left( \frac{n\pi \psi}{H} \right) \frac{2}{\sqrt{LH}} \sin \left( \frac{m\pi x}{L} \right) \sin \left( \frac{n\pi y}{H} \right) \\
& a''_{mn}(z) - \pi \left( \left( \frac{m}{L} \right)^2 + \left( \frac{n}{H} \right)^2 \right) a_{mn}(z) = \frac{2}{\sqrt{LH}} \sin \left( \frac{m\pi \xi}{L} \right) \sin \left( \frac{n\pi \psi}{H} \right) \delta(z - \zeta)
\end{aligned}$$

From the boundary conditions on  $G$ , we obtain boundary conditions for the  $a_{mn}$ .

$$a_{mn}(0) = a_{mn}(W) = 0$$

The solutions that satisfy the left and right boundary conditions are

$$a_{mn1} = \sinh \left( \sqrt{\left( \frac{m}{L} \right)^2 + \left( \frac{n}{H} \right)^2} \pi z \right), \quad a_{mn2} = \sinh \left( \sqrt{\left( \frac{m}{L} \right)^2 + \left( \frac{n}{H} \right)^2} \pi (W - z) \right).$$

The Wronskian of these solutions is

$$W = -\sqrt{\left( \frac{m}{L} \right)^2 + \left( \frac{n}{H} \right)^2} \pi \sinh \left( \sqrt{\left( \frac{m}{L} \right)^2 + \left( \frac{n}{H} \right)^2} \pi W \right).$$

Thus the solution for  $a_{mn}(z)$  is

$$\begin{aligned}
a_{mn}(z) = & \frac{2}{\sqrt{LH}} \sin \left( \frac{m\pi \xi}{L} \right) \sin \left( \frac{n\pi \psi}{H} \right) \\
& \frac{\sinh \left( \sqrt{\left( \frac{m}{L} \right)^2 + \left( \frac{n}{H} \right)^2} \pi z_{<} \right) \sinh \left( \sqrt{\left( \frac{m}{L} \right)^2 + \left( \frac{n}{H} \right)^2} \pi (W - z_{>}) \right)}{-\sqrt{\left( \frac{m}{L} \right)^2 + \left( \frac{n}{H} \right)^2} \pi \sinh \left( \sqrt{\left( \frac{m}{L} \right)^2 + \left( \frac{n}{H} \right)^2} \pi W \right)}
\end{aligned}$$

$$a_{mn}(z) = -\frac{2}{\pi \lambda_{mn} \sqrt{LH}} \operatorname{csch}(\lambda_{mn} \pi W) \sin\left(\frac{m\pi\xi}{L}\right) \sin\left(\frac{n\pi\psi}{H}\right) \sinh(\lambda_{mn} \pi z_{<}) \sinh(\lambda_{mn} \pi (W - z_{>})),$$

where

$$\lambda_{mn} = \sqrt{\left(\frac{m}{L}\right)^2 + \left(\frac{n}{H}\right)^2}.$$

This determines the Green function.

$$G(\mathbf{x}; \mathbf{x}i) = -\frac{4}{\pi LH} \sum_{\substack{m=1 \\ n=1}}^{\infty} \frac{1}{\lambda_{mn}} \operatorname{csch}(\lambda_{mn} \pi W) \sin\left(\frac{m\pi\xi}{L}\right) \sin\left(\frac{m\pi x}{L}\right) \sin\left(\frac{n\pi\psi}{H}\right) \sin\left(\frac{n\pi y}{H}\right) \sinh(\lambda_{mn} \pi z_{<}) \sinh(\lambda_{mn} \pi (W - z_{>}))$$

3. First we write the problem in circular coordinates.

$$\begin{aligned} \nabla^2 G &= \delta(\mathbf{x} - \mathbf{x}i) \\ G_{rr} + \frac{1}{r} G_r + \frac{1}{r^2} G_{\theta\theta} &= \frac{1}{r} \delta(r - \rho) \delta(\theta - \vartheta), \\ G(r, 0; \rho, \vartheta) = G(r, \pi; \rho, \vartheta) = G(0, \theta; \rho, \vartheta) = G(a, \theta; \rho, \vartheta) &= 0 \end{aligned}$$

Because the Green function vanishes at  $\theta = 0$  and  $\theta = \pi$  we expand it in a series of the form

$$G = \sum_{n=1}^{\infty} g_n(r) \sin(n\theta).$$

We substitute the series into the differential equation.

$$\begin{aligned} \sum_{n=1}^{\infty} \left( g_n''(r) + \frac{1}{r} g_n'(r) - \frac{n^2}{r^2} g_n(r) \right) \sin(n\theta) &= \frac{1}{r} \delta(r - \rho) \sum_{n=1}^{\infty} \frac{2}{\pi} \sin(n\vartheta) \sin(n\theta) \\ g_n''(r) + \frac{1}{r} g_n'(r) - \frac{n^2}{r^2} g_n(r) &= \frac{2}{\pi r} \sin(n\vartheta) \delta(r - \rho) \end{aligned}$$

From the boundary conditions on  $G$ , we obtain boundary conditions for the  $g_n$ .

$$g_n(0) = g_n(a) = 0$$

The solutions that satisfy the left and right boundary conditions are

$$g_{n1} = r^n, \quad g_{n2} = \left(\frac{r}{a}\right)^n - \left(\frac{a}{r}\right)^n.$$

The Wronskian of these solutions is

$$W = \frac{2na^n}{r}.$$

Thus the solution for  $g_n(r)$  is

$$g_n(r) = \frac{2}{\pi\rho} \sin(n\vartheta) \frac{r^n \left( \left(\frac{r_{>}}{a}\right)^n - \left(\frac{a}{r_{>}}\right)^n \right)}{\frac{2na^n}{\rho}}$$

$$g_n(r) = \frac{1}{n\pi} \sin(n\vartheta) \left(\frac{r_{\leq}}{a}\right)^n \left( \left(\frac{r_{>}}{a}\right)^n - \left(\frac{a}{r_{>}}\right)^n \right).$$

This determines the solution.

$$G = \sum_{n=1}^{\infty} \frac{1}{n\pi} \left(\frac{r_{\leq}}{a}\right)^n \left( \left(\frac{r_{>}}{a}\right)^n - \left(\frac{a}{r_{>}}\right)^n \right) \sin(n\vartheta) \sin(n\theta)$$

4. First we write the problem in circular coordinates.

$$G_{rr} + \frac{1}{r}G_r + \frac{1}{r^2}G_{\theta\theta} = \frac{1}{r}\delta(r - \rho)\delta(\theta - \vartheta),$$

$$G(r, 0; \rho, \vartheta) = G(r, \pi/2; \rho, \vartheta) = G(0, \theta; \rho, \vartheta) = G_r(a, \theta; \rho, \vartheta) = 0$$

Because the Green function vanishes at  $\theta = 0$  and  $\theta = \pi/2$  we expand it in a series of the form

$$G = \sum_{n=1}^{\infty} g_n(r) \sin(2n\theta).$$



We substitute the series into the differential equation.

$$\sum_{n=1}^{\infty} \left( g_n''(r) + \frac{1}{r} g_n'(r) - \frac{4n^2}{r^2} g_n(r) \right) \sin(2n\theta) = \frac{1}{r} \delta(r - \rho) \sum_{n=1}^{\infty} \frac{4}{\pi} \sin(2n\vartheta) \sin(2n\theta)$$

$$g_n''(r) + \frac{1}{r} g_n'(r) - \frac{4n^2}{r^2} g_n(r) = \frac{4}{\pi r} \sin(2n\vartheta) \delta(r - \rho)$$

From the boundary conditions on  $G$ , we obtain boundary conditions for the  $g_n$ .

$$g_n(0) = g_n'(a) = 0$$

The solutions that satisfy the left and right boundary conditions are

$$g_{n1} = r^{2n}, \quad g_{n2} = \left(\frac{r}{a}\right)^{2n} + \left(\frac{a}{r}\right)^{2n}.$$

The Wronskian of these solutions is

$$W = -\frac{4na^{2n}}{r}.$$

Thus the solution for  $g_n(r)$  is

$$g_n(r) = \frac{4}{\pi \rho} \sin(2n\vartheta) \frac{r^{2n} \left( \left(\frac{r_{>}}{a}\right)^{2n} + \left(\frac{a}{r_{>}}\right)^{2n} \right)}{-\frac{4na^{2n}}{\rho}}$$

$$g_n(r) = -\frac{1}{\pi n} \sin(2n\vartheta) \left(\frac{r_{<}}{a}\right)^{2n} \left( \left(\frac{r_{>}}{a}\right)^{2n} + \left(\frac{a}{r_{>}}\right)^{2n} \right)$$

This determines the solution.

$$G = -\sum_{n=1}^{\infty} \frac{1}{\pi n} \left(\frac{r_{<}}{a}\right)^{2n} \left( \left(\frac{r_{>}}{a}\right)^{2n} + \left(\frac{a}{r_{>}}\right)^{2n} \right) \sin(2n\vartheta) \sin(2n\theta)$$

**Solution 45.13**

1. The set

$$\{X_n\} = \left\{ \sin \left( \frac{(2m-1)\pi x}{2L} \right) \right\}_{m=1}^{\infty}$$

are eigenfunctions of  $\nabla^2$  and satisfy the boundary conditions  $X_n(0) = X'_n(L) = 0$ . The set

$$\{Y_n\} = \left\{ \cos \left( \frac{n\pi y}{H} \right) \right\}_{n=0}^{\infty}$$

are eigenfunctions of  $\nabla^2$  and satisfy the boundary conditions  $Y'_n(0) = Y'_n(H) = 0$ . The set

$$\left\{ \sin \left( \frac{(2m-1)\pi x}{2L} \right) \cos \left( \frac{n\pi y}{H} \right) \right\}_{m=1, n=0}^{\infty}$$

are eigenfunctions of  $\nabla^2$  and satisfy the boundary conditions of this problem. We expand the Green function in a series of these eigenfunctions.

$$G = \sum_{m=1}^{\infty} g_{m0} \sqrt{\frac{2}{LH}} \sin \left( \frac{(2m-1)\pi x}{2L} \right) + \sum_{\substack{m=1 \\ n=1}}^{\infty} g_{mn} \frac{2}{\sqrt{LH}} \sin \left( \frac{(2m-1)\pi x}{2L} \right) \cos \left( \frac{n\pi y}{H} \right)$$

We substitute the series into the Green function differential equation.

$$\Delta G = \delta(x - \xi)\delta(y - \psi)$$

$$\begin{aligned}
& - \sum_{m=1}^{\infty} g_{m0} \left( \frac{(2m-1)\pi}{2L} \right)^2 \sqrt{\frac{2}{LH}} \sin \left( \frac{(2m-1)\pi x}{2L} \right) \\
& - \sum_{\substack{m=1 \\ n=1}}^{\infty} g_{mn} \left( \left( \frac{(2m-1)\pi}{2L} \right)^2 + \left( \frac{n\pi y}{H} \right)^2 \right) \frac{2}{\sqrt{LH}} \sin \left( \frac{(2m-1)\pi x}{2L} \right) \cos \left( \frac{n\pi y}{H} \right) \\
& = \sum_{m=1}^{\infty} \sqrt{\frac{2}{LH}} \sin \left( \frac{(2m-1)\pi \xi}{2L} \right) \sqrt{\frac{2}{LH}} \sin \left( \frac{(2m-1)\pi x}{2L} \right) \\
& + \sum_{\substack{m=1 \\ n=1}}^{\infty} \frac{2}{\sqrt{LH}} \sin \left( \frac{(2m-1)\pi \xi}{2L} \right) \cos \left( \frac{n\pi \psi}{H} \right) \frac{2}{\sqrt{LH}} \sin \left( \frac{(2m-1)\pi x}{2L} \right) \cos \left( \frac{n\pi y}{H} \right)
\end{aligned}$$

We equate terms and solve for the coefficients  $g_{mn}$ .

$$\begin{aligned}
g_{m0} &= -\sqrt{\frac{2}{LH}} \left( \frac{2L}{(2m-1)\pi} \right)^2 \sin \left( \frac{(2m-1)\pi \xi}{2L} \right) \\
g_{mn} &= -\frac{2}{\sqrt{LH}} \frac{1}{\pi^2 \left( \left( \frac{2m-1}{2L} \right)^2 + \left( \frac{n}{H} \right)^2 \right)} \sin \left( \frac{(2m-1)\pi \xi}{2L} \right) \cos \left( \frac{n\pi \psi}{H} \right)
\end{aligned}$$

This determines the Green function.

2. Note that

$$\left\{ \sqrt{\frac{8}{LHW}} \sin \left( \frac{k\pi x}{L} \right), \sin \left( \frac{m\pi y}{H} \right), \sin \left( \frac{n\pi z}{W} \right) : k, m, n \in \mathbb{Z}^+ \right\}$$

is orthonormal and complete on  $(0 \dots L) \times (0 \dots H) \times (0 \dots W)$ . The functions are eigenfunctions of  $\nabla^2$ . We expand the Green function in a series of these eigenfunctions.

$$G = \sum_{k,m,n=1}^{\infty} g_{kmn} \sqrt{\frac{8}{LHW}} \sin \left( \frac{k\pi x}{L} \right) \sin \left( \frac{m\pi y}{H} \right) \sin \left( \frac{n\pi z}{W} \right)$$

We substitute the series into the Green function differential equation.

$$\Delta G = \delta(x - \xi)\delta(y - \psi)\delta(z - \zeta)$$

$$\begin{aligned} - \sum_{k,m,n=1}^{\infty} g_{kmn} \left( \left( \frac{k\pi}{L} \right)^2 + \left( \frac{m\pi}{H} \right)^2 + \left( \frac{n\pi}{W} \right)^2 \right) \sqrt{\frac{8}{LHW}} \sin \left( \frac{k\pi x}{L} \right) \sin \left( \frac{m\pi y}{H} \right) \sin \left( \frac{n\pi z}{W} \right) \\ = \sum_{k,m,n=1}^{\infty} \sqrt{\frac{8}{LHW}} \sin \left( \frac{k\pi \xi}{L} \right) \sin \left( \frac{m\pi \psi}{H} \right) \sin \left( \frac{n\pi \zeta}{W} \right) \\ \sqrt{\frac{8}{LHW}} \sin \left( \frac{k\pi x}{L} \right) \sin \left( \frac{m\pi y}{H} \right) \sin \left( \frac{n\pi z}{W} \right) \end{aligned}$$

We equate terms and solve for the coefficients  $g_{kmn}$ .

$$g_{kmn} = - \frac{\sqrt{\frac{8}{LHW}} \sin \left( \frac{k\pi \xi}{L} \right) \sin \left( \frac{m\pi \psi}{H} \right) \sin \left( \frac{n\pi \zeta}{W} \right)}{\pi^2 \left( \left( \frac{k}{L} \right)^2 + \left( \frac{m}{H} \right)^2 + \left( \frac{n}{W} \right)^2 \right)}$$

This determines the Green function.

3. The Green function problem is

$$\Delta G \equiv G_{rr} + \frac{1}{r}G_r + \frac{1}{r^2}G_{\theta\theta} = \frac{1}{r}\delta(r - \rho)\delta(\theta - \vartheta).$$

We seek a set of functions  $\{\Theta_n(\theta)R_{nm}(r)\}$  which are orthogonal and complete on  $(0 \dots a) \times (0 \dots \pi)$  and which are eigenfunctions of the laplacian. For the  $\Theta_n$  we choose eigenfunctions of  $\frac{\partial^2}{\partial \theta^2}$ .

$$\begin{aligned} \Theta'' &= -\nu^2\Theta, \quad \Theta(0) = \Theta(\pi) = 0 \\ \nu_n &= n, \quad \Theta_n = \sin(n\theta), \quad n \in \mathbb{Z}^+ \end{aligned}$$

Now we look for eigenfunctions of the laplacian.

$$\begin{aligned}(R\Theta_n)_{rr} + \frac{1}{r}(R\Theta_n)_r + \frac{1}{r^2}(R\Theta_n)_{\theta\theta} &= -\mu^2 R\Theta_n \\ R''\Theta_n + \frac{1}{r}R'\Theta_n - \frac{n^2}{r^2}R\Theta_n &= -\mu^2 R\Theta_n \\ R'' + \frac{1}{r}R' + \left(\mu^2 - \frac{n^2}{r^2}\right)R &= 0, \quad R(0) = R(a) = 0\end{aligned}$$

The general solution for  $R$  is

$$R = c_1 J_n(\mu r) + c_2 Y_n(\mu r).$$

the solution that satisfies the left boundary condition is  $R = cJ_n(\mu r)$ . We use the right boundary condition to determine the eigenvalues.

$$\mu_m = \frac{j_{n,m}}{a}, \quad R_{nm} = J_n\left(\frac{j_{n,m}r}{a}\right), \quad m, n \in \mathbb{Z}^+$$

here  $j_{n,m}$  is the  $m^{\text{th}}$  root of  $J_n$ .

Note that

$$\left\{ \sin(n\theta) J_n\left(\frac{j_{n,m}r}{a}\right) : m, n \in \mathbb{Z}^+ \right\}$$

is orthogonal and complete on  $(r, \theta) \in (0 \dots a) \times (0 \dots \pi)$ . We use the identities

$$\int_0^\pi \sin^2(n\theta) d\theta = \frac{\pi}{2}, \quad \int_0^1 r J_n^2(j_{n,m}r) dr = \frac{1}{2} J_{n+1}^2(j_{n,m})$$

to make the functions orthonormal.

$$\left\{ \frac{2}{\sqrt{\pi} a |J_{n+1}(j_{n,m})|} \sin(n\theta) J_n\left(\frac{j_{n,m}r}{a}\right) : m, n \in \mathbb{Z}^+ \right\}$$

We expand the Green function in a series of these eigenfunctions.

$$G = \sum_{n,m=1}^{\infty} g_{nm} \frac{2}{\sqrt{\pi} a |J_{n+1}(j_{n,m})|} J_n\left(\frac{j_{n,m}r}{a}\right) \sin(n\theta)$$

We substitute the series into the Green function differential equation.

$$G_{rr} + \frac{1}{r}G_r + \frac{1}{r^2}G_{\theta\theta} = \frac{1}{r}\delta(r - \rho)\delta(\theta - \vartheta)$$

$$\begin{aligned} - \sum_{n,m=1}^{\infty} \left(\frac{j_{n,m}}{a}\right)^2 g_{nm} \frac{2}{\sqrt{\pi} a |J_{n+1}(j_{n,m})|} J_n\left(\frac{j_{n,m}r}{a}\right) \sin(n\theta) \\ = \sum_{n,m=1}^{\infty} \frac{2}{\sqrt{\pi} a |J_{n+1}(j_{n,m})|} J_n\left(\frac{j_{n,m}\rho}{a}\right) \sin(n\vartheta) \frac{2}{\sqrt{\pi} a |J_{n+1}(j_{n,m})|} J_n\left(\frac{j_{n,m}r}{a}\right) \sin(n\theta) \end{aligned}$$

We equate terms and solve for the coefficients  $g_{mn}$ .

$$g_{nm} = - \left(\frac{a}{j_{n,m}}\right)^2 \frac{2}{\sqrt{\pi} a |J_{n+1}(j_{n,m})|} J_n\left(\frac{j_{n,m}\rho}{a}\right) \sin(n\vartheta)$$

This determines the green function.

4. The Green function problem is

$$\Delta G \equiv G_{rr} + \frac{1}{r}G_r + \frac{1}{r^2}G_{\theta\theta} = \frac{1}{r}\delta(r - \rho)\delta(\theta - \vartheta).$$

We seek a set of functions  $\{\Theta_n(\theta)R_{nm}(r)\}$  which are orthogonal and complete on  $(0 \dots a) \times (0 \dots \pi/2)$  and which are eigenfunctions of the laplacian. For the  $\Theta_n$  we choose eigenfunctions of  $\frac{\partial^2}{\partial \theta^2}$ .

$$\begin{aligned} \Theta'' &= -\nu^2\Theta, & \Theta(0) &= \Theta(\pi/2) = 0 \\ \nu_n &= 2n, & \Theta_n &= \sin(2n\theta), \quad n \in \mathbb{Z}^+ \end{aligned}$$

Now we look for eigenfunctions of the laplacian.

$$\begin{aligned} (R\Theta_n)_{rr} + \frac{1}{r}(R\Theta_n)_r + \frac{1}{r^2}(R\Theta_n)_{\theta\theta} &= -\mu^2 R\Theta_n \\ R''\Theta_n + \frac{1}{r}R'\Theta_n - \frac{(2n)^2}{r^2}R\Theta_n &= -\mu^2 R\Theta_n \\ R'' + \frac{1}{r}R' + \left(\mu^2 - \frac{(2n)^2}{r^2}\right)R &= 0, \quad R(0) = R(a) = 0 \end{aligned}$$

The general solution for  $R$  is

$$R = c_1 J_{2n}(\mu r) + c_2 Y_{2n}(\mu r).$$

the solution that satisfies the left boundary condition is  $R = c J_{2n}(\mu r)$ . We use the right boundary condition to determine the eigenvalues.

$$\mu_m = \frac{j'_{2n,m}}{a}, \quad R_{nm} = J_{2n}\left(\frac{j'_{2n,m}r}{a}\right), \quad m, n \in \mathbb{Z}^+$$

here  $j'_{n,m}$  is the  $m^{\text{th}}$  root of  $J'_n$ .

Note that

$$\left\{ \sin(2n\theta) J'_{2n}\left(\frac{j'_{2n,m}r}{a}\right) : m, n \in \mathbb{Z}^+ \right\}$$

is orthogonal and complete on  $(r, \theta) \in (0 \dots a) \times (0 \dots \pi/2)$ . We use the identities

$$\begin{aligned} \int_0^\pi \sin(m\theta) \sin(n\theta) d\theta &= \frac{\pi}{2} \delta_{mn}, \\ \int_0^1 r J_\nu(j'_{\nu,m}r) J_\nu(j'_{\nu,n}r) dr &= \frac{j'^2_{\nu,n} - \nu^2}{2j'^2_{\nu,n}} (J_\nu(j'_{\nu,n}))^2 \delta_{mn} \end{aligned}$$

to make the functions orthonormal.

$$\left\{ \frac{2j'_{2n,m}}{\sqrt{\pi} a \sqrt{j'^2_{2n,m} - 4n^2} |J_{2n}(j'_{2n,m})|} \sin(2n\theta) J_{2n}\left(\frac{j'_{2n,m}r}{a}\right) : m, n \in \mathbb{Z}^+ \right\}$$

We expand the Green function in a series of these eigenfunctions.

$$G = \sum_{n,m=1}^{\infty} g_{nm} \frac{2j'_{2n,m}}{\sqrt{\pi} a \sqrt{j'^2_{2n,m} - 4n^2} |J_{2n}(j'_{2n,m})|} J_{2n} \left( \frac{j'_{2n,m} r}{a} \right) \sin(2n\theta)$$

We substitute the series into the Green function differential equation.

$$G_{rr} + \frac{1}{r} G_r + \frac{1}{r^2} G_{\theta\theta} = \frac{1}{r} \delta(r - \rho) \delta(\theta - \vartheta)$$

$$\begin{aligned} - \sum_{n,m=1}^{\infty} \left( \frac{j'_{2n,m}}{a} \right)^2 g_{nm} \frac{2j'_{2n,m}}{\sqrt{\pi} a \sqrt{j'^2_{2n,m} - 4n^2} |J_{2n}(j'_{2n,m})|} J_{2n} \left( \frac{j'_{2n,m} r}{a} \right) \sin(2n\theta) \\ = \sum_{n,m=1}^{\infty} \frac{2j'_{2n,m}}{\sqrt{\pi} a \sqrt{j'^2_{2n,m} - 4n^2} |J_{2n}(j'_{2n,m})|} J_{2n} \left( \frac{j'_{2n,m} \rho}{a} \right) \sin(2n\vartheta) \\ \frac{2j'_{2n,m}}{\sqrt{\pi} a \sqrt{j'^2_{2n,m} - 4n^2} |J_{2n}(j'_{2n,m})|} J_{2n} \left( \frac{j'_{2n,m} r}{a} \right) \sin(2n\theta) \end{aligned}$$

We equate terms and solve for the coefficients  $g_{mn}$ .

$$g_{nm} = - \left( \frac{a}{j'_{2n,m}} \right)^2 \frac{2j'_{2n,m}}{\sqrt{\pi} a \sqrt{j'^2_{2n,m} - 4n^2} |J_{2n}(j'_{2n,m})|} J_{2n} \left( \frac{j'_{2n,m} \rho}{a} \right) \sin(2n\vartheta)$$

This determines the green function.

### Solution 45.14

We start with the equation

$$\nabla^2 G = \delta(x - \xi) \delta(y - \psi).$$



We do an odd reflection across the  $y$  axis so that  $G(0, y; \xi, \psi) = 0$ .

$$\nabla^2 G = \delta(x - \xi)\delta(y - \psi) - \delta(x + \xi)\delta(y - \psi)$$

Then we do an even reflection across the  $x$  axis so that  $G_y(x, 0; \xi, \psi) = 0$ .

$$\nabla^2 G = \delta(x - \xi)\delta(y - \psi) - \delta(x + \xi)\delta(y - \psi) + \delta(x - \xi)\delta(y + \psi) - \delta(x + \xi)\delta(y + \psi)$$

We solve this problem using the infinite space Green function.

$$G = \frac{1}{4\pi} \ln((x - \xi)^2 + (y - \psi)^2) - \frac{1}{4\pi} \ln((x + \xi)^2 + (y - \psi)^2) \\ + \frac{1}{4\pi} \ln((x - \xi)^2 + (y + \psi)^2) - \frac{1}{4\pi} \ln((x + \xi)^2 + (y + \psi)^2)$$

$$G = \frac{1}{4\pi} \ln \left( \frac{((x - \xi)^2 + (y - \psi)^2)((x - \xi)^2 + (y + \psi)^2)}{((x + \xi)^2 + (y - \psi)^2)((x + \xi)^2 + (y + \psi)^2)} \right)$$

Now we solve the boundary value problem.

$$u(\xi, \psi) = \int_S \left( u(x, y) \frac{\partial G}{\partial n} - G \frac{\partial u(x, y)}{\partial n} \right) dS + \int_V G \Delta u dV$$

$$u(\xi, \psi) = \int_0^0 u(0, y)(-G_x(0, y; \xi, \psi)) dy + \int_0^\infty -G(x, 0; \xi, \psi)(-u_y(x, 0)) dx$$

$$u(\xi, \psi) = \int_0^\infty g(y)G_x(0, y; \xi, \psi) dy + \int_0^\infty G(x, 0; \xi, \psi)h(x) dx$$

$$u(\xi, \psi) = -\frac{\xi}{\pi} \int_0^\infty \left( \frac{1}{\xi^2 + (y - \psi)^2} + \frac{1}{\xi^2 + (y + \psi)^2} \right) g(y) dy + \frac{1}{2\pi} \int_0^\infty \ln \left( \frac{(x - \xi)^2 + \psi^2}{(x + \xi)^2 + \psi^2} \right) h(x) dx$$

$$u(x, y) = -\frac{x}{\pi} \int_0^\infty \left( \frac{1}{x^2 + (y - \psi)^2} + \frac{1}{x^2 + (y + \psi)^2} \right) g(\psi) d\psi + \frac{1}{2\pi} \int_0^\infty \ln \left( \frac{(x - \xi)^2 + y^2}{(x + \xi)^2 + y^2} \right) h(\xi) d\xi$$

**Solution 45.15**

First we find the infinite space Green function.

$$G_{tt} - c^2 G_{xx} = \delta(x - \xi)\delta(t - \tau), \quad G = G_t = 0 \text{ for } t < \tau$$

We solve this problem with the Fourier transform.

$$\begin{aligned} \hat{G}_{tt} + c^2 \omega^2 \hat{G} &= \mathcal{F}[\delta(x - \xi)]\delta(t - \tau) \\ \hat{G} &= \mathcal{F}[\delta(x - \xi)]H(t - \tau) \frac{1}{c\omega} \sin(c\omega(t - \tau)) \\ \hat{G} &= H(t - \tau) \mathcal{F}[\delta(x - \xi)] \mathcal{F}\left[\frac{\pi}{c} H(c(t - \tau) - |x|)\right] \\ G &= H(t - \tau) \frac{\pi}{c} \frac{1}{2\pi} \int_{-\infty}^{\infty} \delta(y - \xi) H(c(t - \tau) - |x - y|) dy \\ G &= \frac{1}{2c} H(t - \tau) H(c(t - \tau) - |x - \xi|) \\ G &= \frac{1}{2c} H(c(t - \tau) - |x - \xi|) \end{aligned}$$

1. So that the Green function vanishes at  $x = 0$  we do an odd reflection about that point.

$$\begin{aligned} G_{tt} - c^2 G_{xx} &= \delta(x - \xi)\delta(t - \tau) - \delta(x + \xi)\delta(t - \tau) \\ G &= \frac{1}{2c} H(c(t - \tau) - |x - \xi|) - \frac{1}{2c} H(c(t - \tau) - |x + \xi|) \end{aligned}$$

2. Note that the Green function satisfies the symmetry relation

$$G(x, t; \xi, \tau) = G(\xi, -\tau; x, -t).$$

This implies that

$$G_{xx} = G_{\xi\xi}, \quad G_{tt} = G_{\tau\tau}.$$

We write the Green function problem and the inhomogeneous differential equation for  $u$  in terms of  $\xi$  and  $\tau$ .

$$G_{\tau\tau} - c^2 G_{\xi\xi} = \delta(x - \xi)\delta(t - \tau) \quad (45.4)$$

$$u_{\tau\tau} - c^2 u_{\xi\xi} = Q(\xi, \tau) \quad (45.5)$$

We take the difference of  $u$  times Equation 45.4 and  $G$  times Equation 45.5 and integrate this over the domain  $(0, \infty) \times (0, t^+)$ .

$$\begin{aligned} \int_0^{t^+} \int_0^\infty (u\delta(x - \xi)\delta(t - \tau) - GQ) \, d\xi \, d\tau &= \int_0^{t^+} \int_0^\infty (uG_{\tau\tau} - u_{\tau\tau}G - c^2(uG_{\xi\xi} - u_{\xi\xi}G)) \, d\xi \, d\tau \\ u(x, t) &= \int_0^{t^+} \int_0^\infty GQ \, d\xi \, d\tau + \int_0^{t^+} \int_0^\infty \left( \frac{\partial}{\partial\tau} (uG_\tau - u_\tau G) - c^2 \frac{\partial}{\partial\xi} (uG_\xi - u_\xi G) \right) \, d\xi \, d\tau \\ u(x, t) &= \int_0^{t^+} \int_0^\infty GQ \, d\xi \, d\tau + \int_0^\infty [uG_\tau - u_\tau G]_0^{t^+} \, d\xi - c^2 \int_0^{t^+} [uG_\xi - u_\xi G]_0^\infty \, d\tau \\ u(x, t) &= \int_0^{t^+} \int_0^\infty GQ \, d\xi \, d\tau - \int_0^\infty [uG_\tau - u_\tau G]_{\tau=0} \, d\xi + c^2 \int_0^{t^+} [uG_\xi]_{\xi=0} \, d\tau \end{aligned}$$

We consider the case  $Q(x, t) = f(x) = g(x) = 0$ .

$$u(x, t) = c^2 \int_0^{t^+} h(\tau) G_\xi(x, t; 0, \tau) \, d\tau$$

We calculate  $G_\xi$ .

$$\begin{aligned} G &= \frac{1}{2c} (H(c(t - \tau) - |x - \xi|) - H(c(t - \tau) - |x + \xi|)) \\ G_\xi &= \frac{1}{2c} (\delta(c(t - \tau) - |x - \xi|)(-1) \operatorname{sign}(x - \xi)(-1) - \delta(c(t - \tau) - |x + \xi|)(-1) \operatorname{sign}(x + \xi)) \\ G_\xi(x, t; 0, \psi) &= \frac{1}{c} \delta(c(t - \tau) - |x|) \operatorname{sign}(x) \end{aligned}$$

We are interested in  $x > 0$ .

$$G_{\xi}(x, t; 0, \psi) = \frac{1}{c} \delta(c(t - \tau) - x)$$

Now we can calculate the solution  $u$ .

$$u(x, t) = c^2 \int_0^{t^+} h(\tau) \frac{1}{c} \delta(c(t - \tau) - x) d\tau$$

$$u(x, t) = \int_0^{t^+} h(\tau) \delta\left(\left(t - \tau\right) - \frac{x}{c}\right) d\tau$$

$$u(x, t) = h\left(t - \frac{x}{c}\right)$$

3. The boundary condition influences the solution  $u(x_1, t_1)$  only at the point  $t = t_1 - x_1/c$ . The contribution from the boundary condition  $u(0, t) = h(t)$  is a wave moving to the right with speed  $c$ .

### Solution 45.16

$$g_{tt} - c^2 g_{xx} = 0, \quad g(x, 0; \xi, \tau) = \delta(x - \xi), \quad g_t(x, 0; \xi, \tau) = 0$$

$$\hat{g}_{tt} + c^2 \omega^2 \hat{g}_{xx} = 0, \quad \hat{g}(x, 0; \xi, \tau) = \mathcal{F}[\delta(x - \xi)], \quad \hat{g}_t(x, 0; \xi, \tau) = 0$$

$$\hat{g} = \mathcal{F}[\delta(x - \xi)] \cos(c\omega t)$$

$$\hat{g} = \mathcal{F}[\delta(x - \xi)] \mathcal{F}[\pi(\delta(x + ct) + \delta(x - ct))]$$

$$g = \frac{1}{2\pi} \int_{-\infty}^{\infty} \delta(\psi - \xi) \pi(\delta(x - \psi + ct) + \delta(x - \psi - ct)) d\psi$$

$$\boxed{g(x, t; \xi) = \frac{1}{2}(\delta(x - \xi + ct) + \delta(x - \xi - ct))}$$

$$\begin{aligned}\gamma_{tt} - c^2\gamma_{xx} &= 0, & \gamma(x, 0; \xi, \tau) &= 0, & \gamma_t(x, 0; \xi, \tau) &= \delta(x - \xi) \\ \hat{\gamma}_{tt} + c^2\omega^2\hat{\gamma}_{xx} &= 0, & \hat{\gamma}(x, 0; \xi, \tau) &= 0, & \hat{\gamma}_t(x, 0; \xi, \tau) &= \mathcal{F}[\delta(x - \xi)]\end{aligned}$$

$$\hat{\gamma} = \mathcal{F}[\delta(x - \xi)] \frac{1}{c\omega} \sin(c\omega t)$$

$$\hat{\gamma} = \mathcal{F}[\delta(x - \xi)] \mathcal{F} \left[ \frac{\pi}{c} (H(x + ct) + H(x - ct)) \right]$$

$$\gamma = \frac{1}{2\pi} \int_{-\infty}^{\infty} \delta(\psi - \xi) \frac{\pi}{c} (H(x - \psi + ct) + H(x - \psi - ct)) d\psi$$

$$\boxed{\gamma(x, t; \xi) = \frac{1}{2c} (H(x - \xi + ct) + H(x - \xi - ct))}$$

### Solution 45.17

$$u(x, t) = \int_0^{\infty} \int_{-\infty}^{\infty} G(x, t; \xi, \tau) f(\xi, \tau) d\xi d\tau + \int_{-\infty}^{\infty} g(x, t; \xi) p(\xi) d\xi + \int_{-\infty}^{\infty} \gamma(x, t; \xi) q(\xi) d\xi$$

$$\begin{aligned}u(x, t) &= \frac{1}{2c} \int_0^{\infty} \int_{-\infty}^{\infty} H(t - \tau) (H(x - \xi + c(t - \tau)) - H(x - \xi - c(t - \tau))) f(\xi, \tau) d\xi d\tau \\ &\quad + \frac{1}{2} \int_{-\infty}^{\infty} (\delta(x - \xi + ct) + \delta(x - \xi - ct)) p(\xi) d\xi + \frac{1}{2c} \int_{-\infty}^{\infty} (H(x - \xi + ct) + H(x - \xi - ct)) q(\xi) d\xi\end{aligned}$$

$$\begin{aligned}u(x, t) &= \frac{1}{2c} \int_0^t \int_{-\infty}^{\infty} (H(x - \xi + c(t - \tau)) - H(x - \xi - c(t - \tau))) f(\xi, \tau) d\xi d\tau \\ &\quad + \frac{1}{2} (p(x + ct) + p(x - ct)) + \frac{1}{2c} \int_{x-ct}^{x+ct} q(\xi) d\xi\end{aligned}$$

$$\boxed{u(x, t) = \frac{1}{2c} \int_0^t \int_{x-c(t-\tau)}^{x+c(t-\tau)} f(\xi, \tau) d\xi d\tau + \frac{1}{2} (p(x + ct) + p(x - ct)) + \frac{1}{2c} \int_{x-ct}^{x+ct} q(\xi) d\xi}$$

This solution demonstrates the *domain of dependence* of the solution. The first term is an integral over the triangle domain  $\{(\xi, \tau) : 0 < \tau < t, x - c\tau < \xi < x + c\tau\}$ . The second term involves only the points  $(x \pm ct, 0)$ . The third term is an integral on the line segment  $\{(\xi, 0) : x - ct < \xi < x + ct\}$ . In totality, this is just the triangle domain. This is shown graphically in Figure 45.4.

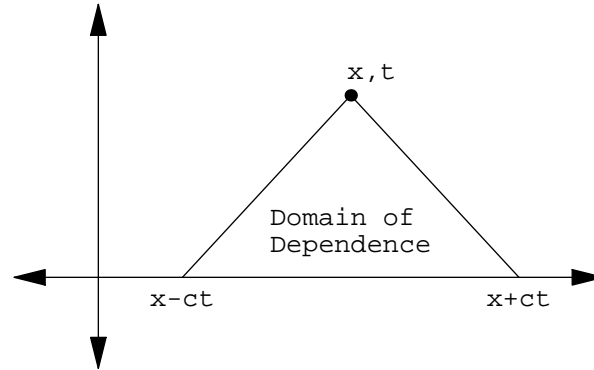

Figure 45.4: Domain of dependence for the wave equation.

### Solution 45.18

**Single Sum Representation.** First we find the eigenfunctions of the homogeneous problem  $\Delta u - k^2 u = 0$ . We substitute the separation of variables,  $u(x, y) = X(x)Y(y)$  into the partial differential equation.

$$X''Y + XY'' - k^2XY = 0$$

$$\frac{X''}{X} = k^2 - \frac{Y''}{Y} = -\lambda^2$$

We have the regular Sturm-Liouville eigenvalue problem,

$$X'' = -\lambda^2 X, \quad X(0) = X(a) = 0,$$

which has the solutions,

$$\lambda_n = \frac{n\pi}{a}, \quad X_n = \sin\left(\frac{n\pi x}{a}\right), \quad n \in \mathbb{N}.$$

We expand the solution  $u$  in a series of these eigenfunctions.

$$G(x, y; \xi, \psi) = \sum_{n=1}^{\infty} c_n(y) \sin\left(\frac{n\pi x}{a}\right)$$

We substitute this series into the partial differential equation to find equations for the  $c_n(y)$ .

$$\sum_{n=1}^{\infty} \left( -\left(\frac{n\pi}{a}\right)^2 c_n(y) + c_n''(y) - k^2 c_n(y) \right) \sin\left(\frac{n\pi x}{a}\right) = \delta(x - \xi)\delta(y - \psi)$$

The series expansion of the right side is,

$$\begin{aligned} \delta(x - \xi)\delta(y - \psi) &= \sum_{n=1}^{\infty} d_n(y) \sin\left(\frac{n\pi x}{a}\right) \\ d_n(y) &= \frac{2}{a} \int_0^a \delta(x - \xi)\delta(y - \psi) \sin\left(\frac{n\pi x}{a}\right) dx \\ d_n(y) &= \frac{2}{a} \sin\left(\frac{n\pi \xi}{a}\right) \delta(y - \psi). \end{aligned}$$

The the equations for the  $c_n(y)$  are

$$c_n''(y) - \left( k^2 + \left(\frac{n\pi}{a}\right)^2 \right) c_n(y) = \frac{2}{a} \sin\left(\frac{n\pi \xi}{a}\right) \delta(y - \psi), \quad c_n(0) = c_n(b) = 0.$$

The homogeneous solutions are  $\{\cosh(\sigma_n y), \sinh(\sigma_n y)\}$ , where  $\sigma_n = \sqrt{k^2 + (n\pi/a)^2}$ . The solutions that satisfy the boundary conditions at  $y = 0$  and  $y = b$  are,  $\sinh(\sigma_n y)$  and  $\sinh(\sigma_n(y - b))$ , respectively. The Wronskian of these

solutions is,

$$\begin{aligned} W(y) &= \begin{vmatrix} \sinh(\sigma_n y) & \sinh(\sigma_n(y-b)) \\ \sigma_n \cosh(\sigma_n y) & \sigma_n \cosh(\sigma_n(y-b)) \end{vmatrix} \\ &= \sigma_n (\sinh(\sigma_n y) \cosh(\sigma_n(y-b)) - \sinh(\sigma_n(y-b)) \cosh(\sigma_n y)) \\ &= \sigma_n \sinh(\sigma_n b). \end{aligned}$$

The solution for  $c_n(y)$  is

$$c_n(y) = \frac{2}{a} \sin\left(\frac{n\pi\xi}{a}\right) \frac{\sinh(\sigma_n y_{<}) \sinh(\sigma_n(y_{>} - b))}{\sigma_n \sinh(\sigma_n b)}.$$

The Green function for the partial differential equation is

$$G(x, y; \xi, \psi) = \frac{2}{a} \sum_{n=1}^{\infty} \frac{\sinh(\sigma_n y_{<}) \sinh(\sigma_n(y_{>} - b))}{\sigma_n \sinh(\sigma_n b)} \sin\left(\frac{n\pi x}{a}\right) \sin\left(\frac{n\pi\xi}{a}\right).$$

### Solution 45.19

We take the Fourier cosine transform in  $x$  of the partial differential equation and the boundary condition along  $y = 0$ .

$$\begin{aligned} G_{xx} + G_{yy} - k^2 G &= \delta(x - \xi) \delta(y - \psi) \\ -\alpha^2 \hat{G}(\alpha, y) - \frac{1}{\pi} \hat{G}_x(0, y) + \hat{G}_{yy}(\alpha, y) - k^2 \hat{G}(\alpha, y) &= \frac{1}{\pi} \cos(\alpha\xi) \delta(y - \psi) \\ \hat{G}_{yy}(\alpha, y) - (k^2 + \alpha^2) \hat{G}(\alpha, y) &= \frac{1}{\pi} \cos(\alpha\xi) \delta(y - \psi), \quad \hat{G}(\alpha, 0) = 0 \end{aligned}$$

Then we take the Fourier sine transform in  $y$ .

$$\begin{aligned} -\beta^2 \hat{G}(\alpha, \beta) + \frac{\beta}{\pi} \hat{G}(\alpha, 0) - (k^2 + \alpha^2) \hat{G}(\alpha, \beta) &= \frac{1}{\pi^2} \cos(\alpha\xi) \sin(\beta\psi) \\ \hat{G} &= -\frac{\cos(\alpha\xi) \sin(\beta\psi)}{\pi^2(k^2 + \alpha^2 + \beta^2)} \end{aligned}$$



We take two inverse transforms to find the solution. For one integral representation of the Green function we take the inverse sine transform followed by the inverse cosine transform.

$$\begin{aligned}\hat{\hat{G}} &= -\cos(\alpha\xi) \frac{\sin(\beta\psi)}{\pi} \frac{1}{\pi(k^2 + \alpha^2 + \beta^2)} \\ \hat{G} &= -\cos(\alpha\xi) \mathcal{F}_s[\delta(y - \psi)] \mathcal{F}_c \left[ \frac{1}{\sqrt{k^2 + \alpha^2}} e^{-\sqrt{k^2 + \alpha^2}y} \right] \\ \hat{G}(\alpha, y) &= -\cos(\alpha\xi) \frac{1}{2\pi} \int_0^\infty \delta(z - \psi) \frac{1}{\sqrt{k^2 + \alpha^2}} \left( \exp\left(-\sqrt{k^2 + \alpha^2}|y - z|\right) - \exp\left(-\sqrt{k^2 + \alpha^2}(y + z)\right) \right) dz \\ \hat{G}(\alpha, y) &= -\frac{\cos(\alpha\xi)}{2\pi\sqrt{k^2 + \alpha^2}} \left( \exp\left(-\sqrt{k^2 + \alpha^2}|y - \psi|\right) - \exp\left(-\sqrt{k^2 + \alpha^2}(y + \psi)\right) \right) \\ \boxed{G(x, y; \xi, \psi)} &= -\frac{1}{\pi} \int_0^\infty \frac{\cos(\alpha\xi)}{\sqrt{k^2 + \alpha^2}} \left( \exp\left(-\sqrt{k^2 + \alpha^2}|y - \psi|\right) - \exp\left(-\sqrt{k^2 + \alpha^2}(y + \psi)\right) \right) d\alpha\end{aligned}$$

For another integral representation of the Green function, we take the inverse cosine transform followed by the inverse sine transform.

$$\begin{aligned}\hat{\hat{G}}(\alpha, \beta) &= -\sin(\beta\psi) \frac{\cos(\alpha\xi)}{\pi} \frac{1}{\pi(k^2 + \alpha^2 + \beta^2)} \\ \hat{G}(\alpha, \beta) &= -\sin(\beta\psi) \mathcal{F}_c[\delta(x - \xi)] \mathcal{F}_s \left[ \frac{1}{\sqrt{k^2 + \beta^2}} e^{-\sqrt{k^2 + \beta^2}x} \right] \\ \hat{G}(x, \beta) &= -\sin(\beta\psi) \frac{1}{2\pi} \int_0^\infty \delta(z - \xi) \frac{1}{\sqrt{k^2 + \beta^2}} \left( e^{-\sqrt{k^2 + \beta^2}|x - z|} + e^{-\sqrt{k^2 + \beta^2}(x + z)} \right) dz \\ \hat{G}(x, \beta) &= -\sin(\beta\psi) \frac{1}{2\pi} \frac{1}{\sqrt{k^2 + \beta^2}} \left( e^{-\sqrt{k^2 + \beta^2}|x - \xi|} + e^{-\sqrt{k^2 + \beta^2}(x + \xi)} \right) \\ \boxed{G(x, y; \xi, \psi)} &= -\frac{1}{\pi} \int_0^\infty \frac{\sin(\beta y) \sin(\beta\psi)}{\sqrt{k^2 + \beta^2}} \left( e^{-\sqrt{k^2 + \beta^2}|x - \xi|} + e^{-\sqrt{k^2 + \beta^2}(x + \xi)} \right) d\beta\end{aligned}$$

**Solution 45.20**

The problem is:

$$G_{rr} + \frac{1}{r}G_r + \frac{1}{r^2}G_{\theta\theta} = \frac{\delta(r - \rho)\delta(\theta - \vartheta)}{r}, \quad 0 < r < \infty, \quad 0 < \theta < \alpha,$$

$$G(r, 0, \rho, \vartheta) = G(r, \alpha, \rho, \vartheta) = 0,$$

$$G(0, \theta, \rho, \vartheta) = 0$$

$$G(r, \theta, \rho, \vartheta) \rightarrow 0 \text{ as } r \rightarrow \infty.$$

Let  $w = r e^{i\theta}$  and  $z = x + iy$ . We use the conformal mapping,  $z = w^{\pi/\alpha}$  to map the sector to the upper half  $z$  plane. The problem is  $(x, y)$  space is

$$G_{xx} + G_{yy} = \delta(x - \xi)\delta(y - \psi), \quad -\infty < x < \infty, \quad 0 < y < \infty,$$

$$G(x, 0, \xi, \psi) = 0,$$

$$G(x, y, \xi, \psi) \rightarrow 0 \text{ as } x, y \rightarrow \infty.$$

We will solve this problem with the method of images. Note that the solution of,

$$G_{xx} + G_{yy} = \delta(x - \xi)\delta(y - \psi) - \delta(x - \xi)\delta(y + \psi), \quad -\infty < x < \infty, \quad -\infty < y < \infty,$$

$$G(x, y, \xi, \psi) \rightarrow 0 \text{ as } x, y \rightarrow \infty,$$

satisfies the condition,  $G(x, 0, \xi, \psi) = 0$ . Since the infinite space Green function for the Laplacian in two dimensions is

$$\frac{1}{4\pi} \ln \left( (x - \xi)^2 + (y - \psi)^2 \right),$$

the solution of this problem is,

$$G(x, y, \xi, \psi) = \frac{1}{4\pi} \ln \left( (x - \xi)^2 + (y - \psi)^2 \right) - \frac{1}{4\pi} \ln \left( (x - \xi)^2 + (y + \psi)^2 \right)$$

$$= \frac{1}{4\pi} \ln \left( \frac{(x - \xi)^2 + (y - \psi)^2}{(x - \xi)^2 + (y + \psi)^2} \right).$$

Now we solve for  $x$  and  $y$  in the conformal mapping.

$$\begin{aligned} z &= w^{\pi/\alpha} = (r e^{i\theta})^{\pi/\alpha} \\ x + iy &= r^{\pi/\alpha} (\cos(\theta\pi/\alpha) + i \sin(\theta\pi/\alpha)) \\ x &= r^{\pi/\alpha} \cos(\theta\pi/\alpha), \quad y = r^{\pi/\alpha} \sin(\theta\pi/\alpha) \end{aligned}$$

We substitute these expressions into  $G(x, y, \xi, \psi)$  to obtain  $G(r, \theta, \rho, \vartheta)$ .

$$\begin{aligned} G(r, \theta, \rho, \vartheta) &= \frac{1}{4\pi} \ln \left( \frac{(r^{\pi/\alpha} \cos(\theta\pi/\alpha) - \rho^{\pi/\alpha} \cos(\vartheta\pi/\alpha))^2 + (r^{\pi/\alpha} \sin(\theta\pi/\alpha) - \rho^{\pi/\alpha} \sin(\vartheta\pi/\alpha))^2}{(r^{\pi/\alpha} \cos(\theta\pi/\alpha) - \rho^{\pi/\alpha} \cos(\vartheta\pi/\alpha))^2 + (r^{\pi/\alpha} \sin(\theta\pi/\alpha) + \rho^{\pi/\alpha} \sin(\vartheta\pi/\alpha))^2} \right) \\ &= \frac{1}{4\pi} \ln \left( \frac{r^{2\pi/\alpha} + \rho^{2\pi/\alpha} - 2r^{\pi/\alpha} \rho^{\pi/\alpha} \cos(\pi(\theta - \vartheta)/\alpha)}{r^{2\pi/\alpha} + \rho^{2\pi/\alpha} - 2r^{\pi/\alpha} \rho^{\pi/\alpha} \cos(\pi(\theta + \vartheta)/\alpha)} \right) \\ &= \frac{1}{4\pi} \ln \left( \frac{(r/\rho)^{\pi/\alpha}/2 + (\rho/r)^{\pi/\alpha}/2 - \cos(\pi(\theta - \vartheta)/\alpha)}{(r/\rho)^{\pi/\alpha}/2 + (\rho/r)^{\pi/\alpha}/2 - \cos(\pi(\theta + \vartheta)/\alpha)} \right) \\ &= \frac{1}{4\pi} \ln \left( \frac{e^{\pi \ln(r/\rho)/\alpha} / 2 + e^{\pi \ln(\rho/r)/\alpha} / 2 - \cos(\pi(\theta - \vartheta)/\alpha)}{e^{\pi \ln(r/\rho)/\alpha} / 2 + e^{\pi \ln(\rho/r)/\alpha} / 2 - \cos(\pi(\theta + \vartheta)/\alpha)} \right) \end{aligned}$$

$$G(r, \theta, \rho, \vartheta) = \frac{1}{4\pi} \ln \left( \frac{\cosh \left( \frac{\pi/\alpha}{\ln \rho} r \right) - \cos(\pi(\theta - \vartheta)/\alpha)}{\cosh \left( \frac{\pi/\alpha}{\ln \rho} r \right) - \cos(\pi(\theta + \vartheta)/\alpha)} \right)$$

Now recall that the solution of

$$\Delta u = f(\mathbf{x}),$$

subject to the boundary condition,

$$u(\mathbf{x}) = g(\mathbf{x}),$$

is

$$u(\mathbf{x}) = \iint f(\mathbf{x}i) G(\mathbf{x}; \mathbf{x}i) dA_\xi + \oint g(\mathbf{x}i) \nabla_\xi G(\mathbf{x}; \mathbf{x}i) \cdot \hat{\mathbf{n}} ds_\xi.$$

The normal directions along the lower and upper edges of the sector are  $-\hat{\theta}$  and  $\hat{\theta}$ , respectively. The gradient in polar coordinates is

$$\nabla_{\xi} = \hat{\rho} \frac{\partial}{\partial \rho} + \frac{\hat{\vartheta}}{\rho} \frac{\partial}{\partial \vartheta}.$$

We only need to compute the  $\hat{\vartheta}$  component of the gradient of  $G$ . This is

$$\frac{1}{\rho} \frac{\partial}{\partial \rho} G = \frac{\sin(\pi(\theta - \vartheta)/\alpha)}{4\alpha\rho \left( \cosh\left(\frac{\pi}{\alpha} \ln \frac{r}{\rho}\right) - \cos(\pi(\theta - \vartheta)/\alpha) \right)} + \frac{\sin(\pi(\theta + \vartheta)/\alpha)}{4\alpha\rho \left( \cosh\left(\frac{\pi}{\alpha} \ln \frac{r}{\rho}\right) - \cos(\pi(\theta + \vartheta)/\alpha) \right)}$$

Along  $\vartheta = 0$ , this is

$$\frac{1}{\rho} G_{\vartheta}(r, \theta, \rho, 0) = \frac{\sin(\pi\theta/\alpha)}{2\alpha\rho \left( \cosh\left(\frac{\pi}{\alpha} \ln \frac{r}{\rho}\right) - \cos(\pi\theta/\alpha) \right)}.$$

Along  $\vartheta = \alpha$ , this is

$$\frac{1}{\rho} G_{\vartheta}(r, \theta, \rho, \alpha) = -\frac{\sin(\pi\theta/\alpha)}{2\alpha\rho \left( \cosh\left(\frac{\pi}{\alpha} \ln \frac{r}{\rho}\right) + \cos(\pi\theta/\alpha) \right)}.$$

The solution of our problem is

$$u(r, \theta) = \int_{\infty}^c -\frac{\sin(\pi\theta/\alpha)}{2\alpha\rho \left( \cosh\left(\frac{\pi}{\alpha} \ln \frac{r}{\rho}\right) + \cos(\pi\theta/\alpha) \right)} d\rho + \int_c^{\infty} -\frac{\sin(\pi\theta/\alpha)}{2\alpha\rho \left( \cosh\left(\frac{\pi}{\alpha} \ln \frac{r}{\rho}\right) - \cos(\pi\theta/\alpha) \right)} d\rho$$

$$u(r, \theta) = \int_c^{\infty} \frac{-\sin(\pi\theta/\alpha)}{2\alpha\rho \left( \cosh\left(\frac{\pi}{\alpha} \ln \frac{r}{\rho}\right) - \cos(\pi\theta/\alpha) \right)} + \frac{\sin(\pi\theta/\alpha)}{2\alpha\rho \left( \cosh\left(\frac{\pi}{\alpha} \ln \frac{r}{\rho}\right) + \cos(\pi\theta/\alpha) \right)} d\rho$$

$$u(r, \theta) = -\frac{1}{\alpha} \sin\left(\frac{\pi\theta}{\alpha}\right) \cos\left(\frac{\pi\theta}{\alpha}\right) \int_c^{\infty} \frac{1}{\rho \left( \cosh^2\left(\frac{\pi}{\alpha} \ln \frac{r}{\rho}\right) - \cos^2\left(\frac{\pi\theta}{\alpha}\right) \right)} d\rho$$

$$u(r, \theta) = -\frac{1}{\alpha} \sin\left(\frac{\pi\theta}{\alpha}\right) \cos\left(\frac{\pi\theta}{\alpha}\right) \int_{\ln(c/r)}^{\infty} \frac{1}{\cosh^2\left(\frac{\pi x}{\alpha}\right) - \cos^2\left(\frac{\pi\theta}{\alpha}\right)} dx$$

$$u(r, \theta) = -\frac{2}{\alpha} \sin\left(\frac{\pi\theta}{\alpha}\right) \cos\left(\frac{\pi\theta}{\alpha}\right) \int_{\ln(c/r)}^{\infty} \frac{1}{\cosh\left(\frac{2\pi x}{\alpha}\right) - \cos\left(\frac{2\pi\theta}{\alpha}\right)} dx$$

### Solution 45.21

First consider the Green function for

$$u_t - \kappa u_{xx} = 0, \quad u(x, 0) = f(x).$$

The differential equation and initial condition is

$$G_t = \kappa G_{xx}, \quad G(x, 0; \xi) = \delta(x - \xi).$$

The Green function is a solution of the homogeneous heat equation for the initial condition of a unit amount of heat concentrated at the point  $x = \xi$ . You can verify that the Green function is a solution of the heat equation for  $t > 0$  and that it has the property:

$$\int_{-\infty}^{\infty} G(x, t; \xi) dx = 1, \quad \text{for } t > 0.$$

This property demonstrates that the total amount of heat is the constant 1. At time  $t = 0$  the heat is concentrated at the point  $x = \xi$ . As time increases, the heat diffuses out from this point.

The solution for  $u(x, t)$  is the linear combination of the Green functions that satisfies the initial condition  $u(x, 0) = f(x)$ . This linear combination is

$$u(x, t) = \int_{-\infty}^{\infty} G(x, t; \xi) f(\xi) d\xi.$$

$G(x, t; 1)$  and  $G(x, t; -1)$  are plotted in Figure 45.5 for the domain  $t \in [1/100..1/4]$ ,  $x \in [-2..2]$  and  $\kappa = 1$ .

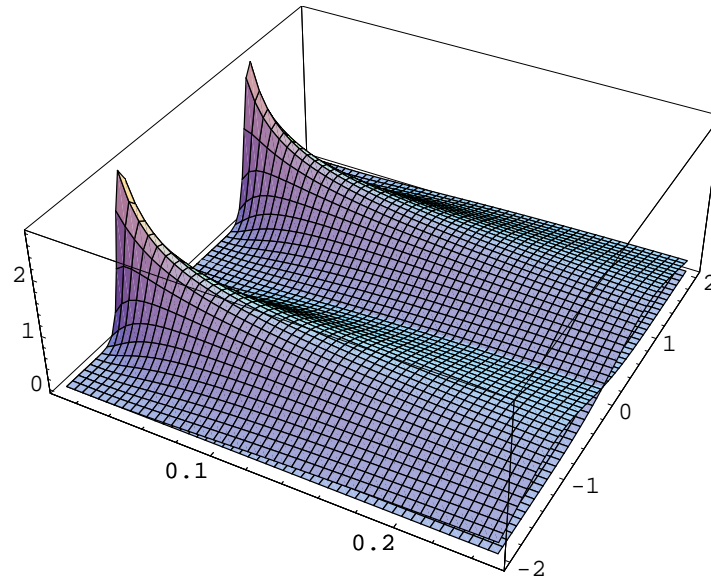

Figure 45.5:  $G(x, t; 1)$  and  $G(x, t; -1)$

Now we consider the problem

$$u_t = \kappa u_{xx}, \quad u(x, 0) = f(x) \text{ for } x > 0, \quad u(0, t) = 0.$$

Note that the solution of

$$G_t = \kappa G_{xx}, \quad x > 0, \quad t > 0,$$

$$G(x, 0; \xi) = \delta(x - \xi) - \delta(x + \xi),$$

satisfies the boundary condition  $G(0, t; \xi) = 0$ . We write the solution as the difference of infinite space Green functions.

$$G(x, t; \xi) = \frac{1}{\sqrt{4\pi\kappa t}} e^{-(x-\xi)^2/(4\kappa t)} - \frac{1}{\sqrt{4\pi\kappa t}} e^{-(x+\xi)^2/(4\kappa t)}$$

$$= \frac{1}{\sqrt{4\pi\kappa t}} \left( e^{-(x-\xi)^2/(4\kappa t)} - e^{-(x+\xi)^2/(4\kappa t)} \right)$$

$$G(x, t; \xi) = \frac{1}{\sqrt{4\pi\kappa t}} e^{-(x^2+\xi^2)/(4\kappa t)} \sinh\left(\frac{x\xi}{2\kappa t}\right)$$

Next we consider the problem

$$u_t = \kappa u_{xx}, \quad u(x, 0) = f(x) \text{ for } x > 0, \quad u_x(0, t) = 0.$$

Note that the solution of

$$G_t = \kappa G_{xx}, \quad x > 0, \quad t > 0,$$

$$G(x, 0; \xi) = \delta(x - \xi) + \delta(x + \xi),$$

satisfies the boundary condition  $G_x(0, t; \xi) = 0$ . We write the solution as the sum of infinite space Green functions.

$$G(x, t; \xi) = \frac{1}{\sqrt{4\pi\kappa t}} e^{-(x-\xi)^2/(4\kappa t)} + \frac{1}{\sqrt{4\pi\kappa t}} e^{-(x+\xi)^2/(4\kappa t)}$$

$$G(x, t; \xi) = \frac{1}{\sqrt{4\pi\kappa t}} e^{-(x^2+\xi^2)/(4\kappa t)} \cosh\left(\frac{x\xi}{2\kappa t}\right)$$

The Green functions for the two boundary conditions are shown in Figure 45.6.

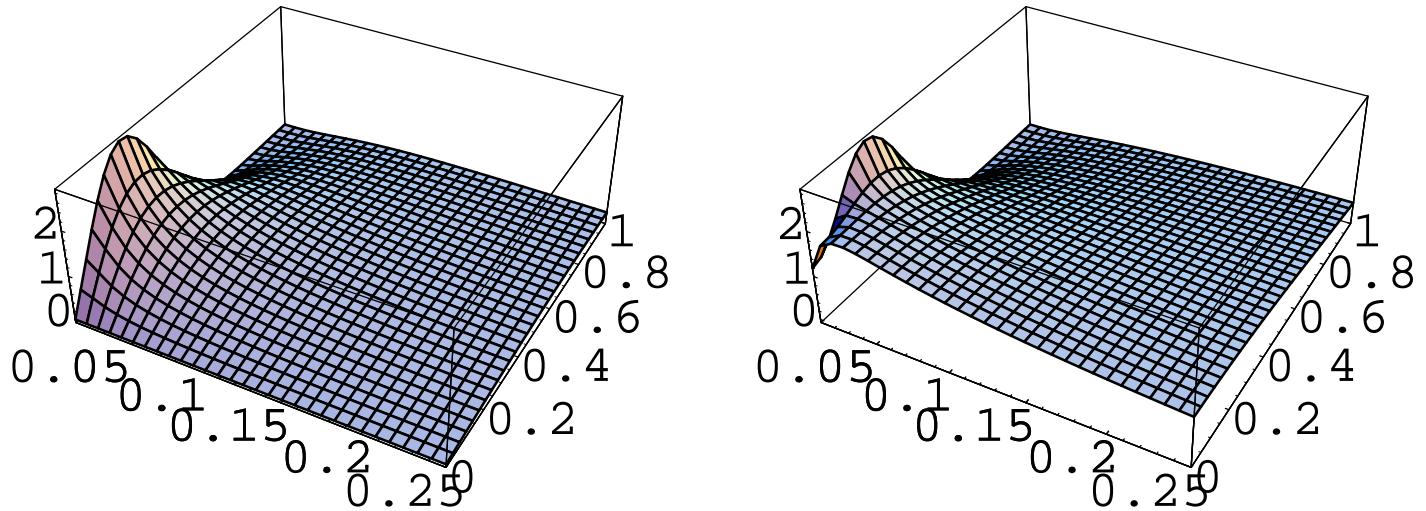

Figure 45.6: Green functions for the boundary conditions  $u(0, t) = 0$  and  $u_x(0, t) = 0$ .

### Solution 45.22

a) The Green function problem is

$$\begin{aligned}
 G_{tt} - c^2 G_{xx} &= \delta(t - \tau)\delta(x - \xi), \quad 0 < x < L, \quad t > 0, \\
 G(0, t; \xi, \tau) &= G_x(L, t; \xi, \tau) = 0, \\
 G(x, t; \xi, \tau) &= 0 \text{ for } t < \tau.
 \end{aligned}$$

The condition that  $G$  is zero for  $t < \tau$  makes this a *causal* Green function. We solve this problem by expanding  $G$  in a series of eigenfunctions of the  $x$  variable. The coefficients in the expansion will be functions of  $t$ . First we find the eigenfunctions of  $x$  in the homogeneous problem. We substitute the separation of variables  $u = X(x)T(t)$  into the



homogeneous partial differential equation.

$$XT'' = c^2 X''T$$
$$\frac{T''}{c^2 T} = \frac{X''}{X} = -\lambda^2$$

The eigenvalue problem is

$$X'' = -\lambda^2 X, \quad X(0) = X'(L) = 0,$$

which has the solutions,

$$\lambda_n = \frac{(2n-1)\pi}{2L}, \quad X_n = \sin\left(\frac{(2n-1)\pi x}{2L}\right), \quad n \in \mathbb{N}.$$

The series expansion of the Green function has the form,

$$G(x, t; \xi, \tau) = \sum_{n=1}^{\infty} g_n(t) \sin\left(\frac{(2n-1)\pi x}{2L}\right).$$

We determine the coefficients by substituting the expansion into the Green function differential equation.

$$G_{tt} - c^2 G_{xx} = \delta(x - \xi)\delta(t - \tau)$$
$$\sum_{n=1}^{\infty} \left( g_n''(t) + \left(\frac{(2n-1)\pi c}{2L}\right)^2 g_n(t) \right) \sin\left(\frac{(2n-1)\pi x}{2L}\right) = \delta(x - \xi)\delta(t - \tau)$$

We need to expand the right side of the equation in the sine series

$$\delta(x - \xi)\delta(t - \tau) = \sum_{n=1}^{\infty} d_n(t) \sin\left(\frac{(2n-1)\pi x}{2L}\right)$$
$$d_n(t) = \frac{2}{L} \int_0^L \delta(x - \xi)\delta(t - \tau) \sin\left(\frac{(2n-1)\pi x}{2L}\right) dx$$
$$d_n(t) = \frac{2}{L} \sin\left(\frac{(2n-1)\pi \xi}{2L}\right) \delta(t - \tau)$$

By equating coefficients in the sine series, we obtain ordinary differential equation Green function problems for the  $g_n$ 's.

$$g_n''(t; \tau) + \left( \frac{(2n-1)\pi c}{2L} \right)^2 g_n(t; \tau) = \frac{2}{L} \sin \left( \frac{(2n-1)\pi \xi}{2L} \right) \delta(t - \tau)$$

From the causality condition for  $G$ , we have the causality conditions for the  $g_n$ 's,

$$g_n(t; \tau) = g_n'(t; \tau) = 0 \text{ for } t < \tau.$$

The continuity and jump conditions for the  $g_n$  are

$$g_n(\tau^+; \tau) = 0, \quad g_n'(\tau^+; \tau) = \frac{2}{L} \sin \left( \frac{(2n-1)\pi \xi}{2L} \right).$$

A set of homogeneous solutions of the ordinary differential equation are

$$\left\{ \cos \left( \frac{(2n-1)\pi c t}{2L} \right), \sin \left( \frac{(2n-1)\pi c t}{2L} \right) \right\}$$

Since the continuity and jump conditions are given at the point  $t = \tau$ , a handy set of solutions to use for this problem is the fundamental set of solutions at that point:

$$\left\{ \cos \left( \frac{(2n-1)\pi c(t-\tau)}{2L} \right), \frac{2L}{(2n-1)\pi c} \sin \left( \frac{(2n-1)\pi c(t-\tau)}{2L} \right) \right\}$$

The solution that satisfies the causality condition and the continuity and jump conditions is,

$$g_n(t; \tau) = \frac{4}{(2n-1)\pi c} \sin \left( \frac{(2n-1)\pi \xi}{2L} \right) \sin \left( \frac{(2n-1)\pi c(t-\tau)}{2L} \right) H(t - \tau).$$

Substituting this into the sum yields,

$$G(x, t; \xi, \tau) = \frac{4}{\pi c} H(t - \tau) \sum_{n=1}^{\infty} \frac{1}{2n-1} \sin \left( \frac{(2n-1)\pi \xi}{2L} \right) \sin \left( \frac{(2n-1)\pi c(t-\tau)}{2L} \right) \sin \left( \frac{(2n-1)\pi x}{2L} \right).$$

We use trigonometric identities to write this in terms of traveling waves.

$$G(x, t; \xi, \tau) = \frac{1}{\pi c} H(t - \tau) \sum_{n=1}^{\infty} \frac{1}{2n-1} \left( \sin \left( \frac{(2n-1)\pi((x-\xi) - c(t-\tau))}{2L} \right) \right. \\ \left. + \sin \left( \frac{(2n-1)\pi((x-\xi) + c(t-\tau))}{2L} \right) - \sin \left( \frac{(2n-1)\pi((x+\xi) - c(t-\tau))}{2L} \right) \right. \\ \left. - \sin \left( \frac{(2n-1)\pi((x+\xi) + c(t-\tau))}{2L} \right) \right)$$

**b)** Now we consider the Green function with the boundary conditions,

$$u_x(0, t) = u_x(L, t) = 0.$$

First we find the eigenfunctions in  $x$  of the homogeneous problem. The eigenvalue problem is

$$X'' = -\lambda^2 X, \quad X'(0) = X'(L) = 0,$$

which has the solutions,

$$\lambda_0 = 0, \quad X_0 = 1, \\ \lambda_n = \frac{n\pi}{L}, \quad X_n = \cos \left( \frac{n\pi x}{L} \right), \quad n = 1, 2, \dots$$

The series expansion of the Green function for  $t > \tau$  has the form,

$$G(x, t; \xi, \tau) = \frac{1}{2} g_0(t) + \sum_{n=1}^{\infty} g_n(t) \cos \left( \frac{n\pi x}{L} \right).$$

(Note the factor of  $1/2$  in front of  $g_0(t)$ . With this, the integral formulas for all the coefficients are the same.) We

determine the coefficients by substituting the expansion into the partial differential equation.

$$G_{tt} - c^2 G_{xx} = \delta(x - \xi)\delta(t - \tau)$$

$$\frac{1}{2}g_0''(t) + \sum_{n=1}^{\infty} \left( g_n''(t) + \left( \frac{n\pi c}{L} \right)^2 g_n(t) \right) \cos\left( \frac{n\pi x}{L} \right) = \delta(x - \xi)\delta(t - \tau)$$

We expand the right side of the equation in the cosine series.

$$\delta(x - \xi)\delta(t - \tau) = \frac{1}{2}d_0(t) + \sum_{n=1}^{\infty} d_n(t) \cos\left( \frac{n\pi x}{L} \right)$$

$$d_n(t) = \frac{2}{L} \int_0^L \delta(x - \xi)\delta(t - \tau) \cos\left( \frac{n\pi x}{L} \right) dx$$

$$d_n(t) = \frac{2}{L} \cos\left( \frac{n\pi \xi}{L} \right) \delta(t - \tau)$$

By equating coefficients in the cosine series, we obtain ordinary differential equations for the  $g_n$ .

$$g_n''(t; \tau) + \left( \frac{n\pi c}{L} \right)^2 g_n(t; \tau) = \frac{2}{L} \cos\left( \frac{n\pi \xi}{L} \right) \delta(t - \tau), \quad n = 0, 1, 2, \dots$$

From the causality condition for  $G$ , we have the causality conditions for the  $g_n$ ,

$$g_n(t; \tau) = g_n'(t; \tau) = 0 \text{ for } t < \tau.$$

The continuity and jump conditions for the  $g_n$  are

$$g_n(\tau^+; \tau) = 0, \quad g_n'(\tau^+; \tau) = \frac{2}{L} \cos\left( \frac{n\pi \xi}{L} \right).$$

The homogeneous solutions of the ordinary differential equation for  $n = 0$  and  $n > 0$  are respectively,

$$\{1, t\}, \quad \left\{ \cos\left( \frac{n\pi ct}{L} \right), \sin\left( \frac{n\pi ct}{L} \right) \right\}.$$

Since the continuity and jump conditions are given at the point  $t = \tau$ , a handy set of solutions to use for this problem is the fundamental set of solutions at that point:

$$\{1, t - \tau\}, \quad \left\{ \cos\left(\frac{n\pi c(t - \tau)}{L}\right), \frac{L}{n\pi c} \sin\left(\frac{n\pi c(t - \tau)}{L}\right) \right\}.$$

The solutions that satisfy the causality condition and the continuity and jump conditions are,

$$g_0(t) = \frac{2}{L}(t - \tau)H(t - \tau),$$

$$g_n(t) = \frac{2}{n\pi c} \cos\left(\frac{n\pi\xi}{L}\right) \sin\left(\frac{n\pi c(t - \tau)}{L}\right) H(t - \tau).$$

Substituting this into the sum yields,

$$G(x, t; \xi, \tau) = H(t - \tau) \left( \frac{t - \tau}{L} + \frac{2}{\pi c} \sum_{n=1}^{\infty} \frac{1}{n} \cos\left(\frac{n\pi\xi}{L}\right) \sin\left(\frac{n\pi c(t - \tau)}{L}\right) \cos\left(\frac{n\pi x}{L}\right) \right).$$

We can write this as the sum of traveling waves.

$$G(x, t; \xi, \tau) = \frac{t - \tau}{L} H(t - \tau) + \frac{1}{2\pi c} H(t - \tau) \sum_{n=1}^{\infty} \frac{1}{n} \left( -\sin\left(\frac{n\pi((x - \xi) - c(t - \tau))}{2L}\right) \right. \\ \left. + \sin\left(\frac{n\pi((x - \xi) + c(t - \tau))}{2L}\right) - \sin\left(\frac{n\pi((x + \xi) - c(t - \tau))}{2L}\right) \right. \\ \left. + \sin\left(\frac{n\pi((x + \xi) + c(t - \tau))}{2L}\right) \right)$$

**Solution 45.23**

First we derive Green's identity for this problem. We consider the integral of  $uL[v] - L[u]v$  on the domain  $0 < x < 1$ ,  $0 < t < T$ .

$$\begin{aligned} & \int_0^T \int_0^1 (uL[v] - L[u]v) \, dx \, dt \\ & \int_0^T \int_0^1 (u(v_{tt} - c^2v_{xx}) - (u_{tt} - c^2u_{xx})v) \, dx \, dt \\ & \int_0^T \int_0^1 \left( \left( \frac{\partial}{\partial x}, \frac{\partial}{\partial t} \right) \cdot (-c^2(uv_x - u_xv), uv_t - u_tv) \right) \, dx \, dt \end{aligned}$$

Now we can use the divergence theorem to write this as an integral along the boundary of the domain.

$$\oint_{\partial\Omega} (-c^2(uv_x - u_xv), uv_t - u_tv) \cdot \mathbf{n} \, ds$$

The domain and the outward normal vectors are shown in Figure 45.7.

Writing out the boundary integrals, Green's identity for this problem is,

$$\begin{aligned} \int_0^T \int_0^1 (u(v_{tt} - c^2v_{xx}) - (u_{tt} - c^2u_{xx})v) \, dx \, dt &= - \int_0^1 (uv_t - u_tv)_{t=0} \, dx \\ &+ \int_1^0 (uv_t - u_tv)_{t=T} \, dx - c^2 \int_0^T (uv_x - u_xv)_{x=1} \, dt + c^2 \int_0^T (uv_x - u_xv)_{x=0} \, dt \end{aligned}$$

The Green function problem is

$$\begin{aligned} G_{tt} - c^2G_{xx} &= \delta(x - \xi)\delta(t - \tau), \quad 0 < x, \xi < 1, \quad t, \tau > 0, \\ G_x(0, t; \xi, \tau) &= G_x(1, t; \xi, \tau) = 0, \quad t > 0, \quad G(x, t; \xi, \tau) = 0 \quad \text{for } t < \tau. \end{aligned}$$

If we consider  $G$  as a function of  $(\xi, \tau)$  with  $(x, t)$  as parameters, then it satisfies:

$$\begin{aligned} G_{\tau\tau} - c^2G_{\xi\xi} &= \delta(x - \xi)\delta(t - \tau), \\ G_\xi(x, t; 0, \tau) &= G_\xi(x, t; 1, \tau) = 0, \quad \tau > 0, \quad G(x, t; \xi, \tau) = 0 \quad \text{for } \tau > t. \end{aligned}$$

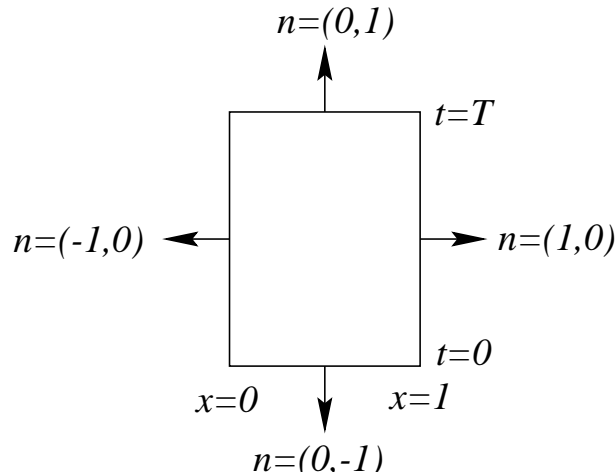

Figure 45.7: Outward normal vectors of the domain.

Now we apply Green's identity for  $u = u(\xi, \tau)$ , (the solution of the wave equation), and  $v = G(x, t; \xi, \tau)$ , (the Green function), and integrate in the  $(\xi, \tau)$  variables. The left side of Green's identity becomes:

$$\int_0^T \int_0^1 (u(G_{\tau\tau} - c^2 G_{\xi\xi}) - (u_{\tau\tau} - c^2 u_{\xi\xi})G) \, d\xi \, d\tau$$

$$\int_0^T \int_0^1 (u(\delta(x - \xi)\delta(t - \tau)) - (0)G) \, d\xi \, d\tau$$

$$u(x, t).$$

Since the normal derivative of  $u$  and  $G$  vanish on the sides of the domain, the integrals along  $\xi = 0$  and  $\xi = 1$  in Green's identity vanish. If we take  $T > t$ , then  $G$  is zero for  $\tau = T$  and the integral along  $\tau = T$  vanishes. The one remaining integral is

$$-\int_0^1 (u(\xi, 0)G_\tau(x, t; \xi, 0) - u_\tau(\xi, 0)G(x, t; \xi, 0)) \, d\xi.$$

Thus Green's identity allows us to write the solution of the inhomogeneous problem.

$$u(x, t) = \int_0^1 (u_\tau(\xi, 0)G(x, t; \xi, 0) - u(\xi, 0)G_\tau(x, t; \xi, 0)) d\xi.$$

With the specified initial conditions this becomes

$$u(x, t) = \int_0^1 (G(x, t; \xi, 0) - \xi^2(1 - \xi)^2 G_\tau(x, t; \xi, 0)) d\xi.$$

Now we substitute in the Green function that we found in the previous exercise. The Green function and its derivative are,

$$G(x, t; \xi, 0) = t + \sum_{n=1}^{\infty} \frac{2}{n\pi c} \cos(n\pi\xi) \sin(n\pi ct) \cos(n\pi x),$$

$$G_\tau(x, t; \xi, 0) = -1 - 2 \sum_{n=1}^{\infty} \cos(n\pi\xi) \cos(n\pi ct) \cos(n\pi x).$$

The integral of the first term is,

$$\int_0^1 \left( t + \sum_{n=1}^{\infty} \frac{2}{n\pi c} \cos(n\pi\xi) \sin(n\pi ct) \cos(n\pi x) \right) d\xi = t.$$

The integral of the second term is

$$\int_0^1 \xi^2(1 - \xi)^2 \left( 1 + 2 \sum_{n=1}^{\infty} \cos(n\pi\xi) \cos(n\pi ct) \cos(n\pi x) \right) d\xi = \frac{1}{30} - 3 \sum_{n=1}^{\infty} \frac{1}{n^4 \pi^4} \cos(2n\pi x) \cos(2n\pi ct).$$

Thus the solution is

$$u(x, t) = \frac{1}{30} + t - 3 \sum_{n=1}^{\infty} \frac{1}{n^4 \pi^4} \cos(2n\pi x) \cos(2n\pi ct).$$



For  $c = 1$ , the solution at  $x = 3/4$ ,  $t = 7/2$  is,

$$u(3/4, 7/2) = \frac{1}{30} + \frac{7}{2} - 3 \sum_{n=1}^{\infty} \frac{1}{n^4 \pi^4} \cos(3n\pi/2) \cos(7n\pi).$$

Note that the summand is nonzero only for even terms.

$$\begin{aligned} u(3/4, 7/2) &= \frac{53}{15} - \frac{3}{16\pi^4} \sum_{n=1}^{\infty} \frac{1}{n^4} \cos(3n\pi) \cos(14n\pi) \\ &= \frac{53}{15} - \frac{3}{16\pi^4} \sum_{n=1}^{\infty} \frac{(-1)^n}{n^4} \\ &= \frac{53}{15} - \frac{3}{16\pi^4} \frac{-7\pi^4}{720} \end{aligned}$$

$$\boxed{u(3/4, 7/2) = \frac{12727}{3840}}$$

# Chapter 46

## Conformal Mapping

## 46.1 Exercises

### Exercise 46.1

Use an appropriate conformal map to find a non-trivial solution to Laplace's equation

$$u_{xx} + u_{yy} = 0,$$

on the wedge bounded by the  $x$ -axis and the line  $y = x$  with boundary conditions:

1.  $u = 0$  on both sides.
2.  $\frac{du}{dn} = 0$  on both sides (where  $\mathbf{n}$  is the inward normal to the boundary).

### Exercise 46.2

Consider

$$u_{xx} + u_{yy} = \delta(x - \xi)\delta(y - \psi),$$

on the quarter plane  $x, y > 0$  with  $u(x, 0) = u(0, y) = 0$  (and  $\xi, \psi > 0$ ).

1. Use image sources to find  $u(x, y; \xi, \psi)$ .
2. Compare this to the solution which would be obtained using conformal maps and the Green function for the upper half plane.
3. Finally use this idea and conformal mapping to discover how image sources are arrayed when the domain is now the wedge bounded by the  $x$ -axis and the line  $y = x$  (with  $u = 0$  on both sides).

### Exercise 46.3

$\zeta = \xi + \eta i$  is an analytic function of  $z$ ,  $\zeta = \zeta(z)$ . We assume that  $\zeta'(z)$  is nonzero on the domain of interest.  $u(x, y)$  is an arbitrary smooth function of  $x$  and  $y$ . When expressed in terms of  $\xi$  and  $\eta$ ,  $u(x, y) = v(\xi, \eta)$ . In Exercise 8.15 we showed that

$$\frac{\partial^2 v}{\partial \xi^2} + \frac{\partial^2 v}{\partial \eta^2} = \left| \frac{d\zeta}{dz} \right|^{-2} \left( \frac{\partial^2 u}{\partial x^2} + \frac{\partial^2 u}{\partial y^2} \right).$$

1. Show that if  $u$  satisfies Laplace's equation in the  $z$ -plane,

$$u_{xx} + u_{yy} = 0,$$

then  $v$  satisfies Laplace's equation in the  $\zeta$ -plane,

$$v_{\xi\xi} + v_{\eta\eta} = 0,$$

2. Show that if  $u$  satisfies Helmholtz's equation in the  $z$ -plane,

$$u_{xx} + u_{yy} = \lambda u,$$

then in the  $\zeta$ -plane  $v$  satisfies

$$v_{\xi\xi} + v_{\eta\eta} = \lambda \left| \frac{dz}{d\zeta} \right|^2 v.$$

3. Show that if  $u$  satisfies Poisson's equation in the  $z$ -plane,

$$u_{xx} + u_{yy} = f(x, y),$$

then  $v$  satisfies Poisson's equation in the  $\zeta$ -plane,

$$v_{\xi\xi} + v_{\eta\eta} = \left| \frac{dz}{d\zeta} \right|^2 \phi(\xi, \eta),$$

where  $\phi(\xi, \eta) = f(x, y)$ .

4. Show that if in the  $z$ -plane,  $u$  satisfies the Green function problem,

$$u_{xx} + u_{yy} = \delta(x - x_0)\delta(y - y_0),$$

then in the  $\zeta$ -plane,  $v$  satisfies the Green function problem,

$$v_{\xi\xi} + v_{\eta\eta} = \delta(\xi - \xi_0)\delta(\eta - \eta_0).$$

**Exercise 46.4**

A semi-circular rod of infinite extent is maintained at temperature  $T = 0$  on the flat side and at  $T = 1$  on the curved surface:

$$x^2 + y^2 = 1, \quad y > 0.$$

Use the conformal mapping

$$w = \xi + i\eta = \frac{1+z}{1-z}, \quad z = x + iy,$$

to formulate the problem in terms of  $\xi$  and  $\eta$ . Solve the problem in terms of these variables. This problem is solved with an eigenfunction expansion in Exercise 37.24. Verify that the two solutions agree.

**Exercise 46.5**

Consider Laplace's equation on the domain  $-\infty < x < \infty$ ,  $0 < y < \pi$ , subject to the mixed boundary conditions,

$$\begin{aligned} u &= 1 && \text{on } y = 0, \quad x > 0, \\ u &= 0 && \text{on } y = \pi, \quad x > 0, \\ u_y &= 0 && \text{on } y = 0, \quad y = \pi, \quad x < 0. \end{aligned}$$

Because of the mixed boundary conditions, ( $u$  and  $u_y$  are given on separate parts of the same boundary), this problem cannot be solved with separation of variables. Verify that the conformal map,

$$\zeta = \cosh^{-1}(e^z),$$

with  $z = x + iy$ ,  $\zeta = \xi + i\eta$  maps the infinite interval into the semi-infinite interval,  $\xi > 0$ ,  $0 < \eta < \pi$ . Solve Laplace's equation with the appropriate boundary conditions in the  $\zeta$  plane by inspection. Write the solution  $u$  in terms of  $x$  and  $y$ .

## 46.2 Hints

### Hint 46.1

### Hint 46.2

### Hint 46.3

### Hint 46.4

Show that  $w = (1 + z)/(1 - z)$  maps the semi-disc,  $0 < r < 1$ ,  $0 < \theta < \pi$  to the first quadrant of the  $w$  plane. Solve the problem for  $v(\xi, \eta)$  by taking Fourier sine transforms in  $\xi$  and  $\eta$ .

To show that the solution for  $v(\xi, \eta)$  is equivalent to the series expression for  $u(r, \theta)$ , first find an analytic function  $g(w)$  of which  $v(\xi, \eta)$  is the imaginary part. Change variables to  $z$  to obtain the analytic function  $f(z) = g(w)$ . Expand  $f(z)$  in a Taylor series and take the imaginary part to show the equivalence of the solutions.

### Hint 46.5

To see how the boundary is mapped, consider the map,

$$z = \log(\cosh \zeta).$$

The problem in the  $\zeta$  plane is,

$$\begin{aligned} v_{\xi\xi} + v_{\eta\eta} &= 0, & \xi > 0, & & 0 < \eta < \pi, \\ v_{\xi}(0, \eta) &= 0, & v(\xi, 0) &= 1, & v(\xi, \pi) &= 0. \end{aligned}$$

To solve this, find a plane that satisfies the boundary conditions.

## 46.3 Solutions

### Solution 46.1

We map the wedge to the upper half plane with the conformal transformation  $\zeta = z^4$ .

1. We map the wedge to the upper half plane with the conformal transformation  $\zeta = z^4$ . The new problem is

$$u_{\xi\xi} + u_{\eta\eta} = 0, \quad u(\xi, 0) = 0.$$

This has the solution  $u = \eta$ . We transform this problem back to the wedge.

$$\begin{aligned} u(x, y) &= \Im(z^4) \\ u(x, y) &= \Im(x^4 + i4x^3y - 6x^2y^2 - i4xy^3 + y^4) \\ u(x, y) &= 4x^3y - 4xy^3 \\ \boxed{u(x, y) &= 4xy(x^2 - y^2)} \end{aligned}$$

2. We don't need to use conformal mapping to solve the problem with Neumann boundary conditions.  $u = c$  is a solution to

$$u_{xx} + u_{yy} = 0, \quad \frac{du}{dn} = 0$$

on any domain.

### Solution 46.2

1. We add image sources to satisfy the boundary conditions.

$$u_{xx} + u_{yy} = \delta(x - \xi)\delta(y - \eta) - \delta(x + \xi)\delta(y - \eta) - \delta(x - \xi)\delta(y + \eta) + \delta(x + \xi)\delta(y + \eta)$$

$$\begin{aligned} u = \frac{1}{2\pi} & \left( \ln \left( \sqrt{(x - \xi)^2 + (y - \eta)^2} \right) - \ln \left( \sqrt{(x + \xi)^2 + (y - \eta)^2} \right) \right. \\ & \left. - \ln \left( \sqrt{(x - \xi)^2 + (y + \eta)^2} \right) + \ln \left( \sqrt{(x + \xi)^2 + (y + \eta)^2} \right) \right) \end{aligned}$$

$$u = \frac{1}{4\pi} \ln \left( \frac{((x - \xi)^2 + (y - \eta)^2) ((x + \xi)^2 + (y + \eta)^2)}{((x + \xi)^2 + (y - \eta)^2) ((x - \xi)^2 + (y + \eta)^2)} \right)$$

2. The Green function for the upper half plane is

$$G = \frac{1}{4\pi} \ln \left( \frac{((x - \xi)^2 + (y - \eta)^2)}{((x - \xi)^2 + (y + \eta)^2)} \right)$$

We use the conformal map,

$$\begin{aligned} c &= z^2, & c &= a + ib. \\ a &= x^2 - y^2, & b &= 2xy \end{aligned}$$

We compute the Jacobian of the mapping.

$$J = \begin{vmatrix} a_x & a_y \\ b_x & b_y \end{vmatrix} = \begin{vmatrix} 2x & -2y \\ 2y & 2x \end{vmatrix} = 4(x^2 + y^2)$$

We transform the problem to the upper half plane, solve the problem there, and then transform back to the first quadrant.

$$\begin{aligned} u_{xx} + u_{yy} &= \delta(x - \xi)\delta(y - \eta) \\ (u_{aa} + u_{bb}) \left| \frac{dc}{dz} \right|^2 &= 4(x^2 + y^2) \delta(a - \alpha)\delta(b - \beta) \\ (u_{aa} + u_{bb}) |2z|^2 &= 4(x^2 + y^2) \delta(a - \alpha)\delta(b - \beta) \\ u_{aa} + u_{bb} &= \delta(a - \alpha)\delta(b - \beta) \\ u &= \frac{1}{4\pi} \ln \left( \frac{((a - \alpha)^2 + (b - \beta)^2)}{((a - \alpha)^2 + (b + \beta)^2)} \right) \\ u &= \frac{1}{4\pi} \ln \left( \frac{((x^2 - y^2 - \xi^2 + \eta^2)^2 + (2xy - 2\xi\eta)^2)}{((x^2 - y^2 - \xi^2 + \eta^2)^2 + (2xy + 2\xi\eta)^2)} \right) \end{aligned}$$

$$u = \frac{1}{4\pi} \ln \left( \frac{((x - \xi)^2 + (y - \eta)^2) ((x + \xi)^2 + (y + \eta)^2)}{((x + \xi)^2 + (y - \eta)^2) ((x - \xi)^2 + (y + \eta)^2)} \right)$$



We obtain the some solution as before.

3. First consider

$$\Delta u = \delta(x - \xi)\delta(y - \eta), \quad u(x, 0) = u(x, x) = 0.$$

Enforcing the boundary conditions will require 7 image sources obtained from 4 odd reflections. Refer to Figure 46.1 to see the reflections pictorially. First we do a negative reflection across the line  $y = x$ , which adds a negative image source at the point  $(\eta, \xi)$  This enforces the boundary condition along  $y = x$ .

$$\Delta u = \delta(x - \xi)\delta(y - \eta) - \delta(x - \eta)\delta(y - \xi), \quad u(x, 0) = u(x, x) = 0$$

Now we take the negative image of the reflection of these two sources across the line  $y = 0$  to enforce the boundary condition there.

$$\Delta u = \delta(x - \xi)\delta(y - \eta) - \delta(x - \eta)\delta(y - \xi) - \delta(x - \xi)\delta(y + \eta) + \delta(x - \eta)\delta(y + \xi)$$

The point sources are no longer odd symmetric about  $y = x$ . We add two more image sources to enforce that boundary condition.

$$\begin{aligned} \Delta u = \delta(x - \xi)\delta(y - \eta) - \delta(x - \eta)\delta(y - \xi) - \delta(x - \xi)\delta(y + \eta) + \delta(x - \eta)\delta(y + \xi) \\ + \delta(x + \eta)\delta(y - \xi) - \delta(x + \xi)\delta(y - \eta) \end{aligned}$$

Now sources are no longer odd symmetric about  $y = 0$ . Finally we add two more image sources to enforce that boundary condition. Now the sources are odd symmetric about both  $y = x$  and  $y = 0$ .

$$\begin{aligned} \Delta u = \delta(x - \xi)\delta(y - \eta) - \delta(x - \eta)\delta(y - \xi) - \delta(x - \xi)\delta(y + \eta) + \delta(x - \eta)\delta(y + \xi) \\ + \delta(x + \eta)\delta(y - \xi) - \delta(x + \xi)\delta(y - \eta) + \delta(x + \xi)\delta(y + \eta) - \delta(x + \eta)\delta(y + \xi) \end{aligned}$$

### Solution 46.3

$$\frac{\partial^2 v}{\partial \xi^2} + \frac{\partial^2 v}{\partial \eta^2} = \left| \frac{d\zeta}{dz} \right|^{-2} \left( \frac{\partial^2 u}{\partial x^2} + \frac{\partial^2 u}{\partial y^2} \right).$$

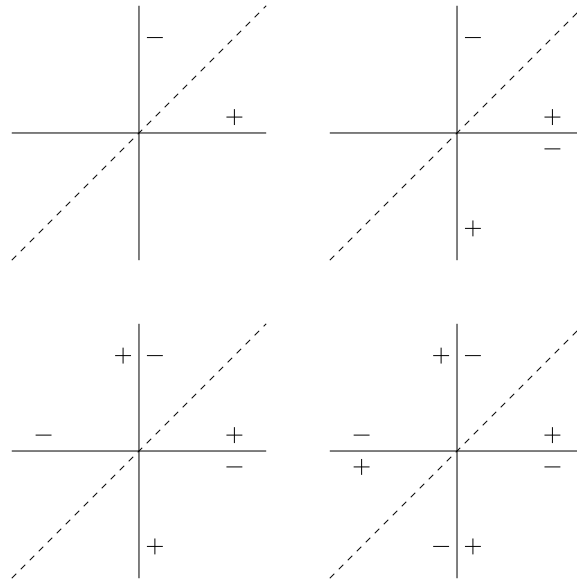

Figure 46.1: Odd reflections to enforce the boundary conditions.

1.

$$\begin{aligned}
 u_{xx} + u_{yy} &= 0 \\
 \left| \frac{d\zeta}{dz} \right|^2 (v_{\xi\xi} + v_{\eta\eta}) &= 0 \\
 v_{\xi\xi} + v_{\eta\eta} &= 0
 \end{aligned}$$

2.

$$\begin{aligned}u_{xx} + u_{yy} &= \lambda u \\ \left| \frac{d\zeta}{dz} \right|^2 (v_{\xi\xi} + v_{\eta\eta}) &= \lambda v \\ v_{\xi\xi} + v_{\eta\eta} &= \lambda \left| \frac{dz}{d\zeta} \right|^2 v\end{aligned}$$

3.

$$\begin{aligned}u_{xx} + u_{yy} &= f(x, y) \\ \left| \frac{d\zeta}{dz} \right|^2 (v_{\xi\xi} + v_{\eta\eta}) &= \phi(\xi, \eta) \\ v_{\xi\xi} + v_{\eta\eta} &= \left| \frac{dz}{d\zeta} \right|^2 \phi(\xi, \eta)\end{aligned}$$

4. The Jacobian of the mapping is

$$J = \begin{vmatrix} x_\xi & y_\xi \\ x_\eta & y_\eta \end{vmatrix} = x_\xi y_\eta - x_\eta y_\xi = x_\xi^2 + y_\xi^2.$$

Thus the Dirac delta function on the right side gets mapped to

$$\frac{1}{x_\xi^2 + y_\xi^2} \delta(\xi - \xi_0) \delta(\eta - \eta_0).$$

Next we show that  $|dz/d\zeta|^2$  has the same value as the Jacobian.

$$\left| \frac{dz}{d\zeta} \right|^2 = (x_\xi + iy_\xi)(x_\xi - iy_\xi) = x_\xi^2 + y_\xi^2$$

Now we transform the Green function problem.

$$\begin{aligned}
 u_{xx} + u_{yy} &= \delta(x - x_0)\delta(y - y_0) \\
 \left| \frac{d\zeta}{dz} \right|^2 (v_{\xi\xi} + v_{\eta\eta}) &= \frac{1}{x_\xi^2 + y_\xi^2} \delta(\xi - \xi_0)\delta(\eta - \eta_0) \\
 v_{\xi\xi} + v_{\eta\eta} &= \delta(\xi - \xi_0)\delta(\eta - \eta_0)
 \end{aligned}$$

### Solution 46.4

The mapping,

$$w = \frac{1+z}{1-z},$$

maps the unit semi-disc to the first quadrant of the complex plane.

We write the mapping in terms of  $r$  and  $\theta$ .

$$\xi + i\eta = \frac{1 + r e^{i\theta}}{1 - r e^{i\theta}} = \frac{1 - r^2 + i2r \sin \theta}{1 + r^2 - 2r \cos \theta}$$

$$\begin{aligned}
 \xi &= \frac{1 - r^2}{1 + r^2 - 2r \cos \theta} \\
 \eta &= \frac{2r \sin \theta}{1 + r^2 - 2r \cos \theta}
 \end{aligned}$$

Consider a semi-circle of radius  $r$ . The image of this under the conformal mapping is a semi-circle of radius  $\frac{2r}{1-r^2}$  and center  $\frac{1+r^2}{1-r^2}$  in the first quadrant of the  $w$  plane. This semi-circle intersects the  $\xi$  axis at  $\frac{1-r}{1+r}$  and  $\frac{1+r}{1-r}$ . As  $r$  ranges from zero to one, these semi-circles cover the first quadrant of the  $w$  plane. (See Figure 46.2.)

We also note how the boundary of the semi-disc is mapped to the boundary of the first quadrant of the  $w$  plane. The line segment  $\theta = 0$  is mapped to the real axis  $\xi > 1$ . The line segment  $\theta = \pi$  is mapped to the real axis  $0 < \xi < 1$ . Finally, the semi-circle  $r = 1$  is mapped to the positive imaginary axis.

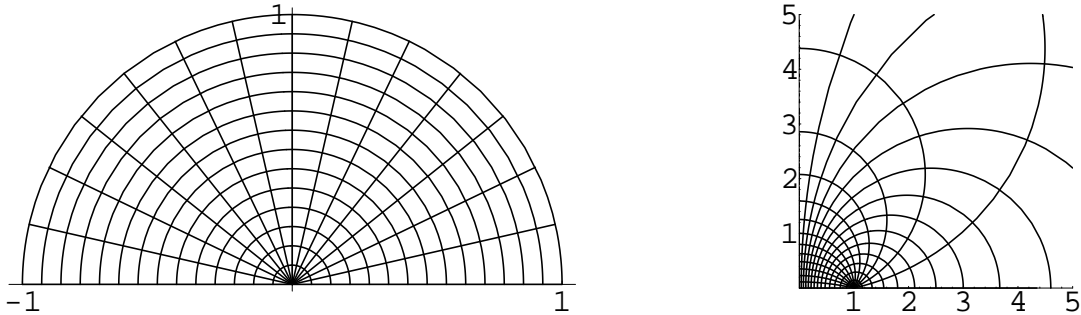

Figure 46.2: The conformal map,  $w = \frac{1+z}{1-z}$ .

The problem for  $v(\xi, \eta)$  is,

$$\begin{aligned} v_{\xi\xi} + v_{\eta\eta} &= 0, & \xi > 0, & \eta > 0, \\ v(\xi, 0) &= 0, & v(0, \eta) &= 1. \end{aligned}$$

We will solve this problem with the Fourier sine transform. We take the Fourier sine transform of the partial differential equation, first in  $\xi$  and then in  $\eta$ .

$$\begin{aligned} -\alpha^2 \hat{v}(\alpha, \eta) + \frac{\alpha}{\pi} v(0, \eta) + \hat{v}(\alpha, \eta) &= 0, & \hat{v}(\alpha, 0) &= 0 \\ -\alpha^2 \hat{v}(\alpha, \eta) + \frac{\alpha}{\pi} + \hat{v}(\alpha, \eta) &= 0, & \hat{v}(\alpha, 0) &= 0 \\ -\alpha^2 \hat{\hat{v}}(\alpha, \beta) + \frac{\alpha}{\pi^2 \beta} - \beta^2 \hat{\hat{v}}(\alpha, \beta) + \frac{\beta}{\pi} \hat{v}(\alpha, 0) &= 0 \\ \hat{\hat{v}}(\alpha, \beta) &= \frac{\alpha}{\pi^2 \beta (\alpha^2 + \beta^2)} \end{aligned}$$

Now we utilize the Fourier sine transform pair,

$$\mathcal{F}_s [e^{-cx}] = \frac{\omega/\pi}{\omega^2 + c^2},$$

to take the inverse sine transform in  $\alpha$ .

$$\hat{v}(\xi, \beta) = \frac{1}{\pi\beta} e^{-\beta\xi}$$

With the Fourier sine transform pair,

$$\mathcal{F}_s \left[ 2 \arctan \left( \frac{x}{c} \right) \right] = \frac{1}{\omega} e^{-c\omega},$$

we take the inverse sine transform in  $\beta$  to obtain the solution.

$$v(\xi, \eta) = \frac{2}{\pi} \arctan \left( \frac{\eta}{\xi} \right)$$

Since  $v$  is harmonic, it is the imaginary part of an analytic function  $g(w)$ . By inspection, we see that this function is

$$g(w) = \frac{2}{\pi} \log(w).$$

We change variables to  $z$ ,  $f(z) = g(w)$ .

$$f(z) = \frac{2}{\pi} \log \left( \frac{1+z}{1-z} \right)$$

We expand  $f(z)$  in a Taylor series about  $z = 0$ ,

$$f(z) = \frac{4}{\pi} \sum_{\substack{n=1 \\ \text{odd } n}}^{\infty} \frac{z^n}{n},$$

and write the result in terms of  $r$  and  $\theta$ ,  $z = r e^{i\theta}$ .

$$f(z) = \frac{4}{\pi} \sum_{\substack{n=1 \\ \text{odd } n}}^{\infty} \frac{r^n e^{i n \theta}}{n}$$

$u(r, \theta)$  is the imaginary part of  $f(z)$ .

$$u(r, \theta) = \frac{4}{\pi} \sum_{\substack{n=1 \\ \text{odd } n}}^{\infty} \frac{1}{n} r^n \sin(n\theta)$$

This demonstrates that the solutions obtained with conformal mapping and with an eigenfunction expansion in Exercise 37.24 agree.

### Solution 46.5

Instead of working with the conformal map from the  $z$  plane to the  $\zeta$  plane,

$$\zeta = \cosh^{-1}(e^z),$$

it will be more convenient to work with the inverse map,

$$z = \log(\cosh \zeta),$$

which maps the semi-infinite strip to the infinite one. We determine how the boundary of the domain is mapped so that we know the appropriate boundary conditions for the semi-infinite strip domain.

- A  $\{\zeta : \xi > 0, \eta = 0\} \mapsto \{\log(\cosh(\xi)) : \xi > 0\} = \{z : x > 0, y = 0\}$   
 B  $\{\zeta : \xi > 0, \eta = \pi\} \mapsto \{\log(-\cosh(\xi)) : \xi > 0\} = \{z : x > 0, y = \pi\}$   
 C  $\{\zeta : \xi = 0, 0 < \eta < \pi/2\} \mapsto \{\log(\cos(\eta)) : 0 < \eta < \pi/2\} = \{z : x < 0, y = 0\}$   
 D  $\{\zeta : \xi = 0, \pi/2 < \eta < \pi\} \mapsto \{\log(\cos(\eta)) : \pi/2 < \eta < \pi\} = \{z : x < 0, y = \pi\}$

From the mapping of the boundary, we see that the solution  $v(\xi, \eta) = u(x, y)$ , is 1 on the bottom of the semi-infinite strip, 0 on the top. The normal derivative of  $v$  vanishes on the vertical boundary. See Figure 46.3.

In the  $\zeta$  plane, the problem is,

$$\begin{aligned} v_{\xi\xi} + v_{\eta\eta} &= 0, & \xi > 0, & \quad 0 < \eta < \pi, \\ v_{\xi}(0, \eta) &= 0, & v(\xi, 0) &= 1, & \quad v(\xi, \pi) = 0. \end{aligned}$$

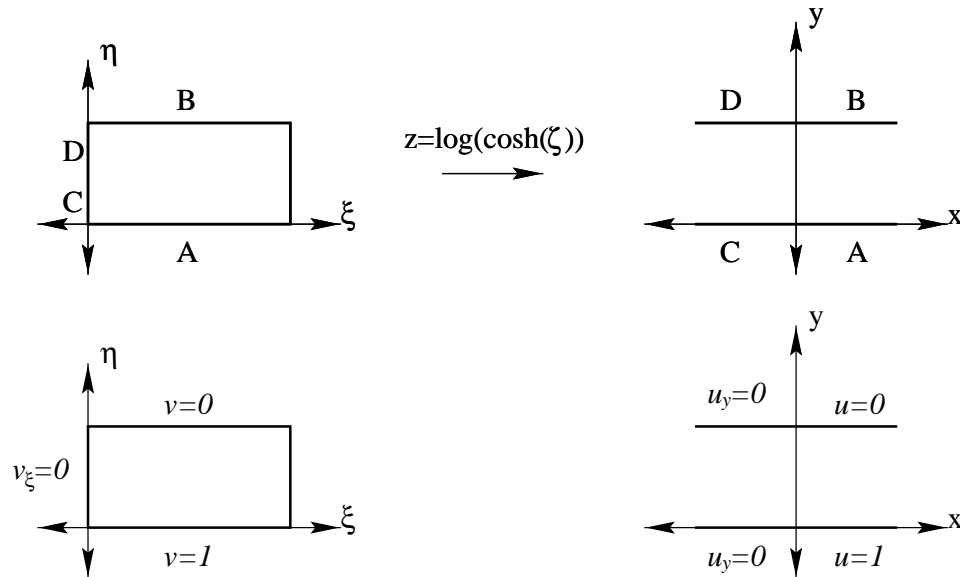

Figure 46.3: The mapping of the boundary conditions.

By inspection, we see that the solution of this problem is,

$$v(\xi, \eta) = 1 - \frac{\eta}{\pi}.$$

The solution in the  $z$  plane is

$$u(x, y) = 1 - \frac{1}{\pi} \Im (\cosh^{-1}(e^z)),$$

where  $z = x + iy$ . We will find the imaginary part of  $\cosh^{-1}(e^z)$  in order to write this explicitly in terms of  $x$  and  $y$ .



Recall that we can write the  $\cosh^{-1}$  in terms of the logarithm.

$$\begin{aligned}\cosh^{-1}(w) &= \log\left(w + \sqrt{w^2 - 1}\right) \\ \cosh^{-1}(e^z) &= \log\left(e^z + \sqrt{e^{2z} - 1}\right) \\ &= \log\left(e^z \left(1 + \sqrt{1 - e^{-2z}}\right)\right) \\ &= z + \log\left(1 + \sqrt{1 - e^{-2z}}\right)\end{aligned}$$

Now we need to find the imaginary part. We'll work from the inside out. First recall,

$$\sqrt{x + iy} = \sqrt{\sqrt{x^2 + y^2} \exp\left(i \tan^{-1}\left(\frac{y}{x}\right)\right)} = \sqrt[4]{x^2 + y^2} \exp\left(\frac{i}{2} \tan^{-1}\left(\frac{y}{x}\right)\right),$$

so that we can write the innermost factor as,

$$\begin{aligned}\sqrt{1 - e^{-2z}} &= \sqrt{1 - e^{-2x} \cos(2y) + i e^{-2x} \sin(2y)} \\ &= \sqrt[4]{(1 - e^{-2x} \cos(2y))^2 + (e^{-2x} \sin(2y))^2} \exp\left(\frac{i}{2} \tan^{-1}\left(\frac{e^{-2x} \sin(2y)}{1 - e^{-2x} \cos(2y)}\right)\right) \\ &= \sqrt[4]{1 - 2e^{-2x} \cos(2y) + e^{-4x}} \exp\left(\frac{i}{2} \tan^{-1}\left(\frac{\sin(2y)}{e^{2x} - \cos(2y)}\right)\right)\end{aligned}$$

We substitute this into the logarithm.

$$\log\left(1 + \sqrt{1 - e^{-2z}}\right) = \log\left(1 + \sqrt[4]{1 - 2e^{-2x} \cos(2y) + e^{-4x}} \exp\left(\frac{i}{2} \tan^{-1}\left(\frac{\sin(2y)}{e^{2x} - \cos(2y)}\right)\right)\right)$$

Now we can write  $\eta$ .

$$\begin{aligned}\eta &= \Im\left(z + \log\left(1 + \sqrt{1 - e^{-2z}}\right)\right) \\ \eta &= y + \tan^{-1}\left(\frac{\sqrt[4]{1 - 2e^{-2x} \cos(2y) + e^{-4x}} \sin\left(\frac{1}{2} \tan^{-1}\left(\frac{\sin(2y)}{e^{2x} - \cos(2y)}\right)\right)}{1 + \sqrt[4]{1 - 2e^{-2x} \cos(2y) + e^{-4x}} \cos\left(\frac{1}{2} \tan^{-1}\left(\frac{\sin(2y)}{e^{2x} - \cos(2y)}\right)\right)}\right)\end{aligned}$$

Finally we have the solution,  $u(x, y)$ .

$$u(x, y) = 1 - \frac{y}{\pi} - \frac{1}{\pi} \tan^{-1} \left( \frac{\sqrt[4]{1 - 2e^{-2x} \cos(2y) + e^{-4x}} \sin \left( \frac{1}{2} \tan^{-1} \left( \frac{\sin(2y)}{e^{2x} - \cos(2y)} \right) \right)}{1 + \sqrt[4]{1 - 2e^{-2x} \cos(2y) + e^{-4x}} \cos \left( \frac{1}{2} \tan^{-1} \left( \frac{\sin(2y)}{e^{2x} - \cos(2y)} \right) \right)} \right)$$

# Chapter 47

## Non-Cartesian Coordinates

### 47.1 Spherical Coordinates

Writing rectangular coordinates in terms of spherical coordinates,

$$x = r \cos \theta \sin \phi$$

$$y = r \sin \theta \sin \phi$$

$$z = r \cos \phi.$$

The Jacobian is

$$\begin{aligned} & \begin{vmatrix} \cos \theta \sin \phi & -r \sin \theta \sin \phi & r \cos \theta \cos \phi \\ \sin \theta \sin \phi & r \cos \theta \sin \phi & r \sin \theta \cos \phi \\ \cos \phi & 0 & -r \sin \phi \end{vmatrix} \\ &= r^2 \sin \phi \begin{vmatrix} \cos \theta \sin \phi & -\sin \theta & \cos \theta \cos \phi \\ \sin \theta \sin \phi & \cos \theta & \sin \theta \cos \phi \\ \cos \phi & 0 & -\sin \phi \end{vmatrix} \\ &= |r^2 \sin \phi (-\cos^2 \theta \sin^2 \phi - \sin^2 \theta \cos^2 \phi - \cos^2 \theta \cos^2 \phi - \sin^2 \theta \sin^2 \phi)| \\ &= r^2 \sin \phi (\sin^2 \phi + \cos^2 \phi) \\ &= r^2 \sin \phi. \end{aligned}$$

Thus we have that

$$\iiint_V f(x, y, z) \, dx \, dy \, dz = \iiint_V f(r, \theta, \phi) r^2 \sin \phi \, dr \, d\theta \, d\phi.$$

## 47.2 Laplace's Equation in a Disk

Consider Laplace's equation in polar coordinates

$$\frac{1}{r} \frac{\partial}{\partial r} \left( r \frac{\partial u}{\partial r} \right) + \frac{1}{r^2} \frac{\partial^2 u}{\partial \theta^2} = 0, \quad 0 \leq r \leq 1$$

subject to the the boundary conditions

1.  $u(1, \theta) = f(\theta)$
2.  $u_r(1, \theta) = g(\theta)$ .

We separate variables with  $u(r, \theta) = R(r)T(\theta)$ .

$$\frac{1}{r}(R'T + rR''T) + \frac{1}{r^2}RT'' = 0$$
$$r^2\frac{R''}{R} + r\frac{R'}{R} = -\frac{T''}{T} = \lambda$$

Thus we have the two ordinary differential equations

$$T'' + \lambda T = 0, \quad T(0) = T(2\pi), \quad T'(0) = T'(2\pi)$$
$$r^2R'' + rR' - \lambda R = 0, \quad R(0) < \infty.$$

The eigenvalues and eigenfunctions for the equation in  $T$  are

$$\lambda_0 = 0, \quad T_0 = \frac{1}{2}$$
$$\lambda_n = n^2, \quad T_n^{(1)} = \cos(n\theta), \quad T_n^{(2)} = \sin(n\theta)$$

(I chose  $T_0 = 1/2$  so that all the eigenfunctions have the same norm.)

For  $\lambda = 0$  the general solution for  $R$  is

$$R = c_1 + c_2 \log r.$$

Requiring that the solution be bounded gives us

$$R_0 = 1.$$

For  $\lambda = n^2 > 0$  the general solution for  $R$  is

$$R = c_1r^n + c_2r^{-n}.$$

Requiring that the solution be bounded gives us

$$R_n = r^n.$$

Thus the general solution for  $u$  is

$$u(r, \theta) = \frac{a_0}{2} + \sum_{n=1}^{\infty} r^n [a_n \cos(n\theta) + b_n \sin(n\theta)].$$

For the boundary condition  $u(1, \theta) = f(\theta)$  we have the equation

$$f(\theta) = \frac{a_0}{2} + \sum_{n=1}^{\infty} [a_n \cos(n\theta) + b_n \sin(n\theta)].$$

If  $f(\theta)$  has a Fourier series then the coefficients are

$$a_0 = \frac{1}{\pi} \int_0^{2\pi} f(\theta) d\theta$$

$$a_n = \frac{1}{\pi} \int_0^{2\pi} f(\theta) \cos(n\theta) d\theta$$

$$b_n = \frac{1}{\pi} \int_0^{2\pi} f(\theta) \sin(n\theta) d\theta.$$

For the boundary condition  $u_r(1, \theta) = g(\theta)$  we have the equation

$$g(\theta) = \sum_{n=1}^{\infty} n [a_n \cos(n\theta) + b_n \sin(n\theta)].$$

$g(\theta)$  has a series of this form only if

$$\int_0^{2\pi} g(\theta) d\theta = 0.$$

The coefficients are

$$a_n = \frac{1}{n\pi} \int_0^{2\pi} g(\theta) \cos(n\theta) \, d\theta$$
$$b_n = \frac{1}{n\pi} \int_0^{2\pi} g(\theta) \sin(n\theta) \, d\theta.$$

### 47.3 Laplace's Equation in an Annulus

Consider the problem

$$\nabla^2 u = \frac{1}{r} \frac{\partial}{\partial r} \left( r \frac{\partial u}{\partial r} \right) + \frac{1}{r^2} \frac{\partial^2 u}{\partial \theta^2} = 0, \quad 0 \leq r < a, \quad -\pi < \theta \leq \pi,$$

with the boundary condition

$$u(a, \theta) = \theta^2.$$

So far this problem only has one boundary condition. By requiring that the solution be finite, we get the boundary condition

$$|u(0, \theta)| < \infty.$$

By specifying that the solution be  $C^1$ , (continuous and continuous first derivative) we obtain

$$u(r, -\pi) = u(r, \pi) \quad \text{and} \quad \frac{\partial u}{\partial \theta}(r, -\pi) = \frac{\partial u}{\partial \theta}(r, \pi).$$

We will use the method of separation of variables. We seek solutions of the form

$$u(r, \theta) = R(r)\Theta(\theta).$$

Substituting into the partial differential equation,

$$\begin{aligned}\frac{\partial^2 u}{\partial r^2} + \frac{1}{r} \frac{\partial u}{\partial r} + \frac{1}{r^2} \frac{\partial^2 u}{\partial \theta^2} &= 0 \\ R''\Theta + \frac{1}{r} R'\Theta &= -\frac{1}{r^2} R\Theta'' \\ \frac{r^2 R''}{R} + \frac{r R'}{R} &= -\frac{\Theta''}{\Theta} = \lambda\end{aligned}$$

Now we have the boundary value problem for  $\Theta$ ,

$$\Theta''(\theta) + \lambda\Theta(\theta) = 0, \quad -\pi < \theta \leq \pi,$$

subject to

$$\Theta(-\pi) = \Theta(\pi) \quad \text{and} \quad \Theta'(-\pi) = \Theta'(\pi)$$

We consider the following three cases for the eigenvalue,  $\lambda$ ,

$\lambda < 0$ . No linear combination of the solutions,  $\Theta = \exp(\sqrt{-\lambda}\theta)$ ,  $\exp(-\sqrt{-\lambda}\theta)$ , can satisfy the boundary conditions. Thus there are no negative eigenvalues.

$\lambda = 0$ . The general solution is  $\Theta = a + b\theta$ . By applying the boundary conditions, we get  $\Theta = a$ . Thus we have the eigenvalue and eigenfunction,

$$\lambda_0 = 0, \quad A_0 = 1.$$

$\lambda > 0$ . The general solution is  $\Theta = a \cos(\sqrt{\lambda}\theta) + b \sin(\sqrt{\lambda}\theta)$ . Applying the boundary conditions yields the eigenvalues

$$\lambda_n = n^2, \quad n = 1, 2, 3, \dots$$

with the associated eigenfunctions

$$A_n = \cos(n\theta) \quad \text{and} \quad B_n = \sin(n\theta).$$



The equation for  $R$  is

$$r^2 R'' + rR' - \lambda_n R = 0.$$

In the case  $\lambda_0 = 0$ , this becomes

$$\begin{aligned} R'' &= -\frac{1}{r} R' \\ R' &= \frac{a}{r} \\ R &= a \log r + b \end{aligned}$$

Requiring that the solution be bounded at  $r = 0$  yields (to within a constant multiple)

$$R_0 = 1.$$

For  $\lambda_n = n^2$ ,  $n \geq 1$ , we have

$$r^2 R'' + rR' - n^2 R = 0$$

Recognizing that this is an Euler equation and making the substitution  $R = r^\alpha$ ,

$$\begin{aligned} \alpha(\alpha - 1) + \alpha - n^2 &= 0 \\ \alpha &= \pm n \\ R &= ar^n + br^{-n}. \end{aligned}$$

requiring that the solution be bounded at  $r = 0$  we obtain (to within a constant multiple)

$$R_n = r^n$$

The general solution to the partial differential equation is a linear combination of the eigenfunctions

$$u(r, \theta) = c_0 + \sum_{n=1}^{\infty} [c_n r^n \cos n\theta + d_n r^n \sin n\theta].$$

We determine the coefficients of the expansion with the boundary condition

$$u(a, \theta) = \theta^2 = c_0 + \sum_{n=1}^{\infty} [c_n a^n \cos n\theta + d_n a^n \sin n\theta].$$

We note that the eigenfunctions 1,  $\cos n\theta$ , and  $\sin n\theta$  are orthogonal on  $-\pi \leq \theta \leq \pi$ . Integrating the boundary condition from  $-\pi$  to  $\pi$  yields

$$\int_{-\pi}^{\pi} \theta^2 d\theta = \int_{-\pi}^{\pi} c_0 d\theta$$
$$c_0 = \frac{\pi^2}{3}.$$

Multiplying the boundary condition by  $\cos m\theta$  and integrating gives

$$\int_{-\pi}^{\pi} \theta^2 \cos m\theta d\theta = c_m a^m \int_{-\pi}^{\pi} \cos^2 m\theta d\theta$$
$$c_m = \frac{(-1)^m 8\pi}{m^2 a^m}.$$

We multiply by  $\sin m\theta$  and integrate to get

$$\int_{-\pi}^{\pi} \theta^2 \sin m\theta d\theta = d_m a^m \int_{-\pi}^{\pi} \sin^2 m\theta d\theta$$
$$d_m = 0$$

Thus the solution is

$$u(r, \theta) = \frac{\pi^2}{3} + \sum_{n=1}^{\infty} \frac{(-1)^n 8\pi}{n^2 a^n} r^n \cos n\theta.$$

**Part VI**

**Calculus of Variations**

# Chapter 48

## Calculus of Variations

## 48.1 Exercises

### Exercise 48.1

Discuss the problem of minimizing  $\int_0^\alpha ((y')^4 - 6(y')^2) dx$ ,  $y(0) = 0$ ,  $y(\alpha) = \beta$ . Consider both  $C^1[0, \alpha]$  and  $C_p^1[0, \alpha]$ , and comment (with reasons) on whether your answers are weak or strong minima.

### Exercise 48.2

Consider

1.  $\int_{x_0}^{x_1} (a(y')^2 + byy' + cy^2) dx$ ,  $y(x_0) = y_0$ ,  $y(x_1) = y_1$ ,  $a \neq 0$ ,
2.  $\int_{x_0}^{x_1} (y')^3 dx$ ,  $y(x_0) = y_0$ ,  $y(x_1) = y_1$ .

Can these functionals have broken extremals, and if so, find them.

### Exercise 48.3

Discuss finding a weak extremum for the following:

1.  $\int_0^1 ((y'')^2 - 2xy) dx$ ,  $y(0) = y'(0) = 0$ ,  $y(1) = \frac{1}{120}$
2.  $\int_0^1 (\frac{1}{2}(y')^2 + yy' + y' + y) dx$
3.  $\int_a^b (y^2 + 2xyy') dx$ ,  $y(a) = A$ ,  $y(b) = B$
4.  $\int_0^1 (xy + y^2 - 2y^2y') dx$ ,  $y(0) = 1$ ,  $y(1) = 2$

### Exercise 48.4

Find the natural boundary conditions associated with the following functionals:

1.  $\iint_D F(x, y, u, u_x, u_y) dx dy$
2.  $\iint_D (p(x, y)(u_x^2 + u_y^2) - q(x, y)u^2) dx dy + \int_\Gamma \sigma(x, y)u^2 ds$

Here  $D$  represents a closed boundary domain with boundary  $\Gamma$ , and  $ds$  is the arc-length differential.  $p$  and  $q$  are known in  $D$ , and  $\sigma$  is known on  $\Gamma$ .

### Exercise 48.5

The equations for water waves with free surface  $y = h(x, t)$  and bottom  $y = 0$  are

$$\begin{aligned}\phi_{xx} + \phi_{yy} &= 0 && 0 < y < h(x, t), \\ \phi_t + \frac{1}{2}\phi_x^2 + \frac{1}{2}\phi_y^2 + gy &= 0 && \text{on } y = h(x, t), \\ h_t + \phi_x h_x - \phi_y &= 0, && \text{on } y = h(x, t), \\ \phi_y &= 0 && \text{on } y = 0,\end{aligned}$$

where the fluid motion is described by  $\phi(x, y, t)$  and  $g$  is the acceleration of gravity. Show that all these equations may be obtained by varying the functions  $\phi(x, y, t)$  and  $h(x, t)$  in the variational principle

$$\delta \iint_R \left( \int_0^{h(x,t)} \left( \phi_t + \frac{1}{2}\phi_x^2 + \frac{1}{2}\phi_y^2 + gy \right) dy \right) dx dt = 0,$$

where  $R$  is an arbitrary region in the  $(x, t)$  plane.

### Exercise 48.6

Extremize the functional  $\int_a^b F(x, y, y') dx$ ,  $y(a) = A$ ,  $y(b) = B$  given that the admissible curves can not penetrate the interior of a given region  $R$  in the  $(x, y)$  plane. Apply your results to find the curves which extremize  $\int_0^{10} (y')^3 dx$ ,  $y(0) = 0$ ,  $y(10) = 0$  given that the admissible curves can not penetrate the interior of the circle  $(x - 5)^2 + y^2 = 9$ .

### Exercise 48.7

Consider the functional  $\int \sqrt{y} ds$  where  $ds$  is the arc-length differential ( $ds = \sqrt{(dx)^2 + (dy)^2}$ ). Find the curve or curves from a given vertical line to a given fixed point  $B = (x_1, y_1)$  which minimize this functional. Consider both the classes  $C^1$  and  $C_p^1$ .

### Exercise 48.8

A perfectly flexible uniform rope of length  $L$  hangs in equilibrium with one end fixed at  $(x_1, y_1)$  so that it passes over a frictionless pin at  $(x_2, y_2)$ . What is the position of the free end of the rope?

### Exercise 48.9

The drag on a supersonic airfoil of chord  $c$  and shape  $y = y(x)$  is proportional to

$$D = \int_0^c \left( \frac{dy}{dx} \right)^2 dx.$$

Find the shape for minimum drag if the moment of inertia of the contour with respect to the  $x$ -axis is specified; that is, find the shape for minimum drag if

$$\int_0^c y^2 dx = A, \quad y(0) = y(c) = 0, \quad (c, A \text{ given}).$$

### Exercise 48.10

The deflection  $y$  of a beam executing free (small) vibrations of frequency  $\omega$  satisfies the differential equation

$$\frac{d^2}{dx^2} \left( EI \frac{dy}{dx} \right) - \rho \omega^2 y = 0,$$

where  $EI$  is the flexural rigidity and  $\rho$  is the linear mass density. Show that the deflection modes are extremals of the problem

$$\delta \omega^2 \equiv \delta \left( \frac{\int_0^L EI (y'')^2 dx}{\int_0^L \rho y^2 dx} \right) = 0, \quad (L = \text{length of beam})$$

when appropriate homogeneous end conditions are prescribed. Show that stationary values of the ratio are the squares of the natural frequencies.

### Exercise 48.11

A boatman wishes to steer his boat so as to minimize the transit time required to cross a river of width  $l$ . The path of the boat is given parametrically by

$$x = X(t), \quad y = Y(t),$$

for  $0 \leq t \leq T$ . The river has no cross currents, so the current velocity is directed downstream in the  $y$ -direction.  $v_0$  is the constant boat speed relative to the surrounding water, and  $w = w(x, y, t)$  denotes the downstream river current at point  $(x, y)$  at time  $t$ . Then,

$$\dot{X}(t) = v_0 \cos \alpha(t), \quad \dot{Y}(t) = v_0 \sin \alpha(t) + w,$$

where  $\alpha(t)$  is the steering angle of the boat at time  $t$ . Find the steering control function  $\alpha(t)$  and the final time  $T$  that will transfer the boat from the initial state  $(X(0), Y(0)) = (0, 0)$  to the final state at  $X(t) = l$  in such a way as to minimize  $T$ .

### Exercise 48.12

Two particles of equal mass  $m$  are connected by an inextensible string which passes through a hole in a smooth horizontal table. The first particle is on the table moving with angular velocity  $\omega = \sqrt{g/\alpha}$  in a circular path, of radius  $\alpha$ , around the hole. The second particle is suspended vertically and is in equilibrium. At time  $t = 0$ , the suspended mass is pulled downward a short distance and released while the first mass continues to rotate.

1. If  $x$  represents the distance of the second mass below its equilibrium at time  $t$  and  $\theta$  represents the angular position of the first particle at time  $t$ , show that the Lagrangian is given by

$$L = m \left( \dot{x}^2 + \frac{1}{2}(\alpha - x)^2 \dot{\theta}^2 + gx \right)$$

and obtain the equations of motion.

2. In the case where the displacement of the suspended mass from equilibrium is small, show that the suspended mass performs small vertical oscillations and find the period of these oscillations.

### Exercise 48.13

A rocket is propelled vertically upward so as to reach a prescribed height  $h$  in minimum time while using a given fixed quantity of fuel. The vertical distance  $x(t)$  above the surface satisfies,

$$m\ddot{x} = -mg + mU(t), \quad x(0) = 0, \quad \dot{x}(0) = 0,$$

where  $U(t)$  is the acceleration provided by engine thrust. We impose the terminal constraint  $x(T) = h$ , and we wish to find the particular thrust function  $U(t)$  which will minimize  $T$  assuming that the total thrust of the rocket engine over the entire thrust time is limited by the condition,

$$\int_0^T U^2(t) dt = k^2.$$

Here  $k$  is a given positive constant which measures the total amount of fuel available.



**Exercise 48.14**

A space vehicle moves along a straight path in free space.  $x(t)$  is the distance to its docking pad, and  $a, b$  are its position and speed at time  $t = 0$ . The equation of motion is

$$\ddot{x} = M \sin V, \quad x(0) = a, \quad \dot{x}(0) = b,$$

where the control function  $V(t)$  is related to the rocket acceleration  $U(t)$  by  $U = M \sin V$ ,  $M = \text{const.}$  We wish to dock the vehicle in minimum time; that is, we seek a thrust function  $U(t)$  which will minimize the final time  $T$  while bringing the vehicle to rest at the origin with  $x(T) = 0$ ,  $\dot{x}(T) = 0$ . Find  $U(t)$ , and in the  $(x, \dot{x})$ -plane plot the corresponding trajectory which transfers the state of the system from  $(a, b)$  to  $(0, 0)$ . Account for all values of  $a$  and  $b$ .

**Exercise 48.15**

Find a minimum for the functional  $I(y) = \int_0^m \sqrt{y+h} \sqrt{1+(y')^2} dx$  in which  $h > 0$ ,  $y(0) = 0$ ,  $y(m) = M > -h$ . Discuss the nature of the minimum, (i.e., weak, strong, ...).

**Exercise 48.16**

Show that for the functional  $\int n(x, y) \sqrt{1+(y')^2} dx$ , where  $n(x, y) \geq 0$  in some domain  $D$ , the Weierstrass  $E$  function  $E(x, y, q, y')$  is non-negative for arbitrary finite  $p$  and  $y'$  at any point of  $D$ . What is the implication of this for Fermat's Principle?

**Exercise 48.17**

Consider the integral  $\int \frac{1+y^2}{(y')^2} dx$  between fixed limits. Find the extremals, (hyperbolic sines), and discuss the Jacobi, Legendre, and Weierstrass conditions and their implications regarding weak and strong extrema. Also consider the value of the integral on any extremal compared with its value on the illustrated strong variation. Comment!

$P_i Q_i$  are vertical segments, and the lines  $Q_i P_{i+1}$  are tangent to the extremal at  $P_{i+1}$ .

**Exercise 48.18**

Consider  $I = \int_{x_0}^{x_1} y'(1+x^2 y') dx$ ,  $y(x_0) = y_0$ ,  $y(x_1) = y_1$ . Can you find continuous curves which will minimize  $I$  if

- (i)  $x_0 = -1, \quad y_0 = 1, \quad x_1 = 2, \quad y_1 = 4,$
- (ii)  $x_0 = 1, \quad y_0 = 3, \quad x_1 = 2, \quad y_1 = 5,$
- (iii)  $x_0 = -1, \quad y_0 = 1, \quad x_1 = 2, \quad y_1 = 1.$

**Exercise 48.19**

Starting from

$$\iint_D (Q_x - P_y) \, dx \, dy = \int_{\Gamma} (P \, dx + Q \, dy)$$

prove that

- (a)  $\iint_D \phi \psi_{xx} \, dx \, dy = \iint_D \psi \phi_{xx} \, dx \, dy + \int_{\Gamma} (\phi \psi_x - \psi \phi_x) \, dy,$
- (b)  $\iint_D \phi \psi_{yy} \, dx \, dy = \iint_D \psi \phi_{yy} \, dx \, dy - \int_{\Gamma} (\phi \psi_y - \psi \phi_y) \, dx,$
- (c)  $\iint_D \phi \psi_{xy} \, dx \, dy = \iint_D \psi \phi_{xy} \, dx \, dy - \frac{1}{2} \int_{\Gamma} (\phi \psi_x - \psi \phi_x) \, dx + \frac{1}{2} \int_{\Gamma} (\phi \psi_y - \psi \phi_y) \, dy.$

Then, consider

$$I(u) = \int_{t_0}^{t_1} \iint_D (-(u_{xx} + u_{yy})^2 + 2(1 - \mu)(u_{xx}u_{yy} - u_{xy}^2)) \, dx \, dy \, dt.$$

Show that

$$\delta I = \int_{t_0}^{t_1} \iint_D (-\nabla^4 u) \delta u \, dx \, dy \, dt + \int_{t_0}^{t_1} \int_{\Gamma} \left( P(u) \delta u + M(u) \frac{\partial(\delta u)}{\partial n} \right) \, ds \, dt,$$

where  $P$  and  $M$  are the expressions we derived in class for the problem of the vibrating plate.**Exercise 48.20**

For the following functionals use the Rayleigh-Ritz method to find an approximate solution of the problem of minimizing the functionals and compare your answers with the exact solutions.

•

$$\int_0^1 ((y')^2 - y^2 - 2xy) \, dx, \quad y(0) = 0 = y(1).$$

For this problem take an approximate solution of the form

$$y = x(1 - x) (a_0 + a_1x + \cdots + a_nx^n),$$

and carry out the solutions for  $n = 0$  and  $n = 1$ .

•

$$\int_0^2 ((y')^2 + y^2 + 2xy) \, dx, \quad y(0) = 0 = y(2).$$

•

$$\int_1^2 \left( x(y')^2 - \frac{x^2 - 1}{x} y^2 - 2x^2 y \right) \, dx, \quad y(1) = 0 = y(2)$$

### Exercise 48.21

Let  $K(x)$  belong to  $L_1(-\infty, \infty)$  and define the operator  $T$  on  $L_2(-\infty, \infty)$  by

$$Tf(x) = \int_{-\infty}^{\infty} K(x-y)f(y) \, dy.$$

1. Show that the spectrum of  $T$  consists of the range of the Fourier transform  $\hat{K}$  of  $K$ , (that is, the set of all values  $\hat{K}(y)$  with  $-\infty < y < \infty$ ), plus 0 if this is not already in the range. (Note: From the assumption on  $K$  it follows that  $\hat{K}$  is continuous and approaches zero at  $\pm\infty$ .)
2. For  $\lambda$  in the spectrum of  $T$ , show that  $\lambda$  is an eigenvalue if and only if  $\hat{K}$  takes on the value  $\lambda$  on at least some interval of positive length and that every other  $\lambda$  in the spectrum belongs to the continuous spectrum.
3. Find an explicit representation for  $(T - \lambda I)^{-1}f$  for  $\lambda$  not in the spectrum, and verify directly that this result agrees with that given by the Neumann series if  $\lambda$  is large enough.

### Exercise 48.22

Let  $U$  be the space of twice continuously differentiable functions  $f$  on  $[-1, 1]$  satisfying  $f(-1) = f(1) = 0$ , and  $W = C[-1, 1]$ . Let  $L : U \mapsto W$  be the operator  $\frac{d^2}{dx^2}$ . Call  $\lambda$  in the spectrum of  $L$  if the following does not occur: There is a bounded linear transformation  $T : W \mapsto U$  such that  $(L - \lambda I)Tf = f$  for all  $f \in W$  and  $T(L - \lambda I)f = f$  for all  $f \in U$ . Determine the spectrum of  $L$ .

**Exercise 48.23**

Solve the integral equations

$$1. \phi(x) = x + \lambda \int_0^1 (x^2y - y^2) \phi(y) dy$$

$$2. \phi(x) = x + \lambda \int_0^x K(x, y)\phi(y) dy$$

where

$$K(x, y) = \begin{cases} \sin(xy) & \text{for } x \geq 1 \text{ and } y \leq 1, \\ 0 & \text{otherwise} \end{cases}$$

In both cases state for which values of  $\lambda$  the solution obtained is valid.**Exercise 48.24**

- Suppose that  $K = L_1L_2$ , where  $L_1L_2 - L_2L_1 = I$ . Show that if  $x$  is an eigenvector of  $K$  corresponding to the eigenvalue  $\lambda$ , then  $L_1x$  is an eigenvector of  $K$  corresponding to the eigenvalue  $\lambda - 1$ , and  $L_2x$  is an eigenvector corresponding to the eigenvalue  $\lambda + 1$ .
- Find the eigenvalues and eigenfunctions of the operator  $K \equiv -\frac{d}{dt} + \frac{t^2}{4}$  in the space of functions  $u \in L_2(-\infty, \infty)$ . (Hint:  $L_1 = \frac{t}{2} + \frac{d}{dt}$ ,  $L_2 = \frac{t}{2} - \frac{d}{dt}$ .  $e^{-t^2/4}$  is the eigenfunction corresponding to the eigenvalue  $1/2$ .)

**Exercise 48.25**Prove that if the value of  $\lambda = \lambda_1$  is in the residual spectrum of  $T$ , then  $\overline{\lambda_1}$  is in the discrete spectrum of  $T^*$ .**Exercise 48.26**

Solve

1.

$$u''(t) + \int_0^1 \sin(k(s-t))u(s) ds = f(t), \quad u(0) = u'(0) = 0.$$

2.

$$u(x) = \lambda \int_0^\pi K(x, s)u(s) ds$$

where

$$K(x, s) = \frac{1}{2} \log \left| \frac{\sin \left( \frac{x+s}{2} \right)}{\sin \left( \frac{x-s}{2} \right)} \right| = \sum_{n=1}^{\infty} \frac{\sin nx \sin ns}{n}$$

3.

$$\phi(s) = \lambda \int_0^{2\pi} \frac{1}{2\pi} \frac{1-h^2}{1-2h \cos(s-t) + h^2} \phi(t) dt, \quad |h| < 1$$

4.

$$\phi(x) = \lambda \int_{-\pi}^{\pi} \cos^n(x-\xi) \phi(\xi) d\xi$$

**Exercise 48.27**Let  $K(x, s) = 2\pi^2 - 6\pi|x-s| + 3(x-s)^2$ .

1. Find the eigenvalues and eigenfunctions of

$$\phi(x) = \lambda \int_0^{2\pi} K(x, s)\phi(s) ds.$$

(Hint: Try to find an expansion of the form

$$K(x, s) = \sum_{n=-\infty}^{\infty} c_n e^{in(x-s)} .)$$

2. Do the eigenfunctions form a complete set? If not, show that a complete set may be obtained by adding a suitable set of solutions of

$$\int_0^{2\pi} K(x, s)\phi(s) ds = 0.$$

3. Find the resolvent kernel  $\Gamma(x, s, \lambda)$ .

**Exercise 48.28**

Let  $K(x, s)$  be a bounded self-adjoint kernel on the finite interval  $(a, b)$ , and let  $T$  be the integral operator on  $L_2(a, b)$  with kernel  $K(x, s)$ . For a polynomial  $p(t) = a_0 + a_1t + \dots + a_nt^n$  we define the operator  $p(T) = a_0I + a_1T + \dots + a_nT^n$ . Prove that the eigenvalues of  $p(T)$  are exactly the numbers  $p(\lambda)$  with  $\lambda$  an eigenvalue of  $T$ .

**Exercise 48.29**

Show that if  $f(x)$  is continuous, the solution of

$$\phi(x) = f(x) + \lambda \int_0^\infty \cos(2xs)\phi(s) ds$$

is

$$\phi(x) = \frac{f(x) + \lambda \int_0^\infty f(s) \cos(2xs) ds}{1 - \pi\lambda^2/4}.$$

**Exercise 48.30**

Consider

$$Lu = 0 \text{ in } D, \quad u = f \text{ on } C,$$

where

$$Lu \equiv u_{xx} + u_{yy} + au_x + bu_y + cu.$$

Here  $a, b$  and  $c$  are continuous functions of  $(x, y)$  on  $D + C$ . Show that the adjoint  $L^*$  is given by

$$L^*v = v_{xx} + v_{yy} - av_x - bv_y + (c - a_x - b_y)v$$

and that

$$\int_D (vLu - uL^*v) = \int_C H(u, v), \tag{48.1}$$

where

$$\begin{aligned} H(u, v) &\equiv (vu_x - uv_x + auv) dy - (vu_y - uv_y + buv) dx \\ &= \left( v \frac{\partial u}{\partial n} - u \frac{\partial v}{\partial n} + auv \frac{\partial x}{\partial n} + buv \frac{\partial y}{\partial n} \right) ds. \end{aligned}$$

Take  $v$  in (48.1) to be the harmonic Green function  $G$  given by

$$G(x, y; \xi, \eta) = \frac{1}{2\pi} \log \left( \frac{1}{\sqrt{(x - \xi)^2 + (y - \eta)^2}} \right) + \dots,$$

and show formally, (use Delta functions), that (48.1) becomes

$$-u(\xi, \eta) - \int_D u(L^* - \Delta)G dx dy = \int_C H(u, G) \quad (48.2)$$

where  $u$  satisfies  $Lu = 0$ , ( $\Delta G = \delta$  in  $D$ ,  $G = 0$  on  $C$ ). Show that (48.2) can be put into the forms

$$u + \int_D ((c - a_x - b_y)G - aG_x - bG_y)u dx dy = U \quad (48.3)$$

and

$$u + \int_D (au_x + bu_y + cu)G dx dy = U, \quad (48.4)$$

where  $U$  is the known harmonic function in  $D$  with assumes the boundary values prescribed for  $u$ . Finally, rigorously show that the integrodifferential equation (48.4) can be solved by successive approximations when the domain  $D$  is small enough.

### Exercise 48.31

Find the eigenvalues and eigenfunctions of the following kernels on the interval  $[0, 1]$ .

1.

$$K(x, s) = \min(x, s)$$

2.

$$K(x, s) = e^{\min(x, s)}$$

(Hint:  $\phi'' + \phi' + \lambda e^x \phi = 0$  can be solved in terms of Bessel functions.)

**Exercise 48.32**

Use Hilbert transforms to evaluate

$$1. \int_{-\infty}^{\infty} \frac{\sin(kx) \sin(lx)}{x^2 - z^2} dx$$

$$2. \int_{-\infty}^{\infty} \frac{\cos(px) - \cos(qx)}{x^2} dx$$

$$3. \int_{-\infty}^{\infty} \frac{-(x^2 - ab) \sin x + (a + b)x \cos x}{x(x^2 + a^2)(x^2 + b^2)} dx$$

**Exercise 48.33**

Show that

$$\int_{-\infty}^{\infty} \frac{(1 - t^2)^{1/2} \log(1 + t)}{t - x} dt = \pi \left( x \log 2 - 1 + (1 - x^2)^{1/2} \left( \frac{\pi}{2} - \arcsin(x) \right) \right).$$

**Exercise 48.34**

Let  $C$  be a simple closed contour. Let  $g(t)$  be a given function and consider

$$\frac{1}{i\pi} \int_C \frac{f(t) dt}{t - t_0} = g(t_0) \tag{48.5}$$

Note that the left side can be written as  $F^+(t_0) + F^-(t_0)$ . Define a function  $W(z)$  such that  $W(z) = F(z)$  for  $z$  inside  $C$  and  $W(z) = -F(z)$  for  $z$  outside  $C$ . Proceeding in this way, show that the solution of (48.5) is given by

$$f(t_0) = \frac{1}{i\pi} \int_C \frac{g(t) dt}{t - t_0}.$$



**Exercise 48.35**

If  $C$  is an arc with endpoints  $\alpha$  and  $\beta$ , evaluate

- (i)  $\frac{1}{i\pi} \int_C \frac{1}{(\tau - \beta)^{1-\gamma}(\tau - \alpha)^\gamma(\tau - \zeta)} d\tau$ , where  $0 < \gamma < 1$
- (ii)  $\frac{1}{i\pi} \int_C \left(\frac{\tau - \beta}{\tau - \alpha}\right)^\gamma \frac{\tau^n}{\tau - \zeta} d\tau$ , where  $0 < \gamma < 1$ , integer  $n \geq 0$ .

**Exercise 48.36**

Solve

$$\int_{-1}^1 \frac{\phi(y)}{y^2 - x^2} dy = f(x).$$

**Exercise 48.37**

Solve

$$\frac{1}{i\pi} \int_0^1 \frac{f(t)}{t - x} dt = \lambda f(x), \quad \text{where } -1 < \lambda < 1.$$

Are there any solutions for  $\lambda > 1$ ? (The operator on the left is self-adjoint. Its spectrum is  $-1 \leq \lambda \leq 1$ .)

**Exercise 48.38**

Show that the general solution of

$$\frac{\tan(x)}{\pi} \int_0^1 \frac{f(t)}{t - x} dt = f(x)$$

is

$$f(x) = \frac{k \sin(x)}{(1 - x)^{1-x/\pi} x^{x/\pi}}.$$

**Exercise 48.39**

Show that the general solution of

$$f'(x) + \lambda \int_C \frac{f(t)}{t - x} dt = 1$$

is given by

$$f(x) = \frac{1}{i\pi\lambda} + k e^{-i\pi\lambda x},$$

( $k$  is a constant). Here  $C$  is a simple closed contour,  $\lambda$  a constant and  $f(x)$  a differentiable function on  $C$ . Generalize the result to the case of an arbitrary function  $g(x)$  on the right side, where  $g(x)$  is analytic inside  $C$ .

### Exercise 48.40

Show that the solution of

$$\oint_C \left( \frac{1}{t-x} + P(t-x) \right) f(t) dt = g(x)$$

is given by

$$f(t) = -\frac{1}{\pi^2} \oint_C \frac{g(\tau)}{\tau-t} d\tau - \frac{1}{\pi^2} \int_C g(\tau) P(\tau-t) d\tau.$$

Here  $C$  is a simple closed curve, and  $P(t)$  is a given entire function of  $t$ .

### Exercise 48.41

Solve

$$\int_0^1 \frac{f(t)}{t-x} dt + \int_2^3 \frac{f(t)}{t-x} dt = x$$

where this equation is to hold for  $x$  in either  $(0, 1)$  or  $(2, 3)$ .

### Exercise 48.42

Solve

$$\int_0^x \frac{f(t)}{\sqrt{x-t}} dt + A \int_x^1 \frac{f(t)}{\sqrt{t-x}} dt = 1$$

where  $A$  is a real positive constant. Outline briefly the appropriate method of  $A$  is a function of  $x$ .

## 48.2 Hints

**Hint 48.1**

**Hint 48.2**

**Hint 48.3**

**Hint 48.4**

**Hint 48.5**

**Hint 48.6**

**Hint 48.7**

**Hint 48.8**

**Hint 48.9**

**Hint 48.10**

**Hint 48.11**

**Hint 48.12**

**Hint 48.13**

**Hint 48.14**

**Hint 48.15**

**Hint 48.16**

**Hint 48.17**

**Hint 48.18**

**Hint 48.19**

**Hint 48.20**

**Hint 48.21**

**Hint 48.22**

**Hint 48.23**

**Hint 48.24**

**Hint 48.25**

**Hint 48.26**

**Hint 48.27**

**Hint 48.28**

**Hint 48.29**

**Hint 48.30**

**Hint 48.31**

**Hint 48.32**

**Hint 48.33**

**Hint 48.34**

**Hint 48.35**

**Hint 48.36**

**Hint 48.37**

**Hint 48.38**

**Hint 48.39**

**Hint 48.40**

**Hint 48.41**

**Hint 48.42**

## 48.3 Solutions

### Solution 48.1

$C^1[0, \alpha]$  Extremals

**Admissible Extremal.** First we consider continuously differentiable extremals. Because the Lagrangian is a function of  $y'$  alone, we know that the extremals are straight lines. Thus the admissible extremal is

$$\hat{y} = \frac{\beta}{\alpha}x.$$

**Legendre Condition.**

$$\begin{aligned}\hat{F}_{y'y'} &= 12(\hat{y}')^2 - 12 \\ &= 12 \left( \left( \frac{\beta}{\alpha} \right)^2 - 1 \right) \\ &\begin{cases} < 0 & \text{for } |\beta/\alpha| < 1 \\ = 0 & \text{for } |\beta/\alpha| = 1 \\ > 0 & \text{for } |\beta/\alpha| > 1 \end{cases}\end{aligned}$$

Thus we see that  $\frac{\beta}{\alpha}x$  may be a minimum for  $|\beta/\alpha| \geq 1$  and may be a maximum for  $|\beta/\alpha| \leq 1$ .

**Jacobi Condition.** Jacobi's accessory equation for this problem is

$$\begin{aligned}(\hat{F}_{y'y'}h')' &= 0 \\ \left( 12 \left( \left( \frac{\beta}{\alpha} \right)^2 - 1 \right) h' \right)' &= 0 \\ h'' &= 0\end{aligned}$$

The problem  $h'' = 0$ ,  $h(0) = 0$ ,  $h(c) = 0$  has only the trivial solution for  $c > 0$ . Thus we see that there are no conjugate points and the admissible extremal satisfies the strengthened Legendre condition.

**A Weak Minimum.** For  $|\beta/\alpha| > 1$  the admissible extremal  $\frac{\beta}{\alpha}x$  is a solution of the Euler equation, and satisfies the strengthened Jacobi and Legendre conditions. Thus it is a weak minima. (For  $|\beta/\alpha| < 1$  it is a weak maxima for the same reasons.)

**Weierstrass Excess Function.** The Weierstrass excess function is

$$\begin{aligned}
 E(x, \hat{y}, \hat{y}', w) &= F(w) - F(\hat{y}') - (w - \hat{y}')F_{,y'}(\hat{y}') \\
 &= w^4 - 6w^2 - (\hat{y}')^4 + 6(\hat{y}')^2 - (w - \hat{y}')(4(\hat{y}')^3 - 12\hat{y}') \\
 &= w^4 - 6w^2 - \left(\frac{\beta}{\alpha}\right)^4 + 6\left(\frac{\beta}{\alpha}\right)^2 - (w - \frac{\beta}{\alpha})\left(4\left(\frac{\beta}{\alpha}\right)^3 - 12\frac{\beta}{\alpha}\right) \\
 &= w^4 - 6w^2 - w\left(4\frac{\beta}{\alpha}\left(\frac{\beta}{\alpha}\right)^2 - 3\right) + 3\left(\frac{\beta}{\alpha}\right)^4 - 6\left(\frac{\beta}{\alpha}\right)^2
 \end{aligned}$$

We can find the stationary points of the excess function by examining its derivative. (Let  $\lambda = \beta/\alpha$ .)

$$\begin{aligned}
 E'(w) &= 4w^3 - 12w + 4\lambda((\lambda)^2 - 3) = 0 \\
 w_1 = \lambda, \quad w_2 &= \frac{1}{2}\left(-\lambda - \sqrt{4 - \lambda^2}\right) \quad w_3 = \frac{1}{2}\left(-\lambda + \sqrt{4 - \lambda^2}\right)
 \end{aligned}$$

The excess function evaluated at these points is

$$\begin{aligned}
 E(w_1) &= 0, \\
 E(w_2) &= \frac{3}{2}\left(3\lambda^4 - 6\lambda^2 - 6 - \sqrt{3}\lambda(4 - \lambda^2)^{3/2}\right), \\
 E(w_3) &= \frac{3}{2}\left(3\lambda^4 - 6\lambda^2 - 6 + \sqrt{3}\lambda(4 - \lambda^2)^{3/2}\right).
 \end{aligned}$$

$E(w_2)$  is negative for  $-1 < \lambda < \sqrt{3}$  and  $E(w_3)$  is negative for  $-\sqrt{3} < \lambda < 1$ . This implies that the weak minimum  $\hat{y} = \beta x/\alpha$  is not a strong local minimum for  $|\lambda| < \sqrt{3}$ . Since  $E(w_1) = 0$ , we cannot use the Weierstrass excess function to determine if  $\hat{y} = \beta x/\alpha$  is a strong local minima for  $|\beta/\alpha| > \sqrt{3}$ .



**Erdmann's Corner Conditions.** Erdmann's corner conditions require that

$$\hat{F}_{,y'} = 4(\hat{y}')^3 - 12\hat{y}'$$

and

$$\hat{F} - \hat{y}'\hat{F}_{,y'} = (\hat{y}')^4 - 6(\hat{y}')^2 - \hat{y}'(4(\hat{y}')^3 - 12\hat{y}')$$

are continuous at corners. Thus the quantities

$$(\hat{y}')^3 - 3\hat{y}' \quad \text{and} \quad (\hat{y}')^4 - 2(\hat{y}')^2$$

are continuous. Denoting  $p = \hat{y}'_-$  and  $q = \hat{y}'_+$ , the first condition has the solutions

$$p = q, \quad p = \frac{1}{2} \left( -q \pm \sqrt{3}\sqrt{4 - q^2} \right).$$

The second condition has the solutions,

$$p = \pm q, \quad p = \pm\sqrt{2 - q^2}$$

Combining these, we have

$$p = q, \quad p = \sqrt{3}, q = -\sqrt{3}, \quad p = -\sqrt{3}, q = \sqrt{3}.$$

Thus we see that there can be a corner only when  $\hat{y}'_- = \pm\sqrt{3}$  and  $\hat{y}'_+ = \mp\sqrt{3}$ .

**Case 1,**  $|\beta| = \sqrt{3}|\alpha|$ . Notice the the Lagrangian is minimized point-wise if  $y' = \pm\sqrt{3}$ . For this case the unique, strong global minimum is

$$\hat{y} = \sqrt{3} \operatorname{sign}(\beta)x.$$

**Case 2,**  $|\beta| < \sqrt{3}|\alpha|$ . For this case there are an infinite number of strong minima. Any piecewise linear curve satisfying  $y'_-(x) = \pm\sqrt{3}$  and  $y'_+(x) = \pm\sqrt{3}$  and  $y(0) = 0$ ,  $y(\alpha) = \beta$  is a strong minima.

**Case 3,**  $|\beta| > \sqrt{3}|\alpha|$ . First note that the extremal cannot have corners. Thus the unique extremal is  $\hat{y} = \frac{\beta}{\alpha}x$ . We know that this extremal is a weak local minima.

## Solution 48.2

1.

$$\int_{x_0}^{x_1} (a(y')^2 + byy' + cy^2) dx, \quad y(x_0) = y_0, \quad y(x_1) = y_1, \quad a \neq 0$$

**Erdmann's First Corner Condition.**  $\hat{F}_{y'} = 2a\hat{y}' + b\hat{y}$  must be continuous at a corner. This implies that  $\hat{y}$  must be continuous, i.e., there are no corners.

The functional cannot have broken extremals.

2.

$$\int_{x_0}^{x_1} (y')^3 dx, \quad y(x_0) = y_0, \quad y(x_1) = y_1$$

**Erdmann's First Corner Condition.**  $\hat{F}_{y'} = 3(y')^2$  must be continuous at a corner. This implies that  $\hat{y}'_- = \hat{y}'_+$ .

**Erdmann's Second Corner Condition.**  $\hat{F} - \hat{y}'\hat{F}_{y'} = (\hat{y}')^3 - \hat{y}'3(\hat{y}')^2 = -2(\hat{y}')^3$  must be continuous at a corner. This implies that  $\hat{y}$  is continuous at a corner, i.e. there are no corners.

The functional cannot have broken extremals.

## Solution 48.3

1.

$$\int_0^1 ((y'')^2 - 2xy) dx, \quad y(0) = y'(0) = 0, \quad y(1) = \frac{1}{120}$$

**Euler's Differential Equation.** We will consider  $C^4$  extremals which satisfy Euler's DE,

$$(\hat{F}_{,y''})'' - (\hat{F}_{,y'})' + \hat{F}_{,y} = 0.$$

For the given Lagrangian, this is,

$$(2\hat{y}'')'' - 2x = 0.$$

**Natural Boundary Condition.** The first variation of the performance index is

$$\delta J = \int_0^1 (\hat{F}_{,y}\delta y + \hat{F}_{,y'}\delta y' + \hat{F}_{,y''}\delta y'') dx.$$

From the given boundary conditions we have  $\delta y(0) = \delta y'(0) = \delta y(1) = 0$ . Using Euler's DE, we have,

$$\delta J = \int_0^1 ((\hat{F}_{,y'} - (\hat{F}_{,y''})')\delta y + \hat{F}_{,y'}\delta y' + \hat{F}_{,y''}\delta y'') dx.$$

Now we apply integration by parts.

$$\begin{aligned} \delta J &= [(\hat{F}_{,y'} - (\hat{F}_{,y''})')\delta y]_0^1 + \int_0^1 (-(\hat{F}_{,y'} - (\hat{F}_{,y''})')\delta y' + \hat{F}_{,y'}\delta y' + \hat{F}_{,y''}\delta y'') dx \\ &= \int_0^1 ((\hat{F}_{,y''})'\delta y' + \hat{F}_{,y''}\delta y'') dx \\ &= [\hat{F}_{,y''}\delta y']_0^1 \\ &= \hat{F}_{,y''}(1)\delta y'(1) \end{aligned}$$

In order that the first variation vanish, we need the natural boundary condition  $\hat{F}_{,y''}(1) = 0$ . For the given Lagrangian, this condition is

$$\hat{y}''(1) = 0.$$

**The Extremal BVP.** The extremal boundary value problem is

$$y'''' = x, \quad y(0) = y'(0) = y''(1) = 0, \quad y(1) = \frac{1}{120}.$$

The general solution of the differential equation is

$$y = c_0 + c_1x + c_2x^2 + c_3x^3 + \frac{1}{120}x^5.$$

Applying the boundary conditions, we see that the unique admissible extremal is

$$\hat{y} = \frac{x^2}{120}(x^3 - 5x + 5).$$

This may be a weak extremum for the problem.

**Legendre's Condition.** Since

$$\hat{F}_{,y''y''} = 2 > 0,$$

the strengthened Legendre condition is satisfied.

**Jacobi's Condition.** The second variation for  $F(x, y, y'')$  is

$$\frac{d^2 J}{d\epsilon^2} \Big|_{\epsilon=0} = \int_a^b \left( \hat{F}_{,y''y''} (h'')^2 + 2\hat{F}_{,yy''} h h'' + \hat{F}_{,yy} h^2 \right) dx$$

Jacobi's accessory equation is,

$$\begin{aligned} (2\hat{F}_{,y''y''} h'' + 2\hat{F}_{,yy''} h)'' + 2\hat{F}_{,yy''} h'' + 2\hat{F}_{,yy} h &= 0, \\ (h'')'' &= 0 \end{aligned}$$

Since the boundary value problem,

$$h'''' = 0, \quad h(0) = h'(0) = h(c) = h''(c) = 0,$$

has only the trivial solution for all  $c > 0$  the strengthened Jacobi condition is satisfied.

**A Weak Minimum.** Since the admissible extremal,

$$\hat{y} = \frac{x^2}{120}(x^3 - 5x + 5),$$

satisfies the strengthened Legendre and Jacobi conditions, we conclude that it is a weak minimum.

2.

$$\int_0^1 \left( \frac{1}{2}(y')^2 + yy' + y' + y \right) dx$$

**Boundary Conditions.** Since no boundary conditions are specified, we have the Euler boundary conditions,

$$\hat{F}_{,y'}(0) = 0, \quad \hat{F}_{,y'}(1) = 0.$$

The derivatives of the integrand are,

$$F_{,y} = y' + 1, \quad F_{,y'} = y' + y + 1.$$

The Euler boundary conditions are then

$$\hat{y}'(0) + \hat{y}(0) + 1 = 0, \quad \hat{y}'(1) + \hat{y}(1) + 1 = 0.$$

**Erdmann's Corner Conditions.** Erdmann's first corner condition specifies that

$$\hat{F}_{,y'}(x) = \hat{y}'(x) + \hat{y}(x) + 1$$

must be continuous at a corner. This implies that  $\hat{y}'(x)$  is continuous at corners, which means that there are no corners.

**Euler's Differential Equation.** Euler's DE is

$$(F_{,y'})' = F_{,y},$$

$$y'' + y' = y' + 1,$$

$$y'' = 1.$$

The general solution is

$$y = c_0 + c_1x + \frac{1}{2}x^2.$$

The boundary conditions give us the constraints,

$$\begin{aligned}c_0 + c_1 + 1 &= 0, \\c_0 + 2c_1 + \frac{5}{2} &= 0.\end{aligned}$$

The extremal that satisfies the Euler DE and the Euler BC's is

$$\hat{y} = \frac{1}{2}(x^2 - 3x + 1).$$

**Legendre's Condition.** Since the strengthened Legendre condition is satisfied,

$$\hat{F}_{,y'y'}(x) = 1 > 0,$$

we conclude that the extremal is a weak local minimum of the problem.

**Jacobi's Condition.** Jacobi's accessory equation for this problem is,

$$\begin{aligned}\left(\hat{F}_{,y'y'}h'\right)' - \left(\hat{F}_{,yy} - \left(\hat{F}_{,yy'}\right)'\right)h &= 0, & h(0) = h(c) = 0, \\(h')' - (-1)'h &= 0, & h(0) = h(c) = 0, \\h'' &= 0, & h(0) = h(c) = 0,\end{aligned}$$

Since this has only trivial solutions for  $c > 0$  we conclude that there are no conjugate points. The extremal satisfies the strengthened Jacobi condition.

The only admissible extremal,

$$\hat{y} = \frac{1}{2}(x^2 - 3x + 1),$$

satisfies the strengthened Legendre and Jacobi conditions and is thus a weak extremum.

3.

$$\int_a^b (y^2 + 2xyy') \, dx, \quad y(a) = A, \quad y(b) = B$$

**Euler's Differential Equation.** Euler's differential equation,

$$(F_{,y'})' = F_y,$$

$$(2xy)' = 2y + 2xy',$$

$$2y + 2xy' = 2y + 2xy',$$

is trivial. Every  $C^1$  function satisfies the Euler DE.

**Erdmann's Corner Conditions.** The expressions,

$$\hat{F}_{,y'} = 2xy, \quad \hat{F} - \hat{y}' \hat{F}_{,y'} = \hat{y}^2 + 2x\hat{y}\hat{y}' - \hat{y}'(2x\hat{h}) = \hat{y}^2$$

are continuous at a corner. The conditions are trivial and do not restrict corners in the extremal.

**Extremal.** Any piecewise smooth function that satisfies the boundary conditions  $\hat{y}(a) = A$ ,  $\hat{y}(b) = B$  is an admissible extremal.

**An Exact Derivative.** At this point we note that

$$\begin{aligned} \int_a^b (y^2 + 2xyy') \, dx &= \int_a^b \frac{d}{dx}(xy^2) \, dx \\ &= [xy^2]_a^b \\ &= bB^2 - aA^2. \end{aligned}$$

The integral has the same value for all piecewise smooth functions  $y$  that satisfy the boundary conditions.

Since the integral has the same value for all piecewise smooth functions that satisfy the boundary conditions, all such functions are weak extrema.

4.

$$\int_0^1 (xy + y^2 - 2y^2y') dx, \quad y(0) = 1, \quad y(1) = 2$$

**Erdmann's Corner Conditions.** Erdmann's first corner condition requires  $\hat{F}_{,y'} = -2\hat{y}^2$  to be continuous, which is trivial. Erdmann's second corner condition requires that

$$\hat{F} - \hat{y}' \hat{F}_{,y'} = x\hat{y} + \hat{y}^2 - 2\hat{y}^2\hat{y}' - \hat{y}'(-2\hat{y}^2) = x\hat{y} + \hat{y}^2$$

is continuous. This condition is also trivial. Thus the extremal may have corners at any point.

**Euler's Differential Equation.** Euler's DE is

$$(F_{,y'})' = F_{,y},$$

$$(-2y^2)' = x + 2y - 4yy'$$

$$y = -\frac{x}{2}$$

**Extremal.** There is no piecewise smooth function that satisfies Euler's differential equation on its smooth segments and satisfies the boundary conditions  $y(0) = 1$ ,  $y(1) = 2$ . We conclude that there is no weak extremum.

### Solution 48.4

1. We require that the first variation vanishes

$$\iint_D (F_u h + F_{u_x} h_x + F_{u_y} h_y) dx dy = 0.$$

We rewrite the integrand as

$$\iint_D (F_u h + (F_{u_x} h)_x + (F_{u_y} h)_y - (F_{u_x})_x h - (F_{u_y})_y h) dx dy = 0,$$



$$\iint_D (F_u - (F_{u_x})_x - (F_{u_y})_y) h \, dx \, dy + \iint_D ((F_{u_x} h)_x + (F_{u_y} h)_y) \, dx \, dy = 0.$$

Using the Divergence theorem, we obtain,

$$\iint_D (F_u - (F_{u_x})_x - (F_{u_y})_y) h \, dx \, dy + \int_{\Gamma} (F_{u_x}, F_{u_y}) \cdot \mathbf{n} h \, ds = 0.$$

In order that the line integral vanish we have the natural boundary condition,

$$\boxed{(F_{u_x}, F_{u_y}) \cdot \mathbf{n} = 0 \quad \text{for } (x, y) \in \Gamma.}$$

We can also write this as

$$F_{u_x} \frac{dy}{ds} - F_{u_y} \frac{dx}{ds} = 0 \quad \text{for } (x, y) \in \Gamma.$$

The Euler differential equation for this problem is

$$F_u - (F_{u_x})_x - (F_{u_y})_y = 0.$$

2. We consider the natural boundary conditions for

$$\iint_D F(x, y, u, u_x, u_y) \, dx \, dy + \int_{\Gamma} G(x, y, u) \, ds.$$

We require that the first variation vanishes.

$$\iint_D (F_u - (F_{u_x})_x - (F_{u_y})_y) h \, dx \, dy + \int_{\Gamma} (F_{u_x}, F_{u_y}) \cdot \mathbf{n} h \, ds + \int_{\Gamma} G_u h \, ds = 0,$$

$$\iint_D (F_u - (F_{u_x})_x - (F_{u_y})_y) h \, dx \, dy + \int_{\Gamma} ((F_{u_x}, F_{u_y}) \cdot \mathbf{n} + G_u) h \, ds = 0,$$

In order that the line integral vanishes, we have the natural boundary conditions,

$$(F_{u_x}, F_{u_y}) \cdot \mathbf{n} + G_u = 0 \quad \text{for } (x, y) \in \Gamma.$$

For the given integrand this is,

$$(2pu_x, 2pu_y) \cdot \mathbf{n} + 2\sigma u = 0 \quad \text{for } (x, y) \in \Gamma,$$

$$\boxed{p\nabla \mathbf{u} \cdot \mathbf{n} + \sigma u = 0 \quad \text{for } (x, y) \in \Gamma.}$$

We can also denote this as

$$p \frac{\partial u}{\partial n} + \sigma u = 0 \quad \text{for } (x, y) \in \Gamma.$$

### Solution 48.5

First we vary  $\phi$ .

$$\psi(\epsilon) = \iint_R \left( \int_0^{h(x,t)} \left( \phi_t + \epsilon \eta_t + \frac{1}{2}(\phi_x + \epsilon \eta_x)^2 + \frac{1}{2}(\phi_y + \epsilon \eta_y)^2 + gy \right) dy \right) dx dt$$

$$\psi'(0) = \iint_R \left( \int_0^{h(x,t)} (\eta_t + \phi_x \eta_x + \phi_y \eta_y) dy \right) dx dt = 0$$

$$\begin{aligned} \psi'(0) = \iint_R \left( \frac{\partial}{\partial t} \int_0^{h(x,t)} \eta dy - [\eta h_t]_{y=h(x,t)} + \frac{\partial}{\partial x} \int_0^{h(x,t)} \phi_x \eta dy - [\phi_x \eta h_x]_{y=h(x,t)} - \int_0^{h(x,t)} \phi_{xx} \eta dy \right. \\ \left. + [\phi_y \eta]_0^{h(x,t)} - \int_0^{h(x,t)} \phi_{yy} \eta dy \right) dx dt = 0 \end{aligned}$$

Since  $\eta$  vanishes on the boundary of  $R$ , we have

$$\psi'(0) = \iint_R \left( - [(h_t \phi_x h_x - \phi_y) \eta]_{y=h(x,t)} - [\phi_y \eta]_{y=0} - \int_0^{h(x,t)} (\phi_{xx} + \phi_{yy}) \eta dy \right) dx dt = 0.$$

From the variations  $\eta$  which vanish on  $y = 0, h(x, t)$  we have

$$\boxed{\nabla^2 \phi = 0.}$$

This leaves us with

$$\psi'(0) = \iint_R \left( - [(h_t \phi_x h_x - \phi_y) \eta]_{y=h(x,t)} - [\phi_y \eta]_{y=0} \right) dx dt = 0.$$

By considering variations  $\eta$  which vanish on  $y = 0$  we obtain,

$$\boxed{h_t \phi_x h_x - \phi_y = 0 \quad \text{on } y = h(x, t).}$$

Finally we have

$$\boxed{\phi_y = 0 \quad \text{on } y = 0.}$$

Next we vary  $h(x, t)$ .

$$\begin{aligned} \psi(\epsilon) &= \iint_R \int_0^{h(x,t)+\epsilon\eta(x,t)} \left( \phi_t + \frac{1}{2}\phi_x^2 + \frac{1}{2}\phi_y^2 + gy \right) dx dt \\ \psi'(\epsilon) &= \iint_R \left[ \phi_t + \frac{1}{2}\phi_x^2 + \frac{1}{2}\phi_y^2 + gy \right]_{y=h(x,t)} \eta dx dt = 0 \end{aligned}$$

This gives us the boundary condition,

$$\boxed{\phi_t + \frac{1}{2}\phi_x^2 + \frac{1}{2}\phi_y^2 + gy = 0 \quad \text{on } y = h(x, t).}$$

### Solution 48.6

The parts of the extremizing curve which lie outside the boundary of the region  $R$  must be extremals, (i.e., solutions of Euler's equation) since if we restrict our variations to admissible curves outside of  $R$  and its boundary, we immediately obtain Euler's equation. Therefore an extremum can be reached only on curves consisting of arcs of extremals and parts of the boundary of region  $R$ .

Thus, our problem is to find the points of transition of the extremal to the boundary of  $R$ . Let the boundary of  $R$  be given by  $\phi(x)$ . Consider an extremum that starts at the point  $(a, A)$ , follows an extremal to the point  $(x_0, \phi(x_0))$ , follows the  $\partial R$  to  $(x_1, \phi(x_1))$  then follows an extremal to the point  $(b, B)$ . We seek *transversality conditions* for the points  $x_0$  and  $x_1$ . We will extremize the expression,

$$I(y) = \int_a^{x_0} F(x, y, y') dx + \int_{x_0}^{x_1} F(x, \phi, \phi') dx + \int_{x_1}^b F(x, y, y') dx.$$

Let  $c$  be any point between  $x_0$  and  $x_1$ . Then extremizing  $I(y)$  is equivalent to extremizing the two functionals,

$$I_1(y) = \int_a^{x_0} F(x, y, y') dx + \int_{x_0}^c F(x, \phi, \phi') dx,$$

$$I_2(y) = \int_c^{x_1} F(x, \phi, \phi') dx + \int_{x_1}^b F(x, y, y') dx,$$

$$\delta I = 0 \quad \rightarrow \quad \delta I_1 = \delta I_2 = 0.$$

We will extremize  $I_1(y)$  and then use the derived transversality condition on all points where the extremals meet  $\partial R$ . The general variation of  $I_1$  is,

$$\begin{aligned} \delta I_1(y) = & \int_a^{x_0} \left( F_y - \frac{d}{dx} F_{y'} \right) dx + [F_{y'} \delta y]_a^{x_0} + [(F - y' F_{y'}) \delta x]_a^{x_0} \\ & + [F_{\phi'} \delta \phi(x)]_{x_0}^c + [(F - \phi' F_{\phi'}) \delta x]_{x_0}^c = 0 \end{aligned}$$

Note that  $\delta x = \delta y = 0$  at  $x = a, c$ . That is,  $x = x_0$  is the only point that varies. Also note that  $\delta \phi(x)$  is not independent of  $\delta x$ .  $\delta \phi(x) \rightarrow \phi'(x) \delta x$ . At the point  $x_0$  we have  $\delta y \rightarrow \phi'(x) \delta x$ .

$$\begin{aligned} \delta I_1(y) = & \int_a^{x_0} \left( F_y - \frac{d}{dx} F_{y'} \right) dx + (F_{y'} \phi' \delta x) \Big|_{x_0} + ((F - y' F_{y'}) \delta x) \Big|_{x_0} \\ & - (F_{\phi'} \phi' \delta x) \Big|_{x_0} - ((F - \phi' F_{\phi'}) \delta x) \Big|_{x_0} = 0 \end{aligned}$$

$$\delta I_1(y) = \int_a^{x_0} \left( F_y - \frac{d}{dx} F_{y'} \right) dx + ((F(x, y, y') - F(x, \phi, \phi') + (\phi' - y') F_{y'}) \delta x) \Big|_{x_0} = 0$$

Since  $\delta I_1$  vanishes for those variations satisfying  $\delta x_0 = 0$  we obtain the Euler differential equation,

$$F_y - \frac{d}{dx} F_{y'} = 0.$$

Then we have

$$\left. ((F(x, y, y') - F(x, \phi, \phi') + (\phi' - y')F_{y'})\delta x) \right|_{x_0} = 0$$

for all variations  $\delta x_0$ . This implies that

$$\left. (F(x, y, y') - F(x, \phi, \phi') + (\phi' - y')F_{y'}) \right|_{x_0} = 0.$$

Two solutions of this equation are

$$y'(x_0) = \phi'(x_0) \quad \text{and} \quad F_{y'} = 0.$$

**Transversality condition.** If  $F_{y'}$  is not identically zero, the extremal must be tangent to  $\partial R$  at the points of contact.

Now we apply this result to find the curves which extremize  $\int_0^{10} (y')^3 dx$ ,  $y(0) = 0$ ,  $y(10) = 0$  given that the admissible curves can not penetrate the interior of the circle  $(x - 5)^2 + y^2 = 9$ . Since the Lagrangian is a function of  $y'$  alone, the extremals are straight lines.

The Erdmann corner conditions require that

$$F_{y'} = 3(y')^2 \quad \text{and} \quad F - y'F_{y'} = (y')^3 - y'3(y')^2 = -2(y')^3$$

are continuous at corners. This implies that  $y'$  is continuous. There are no corners.

We see that the extrema are

$$y(x) = \begin{cases} \pm \frac{3}{4}x, & \text{for } 0 \leq x \leq \frac{16}{5}, \\ \pm \sqrt{9 - (x - 5)^2}, & \text{for } \frac{16}{5} \leq x \leq \frac{34}{5}, \\ \mp \frac{3}{4}x, & \text{for } \frac{34}{5} \leq x \leq 10. \end{cases}$$

Note that the extremizing curves neither minimize nor maximize the integral.

**Solution 48.7**

**$C^1$  Extremals.** Without loss of generality, we take the vertical line to be the  $y$  axis. We will consider  $x_1, y_1 > 1$ . With  $ds = \sqrt{1 + (y')^2} dx$  we extremize the integral,

$$\int_0^{x_1} \sqrt{y} \sqrt{1 + (y')^2} dx.$$

Since the Lagrangian is independent of  $x$ , we know that the Euler differential equation has a first integral.

$$\frac{d}{dx} F_{y'} - F_y = 0$$

$$y' F_{y'y} + y'' F_{y'y'} - F_y = 0$$

$$\frac{d}{dx} (y' F_{y'} - F) = 0$$

$$y' F_{y'} - F = \text{const}$$

For the given Lagrangian, this is

$$y' \sqrt{y} \frac{y'}{\sqrt{1 + (y')^2}} - \sqrt{y} \sqrt{1 + (y')^2} = \text{const},$$

$$(y')^2 \sqrt{y} - \sqrt{y} (1 + (y')^2) = \text{const} \sqrt{1 + (y')^2},$$

$$\sqrt{y} = \text{const} \sqrt{1 + (y')^2}$$

$y = \text{const}$  is one solution. To find the others we solve for  $y'$  and then solve the differential equation.

$$y = a(1 + (y')^2)$$

$$y' = \pm \sqrt{\frac{y - a}{a}}$$

$$dx = \sqrt{\frac{a}{y - a}} dy$$

$$\pm x + b = 2\sqrt{a(y - a)}$$

$$y = \frac{x^2}{4a} \pm \frac{bx}{2a} + \frac{b^2}{4a} + a$$

The natural boundary condition is

$$F_{y'} \Big|_{x=0} = \frac{\sqrt{yy'}}{\sqrt{1+(y')^2}} \Big|_{x=0} = 0,$$

$$y'(0) = 0$$

The extremal that satisfies this boundary condition is

$$y = \frac{x^2}{4a} + a.$$

Now we apply  $y(x_1) = y_1$  to obtain

$$a = \frac{1}{2} \left( y_1 \pm \sqrt{y_1^2 - x_1^2} \right)$$

for  $y_1 \geq x_1$ . The value of the integral is

$$\int_0^{x_1} \sqrt{\left(\frac{x^2}{4a} + a\right) \left(1 + \left(\frac{x}{2a}\right)^2\right)} dx = \frac{x_1(x_1^2 + 12a^2)}{12a^{3/2}}.$$

By denoting  $y_1 = cx_1$ ,  $c \geq 1$  we have

$$a = \frac{1}{2} \left( cx_1 \pm x_1 \sqrt{c^2 - 1} \right)$$

The values of the integral for these two values of  $a$  are

$$\sqrt{2}(x_1)^{3/2} \frac{-1 + 3c^2 \pm 3c\sqrt{c^2 - 1}}{3(c \pm \sqrt{c^2 - 1})^{3/2}}.$$

The values are equal only when  $c = 1$ . These values, (divided by  $\sqrt{x_1}$ ), are plotted in Figure 48.1 as a function of  $c$ . The former and latter are fine and coarse dashed lines, respectively. The extremal with

$$a = \frac{1}{2} \left( y_1 + \sqrt{y_1^2 - x_1^2} \right)$$

has the smaller performance index. The value of the integral is

$$\frac{x_1(x_1^2 + 3(y_1 + \sqrt{y_1^2 - x_1^2})^2)}{3\sqrt{2}(y_1 + \sqrt{y_1^2 - x_1^2})^3}.$$

The function  $y = y_1$  is an admissible extremal for all  $x_1$ . The value of the integral for this extremal is  $x_1\sqrt{y_1}$  which is larger than the integral of the quadratic we analyzed before for  $y_1 > x_1$ .

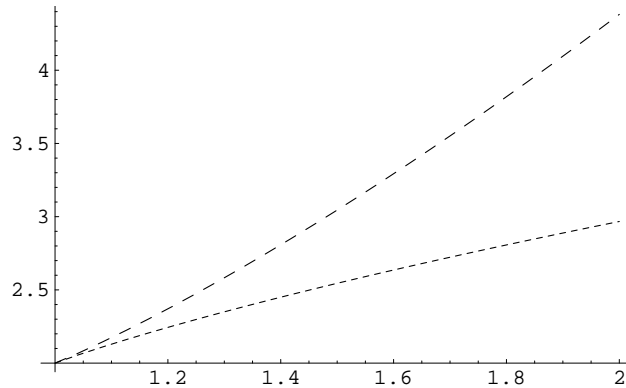

Figure 48.1:

Thus we see that

$$\hat{y} = \frac{x^2}{4a} + a, \quad a = \frac{1}{2} \left( y_1 + \sqrt{y_1^2 - x_1^2} \right)$$



is the extremal with the smaller integral and is the minimizing curve in  $C^1$  for  $y_1 \geq x^1$ . For  $y_1 < x_1$  the  $C^1$  extremum is,

$$\hat{y} = y_1.$$

**$C_p^1$  Extremals.** Consider the parametric form of the Lagrangian.

$$\int_{t_0}^{t_1} \sqrt{y(t)} \sqrt{(x'(t))^2 + (y'(t))^2} dt$$

The Euler differential equations are

$$\frac{d}{dt} f_{x'} - f_x = 0 \quad \text{and} \quad \frac{d}{dt} f_{y'} - f_y = 0.$$

If one of the equations is satisfied, then the other is automatically satisfied, (or the extremal is straight). With either of these equations we could derive the quadratic extremal and the  $y = \text{const}$  extremal that we found previously. We will find one more extremal by considering the first parametric Euler differential equation.

$$\begin{aligned} \frac{d}{dt} f_{x'} - f_x &= 0 \\ \frac{d}{dt} \left( \frac{\sqrt{y(t)} x'(t)}{\sqrt{(x'(t))^2 + (y'(t))^2}} \right) &= 0 \\ \frac{\sqrt{y(t)} x'(t)}{\sqrt{(x'(t))^2 + (y'(t))^2}} &= \text{const} \end{aligned}$$

Note that  $x(t) = \text{const}$  is a solution. Thus the extremals are of the three forms,

$$\begin{aligned} x &= \text{const}, \\ y &= \text{const}, \\ y &= \frac{x^2}{4a} + \frac{bx}{2a} + \frac{b^2}{4a} + a. \end{aligned}$$

The Erdmann corner conditions require that

$$F_{y'} = \frac{\sqrt{y}y'}{\sqrt{1+(y')^2}},$$

$$F - y'F_{y'} = \sqrt{y}\sqrt{1+(y')^2} - \frac{\sqrt{y}(y')^2}{\sqrt{1+(y')^2}} = \frac{\sqrt{y}}{\sqrt{1+(y')^2}}$$

are continuous at corners. There can be corners only if  $y = 0$ .

Now we piece the three forms together to obtain  $C_p^1$  extremals that satisfy the Erdmann corner conditions. The only possibility that is not  $C^1$  is the extremal that is a horizontal line from  $(0, 0)$  to  $(x_1, 0)$  and then a vertical line from  $(x_1, y_1)$ . The value of the integral for this extremal is

$$\int_0^{y_1} \sqrt{t} dt = \frac{2}{3}(y_1)^{3/2}.$$

Equating the performance indices of the quadratic extremum and the piecewise smooth extremum,

$$\frac{x_1(x_1^2 + 3(y_1 + \sqrt{y_1^2 - x_1^2})^2)}{3\sqrt{2}(y_1 + \sqrt{y_1^2 - x_1^2})^3} = \frac{2}{3}(y_1)^{3/2},$$

$$y_1 = \pm x_1 \frac{\sqrt{3 \pm 2\sqrt{3}}}{\sqrt{3}}.$$

The only real positive solution is

$$y_1 = x_1 \frac{\sqrt{3 + 2\sqrt{3}}}{\sqrt{3}} \approx 1.46789 x_1.$$

The piecewise smooth extremal has the smaller performance index for  $y_1$  smaller than this value and the quadratic extremal has the smaller performance index for  $y_1$  greater than this value.

The  $C_p^1$  extremum is the piecewise smooth extremal for  $y_1 \leq x_1 \sqrt{3 + 2\sqrt{3}}/\sqrt{3}$  and is the quadratic extremal for  $y_1 \geq x_1 \sqrt{3 + 2\sqrt{3}}/\sqrt{3}$ .

### Solution 48.8

The shape of the rope will be a catenary between  $x_1$  and  $x_2$  and be a vertically hanging segment after that. Let the length of the vertical segment be  $z$ . Without loss of generality we take  $x_1 = y_2 = 0$ . The potential energy, (relative to  $y = 0$ ), of a length of rope  $ds$  in  $0 \leq x \leq x_2$  is  $mgy = \rho gy ds$ . The total potential energy of the vertically hanging rope is  $m(\text{center of mass})g = \rho z(-z/2)g$ . Thus we seek to minimize,

$$\rho g \int_0^{x_2} y ds - \frac{1}{2} \rho g z^2, \quad y(0) = y_1, \quad y(x_2) = 0,$$

subject to the isoperimetric constraint,

$$\int_0^{x_2} ds - z = L.$$

Writing the arc-length differential as  $ds = \sqrt{1 + (y')^2} dx$  we minimize

$$\rho g \int_0^{x_2} y \sqrt{1 + (y')^2} ds - \frac{1}{2} \rho g z^2, \quad y(0) = y_1, \quad y(x_2) = 0,$$

subject to,

$$\int_0^{x_2} \sqrt{1 + (y')^2} dx - z = L.$$

Consider the more general problem of finding functions  $y(x)$  and numbers  $z$  which extremize  $I \equiv \int_a^b F(x, y, y') dx + f(z)$  subject to  $J \equiv \int_a^b G(x, y, y') dx + g(z) = L$ .

Suppose  $y(x)$  and  $z$  are the desired solutions and form the comparison families,  $y(x) + \epsilon_1 \eta_1(x) + \epsilon_2 \eta_2(x)$ ,  $z + \epsilon_1 \zeta_1 + \epsilon_2 \zeta_2$ . Then, there exists a constant such that

$$\begin{aligned} \frac{\partial}{\partial \epsilon_1} (I + \lambda J) \Big|_{\epsilon_1, \epsilon_2 = 0} &= 0 \\ \frac{\partial}{\partial \epsilon_2} (I + \lambda J) \Big|_{\epsilon_1, \epsilon_2 = 0} &= 0. \end{aligned}$$

These equations are

$$\int_a^b \left( \frac{d}{dx} H_{,y'} - H_y \right) \eta_1 dx + h'(z) \zeta_1 = 0,$$

and

$$\int_a^b \left( \frac{d}{dx} H_{,y'} - H_y \right) \eta_2 dx + h'(z) \zeta_2 = 0,$$

where  $H = F + \lambda G$  and  $h = f + \lambda g$ . From this we conclude that

$$\frac{d}{dx} H_{,y'} - H_y = 0, \quad h'(z) = 0$$

with  $\lambda$  determined by

$$J = \int_a^b G(x, y, y') dx + g(z) = L.$$

Now we apply these results to our problem. Since  $f(z) = -\frac{1}{2}\rho g z^2$  and  $g(z) = -z$  we have

$$-\rho g z - \lambda = 0,$$

$$\boxed{z = -\frac{\lambda}{\rho g}}.$$

It was shown in class that the solution of the Euler differential equation is a family of catenaries,

$$y = -\frac{\lambda}{\rho g} + c_1 \cosh \left( \frac{x - c_2}{c_1} \right).$$

One can find  $c_1$  and  $c_2$  in terms of  $\lambda$  by applying the end conditions  $y(0) = y_1$  and  $y(x_2) = 0$ . Then the expression for  $y(x)$  and  $z = -\lambda/\rho g$  are substituted into the isoperimetric constraint to determine  $\lambda$ .

Consider the special case that  $(x_1, y_1) = (0, 0)$  and  $(x_2, y_2) = (1, 0)$ . In this case we can use the fact that  $y(0) = y(1)$  to solve for  $c_2$  and write  $y$  in the form

$$y = -\frac{\lambda}{\rho g} + c_1 \cosh \left( \frac{x - 1/2}{c_1} \right).$$

Applying the condition  $y(0) = 0$  would give us the algebraic-transcendental equation,

$$y(0) = -\frac{\lambda}{\rho g} + c_1 \cosh\left(\frac{1}{2c_1}\right) = 0,$$

which we can't solve in closed form. Since we ran into a dead end in applying the boundary condition, we turn to the isoperimetric constraint.

$$\begin{aligned} \int_0^1 \sqrt{1 + (y')^2} dx - z &= L \\ \int_0^1 \cosh\left(\frac{x - 1/2}{c_1}\right) dx - z &= L \\ 2c_1 \sinh\left(\frac{1}{2c_1}\right) - z &= L \end{aligned}$$

With the isoperimetric constraint, the algebraic-transcendental equation and  $z = -\lambda/\rho g$  we now have

$$\begin{aligned} z &= -c_1 \cosh\left(\frac{1}{2c_1}\right), \\ z &= 2c_1 \sinh\left(\frac{1}{2c_1}\right) - L. \end{aligned}$$

For any fixed  $L$ , we can numerically solve for  $c_1$  and thus obtain  $z$ . You can derive that there are no solutions unless  $L$  is greater than about 1.9366. If  $L$  is smaller than this, the rope would slip off the pin. For  $L = 2$ ,  $c_1$  has the values 0.4265 and 0.7524. The larger value of  $c_1$  gives the smaller potential energy. The position of the end of the rope is  $z = -0.9248$ .

### Solution 48.9

Using the method of Lagrange multipliers, we look for stationary values of  $\int_0^c ((y')^2 + \lambda y^2) dx$ ,

$$\delta \int_0^c ((y')^2 + \lambda y^2) dx = 0.$$

The Euler differential equation is

$$\frac{d}{dx}F(x, y') - F_{,y} = 0,$$

$$\frac{d}{dx}(2y') - 2\lambda y = 0.$$

Together with the homogeneous boundary conditions, we have the problem

$$y'' - \lambda y = 0, \quad y(0) = y(c) = 0,$$

which has the solutions,

$$\lambda_n = -\left(\frac{n\pi}{c}\right)^2, \quad y_n = a_n \sin\left(\frac{n\pi x}{c}\right), \quad n \in \mathbb{Z}^+.$$

Now we determine the constants  $a_n$  with the moment of inertia constraint.

$$\int_0^c a_n^2 \sin^2\left(\frac{n\pi x}{c}\right) dx = \frac{ca_n^2}{2} = A$$

Thus we have the extremals,

$$y_n = \sqrt{\frac{2A}{c}} \sin\left(\frac{n\pi x}{c}\right), \quad n \in \mathbb{Z}^+.$$

The drag for these extremals is

$$D = \frac{2A}{c} \int_0^c \left(\frac{n\pi}{c}\right)^2 \cos^2\left(\frac{n\pi x}{c}\right) dx = \frac{An^2\pi^2}{c^2}.$$

We see that the drag is minimum for  $n = 1$ . The shape for minimum drag is

$$\hat{y} = \sqrt{\frac{2A}{c}} \sin\left(\frac{\pi x}{c}\right).$$

**Solution 48.10**

Consider the general problem of determining the stationary values of the quantity  $\omega^2$  given by

$$\omega^2 = \frac{\int_a^b F(x, y, y', y'') dx}{\int_a^b G(x, y, y', y'') dx} \equiv \frac{I}{J}.$$

The variation of  $\omega^2$  is

$$\begin{aligned} \delta\omega^2 &= \frac{J\delta I - I\delta J}{J^2} \\ &= \frac{1}{J} \left( \delta I - \frac{I}{J}\delta J \right) \\ &= \frac{1}{J} (\delta I - \omega^2\delta J). \end{aligned}$$

The the values of  $y$  and  $y'$  are specified on the boundary, then the variations of  $I$  and  $J$  are

$$\delta I = \int_a^b \left( \frac{d^2}{dx^2} F_{,y''} - \frac{d}{dx} F_{,y'} + F_{,y} \right) \delta y dx, \quad \delta J = \int_a^b \left( \frac{d^2}{dx^2} G_{,y''} - \frac{d}{dx} G_{,y'} + G_{,y} \right) \delta y dx$$

Thus  $\delta\omega^2 = 0$  becomes

$$\frac{\int_a^b \left( \frac{d^2}{dx^2} H_{,y''} - \frac{d}{dx} H_{,y'} + H_{,y} \right) \delta y dx}{\int_a^b G dx} = 0,$$

where  $H = F - \omega^2 G$ . A necessary condition for an extremum is

$$\boxed{\frac{d^2}{dx^2} H_{,y''} - \frac{d}{dx} H_{,y'} + H_{,y} = 0 \quad \text{where } H \equiv F - \omega^2 G.}$$

For our problem we have  $F = EI(y'')^2$  and  $G = \rho y$  so that the extremals are solutions of

$$\frac{d^2}{dx^2} \left( EI \frac{dy}{dx} \right) - \rho\omega^2 y = 0,$$

With homogeneous boundary conditions we have an eigenvalue problem with deflections modes  $y_n(x)$  and corresponding natural frequencies  $\omega_n$ .

**Solution 48.11**

We assume that  $v_0 > w(x, y, t)$  so that the problem has a solution for any end point. The crossing time is

$$T = \int_0^l \left( \dot{X}(t) \right)^{-1} dx = \frac{1}{v_0} \int_0^l \sec \alpha(t) dx.$$

Note that

$$\begin{aligned} \frac{dy}{dx} &= \frac{w + v_0 \sin \alpha}{v_0 \cos \alpha} \\ &= \frac{w}{v_0} \sec \alpha + \tan \alpha \\ &= \frac{w}{v_0} \sec \alpha + \sqrt{\sec^2 \alpha - 1}. \end{aligned}$$

We solve this relation for  $\sec \alpha$ .

$$\begin{aligned} \left( y' - \frac{w}{v_0} \sec \alpha \right)^2 &= \sec^2 \alpha - 1 \\ (y')^2 - 2 \frac{w}{v_0} y' \sec \alpha + \frac{w^2}{v_0^2} \sec^2 \alpha &= \sec^2 \alpha - 1 \\ (v_0^2 - w^2) \sec^2 \alpha + 2v_0 w y' \sec \alpha - v_0^2 ((y')^2 + 1) &= 0 \\ \sec \alpha &= \frac{-2v_0 w y' \pm \sqrt{4v_0^2 w^2 (y')^2 + 4(v_0^2 - w^2)v_0^2 ((y')^2 + 1)}}{2(v_0^2 - w^2)} \\ \sec \alpha &= v_0 \frac{-w y' \pm \sqrt{v_0^2 ((y')^2 + 1) - w^2}}{(v_0^2 - w^2)} \end{aligned}$$



Since the steering angle satisfies  $-\pi/2 \leq \alpha \leq \pi/2$  only the positive solution is relevant.

$$\sec \alpha = v_0 \frac{-wy' + \sqrt{v_0^2((y')^2 + 1) - w^2}}{(v_0^2 - w^2)}$$

**Time Independent Current.** If we make the assumption that  $w = w(x, y)$  then we can write the crossing time as an integral of a function of  $x$  and  $y$ .

$$T(y) = \int_0^l \frac{-wy' + \sqrt{v_0^2((y')^2 + 1) - w^2}}{(v_0^2 - w^2)} dx$$

A necessary condition for a minimum is  $\delta T = 0$ . The Euler differential equation for this problem is

$$\frac{d}{dx} F_{,y'} - F_{,y} = 0$$

$$\frac{d}{dx} \left( \frac{1}{v_0^2 - w^2} \left( -w + \frac{v_0^2 y'}{\sqrt{v_0^2((y')^2 + 1) - w^2}} \right) \right) - \frac{w_y}{(v_0^2 - w^2)^2} \left( \frac{w(v^2(1 + 2(y')^2) - w^2)}{\sqrt{v_0^2((y')^2 + 1) - w^2}} - y'(v_0^2 + w^2) \right)$$

By solving this second order differential equation subject to the boundary conditions  $y(0) = 0$ ,  $y(l) = y_1$  we obtain the path of minimum crossing time.

**Current  $w = w(x)$ .** If the current is only a function of  $x$ , then the Euler differential equation can be integrated to obtain,

$$\frac{1}{v_0^2 - w^2} \left( -w + \frac{v_0^2 y'}{\sqrt{v_0^2((y')^2 + 1) - w^2}} \right) = c_0.$$

Solving for  $y'$ ,

$$y' = \pm \frac{w + c_0(v_0^2 - w^2)}{v_0 \sqrt{1 - 2c_0 w - c_0^2(v_0^2 - w^2)}}.$$

Since  $y(0) = 0$ , we have

$$y(x) = \pm \int_0^x \frac{w(\xi) + c_0(v_0^2 - (w(\xi))^2)}{v_0 \sqrt{1 - 2c_0 w(\xi) - c_0^2(v_0^2 - (w(\xi))^2)}} d\xi.$$

For any given  $w(x)$  we can use the condition  $y(l) = y_1$  to solve for the constant  $c_0$ .

**Constant Current.** If the current is constant then the Lagrangian is a function of  $y'$  alone. The admissible extremals are straight lines. The solution is then

$$y(x) = \frac{y_1 x}{l}.$$

### Solution 48.12

- The kinetic energy of the first particle is  $\frac{1}{2}m((\alpha - x)\dot{\theta})^2$ . Its potential energy, relative to the table top, is zero. The kinetic energy of the second particle is  $\frac{1}{2}m\dot{x}^2$ . Its potential energy, relative to its equilibrium position is  $-mgx$ . The Lagrangian is the difference of kinetic and potential energy.

$$L = m \left( \dot{x}^2 + \frac{1}{2}(\alpha - x)^2 \dot{\theta}^2 + gx \right)$$

The Euler differential equations are the equations of motion.

$$\frac{d}{dt} L_{,\dot{x}} - L_x = 0, \quad \frac{d}{dt} L_{,\dot{\theta}} - L_{\theta} = 0$$

$$\frac{d}{dt}(2m\dot{x}) + m(\alpha - x)\dot{\theta}^2 - mg = 0, \quad \frac{d}{dt}(m(\alpha - x)^2 \dot{\theta}^2) = 0$$

$$2\ddot{x} + (\alpha - x)\dot{\theta}^2 - g = 0, \quad (\alpha - x)^2 \dot{\theta}^2 = \text{const}$$

When  $x = 0$ ,  $\dot{\theta} = \omega = \sqrt{g/\alpha}$ . This determines the constant in the equation of motion for  $\theta$ .

$$\dot{\theta} = \frac{\alpha \sqrt{\alpha g}}{(\alpha - x)^2}$$

Now we substitute the expression for  $\dot{\theta}$  into the equation of motion for  $x$ .

$$2\ddot{x} + (\alpha - x) \frac{\alpha^3 g}{(\alpha - x)^4} - g = 0$$

$$2\ddot{x} + \left( \frac{\alpha^3}{(\alpha - x)^3} - 1 \right) g = 0$$

$$2\ddot{x} + \left( \frac{1}{(1 - x/\alpha)^3} - 1 \right) g = 0$$

2. For small oscillations,  $\left| \frac{x}{\alpha} \right| \ll 1$ . Recall the binomial expansion,

$$(1 + z)^a = \sum_{n=0}^{\infty} \binom{a}{n} z^n, \quad \text{for } |z| < 1,$$

$$(1 + z)^a \approx 1 + az, \quad \text{for } |z| \ll 1.$$

We make the approximation,

$$\frac{1}{(1 - x/\alpha)^3} \approx 1 + 3\frac{x}{\alpha},$$

to obtain the linearized equation of motion,

$$2\ddot{x} + \frac{3g}{\alpha}x = 0.$$

This is the equation of a harmonic oscillator with solution

$$x = a \sin \left( \sqrt{3g/2\alpha}(t - b) \right).$$

The period of oscillation is,

$$T = 2\pi\sqrt{2\alpha/3g}.$$

### Solution 48.13

We write the equation of motion and boundary conditions,

$$\ddot{x} = U(t) - g, \quad x(0) = \dot{x}(0) = 0, \quad x(T) = h,$$

as the first order system,

$$\begin{aligned}\dot{x} &= 0, & x(0) &= 0, & x(T) &= h, \\ \dot{y} &= U(t) - g, & y(0) &= 0.\end{aligned}$$

We seek to minimize,

$$T = \int_0^T dt,$$

subject to the constraints,

$$\begin{aligned}\dot{x} - y &= 0, \\ \dot{y} - U(t) + g &= 0, \\ \int_0^T U^2(t) dt &= k^2.\end{aligned}$$

Thus we seek extrema of

$$\int_0^T H dt \equiv \int_0^T (1 + \lambda(t)(\dot{x} - y) + \mu(t)(\dot{y} - U(t) + g) + \nu U^2(t)) dt.$$

Since  $y$  is not specified at  $t = T$ , we have the natural boundary condition,

$$\begin{aligned}H_{,\dot{y}}|_{t=T} &= 0, \\ \mu(T) &= 0.\end{aligned}$$

The first Euler differential equation is

$$\begin{aligned}\frac{d}{dt}H_{,\dot{x}} - H_{,x} &= 0, \\ \frac{d}{dt}\lambda(t) &= 0.\end{aligned}$$

We see that  $\lambda(t) = \lambda$  is constant. The next Euler DE is

$$\frac{d}{dt}H_{,\dot{y}} - H_{,y} = 0,$$

$$\frac{d}{dt}\mu(t) + \lambda = 0.$$

$$\mu(t) = -\lambda t + \text{const}$$

With the natural boundary condition,  $\mu(T) = 0$ , we have

$$\mu(t) = \lambda(T - t).$$

The final Euler DE is,

$$\frac{d}{dt}H_{,\dot{U}} - H_{,U} = 0,$$

$$\mu(t) - 2\nu U(t) = 0.$$

Thus we have

$$U(t) = \frac{\lambda(T - t)}{2\nu}.$$

This is the required thrust function. We use the constraints to find  $\lambda$ ,  $\nu$  and  $T$ .

Substituting  $U(t) = \lambda(T - t)/(2\nu)$  into the isoperimetric constraint,  $\int_0^T U^2(t) dt = k^2$  yields

$$\frac{\lambda^2 T^3}{12\nu^2} = k^2,$$

$$U(t) = \frac{\sqrt{3}k}{T^{3/2}}(T - t).$$

The equation of motion for  $x$  is

$$\ddot{x} = U(t) - g = \frac{\sqrt{3}k}{T^{3/2}}(T - t).$$

Integrating and applying the initial conditions  $x(0) = \dot{x}(0) = 0$  yields,

$$x(t) = \frac{kt^2(3T - t)}{2\sqrt{3}T^{3/2}} - \frac{1}{2}gt^2.$$

Applying the condition  $x(T) = h$  gives us,

$$\frac{k}{\sqrt{3}}T^{3/2} - \frac{1}{2}gT^2 = h,$$

$$\boxed{\frac{1}{4}g^2T^4 - \frac{k}{3}T^3 + ghT^2 + h^2 = 0.}$$

If  $k \geq 4\sqrt{2/3}g^{3/2}\sqrt{h}$  then this fourth degree polynomial has positive, real solutions for  $T$ . With strict inequality, the minimum time is the smaller of the two positive, real solutions. If  $k < 4\sqrt{2/3}g^{3/2}\sqrt{h}$  then there is not enough fuel to reach the target height.

#### Solution 48.14

We have  $\ddot{x} = U(t)$  where  $U(t)$  is the acceleration furnished by the thrust of the vehicles engine. In practice, the engine will be designed to operate within certain bounds, say  $-M \leq U(t) \leq M$ , where  $\pm M$  is the maximum forward/backward acceleration. To account for the inequality constraint we write  $U = M \sin V(t)$  for some suitable  $V(t)$ . More generally, if we had  $\phi(t) \leq U(t) \leq \psi(t)$ , we could write this as  $U(t) = \frac{\psi+\phi}{2} + \frac{\psi-\phi}{2} \sin V(t)$ .

We write the equation of motion as a first order system,

$$\begin{aligned} \dot{x} &= y, & x(0) &= a, & x(T) &= 0, \\ \dot{y} &= M \sin V, & y(0) &= b, & y(T) &= 0. \end{aligned}$$

Thus we minimize

$$T = \int_0^T dt$$

subject to the constraints,

$$\begin{aligned} \dot{x} - y &= 0 \\ \dot{y} - M \sin V &= 0. \end{aligned}$$

Consider

$$H = 1 + \lambda(t)(\dot{x} - y) + \mu(t)(\dot{y} - M \sin V).$$

The Euler differential equations are

$$\begin{aligned} \frac{d}{dt}H_{,\dot{x}} - H_{,x} = 0 &\Rightarrow \frac{d}{dt}\lambda(t) = 0 &\Rightarrow \lambda(t) = \text{const} \\ \frac{d}{dt}H_{,\dot{y}} - H_{,y} = 0 &\Rightarrow \frac{d}{dt}\mu(t) + \lambda = 0 &\Rightarrow \mu(t) = -\lambda t + \text{const} \\ \frac{d}{dt}H_{,V} - H_{,V} = 0 &\Rightarrow \mu(t)M \cos V(t) = 0 &\Rightarrow V(t) = \frac{\pi}{2} + n\pi. \end{aligned}$$

Thus we see that

$$U(t) = M \sin\left(\frac{\pi}{2} + n\pi\right) = \pm M.$$

Therefore, if the rocket is to be transferred from its initial state to its specified final state in minimum time with a limited source of thrust, ( $|U| \leq M$ ), then the engine should operate at full power at all times except possibly for a finite number of switching times. (Indeed, if some power were not being used, we would expect the transfer would be speeded up by using the additional power suitably.)

To see how this "bang-bang" process works, we'll look at the phase plane. The problem

$$\begin{aligned} \dot{x} &= y, & x(0) &= c, \\ \dot{y} &= \pm M, & y(0) &= d, \end{aligned}$$

has the solution

$$x(t) = c + dt \pm M\frac{t^2}{2}, \quad y(t) = d \pm Mt.$$

We can eliminate  $t$  to get

$$x = \pm \frac{y^2}{2M} + c \mp \frac{d^2}{2M}.$$

These curves are plotted in Figure 48.2.

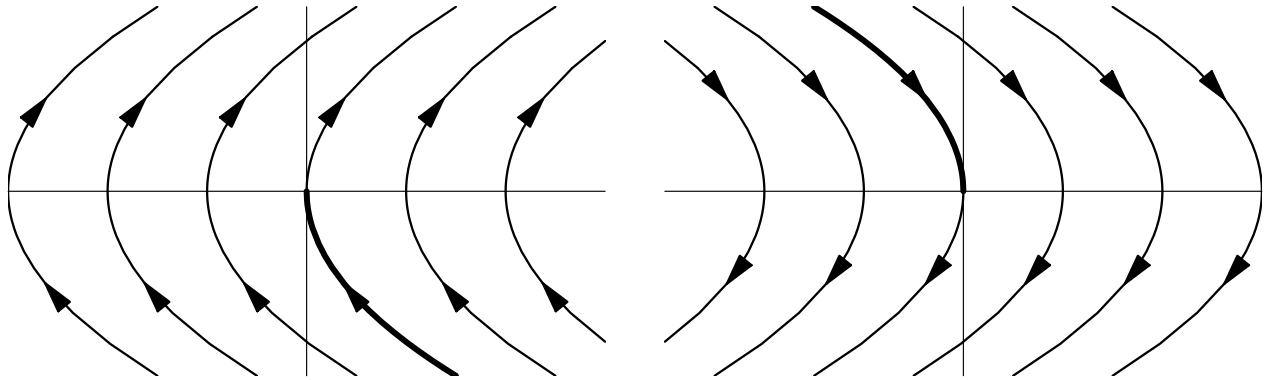

Figure 48.2:

There is only curve in each case which transfers the initial state to the origin. We will denote these curves  $\gamma$  and  $\Gamma$ , respectively. Only if the initial point  $(a, b)$  lies on one of these two curves can we transfer the state of the system to the origin along an extremal without switching. If  $a = \frac{b^2}{2M}$  and  $b < 0$  then this is possible using  $U(t) = M$ . If  $a = -\frac{b^2}{2M}$  and  $b > 0$  then this is possible using  $U(t) = -M$ . Otherwise we follow an extremal that intersects the initial position until this curve intersects  $\gamma$  or  $\Gamma$ . We then follow  $\gamma$  or  $\Gamma$  to the origin.

### Solution 48.15

Since the integrand does not explicitly depend on  $x$ , the Euler differential equation has the first integral,

$$F - y'F_{y'} = \text{const.}$$

$$\sqrt{y+h}\sqrt{1+(y')^2} - y' \frac{y'\sqrt{y+h}}{\sqrt{1+(y')^2}} = \text{const}$$

$$\frac{\sqrt{y+h}}{\sqrt{1+(y')^2}} = \text{const}$$

$$y+h = c_1^2(1+(y')^2)$$



$$\begin{aligned}\sqrt{y+h-c_1^2} &= c_1 y' \\ \frac{c_1 dy}{\sqrt{y+h-c_1^2}} &= dx \\ 2c_1 \sqrt{y+h-c_1^2} &= x-c_2 \\ 4c_1^2(y+h-c_1^2) &= (x-c_2)^2\end{aligned}$$

Since the extremal passes through the origin, we have

$$4c_1^2(h-c_1^2) = c_2^2.$$

$$4c_1^2 y = x^2 - 2c_2 x \tag{48.6}$$

Introduce as a parameter the slope of the extremal at the origin; that is,  $y'(0) = \alpha$ . Then differentiating (48.6) at  $x = 0$  yields  $4c_1^2 \alpha = -2c_2$ . Together with  $c_2^2 = 4c_1^2(h-c_1^2)$  we obtain  $c_1^2 = \frac{h}{1+\alpha^2}$  and  $c_2 = -\frac{2\alpha h}{1+\alpha^2}$ . Thus the equation of the pencil (48.6) will have the form

$$y = \alpha x + \frac{1+\alpha^2}{4h} x^2. \tag{48.7}$$

To find the envelope of this family we differentiate (48.7) with respect to  $\alpha$  to obtain  $0 = x + \frac{\alpha}{2h} x^2$  and eliminate  $\alpha$  between this and (48.7) to obtain

$$y = -h + \frac{x^2}{4h}.$$

See Figure 48.3 for a plot of some extremals and the envelope.

All extremals (48.7) lie above the envelope which in ballistics is called the parabola of safety. If  $(m, M)$  lies outside the parabola,  $M < -h + \frac{m^2}{4h}$ , then it cannot be joined to  $(0, 0)$  by an extremal. If  $(m, M)$  is above the envelope then there are two candidates. Clearly we rule out the one that touches the envelope because of the occurrence of conjugate points. For the other extremal, problem 2 shows that  $E \geq 0$  for all  $y'$ . Clearly we can embed this extremal in an extremal pencil, so Jacobi's test is satisfied. Therefore the parabola that does not touch the envelope is a strong minimum.

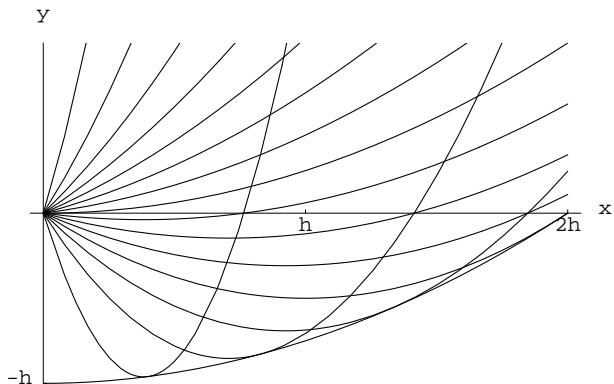

Figure 48.3: Some Extremals and the Envelope.

**Solution 48.16**

$$\begin{aligned}
 E &= F(x, y, y') - F(x, y, p) - (y' - p)F_{y'}(x, y, p) \\
 &= n\sqrt{1 + (y')^2} - n\sqrt{1 + p^2} - (y' - p)\frac{np}{\sqrt{1 + p^2}} \\
 &= \frac{n}{\sqrt{1 + p^2}} \left( \sqrt{1 + (y')^2}\sqrt{1 + p^2} - (1 + p^2) - (y' - p)p \right) \\
 &= \frac{n}{\sqrt{1 + p^2}} \left( \sqrt{1 + (y')^2 + p^2 + (y')^2p^2 - 2y'p + 2y'p} - (1 + py') \right) \\
 &= \frac{n}{\sqrt{1 + p^2}} \left( \sqrt{(1 + py')^2 + (y' - p)^2} - (1 + py') \right) \\
 &\geq 0
 \end{aligned}$$

The speed of light in an inhomogeneous medium is  $\frac{ds}{dt} = \frac{1}{n(x,y)}$ . The time of transit is then

$$T = \int_{(a,A)}^{(b,B)} \frac{dt}{ds} ds = \int_a^b n(x,y) \sqrt{1 + (y')^2} dx.$$

Since  $E \geq 0$ , light traveling on extremals follow the time optimal path as long as the extremals do not intersect.

**Solution 48.17**

**Extremals.** Since the integrand does not depend explicitly on  $x$ , the Euler differential equation has the first integral,

$$F - y'F_{y'} = \text{const.}$$

$$\frac{1 + y^2}{(y')^2} - y' \frac{-2(1 + y^2)}{(y')^3} = \text{const}$$

$$\frac{dy}{\sqrt{1 + (y')^2}} = \text{const } dx$$

$$\text{arcsinh}(y) = c_1x + c_2$$

$$\boxed{y = \sinh(c_1x + c_2)}$$

**Jacobi Test.** We can see by inspection that no conjugate points exist. Consider the central field through  $(0, 0)$ ,  $\sinh(cx)$ , (See Figure 48.4).

We can also easily arrive at this conclusion analytically as follows: Solutions  $u_1$  and  $u_2$  of the Jacobi equation are given by

$$u_1 = \frac{\partial y}{\partial c_2} = \cosh(c_1x + c_2),$$

$$u_2 = \frac{\partial y}{\partial c_1} = x \cosh(c_1x + c_2).$$

Since  $u_2/u_1 = x$  is monotone for all  $x$  there are no conjugate points.

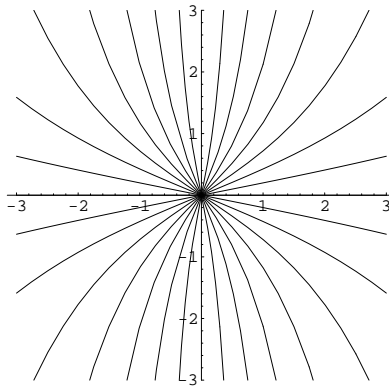

Figure 48.4:  $\sinh(cx)$

### Weierstrass Test.

$$\begin{aligned}
 E &= F(x, y, y') - F(x, y, p) - (y' - p)F_{,y'}(x, y, p) \\
 &= \frac{1 + y^2}{(y')^2} - \frac{1 + y^2}{p^2} - (y' - p)\frac{-2(1 + y^2)}{p^3} \\
 &= \frac{1 + y^2}{(y')^2 p^2} \left( \frac{p^3 - p(y')^2 + 2(y')^3 - 2p(y')^2}{p} \right) \\
 &= \frac{1 + y^2}{(y')^2 p^2} \left( \frac{(p - y')^2(p + 2y')}{p} \right)
 \end{aligned}$$

For  $p = p(x, y)$  bounded away from zero,  $E$  is one-signed for values of  $y'$  close to  $p$ . However, since the factor  $(p + 2y')$  can have any sign for arbitrary values of  $y'$ , the conditions for a strong minimum are not satisfied.

Furthermore, since the extremals are  $y = \sinh(c_1x + c_2)$ , the slope function  $p(x, y)$  will be of one sign only if the range of integration is such that we are on a monotonic piece of the  $\sinh$ . If we span both an increasing and decreasing section,  $E$  changes sign even for weak variations.

### Legendre Condition.

$$F_{,y'y'} = \frac{6(1+y^2)}{(y')^4} > 0$$

Note that  $F$  cannot be represented in a Taylor series for arbitrary values of  $y'$  due to the presence of a discontinuity in  $F$  when  $y' = 0$ . However,  $F_{,y'y'} > 0$  on an extremal implies a weak minimum is provided by the extremal.

**Strong Variations.** Consider  $\int \frac{1+y^2}{(y')^2} dx$  on both an extremal and on the special piecewise continuous variation in the figure. On  $PQ$  we have  $y' = \infty$  which implies that  $\frac{1+y^2}{(y')^2} = 0$  so that there is no contribution to the integral from  $PQ$ .

On  $QR$  the value of  $y'$  is greater than its value along the extremal  $PR$  while the value of  $y$  on  $QR$  is less than the value of  $y$  along  $PR$ . Thus on  $QR$  the quantity  $\frac{1+y^2}{(y')^2}$  is less than it is on the extremal  $PR$ .

$$\int_{QR} \frac{1+y^2}{(y')^2} dx < \int_{PR} \frac{1+y^2}{(y')^2} dx$$

Thus the weak minimum along the extremal can be weakened by a strong variation.

### Solution 48.18

The Euler differential equation is

$$\frac{d}{dx} F_{,y'} - F_{,y} = 0.$$

$$\frac{d}{dx} (1 + 2x^2 y') = 0$$

$$1 + 2x^2 y' = \text{const}$$

$$y' = \text{const} \frac{1}{x^2}$$

$$\boxed{y = \frac{c_1}{x} + c_2}$$

(i) No continuous extremal exists in  $-1 \leq x \leq 2$  that satisfies  $y(-1) = 1$  and  $y(2) = 4$ .

(ii) The continuous extremal that satisfies the boundary conditions is  $y = 7 - \frac{4}{x}$ . Since  $F_{,y'y'} = 2x^2 \geq 0$  has a Taylor series representation for all  $y'$ , this extremal provides a strong minimum.

(iii) The continuous extremal that satisfies the boundary conditions is  $y = 1$ . This is a strong minimum.

### Solution 48.19

For identity (a) we take  $P = 0$  and  $Q = \phi\psi_x - \psi\phi_x$ . For identity (b) we take  $P = \phi\psi_y - \psi\phi_y$  and  $Q = 0$ . For identity (c) we take  $P = -\frac{1}{2}(\phi\psi_x - \psi\phi_x)$  and  $Q = \frac{1}{2}(\phi\psi_y - \psi\phi_y)$ .

$$\iint_D \left( \frac{1}{2}(\phi\psi_y - \psi\phi_y)_x - \left(-\frac{1}{2}\right)(\phi\psi_x - \psi\phi_x)_y \right) dx dy = \int_{\Gamma} \left( -\frac{1}{2}(\phi\psi_x - \psi\phi_x) dx + \frac{1}{2}(\phi\psi_y - \psi\phi_y) dy \right)$$

$$\begin{aligned} \iint_D \left( \frac{1}{2}(\phi_x\psi_y + \phi\psi_{xy} - \psi_x\phi_y - \psi\phi_{xy}) + \frac{1}{2}(\phi_y\psi_x\phi\psi_{xy} - \psi_y\phi_x - \psi\phi_{xy}) \right) dx dy \\ = -\frac{1}{2} \int_{\Gamma} (\phi\psi_x - \psi\phi_x) dx + \frac{1}{2} \int_{\Gamma} (\phi\psi_y - \psi\phi_y) dy \end{aligned}$$

$$\iint_D \phi\psi_{xy} dx dy = \iint_D \psi\phi_{xy} dx dy - \frac{1}{2} \int_{\Gamma} (\phi\psi_x - \psi\phi_x) dx + \frac{1}{2} \int_{\Gamma} (\phi\psi_y - \psi\phi_y) dy$$

The variation of  $I$  is

$$\delta I = \int_{t_0}^{t_1} \iint_D (-2(u_{xx} + u_{yy})(\delta u_{xx} + \delta u_{yy}) + 2(1 - \mu)(u_{xx}\delta u_{yy} + u_{yy}\delta u_{xx} - 2u_{xy}\delta u_{xy})) dx dy dt.$$

From (a) we have

$$\begin{aligned} \iint_D -2(u_{xx} + u_{yy})\delta u_{xx} dx dy &= \iint_D -2(u_{xx} + u_{yy})_{xx}\delta u dx dy \\ &+ \int_{\Gamma} -2((u_{xx} + u_{yy})\delta u_x - (u_{xx} + u_{yy})_x\delta u) dy. \end{aligned}$$

From (b) we have

$$\begin{aligned} \iint_D -2(u_{xx} + u_{yy})\delta u_{yy} \, dx \, dy &= \iint_D -2(u_{xx} + u_{yy})_{yy}\delta u \, dx \, dy \\ &\quad - \int_{\Gamma} -2((u_{xx} + u_{yy})\delta u_y - (u_{xx} + u_{yy})_y\delta u) \, dy. \end{aligned}$$

From (a) and (b) we get

$$\begin{aligned} \iint_D 2(1 - \mu)(u_{xx}\delta u_{yy} + u_{yy}\delta u_{xx}) \, dx \, dy \\ &= \iint_D 2(1 - \mu)(u_{xxyy} + u_{yyxx})\delta u \, dx \, dy \\ &\quad + \int_{\Gamma} 2(1 - \mu)(-(u_{xx}\delta u_y - u_{xxy}\delta u) \, dx + (u_{yy}\delta u_x - u_{yyx}\delta u) \, dy). \end{aligned}$$

Using  $c$  gives us

$$\begin{aligned} \iint_D 2(1 - \mu)(-2u_{xy}\delta u_{xy}) \, dx \, dy &= \iint_D 2(1 - \mu)(-2u_{xyxy}\delta u) \, dx \, dy \\ &\quad + \int_{\Gamma} 2(1 - \mu)(u_{xy}\delta u_x - u_{xyx}\delta u) \, dx \\ &\quad - \int_{\Gamma} 2(1 - \mu)(u_{xy}\delta u_y - u_{xyy}\delta u) \, dy. \end{aligned}$$

Note that

$$\frac{\partial u}{\partial n} \, ds = u_x \, dy - u_y \, dx.$$

Using the above results, we obtain

$$\begin{aligned} \delta I &= 2 \int_{t_0}^{t_1} \iint_D (-\nabla^4 u)\delta u \, dx \, dy \, dt + 2 \int_{t_0}^{t_1} \int_{\Gamma} \left( \frac{\partial(\nabla^2 u)}{\partial n} \delta u + (\nabla^2 u) \frac{\partial(\delta u)}{\partial n} \right) \, ds \, dt \\ &\quad + 2(1 - \mu) \int_{t_0}^{t_1} \left( \int_{\Gamma} (u_{yy}\delta u_x - u_{xy}\delta u_y) \, dy + (u_{xy}\delta u_x - u_{xx}\delta u_y) \, dx \right) \, dt. \end{aligned}$$

**Solution 48.20**

1. **Exact Solution.** The Euler differential equation is

$$\begin{aligned}\frac{d}{dx}F_{,y'} &= F_{,y} \\ \frac{d}{dx}[2y'] &= -2y - 2x \\ y'' + y &= -x.\end{aligned}$$

The general solution is

$$y = c_1 \cos x + c_2 \sin x - x.$$

Applying the boundary conditions we obtain,

$$y = \frac{\sin x}{\sin 1} - x.$$

The value of the integral for this extremal is

$$J \left[ \frac{\sin x}{\sin 1} - x \right] = \cot(1) - \frac{2}{3} \approx -0.0245741.$$

**n = 0.** We consider an approximate solution of the form  $y(x) = ax(1-x)$ . We substitute this into the functional.

$$J(a) = \int_0^1 ((y')^2 - y^2 - 2xy) \, dx = \frac{3}{10}a^2 - \frac{1}{6}a$$

The only stationary point is

$$\begin{aligned}J'(a) &= \frac{3}{5}a - \frac{1}{6} = 0 \\ a &= \frac{5}{18}.\end{aligned}$$



Since

$$J''\left(\frac{5}{18}\right) = \frac{3}{5} > 0,$$

we see that this point is a minimum. The approximate solution is

$$y(x) = \frac{5}{18}x(1-x).$$

This one term approximation and the exact solution are plotted in Figure 48.5. The value of the functional is

$$J = -\frac{5}{216} \approx -0.0231481.$$

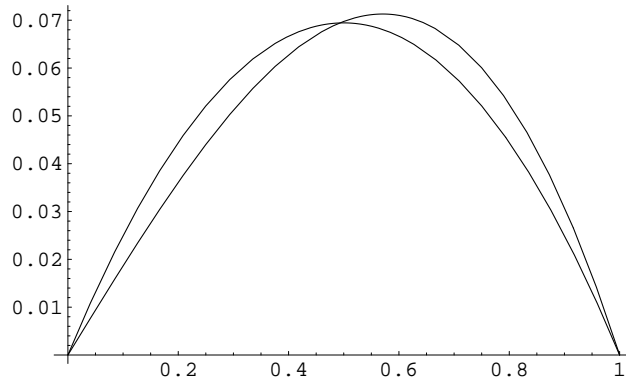

Figure 48.5: One Term Approximation and Exact Solution.

**n = 1.** We consider an approximate solution of the form  $y(x) = x(1-x)(a+bx)$ . We substitute this into the functional.

$$J(a,b) = \int_0^1 ((y')^2 - y^2 - 2xy) dx = \frac{1}{210} (63a^2 + 63ab + 26b^2 - 35a - 21b)$$

We find the stationary points.

$$J_a = \frac{1}{30}(18a + 9b - 5) = 0$$

$$J_b = \frac{1}{210}(63a + 52b - 21) = 0$$

$$a = \frac{71}{369}, \quad b = \frac{7}{41}$$

Since the Hessian matrix

$$H = \begin{pmatrix} J_{aa} & J_{ab} \\ J_{ba} & J_{bb} \end{pmatrix} = \begin{pmatrix} \frac{3}{5} & \frac{3}{10} \\ \frac{3}{10} & \frac{26}{105} \end{pmatrix},$$

is positive definite,

$$\frac{3}{5} > 0, \quad \det(H) = \frac{41}{700},$$

we see that this point is a minimum. The approximate solution is

$$y(x) = x(1-x) \left( \frac{71}{369} + \frac{7}{41}x \right).$$

This two term approximation and the exact solution are plotted in Figure 48.6. The value of the functional is

$$J = -\frac{136}{5535} \approx -0.0245709.$$

2. **Exact Solution.** The Euler differential equation is

$$\begin{aligned} \frac{d}{dx} F_{,y'} &= F_{,y} \\ \frac{d}{dx} [2y'] &= 2y + 2x \\ y'' - y &= x. \end{aligned}$$

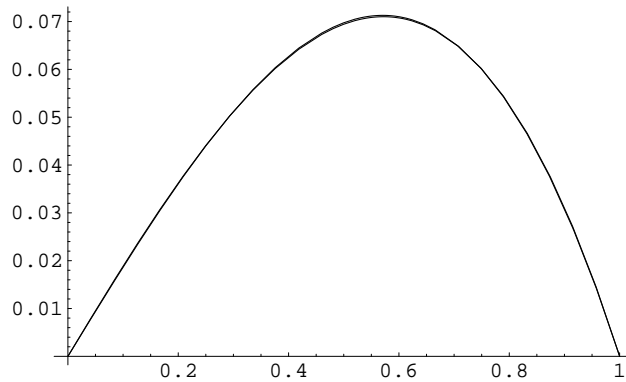

Figure 48.6: Two Term Approximation and Exact Solution.

The general solution is

$$y = c_1 \cosh x + c_2 \sinh x - x.$$

Applying the boundary conditions, we obtain,

$$y = \frac{2 \sinh x}{\sinh 2} - x.$$

The value of the integral for this extremal is

$$J = -\frac{2(e^4 - 13)}{3(e^4 - 1)} \approx -0.517408.$$

**Polynomial Approximation.** Consider an approximate solution of the form

$$y(x) = x(2 - x)(a_0 + a_1x + \cdots a_nx^n).$$

The one term approximate solution is

$$y(x) = -\frac{5}{14}x(2-x).$$

This one term approximation and the exact solution are plotted in Figure 48.7. The value of the functional is

$$J = -\frac{10}{21} \approx -0.47619.$$

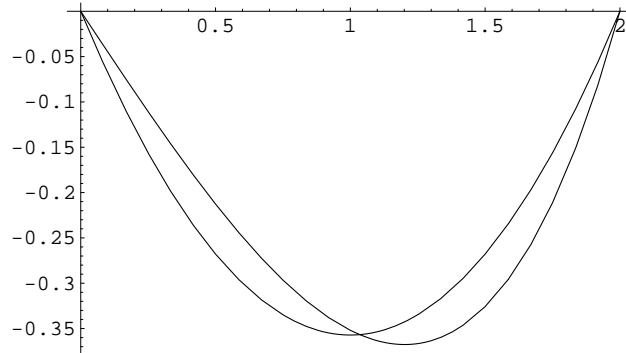

Figure 48.7: One Term Approximation and Exact Solution.

The two term approximate solution is

$$y(x) = x(2-x) \left( -\frac{33}{161} - \frac{7}{46}x \right).$$

This two term approximation and the exact solution are plotted in Figure 48.8. The value of the functional is

$$J = -\frac{416}{805} \approx -0.51677.$$

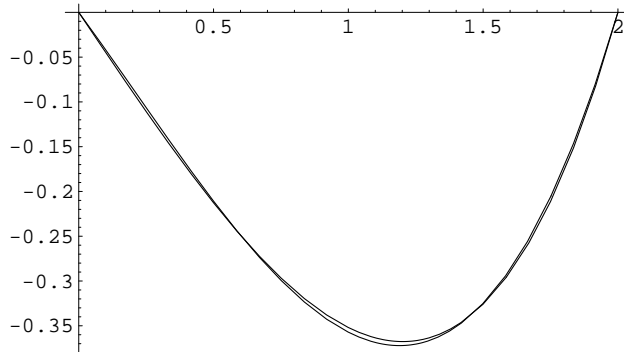

Figure 48.8: Two Term Approximation and Exact Solution.

**Sine Series Approximation.** Consider an approximate solution of the form

$$y(x) = a_1 \sin\left(\frac{\pi x}{2}\right) + a_2 \sin(\pi x) + \cdots + a_n \sin\left(n\frac{\pi x}{2}\right).$$

The one term approximate solution is

$$y(x) = -\frac{16}{\pi(\pi^2 + 4)} \sin\left(\frac{\pi x}{2}\right).$$

This one term approximation and the exact solution are plotted in Figure 48.9. The value of the functional is

$$J = -\frac{64}{\pi^2(\pi^2 + 4)} \approx -0.467537.$$

The two term approximate solution is

$$y(x) = -\frac{16}{\pi(\pi^2 + 4)} \sin\left(\frac{\pi x}{2}\right) + \frac{2}{\pi(\pi^2 + 1)} \sin(\pi x).$$

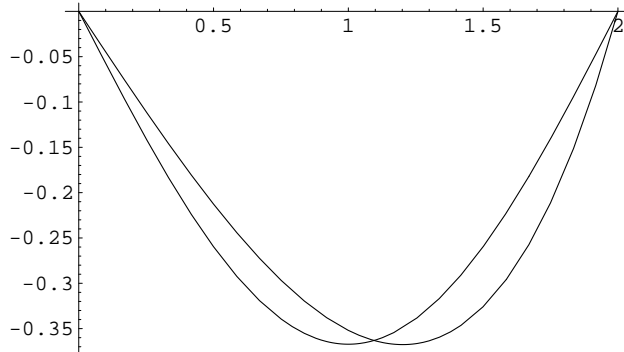

Figure 48.9: One Term Sine Series Approximation and Exact Solution.

This two term approximation and the exact solution are plotted in Figure 48.10. The value of the functional is

$$J = -\frac{4(17\pi^2 + 20)}{\pi^2(\pi^4 + 5\pi^2 + 4)} \approx -0.504823.$$

3. **Exact Solution.** The Euler differential equation is

$$\begin{aligned} \frac{d}{dx} F_{,y'} &= F_{,y} \\ \frac{d}{dx} [2xy'] &= -2\frac{x^2 - 1}{x}y - 2x^2 \\ y'' + \frac{1}{x}y' + \left(1 - \frac{1}{x^2}\right)y &= -x \end{aligned}$$

The general solution is

$$y = c_1 J_1(x) + c_2 Y_1(x) - x$$

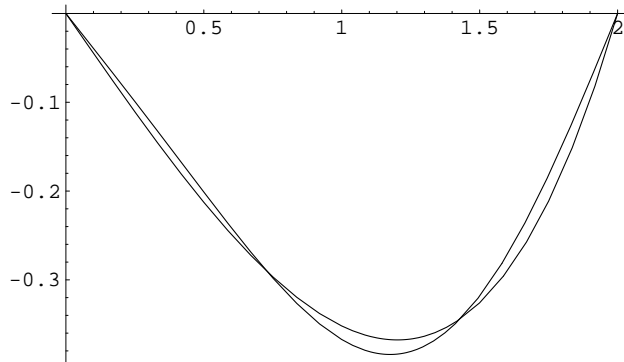

Figure 48.10: Two Term Sine Series Approximation and Exact Solution.

Applying the boundary conditions we obtain,

$$y = \frac{(Y_1(2) - 2Y_1(1))J_1(x) + (2J_1(1) - J_1(2))Y_1(x)}{J_1(1)Y_1(2) - Y_1(1)J_1(2)} - x$$

The value of the integral for this extremal is

$$J \approx -0.310947$$

**Polynomial Approximation.** Consider an approximate solution of the form

$$y(x) = (x - 1)(2 - x)(a_0 + a_1x + \cdots + a_nx^n).$$

The one term approximate solution is

$$y(x) = (x - 1)(2 - x) \frac{23}{6(40 \log 2 - 23)}$$

This one term approximation and the exact solution are plotted in Figure 48.11. The one term approximation is a surprisingly close to the exact solution. The value of the functional is

$$J = -\frac{529}{360(40 \log 2 - 23)} \approx -0.310935.$$

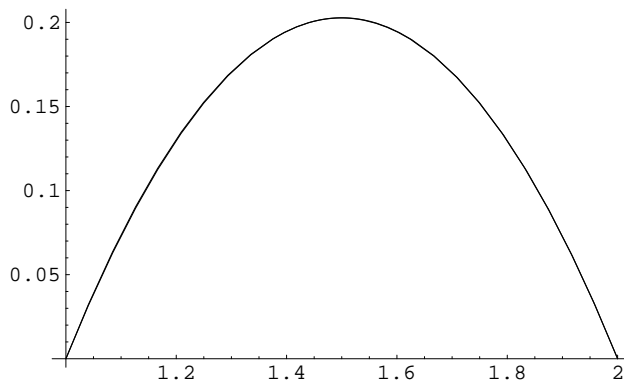

Figure 48.11: One Term Polynomial Approximation and Exact Solution.

### Solution 48.21

1. The spectrum of  $T$  is the set,

$$\{\lambda : (T - \lambda I) \text{ is not invertible.}\}$$



$$\begin{aligned}
(T - \lambda I)f &= g \\
\int_{-\infty}^{\infty} K(x - y)f(y) \, dy - \lambda f(x) &= g \\
\hat{K}(\omega)\hat{f}(\omega) - \lambda\hat{f}(\omega) &= \hat{g}(\omega) \\
(\hat{K}(\omega) - \lambda)\hat{f}(\omega) &= \hat{g}(\omega)
\end{aligned}$$

We may not be able to solve for  $\hat{f}(\omega)$ , (and hence invert  $T - \lambda I$ ), if  $\lambda = \hat{K}(\omega)$ . Thus all values of  $\hat{K}(\omega)$  are in the spectrum. If  $\hat{K}(\omega)$  is everywhere nonzero we consider the case  $\lambda = 0$ . We have the equation,

$$\int_{-\infty}^{\infty} K(x - y)f(y) \, dy = 0$$

Since there are an infinite number of  $L_2(-\infty, \infty)$  functions which satisfy this, (those which are nonzero on a set of measure zero), we cannot invert the equation. Thus  $\lambda = 0$  is in the spectrum. The spectrum of  $T$  is the range of  $\hat{K}(\omega)$  plus zero.

2. Let  $\lambda$  be a nonzero eigenvalue with eigenfunction  $\phi$ .

$$\begin{aligned}
(T - \lambda I)\phi &= 0, \quad \forall x \\
\int_{-\infty}^{\infty} K(x - y)\phi(y) \, dy - \lambda\phi(x) &= 0, \quad \forall x
\end{aligned}$$

Since  $K$  is continuous,  $T\phi$  is continuous. This implies that the eigenfunction  $\phi$  is continuous. We take the Fourier transform of the above equation.

$$\begin{aligned}
\hat{K}(\omega)\hat{\phi}(\omega) - \lambda\hat{\phi}(\omega) &= 0, \quad \forall \omega \\
(\hat{K}(\omega) - \lambda)\hat{\phi}(\omega) &= 0, \quad \forall \omega
\end{aligned}$$

If  $\phi(x)$  is absolutely integrable, then  $\hat{\phi}(\omega)$  is continuous. Since  $\phi(x)$  is not identically zero,  $\hat{\phi}(\omega)$  is not identically zero. Continuity implies that  $\hat{\phi}(\omega)$  is nonzero on some interval of positive length,  $(a, b)$ . From the above equation we see that  $\hat{K}(\omega) = \lambda$  for  $\omega \in (a, b)$ .

Now assume that  $\hat{K}(\omega) = \lambda$  in some interval  $(a, b)$ . Any function  $\hat{\phi}(\omega)$  that is nonzero only for  $\omega \in (a, b)$  satisfies

$$\left(\hat{K}(\omega) - \lambda\right) \hat{\phi}(\omega) = 0, \quad \forall \omega.$$

By taking the inverse Fourier transform we obtain an eigenfunction  $\phi(x)$  of the eigenvalue  $\lambda$ .

3. First we use the Fourier transform to find an explicit representation of  $u = (T - \lambda I)^{-1}f$ .

$$\begin{aligned} u &= (T - \lambda I)^{-1}f(T - \lambda I)u = f \\ \int_{-\infty}^{\infty} K(x - y)u(y) \, dy - \lambda u &= f \\ 2\pi\hat{K}\hat{u} - \lambda\hat{u} &= \hat{f} \\ \hat{u} &= \frac{\hat{f}}{2\pi\hat{K} - \lambda} \\ \hat{u} &= -\frac{1}{\lambda} \frac{\hat{f}}{1 - 2\pi\hat{K}/\lambda} \end{aligned}$$

For  $|\lambda| > |2\pi\hat{K}|$  we can expand the denominator in a geometric series.

$$\hat{u} = -\frac{1}{\lambda} \hat{f} \sum_{n=0}^{\infty} \left(\frac{2\pi\hat{K}}{\lambda}\right)^n$$

$$u = -\frac{1}{\lambda} \sum_{n=0}^{\infty} \frac{1}{\lambda^n} \int_{-\infty}^{\infty} K_n(x - y) f(y) \, dy$$

Here  $K_n$  is the  $n^{\text{th}}$  iterated kernel. Now we form the Neumann series expansion.

$$\begin{aligned}
 u &= (T - \lambda I)^{-1} f \\
 &= -\frac{1}{\lambda} \left( I - \frac{1}{\lambda} T \right)^{-1} f \\
 &= -\frac{1}{\lambda} \sum_{n=0}^{\infty} \frac{1}{\lambda^n} T^n f \\
 &= -\frac{1}{\lambda} \sum_{n=0}^{\infty} \frac{1}{\lambda^n} T^n f \\
 &= -\frac{1}{\lambda} \sum_{n=0}^{\infty} \frac{1}{\lambda^n} \int_{-\infty}^{\infty} K_n(x-y) f(y) \, dy
 \end{aligned}$$

The Neumann series is the same as the series we derived with the Fourier transform.

### Solution 48.22

We seek a transformation  $T$  such that

$$(L - \lambda I)Tf = f.$$

We denote  $u = Tf$  to obtain a boundary value problem,

$$u'' - \lambda u = f, \quad u(-1) = u(1) = 0.$$

This problem has a unique solution if and only if the homogeneous adjoint problem has only the trivial solution.

$$u'' - \lambda u = 0, \quad u(-1) = u(1) = 0.$$

This homogeneous problem has the eigenvalues and eigenfunctions,

$$\lambda_n = -\left(\frac{n\pi}{2}\right)^2, \quad u_n = \sin\left(\frac{n\pi}{2}(x+1)\right), \quad n \in \mathbb{N}.$$

The inhomogeneous problem has the unique solution

$$u(x) = \int_{-1}^1 G(x, \xi; \lambda) f(\xi) d\xi$$

where

$$G(x, \xi; \lambda) = \begin{cases} -\frac{\sin(\sqrt{-\lambda}(x_{<}+1)) \sin(\sqrt{-\lambda}(1-x_{>}))}{\sqrt{-\lambda} \sin(2\sqrt{-\lambda})}, & \lambda < 0, \\ -\frac{1}{2}(x_{<}+1)(1-x_{>}), & \lambda = 0, \\ -\frac{\sinh(\sqrt{\lambda}(x_{<}+1)) \sinh(\sqrt{\lambda}(1-x_{>}))}{\sqrt{\lambda} \sinh(2\sqrt{\lambda})}, & \lambda > 0, \end{cases}$$

for  $\lambda \neq -(n\pi/2)^2$ ,  $n \in \mathbb{N}$ . We set

$$Tf = \int_{-1}^1 G(x, \xi; \lambda) f(\xi) d\xi$$

and note that since the kernel is continuous this is a bounded linear transformation. If  $f \in W$ , then

$$\begin{aligned} (L - \lambda I)Tf &= (L - \lambda I) \int_{-1}^1 G(x, \xi; \lambda) f(\xi) d\xi \\ &= \int_{-1}^1 (L - \lambda I)[G(x, \xi; \lambda)] f(\xi) d\xi \\ &= \int_{-1}^1 \delta(x - \xi) f(\xi) d\xi \\ &= f(x). \end{aligned}$$

If  $f \in U$  then

$$\begin{aligned}
 T(L - \lambda I)f &= \int_{-1}^1 G(x, \xi; \lambda)(f''(\xi) - \lambda f(\xi)) \, d\xi \\
 &= [G(x, \xi; \lambda)f'(\xi)]_{-1}^1 - \int_{-1}^1 G'(x, \xi; \lambda)f'(\xi) \, d\xi - \lambda \int_{-1}^1 G(x, \xi; \lambda)f(\xi) \, d\xi \\
 &= [-G'(x, \xi; \lambda)f(\xi)]_{-1}^1 + \int_{-1}^1 G''(x, \xi; \lambda)f(\xi) \, d\xi - \lambda \int_{-1}^1 G(x, \xi; \lambda)f(\xi) \, d\xi \\
 &= \int_{-1}^1 (G''(x, \xi; \lambda) - \lambda G(x, \xi; \lambda))f(\xi) \, d\xi \\
 &= \int_{-1}^1 \delta(x - \xi)f(\xi) \, d\xi \\
 &= f(x).
 \end{aligned}$$

$L$  has the point spectrum  $\lambda_n = -(n\pi/2)^2$ ,  $n \in \mathbb{N}$ .

### Solution 48.23

1. We see that the solution is of the form  $\phi(x) = a + x + bx^2$  for some constants  $a$  and  $b$ . We substitute this into the integral equation.

$$\begin{aligned}
 \phi(x) &= x + \lambda \int_0^1 (x^2y - y^2) \phi(y) \, dy \\
 a + x + bx^2 &= x + \lambda \int_0^1 (x^2y - y^2) (a + x + bx^2) \, dy \\
 a + bx^2 &= \frac{\lambda}{60} (-(15 + 20a + 12b) + (20 + 30a + 15b)x^2)
 \end{aligned}$$

By equating the coefficients of  $x^0$  and  $x^2$  we solve for  $a$  and  $b$ .

$$a = -\frac{\lambda(\lambda + 60)}{4(\lambda^2 + 5\lambda + 60)}, \quad b = -\frac{5\lambda(\lambda - 60)}{6(\lambda^2 + 5\lambda + 60)}$$

Thus the solution of the integral equation is

$$\phi(x) = x - \frac{\lambda}{\lambda^2 + 5\lambda + 60} \left( \frac{5(\lambda - 24)}{6} x^2 + \frac{\lambda + 60}{4} \right).$$

2. For  $x < 1$  the integral equation reduces to

$$\phi(x) = x.$$

For  $x \geq 1$  the integral equation becomes,

$$\phi(x) = x + \lambda \int_0^1 \sin(xy) \phi(y) dy.$$

We could solve this problem by writing down the Neumann series. Instead we will use an eigenfunction expansion. Let  $\{\lambda_n\}$  and  $\{\phi_n\}$  be the eigenvalues and orthonormal eigenfunctions of

$$\phi(x) = \lambda \int_0^1 \sin(xy) \phi(y) dy.$$

We expand  $\phi(x)$  and  $x$  in terms of the eigenfunctions.

$$\begin{aligned} \phi(x) &= \sum_{n=1}^{\infty} a_n \phi_n(x) \\ x &= \sum_{n=1}^{\infty} b_n \phi_n(x), \quad b_n = \langle x, \phi_n(x) \rangle \end{aligned}$$

We determine the coefficients  $a_n$  by substituting the series expansions into the Fredholm equation and equating

coefficients of the eigenfunctions.

$$\begin{aligned}\phi(x) &= x + \lambda \int_0^1 \sin(xy)\phi(y) dy \\ \sum_{n=1}^{\infty} a_n \phi_n(x) &= \sum_{n=1}^{\infty} b_n \phi_n(x) + \lambda \int_0^1 \sin(xy) \sum_{n=1}^{\infty} a_n \phi_n(y) dy \\ \sum_{n=1}^{\infty} a_n \phi_n(x) &= \sum_{n=1}^{\infty} b_n \phi_n(x) + \lambda \sum_{n=1}^{\infty} a_n \frac{1}{\lambda_n} \phi_n(x) \\ a_n \left(1 - \frac{\lambda}{\lambda_n}\right) &= b_n\end{aligned}$$

If  $\lambda$  is not an eigenvalue then we can solve for the  $a_n$  to obtain the unique solution.

$$a_n = \frac{b_n}{1 - \lambda/\lambda_n} = \frac{\lambda_n b_n}{\lambda_n - \lambda} = b_n + \frac{\lambda b_n}{\lambda_n - \lambda}$$

$$\phi(x) = x + \sum_{n=1}^{\infty} \frac{\lambda b_n}{\lambda_n - \lambda} \phi_n(x), \quad \text{for } x \geq 1.$$

If  $\lambda = \lambda_m$ , and  $\langle x, \phi_m \rangle = 0$  then there is the one parameter family of solutions,

$$\phi(x) = x + c\phi_m(x) + \sum_{\substack{n=1 \\ n \neq m}}^{\infty} \frac{\lambda b_n}{\lambda_n - \lambda} \phi_n(x), \quad \text{for } x \geq 1.$$

If  $\lambda = \lambda_m$ , and  $\langle x, \phi_m \rangle \neq 0$  then there is no solution.

### Solution 48.24

1.

$$Kx = L_1 L_2 x = \lambda x$$

$$\begin{aligned}
L_1 L_2(L_1 x) &= L_1(L_1 b_2 - I)x \\
&= L_1(\lambda x - x) \\
&= (\lambda - 1)(L_1 x)
\end{aligned}$$

$$\begin{aligned}
L_1 L_2(L_2 x) &= (L_2 L_1 + I)L_2 x \\
&= L_2 \lambda x + L_2 x \\
&= (\lambda + 1)(L_2 x)
\end{aligned}$$

2.

$$\begin{aligned}
L_1 L_2 - L_2 L_1 &= \left(\frac{d}{dt} + \frac{t}{2}\right) \left(-\frac{d}{dt} + \frac{t}{2}\right) - \left(-\frac{d}{dt} + \frac{t}{2}\right) \left(\frac{d}{dt} + \frac{t}{2}\right) \\
&= -\frac{d}{dt} + \frac{t}{2} \frac{d}{dt} + \frac{1}{2}I - \frac{t}{2} \frac{d}{dt} + \frac{t^2}{4}I - \left(-\frac{d}{dt} - \frac{t}{2} \frac{d}{dt} - \frac{1}{2}I + \frac{t}{2} \frac{d}{dt} + \frac{t^2}{4}I\right) \\
&= I
\end{aligned}$$

$$L_1 L_2 = -\frac{d}{dt} + \frac{1}{2}I + \frac{t^2}{4}I = K + \frac{1}{2}I$$

We note that  $e^{-t^2/4}$  is an eigenfunction corresponding to the eigenvalue  $\lambda = 1/2$ . Since  $L_1 e^{-t^2/4} = 0$  the result of this problem does not produce any negative eigenvalues. However,  $L_2^n e^{-t^2/4}$  is the product of  $e^{-t^2/4}$  and a polynomial of degree  $n$  in  $t$ . Since this function is square integrable it is an eigenfunction. Thus we have the eigenvalues and eigenfunctions,

$$\lambda_n = n - \frac{1}{2}, \quad \phi_n = \left(\frac{t}{2} - \frac{d}{dt}\right)^{n-1} e^{-t^2/4}, \quad \text{for } n \in \mathbb{N}.$$

### Solution 48.25

Since  $\lambda_1$  is in the residual spectrum of  $T$ , there exists a nonzero  $y$  such that

$$\langle (T - \lambda_1 I)x, y \rangle = 0$$



for all  $x$ . Now we apply the definition of the adjoint.

$$\langle x, (T - \lambda_1 I)^* y \rangle = 0, \quad \forall x$$

$$\langle x, (T^* - \overline{\lambda_1} I) y \rangle = 0, \quad \forall x$$

$$(T^* - \overline{\lambda_1} I) y = 0$$

$y$  is an eigenfunction of  $T^*$  corresponding to the eigenvalue  $\overline{\lambda_1}$ .

### Solution 48.26

1.

$$u''(t) + \int_0^1 \sin(k(s-t))u(s) ds = f(t), \quad u(0) = u'(0) = 0$$

$$u''(t) + \cos(kt) \int_0^1 \sin(ks)u(s) ds - \sin(kt) \int_0^1 \cos(ks)u(s) ds = f(t)$$

$$u''(t) + c_1 \cos(kt) - c_2 \sin(kt) = f(t)$$

$$u''(t) = f(t) - c_1 \cos(kt) + c_2 \sin(kt)$$

The solution of

$$u''(t) = g(t), \quad u(0) = u'(0) = 0$$

using Green functions is

$$u(t) = \int_0^t (t - \tau)g(\tau) d\tau.$$

Thus the solution of our problem has the form,

$$u(t) = \int_0^t (t - \tau)f(\tau) d\tau - c_1 \int_0^t (t - \tau) \cos(k\tau) d\tau + c_2 \int_0^t (t - \tau) \sin(k\tau) d\tau$$

$$u(t) = \int_0^t (t - \tau)f(\tau) d\tau - c_1 \frac{1 - \cos(kt)}{k^2} + c_2 \frac{kt - \sin(kt)}{k^2}$$

We could determine the constants by multiplying in turn by  $\cos(kt)$  and  $\sin(kt)$  and integrating from 0 to 1. This would yield a set of two linear equations for  $c_1$  and  $c_2$ .

2.

$$u(x) = \lambda \int_0^\pi \sum_{n=1}^{\infty} \frac{\sin nx \sin ns}{n} u(s) ds$$

We expand  $u(x)$  in a sine series.

$$\begin{aligned} \sum_{n=1}^{\infty} a_n \sin nx &= \lambda \int_0^\pi \left( \sum_{n=1}^{\infty} \frac{\sin nx \sin ns}{n} \right) \left( \sum_{m=1}^{\infty} a_m \sin ms \right) ds \\ \sum_{n=1}^{\infty} a_n \sin nx &= \lambda \sum_{n=1}^{\infty} \frac{\sin nx}{n} \sum_{m=1}^{\infty} \int_0^\pi a_m \sin ns \sin ms ds \\ \sum_{n=1}^{\infty} a_n \sin nx &= \lambda \sum_{n=1}^{\infty} \frac{\sin nx}{n} \sum_{m=1}^{\infty} \frac{\pi}{2} a_m \delta_{mn} \\ \sum_{n=1}^{\infty} a_n \sin nx &= \frac{\pi}{2} \lambda \sum_{n=1}^{\infty} a_n \frac{\sin nx}{n} \end{aligned}$$

The eigenvalues and eigenfunctions are

$$\lambda_n = \frac{2n}{\pi}, \quad u_n = \sin nx, \quad n \in \mathbb{N}.$$

3.

$$\phi(\theta) = \lambda \int_0^{2\pi} \frac{1}{2\pi} \frac{1-r^2}{1-2r \cos(\theta-t) + r^2} \phi(t) dt, \quad |r| < 1$$

We use Poisson's formula.

$$\phi(\theta) = \lambda u(r, \theta),$$

where  $u(r, \theta)$  is harmonic in the unit disk and satisfies,  $u(1, \theta) = \phi(\theta)$ . For a solution we need  $\lambda = 1$  and that  $u(r, \theta)$  is independent of  $r$ . In this case  $u(\theta)$  satisfies

$$u''(\theta) = 0, \quad u(\theta) = \phi(\theta).$$

The solution is  $\phi(\theta) = c_1 + c_2\theta$ . There is only one eigenvalue and corresponding eigenfunction,

$$\boxed{\lambda = 1, \quad \phi = c_1 + c_2\theta.}$$

4.

$$\phi(x) = \lambda \int_{-\pi}^{\pi} \cos^n(x - \xi) \phi(\xi) d\xi$$

We expand the kernel in a Fourier series. We could find the expansion by integrating to find the Fourier coefficients, but it is easier to expand  $\cos^n(x)$  directly.

$$\begin{aligned} \cos^n(x) &= \left[ \frac{1}{2} (e^{ix} + e^{-ix}) \right]^n \\ &= \frac{1}{2^n} \left[ \binom{n}{0} e^{inx} + \binom{n}{1} e^{i(n-2)x} + \dots + \binom{n}{n-1} e^{-i(n-2)x} + \binom{n}{n} e^{-inx} \right] \end{aligned}$$

If  $n$  is odd,

$$\begin{aligned}\cos^n(x) &= \frac{1}{2^n} \left[ \binom{n}{0} (e^{inx} + e^{-inx}) + \binom{n}{1} (e^{i(n-2)x} + e^{-i(n-2)x}) + \dots \right. \\ &\quad \left. + \binom{n}{(n-1)/2} (e^{ix} + e^{-ix}) \right] \\ &= \frac{1}{2^n} \left[ \binom{n}{0} 2 \cos(nx) + \binom{n}{1} 2 \cos((n-2)x) + \dots + \binom{n}{(n-1)/2} 2 \cos(x) \right] \\ &= \frac{1}{2^{n-1}} \sum_{m=0}^{(n-1)/2} \binom{n}{m} \cos((n-2m)x) \\ &= \frac{1}{2^{n-1}} \sum_{\substack{k=1 \\ \text{odd } k}}^n \binom{n}{(n-k)/2} \cos(kx).\end{aligned}$$

If  $n$  is even,

$$\begin{aligned}
 \cos^n(x) &= \frac{1}{2^n} \left[ \binom{n}{0} (e^{inx} + e^{-inx}) + \binom{n}{1} (e^{i(n-2)x} + e^{-i(n-2)x}) + \dots \right. \\
 &\quad \left. + \binom{n}{n/2-1} (e^{i2x} + e^{-i2x}) + \binom{n}{n/2} \right] \\
 &= \frac{1}{2^n} \left[ \binom{n}{0} 2 \cos(nx) + \binom{n}{1} 2 \cos((n-2)x) + \dots + \binom{n}{n/2-1} 2 \cos(2x) + \binom{n}{n/2} \right] \\
 &= \frac{1}{2^n} \binom{n}{n/2} + \frac{1}{2^{n-1}} \sum_{m=0}^{(n-2)/2} \binom{n}{m} \cos((n-2m)x) \\
 &= \frac{1}{2^n} \binom{n}{n/2} + \frac{1}{2^{n-1}} \sum_{\substack{k=2 \\ \text{even } k}}^n \binom{n}{(n-k)/2} \cos(kx).
 \end{aligned}$$

We will denote,

$$\cos^n(x - \xi) = \frac{a_0}{2} \sum_{k=1}^n a_k \cos(k(x - \xi)),$$

where

$$a_k = \frac{1 + (-1)^{n-k}}{2} \frac{1}{2^{n-1}} \binom{n}{(n-k)/2}.$$

We substitute this into the integral equation.

$$\begin{aligned}
 \phi(x) &= \lambda \int_{-\pi}^{\pi} \left( \frac{a_0}{2} \sum_{k=1}^n a_k \cos(k(x - \xi)) \right) \phi(\xi) \, d\xi \\
 \phi(x) &= \lambda \frac{a_0}{2} \int_{-\pi}^{\pi} \phi(\xi) \, d\xi + \lambda \sum_{k=1}^n a_k \left( \cos(kx) \int_{-\pi}^{\pi} \cos(k\xi) \phi(\xi) \, d\xi + \sin(kx) \int_{-\pi}^{\pi} \sin(k\xi) \phi(\xi) \, d\xi \right)
 \end{aligned}$$

For even  $n$ , substituting  $\phi(x) = 1$  yields  $\lambda = \frac{1}{\pi a_0}$ . For  $n$  and  $m$  both even or odd, substituting  $\phi(x) = \cos(mx)$  or  $\phi(x) = \sin(mx)$  yields  $\lambda = \frac{1}{\pi a_m}$ . For even  $n$  we have the eigenvalues and eigenvectors,

$$\lambda_0 = \frac{1}{\pi a_0}, \quad \phi_0 = 1,$$

$$\lambda_m = \frac{1}{\pi a_{2m}}, \quad \phi_m^{(1)} = \cos(2mx), \quad \phi_m^{(2)} = \sin(2mx), \quad m = 1, 2, \dots, n/2.$$

For odd  $n$  we have the eigenvalues and eigenvectors,

$$\lambda_m = \frac{1}{\pi a_{2m-1}}, \quad \phi_m^{(1)} = \cos((2m-1)x), \quad \phi_m^{(2)} = \sin((2m-1)x), \quad m = 1, 2, \dots, (n+1)/2.$$

### Solution 48.27

1. First we shift the range of integration to rewrite the kernel.

$$\phi(x) = \lambda \int_0^{2\pi} (2\pi^2 - 6\pi|x-s| + 3(x-s)^2) \phi(s) ds$$

$$\phi(x) = \lambda \int_{-x}^{-x+2\pi} (2\pi^2 - 6\pi|y| + 3y^2) \phi(x+y) dy$$

We expand the kernel in a Fourier series.

$$K(y) = 2\pi^2 - 6\pi|y| + 3y^2 = \sum_{n=-\infty}^{\infty} c_n e^{iny}$$

$$c_n = \frac{1}{2\pi} \int_{-x}^{-x+2\pi} K(y) e^{-iny} dy = \begin{cases} \frac{6}{n^2}, & n \neq 0, \\ 0, & n = 0 \end{cases}$$

$$K(y) = \sum_{\substack{n=-\infty \\ n \neq 0}}^{\infty} \frac{6}{n^2} e^{iny} = \sum_{n=1}^{\infty} \frac{12}{n^2} \cos(ny)$$

$$K(x, s) = \sum_{n=1}^{\infty} \frac{12}{n^2} \cos(n(x-s)) = \sum_{n=1}^{\infty} \frac{12}{n^2} (\cos(nx) \cos(ns) + \sin(nx) \sin(ns))$$

Now we substitute the Fourier series expression for the kernel into the eigenvalue problem.

$$\phi(x) = 12\lambda \int_0^{2\pi} \left( \sum_{n=1}^{\infty} \frac{1}{n^2} (\cos(nx) \cos(ns) + \sin(nx) \sin(ns)) \right) \phi(s) ds$$

From this we obtain the eigenvalues and eigenfunctions,

$$\lambda_n = \frac{n^2}{12\pi}, \quad \phi_n^{(1)} = \frac{1}{\sqrt{\pi}} \cos(nx), \quad \phi_n^{(2)} = \frac{1}{\sqrt{\pi}} \sin(nx), \quad n \in \mathbb{N}.$$

2. The set of eigenfunctions do not form a complete set. Only those functions with a vanishing integral on  $[0, 2\pi]$  can be represented. We consider the equation

$$\int_0^{2\pi} K(x, s) \phi(s) ds = 0$$

$$\int_0^{2\pi} \left( \sum_{n=1}^{\infty} \frac{12}{n^2} (\cos(nx) \cos(ns) + \sin(nx) \sin(ns)) \right) \phi(s) ds = 0$$

This has the solutions  $\phi = \text{const.}$  The set of eigenfunctions

$$\phi_0 = \frac{1}{\sqrt{2\pi}}, \quad \phi_n^{(1)} = \frac{1}{\sqrt{\pi}} \cos(nx), \quad \phi_n^{(2)} = \frac{1}{\sqrt{\pi}} \sin(nx), \quad n \in \mathbb{N},$$

is a complete set. We can also write the eigenfunctions as

$$\phi_n = \frac{1}{\sqrt{2\pi}} e^{inx}, \quad n \in \mathbb{Z}.$$

3. We consider the problem

$$u - \lambda Tu = f.$$

For  $\lambda \neq \lambda_n$  ( $\lambda$  not an eigenvalue), we can obtain a unique solution for  $u$ .

$$u(x) = f(x) + \int_0^{2\pi} \Gamma(x, s, \lambda) f(s) ds$$

Since  $K(x, s)$  is self-adjoint and  $L_2(0, 2\pi)$ , we have

$$\begin{aligned} \Gamma(x, s, \lambda) &= \lambda \sum_{\substack{n=-\infty \\ n \neq 0}}^{\infty} \frac{\phi_n(x) \overline{\phi_n(s)}}{\lambda_n - \lambda} \\ &= \lambda \sum_{\substack{n=-\infty \\ n \neq 0}}^{\infty} \frac{\frac{1}{2\pi} e^{inx} e^{-ins}}{\frac{n^2}{12\pi} - \lambda} \\ &= 6\lambda \sum_{\substack{n=-\infty \\ n \neq 0}}^{\infty} \frac{e^{in(x-s)}}{n^2 - 12\pi\lambda} \end{aligned}$$

$$\Gamma(x, s, \lambda) = 12\lambda \sum_{n=1}^{\infty} \frac{\cos(n(x-s))}{n^2 - 12\pi\lambda}$$

### Solution 48.28

First assume that  $\lambda$  is an eigenvalue of  $T$ ,  $T\phi = \lambda\phi$ .

$$\begin{aligned} p(T)\phi &= \sum_{k=0}^n a_k T^k \phi \\ &= \sum_{k=0}^n a_k \lambda^k \phi \\ &= p(\lambda)\phi \end{aligned}$$



$p(\lambda)$  is an eigenvalue of  $p(T)$ .

Now assume that  $\mu$  is an eigenvalue of  $p(T)$ ,  $p(T)\phi = \mu\phi$ . We assume that  $T$  has a complete, orthonormal set of eigenfunctions,  $\{\phi_n\}$  corresponding to the set of eigenvalues  $\{\lambda_n\}$ . We expand  $\phi$  in these eigenfunctions.

$$\begin{aligned} p(T)\phi &= \mu\phi \\ p(T) \sum c_n \phi_n &= \mu \sum c_n \phi_n \\ \sum c_n p(\lambda_n) \phi_n &= \sum c_n \mu \phi_n \\ p(\lambda_n) &= \mu, \quad \forall n \text{ such that } c_n \neq 0 \end{aligned}$$

Thus all eigenvalues of  $p(T)$  are of the form  $p(\lambda)$  with  $\lambda$  an eigenvalue of  $T$ .

### Solution 48.29

The Fourier cosine transform is defined,

$$\begin{aligned} \hat{f}(\omega) &= \frac{1}{\pi} \int_0^{\infty} f(x) \cos(\omega x) dx, \\ f(x) &= 2 \int_0^{\infty} \hat{f}(\omega) \cos(\omega x) d\omega. \end{aligned}$$

We can write the integral equation in terms of the Fourier cosine transform.

$$\phi(x) = f(x) + \lambda \int_0^{\infty} \cos(2xs)\phi(s) ds$$

$$\phi(x) = f(x) + \lambda\pi\hat{\phi}(2x) \tag{48.8}$$

We multiply the integral equation by  $\frac{1}{\pi} \cos(2xs)$  and integrate.

$$\begin{aligned} \frac{1}{\pi} \int_0^\infty \cos(2xs) \phi(x) dx &= \frac{1}{\pi} \int_0^\infty \cos(2xs) f(x) dx + \lambda \int_0^\infty \cos(2xs) \hat{\phi}(2x) dx \\ \hat{\phi}(2s) &= \hat{f}(2s) + \frac{\lambda}{2} \int_0^\infty \cos(xs) \hat{\phi}(x) dx \\ \hat{\phi}(2s) &= \hat{f}(2s) + \frac{\lambda}{4} \phi(s) \end{aligned}$$

$$\phi(x) = -\frac{4}{\lambda} \hat{f}(2x) + \frac{4}{\lambda} \hat{\phi}(2x) \quad (48.9)$$

We eliminate  $\hat{\phi}$  between (48.8) and (48.9).

$$\left(1 - \frac{\pi\lambda^2}{4}\right) \phi(x) = f(x) + \lambda\pi\hat{f}(2x)$$

$$\boxed{\phi(x) = \frac{f(x) + \lambda \int_0^\infty f(s) \cos(2xs) ds}{1 - \pi\lambda^2/4}}$$

### Solution 48.30

$$\begin{aligned} \int_D vLu dx dy &= \int_D v(u_{xx} + u_{yy} + au_x + bu_y + cu) dx dy \\ &= \int_D (v\nabla^2 u + avu_x + bvu_y + cuv) dx dy \\ &= \int_D (u\nabla^2 v + avu_x + bvu_y + cuv) dx dy + \int_C (v\nabla u - u\nabla v) \cdot n ds \\ &= \int_D (u\nabla^2 v - auv_x - buv_y - uva_x - uvb_y + cuv) dx dy + \int_C \left(auv \frac{\partial x}{\partial n} + buv \frac{\partial y}{\partial n}\right) ds + \int_C \left(v \frac{\partial u}{\partial n} - u \frac{\partial v}{\partial n}\right) ds \end{aligned}$$

Thus we see that

$$\int_D (vLu - uL^*v) \, dx \, dy = \int_C H(u, v) \, ds,$$

where

$$L^*v = v_{xx} + v_{yy} - av_x - bv_y + (c - a_x - b_y)v$$

and

$$H(u, v) = \left( v \frac{\partial u}{\partial n} - u \frac{\partial v}{\partial n} + avv \frac{\partial x}{\partial n} + buv \frac{\partial y}{\partial n} \right).$$

Let  $G$  be the harmonic Green function, which satisfies,

$$\Delta G = \delta \text{ in } D, \quad G = 0 \text{ on } C.$$

Let  $u$  satisfy  $Lu = 0$ .

$$\begin{aligned} \int_D (GLu - uL^*G) \, dx \, dy &= \int_C H(u, G) \, ds \\ - \int_D uL^*G \, dx \, dy &= \int_C H(u, G) \, ds \\ - \int_D u\Delta G \, dx \, dy - \int_D u(L^* - \Delta)G \, dx \, dy &= \int_C H(u, G) \, ds \\ - \int_D u\delta(x - \xi)\delta(y - \eta) \, dx \, dy - \int_D u(L^* - \Delta)G \, dx \, dy &= \int_C H(u, G) \, ds \\ -u(\xi, \eta) - \int_D u(L^* - \Delta)G \, dx \, dy &= \int_C H(u, G) \, ds \end{aligned}$$

We expand the operators to obtain the first form.

$$u + \int_D u(-aG_x - bG_y + (c - a_x - b_y)G) dx dy = - \int_C \left( G \frac{\partial u}{\partial n} - u \frac{\partial G}{\partial n} + auG \frac{\partial x}{\partial n} + buG \frac{\partial y}{\partial n} \right) ds$$

$$u + \int_D ((c - a_x - b_y)G - aG_x - bG_y)u dx dy = \int_C u \frac{\partial G}{\partial n} ds$$

$$u + \int_D ((c - a_x - b_y)G - aG_x - bG_y)u dx dy = U$$

Here  $U$  is the harmonic function that satisfies  $U = f$  on  $C$ .

We use integration by parts to obtain the second form.

$$u + \int_D (cuG - a_x uG - b_y uG - auG_x - buG_y) dx dy = U$$

$$u + \int_D (cuG - a_x uG - b_y uG + (au)_x G + (bu)_y G) dx dy - \int_C \left( auG \frac{\partial y}{\partial n} + buG \frac{\partial x}{\partial n} \right) ds = U$$

$$u + \int_D (cuG - a_x uG - b_y uG + a_x uG + au_x G + b_y uG + bu_y G) dx dy = U$$

$$u + \int_D (au_x + bu_y + cu)G dx dy = U$$

### Solution 48.31

1. First we differentiate to obtain a differential equation.

$$\phi(x) = \lambda \int_0^1 \min(x, s)\phi(s) ds = \lambda \left( \int_0^x e^s \phi(s) ds + \int_x^1 e^x \phi(s) ds \right)$$

$$\phi'(x) = \lambda \left( x\phi(x) + \int_x^1 \phi(s) ds - x\phi(x) \right) = \lambda \int_x^1 \phi(s) ds$$

$$\phi''(x) = -\lambda\phi(x)$$

We note that that  $\phi(x)$  satisfies the constraints,

$$\begin{aligned}\phi(0) &= \lambda \int_0^1 0 \cdot \phi(s) \, ds = 0, \\ \phi'(1) &= \lambda \int_1^1 \phi(s) \, ds = 0.\end{aligned}$$

Thus we have the problem,

$$\phi'' + \lambda\phi = 0, \quad \phi(0) = \phi'(1) = 0.$$

The general solution of the differential equation is

$$\phi(x) = \begin{cases} a + bx & \text{for } \lambda = 0 \\ a \cos(\sqrt{\lambda}x) + b \sin(\sqrt{\lambda}x) & \text{for } \lambda > 0 \\ a \cosh(\sqrt{-\lambda}x) + b \sinh(\sqrt{-\lambda}x) & \text{for } \lambda < 0 \end{cases}$$

We see that for  $\lambda = 0$  and  $\lambda < 0$  only the trivial solution satisfies the homogeneous boundary conditions. For positive  $\lambda$  the left boundary condition demands that  $a = 0$ . The right boundary condition is then

$$b\sqrt{\lambda} \cos(\sqrt{\lambda}) = 0$$

The eigenvalues and eigenfunctions are

$$\lambda_n = \left(\frac{(2n-1)\pi}{2}\right)^2, \quad \phi_n(x) = \sin\left(\frac{(2n-1)\pi}{2}x\right), \quad n \in \mathbb{N}$$

2. First we differentiate the integral equation.

$$\begin{aligned}\phi(x) &= \lambda \left( \int_0^x e^s \phi(s) \, ds + \int_x^1 e^x \phi(s) \, ds \right) \\ \phi'(x) &= \lambda \left( e^x \phi(x) + e^x \int_x^1 \phi(s) \, ds - e^x \phi(x) \right) \\ &= \lambda e^x \int_x^1 \phi(s) \, ds \\ \phi''(x) &= \lambda \left( e^x \int_x^1 \phi(s) \, ds - e^x \phi(x) \right)\end{aligned}$$

$\phi(x)$  satisfies the differential equation

$$\phi'' - \phi' + \lambda e^x \phi = 0.$$

We note the boundary conditions,

$$\phi(0) - \phi'(0) = 0, \quad \phi'(1) = 0.$$

In self-adjoint form, the problem is

$$(e^{-x} \phi')' + \lambda \phi = 0, \quad \phi(0) - \phi'(0) = 0, \quad \phi'(1) = 0.$$

The Rayleigh quotient is

$$\begin{aligned}\lambda &= \frac{[-e^{-x} \phi \phi']_0^1 + \int_0^1 e^{-x} (\phi')^2 \, dx}{\int_0^1 \phi^2 \, dx} \\ &= \frac{\phi(0)\phi'(0) + \int_0^1 e^{-x} (\phi')^2 \, dx}{\int_0^1 \phi^2 \, dx} \\ &= \frac{(\phi(0))^2 + \int_0^1 e^{-x} (\phi')^2 \, dx}{\int_0^1 \phi^2 \, dx}\end{aligned}$$

Thus we see that there are only positive eigenvalues. The differential equation has the general solution

$$\phi(x) = e^{x/2} \left( aJ_1 \left( 2\sqrt{\lambda} e^{x/2} \right) + bY_1 \left( 2\sqrt{\lambda} e^{x/2} \right) \right)$$

We define the functions,

$$u(x; \lambda) = e^{x/2} J_1 \left( 2\sqrt{\lambda} e^{x/2} \right), \quad v(x; \lambda) = e^{x/2} Y_1 \left( 2\sqrt{\lambda} e^{x/2} \right).$$

We write the solution to automatically satisfy the right boundary condition,  $\phi'(1) = 0$ ,

$$\phi(x) = v'(1; \lambda)u(x; \lambda) - u'(1; \lambda)v(x; \lambda).$$

We determine the eigenvalues from the left boundary condition,  $\phi(0) - \phi'(0) = 0$ . The first few are

$$\lambda_1 \approx 0.678298$$

$$\lambda_2 \approx 7.27931$$

$$\lambda_3 \approx 24.9302$$

$$\lambda_4 \approx 54.2593$$

$$\lambda_5 \approx 95.3057$$

The eigenfunctions are,

$$\phi_n(x) = v'(1; \lambda_n)u(x; \lambda_n) - u'(1; \lambda_n)v(x; \lambda_n).$$

### Solution 48.32

1. First note that

$$\sin(kx) \sin(lx) = \text{sign}(kl) \sin(ax) \sin(bx)$$

where

$$a = \max(|k|, |l|), \quad b = \min(|k|, |l|).$$

Consider the analytic function,

$$\frac{e^{i(a-b)x} - e^{i(a+b)x}}{2} = \sin(ax) \sin(bx) - i \cos(ax) \sin(bx).$$

$$\begin{aligned}
\int_{-\infty}^{\infty} \frac{\sin(kx) \sin(lx)}{x^2 - z^2} dx &= \text{sign}(kl) \int_{-\infty}^{\infty} \frac{\sin(ax) \sin(bx)}{x^2 - z^2} dx \\
&= \text{sign}(kl) \frac{1}{2z} \int_{-\infty}^{\infty} \left( \frac{\sin(ax) \sin(bx)}{x - z} - \frac{\sin(ax) \sin(bx)}{x + z} \right) dx \\
&= -\pi \text{sign}(kl) \frac{1}{2z} (-\cos(az) \sin(bz) + \cos(-az) \sin(-bz))
\end{aligned}$$

$$\boxed{\int_{-\infty}^{\infty} \frac{\sin(kx) \sin(lx)}{x^2 - z^2} dx = \text{sign}(kl) \frac{\pi}{z} \cos(az) \sin(bz)}$$

2. Consider the analytic function,

$$\frac{e^{i|p|x} - e^{i|q|x}}{x} = \frac{\cos(|p|x) - \cos(|q|x) + i(\sin(|p|x) - \sin(|q|x))}{x}.$$

$$\begin{aligned}
\int_{-\infty}^{\infty} \frac{\cos(px) - \cos(qx)}{x^2} dx &= \int_{-\infty}^{\infty} \frac{\cos(|p|x) - \cos(|q|x)}{x^2} dx \\
&= -\pi \lim_{x \rightarrow 0} \frac{\sin(|p|x) - \sin(|q|x)}{x}
\end{aligned}$$

$$\boxed{\int_{-\infty}^{\infty} \frac{\cos(px) - \cos(qx)}{x^2} dx = \pi(|q| - |p|)}$$

3. We use the analytic function,

$$\frac{i(x - ia)(x - ib) e^{ix}}{(x^2 + a^2)(x^2 + b^2)} = \frac{-(x^2 - ab) \sin x + (a + b)x \cos x + i((x^2 - ab) \cos x + (a + b)x \sin x)}{(x^2 + a^2)(x^2 + b^2)}$$

$$\begin{aligned}
\int_{-\infty}^{\infty} \frac{-(x^2 - ab) \sin x + (a + b)x \cos x}{x(x^2 + a^2)(x^2 + b^2)} dx &= -\pi \lim_{x \rightarrow 0} \frac{(x^2 - ab) \cos x + (a + b)x \sin x}{(x^2 + a^2)(x^2 + b^2)} \\
&= -\pi \frac{-ab}{a^2 b^2}
\end{aligned}$$



$$\boxed{\int_{-\infty}^{\infty} \frac{-(x^2 - ab) \sin x + (a + b)x \cos x}{(x^2 + a^2)(x^2 + b^2)} dx = \frac{\pi}{ab}}$$

### Solution 48.33

We consider the function

$$G(z) = ((1 - z^2)^{1/2} + iz) \log(1 + z).$$

For  $(1 - z^2)^{1/2} = (1 - z)^{1/2}(1 + z)^{1/2}$  we choose the angles,

$$-\pi < \arg(1 - z) < \pi, \quad 0 < \arg(1 + z) < 2\pi,$$

so that there is a branch cut on the interval  $(-1, 1)$ . With this choice of branch,  $G(z)$  vanishes at infinity. For the logarithm we choose the principal branch,

$$-\pi < \arg(1 + z) < \pi.$$

For  $t \in (-1, 1)$ ,

$$G^+(t) = \left( \sqrt{1 - t^2} + it \right) \log(1 + t),$$

$$G^-(t) = \left( -\sqrt{1 - t^2} + it \right) \log(1 + t),$$

$$G^+(t) - G^-(t) = 2\sqrt{1 - t^2} \log(1 + t),$$

$$\frac{1}{2} (G^+(t) + G^-(t)) = it \log(1 + t).$$

For  $t \in (-\infty, -1)$ ,

$$G^+(t) = i \left( \sqrt{1 - t^2} + t \right) (\log(-t - 1) + i\pi),$$

$$G^-(t) = i \left( -\sqrt{1 - t^2} + t \right) (\log(-t - 1) - i\pi),$$

$$G^+(t) - G^-(t) = -2\pi \left( \sqrt{t^2 - 1} + t \right).$$

For  $x \in (-1, 1)$  we have

$$\begin{aligned} G(x) &= \frac{1}{2} (G^+(x) + G^-(x)) \\ &= ix \log(1+x) \\ &= \frac{1}{i2\pi} \int_{-}^{\infty -1} \frac{-2\pi(\sqrt{t^2 - 1} + t)}{t - x} dt + \frac{1}{i2\pi} \int_{-1}^1 \frac{2\sqrt{1 - t^2} \log(1+t)}{t - x} dt \end{aligned}$$

From this we have

$$\begin{aligned} &\int_{-1}^1 \frac{\sqrt{1 - t^2} \log(1+t)}{t - x} dt \\ &= -\pi x \log(1+x) + \pi \int_1^{\infty} \frac{t - \sqrt{t^2 - 1}}{t + x} dt \\ &= \pi \left( x \log(1+x) - 1 + \frac{\pi}{2} \sqrt{1 - x^2} - \sqrt{1 - x^2} \arcsin(x) + x \log(2) + x \log(1+x) \right) \end{aligned}$$

$$\boxed{\int_{-1}^1 \frac{\sqrt{1 - t^2} \log(1+t)}{t - x} dt = \pi \left( x \log x - 1 + \sqrt{1 - x^2} \left( \frac{\pi}{2} - \arcsin(x) \right) \right)}$$

### Solution 48.34

Let  $F(z)$  denote the value of the integral.

$$F(z) = \frac{1}{i\pi} \int_C \frac{f(t) dt}{t - z}$$

From the Plemelj formula we have,

$$\begin{aligned} F^+(t_0) + F^-(t_0) &= \frac{1}{i\pi} \int_C \frac{f(t)}{t - t_0} dt, \\ f(t_0) &= F^+(t_0) - F^-(t_0). \end{aligned}$$

With  $W(z)$  defined as above, we have

$$W^+(t_0) + W^-(t_0) = F^+(t_0) - F^-(t_0) = f(t_0),$$

and also

$$\begin{aligned} W^+(t_0) + W^-(t_0) &= \frac{1}{i\pi} \int_C \frac{W^+(t) - W^-(t)}{t - t_0} dt \\ &= \frac{1}{i\pi} \int_C \frac{F^+(t) + F^-(t)}{t - t_0} dt \\ &= \frac{1}{i\pi} \int_C \frac{g(t)}{t - t_0} dt. \end{aligned}$$

Thus the solution of the integral equation is

$$f(t_0) = \frac{1}{i\pi} \int_C \frac{g(t)}{t - t_0} dt.$$

**Solution 48.35**

(i)

$$G(\tau) = (\tau - \beta)^{-1} \left( \frac{\tau - \beta}{\tau - \alpha} \right)^\gamma$$

$$G^+(\zeta) = (\zeta - \beta)^{-1} \left( \frac{\zeta - \beta}{\zeta - \alpha} \right)^\gamma$$

$$G^-(\zeta) = e^{-i2\pi\gamma} G^+(\zeta)$$

$$G^+(\zeta) - G^-(\zeta) = (1 - e^{-i2\pi\gamma})(\zeta - \beta)^{-1} \left( \frac{\zeta - \beta}{\zeta - \alpha} \right)^\gamma$$

$$G^+(\zeta) + G^-(\zeta) = (1 + e^{-i2\pi\gamma})(\zeta - \beta)^{-1} \left( \frac{\zeta - \beta}{\zeta - \alpha} \right)^\gamma$$

$$G^+(\zeta) + G^-(\zeta) = \frac{1}{i\pi} \int_C \frac{(1 - e^{-i2\pi\gamma}) d\tau}{(\tau - \beta)^{1-\gamma}(\tau - \alpha)^\gamma(\tau - \zeta)}$$

$\frac{1}{i\pi} \int_C \frac{d\tau}{(\tau - \beta)^{1-\gamma}(\tau - \alpha)^\gamma(\tau - \zeta)} = -i \cot(\pi\gamma) \frac{(\zeta - \beta)^{\gamma-1}}{(\zeta - \alpha)^\gamma}$
---

(ii) Consider the branch of

$$\left( \frac{z - \beta}{z - \alpha} \right)^\gamma$$

that tends to unity as  $z \rightarrow \infty$ . We find a series expansion of this function about infinity.

$$\begin{aligned} \left(\frac{z-\beta}{z-\alpha}\right)^\gamma &= \left(1 - \frac{\beta}{z}\right)^\gamma \left(1 - \frac{\alpha}{z}\right)^{-\gamma} \\ &= \left(\sum_{j=0}^{\infty} (-1)^j \binom{\gamma}{j} \left(\frac{\beta}{z}\right)^j\right) \left(\sum_{k=0}^{\infty} (-1)^k \binom{-\gamma}{k} \left(\frac{\alpha}{z}\right)^k\right) \\ &= \sum_{j=0}^{\infty} \left(\sum_{k=0}^j (-1)^j \binom{\gamma}{j-k} \binom{-\gamma}{k} \beta^{j-k} \alpha^k\right) z^{-j} \end{aligned}$$

Define the polynomial

$$Q(z) = \sum_{j=0}^n \left(\sum_{k=0}^j (-1)^j \binom{\gamma}{j-k} \binom{-\gamma}{k} \beta^{j-k} \alpha^k\right) z^{n-j}.$$

Then the function

$$G(z) = \left(\frac{z-\beta}{z-\alpha}\right)^\gamma z^n - Q(z)$$

vanishes at infinity.

$$G^+(\zeta) = \left(\frac{\zeta - \beta}{\zeta - \alpha}\right)^\gamma \zeta^n - Q(\zeta)$$

$$G^-(\zeta) = e^{-i2\pi\gamma} \left(\frac{\zeta - \beta}{\zeta - \alpha}\right)^\gamma \zeta^n - Q(\zeta)$$

$$G^+(\zeta) - G^-(\zeta) = \left(\frac{\zeta - \beta}{\zeta - \alpha}\right)^\gamma \zeta^n (1 - e^{-i2\pi\gamma})$$

$$G^+(\zeta) + G^-(\zeta) = \left(\frac{\zeta - \beta}{\zeta - \alpha}\right)^\gamma \zeta^n (1 + e^{-i2\pi\gamma}) - 2Q(\zeta)$$

$$\frac{1}{i\pi} \int_C \left(\frac{\tau - \beta}{\tau - \alpha}\right)^\gamma \tau^n (1 - e^{-i2\pi\gamma}) \frac{1}{\tau - \zeta} d\tau = \left(\frac{\zeta - \beta}{\zeta - \alpha}\right)^\gamma \zeta^n (1 + e^{-i2\pi\gamma}) - 2Q(\zeta)$$

$$\frac{1}{i\pi} \int_C \left(\frac{\tau - \beta}{\tau - \alpha}\right)^\gamma \frac{\tau^n}{\tau - \zeta} d\tau = -i \cot(\pi\gamma) \left(\frac{\zeta - \beta}{\zeta - \alpha}\right)^\gamma \zeta^n - (1 - i \cot(\pi\gamma))Q(\zeta)$$

$$\boxed{\frac{1}{i\pi} \int_C \left(\frac{\tau - \beta}{\tau - \alpha}\right)^\gamma \frac{\tau^n}{\tau - \zeta} d\tau = -i \cot(\pi\gamma) \left( \left(\frac{\zeta - \beta}{\zeta - \alpha}\right)^\gamma \zeta^n - Q(\zeta) \right) - Q(\zeta)}$$

### Solution 48.36

$$\begin{aligned} \int_{-1}^1 \frac{\phi(y)}{y^2 - x^2} dy &= \frac{1}{2x} \int_{-1}^1 \frac{\phi(y)}{y - x} dy - \frac{1}{2x} \int_{-1}^1 \frac{\phi(y)}{y + x} dy \\ &= \frac{1}{2x} \int_{-1}^1 \frac{\phi(y)}{y - x} dy + \frac{1}{2x} \int_{-1}^1 \frac{\phi(-y)}{y - x} dy \\ &= \frac{1}{2x} \int_{-1}^1 \frac{\phi(y) + \phi(-y)}{y - x} dy \end{aligned}$$

$$\frac{1}{2x} \int_{-1}^1 \frac{\phi(y) + \phi(-y)}{y-x} dy = f(x)$$

$$\frac{1}{i\pi} \int_{-1}^1 \frac{\phi(y) + \phi(-y)}{y-x} dy = \frac{2x}{i\pi} f(x)$$

$$\phi(x) + \phi(-x) = \frac{1}{i\pi\sqrt{1-x^2}} \int_{-1}^1 \frac{2y}{i\pi} f(y) \sqrt{1-y^2} \frac{1}{y-x} dy + \frac{k}{\sqrt{1-x^2}}$$

$$\phi(x) + \phi(-x) = -\frac{1}{\pi^2\sqrt{1-x^2}} \int_{-1}^1 \frac{2yf(y)\sqrt{1-y^2}}{y-x} dy + \frac{k}{\sqrt{1-x^2}}$$

$$\phi(x) = -\frac{1}{\pi^2\sqrt{1-x^2}} \int_{-1}^1 \frac{yf(y)\sqrt{1-y^2}}{y-x} dy + \frac{k}{\sqrt{1-x^2}} + g(x)$$

Here  $k$  is an arbitrary constant and  $g(x)$  is an arbitrary odd function.

### Solution 48.37

We define

$$F(z) = \frac{1}{i2\pi} \int_0^1 \frac{f(t)}{t-z} dt.$$

The Plemelj formulas and the integral equation give us,

$$F^+(x) - F^-(x) = f(x)$$

$$F^+(x) + F^-(x) = \lambda f(x).$$

We solve for  $F^+$  and  $F^-$ .

$$F^+(x) = (\lambda + 1)f(x)$$

$$F^-(x) = (\lambda - 1)f(x)$$

By writing

$$\frac{F^+(x)}{F^-(x)} = \frac{\lambda + 1}{\lambda - 1}$$

we seek to determine  $F$  to within a multiplicative constant.

$$\begin{aligned}\log F^+(x) - \log F^-(x) &= \log \left( \frac{\lambda + 1}{\lambda - 1} \right) \\ \log F^+(x) - \log F^-(x) &= \log \left( \frac{1 + \lambda}{1 - \lambda} \right) + i\pi \\ \log F^+(x) - \log F^-(x) &= \gamma + i\pi\end{aligned}$$

We have left off the additive term of  $i2\pi n$  in the above equation, which will introduce factors of  $z^k$  and  $(z - 1)^m$  in  $F(z)$ . We will choose these factors so that  $F(z)$  has integrable algebraic singularities and vanishes at infinity. Note that we have defined  $\gamma$  to be the real parameter,

$$\gamma = \log \left( \frac{1 + \lambda}{1 - \lambda} \right).$$

By the discontinuity theorem,

$$\begin{aligned}\log F(z) &= \frac{1}{i2\pi} \int_0^1 \frac{\gamma + i\pi}{t - z} dz \\ &= \left( \frac{1}{2} - i\frac{\gamma}{2\pi} \right) \log \left( \frac{1 - z}{-z} \right) \\ &= \log \left( \left( \frac{z - 1}{z} \right)^{1/2 - i\gamma/(2\pi)} \right)\end{aligned}$$



$$F(z) = \left( \frac{z-1}{z} \right)^{1/2 - i\gamma/(2\pi)} z^k (z-1)^m$$

$$F(z) = \frac{1}{\sqrt{z(z-1)}} \left( \frac{z-1}{z} \right)^{-i\gamma/(2\pi)}$$

$$F^\pm(x) = \frac{e^{\pm i\pi(-i\gamma/(2\pi))}}{\sqrt{x(1-x)}} \left( \frac{1-x}{x} \right)^{-i\gamma/(2\pi)}$$

$$F^\pm(x) = \frac{e^{\pm\gamma/2}}{\sqrt{x(1-x)}} \left( \frac{1-x}{x} \right)^{-i\gamma/(2\pi)}$$

Define

$$f(x) = \frac{1}{\sqrt{x(1-x)}} \left( \frac{1-x}{x} \right)^{-i\gamma/(2\pi)} .$$

We apply the Plemelj formulas.

$$\frac{1}{i\pi} \int_0^1 (e^{\gamma/2} - e^{-\gamma/2}) \frac{f(t)}{t-x} dt = (e^{\gamma/2} + e^{-\gamma/2}) f(x)$$

$$\frac{1}{i\pi} \int_0^1 \frac{f(t)}{t-x} dt = \tanh\left(\frac{\gamma}{2}\right) f(x)$$

Thus we see that the eigenfunctions are

$$\boxed{\phi(x) = \frac{1}{\sqrt{x(1-x)}} \left( \frac{1-x}{x} \right)^{-i \tanh^{-1}(\lambda)/\pi}}$$

for  $-1 < \lambda < 1$ .

The method used in this problem cannot be used to construct eigenfunctions for  $\lambda > 1$ . For this case we cannot find an  $F(z)$  that has integrable algebraic singularities and vanishes at infinity.

### Solution 48.38

$$\frac{1}{i\pi} \int_0^1 \frac{f(t)}{t-x} dt = -\frac{i}{\tan(x)} f(x)$$

We define the function,

$$F(z) = \frac{1}{i2\pi} \int_0^1 \frac{f(t)}{t-z} dt.$$

The Plemelj formula are,

$$\begin{aligned} F^+(x) - F^-(x) &= f(x) \\ F^+(x) + F^-(x) &= -\frac{i}{\tan(x)} f(x). \end{aligned}$$

We solve for  $F^+$  and  $F^-$ .

$$F^\pm(x) = \frac{1}{2} \left( \pm 1 - \frac{i}{\tan(x)} \right) f(x)$$

From this we see

$$\frac{F^+(x)}{F^-(x)} = \frac{1 - i/\tan(x)}{-1 - i/\tan(x)} = e^{i2x}.$$

We seek to determine  $F(z)$  up to a multiplicative constant. Taking the logarithm of this equation yields

$$\log F^+(x) - \log F^-(x) = i2x + i2\pi n.$$

The  $i2\pi n$  term will give us the factors  $(z-1)^k$  and  $z^m$  in the solution for  $F(z)$ . We will choose the integers  $k$  and  $m$  so that  $F(z)$  has only algebraic singularities and vanishes at infinity. We drop the  $i2\pi n$  term for now.

$$\begin{aligned} \log F(z) &= \frac{1}{i2\pi} \int_0^1 \frac{i2t}{t-z} dt \\ \log F(z) &= \frac{1}{\pi} + \frac{z}{\pi} \log \left( \frac{1-z}{-z} \right) F(z) = e^{1/\pi} \left( \frac{z-1}{z} \right)^{z/\pi} \end{aligned}$$

We replace  $e^{1/\pi}$  by a multiplicative constant and multiply by  $(z - 1)^1$  to give  $F(z)$  the desired properties.

$$F(z) = \frac{c}{(z - 1)^{1-z/\pi} z^{z/\pi}}$$

We evaluate  $F(z)$  above and below the branch cut.

$$F^\pm(x) = \frac{c}{e^{\pm(i\pi - ix)}(1 - x)^{1-x/\pi} x^{x/\pi}} = \frac{c e^{\pm ix}}{(1 - x)^{1-x/\pi} x^{x/\pi}}$$

Finally we use the Plemelj formulas to determine  $f(x)$ .

$$f(x) = F^+(x) - F^-(x) = \frac{k \sin(x)}{(1 - x)^{1-x/\pi} x^{x/\pi}}$$

### Solution 48.39

Consider the equation,

$$f'(z) + \lambda \int_C \frac{f(t)}{t - z} dt = 1.$$

Since the integral is an analytic function of  $z$  off  $C$  we know that  $f(z)$  is analytic off  $C$ . We use Cauchy's theorem to evaluate the integral and obtain a differential equation for  $f(x)$ .

$$f'(x) + \lambda \int_C \frac{f(t)}{t - x} dt = 1$$

$$f'(x) + i\lambda\pi f(x) = 1$$

$$f(x) = \frac{1}{i\lambda\pi} + c e^{-i\lambda\pi x}$$

Consider the equation,

$$f'(z) + \lambda \int_C \frac{f(t)}{t - z} dt = g(z).$$

Since the integral and  $g(z)$  are analytic functions inside  $C$  we know that  $f(z)$  is analytic inside  $C$ . We use Cauchy's theorem to evaluate the integral and obtain a differential equation for  $f(x)$ .

$$f'(x) + \lambda \oint_C \frac{f(t)}{t-x} dt = g(x)$$

$$f'(x) + i\lambda\pi f(x) = g(x)$$

$$f(x) = \int_{z_0}^x e^{-i\lambda\pi(x-\xi)} g(\xi) d\xi + c e^{-i\lambda\pi x}$$

Here  $z_0$  is any point inside  $C$ .

### Solution 48.40

$$\oint_C \left( \frac{1}{t-x} + P(t-x) \right) f(t) dt = g(x)$$

$$\frac{1}{i\pi} \oint_C \frac{f(t)}{t-x} dt = \frac{1}{i\pi} g(x) - \frac{1}{i\pi} \int_C P(t-x) f(t) dt$$

We know that if

$$\frac{1}{i\pi} \oint_C \frac{f(\tau)}{\tau-\zeta} d\tau = g(\zeta)$$

then

$$f(\zeta) = \frac{1}{i\pi} \oint_C \frac{g(\tau)}{\tau-\zeta} d\tau.$$

We apply this theorem to the integral equation.

$$\begin{aligned}
 f(x) &= -\frac{1}{\pi^2} \int_C \frac{g(t)}{t-x} dt + \frac{1}{\pi^2} \int_C \left( \int_C P(\tau-t)f(\tau) d\tau \right) \frac{1}{t-x} dt \\
 &= -\frac{1}{\pi^2} \int_C \frac{g(t)}{t-x} dt + \frac{1}{\pi^2} \int_C \left( \int_C \frac{P(\tau-t)}{t-x} dt \right) f(\tau) d\tau \\
 &= -\frac{1}{\pi^2} \int_C \frac{g(t)}{t-x} dt - \frac{1}{i\pi} \int_C P(t-x)f(t) dt
 \end{aligned}$$

Now we substitute the non-analytic part of  $f(t)$  into the integral. (The analytic part integrates to zero.)

$$\begin{aligned}
 &= -\frac{1}{\pi^2} \int_C \frac{g(t)}{t-x} dt - \frac{1}{i\pi} \int_C P(t-x) \left( -\frac{1}{\pi^2} \int_C \frac{g(\tau)}{\tau-t} d\tau \right) dt \\
 &= -\frac{1}{\pi^2} \int_C \frac{g(t)}{t-x} dt - \frac{1}{\pi^2} \int_C \left( -\frac{1}{i\pi} \int_C \frac{P(t-x)}{\tau-t} dt \right) g(\tau) d\tau \\
 &= -\frac{1}{\pi^2} \int_C \frac{g(t)}{t-x} dt - \frac{1}{\pi^2} \int_C P(\tau-x)g(\tau) d\tau
 \end{aligned}$$

$$\boxed{f(x) = -\frac{1}{\pi^2} \int_C \frac{g(t)}{t-x} dt - \frac{1}{\pi^2} \int_C P(t-x)g(t) dt}$$

**Solution 48.41**

**Solution 48.42**

## Part VII

# Nonlinear Differential Equations

# Chapter 49

## Nonlinear Ordinary Differential Equations

## 49.1 Exercises

### Exercise 49.1

A model set of equations to describe an epidemic, in which  $x(t)$  is the number infected,  $y(t)$  is the number susceptible, is

$$\frac{dx}{dt} = rxy - \gamma x, \quad \frac{dy}{dt} = -rxy + \beta,$$

where  $r > 0$ ,  $\beta \geq 0$ ,  $\gamma \geq 0$ . Initially  $x = x_0$ ,  $y = y_0$  at  $t = 0$ . Directly from the equations, without using the phase plane:

1. Find the solution,  $x(t)$ ,  $y(t)$ , in the case  $\beta = \gamma = 0$ .
2. Show for the case  $\beta = 0$ ,  $\gamma \neq 0$  that  $x(t)$  first decreases or increases according as  $ry_0 < \gamma$  or  $ry_0 > \gamma$ . Show that  $x(t) \rightarrow 0$  as  $t \rightarrow \infty$  in both cases. Find  $x$  as a function of  $y$ .
3. In the phase plane: Find the position of the singular point and its type when  $\beta > 0$ ,  $\gamma > 0$ .

### Exercise 49.2

Find the singular points and their types for the system

$$\begin{aligned} \frac{du}{dx} &= ru + v(1-v)(p-v), & r > 0, \quad 0 < p < 1, \\ \frac{dv}{dx} &= u, \end{aligned}$$

which comes from one of our nonlinear diffusion problems. Note that there is a solution with

$$u = \alpha(1-v)$$

for special values of  $\alpha$  and  $r$ . Find  $v(x)$  for this special case.



**Exercise 49.3**

Check that  $r = 1$  is a limit cycle for

$$\begin{aligned}\frac{dx}{dt} &= -y + x(1 - r^2) \\ \frac{dy}{dt} &= x + y(1 - r^2)\end{aligned}$$

( $r = x^2 + y^2$ ), and that all solution curves spiral into it.

**Exercise 49.4**

Consider

$$\begin{aligned}\epsilon \dot{y} &= f(y) - x \\ \dot{x} &= y\end{aligned}$$

Introduce new coordinates,  $R, \theta$  given by

$$\begin{aligned}x &= R \cos \theta \\ y &= \frac{1}{\sqrt{\epsilon}} R \sin \theta\end{aligned}$$

and obtain the exact differential equations for  $R(t), \theta(t)$ . Show that  $R(t)$  continually increases with  $t$  when  $R \neq 0$ . Show that  $\theta(t)$  continually decreases when  $R > 1$ .

**Exercise 49.5**

One choice of the Lorenz equations is

$$\begin{aligned}\dot{x} &= -10x + 10y \\ \dot{y} &= Rx - y - xz \\ \dot{z} &= -\frac{8}{3}z + xy\end{aligned}$$

Where  $R$  is a positive parameter.

1. Investigate the nature of the singular point at  $(0, 0, 0)$  by finding the eigenvalues and their behavior for all  $0 < R < \infty$ .
2. Find the other singular points when  $R > 1$ .
3. Show that the appropriate eigenvalues for these other singular points satisfy the cubic

$$3\lambda^3 + 41\lambda^2 + 8(10 + R)\lambda + 160(R - 1) = 0.$$

4. There is a special value of  $R$ , call it  $R_c$ , for which the cubic has two pure imaginary roots,  $\pm i\mu$  say. Find  $R_c$  and  $\mu$ ; then find the third root.

### Exercise 49.6

In polar coordinates  $(r, \phi)$ , Einstein's equations lead to the equation

$$\frac{d^2v}{d\phi^2} + v = 1 + \epsilon v^2, \quad v = \frac{1}{r},$$

for planetary orbits. For Mercury,  $\epsilon = 8 \times 10^{-8}$ . When  $\epsilon = 0$  (Newtonian theory) the orbit is given by

$$v = 1 + A \cos \phi, \quad \text{period } 2\pi.$$

Introduce  $\theta = \omega\phi$  and use perturbation expansions for  $v(\theta)$  and  $\omega$  in powers of  $\epsilon$  to find the corrections proportional to  $\epsilon$ .

[ $A$  is not small;  $\epsilon$  is the small parameter].

### Exercise 49.7

Consider the problem

$$\ddot{x} + \omega_0^2 x + \alpha x^2 = 0, \quad x = a, \dot{x} = 0 \text{ at } t = 0$$

Use expansions

$$x = a \cos \theta + a^2 x_2(\theta) + a^3 x_3(\theta) + \dots, \quad \theta = \omega t$$

$$\omega = \omega_0 + a^2 \omega_2 + \dots,$$

to find a periodic solution and its natural frequency  $\omega$ .

Note that, with the expansions given, there are no “secular term” troubles in the determination of  $x_2(\theta)$ , but  $x_2(\theta)$  is needed in the subsequent determination of  $x_3(\theta)$  and  $\omega$ .

Show that a term  $a\omega_1$  in the expansion for  $\omega$  would have caused trouble, so  $\omega_1$  would have to be taken equal to zero.

### Exercise 49.8

Consider the linearized traffic problem

$$\begin{aligned}\frac{dp_n(t)}{dt} &= \alpha [p_{n-1}(t) - p_n(t)], \quad n \geq 1, \\ p_n(0) &= 0, \quad n \geq 1, \\ p_0(t) &= ae^{\omega t}, \quad t > 0.\end{aligned}$$

(We take the imaginary part of  $p_n(t)$  in the final answers.)

1. Find  $p_1(t)$  directly from the equation for  $n = 1$  and note the behavior as  $t \rightarrow \infty$ .
2. Find the generating function

$$G(s, t) = \sum_{n=1}^{\infty} p_n(t) s^n.$$

3. Deduce that

$$p_n(t) \sim A_n e^{\omega t}, \quad \text{as } t \rightarrow \infty,$$

and find the expression for  $A_n$ . Find the imaginary part of this  $p_n(t)$ .

### Exercise 49.9

1. For the equation modified with a reaction time, namely

$$\frac{d}{dt} p_n(t + \tau) = \alpha [p_{n-1}(t) - p_n(t)] \quad n \geq 1,$$

find a solution of the form in 1(c) by direct substitution in the equation. Again take its imaginary part.

2. Find a condition that the disturbance is stable, i.e.  $p_n(t)$  remains bounded as  $n \rightarrow \infty$ .
3. In the stable case show that the disturbance is wave-like and find the wave velocity.

## 49.2 Hints

**Hint 49.1**

**Hint 49.2**

**Hint 49.3**

**Hint 49.4**

**Hint 49.5**

**Hint 49.6**

**Hint 49.7**

**Hint 49.8**

**Hint 49.9**

## 49.3 Solutions

### Solution 49.1

1. When  $\beta = \gamma = 0$  the equations are

$$\frac{dx}{dt} = rxy, \quad \frac{dy}{dt} = -rxy.$$

Adding these two equations we see that

$$\frac{dx}{dt} = -\frac{dy}{dt}.$$

Integrating and applying the initial conditions  $x(0) = x_0$  and  $y(0) = y_0$  we obtain

$$x = x_0 + y_0 - y$$

Substituting this into the differential equation for  $y$ ,

$$\begin{aligned} \frac{dy}{dt} &= -r(x_0 + y_0 - y)y \\ \frac{dy}{dt} &= -r(x_0 + y_0)y + ry^2. \end{aligned}$$

We recognize this as a Bernoulli equation and make the substitution  $u = y^{-1}$ .

$$\begin{aligned} -y^{-2} \frac{dy}{dt} &= r(x_0 + y_0)y^{-1} - r \\ \frac{du}{dt} &= r(x_0 + y_0)u - r \\ \frac{d}{dt} (e^{-r(x_0+y_0)t}u) &= -re^{-r(x_0+y_0)t} \\ u &= e^{r(x_0+y_0)t} \int -re^{-r(x_0+y_0)t} dt + ce^{r(x_0+y_0)t} \\ u &= \frac{1}{x_0 + y_0} + ce^{r(x_0+y_0)t} \\ y &= \left( \frac{1}{x_0 + y_0} + ce^{r(x_0+y_0)t} \right)^{-1} \end{aligned}$$

Applying the initial condition for  $y$ ,

$$\begin{aligned} \left( \frac{1}{x_0 + y_0} + c \right)^{-1} &= y_0 \\ c &= \frac{1}{y_0} - \frac{1}{x_0 + y_0}. \end{aligned}$$

The solution for  $y$  is then

$$y = \left[ \frac{1}{x_0 + y_0} + \left( \frac{1}{y_0} - \frac{1}{x_0 + y_0} \right) e^{r(x_0+y_0)t} \right]^{-1}$$

Since  $x = x_0 + y_0 - y$ , the solution to the system of differential equations is

$$\boxed{x = x_0 + y_0 - \left[ \frac{1}{y_0} + \frac{1}{x_0 + y_0} (1 - e^{r(x_0+y_0)t}) \right]^{-1}, \quad y = \left[ \frac{1}{y_0} + \frac{1}{x_0 + y_0} (1 - e^{r(x_0+y_0)t}) \right]^{-1}.}$$

2. For  $\beta = 0$ ,  $\gamma \neq 0$ , the equation for  $x$  is

$$\dot{x} = rxy - \gamma x.$$

At  $t = 0$ ,

$$\dot{x}(0) = x_0(ry_0 - \gamma).$$

Thus we see that if  $ry_0 < \gamma$ ,  $x$  is initially decreasing. If  $ry_0 > \gamma$ ,  $x$  is initially increasing.

Now to show that  $x(t) \rightarrow 0$  as  $t \rightarrow \infty$ . First note that if the initial conditions satisfy  $x_0, y_0 > 0$  then  $x(t), y(t) > 0$  for all  $t \geq 0$  because the axes are a separatrix.  $y(t)$  is a strictly decreasing function of time. Thus we see that at some time the quantity  $x(ry - \gamma)$  will become negative. Since  $y$  is decreasing, this quantity will remain negative. Thus after some time,  $x$  will become a strictly decreasing quantity. Finally we see that regardless of the initial conditions, (as long as they are positive),  $x(t) \rightarrow 0$  as  $t \rightarrow \infty$ .

Taking the ratio of the two differential equations,

$$\begin{aligned}\frac{dx}{dy} &= -1 + \frac{\gamma}{ry}. \\ x &= -y + \frac{\gamma}{r} \ln y + c\end{aligned}$$

Applying the initial condition,

$$\begin{aligned}x_0 &= -y_0 + \frac{\gamma}{r} \ln y_0 + c \\ c &= x_0 + y_0 - \frac{\gamma}{r} \ln y_0.\end{aligned}$$

Thus the solution for  $x$  is

$$x = x_0 + (y_0 - y) + \frac{\gamma}{r} \ln \left( \frac{y}{y_0} \right).$$

3. When  $\beta > 0$  and  $\gamma > 0$  the system of equations is

$$\begin{aligned}\dot{x} &= rxy - \gamma x \\ \dot{y} &= -rxy + \beta.\end{aligned}$$



The equilibrium solutions occur when

$$\begin{aligned}x(ry - \gamma) &= 0 \\ \beta - rxy &= 0.\end{aligned}$$

Thus the singular point is

$$\boxed{x = \frac{\beta}{\gamma}, \quad y = \frac{\gamma}{r}.$$

Now to classify the point. We make the substitution  $u = (x - \frac{\beta}{\gamma})$ ,  $v = (y - \frac{\gamma}{r})$ .

$$\dot{u} = r \left( u + \frac{\beta}{\gamma} \right) \left( v + \frac{\gamma}{r} \right) - \gamma \left( u + \frac{\beta}{\gamma} \right)$$

$$\dot{v} = -r \left( u + \frac{\beta}{\gamma} \right) \left( v + \frac{\gamma}{r} \right) + \beta$$

$$\dot{u} = \frac{r\beta}{\gamma}v + ruv$$

$$\dot{v} = -\gamma u - \frac{r\beta}{\gamma}v - ruv$$

The linearized system is

$$\dot{u} = \frac{r\beta}{\gamma}v$$

$$\dot{v} = -\gamma u - \frac{r\beta}{\gamma}v$$

Finding the eigenvalues of the linearized system,

$$\begin{vmatrix} \lambda & -\frac{r\beta}{\gamma} \\ \gamma & \lambda + \frac{r\beta}{\gamma} \end{vmatrix} = \lambda^2 + \frac{r\beta}{\gamma}\lambda + r\beta = 0$$

$$\lambda = \frac{-\frac{r\beta}{\gamma} \pm \sqrt{\left(\frac{r\beta}{\gamma}\right)^2 - 4r\beta}}{2}$$

Since both eigenvalues have negative real part, we see that the singular point is asymptotically stable. A plot of the vector field for  $r = \gamma = \beta = 1$  is attached. We note that there appears to be a stable singular point at  $x = y = 1$  which corroborates the previous results.

### Solution 49.2

The singular points are

$$u = 0, v = 0, \quad u = 0, v = 1, \quad u = 0, v = p.$$

**The point  $u = 0, v = 0$ .** The linearized system about  $u = 0, v = 0$  is

$$\begin{aligned} \frac{du}{dx} &= ru \\ \frac{dv}{dx} &= u. \end{aligned}$$

The eigenvalues are

$$\begin{aligned} \begin{vmatrix} \lambda - r & 0 \\ -1 & \lambda \end{vmatrix} &= \lambda^2 - r\lambda = 0. \\ \lambda &= 0, r. \end{aligned}$$

Since there are positive eigenvalues, this point is a source. The critical point is unstable.

**The point  $u = 0, v = 1$ .** Linearizing the system about  $u = 0, v = 1$ , we make the substitution  $w = v - 1$ .

$$\begin{aligned} \frac{du}{dx} &= ru + (w + 1)(-w)(p - 1 - w) \\ \frac{dw}{dx} &= u \end{aligned}$$

$$\begin{aligned} \frac{du}{dx} &= ru + (1 - p)w \\ \frac{dw}{dx} &= u \end{aligned}$$

$$\begin{vmatrix} \lambda - r & (p - 1) \\ -1 & \lambda \end{vmatrix} = \lambda^2 - r\lambda + p - 1 = 0$$

$$\lambda = \frac{r \pm \sqrt{r^2 - 4(p - 1)}}{2}$$

Thus we see that this point is a saddle point. The critical point is unstable.

**The point  $u = 0, v = p$ .** Linearizing the system about  $u = 0, v = p$ , we make the substitution  $w = v - p$ .

$$\begin{aligned} \frac{du}{dx} &= ru + (w + p)(1 - p - w)(-w) \\ \frac{dw}{dx} &= u \end{aligned}$$

$$\begin{aligned} \frac{du}{dx} &= ru + p(p - 1)w \\ \frac{dw}{dx} &= u \end{aligned}$$

$$\begin{vmatrix} \lambda - r & p(1 - p) \\ -1 & \lambda \end{vmatrix} = \lambda^2 - r\lambda + p(1 - p) = 0$$

$$\lambda = \frac{r \pm \sqrt{r^2 - 4p(1 - p)}}{2}$$

Thus we see that this point is a source. The critical point is unstable.

**The solution of for special values of  $\alpha$  and  $r$ .** Differentiating  $u = \alpha v(1 - v)$ ,

$$\frac{du}{dv} = \alpha - 2\alpha v.$$

Taking the ratio of the two differential equations,

$$\begin{aligned}\frac{du}{dv} &= r + \frac{v(1-v)(p-v)}{u} \\ &= r + \frac{v(1-v)(p-v)}{\alpha v(1-v)} \\ &= r + \frac{(p-v)}{\alpha}\end{aligned}$$

Equating these two expressions,

$$\alpha - 2\alpha v = r + \frac{p}{\alpha} - \frac{v}{\alpha}.$$

Equating coefficients of  $v$ , we see that  $\alpha = \frac{1}{\sqrt{2}}$ .

$$\frac{1}{\sqrt{2}} = r + \sqrt{2}p$$

Thus we have the solution  $u = \frac{1}{\sqrt{2}}v(1-v)$  when  $r = \frac{1}{\sqrt{2}} - \sqrt{2}p$ . In this case, the differential equation for  $v$  is

$$\begin{aligned}\frac{dv}{dx} &= \frac{1}{\sqrt{2}}v(1-v) \\ -v^{-2}\frac{dv}{dx} &= -\frac{1}{\sqrt{2}}v^{-1} + \frac{1}{\sqrt{2}}\end{aligned}$$

We make the change of variables  $y = v^{-1}$ .

$$\begin{aligned}\frac{dy}{dx} &= -\frac{1}{\sqrt{2}}y + \frac{1}{\sqrt{2}} \\ \frac{d}{dx} \left( e^{x/\sqrt{2}}y \right) &= \frac{e^{x/\sqrt{2}}}{\sqrt{2}} \\ y &= e^{-x/\sqrt{2}} \int^x \frac{e^{x/\sqrt{2}}}{\sqrt{2}} dx + ce^{-x/\sqrt{2}} \\ y &= 1 + ce^{-x/\sqrt{2}}\end{aligned}$$

The solution for  $v$  is

$$v(x) = \frac{1}{1 + ce^{-x/\sqrt{2}}}.$$

### Solution 49.3

We make the change of variables

$$\begin{aligned}x &= r \cos \theta \\ y &= r \sin \theta.\end{aligned}$$

Differentiating these expressions with respect to time,

$$\begin{aligned}\dot{x} &= \dot{r} \cos \theta - r\dot{\theta} \sin \theta \\ \dot{y} &= \dot{r} \sin \theta + r\dot{\theta} \cos \theta.\end{aligned}$$

Substituting the new variables into the pair of differential equations,

$$\begin{aligned}\dot{r} \cos \theta - r\dot{\theta} \sin \theta &= -r \sin \theta + r \cos \theta(1 - r^2) \\ \dot{r} \sin \theta + r\dot{\theta} \cos \theta &= r \cos \theta + r \sin \theta(1 - r^2).\end{aligned}$$

Multiplying the equations by  $\cos \theta$  and  $\sin \theta$  and taking their sum and difference yields

$$\begin{aligned}\dot{r} &= r(1 - r^2) \\ r\dot{\theta} &= r.\end{aligned}$$

We can integrate the second equation.

$$\begin{aligned}\dot{r} &= r(1 - r^2) \\ \theta &= t + \theta_0\end{aligned}$$

At this point we could note that  $\dot{r} > 0$  in  $(0, 1)$  and  $\dot{r} < 0$  in  $(1, \infty)$ . Thus if  $r$  is not initially zero, then the solution tends to  $r = 1$ .

Alternatively, we can solve the equation for  $r$  exactly.

$$\begin{aligned}\dot{r} &= r - r^3 \\ \frac{\dot{r}}{r^3} &= \frac{1}{r^2} - 1\end{aligned}$$

We make the change of variables  $u = 1/r^2$ .

$$\begin{aligned}-\frac{1}{2}\dot{u} &= u - 1 \\ \dot{u} + 2u &= 2 \\ u &= e^{-2t} \int 2e^{2t} dt + ce^{-2t} \\ u &= 1 + ce^{-2t} \\ r &= \frac{1}{\sqrt{1 + ce^{-2t}}}\end{aligned}$$

Thus we see that if  $r$  is initial nonzero, the solution tends to 1 as  $t \rightarrow \infty$ .

### Solution 49.4

The set of differential equations is

$$\begin{aligned}\epsilon \dot{y} &= f(y) - x \\ \dot{x} &= y.\end{aligned}$$

We make the change of variables

$$\begin{aligned}x &= R \cos \theta \\ y &= \frac{1}{\sqrt{\epsilon}} R \sin \theta\end{aligned}$$

Differentiating  $x$  and  $y$ ,

$$\begin{aligned}\dot{x} &= \dot{R} \cos \theta - R \dot{\theta} \sin \theta \\ \dot{y} &= \frac{1}{\sqrt{\epsilon}} \dot{R} \sin \theta + \frac{1}{\sqrt{\epsilon}} R \dot{\theta} \cos \theta.\end{aligned}$$

The pair of differential equations become

$$\begin{aligned}\sqrt{\epsilon} \dot{R} \sin \theta + \sqrt{\epsilon} R \dot{\theta} \cos \theta &= f\left(\frac{1}{\sqrt{\epsilon}} R \sin \theta\right) - R \cos \theta \\ \dot{R} \cos \theta - R \dot{\theta} \sin \theta &= \frac{1}{\sqrt{\epsilon}} R \sin \theta.\end{aligned}$$

$$\begin{aligned}\dot{R} \sin \theta + R \dot{\theta} \cos \theta &= -\frac{1}{\sqrt{\epsilon}} R \cos \theta \frac{1}{\sqrt{\epsilon}} f\left(\frac{1}{\sqrt{\epsilon}} R \sin \theta\right) \\ \dot{R} \cos \theta - R \dot{\theta} \sin \theta &= \frac{1}{\sqrt{\epsilon}} R \sin \theta.\end{aligned}$$

Multiplying by  $\cos \theta$  and  $\sin \theta$  and taking the sum and difference of these differential equations yields

$$\begin{aligned}\dot{R} &= \frac{1}{\sqrt{\epsilon}} \sin \theta f \left( \frac{1}{\sqrt{\epsilon}} R \sin \theta \right) \\ R\dot{\theta} &= -\frac{1}{\sqrt{\epsilon}} R + \frac{1}{\sqrt{\epsilon}} \cos \theta f \left( \frac{1}{\sqrt{\epsilon}} R \sin \theta \right).\end{aligned}$$

Dividing by  $R$  in the second equation,

$$\begin{aligned}\dot{R} &= \frac{1}{\sqrt{\epsilon}} \sin \theta f \left( \frac{1}{\sqrt{\epsilon}} R \sin \theta \right) \\ \dot{\theta} &= -\frac{1}{\sqrt{\epsilon}} + \frac{1}{\sqrt{\epsilon}} \frac{\cos \theta}{R} f \left( \frac{1}{\sqrt{\epsilon}} R \sin \theta \right).\end{aligned}$$

We make the assumptions that  $0 < \epsilon < 1$  and that  $f(y)$  is an odd function that is nonnegative for positive  $y$  and satisfies  $|f(y)| \leq 1$  for all  $y$ .

Since  $\sin \theta$  is odd,

$$\sin \theta f \left( \frac{1}{\sqrt{\epsilon}} R \sin \theta \right)$$

is nonnegative. Thus  $R(t)$  continually increases with  $t$  when  $R \neq 0$ .

If  $R > 1$  then

$$\begin{aligned}\left| \frac{\cos \theta}{R} f \left( \frac{1}{\sqrt{\epsilon}} R \sin \theta \right) \right| &\leq \left| f \left( \frac{1}{\sqrt{\epsilon}} R \sin \theta \right) \right| \\ &\leq 1.\end{aligned}$$

Thus the value of  $\dot{\theta}$ ,

$$-\frac{1}{\sqrt{\epsilon}} + \frac{1}{\sqrt{\epsilon}} \frac{\cos \theta}{R} f \left( \frac{1}{\sqrt{\epsilon}} R \sin \theta \right),$$

is always nonpositive. Thus  $\theta(t)$  continually decreases with  $t$ .



### Solution 49.5

1. Linearizing the Lorentz equations about  $(0, 0, 0)$  yields

$$\begin{pmatrix} \dot{x} \\ \dot{y} \\ \dot{z} \end{pmatrix} = \begin{pmatrix} -10 & 10 & 0 \\ R & -1 & 0 \\ 0 & 0 & -8/3 \end{pmatrix} \begin{pmatrix} x \\ y \\ z \end{pmatrix}$$

The eigenvalues of the matrix are

$$\begin{aligned} \lambda_1 &= -\frac{8}{3}, \\ \lambda_2 &= \frac{-11 - \sqrt{81 + 40R}}{2} \\ \lambda_3 &= \frac{-11 + \sqrt{81 + 40R}}{2}. \end{aligned}$$

There are three cases for the eigenvalues of the linearized system.

- $R < 1$ .** There are three negative, real eigenvalues. In the linearized and also the nonlinear system, the origin is a stable, sink.
- $R = 1$ .** There are two negative, real eigenvalues and one zero eigenvalue. In the linearized system the origin is stable and has a center manifold plane. The linearized system does not tell us if the nonlinear system is stable or unstable.
- $R > 1$ .** There are two negative, real eigenvalues, and one positive, real eigenvalue. The origin is a saddle point.

2. The other singular points when  $R > 1$  are

$$\left( \pm \sqrt{\frac{8}{3}(R-1)}, \pm \sqrt{\frac{8}{3}(R-1)}, R-1 \right).$$

3. Linearizing about the point

$$\left( \sqrt{\frac{8}{3}}(R-1), \sqrt{\frac{8}{3}}(R-1), R-1 \right)$$

yields

$$\begin{pmatrix} \dot{X} \\ \dot{Y} \\ \dot{Z} \end{pmatrix} = \begin{pmatrix} -10 & 10 & 0 \\ 1 & -1 & -\sqrt{\frac{8}{3}}(R-1) \\ \sqrt{\frac{8}{3}}(R-1) & \sqrt{\frac{8}{3}}(R-1) & -\frac{8}{3} \end{pmatrix} \begin{pmatrix} X \\ Y \\ Z \end{pmatrix}$$

The characteristic polynomial of the matrix is

$$\lambda^3 + \frac{41}{3}\lambda^2 + \frac{8(10+R)}{3}\lambda + \frac{160}{3}(R-1).$$

Thus the eigenvalues of the matrix satisfy the polynomial,

$$3\lambda^3 + 41\lambda^2 + 8(10+R)\lambda + 160(R-1) = 0.$$

Linearizing about the point

$$\left( -\sqrt{\frac{8}{3}}(R-1), -\sqrt{\frac{8}{3}}(R-1), R-1 \right)$$

yields

$$\begin{pmatrix} \dot{X} \\ \dot{Y} \\ \dot{Z} \end{pmatrix} = \begin{pmatrix} -10 & 10 & 0 \\ 1 & -1 & \sqrt{\frac{8}{3}}(R-1) \\ -\sqrt{\frac{8}{3}}(R-1) & -\sqrt{\frac{8}{3}}(R-1) & -\frac{8}{3} \end{pmatrix} \begin{pmatrix} X \\ Y \\ Z \end{pmatrix}$$

The characteristic polynomial of the matrix is

$$\lambda^3 + \frac{41}{3}\lambda^2 + \frac{8(10+R)}{3}\lambda + \frac{160}{3}(R-1).$$

Thus the eigenvalues of the matrix satisfy the polynomial,

$$3\lambda^3 + 41\lambda^2 + 8(10 + R)\lambda + 160(R - 1) = 0.$$

4. If the characteristic polynomial has two pure imaginary roots  $\pm i\mu$  and one real root, then it has the form

$$(\lambda - r)(\lambda^2 + \mu^2) = \lambda^3 - r\lambda^2 + \mu^2\lambda - r\mu^2.$$

Equating the  $\lambda^2$  and the  $\lambda$  term with the characteristic polynomial yields

$$r = -\frac{41}{3}, \quad \mu = \sqrt{\frac{8}{3}(10 + R)}.$$

Equating the constant term gives us the equation

$$\frac{41}{3} \frac{8}{3} (10 + R_c) = \frac{160}{3} (R_c - 1)$$

which has the solution

$$R_c = \frac{470}{19}.$$

For this critical value of  $R$  the characteristic polynomial has the roots

$$\begin{aligned}\lambda_1 &= -\frac{41}{3} \\ \lambda_2 &= \frac{4}{19} \sqrt{2090} \\ \lambda_3 &= -\frac{4}{19} \sqrt{2090}.\end{aligned}$$

### Solution 49.6

The form of the perturbation expansion is

$$\begin{aligned}v(\theta) &= 1 + A \cos \theta + \epsilon u(\theta) + \mathcal{O}(\epsilon^2) \\ \theta &= (1 + \epsilon \omega_1 + \mathcal{O}(\epsilon^2)) \phi.\end{aligned}$$

Writing the derivatives in terms of  $\theta$ ,

$$\begin{aligned}\frac{d}{d\phi} &= (1 + \epsilon\omega_1 + \cdots) \frac{d}{d\theta} \\ \frac{d^2}{d\phi^2} &= (1 + 2\epsilon\omega_1 + \cdots) \frac{d^2}{d\theta^2}.\end{aligned}$$

Substituting these expressions into the differential equation for  $v(\phi)$ ,

$$\begin{aligned}[1 + 2\epsilon\omega_1 + \mathcal{O}(\epsilon^2)] [-A \cos \theta + \epsilon u'' + \mathcal{O}(\epsilon^2)] + 1 + A \cos \theta + \epsilon u(\theta) + \mathcal{O}(\epsilon^2) \\ = 1 + \epsilon [1 + 2A \cos \theta + A^2 \cos^2 \theta + \mathcal{O}(\epsilon)]\end{aligned}$$

$$\epsilon u'' + \epsilon u - 2\epsilon\omega_1 A \cos \theta = \epsilon + 2\epsilon A \cos \theta + \epsilon A^2 \cos^2 \theta + \mathcal{O}(\epsilon^2).$$

Equating the coefficient of  $\epsilon$ ,

$$\begin{aligned}u'' + u &= 1 + 2\epsilon(1 + \omega_1)A \cos \theta + \frac{1}{2}A^2(\cos 2\theta + 1) \\ u'' + u &= (1 + \frac{1}{2}A^2) + 2\epsilon(1 + \omega_1)A \cos \theta + \frac{1}{2}A^2 \cos 2\theta.\end{aligned}$$

To avoid secular terms, we must have  $\omega_1 = -1$ . A particular solution for  $u$  is

$$u = 1 + \frac{1}{2}A^2 - \frac{1}{6}A^2 \cos 2\theta.$$

The the solution for  $v$  is

$$v(\phi) = 1 + A \cos((1 - \epsilon)\phi) + \epsilon \left[ 1 + \frac{1}{2}A^2 - \frac{1}{6}A^2 \cos(2(1 - \epsilon)\phi) \right] + \mathcal{O}(\epsilon^2).$$

**Solution 49.7**

Substituting the expressions for  $x$  and  $\omega$  into the differential equations yields

$$a^2 \left[ \omega_0^2 \left( \frac{d^2 x_2}{d\theta^2} + x_2 \right) + \alpha \cos^2 \theta \right] + a^3 \left[ \omega_0^2 \left( \frac{d^2 x_3}{d\theta^2} + x_3 \right) - 2\omega_0 \omega_2 \cos \theta + 2\alpha x_2 \cos \theta \right] + \mathcal{O}(a^4) = 0$$

Equating the coefficient of  $a^2$  gives us the differential equation

$$\frac{d^2 x_2}{d\theta^2} + x_2 = -\frac{\alpha}{2\omega_0^2} (1 + \cos 2\theta).$$

The solution subject to the initial conditions  $x_2(0) = x_2'(0) = 0$  is

$$x_2 = \frac{\alpha}{6\omega_0^2} (-3 + 2 \cos \theta + \cos 2\theta).$$

Equating the coefficient of  $a^3$  gives us the differential equation

$$\omega_0^2 \left( \frac{d^2 x_3}{d\theta^2} + x_3 \right) + \frac{\alpha^2}{3\omega_0^2} - \left( 2\omega_0 \omega_2 + \frac{5\alpha^2}{6\omega_0^2} \right) \cos \theta + \frac{\alpha^2}{3\omega_0^2} \cos 2\theta + \frac{\alpha^2}{6\omega_0^2} \cos 3\theta = 0.$$

To avoid secular terms we must have

$$\omega_2 = -\frac{5\alpha^2}{12\omega_0}.$$

Solving the differential equation for  $x_3$  subject to the initial conditions  $x_3(0) = x_3'(0) = 0$ ,

$$x_3 = \frac{\alpha^2}{144\omega_0^4} (-48 + 29 \cos \theta + 16 \cos 2\theta + 3 \cos 3\theta).$$

Thus our solution for  $x(t)$  is

$$x(t) = a \cos \theta + a^2 \left[ \frac{\alpha}{6\omega_0^2} (-3 + 2 \cos \theta + \cos 2\theta) \right] + a^3 \left[ \frac{\alpha^2}{144\omega_0^4} (-48 + 29 \cos \theta + 16 \cos 2\theta + 3 \cos 3\theta) \right] + \mathcal{O}(a^4)$$

where  $\theta = \left(\omega_0 - a^2 \frac{5\alpha^2}{12\omega_0}\right) t$ .

Now to see why we didn't need an  $a\omega_1$  term. Assume that

$$\begin{aligned}x &= a \cos \theta + a^2 x_2(\theta) + \mathcal{O}(a^3); & \theta &= \omega t \\ \omega &= \omega_0 + a\omega_1 + \mathcal{O}(a^2).\end{aligned}$$

Substituting these expressions into the differential equation for  $x$  yields

$$a^2 [\omega_0^2(x_2'' + x_2) - 2\omega_0\omega_1 \cos \theta + \alpha \cos^2 \theta] = \mathcal{O}(a^3)$$

$$x_2'' + x_2 = 2\frac{\omega_1}{\omega_0} \cos \theta - \frac{\alpha}{2\omega_0^2}(1 + \cos 2\theta).$$

In order to eliminate secular terms, we need  $\omega_1 = 0$ .

### Solution 49.8

1. The equation for  $p_1(t)$  is

$$\begin{aligned}\frac{dp_1(t)}{dt} &= \alpha[p_0(t) - p_1(t)]. \\ \frac{dp_1(t)}{dt} &= \alpha[ae^{i\omega t} - p_1(t)] \\ \frac{d}{dt} (e^{\alpha t} p_1(t)) &= \alpha a e^{\alpha t} e^{i\omega t} \\ p_1(t) &= \frac{\alpha a}{\alpha + i\omega} e^{i\omega t} + ce^{-\alpha t}\end{aligned}$$

Applying the initial condition,  $p_1(0) = 0$ ,

$$p_1(t) = \frac{\alpha a}{\alpha + i\omega} (e^{i\omega t} - e^{-\alpha t})$$

2. We start with the differential equation for  $p_n(t)$ .

$$\frac{dp_n(t)}{dt} = \alpha[p_{n-1}(t) - p_n(t)]$$

Multiply by  $s^n$  and sum from  $n = 1$  to  $\infty$ .

$$\begin{aligned} \sum_{n=1}^{\infty} p'_n(t)s^n &= \sum_{n=1}^{\infty} \alpha[p_{n-1}(t) - p_n(t)]s^n \\ \frac{\partial G(s, t)}{\partial t} &= \alpha \sum_{n=0}^{\infty} p_n s^{n+1} - \alpha G(s, t) \\ \frac{\partial G(s, t)}{\partial t} &= \alpha s p_0 + \alpha \sum_{n=1}^{\infty} p_n s^{n+1} - \alpha G(s, t) \\ \frac{\partial G(s, t)}{\partial t} &= \alpha a s e^{\omega t} + \alpha s G(s, t) - \alpha G(s, t) \\ \frac{\partial G(s, t)}{\partial t} &= \alpha a s e^{\omega t} + \alpha(s - 1)G(s, t) \\ \frac{\partial}{\partial t} (e^{\alpha(1-s)t} G(s, t)) &= \alpha a s e^{\alpha(1-s)t} e^{\omega t} \\ G(s, t) &= \frac{\alpha a s}{\alpha(1-s) + \omega} e^{\omega t} + C(s) e^{\alpha(s-1)t} \end{aligned}$$

The initial condition is

$$G(s, 0) = \sum_{n=1}^{\infty} p_n(0) s^n = 0.$$

The generating function is then

$$G(s, t) = \frac{\alpha a s}{\alpha(1-s) + \omega} (\alpha e^{\omega t} - e^{\alpha(s-1)t}).$$

3. Assume that  $|s| < 1$ . In the limit  $t \rightarrow \infty$  we have

$$\begin{aligned}
 G(s, t) &\sim \frac{\alpha a s}{\alpha(1-s) + i\omega} e^{i\omega t} \\
 G(s, t) &\sim \frac{a s}{1 + i\omega/\alpha - s} e^{i\omega t} \\
 G(s, t) &\sim \frac{a s / (1 + i\omega/\alpha)}{1 - s / (1 + i\omega/\alpha)} e^{i\omega t} \\
 G(s, t) &\sim \frac{a s e^{i\omega t}}{1 + i\omega/\alpha} \sum_{n=0}^{\infty} \left( \frac{s}{1 + i\omega/\alpha} \right)^n \\
 G(s, t) &\sim a e^{i\omega t} \sum_{n=1}^{\infty} \frac{s^n}{(1 + i\omega/\alpha)^n}
 \end{aligned}$$

Thus we have

$$\boxed{p_n(t) \sim \frac{a}{(1 + i\omega/\alpha)^n} e^{i\omega t} \quad \text{as } t \rightarrow \infty.}$$

$$\begin{aligned}
 \Im(p_n(t)) &\sim \Im \left[ \frac{a}{(1 + i\omega/\alpha)^n} e^{i\omega t} \right] \\
 &= a \left( \frac{1 - i\omega/\alpha}{1 + (\omega/\alpha)^2} \right)^n [\cos(\omega t) + i \sin(\omega t)] \\
 &= \frac{a}{(1 + (\omega/\alpha)^2)^n} [\cos(\omega t) \Im[(1 - i\omega/\alpha)^n] + \sin(\omega t) \Re[(1 - i\omega/\alpha)^n]] \\
 &= \frac{a}{(1 + (\omega/\alpha)^2)^n} \left[ \cos(\omega t) \sum_{\substack{j=1 \\ \text{odd } j}}^n (-1)^{(j+1)/2} \left( \frac{\omega}{\alpha} \right)^j + \sin(\omega t) \sum_{\substack{j=0 \\ \text{even } j}}^n (-1)^{j/2} \left( \frac{\omega}{\alpha} \right)^j \right]
 \end{aligned}$$



### Solution 49.9

1. Substituting  $p_n = A_n e^{i\omega t}$  into the differential equation yields

$$\begin{aligned} A_n i\omega e^{i\omega(t+\tau)} &= \alpha[A_{n-1} e^{i\omega t} - A_n e^{i\omega t}] \\ A_n(\alpha + i\omega e^{i\omega\tau}) &= \alpha A_{n-1} \end{aligned}$$

We make the substitution  $A_n = r^n$ .

$$\begin{aligned} r^n(\alpha + i\omega e^{i\omega\tau}) &= \alpha r^{n-1} \\ r &= \frac{\alpha}{\alpha + i\omega e^{i\omega\tau}} \end{aligned}$$

Thus we have

$$p_n(t) = \left( \frac{1}{1 + i\omega e^{i\omega\tau}/\alpha} \right)^n e^{i\omega t}.$$

Taking the imaginary part,

$$\begin{aligned}
\Im(p_n(t)) &= \Im \left[ \left( \frac{1}{1 + i\frac{\omega}{\alpha} e^{i\omega\tau}} \right)^n e^{i\omega t} \right] \\
&= \Im \left[ \left( \frac{1 - i\frac{\omega}{\alpha} e^{-i\omega\tau}}{1 + i\frac{\omega}{\alpha} (e^{i\omega\tau} - e^{-i\omega\tau}) + (\frac{\omega}{\alpha})^2} \right)^n (\cos(\omega t) + i \sin(\omega t)) \right] \\
&= \Im \left[ \left( \frac{1 - \frac{\omega}{\alpha} \sin(\omega\tau) - i\frac{\omega}{\alpha} \cos(\omega\tau)}{1 - 2\frac{\omega}{\alpha} \sin(\omega\tau) + (\frac{\omega}{\alpha})^2} \right)^n (\cos(\omega t) + i \sin(\omega t)) \right] \\
&= \left( \frac{1}{1 - 2\frac{\omega}{\alpha} \sin(\omega\tau) + (\frac{\omega}{\alpha})^2} \right)^n \left[ \cos(\omega t) \Im \left[ \left( 1 - \frac{\omega}{\alpha} \sin(\omega\tau) - i\frac{\omega}{\alpha} \cos(\omega\tau) \right)^n \right] \right. \\
&\quad \left. + \sin(\omega t) \Re \left[ \left( 1 - \frac{\omega}{\alpha} \sin(\omega\tau) - i\frac{\omega}{\alpha} \cos(\omega\tau) \right)^n \right] \right] \\
&= \left( \frac{1}{1 - 2\frac{\omega}{\alpha} \sin(\omega\tau) + (\frac{\omega}{\alpha})^2} \right)^n \\
&\quad \left[ \cos(\omega t) \sum_{\substack{j=1 \\ \text{odd } j}}^n (-1)^{(j+1)/2} \left[ \frac{\omega}{\alpha} \cos(\omega\tau) \right]^j \left[ 1 - \frac{\omega}{\alpha} \sin(\omega\tau) \right]^{n-j} \right. \\
&\quad \left. + \sin(\omega t) \sum_{\substack{j=0 \\ \text{even } j}}^n (-1)^{j/2} \left[ \frac{\omega}{\alpha} \cos(\omega\tau) \right]^j \left[ 1 - \frac{\omega}{\alpha} \sin(\omega\tau) \right]^{n-j} \right]
\end{aligned}$$

2.  $p_n(t)$  will remain bounded in time as  $n \rightarrow \infty$  if

$$\left| \frac{1}{1 + i\frac{\omega}{\alpha} e^{i\omega\tau}} \right| \leq 1$$
$$\left| 1 + i\frac{\omega}{\alpha} e^{i\omega\tau} \right|^2 \geq 1$$
$$1 - 2\frac{\omega}{\alpha} \sin(\omega\tau) + \left(\frac{\omega}{\alpha}\right)^2 \geq 1$$
$$\boxed{\frac{\omega}{\alpha} \geq 2 \sin(\omega\tau)}$$

3.

# Chapter 50

## Nonlinear Partial Differential Equations

## 50.1 Exercises

### Exercise 50.1

Consider the nonlinear PDE

$$u_t + uu_x = 0.$$

The solution  $u$  is constant along lines (characteristics) such that  $x - ut = k$  for any constant  $k$ . Thus the slope of these lines will depend on the initial data  $u(x, 0) = f(x)$ .

1. In terms of this initial data, write down the equation for the characteristic in the  $x, t$  plane which goes through the point  $(x, t) = (\xi, 0)$ .
2. State a criteria on  $f$  such that two characteristics will intersect at some positive time  $t$ . Assuming intersections do occur, what is the time of the *first* intersection? You may assume that  $f$  is everywhere continuous and differentiable.
3. Apply this to the case where  $f(x) = 1 - e^{-x^2}$  to indicate where and when a shock will form and sketch (roughly) the solution both before and after this time.

### Exercise 50.2

Solve the equation

$$\phi_t + (1 + x)\phi_x + \phi = 0 \quad \text{in} \quad -\infty < x < \infty, \quad t > 0,$$

with initial condition  $\phi(x, 0) = f(x)$ .

### Exercise 50.3

Solve the equation

$$\phi_t + \phi_x + \frac{\alpha\phi}{1+x} = 0$$

in the region  $0 < x < \infty, t > 0$  with initial condition  $\phi(x, 0) = 0$ , and boundary condition  $\phi(0, t) = g(t)$ . [Here  $\alpha$  is a positive constant.]

### Exercise 50.4

Solve the equation

$$\phi_t + \phi_x + \phi^2 = 0$$

in  $-\infty < x < \infty$ ,  $t > 0$  with initial condition  $\phi(x, 0) = f(x)$ . Note that the solution could become infinite in finite time.

### Exercise 50.5

Consider

$$c_t + cc_x + \mu c = 0, \quad -\infty < x < \infty, \quad t > 0.$$

1. Use the method of characteristics to solve the problem with

$$c = F(x) \text{ at } t = 0.$$

( $\mu$  is a positive constant.)

2. Find equations for the envelope of characteristics in the case  $F'(x) < 0$ .
3. Deduce an inequality relating  $\max |F'(x)|$  and  $\mu$  which decides whether breaking does or does not occur.

### Exercise 50.6

For water waves in a channel the so-called shallow water equations are

$$h_t + (hv)_x = 0 \tag{50.1}$$

$$(hv)_t + \left( hv^2 + \frac{1}{2}gh^2 \right)_x = 0, \quad g = \text{constant}. \tag{50.2}$$

Investigate whether there are solutions with  $v = V(h)$ , where  $V(h)$  is not posed in advance but is obtained from requiring consistency between the  $h$  equation obtained from (1) and the  $h$  equation obtained from (2).

There will be two possible choices for  $V(h)$  depending on a choice of sign. Consider each case separately. In each case fix the arbitrary constant that arises in  $V(h)$  by stipulating that before the waves arrive,  $h$  is equal to the undisturbed depth  $h_0$  and  $V(h_0) = 0$ .

Find the  $h$  equation and the wave speed  $c(h)$  in each case.

### Exercise 50.7

After a change of variables, the chemical exchange equations can be put in the form

$$\frac{\partial \rho}{\partial t} + \frac{\partial \sigma}{\partial x} = 0 \quad (50.3)$$

$$\frac{\partial \rho}{\partial t} = \alpha \sigma - \beta \rho - \gamma \rho \sigma; \quad \alpha, \beta, \gamma = \text{positive constants.} \quad (50.4)$$

1. Investigate wave solutions in which  $\rho = \rho(X)$ ,  $\sigma = \sigma(X)$ ,  $X = x - Ut$ ,  $U = \text{constant}$ , and show that  $\rho(X)$  must satisfy an ordinary differential equation of the form

$$\frac{d\rho}{dX} = \text{quadratic in } \rho.$$

2. Discuss the “smooth shock” solution as we did for a different example in class. In particular find the expression for  $U$  in terms of the values of  $\rho$  as  $X \rightarrow \pm\infty$ , and find the sign of  $d\rho/dX$ . Check that

$$U = \frac{\sigma_2 - \sigma_1}{\rho_2 - \rho_1}$$

in agreement with the “discontinuous theory.”

### Exercise 50.8

Find solitary wave solutions for the following equations:

1.  $\eta_t + \eta_x + 6\eta\eta_x - \eta_{xxt} = 0$ . (Regularized long wave or B.B.M. equation)
2.  $u_{tt} - u_{xx} - \left(\frac{3}{2}u^2\right)_{xx} - u_{xxxx} = 0$ . (“Boussinesq”)
3.  $\phi_{tt} - \phi_{xx} + 2\phi_x\phi_{xt} + \phi_{xx}\phi_t - \phi_{xxxx} = 0$ . (The solitary wave form is for  $u = \phi_x$ )
4.  $u_t + 30u^2u_1 + 20u_1u_2 + 10uu_3 + u_5 = 0$ . (Here the subscripts denote  $x$  derivatives.)

## 50.2 Hints

**Hint 50.1**

**Hint 50.2**

**Hint 50.3**

**Hint 50.4**

**Hint 50.5**

**Hint 50.6**

**Hint 50.7**

**Hint 50.8**



## 50.3 Solutions

### Solution 50.1

1.

$$x = \xi + u(\xi, 0)t$$

$$x = \xi + f(\xi)t$$

2. Consider two points  $\xi_1$  and  $\xi_2$  where  $\xi_1 < \xi_2$ . Suppose that  $f(\xi_1) > f(\xi_2)$ . Then the two characteristics passing through the points  $(\xi_1, 0)$  and  $(\xi_2, 0)$  will intersect.

$$\xi_1 + f(\xi_1)t = \xi_2 + f(\xi_2)t$$

$$t = \frac{\xi_2 - \xi_1}{f(\xi_1) - f(\xi_2)}$$

We see that the two characteristics intersect at the point

$$(x, t) = \left( \xi_1 + f(\xi_1) \frac{\xi_2 - \xi_1}{f(\xi_1) - f(\xi_2)}, \frac{\xi_2 - \xi_1}{f(\xi_1) - f(\xi_2)} \right).$$

We see that if  $f(x)$  is not a non-decreasing function, then there will be a positive time when characteristics intersect.

Assume that  $f(x)$  is continuously differentiable and is not a non-decreasing function. That is, there are points where  $f'(x)$  is negative. We seek the time  $T$  of the first intersection of characteristics.

$$T = \min_{\substack{\xi_1 < \xi_2 \\ f(\xi_1) > f(\xi_2)}} \frac{\xi_2 - \xi_1}{f(\xi_1) - f(\xi_2)}$$

$(f(\xi_2) - f(\xi_1))/(\xi_2 - \xi_1)$  is the slope of the secant line on  $f(x)$  that passes through the points  $\xi_1$  and  $\xi_2$ . Thus we seek the secant line on  $f(x)$  with the minimum slope. This occurs for the tangent line where  $f'(x)$  is minimum.

$$T = -\frac{1}{\min_{\xi} f'(\xi)}$$

3. First we find the time when the characteristics first intersect. We find the minima of  $f'(x)$  with the derivative test.

$$\begin{aligned} f(x) &= 1 - e^{-x^2} \\ f'(x) &= 2x e^{-x^2} \\ f''(x) &= (2 - 4x^2) e^{-x^2} = 0 \\ x &= \pm \frac{1}{\sqrt{2}} \end{aligned}$$

The minimum slope occurs at  $x = -1/\sqrt{2}$ .

$$T = -\frac{1}{-2e^{-1/2}/\sqrt{2}} = \frac{e^{1/2}}{\sqrt{2}} \approx 1.16582$$

Figure 50.1 shows the solution at various times up to the first collision of characteristics, when a shock forms. After this time, the shock wave moves to the right.

### Solution 50.2

The method of characteristics gives us the differential equations

$$\begin{aligned} x'(t) &= (1 + x) & x(0) &= \xi \\ \frac{d\phi}{dt} &= -\phi & \phi(\xi, 0) &= f(\xi) \end{aligned}$$

Solving the first differential equation,

$$\begin{aligned} x(t) &= ce^t - 1, & x(0) &= \xi \\ x(t) &= (\xi + 1)e^t - 1 \end{aligned}$$

The second differential equation then becomes

$$\begin{aligned} \phi(x(t), t) &= ce^{-t}, & \phi(\xi, 0) &= f(\xi), & \xi &= (x + 1)e^{-t} - 1 \\ \phi(x, t) &= f((x + 1)e^{-t} - 1)e^{-t} \end{aligned}$$

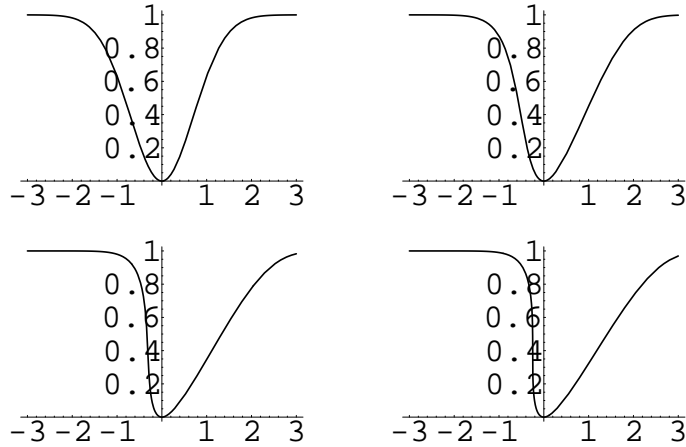

Figure 50.1: The solution at  $t = 0, 1/2, 1, 1.16582$ .

Thus the solution to the partial differential equation is

$$\phi(x, t) = f((x + 1)e^{-t} - 1)e^{-t}.$$

### Solution 50.3

$$\frac{d\phi}{dt} = \phi_t + x'(t)\phi_x = -\frac{\alpha\phi}{1+x}$$

The characteristic curves  $x(t)$  satisfy  $x'(t) = 1$ , so  $x(t) = t + c$ . The characteristic curve that separates the region with domain of dependence on the  $x$  axis and domain of dependence on the  $t$  axis is  $x(t) = t$ . Thus we consider the two cases  $x > t$  and  $x < t$ .

- $x > t$ .  $x(t) = t + \xi$ .

- $x < t$ .  $x(t) = t - \tau$ .

Now we solve the differential equation for  $\phi$  in the two domains.

- $x > t$ .

$$\begin{aligned} \frac{d\phi}{dt} &= -\frac{\alpha\phi}{1+x}, & \phi(\xi, 0) &= 0, & \xi &= x - t \\ \frac{d\phi}{dt} &= -\frac{\alpha\phi}{1+t+\xi} \\ \phi &= c \exp\left(-\alpha \int \frac{1}{t+\xi+1} dt\right) \\ \phi &= c \exp(-\alpha \log(t+\xi+1)) \\ \phi &= c(t+\xi+1)^{-\alpha} \end{aligned}$$

applying the initial condition, we see that

$$\phi = 0$$

- $x < t$ .

$$\begin{aligned} \frac{d\phi}{dt} &= -\frac{\alpha\phi}{1+x}, & \phi(0, \tau) &= g(\tau), & \tau &= t - x \\ \frac{d\phi}{dt} &= -\frac{\alpha\phi}{1+t-\tau} \\ \phi &= c(t+1-\tau)^{-\alpha} \\ \phi &= g(\tau)(t+1-\tau)^{-\alpha} \\ \phi &= g(t-x)(x+1)^{-\alpha} \end{aligned}$$

Thus the solution to the partial differential equation is

$$\phi(x, t) = \begin{cases} 0 & \text{for } x > t \\ g(t - x)(x + 1)^{-\alpha} & \text{for } x < t. \end{cases}$$

### Solution 50.4

The method of characteristics gives us the differential equations

$$\begin{aligned} x'(t) &= 1 & x(0) &= \xi \\ \frac{d\phi}{dt} &= -\phi^2 & \phi(\xi, 0) &= f(\xi) \end{aligned}$$

Solving the first differential equation,

$$x(t) = t + \xi.$$

The second differential equation is then

$$\begin{aligned} \frac{d\phi}{dt} &= -\phi^2, & \phi(\xi, 0) &= f(\xi), & \xi &= x - t \\ \phi^{-2} d\phi &= -dt \\ -\phi^{-1} &= -t + c \\ \phi &= \frac{1}{t - c} \\ \phi &= \frac{1}{t + 1/f(\xi)} \end{aligned}$$

$$\phi = \frac{1}{t + 1/f(x - t)}.$$

### Solution 50.5

1. Taking the total derivative of  $c$  with respect to  $t$ ,

$$\frac{dc}{dt} = c_t + \frac{dx}{dt} c_x.$$

Equating terms with the partial differential equation, we have the system of differential equations

$$\begin{aligned}\frac{dx}{dt} &= c \\ \frac{dc}{dt} &= -\mu c.\end{aligned}$$

subject to the initial conditions

$$x(0) = \xi, \quad c(\xi, 0) = F(\xi).$$

We can solve the second ODE directly.

$$\begin{aligned}c(\xi, t) &= c_1 e^{-\mu t} \\ c(\xi, t) &= F(\xi) e^{-\mu t}\end{aligned}$$

Substituting this result and solving the first ODE,

$$\begin{aligned}\frac{dx}{dt} &= F(\xi) e^{-\mu t} \\ x(t) &= -\frac{F(\xi)}{\mu} e^{-\mu t} + c_2 \\ x(t) &= \frac{F(\xi)}{\mu} (1 - e^{-\mu t}) + \xi.\end{aligned}$$

The solution to the problem at the point  $(x, t)$  is found by first solving

$$x = \frac{F(\xi)}{\mu} (1 - e^{-\mu t}) + \xi$$

for  $\xi$  and then using this value to compute

$$c(x, t) = F(\xi) e^{-\mu t}.$$

2. The characteristic lines are given by the equation

$$x(t) = \frac{F(\xi)}{\mu}(1 - e^{-\mu t}) + \xi.$$

The points on the envelope of characteristics also satisfy

$$\frac{\partial x(t)}{\partial \xi} = 0.$$

Thus the points on the envelope satisfy the system of equations

$$\begin{aligned}x &= \frac{F(\xi)}{\mu}(1 - e^{-\mu t}) + \xi \\0 &= \frac{F'(\xi)}{\mu}(1 - e^{-\mu t}) + 1.\end{aligned}$$

By substituting

$$1 - e^{-\mu t} = -\frac{\mu}{F'(\xi)}$$

into the first equation we can eliminate its  $t$  dependence.

$$x = -\frac{F(\xi)}{F'(\xi)} + \xi$$

Now we can solve the second equation in the system for  $t$ .

$$\begin{aligned}e^{-\mu t} &= 1 + \frac{\mu}{F'(\xi)} \\t &= -\frac{1}{\mu} \log \left( 1 + \frac{\mu}{F'(\xi)} \right)\end{aligned}$$

Thus the equations that describe the envelope are

$$x = -\frac{F(\xi)}{F'(\xi)} + \xi$$
$$t = -\frac{1}{\mu} \log \left( 1 + \frac{\mu}{F'(\xi)} \right).$$

3. The second equation for the envelope has a solution for positive  $t$  if there is some  $x$  that satisfies

$$-1 < \frac{\mu}{F'(x)} < 0.$$

This is equivalent to

$$-\infty < F'(x) < -\mu.$$

So in the case that  $F'(x) < 0$ , there will be breaking iff

$$\max |F'(x)| > \mu.$$

### Solution 50.6

With the substitution  $v = V(h)$ , the two equations become

$$h_t + (V + hV')h_x = 0$$
$$(V + hV')h_t + (V^2 + 2hVV' + gh)h_x = 0.$$

We can rewrite the second equation as

$$h_t + \frac{V^2 + 2hVV' + gh}{V + hV'}h_x = 0.$$

Requiring that the two equations be consistent gives us a differential equation for  $V$ .

$$V + hV' = \frac{V^2 + 2hVV' + gh}{V + hV'}$$
$$V^2 + 2hVV' + h^2(V')^2 = V^2 + 2hVV' + gh$$
$$(V')^2 = \frac{g}{h}.$$



There are two choices depending on which sign we choose when taking the square root of the above equation.

**Positive  $V'$ .**

$$V' = \sqrt{\frac{g}{h}}$$
$$V = 2\sqrt{gh} + \text{const}$$

We apply the initial condition  $V(h_0) = 0$ .

$$V = 2\sqrt{g}(\sqrt{h} - \sqrt{h_0})$$

The partial differential equation for  $h$  is then

$$h_t + (2\sqrt{g}(\sqrt{h} - \sqrt{h_0})h)_x = 0$$

$$h_t + \sqrt{g}(3\sqrt{h} - 2\sqrt{h_0})h_x = 0$$

The wave speed is

$$c(h) = \sqrt{g}(3\sqrt{h} - 2\sqrt{h_0}).$$

**Negative  $V'$ .**

$$V' = -\sqrt{\frac{g}{h}}$$
$$V = -2\sqrt{gh} + \text{const}$$

We apply the initial condition  $V(h_0) = 0$ .

$$V = 2\sqrt{g}(\sqrt{h_0} - \sqrt{h})$$

The partial differential equation for  $h$  is then

$$h_t + \sqrt{g}(2\sqrt{h_0} - 3\sqrt{h})h_x = 0.$$

The wave speed is

$$c(h) = \sqrt{g}(2\sqrt{h_0} - 3\sqrt{h}).$$

### Solution 50.7

1. Making the substitutions,  $\rho = \rho(X)$ ,  $\sigma = \sigma(X)$ ,  $X = x - Ut$ , the system of partial differential equations becomes

$$\begin{aligned} -U\rho' + \sigma' &= 0 \\ -U\rho' &= \alpha\sigma - \beta\rho - \gamma\rho\sigma. \end{aligned}$$

Integrating the first equation yields

$$\begin{aligned} -U\rho + \sigma &= c \\ \sigma &= c + U\rho. \end{aligned}$$

Now we substitute the expression for  $\sigma$  into the second partial differential equation.

$$\begin{aligned} -U\rho' &= \alpha(c + U\rho) - \beta\rho - \gamma\rho(c + U\rho) \\ \rho' &= -\alpha\left(\rho + \frac{c}{U}\right) + \frac{\beta}{U}\rho + \gamma\rho\left(\rho + \frac{c}{U}\right) \end{aligned}$$

Thus  $\rho(X)$  satisfies the ordinary differential equation

$$\rho' = \gamma\rho^2 + \left(\frac{\gamma c}{U} + \frac{\beta}{U} - \alpha\right)\rho - \frac{\alpha c}{U}.$$

2. Assume that

$$\rho(X) \rightarrow \rho_1 \text{ as } X \rightarrow +\infty$$

$$\rho(X) \rightarrow \rho_2 \text{ as } X \rightarrow -\infty$$

$$\rho'(X) \rightarrow 0 \text{ as } X \rightarrow \pm\infty.$$

Integrating the ordinary differential equation for  $\rho$ ,

$$X = \int^{\rho} \frac{d\rho}{\gamma\rho^2 + \left(\frac{\gamma c}{U} + \frac{\beta}{U} - \alpha\right)\rho - \frac{\alpha c}{U}}.$$

We see that the roots of the denominator of the integrand must be  $\rho_1$  and  $\rho_2$ . Thus we can write the ordinary differential equation for  $\rho(X)$  as

$$\rho'(X) = \gamma(\rho - \rho_1)(\rho - \rho_2) = \gamma\rho^2 - \gamma(\rho_1 + \rho_2)\rho + \gamma\rho_1\rho_2.$$

Equating coefficients in the polynomial with the differential equation for part 1, we obtain the two equations

$$-\frac{\alpha c}{U} = \gamma\rho_1\rho_2, \quad \frac{\gamma c}{U} + \frac{\beta}{U} - \alpha = -\gamma(\rho_1 + \rho_2).$$

Solving the first equation for  $c$ ,

$$c = -\frac{U\gamma\rho_1\rho_2}{\alpha}.$$

Now we substitute the expression for  $c$  into the second equation.

$$\begin{aligned} -\frac{\gamma U \gamma \rho_1 \rho_2}{\alpha U} + \frac{\beta}{U} - \alpha &= -\gamma(\rho_1 + \rho_2) \\ \frac{\beta}{U} &= \alpha + \frac{\gamma^2 \rho_1 \rho_2}{\alpha} - \gamma(\rho_1 + \rho_2) \end{aligned}$$

Thus we see that  $U$  is

$$U = \frac{\alpha\beta}{\alpha^2 + \gamma^2\rho_1\rho_2 - \alpha\gamma(\rho_1 + \rho_2)}.$$

Since the quadratic polynomial in the ordinary differential equation for  $\rho(X)$  is convex, it is negative valued between its two roots. Thus we see that

$$\boxed{\frac{d\rho}{dX} < 0.}$$

Using the expression for  $\sigma$  that we obtained in part 1,

$$\begin{aligned} \frac{\sigma_2 - \sigma_1}{\rho_2 - \rho_1} &= \frac{c + U\rho_2 - (c + U\rho_1)}{\rho_2 - \rho_1} \\ &= U \frac{\rho_2 - \rho_1}{\rho_2 - \rho_1} \\ &= U. \end{aligned}$$

Now let's return to the ordinary differential equation for  $\rho(X)$

$$\begin{aligned} \rho'(X) &= \gamma(\rho - \rho_1)(\rho - \rho_2) \\ X &= \int^{\rho} \frac{d\rho}{\gamma(\rho - \rho_1)(\rho - \rho_2)} \\ X &= -\frac{1}{\gamma(\rho_2 - \rho_1)} \int^{\rho} \left( \frac{1}{\rho - \rho_1} + \frac{1}{\rho_2 - \rho} \right) d\rho \\ X - X_0 &= -\frac{1}{\gamma(\rho_2 - \rho_1)} \ln \left( \frac{\rho - \rho_1}{\rho_2 - \rho} \right) \\ -\gamma(\rho_2 - \rho_1)(X - X_0) &= \ln \left( \frac{\rho - \rho_1}{\rho_2 - \rho} \right) \\ \frac{\rho - \rho_1}{\rho_2 - \rho} &= \exp(-\gamma(\rho_2 - \rho_1)(X - X_0)) \\ \rho - \rho_1 &= (\rho_2 - \rho) \exp(-\gamma(\rho_2 - \rho_1)(X - X_0)) \\ \rho [1 + \exp(-\gamma(\rho_2 - \rho_1)(X - X_0))] &= \rho_1 + \rho_2 \exp(-\gamma(\rho_2 - \rho_1)(X - X_0)) \end{aligned}$$

Thus we obtain a closed form solution for  $\rho$

$$\rho = \frac{\rho_1 + \rho_2 \exp(-\gamma(\rho_2 - \rho_1)(X - X_0))}{1 + \exp(-\gamma(\rho_2 - \rho_1)(X - X_0))}$$

### Solution 50.8

1.

$$\eta_t + \eta_x + 6\eta\eta_x - \eta_{xxt} = 0$$

We make the substitution

$$\eta(x, t) = z(X), \quad X = x - Ut.$$

$$(1 - U)z' + 6zz' + Uz''' = 0$$

$$(1 - U)z + 3z^2 + Uz'' = 0$$

$$\frac{1}{2}(1 - U)z^2 + z^3 + \frac{1}{2}U(z')^2 = 0$$

$$(z')^2 = \frac{U - 1}{U}z^2 - \frac{2}{U}z^3$$

$$z(X) = \frac{U - 1}{2} \operatorname{sech}^2 \left( \frac{1}{2} \sqrt{\frac{U - 1}{U}} X \right)$$

$$\eta(x, t) = \frac{U - 1}{2} \operatorname{sech}^2 \left( \frac{1}{2} \left( \sqrt{\frac{U - 1}{U}} x - \sqrt{(U - 1)Ut} \right) \right)$$

The linearized equation is

$$\eta_t + \eta_x - \eta_{xxt} = 0.$$

Substituting  $\eta = e^{-\alpha x + \beta t}$  into this equation yields

$$\beta - \alpha - \alpha^2\beta = 0$$

$$\beta = \frac{\alpha}{1 - \alpha^2}.$$

We set

$$\alpha^2 = \frac{U-1}{U}.$$

$\beta$  is then

$$\begin{aligned}\beta &= \frac{\alpha}{1-\alpha^2} \\ &= \frac{\sqrt{(U-1)/U}}{1-(U-1)/U} \\ &= \frac{\sqrt{(U-1)U}}{U-(U-1)} \\ &= \sqrt{(U-1)U}.\end{aligned}$$

The solution for  $\eta$  becomes

$$\frac{\alpha\beta}{2} \operatorname{sech}^2\left(\frac{\alpha x - \beta t}{2}\right)$$

where

$$\beta = \frac{\alpha}{1-\alpha^2}.$$

2.

$$u_{tt} - u_{xx} - \left(\frac{3}{2}u^2\right)_{xx} - u_{xxxx} = 0$$

We make the substitution

$$u(x, t) = z(X), \quad X = x - Ut.$$

$$(U^2 - 1)z'' - \left(\frac{3}{2}z^2\right)'' - z'''' = 0$$

$$(U^2 - 1)z' - \left(\frac{3}{2}z^2\right)' - z''' = 0$$

$$(U^2 - 1)z - \frac{3}{2}z^2 - z'' = 0$$

We multiply by  $z'$  and integrate.

$$\frac{1}{2}(U^2 - 1)z^2 - \frac{1}{2}z^3 - \frac{1}{2}(z')^2 = 0$$

$$(z')^2 = (U^2 - 1)z^2 - z^3$$

$$z = (U^2 - 1) \operatorname{sech}^2 \left( \frac{1}{2} \sqrt{U^2 - 1} X \right)$$

$$u(x, t) = (U^2 - 1) \operatorname{sech}^2 \left( \frac{1}{2} \left( \sqrt{U^2 - 1} x - U \sqrt{U^2 - 1} t \right) \right)$$

The linearized equation is

$$u_{tt} - u_{xx} - u_{xxx} = 0.$$

Substituting  $u = e^{-\alpha x + \beta t}$  into this equation yields

$$\beta^2 - \alpha^2 - \alpha^4 = 0$$

$$\beta^2 = \alpha^2(\alpha^2 + 1).$$

We set

$$\alpha = \sqrt{U^2 - 1}.$$

$\beta$  is then

$$\begin{aligned}\beta^2 &= \alpha^2(\alpha^2 + 1) \\ &= (U^2 - 1)U^2 \\ \beta &= U\sqrt{U^2 - 1}.\end{aligned}$$

The solution for  $u$  becomes

$$u(x, t) = \alpha^2 \operatorname{sech}^2 \left( \frac{\alpha x - \beta t}{2} \right)$$

where

$$\beta^2 = \alpha^2(\alpha^2 + 1).$$

3.

$$\phi_{tt} - \phi_{xx} + 2\phi_x\phi_{xt} + \phi_{xx}\phi_t - \phi_{xxxx}$$

We make the substitution

$$\begin{aligned}\phi(x, t) &= z(X), & X &= x - Ut. \\ (U^2 - 1)z'' - 2Uz'z'' - Uz''z' - z'''' &= 0 \\ (U^2 - 1)z'' - 3Uz'z'' - z'''' &= 0 \\ (U^2 - 1)z' - \frac{3}{2}(z')^2 - z''' &= 0\end{aligned}$$

Multiply by  $z''$  and integrate.

$$\begin{aligned}\frac{1}{2}(U^2 - 1)(z')^2 - \frac{1}{2}(z')^3 - \frac{1}{2}(z'')^2 &= 0 \\ (z'')^2 &= (U^2 - 1)(z')^2 - (z')^3 \\ z' &= (U^2 - 1) \operatorname{sech}^2 \left( \frac{1}{2}\sqrt{U^2 - 1}X \right) \\ \phi_x(x, t) &= (U^2 - 1) \operatorname{sech}^2 \left( \frac{1}{2} \left( \sqrt{U^2 - 1}x - U\sqrt{U^2 - 1}t \right) \right).\end{aligned}$$



The linearized equation is

$$\phi_{tt} - \phi_{xx} - \phi_{xxxx}$$

Substituting  $\phi = e^{-\alpha x + \beta t}$  into this equation yields

$$\beta^2 = \alpha^2(\alpha^2 + 1).$$

The solution for  $\phi_x$  becomes

$$\phi_x = \alpha^2 \operatorname{sech}^2\left(\frac{\alpha x - \beta t}{2}\right)$$

where

$$\beta^2 = \alpha^2(\alpha^2 + 1).$$

4.

$$u_t + 30u^2u_1 + 20u_1u_2 + 10uu_3 + u_5 = 0$$

We make the substitution

$$u(x, t) = z(X), \quad X = x - Ut.$$

$$-Uz' + 30z^2z' + 20z'z'' + 10zz''' + z^{(5)} = 0$$

Note that  $(zz'')' = z'z'' + zz'''$ .

$$-Uz' + 30z^2z' + 10z'z'' + 10(zz'')' + z^{(5)} = 0$$

$$-Uz + 10z^3 + 5(z')^2 + 10zz'' + z^{(4)} = 0$$

Multiply by  $z'$  and integrate.

$$-\frac{1}{2}Uz^2 + \frac{5}{2}z^4 + 5z(z')^2 - \frac{1}{2}(z'')^2 + z'z''' = 0$$

Assume that

$$(z')^2 = P(z).$$

Differentiating this relation,

$$\begin{aligned}2z'z'' &= P'(z)z' \\z'' &= \frac{1}{2}P'(z) \\z''' &= \frac{1}{2}P''(z)z' \\z'''z' &= \frac{1}{2}P''(z)P(z).\end{aligned}$$

Substituting these expressions into the differential equation for  $z$ ,

$$\begin{aligned}-\frac{1}{2}Uz^2 + \frac{5}{2}z^4 + 5zP(z) - \frac{1}{2}\frac{1}{4}(P'(z))^2 + \frac{1}{2}P''(z)P(z) &= 0 \\4Uz^2 + 20z^4 + 40zP(z) - (P'(z))^2 + 4P''(z)P(z) &= 0\end{aligned}$$

Substituting  $P(z) = az^3 + bz^2$  yields

$$(20 + 40a + 15a^2)z^4 + (40b + 20ab)z^3 + (4b^2 + 4U)z^2 = 0$$

This equation is satisfied by  $b^2 = U$ ,  $a = -2$ . Thus we have

$$\begin{aligned}(z')^2 &= \sqrt{U}z^2 - 2z^3 \\z &= \frac{\sqrt{U}}{2} \operatorname{sech}^2\left(\frac{1}{2}U^{1/4}X\right) \\u(x, t) &= \frac{\sqrt{U}}{2} \operatorname{sech}^2\left(\frac{1}{2}(U^{1/4}x - U^{5/4}t)\right)\end{aligned}$$

The linearized equation is

$$u_t + u_5 = 0.$$

Substituting  $u = e^{-\alpha x + \beta t}$  into this equation yields

$$\beta - \alpha^5 = 0.$$

We set

$$\alpha = U^{1/4}.$$

The solution for  $u(x, t)$  becomes

$$\frac{\alpha^2}{2} \operatorname{sech}^2 \left( \frac{\alpha x - \beta t}{2} \right)$$

where

$$\beta = \alpha^5.$$

**Part VIII**  
**Appendices**

# Appendix A

## Greek Letters

The following table shows the greek letters, (some of them have two typeset variants), and their corresponding Roman letters.

<i>Name</i>	<i>Roman</i>	<i>Lower</i>	<i>Upper</i>
alpha	a	$\alpha$	
beta	b	$\beta$	
chi	c	$\chi$	
delta	d	$\delta$	$\Delta$
epsilon	e	$\epsilon$	
epsilon (variant)	e	$\varepsilon$	
phi	f	$\phi$	$\Phi$
phi (variant)	f	$\varphi$	
gamma	g	$\gamma$	$\Gamma$
eta	h	$\eta$	
iota	i	$\iota$	
kappa	k	$\kappa$	
lambda	l	$\lambda$	$\Lambda$
mu	m	$\mu$	

nu	n	$\nu$	
omicron	o	$o$	
pi	p	$\pi$	$\Pi$
pi (variant)	p	$\varpi$	
theta	q	$\theta$	$\Theta$
theta (variant)	q	$\vartheta$	
rho	r	$\rho$	
rho (variant)	r	$\varrho$	
sigma	s	$\sigma$	$\Sigma$
sigma (variant)	s	$\varsigma$	
tau	t	$\tau$	
upsilon	u	$\upsilon$	$\Upsilon$
omega	w	$\omega$	$\Omega$
xi	x	$\xi$	$\Xi$
psi	y	$\psi$	$\Psi$
zeta	z	$\zeta$	

# Appendix B

## Notation

$C$	class of continuous functions
$C^n$	class of $n$ -times continuously differentiable functions
$\mathbb{C}$	set of complex numbers
$\delta(x)$	Dirac delta function
$\mathcal{F}[\cdot]$	Fourier transform
$\mathcal{F}_c[\cdot]$	Fourier cosine transform
$\mathcal{F}_s[\cdot]$	Fourier sine transform
$\gamma$	Euler's constant, $\gamma = \int_0^\infty e^{-x} \text{Log } x \, dx$
$\Gamma(\nu)$	Gamma function
$H(x)$	Heaviside function
$H_\nu^{(1)}(x)$	Hankel function of the first kind and order $\nu$
$H_\nu^{(2)}(x)$	Hankel function of the second kind and order $\nu$
$i$	$i \equiv \sqrt{-1}$
$J_\nu(x)$	Bessel function of the first kind and order $\nu$
$K_\nu(x)$	Modified Bessel function of the first kind and order $\nu$
$\mathcal{L}[\cdot]$	Laplace transform

$\mathbb{N}$	set of natural numbers, (positive integers)
$N_\nu(x)$	Modified Bessel function of the second kind and order $\nu$
$\mathbb{R}$	set of real numbers
$\mathbb{R}^+$	set of positive real numbers
$\mathbb{R}^-$	set of negative real numbers
$o(z)$	terms smaller than $z$
$\mathcal{O}(z)$	terms no bigger than $z$
$\mathcal{f}$	principal value of the integral
$\psi(\nu)$	digamma function, $\psi(\nu) = \frac{d}{d\nu} \log \Gamma(\nu)$
$\psi^{(n)}(\nu)$	polygamma function, $\psi^{(n)}(\nu) = \frac{d^n}{d\nu^n} \psi(\nu)$
$u^{(n)}(x)$	$\frac{\partial^n u}{\partial x^n}$
$u^{(n,m)}(x, y)$	$\frac{\partial^{n+m} u}{\partial x^n \partial y^m}$
$Y_\nu(x)$	Bessel function of the second kind and order $\nu$ , Neumann function
$\mathbb{Z}$	set of integers
$\mathbb{Z}^+$	set of positive integers



# Appendix C

## Formulas from Complex Variables

**Analytic Functions.** A function  $f(z)$  is analytic in a domain if the derivative  $f'(z)$  exists in that domain.

If  $f(z) = u(x, y) + v(x, y)$  is defined in some neighborhood of  $z_0 = x_0 + iy_0$  and the partial derivatives of  $u$  and  $v$  are continuous and satisfy the **Cauchy-Riemann equations**

$$u_x = v_y, \quad u_y = -v_x,$$

then  $f'(z_0)$  exists.

**Residues.** If  $f(z)$  has the Laurent expansion

$$f(z) = \sum_{n=-\infty}^{\infty} a_n z^n,$$

then the residue of  $f(z)$  at  $z = z_0$  is

$$\operatorname{Res}(f(z), z_0) = a_{-1}.$$

**Residue Theorem.** Let  $C$  be a positively oriented, simple, closed contour. If  $f(z)$  is analytic in and on  $C$  except for isolated singularities at  $z_1, z_2, \dots, z_N$  inside  $C$  then

$$\oint_C f(z) dz = i2\pi \sum_{n=1}^N \text{Res}(f(z), z_n).$$

If in addition  $f(z)$  is analytic outside  $C$  in the finite complex plane then

$$\oint_C f(z) dz = i2\pi \text{Res} \left( \frac{1}{z^2} f \left( \frac{1}{z} \right), 0 \right).$$

**Residues of a pole of order  $n$ .** If  $f(z)$  has a pole of order  $n$  at  $z = z_0$  then

$$\text{Res}(f(z), z_0) = \lim_{z \rightarrow z_0} \left( \frac{1}{(n-1)!} \frac{d^{n-1}}{dz^{n-1}} [(z - z_0)^n f(z)] \right).$$

**Jordan's Lemma.**

$$\int_0^\pi e^{-R \sin \theta} d\theta < \frac{\pi}{R}.$$

Let  $a$  be a positive constant. If  $f(z)$  vanishes as  $|z| \rightarrow \infty$  then the integral

$$\int_C f(z) e^{iaz} dz$$

along the semi-circle of radius  $R$  in the upper half plane vanishes as  $R \rightarrow \infty$ .

**Taylor Series.** Let  $f(z)$  be a function that is analytic and single valued in the disk  $|z - z_0| < R$ .

$$f(z) = \sum_{n=0}^{\infty} \frac{f^{(n)}(z_0)}{n!} (z - z_0)^n$$

The series converges for  $|z - z_0| < R$ .

**Laurent Series.** Let  $f(z)$  be a function that is analytic and single valued in the annulus  $r < |z - z_0| < R$ . In this annulus  $f(z)$  has the convergent series,

$$f(z) = \sum_{n=-\infty}^{\infty} c_n (z - z_0)^n,$$

where

$$c_n = \frac{1}{i2\pi} \oint \frac{f(z)}{(z - z_0)^{n+1}} dz$$

and the path of integration is any simple, closed, positive contour around  $z_0$  and lying in the annulus. The path of integration is shown in Figure C.1.

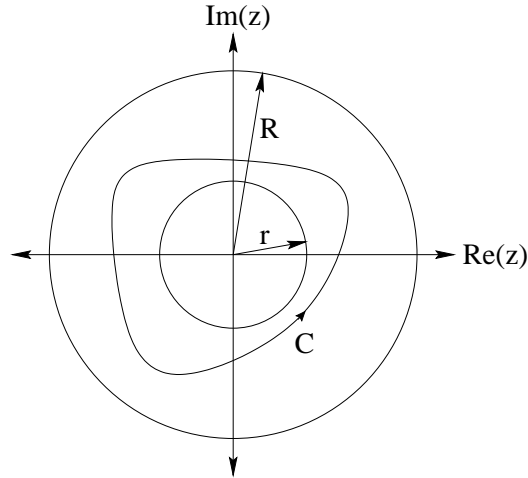

Figure C.1: The Path of Integration.

# Appendix D

## Table of Derivatives

Note:  $c$  denotes a constant and  $'$  denotes differentiation.

$$\frac{d}{dx}(fg) = \frac{df}{dx}g + f\frac{dg}{dx}$$

$$\frac{d}{dx} \frac{f}{g} = \frac{f'g - fg'}{g^2}$$

$$\frac{d}{dx} f^c = cf^{c-1}f'$$

$$\frac{d}{dx} f(g) = f'(g)g'$$

$$\frac{d^2}{dx^2} f(g) = f''(g)(g')^2 + f'g''$$

$$\frac{d^n}{dx^n}(fg) = \binom{n}{0} \frac{d^n f}{dx^n} g + \binom{n}{1} \frac{d^{n-1} f}{dx^{n-1}} \frac{dg}{dx} + \binom{n}{2} \frac{d^{n-2} f}{dx^{n-2}} \frac{d^2 g}{dx^2} + \cdots + \binom{n}{n} f \frac{d^n g}{dx^n}$$

$$\frac{d}{dx} \ln x = \frac{1}{|x|}$$

$$\frac{d}{dx} c^x = c^x \ln c$$

$$\frac{d}{dx} f^g = g f^{g-1} \frac{df}{dx} + f^g \ln f \frac{dg}{dx}$$

$$\frac{d}{dx} \sin x = \cos x$$

$$\frac{d}{dx} \cos x = -\sin x$$

$$\frac{d}{dx} \tan x = \sec^2 x$$

$$\frac{d}{dx} \csc x = -\csc x \cot x$$

$$\frac{d}{dx} \sec x = \sec x \tan x$$

$$\frac{d}{dx} \cot x = -\csc^2 x$$

$$\frac{d}{dx} \arcsin x = \frac{1}{\sqrt{1-x^2}}, \quad -\frac{\pi}{2} \leq \arcsin x \leq \frac{\pi}{2}$$

$$\frac{d}{dx} \arccos x = -\frac{1}{\sqrt{1-x^2}}, \quad 0 \leq \arccos x \leq \pi$$

$$\frac{d}{dx} \arctan x = \frac{1}{1+x^2}, \quad -\frac{\pi}{2} \leq \arctan x \leq \frac{\pi}{2}$$

$$\frac{d}{dx} \sinh x = \cosh x$$

$$\frac{d}{dx} \cosh x = \sinh x$$

$$\frac{d}{dx} \tanh x = \operatorname{sech}^2 x$$

$$\frac{d}{dx} \operatorname{csch} x = -\operatorname{csch} x \coth x$$

$$\frac{d}{dx} \operatorname{sech} x = -\operatorname{sech} x \tanh x$$

$$\frac{d}{dx} \coth x = -\operatorname{csch}^2 x$$

$$\frac{d}{dx} \operatorname{arcsinh} x = \frac{1}{\sqrt{x^2+1}}$$

$$\frac{d}{dx} \operatorname{arccosh} x = \frac{1}{\sqrt{x^2-1}}, \quad x > 1, \operatorname{arccosh} x > 0$$

$$\frac{d}{dx} \operatorname{arctanh} x = \frac{1}{1-x^2}, \quad x^2 < 1$$

$$\frac{d}{dx} \int_c^x f(\xi) d\xi = f(x)$$

$$\frac{d}{dx} \int_x^c f(\xi) d\xi = -f(x)$$

$$\frac{d}{dx} \int_g^h f(\xi, x) d\xi = \int_g^h \frac{\partial f(\xi, x)}{\partial x} d\xi + f(h, x)h' - f(g, x)g'$$

# Appendix E

## Table of Integrals

$$\int u \frac{dv}{dx} dx = uv - \int v \frac{du}{dx} dx$$

$$\int \frac{f'(x)}{f(x)} dx = \log f(x)$$

$$\int \frac{f'(x)}{2\sqrt{f(x)}} dx = \sqrt{f(x)}$$

$$\int x^\alpha dx = \frac{x^{\alpha+1}}{\alpha+1} \quad \text{for } \alpha \neq -1$$

$$\int \frac{1}{x} dx = \log x$$

$$\int e^{ax} dx = \frac{e^{ax}}{a}$$



$$\int a^{bx} dx = \frac{a^{bx}}{b \log a} \quad \text{for } a > 0$$

$$\int \log x dx = x \log x - x$$

$$\int \frac{1}{x^2 + a^2} dx = \frac{1}{a} \arctan \frac{x}{a}$$

$$\int \frac{1}{x^2 - a^2} dx = \begin{cases} \frac{1}{2a} \log \frac{a-x}{a+x} & \text{for } x^2 < a^2 \\ \frac{1}{2a} \log \frac{x-a}{x+a} & \text{for } x^2 > a^2 \end{cases}$$

$$\int \frac{1}{\sqrt{a^2 - x^2}} dx = \arcsin \frac{x}{|a|} = -\arccos \frac{x}{|a|} \quad \text{for } x^2 < a^2$$

$$\int \frac{1}{\sqrt{x^2 \pm a^2}} dx = \log(x + \sqrt{x^2 \pm a^2})$$

$$\int \frac{1}{x\sqrt{x^2 - a^2}} dx = \frac{1}{|a|} \sec^{-1} \frac{x}{a}$$

$$\int \frac{1}{x\sqrt{a^2 \pm x^2}} dx = -\frac{1}{a} \log \left( \frac{a + \sqrt{a^2 \pm x^2}}{x} \right)$$

$$\int \sin(ax) dx = -\frac{1}{a} \cos(ax)$$

$$\int \cos(ax) dx = \frac{1}{a} \sin(ax)$$

$$\int \tan(ax) dx = -\frac{1}{a} \log \cos(ax)$$

$$\int \csc(ax) dx = \frac{1}{a} \log \tan \frac{ax}{2}$$

$$\int \sec(ax) dx = \frac{1}{a} \log \tan \left( \frac{\pi}{4} + \frac{ax}{2} \right)$$

$$\int \cot(ax) dx = \frac{1}{a} \log \sin(ax)$$

$$\int \sinh(ax) dx = \frac{1}{a} \cosh(ax)$$

$$\int \cosh(ax) dx = \frac{1}{a} \sinh(ax)$$

$$\int \tanh(ax) dx = \frac{1}{a} \log \cosh(ax)$$

$$\int \operatorname{csch}(ax) dx = \frac{1}{a} \log \tanh \frac{ax}{2}$$

$$\int \operatorname{sech}(ax) dx = \frac{i}{a} \log \tanh \left( \frac{i\pi}{4} + \frac{ax}{2} \right)$$

$$\int \operatorname{coth}(ax) dx = \frac{1}{a} \log \sinh(ax)$$

$$\int x \sin ax \, dx = \frac{1}{a^2} \sin ax - \frac{x}{a} \cos ax$$

$$\int x^2 \sin ax \, dx = \frac{2x}{a^2} \sin ax - \frac{a^2 x^2 - 2}{a^3} \cos ax$$

$$\int x \cos ax \, dx = \frac{1}{a^2} \cos ax + \frac{x}{a} \sin ax$$

$$\int x^2 \cos ax \, dx = \frac{2x \cos ax}{a^2} + \frac{a^2 x^2 - 2}{a^3} \sin ax$$

# Appendix F

## Definite Integrals

**Integrals from  $-\infty$  to  $\infty$ .** Let  $f(z)$  be analytic except for isolated singularities, none of which lie on the real axis. Let  $a_1, \dots, a_m$  be the singularities of  $f(z)$  in the upper half plane; and  $C_R$  be the semi-circle from  $R$  to  $-R$  in the upper half plane. If

$$\lim_{R \rightarrow \infty} \left( R \max_{z \in C_R} |f(z)| \right) = 0$$

then

$$\int_{-\infty}^{\infty} f(x) dx = i2\pi \sum_{j=1}^m \operatorname{Res}(f(z), a_j).$$

Let  $b_1, \dots, b_n$  be the singularities of  $f(z)$  in the lower half plane. Let  $C_R$  be the semi-circle from  $R$  to  $-R$  in the lower half plane. If

$$\lim_{R \rightarrow \infty} \left( R \max_{z \in C_R} |f(z)| \right) = 0$$

then

$$\int_{-\infty}^{\infty} f(x) dx = -i2\pi \sum_{j=1}^n \operatorname{Res}(f(z), b_j).$$

**Integrals from 0 to  $\infty$ .** Let  $f(z)$  be analytic except for isolated singularities, none of which lie on the positive real axis,  $[0, \infty)$ . Let  $z_1, \dots, z_n$  be the singularities of  $f(z)$ . If  $f(z) \ll z^\alpha$  as  $z \rightarrow 0$  for some  $\alpha > -1$  and  $f(z) \ll z^\beta$  as  $z \rightarrow \infty$  for some  $\beta < -1$  then

$$\int_0^\infty f(x) dx = - \sum_{k=1}^n \operatorname{Res}(f(z) \log z, z_k).$$

$$\int_0^\infty f(x) \log x dx = -\frac{1}{2} \sum_{k=1}^n \operatorname{Res}(f(z) \log^2 z, z_k) + i\pi \sum_{k=1}^n \operatorname{Res}(f(z) \log z, z_k)$$

Assume that  $a$  is not an integer. If  $z^a f(z) \ll z^\alpha$  as  $z \rightarrow 0$  for some  $\alpha > -1$  and  $z^a f(z) \ll z^\beta$  as  $z \rightarrow \infty$  for some  $\beta < -1$  then

$$\int_0^\infty x^a f(x) dx = \frac{i2\pi}{1 - e^{i2\pi a}} \sum_{k=1}^n \operatorname{Res}(z^a f(z), z_k).$$

$$\int_0^\infty x^a f(x) \log x dx = \frac{i2\pi}{1 - e^{i2\pi a}} \sum_{k=1}^n \operatorname{Res}(z^a f(z) \log z, z_k) + \frac{\pi^2 a}{\sin^2(\pi a)} \sum_{k=1}^n \operatorname{Res}(z^a f(z), z_k)$$

**Fourier Integrals.** Let  $f(z)$  be analytic except for isolated singularities, none of which lie on the real axis. Suppose that  $f(z)$  vanishes as  $|z| \rightarrow \infty$ . If  $\omega$  is a positive real number then

$$\int_{-\infty}^\infty f(x) e^{i\omega x} dx = i2\pi \sum_{k=1}^n \operatorname{Res}(f(z) e^{i\omega z}, z_k),$$

where  $z_1, \dots, z_n$  are the singularities of  $f(z)$  in the upper half plane. If  $\omega$  is a negative real number then

$$\int_{-\infty}^\infty f(x) e^{i\omega x} dx = -i2\pi \sum_{k=1}^n \operatorname{Res}(f(z) e^{i\omega z}, z_k),$$

where  $z_1, \dots, z_n$  are the singularities of  $f(z)$  in the lower half plane.

# Appendix G

## Table of Sums

$$\sum_{n=1}^{\infty} r^n = \frac{r}{1-r}, \quad \text{for } |r| < 1$$

$$\sum_{n=1}^N r^n = \frac{r - r^{N+1}}{1-r}$$

$$\sum_{n=a}^b n = \frac{(a+b)(b+1-a)}{2}$$

$$\sum_{n=1}^N n = \frac{N(N+1)}{2}$$

$$\sum_{n=a}^b n^2 = \frac{b(b+1)(2b+1) - a(a-1)(2a-1)}{6}$$

$$\sum_{n=1}^N n^2 = \frac{N(N+1)(2N+1)}{6}$$

$$\sum_{n=1}^{\infty} \frac{(-1)^{n+1}}{n} = \log(2)$$

$$\sum_{n=1}^{\infty} \frac{1}{n^2} = \frac{\pi^2}{6}$$

$$\sum_{n=1}^{\infty} \frac{(-1)^{n+1}}{n^2} = \frac{\pi^2}{12}$$

$$\sum_{n=1}^{\infty} \frac{1}{n^3} = \zeta(3)$$

$$\sum_{n=1}^{\infty} \frac{(-1)^{n+1}}{n^3} = \frac{3\zeta(3)}{4}$$

$$\sum_{n=1}^{\infty} \frac{1}{n^4} = \frac{\pi^4}{90}$$

$$\sum_{n=1}^{\infty} \frac{(-1)^{n+1}}{n^4} = \frac{7\pi^4}{720}$$

$$\sum_{n=1}^{\infty} \frac{1}{n^5} = \zeta(5)$$

$$\sum_{n=1}^{\infty} \frac{(-1)^{n+1}}{n^5} = \frac{15\zeta(5)}{16}$$

$$\sum_{n=1}^{\infty} \frac{1}{n^6} = \frac{\pi^6}{945}$$

$$\sum_{n=1}^{\infty} \frac{(-1)^{n+1}}{n^6} = \frac{31\pi^6}{30240}$$



# Appendix H

## Table of Taylor Series

$$(1 - z)^{-1} = \sum_{n=0}^{\infty} z^n \quad |z| < 1$$

$$(1 - z)^{-2} = \sum_{n=0}^{\infty} (n + 1)z^n \quad |z| < 1$$

$$(1 + z)^\alpha = \sum_{n=0}^{\infty} \binom{\alpha}{n} z^n \quad |z| < 1$$

$$e^z = \sum_{n=0}^{\infty} \frac{z^n}{n!} \quad |z| < \infty$$

$$\log(1 - z) = - \sum_{n=1}^{\infty} \frac{z^n}{n} \quad |z| < 1$$

$$\log \left( \frac{1+z}{1-z} \right) = 2 \sum_{n=1}^{\infty} \frac{z^{2n-1}}{2n-1} \quad |z| < 1$$

$$\cos z = \sum_{n=0}^{\infty} \frac{(-1)^n z^{2n}}{(2n)!} \quad |z| < \infty$$

$$\sin z = \sum_{n=0}^{\infty} \frac{(-1)^n z^{2n+1}}{(2n+1)!} \quad |z| < \infty$$

$$\tan z = z + \frac{z^3}{3} + \frac{2z^5}{15} + \frac{17z^7}{315} + \dots \quad |z| < \frac{\pi}{2}$$

$$\cos^{-1} z = \frac{\pi}{2} - \left( z + \frac{z^3}{2 \cdot 3} + \frac{1 \cdot 3 z^5}{2 \cdot 4 \cdot 5} + \frac{1 \cdot 3 \cdot 5 z^7}{2 \cdot 4 \cdot 6 \cdot 7} + \dots \right) \quad |z| < 1$$

$$\sin^{-1} z = z + \frac{z^3}{2 \cdot 3} + \frac{1 \cdot 3 z^5}{2 \cdot 4 \cdot 5} + \frac{1 \cdot 3 \cdot 5 z^7}{2 \cdot 4 \cdot 6 \cdot 7} + \dots \quad |z| < 1$$

$$\tan^{-1} z = \sum_{n=1}^{\infty} \frac{(-1)^{n+1} z^{2n-1}}{2n-1} \quad |z| < 1$$

$$\cosh z = \sum_{n=0}^{\infty} \frac{z^{2n}}{(2n)!} \quad |z| < \infty$$

$$\sinh z = \sum_{n=0}^{\infty} \frac{z^{2n+1}}{(2n+1)!} \quad |z| < \infty$$

$$\tanh z = z - \frac{z^3}{3} + \frac{2z^5}{15} - \frac{17z^7}{315} + \cdots \quad |z| < \frac{\pi}{2}$$

$$J_\nu(z) = \sum_{n=0}^{\infty} \frac{(-1)^n}{n! \Gamma(\nu + n + 1)} \left(\frac{z}{2}\right)^{\nu+2n} \quad |z| < \infty$$

$$I_\nu(z) = \sum_{n=0}^{\infty} \frac{1}{n! \Gamma(\nu + n + 1)} \left(\frac{z}{2}\right)^{\nu+2n} \quad |z| < \infty$$

# Appendix I

## Continuous Transforms

### I.1 Properties of Laplace Transforms

Let  $f(t)$  be piecewise continuous and of exponential order  $\alpha$ . Unless otherwise noted, the transform is defined for  $s > 0$ . To reduce clutter, it is understood that the Heaviside function  $H(t)$  multiplies the original function in the following two tables.

$$f(t) \qquad \int_0^{\infty} e^{-st} f(t) dt$$

$$\frac{1}{i2\pi} \int_{c-i\infty}^{c+i\infty} e^{ts} \hat{f}(s) ds \qquad \hat{f}(s)$$

$$af(t) + bg(t) \qquad a\hat{f}(s) + b\hat{g}(s)$$

$$\frac{d}{dt} f(t) \qquad s\hat{f}(s) - f(0)$$

$\frac{d^2}{dt^2} f(t)$	$s^2 \hat{f}(s) - sf(0) - f'(0)$	
$\frac{d^n}{dt^n} f(t)$	$s^n \hat{f}(s) - s^{n-1} f(0) - s^{n-2} f'(0) - \dots - f^{(n-1)}(0)$	
$\int_0^t f(\tau) d\tau$	$\frac{\hat{f}(s)}{s}$	
$\int_0^t \int_0^\tau f(s) ds d\tau$	$\frac{\hat{f}(s)}{s^2}$	
$e^{ct} f(t)$	$\hat{f}(s - c)$	$s > c + \alpha$
$\frac{1}{c} f\left(\frac{t}{c}\right), \quad c > 0$	$\hat{f}(cs)$	
$\frac{1}{c} e^{(b/c)t} f\left(\frac{t}{c}\right), \quad c > 0$	$\hat{f}(cs - b)$	
$f(t - c)H(t - c), \quad c > 0$	$e^{-cs} \hat{f}(s)$	
$tf(t)$	$-\frac{d}{ds} \hat{f}(s)$	
$t^n f(t)$	$(-1)^n \frac{d^n}{ds^n} \hat{f}(s)$	
$\frac{f(t)}{t}, \quad \int_0^1 \frac{f(t)}{t} dt \text{ exists}$	$\int_s^\infty \hat{f}(t) dt$	

$$\int_0^t f(\tau)g(t-\tau) d\tau, \quad f, g \in C^0 \quad \hat{f}(s)\hat{g}(s)$$

$$f(t), \quad f(t+T) = f(t) \quad \frac{\int_0^T e^{-st} f(t) dt}{1 - e^{-sT}}$$

$$f(t), \quad f(t+T) = -f(t) \quad \frac{\int_0^T e^{-st} f(t) dt}{1 + e^{-sT}}$$

## I.2 Table of Laplace Transforms

$f(t)$	$\int_0^{\infty} e^{-st} f(t) dt$
$\frac{1}{i2\pi} \int_{c-i\infty}^{c+i\infty} e^{ts} \hat{f}(s) ds$	$\hat{f}(s)$
1	$\frac{1}{s}$
$t$	$\frac{1}{s^2}$
$t^n$ , for $n = 0, 1, 2, \dots$	$\frac{n!}{s^{n+1}}$
$t^{1/2}$	$\frac{\sqrt{\pi}}{2} s^{-3/2}$
$t^{-1/2}$	$\sqrt{\pi} s^{-1/2}$
$t^{n-1/2}$ , $n \in \mathbb{Z}^+$	$\frac{(1)(3)(5) \cdots (2n-1)\sqrt{\pi}}{2^n} s^{-n-1/2}$
$t^\nu$ , $\Re(\nu) > -1$	$\frac{\Gamma(\nu+1)}{s^{\nu+1}}$
$\text{Log } t$	$\frac{-\gamma - \text{Log } s}{s}$

$t^\nu \text{Log } t, \quad \Re(\nu) > -1$	$\frac{\Gamma(\nu + 1)}{s^{\nu+1}}(\psi(\nu + 1) - \text{Log } s)$	
$\delta(t)$	1	$s > 0$
$\delta^{(n)}(t), \quad n \in \mathbb{Z}^{0+}$	$s^n$	$s > 0$
$e^{ct}$	$\frac{1}{s - c}$	$s > c$
$t e^{ct}$	$\frac{1}{(s - c)^2}$	$s > c$
$\frac{t^{n-1} e^{ct}}{(n - 1)!}, n \in \mathbb{Z}^+$	$\frac{1}{(s - c)^n}$	$s > c$
$\sin(ct)$	$\frac{c}{s^2 + c^2}$	
$\cos(ct)$	$\frac{s}{s^2 + c^2}$	
$\sinh(ct)$	$\frac{c}{s^2 - c^2}$	$s >  c $
$\cosh(ct)$	$\frac{s}{s^2 - c^2}$	$s >  c $
$t \sin(ct)$	$\frac{2cs}{(s^2 + c^2)^2}$	
$t \cos(ct)$	$\frac{s^2 - c^2}{(s^2 + c^2)^2}$	



$t^n e^{ct}, \quad n \in \mathbb{Z}^+$	$\frac{n!}{(s-c)^{n+1}}$	
$e^{dt} \sin(ct)$	$\frac{c}{(s-d)^2 + c^2}$	$s > d$
$e^{dt} \cos(ct)$	$\frac{s-d}{(s-d)^2 + c^2}$	$s > d$
$\delta(t-c)$	$\begin{cases} 0 & \text{for } c < 0 \\ e^{-sc} & \text{for } c > 0 \end{cases}$	
$H(t-c) = \begin{cases} 0 & \text{for } t < c \\ 1 & \text{for } t > c \end{cases}$	$\frac{1}{s} e^{-cs}$	
$J_\nu(ct)$	$\frac{c^\nu}{\sqrt{s^2 + c^2} (s + \sqrt{s^2 + c^2})^\nu}$	$\nu > -1$
$I_\nu(ct)$	$\frac{c^\nu}{\sqrt{s^2 - c^2} (s - \sqrt{s^2 - c^2})^\nu}$	$\Re(s) > c, \nu > -1$

## I.3 Table of Fourier Transforms

$f(\mathbf{x})$	$\frac{1}{2\pi} \int_{-\infty}^{\infty} f(\mathbf{x}) e^{-i\omega\mathbf{x}} d\mathbf{x}$
$\int_{-\infty}^{\infty} F(\omega) e^{i\omega x} d\omega$	$F(\omega)$
$af(x) + bg(x)$	$aF(\omega) + bG(\omega)$
$f^{(n)}(x)$	$(i\omega)^n F(\omega)$
$x^n f(x)$	$i^n F^{(n)}(\omega)$
$f(x + c)$	$e^{i\omega c} F(\omega)$
$e^{-icx} f(x)$	$F(\omega + c)$
$f(cx)$	$ c ^{-1} F(\omega/c)$
$f(x)g(x)$	$F * G(\omega) = \int_{-\infty}^{\infty} F(\eta)G(\omega - \eta) d\eta$
$\frac{1}{2\pi} f * g(x) = \frac{1}{2\pi} \int_{-\infty}^{\infty} f(\xi)g(x - \xi) d\xi$	$F(\omega)G(\omega)$
$e^{-cx^2}, \quad c > 0$	$\frac{1}{\sqrt{4\pi c}} e^{-\omega^2/4c}$

$e^{-c x }, \quad c > 0$	$\frac{c/\pi}{\omega^2 + c^2}$
$\frac{2c}{x^2 + c^2}, \quad c > 0$	$e^{-c \omega }$
$\frac{1}{x - i\alpha}, \quad \alpha > 0$	$\begin{cases} 0 & \text{for } \omega > 0 \\ i e^{\alpha\omega} & \text{for } \omega < 0 \end{cases}$
$\frac{1}{x - i\alpha}, \quad \alpha < 0$	$\begin{cases} i e^{\alpha\omega} & \text{for } \omega > 0 \\ 0 & \text{for } \omega < 0 \end{cases}$
$\frac{1}{x}$	$-\frac{i}{2} \text{sign}(\omega)$
$H(x - c) = \begin{cases} 0 & \text{for } x < c \\ 1 & \text{for } x > c \end{cases}$	$\frac{1}{i2\pi\omega} e^{-i c\omega}$
$e^{-cx} H(x), \quad \Re(c) > 0$	$\frac{1}{2\pi(c + i\omega)}$
$e^{cx} H(-x), \quad \Re(c) > 0$	$\frac{1}{2\pi(c - i\omega)}$
1	$\delta(\omega)$
$\delta(x - \xi)$	$\frac{1}{2\pi} e^{-i\omega\xi}$
$\pi(\delta(x + \xi) + \delta(x - \xi))$	$\cos(\omega\xi)$

$$-i\pi(\delta(x + \xi) - \delta(x - \xi)) \quad \sin(\omega\xi)$$

$$H(c - |x|) = \begin{cases} 1 & \text{for } |x| < c \\ 0 & \text{for } |x| > c \end{cases}, c > 0 \quad \frac{\sin(c\omega)}{\pi\omega}$$

## I.4 Table of Fourier Transforms in n Dimensions

$$f(\mathbf{x}) \quad \frac{1}{(2\pi)^n} \int_{\mathbb{R}^n} f(\mathbf{x}) e^{-i\boldsymbol{\omega}\mathbf{x}} d\mathbf{x}$$

$$\int_{\mathbb{R}^n} F(\boldsymbol{\omega}) e^{i\boldsymbol{\omega}\mathbf{x}} d\boldsymbol{\omega} \quad F(\boldsymbol{\omega})$$

$$af(x) + bg(x) \quad aF(\omega) + bG(\omega)$$

$$\left(\frac{\pi}{c}\right)^{n/2} e^{-nx^2/4c} \quad e^{-c\omega^2}$$

## I.5 Table of Fourier Cosine Transforms

$$f(x) \qquad \frac{1}{\pi} \int_0^{\infty} f(x) \cos(\omega x) dx$$

$$2 \int_0^{\infty} C(\omega) \cos(\omega x) d\omega \qquad C(\omega)$$

$$f'(x) \qquad \omega S(\omega) - \frac{1}{\pi} f(0)$$

$$f''(x) \qquad -\omega^2 C(\omega) - \frac{1}{\pi} f'(0)$$

$$xf(x) \qquad \frac{\partial}{\partial \omega} \mathcal{F}_s[f(x)]$$

$$f(cx), \quad c > 0 \qquad \frac{1}{c} C\left(\frac{\omega}{c}\right)$$

$$\frac{2c}{x^2 + c^2} \qquad e^{-c\omega}$$

$$e^{-cx} \qquad \frac{c/\pi}{\omega^2 + c^2}$$

$$e^{-cx^2} \qquad \frac{1}{\sqrt{4\pi c}} e^{-\omega^2/(4c)}$$

$$\sqrt{\frac{\pi}{c}} e^{-x^2/(4c)} \qquad e^{-c\omega^2}$$

## I.6 Table of Fourier Sine Transforms

$$f(x) \qquad \frac{1}{\pi} \int_0^{\infty} f(x) \sin(\omega x) dx$$

$$2 \int_0^{\infty} S(\omega) \sin(\omega x) d\omega \qquad S(\omega)$$

$$f'(x) \qquad -\omega C(\omega)$$

$$f''(x) \qquad -\omega^2 S(\omega) + \frac{1}{\pi} \omega f(0)$$

$$xf(x) \qquad -\frac{\partial}{\partial \omega} \mathcal{F}_c[f(x)]$$

$$f(cx), \quad c > 0 \qquad \frac{1}{c} S\left(\frac{\omega}{c}\right)$$

$$\frac{2x}{x^2 + c^2} \qquad e^{-c\omega}$$

$$e^{-cx} \qquad \frac{\omega/\pi}{\omega^2 + c^2}$$

$$2 \arctan\left(\frac{x}{c}\right) \qquad \frac{1}{\omega} e^{-c\omega}$$

$$\frac{1}{x} e^{-cx} \qquad \frac{1}{\pi} \arctan\left(\frac{\omega}{c}\right)$$

1	$\frac{1}{\pi\omega}$
$\frac{2}{x}$	1
$x e^{-cx^2}$	$\frac{\omega}{4c^{3/2}\sqrt{\pi}} e^{-\omega^2/(4c)}$
$\frac{\sqrt{\pi}x}{2c^{3/2}} e^{-x^2/(4c)}$	$\omega e^{-c\omega^2}$



# Appendix J

## Table of Wronskians

$W [x - a, x - b]$	$b - a$
$W [e^{ax}, e^{bx}]$	$(b - a) e^{(a+b)x}$
$W [\cos(ax), \sin(ax)]$	$a$
$W [\cosh(ax), \sinh(ax)]$	$a$
$W [e^{ax} \cos(bx), e^{ax} \sin(bx)]$	$b e^{2ax}$
$W [e^{ax} \cosh(bx), e^{ax} \sinh(bx)]$	$b e^{2ax}$
$W [\sin(c(x - a)), \sin(c(x - b))]$	$c \sin(c(b - a))$
$W [\cos(c(x - a)), \cos(c(x - b))]$	$c \sin(c(b - a))$
$W [\sin(c(x - a)), \cos(c(x - b))]$	$-c \cos(c(b - a))$

$W [\sinh(c(x - a)), \sinh(c(x - b))]$	$c \sinh(c(b - a))$
$W [\cosh(c(x - a)), \cosh(c(x - b))]$	$c \cosh(c(b - a))$
$W [\sinh(c(x - a)), \cosh(c(x - b))]$	$-c \cosh(c(b - a))$
$W [e^{dx} \sin(c(x - a)), e^{dx} \sin(c(x - b))]$	$c e^{2dx} \sin(c(b - a))$
$W [e^{dx} \cos(c(x - a)), e^{dx} \cos(c(x - b))]$	$c e^{2dx} \sin(c(b - a))$
$W [e^{dx} \sin(c(x - a)), e^{dx} \cos(c(x - b))]$	$-c e^{2dx} \cos(c(b - a))$
$W [e^{dx} \sinh(c(x - a)), e^{dx} \sinh(c(x - b))]$	$c e^{2dx} \sinh(c(b - a))$
$W [e^{dx} \cosh(c(x - a)), e^{dx} \cosh(c(x - b))]$	$-c e^{2dx} \sinh(c(b - a))$
$W [e^{dx} \sinh(c(x - a)), e^{dx} \cosh(c(x - b))]$	$-c e^{2dx} \cosh(c(b - a))$
$W [(x - a) e^{cx}, (x - b) e^{cx}]$	$(b - a) e^{2cx}$

# Appendix K

## Sturm-Liouville Eigenvalue Problems

- $y'' + \lambda^2 y = 0$ ,  $y(a) = y(b) = 0$

$$\lambda_n = \frac{n\pi}{b-a}, \quad y_n = \sin\left(\frac{n\pi(x-a)}{b-a}\right), \quad n \in \mathbb{N}$$

$$\langle y_n, y_n \rangle = \frac{b-a}{2}$$

- $y'' + \lambda^2 y = 0$ ,  $y(a) = y'(b) = 0$

$$\lambda_n = \frac{(2n-1)\pi}{2(b-a)}, \quad y_n = \sin\left(\frac{(2n-1)\pi(x-a)}{2(b-a)}\right), \quad n \in \mathbb{N}$$

$$\langle y_n, y_n \rangle = \frac{b-a}{2}$$

- $y'' + \lambda^2 y = 0$ ,  $y'(a) = y(b) = 0$

$$\lambda_n = \frac{(2n-1)\pi}{2(b-a)}, \quad y_n = \cos\left(\frac{(2n-1)\pi(x-a)}{2(b-a)}\right), \quad n \in \mathbb{N}$$

$$\langle y_n, y_n \rangle = \frac{b-a}{2}$$

- $y'' + \lambda^2 y = 0, y'(a) = y'(b) = 0$

$$\lambda_n = \frac{n\pi}{b-a}, \quad y_n = \cos\left(\frac{n\pi(x-a)}{b-a}\right), \quad n = 0, 1, 2, \dots$$

$$\langle y_0, y_0 \rangle = b-a, \quad \langle y_n, y_n \rangle = \frac{b-a}{2} \text{ for } n \in \mathbb{N}$$

# Appendix L

## Green Functions for Ordinary Differential Equations

- $G' + p(x)G = \delta(x - \xi)$ ,  $G(\xi^- : \xi) = 0$

$$G(x|\xi) = \exp\left(-\int_{\xi}^x p(t) dt\right) H(x - \xi)$$

- $y'' = 0$ ,  $y(a) = y(b) = 0$

$$G(x|\xi) = \frac{(x_{<} - a)(x_{>} - b)}{b - a}$$

- $y'' = 0$ ,  $y(a) = y'(b) = 0$

$$G(x|\xi) = a - x_{<}$$

- $y'' = 0$ ,  $y'(a) = y(b) = 0$

$$G(x|\xi) = x_{>} - b$$

- $y'' - c^2y = 0, y(a) = y(b) = 0$

$$G(x|\xi) = \frac{\sinh(c(x_{<} - a)) \sinh(c(x_{>} - b))}{c \sinh(c(b - a))}$$

- $y'' - c^2y = 0, y(a) = y'(b) = 0$

$$G(x|\xi) = -\frac{\sinh(c(x_{<} - a)) \cosh(c(x_{>} - b))}{c \cosh(c(b - a))}$$

- $y'' - c^2y = 0, y'(a) = y(b) = 0$

$$G(x|\xi) = \frac{\cosh(c(x_{<} - a)) \sinh(c(x_{>} - b))}{c \cosh(c(b - a))}$$

- $y'' + c^2y = 0, y(a) = y(b) = 0, c \neq \frac{n\pi}{b-a}, n \in \mathbb{N}$

$$G(x|\xi) = \frac{\sin(c(x_{<} - a)) \sin(c(x_{>} - b))}{c \sin(c(b - a))}$$

- $y'' + c^2y = 0, y(a) = y'(b) = 0, c \neq \frac{(2n-1)\pi}{2(b-a)}, n \in \mathbb{N}$

$$G(x|\xi) = -\frac{\sin(c(x_{<} - a)) \cos(c(x_{>} - b))}{c \cos(c(b - a))}$$

- $y'' + c^2y = 0, y'(a) = y(b) = 0, c \neq \frac{(2n-1)\pi}{2(b-a)}, n \in \mathbb{N}$

$$G(x|\xi) = \frac{\cos(c(x_{<} - a)) \sin(c(x_{>} - b))}{c \cos(c(b - a))}$$

- $y'' + 2cy' + dy = 0$ ,  $y(a) = y(b) = 0$ ,  $c^2 > d$

$$G(x|\xi) = \frac{e^{-cx} \sinh(\sqrt{c^2 - d}(x_{<} - a)) e^{-c\xi} \sinh(\sqrt{c^2 - d}(x_{>} - b))}{\sqrt{c^2 - d} e^{-2c\xi} \sinh(\sqrt{c^2 - d}(b - a))}$$

- $y'' + 2cy' + dy = 0$ ,  $y(a) = y(b) = 0$ ,  $c^2 < d$ ,  $\sqrt{d - c^2} \neq \frac{n\pi}{b-a}$ ,  $n \in \mathbb{N}$

$$G(x|\xi) = \frac{e^{-cx} \sin(\sqrt{d - c^2}(x_{<} - a)) e^{-c\xi} \sin(\sqrt{d - c^2}(x_{>} - b))}{\sqrt{d - c^2} e^{-2c\xi} \sin(\sqrt{d - c^2}(b - a))}$$

- $y'' + 2cy' + dy = 0$ ,  $y(a) = y(b) = 0$ ,  $c^2 = d$

$$G(x|\xi) = \frac{(x_{<} - a) e^{-cx} (x_{>} - b) e^{-c\xi}}{(b - a) e^{-2c\xi}}$$

# Appendix M

## Trigonometric Identities

### M.1 Circular Functions

#### Pythagorean Identities

$$\sin^2 x + \cos^2 x = 1, \quad 1 + \tan^2 x = \sec^2 x, \quad 1 + \cot^2 x = \csc^2 x$$

#### Angle Sum and Difference Identities

$$\sin(x + y) = \sin x \cos y + \cos x \sin y$$

$$\sin(x - y) = \sin x \cos y - \cos x \sin y$$

$$\cos(x + y) = \cos x \cos y - \sin x \sin y$$

$$\cos(x - y) = \cos x \cos y + \sin x \sin y$$



## Function Sum and Difference Identities

$$\sin x + \sin y = 2 \sin \frac{1}{2}(x + y) \cos \frac{1}{2}(x - y)$$

$$\sin x - \sin y = 2 \cos \frac{1}{2}(x + y) \sin \frac{1}{2}(x - y)$$

$$\cos x + \cos y = 2 \cos \frac{1}{2}(x + y) \cos \frac{1}{2}(x - y)$$

$$\cos x - \cos y = -2 \sin \frac{1}{2}(x + y) \sin \frac{1}{2}(x - y)$$

## Double Angle Identities

$$\sin 2x = 2 \sin x \cos x, \quad \cos 2x = \cos^2 x - \sin^2 x$$

## Half Angle Identities

$$\sin^2 \frac{x}{2} = \frac{1 - \cos x}{2}, \quad \cos^2 \frac{x}{2} = \frac{1 + \cos x}{2}$$

## Function Product Identities

$$\sin x \sin y = \frac{1}{2} \cos(x - y) - \frac{1}{2} \cos(x + y)$$

$$\cos x \cos y = \frac{1}{2} \cos(x - y) + \frac{1}{2} \cos(x + y)$$

$$\sin x \cos y = \frac{1}{2} \sin(x + y) + \frac{1}{2} \sin(x - y)$$

$$\cos x \sin y = \frac{1}{2} \sin(x + y) - \frac{1}{2} \sin(x - y)$$

## Exponential Identities

$$e^{ix} = \cos x + i \sin x, \quad \sin x = \frac{e^{ix} - e^{-ix}}{i2}, \quad \cos x = \frac{e^{ix} + e^{-ix}}{2}$$

## M.2 Hyperbolic Functions

### Exponential Identities

$$\sinh x = \frac{e^x - e^{-x}}{2}, \quad \cosh x = \frac{e^x + e^{-x}}{2}$$
$$\tanh x = \frac{\sinh x}{\cosh x} = \frac{e^x - e^{-x}}{e^x + e^{-x}}$$

### Reciprocal Identities

$$\operatorname{csch} x = \frac{1}{\sinh x}, \quad \operatorname{sech} x = \frac{1}{\cosh x}, \quad \operatorname{coth} x = \frac{1}{\tanh x}$$

### Pythagorean Identities

$$\cosh^2 x - \sinh^2 x = 1, \quad \tanh^2 x + \operatorname{sech}^2 x = 1$$

### Relation to Circular Functions

$$\begin{aligned} \sinh(ix) &= i \sin x & \sinh x &= -i \sin(ix) \\ \cosh(ix) &= \cos x & \cosh x &= \cos(ix) \\ \tanh(ix) &= i \tan x & \tanh x &= -i \tan(ix) \end{aligned}$$

### Angle Sum and Difference Identities

$$\begin{aligned} \sinh(x \pm y) &= \sinh x \cosh y \pm \cosh x \sinh y \\ \cosh(x \pm y) &= \cosh x \cosh y \pm \sinh x \sinh y \\ \tanh(x \pm y) &= \frac{\tanh x \pm \tanh y}{1 \pm \tanh x \tanh y} = \frac{\sinh 2x \pm \sinh 2y}{\cosh 2x \pm \cosh 2y} \\ \operatorname{coth}(x \pm y) &= \frac{1 \pm \operatorname{coth} x \operatorname{coth} y}{\operatorname{coth} x \pm \operatorname{coth} y} = \frac{\sinh 2x \mp \sinh 2y}{\cosh 2x - \cosh 2y} \end{aligned}$$

## Function Sum and Difference Identities

$$\sinh x \pm \sinh y = 2 \sinh \frac{1}{2}(x \pm y) \cosh \frac{1}{2}(x \mp y)$$

$$\cosh x + \cosh y = 2 \cosh \frac{1}{2}(x + y) \cosh \frac{1}{2}(x - y)$$

$$\cosh x - \cosh y = 2 \sinh \frac{1}{2}(x + y) \sinh \frac{1}{2}(x - y)$$

$$\tanh x \pm \tanh y = \frac{\sinh(x \pm y)}{\cosh x \cosh y}$$

$$\coth x \pm \coth y = \frac{\sinh(x \pm y)}{\sinh x \sinh y}$$

## Double Angle Identities

$$\sinh 2x = 2 \sinh x \cosh x, \quad \cosh 2x = \cosh^2 x + \sinh^2 x$$

## Half Angle Identities

$$\sinh^2 \frac{x}{2} = \frac{\cosh x - 1}{2}, \quad \cosh^2 \frac{x}{2} = \frac{\cosh x + 1}{2}$$

## Function Product Identities

$$\sinh x \sinh y = \frac{1}{2} \cosh(x + y) - \frac{1}{2} \cosh(x - y)$$

$$\cosh x \cosh y = \frac{1}{2} \cosh(x + y) + \frac{1}{2} \cosh(x - y)$$

$$\sinh x \cosh y = \frac{1}{2} \sinh(x + y) + \frac{1}{2} \sinh(x - y)$$

See Figure [M.1](#) for plots of the hyperbolic circular functions.

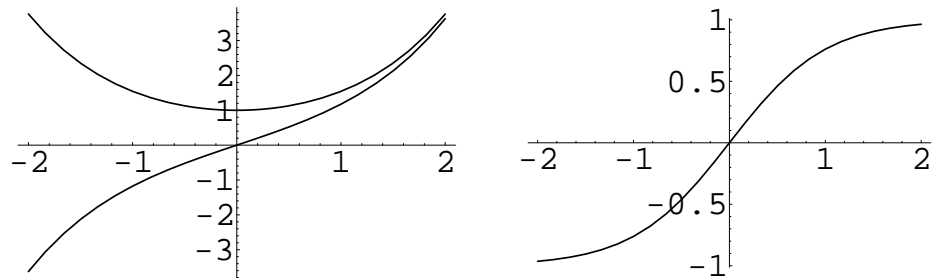

Figure M.1:  $\cosh x$ ,  $\sinh x$  and then  $\tanh x$

# Appendix N

## Bessel Functions

### N.1 Definite Integrals

Let  $\nu > -1$ .

$$\int_0^1 r J_\nu(j_{\nu,m}r) J_\nu(j_{\nu,n}r) dr = \frac{1}{2} (J'_\nu(j_{\nu,n}))^2 \delta_{mn}$$
$$\int_0^1 r J_\nu(j'_{\nu,m}r) J_\nu(j'_{\nu,n}r) dr = \frac{j_{\nu,n}^2 - \nu^2}{2j_{\nu,n}^2} (J_\nu(j'_{\nu,n}))^2 \delta_{mn}$$
$$\int_0^1 r J_\nu(\alpha_m r) J_\nu(\alpha_n r) dr = \frac{1}{2\alpha_n^2} \left( \frac{a^2}{b^2} + \alpha_n^2 - \nu^2 \right) (J_\nu(\alpha_n))^2 \delta_{mn}$$

Here  $\alpha_n$  is the  $n^{\text{th}}$  positive root of  $aJ_\nu(r) + brJ'_\nu(r)$ , where  $a, b \in \mathbb{R}$ .

# Appendix O

## Formulas from Linear Algebra

**Kramer's Rule.** Consider the matrix equation

$$A\vec{x} = \vec{b}.$$

This equation has a unique solution if and only if  $\det(A) \neq 0$ . If the determinant vanishes then there are either no solutions or an infinite number of solutions. If the determinant is nonzero, the solution for each  $x_j$  can be written

$$x_j = \frac{\det A_j}{\det A}$$

where  $A_j$  is the matrix formed by replacing the  $j^{\text{th}}$  column of  $A$  with  $b$ .

**Example O.0.1** *The matrix equation*

$$\begin{pmatrix} 1 & 2 \\ 3 & 4 \end{pmatrix} \begin{pmatrix} x_1 \\ x_2 \end{pmatrix} = \begin{pmatrix} 5 \\ 6 \end{pmatrix},$$

*has the solution*

$$x_1 = \frac{\begin{vmatrix} 5 & 2 \\ 6 & 4 \end{vmatrix}}{\begin{vmatrix} 1 & 2 \\ 3 & 4 \end{vmatrix}} = \frac{8}{-2} = -4, \quad x_2 = \frac{\begin{vmatrix} 1 & 5 \\ 3 & 6 \end{vmatrix}}{\begin{vmatrix} 1 & 2 \\ 3 & 4 \end{vmatrix}} = \frac{-9}{-2} = \frac{9}{2}.$$

# Appendix P

## Vector Analysis

### Rectangular Coordinates

$$f = f(x, y, z), \quad \vec{g} = g_x \mathbf{i} + g_y \mathbf{j} + g_z \mathbf{k}$$

$$\nabla f = \frac{\partial f}{\partial x} \mathbf{i} + \frac{\partial f}{\partial y} \mathbf{j} + \frac{\partial f}{\partial z} \mathbf{k}$$

$$\nabla \cdot \vec{g} = \frac{\partial g_x}{\partial x} + \frac{\partial g_y}{\partial y} + \frac{\partial g_z}{\partial z}$$

$$\nabla \times \vec{g} = \begin{vmatrix} \mathbf{i} & \mathbf{j} & \mathbf{k} \\ \frac{\partial}{\partial x} & \frac{\partial}{\partial y} & \frac{\partial}{\partial z} \\ g_x & g_y & g_z \end{vmatrix}$$

$$\Delta f = \nabla^2 f = \frac{\partial^2 f}{\partial x^2} + \frac{\partial^2 f}{\partial y^2} + \frac{\partial^2 f}{\partial z^2}$$

## Spherical Coordinates

$$x = r \cos \theta \sin \phi, \quad y = r \sin \theta \sin \phi, \quad z = r \cos \phi$$

$$f = f(r, \theta, \phi), \quad \vec{g} = g_r \mathbf{r} + g_\theta \boldsymbol{\theta} + g_\phi \boldsymbol{\phi}$$

## Divergence Theorem.

$$\iiint \nabla \cdot \mathbf{u} \, dx \, dy \, dz = \oint \mathbf{u} \cdot \mathbf{n} \, ds$$

## Stoke's Theorem.

$$\iint (\nabla \times \mathbf{u}) \cdot d\mathbf{s} = \oint \mathbf{u} \cdot d\mathbf{r}$$



# Appendix Q

## Partial Fractions

A proper rational function

$$\frac{p(x)}{q(x)} = \frac{p(x)}{(x-a)^n r(x)}$$

Can be written in the form

$$\frac{p(x)}{(x-\alpha)^n r(x)} = \left( \frac{a_0}{(x-\alpha)^n} + \frac{a_1}{(x-\alpha)^{n-1}} + \cdots + \frac{a_{n-1}}{x-\alpha} \right) + (\cdots)$$

where the  $a_k$ 's are constants and the last ellipses represents the partial fractions expansion of the roots of  $r(x)$ . The coefficients are

$$a_k = \frac{1}{k!} \frac{d^k}{dx^k} \left( \frac{p(x)}{r(x)} \right) \Big|_{x=\alpha}.$$

**Example Q.0.2** Consider the partial fraction expansion of

$$\frac{1+x+x^2}{(x-1)^3}.$$

The expansion has the form

$$\frac{a_0}{(x-1)^3} + \frac{a_1}{(x-1)^2} + \frac{a_2}{x-1}.$$

The coefficients are

$$a_0 = \frac{1}{0!}(1 + x + x^2)|_{x=1} = 3,$$

$$a_1 = \frac{1}{1!} \frac{d}{dx}(1 + x + x^2)|_{x=1} = (1 + 2x)|_{x=1} = 3,$$

$$a_2 = \frac{1}{2!} \frac{d^2}{dx^2}(1 + x + x^2)|_{x=1} = \frac{1}{2}(2)|_{x=1} = 1.$$

Thus we have

$$\frac{1 + x + x^2}{(x - 1)^3} = \frac{3}{(x - 1)^3} + \frac{3}{(x - 1)^2} + \frac{1}{x - 1}.$$

**Example Q.0.3** Consider the partial fraction expansion of

$$\frac{1 + x + x^2}{x^2(x - 1)^2}.$$

The expansion has the form

$$\frac{a_0}{x^2} + \frac{a_1}{x} + \frac{b_0}{(x - 1)^2} + \frac{b_1}{x - 1}.$$

The coefficients are

$$a_0 = \frac{1}{0!} \left( \frac{1 + x + x^2}{(x - 1)^2} \right) \Big|_{x=0} = 1,$$

$$a_1 = \frac{1}{1!} \frac{d}{dx} \left( \frac{1 + x + x^2}{(x - 1)^2} \right) \Big|_{x=0} = \left( \frac{1 + 2x}{(x - 1)^2} - \frac{2(1 + x + x^2)}{(x - 1)^3} \right) \Big|_{x=0} = 3,$$

$$b_0 = \frac{1}{0!} \left( \frac{1 + x + x^2}{x^2} \right) \Big|_{x=1} = 3,$$

$$b_1 = \frac{1}{1!} \frac{d}{dx} \left( \frac{1 + x + x^2}{x^2} \right) \Big|_{x=1} = \left( \frac{1 + 2x}{x^2} - \frac{2(1 + x + x^2)}{x^3} \right) \Big|_{x=1} = -3,$$

Thus we have

$$\frac{1+x+x^2}{x^2(x-1)^2} = \frac{1}{x^2} + \frac{3}{x} + \frac{3}{(x-1)^2} - \frac{3}{x-1}.$$

If the rational function has real coefficients and the denominator has complex roots, then you can reduce the work in finding the partial fraction expansion with the following trick: Let  $\alpha$  and  $\bar{\alpha}$  be complex conjugate pairs of roots of the denominator.

$$\begin{aligned} \frac{p(x)}{(x-\alpha)^n(x-\bar{\alpha})^n r(x)} &= \left( \frac{a_0}{(x-\alpha)^n} + \frac{a_1}{(x-\alpha)^{n-1}} + \cdots + \frac{a_{n-1}}{x-\alpha} \right) \\ &+ \left( \frac{\bar{a}_0}{(x-\bar{\alpha})^n} + \frac{\bar{a}_1}{(x-\bar{\alpha})^{n-1}} + \cdots + \frac{\bar{a}_{n-1}}{x-\bar{\alpha}} \right) + (\cdots) \end{aligned}$$

Thus we don't have to calculate the coefficients for the root at  $\bar{\alpha}$ . We just take the complex conjugate of the coefficients for  $\alpha$ .

**Example Q.0.4** Consider the partial fraction expansion of

$$\frac{1+x}{x^2+1}.$$

The expansion has the form

$$\frac{a_0}{x-i} + \frac{\bar{a}_0}{x+i}$$

The coefficients are

$$\begin{aligned} a_0 &= \frac{1}{0!} \left( \frac{1+x}{x+i} \right) \Big|_{x=i} = \frac{1}{2}(1-i), \\ \bar{a}_0 &= \overline{\frac{1}{2}(1-i)} = \frac{1}{2}(1+i) \end{aligned}$$

Thus we have

$$\frac{1+x}{x^2+1} = \frac{1-i}{2(x-i)} + \frac{1+i}{2(x+i)}.$$

# Appendix R

## Finite Math

Newton's Binomial Formula.

$$\begin{aligned}(a + b)^n &= \sum_{k=0}^n \binom{n}{k} a^{n-k} b^k \\ &= a^n + na^{n-1}b + \frac{n(n-1)}{2}a^{n-2}b^2 + \cdots + nab^{n-1} + b^n,\end{aligned}$$

The *binomial coefficients* are,

$$\binom{k}{n} = \frac{n!}{k!(n-k)!}.$$

# Appendix S

## Physics

In order to reduce processing costs, a chicken farmer wished to acquire a plucking machine. Since there was no such machine on the market, he hired a mechanical engineer to design one. After extensive research and testing, the professor concluded that it was impossible to build such a machine with current technology. The farmer was disappointed, but not wanting to abandon his dream of an automatic plucker, he consulted a physicist. After a single afternoon of work, the physicist reported that not only could a plucking machine be built, but that the design was simple. The elated farmer asked him to describe his method. The physicist replied, "First, assume a spherical chicken . . .".

The problems in this text will implicitly make certain simplifying assumptions about chickens. For example, a problem might assume a perfectly elastic, frictionless, spherical chicken. In two-dimensional problems, we will assume that chickens are circular.

# Appendix T

## Probability

### T.1 Independent Events

Once upon a time I was talking with the father of one of my colleagues at Caltech. He was an educated man. I think that he had studied Russian literature and language back when he was in college. We were discussing gambling. He told me that he had a scheme for winning money at the game of 21. I was familiar with counting cards. Being a mathematician, I was not interested in hearing about conditional probability from a literature major, but I said nothing and prepared to hear about his particular technique. I was quite surprised with his “method”: He said that when he was on a winning streak he would bet more and when he was on a losing streak he would bet less. He conceded that he lost more hands than he won, but since he bet more when he was winning, he made money in the end.

I respectfully and thoroughly explained to him the concept of an independent event. Also, if one is not counting cards then each hand in 21 is essentially an independent event. The outcome of the previous hand has no bearing on the current. Throughout the explanation he nodded his head and agreed with my reasoning. When I was finished he replied, “Yes, that’s true. But you see, I have a method. When I’m on my winning streak I bet more and when I’m on my losing streak I bet less.”

I pretended that I understood. I didn’t want to be rude. After all, he had taken the time to explain the concept of a winning streak to me. And everyone knows that mathematicians often do not easily understand practical matters,

particularly games of chance.

*Never explain mathematics to the layperson.*

## T.2 Playing the Odds

Years ago in a classroom not so far away, your author was being subjected to a presentation of a lengthy proof. About five minutes into the lecture, the entire class was hopelessly lost. At the forty-five minute mark the professor had a combinatorial expression that covered most of a chalk board. From his previous queries the professor knew that none of the students had a clue what was going on. This pleased him and he had become more animated as the lecture had progressed. He gestured to the board with a smirk and asked for the value of the expression. Without a moment's hesitation, I nonchalantly replied, "zero". The professor was taken aback. He was clearly impressed that I was able to evaluate the expression, especially because I had done it in my head and so quickly. He enquired as to my method. "Probability", I replied. "Professors often present difficult problems that have simple, elegant solutions. Zero is the most elegant of numerical answers and thus most likely to be the correct answer. My second guess would have been one." The professor was not amused.

Whenever a professor asks the class a question which has a numeric answer, immediately respond, "zero". If you are asked about your method, casually say something vague about symmetry. Speak with confidence and give non-verbal cues that you consider the problem to be elementary. This tactic will usually suffice. It's quite likely that some kind of symmetry is involved. And if it isn't your response will puzzle the professor. They may continue with the next topic, not wanting to admit that they don't see the "symmetry" in such an elementary problem. If they press further, start mumbling to yourself. Pretend that you are lost in thought, perhaps considering some generalization of the result. They may be a little irked that you are ignoring them, but it's better than divulging your true method.

# Appendix U

## Economics

There are two important concepts in economics. The first is “Buy low, sell high”, which is self-explanatory. The second is *opportunity cost*, the highest valued alternative that must be sacrificed to attain something or otherwise satisfy a want. I discovered this concept as an undergraduate at Caltech. I was never very interested in computer games, but one day I found myself randomly playing tetris. Out of the blue I was struck by a revelation: “I could be having sex right now.” I haven’t played a computer game since.



# Appendix V

## Glossary

Phrases often have different meanings in mathematics than in everyday usage. Here I have collected definitions of some mathematical terms which might confuse the novice.

**beyond the scope of this text:** Beyond the comprehension of the author.

**difficult:** Essentially impossible. Note that mathematicians never refer to problems they have solved as being difficult. This would either be boastful, (claiming that you can solve difficult problems), or self-deprecating, (admitting that you found the problem to be difficult).

**interesting:** This word is grossly overused in math and science. It is often used to describe any work that the author has done, regardless of the work's significance or novelty. It may also be used as a synonym for difficult. It has a completely different meaning when used by the non-mathematician. When I tell people that I am a mathematician they typically respond with, "That must be interesting.", which means, "I don't know anything about math or what mathematicians do." I typically answer, "No. Not really."

**non-obvious** or **non-trivial:** Real fuckin' hard.

**one can prove that . . . :** The "one" that proved it was a genius like Gauss. The phrase literally means "you haven't got a chance in hell of proving that . . ."

**simple:** Mathematicians communicate their prowess to colleagues and students by referring to all problems as simple or trivial. If you ever become a math professor, introduce every example as being “really quite trivial.” <sup>1</sup>

Here are some less interesting words and phrases that you are probably already familiar with.

**corollary:** a proposition inferred immediately from a proved proposition with little or no additional proof

**lemma:** an auxiliary proposition used in the demonstration of another proposition

**theorem:** a formula, proposition, or statement in mathematics or logic deduced or to be deduced from other formulas or propositions

---

<sup>1</sup>For even more fun say it in your best Elmer Fudd accent. “This next pwobwem is weawy quite twiviaw”.

# Appendix W

whoami



Figure W.1: Graduation, June 13, 2003.

# Index

- a + i b form, 184
- Abel's formula, 910
- absolute convergence, 526
- adjoint
  - of a differential operator, 915
  - of operators, 1314
- analytic, 361
- Analytic continuation
  - Fourier integrals, 1550
- analytic continuation, 437
- analytic functions, 2225
- anti-derivative, 473
- Argand diagram, 184
- argument
  - of a complex number, 186
- argument theorem, 501
- asymptotic expansions, 1251
  - integration by parts, 1263
- asymptotic relations, 1251
- autonomous D.E., 992
- average value theorem, 499
- Bernoulli equations, 984
- Bessel functions, 1622
  - generating function, 1629
  - of the first kind, 1628
  - second kind, 1644
- Bessel's equation, 1622
- Bessel's Inequality, 1296
- Bessel's inequality, 1340
- bilinear concomitant, 917
- binomial coefficients, 2276
- binomial formula, 2276
- boundary value problems, 1109
- branch
  - principal, 6
- branch point, 270
- branches, 6
- calculus of variations, 2060
- canonical forms
  - constant coefficient equation, 1018
  - of differential equations, 1018
- cardinality
  - of a set, 3
- Cartesian form, 184

- Cartesian product
  - of sets, 3
- Cauchy convergence, 526
- Cauchy principal value, 634, 1548
- Cauchy's inequality, 497
- Cauchy-Riemann equations, 367, 2225
- chicken
  - spherical, 2277
- clockwise, 241
- closed interval, 3
- closure relation
  - and Fourier transform, 1552
  - discrete sets of functions, 1297
- codomain, 4
- comparison test, 529
- completeness
  - of sets of functions, 1297
  - sets of vectors, 34
- complex conjugate, 182, 184
- complex derivative, 360, 361
- complex infinity, 242
- complex number, 182
  - magnitude, 185
  - modulus, 185
- complex numbers, 180
  - arithmetic, 193
  - set of, 3
  - vectors, 193
- complex plane, 184
  - first order differential equations, 803
  - computer games, 2280
  - connected region, 240
  - constant coefficient differential equations, 930
  - continuity, 53
    - uniform, 55
  - continuous
    - piecewise, 55
  - continuous functions, 53, 536, 539
  - contour, 240
    - traversal of, 241
  - contour integral, 465
  - convergence
    - absolute, 526
    - Cauchy, 526
    - comparison test, 529
    - Gauss' test, 536
    - in the mean, 1296
    - integral test, 530
    - of integrals, 1470
    - Raabe's test, 535
    - ratio test, 531
    - root test, 533
    - sequences, 525
    - series, 526
    - uniform, 536
  - convolution theorem
    - and Fourier transform, 1554
    - for Laplace transforms, 1490
  - convolutions, 1490
  - counter-clockwise, 241

- curve, 240
  - closed, 240
  - continuous, 240
  - Jordan, 240
  - piecewise smooth, 240
  - simple, 240
  - smooth, 240
- definite integral, 122
- degree
  - of a differential equation, 774
- del, 157
- delta function
  - Kronecker, 34
- derivative
  - complex, 361
- determinant
  - derivative of, 905
- difference
  - of sets, 4
- difference equations
  - constant coefficient equations, 1174
  - exact equations, 1168
  - first order homogeneous, 1169
  - first order inhomogeneous, 1171
- differential calculus, 48
- differential equations
  - autonomous, 992
  - constant coefficient, 930
  - degree, 774
  - equidimensional-in-x, 995
  - equidimensional-in-y, 997
  - Euler, 940
  - exact, 782, 945
  - first order, 773, 791
  - homogeneous, 774
  - homogeneous coefficient, 786
  - inhomogeneous, 774
  - linear, 774
  - order, 773
  - ordinary, 773
  - scale-invariant, 1000
  - separable, 780
  - without explicit dep. on y, 946
- differential operator
  - linear, 902
- Dirac delta function, 1041, 1298
- direction
  - negative, 241
  - positive, 241
- directional derivative, 157
- discontinuous functions, 54, 1337
- discrete derivative, 1167
- discrete integral, 1167
- disjoint sets, 4
- domain, 4
- economics, 2280
- eigenfunctions, 1330
- eigenvalue problems, 1330

- eigenvalues, 1330
- elements
  - of a set, 2
- empty set, 2
- entire, 361
- equidimensional differential equations, 940
- equidimensional-in- $x$  D.E., 995
- equidimensional-in- $y$  D.E., 997
- Euler differential equations, 940
- Euler's formula, 189
- Euler's notation
  - $i$ , 182
- Euler's theorem, 786
- Euler-Mascheroni constant, 1611
- exact differential equations, 945
- exact equations, 782
- exchanging dep. and indep. var., 990
- extended complex plane, 242
- extremum modulus theorem, 500
- Fibonacci sequence, 1179
- fluid flow
  - ideal, 383
- formally self-adjoint operators, 1315
- Fourier coefficients, 1291, 1335
  - behavior of, 1349
- Fourier convolution theorem, 1554
- Fourier cosine series, 1344
- Fourier cosine transform, 1562
  - of derivatives, 1564
  - table of, 2254
- Fourier series, 1330
  - and Fourier transform, 1539
  - uniform convergence, 1353
- Fourier Sine series, 1345
- Fourier sine series, 1429
- Fourier sine transform, 1563
  - of derivatives, 1564
  - table of, 2255
- Fourier transform
  - alternate definitions, 1544
  - closure relation, 1552
  - convolution theorem, 1554
  - of a derivative, 1553
  - Parseval's theorem, 1557
  - shift property, 1559
  - table of, 2250, 2253
- Fredholm alternative theorem, 1109
- Fredholm equations, 1027
- Frobenius series
  - first order differential equation, 808
- function
  - bijjective, 5
  - injective, 5
  - inverse of, 6
  - multi-valued, 6
  - single-valued, 4
  - surjective, 5
- function elements, 437
- functional equation, 389



- fundamental set of solutions
  - of a differential equation, 913
- fundamental theorem of algebra, 498
- fundamental theorem of calculus, 125
- gambler's ruin problem, 1166, 1175
- Gamma function, 1605
  - difference equation, 1605
  - Euler's formula, 1605
  - Gauss' formula, 1609
  - Hankel's formula, 1607
  - Weierstrass' formula, 1611
- Gauss' test, 536
- generating function
  - for Bessel functions, 1628
- geometric series, 527
- Gibb's phenomenon, 1358
- gradient, 157
- Gramm-Schmidt orthogonalization, 1284
- greatest integer function, 5
- Green's formula, 917, 1315
- harmonic conjugate, 372
- harmonic series, 528, 564
- Heaviside function, 797, 1041
- holomorphic, 361
- homogeneous coefficient equations, 786
- homogeneous differential equations, 774
- homogeneous functions, 786
- homogeneous solution, 793
- homogeneous solutions
  - of differential equations, 902
- i
  - Euler's notation, 182
- ideal fluid flow, 383
- identity map, 5
- ill-posed problems, 801
  - linear differential equations, 911
- image
  - of a mapping, 5
- imaginary number, 182
- imaginary part, 182
- improper integrals, 130
- indefinite integral, 116, 473
- indicial equation, 1201
- infinity
  - complex, 242
  - first order differential equation, 814
  - point at, 242
- inhomogeneous differential equations, 774
- initial conditions, 796
- inner product
  - of functions, 1288
- integers
  - set of, 2
- integral bound
  - maximum modulus, 467
- integral calculus, 116
- integral equations, 1027

- boundary value problems, 1027
- initial value problems, 1027
- integrals
  - improper, 130
- integrating factor, 792
- integration
  - techniques of, 127
- intermediate value theorem, 55
- intersection
  - of sets, 4
- interval
  - closed, 3
  - open, 3
- inverse function, 6
- inverse image, 5
- irregular singular points, 1216
  - first order differential equations, 812
- j electrical engineering, 182
- Jordan curve, 240
- Jordan's lemma, 2226
- Kramer's rule, 2270
- Kronecker delta function, 34
- L'Hospital's rule, 75
- Lagrange's identity, 917, 949, 1314
- Laplace transform
  - inverse, 1477
- Laplace transform pairs, 1479
- Laplace transforms, 1475
- convolution theorem, 1490
  - of derivatives, 1490
- Laurent expansions, 627, 2225
- Laurent series, 555, 2227
  - first order differential equation, 808
- leading order behavior
  - for differential equations, 1255
- least integer function, 5
- least squares fit
  - Fourier series, 1337
- Legendre polynomials, 1285
- limit
  - left and right, 50
- limits of functions, 48
- line integral, 463
  - complex, 465
- linear differential equations, 774
- linear differential operator, 902
- linear space, 1278
- Liouville's theorem, 497
- magnitude, 185
- maximum modulus integral bound, 467
- maximum modulus theorem, 500
- Mellin inversion formula, 1478
- minimum modulus theorem, 500
- modulus, 185
- multi-valued function, 6
- nabla, 157

- natural boundary, 437
- Newton's binomial formula, 2276
- norm
  - of functions, 1288
- normal form
  - of differential equations, 1021
- null vector, 24
- one-to-one mapping, 5
- open interval, 3
- opportunity cost, 2280
- optimal asymptotic approximations, 1268
- order
  - of a differential equation, 773
  - of a set, 3
- ordinary points
  - first order differential equations, 803
  - of linear differential equations, 1184
- orthogonal series, 1291
- orthogonality
  - weighting functions, 1290
- orthonormal, 1288
- Parseval's equality, 1340
- Parseval's theorem
  - for Fourier transform, 1557
- partial derivative, 155
- particular solution, 793
  - of an ODE, 1059
- particular solutions
  - of differential equations, 903
- periodic extension, 1336
- piecewise continuous, 55
- point at infinity, 242
  - differential equations, 1216
- polar form, 188
- potential flow, 383
- power series
  - definition of, 539
  - differentiation of, 547
  - integration of, 547
  - radius of convergence, 541
  - uniformly convergent, 539
- principal argument, 186
- principal branch, 6
- principal root, 199
- principal value, 634, 1548
- pure imaginary number, 182
- Raabe's test, 535
- range
  - of a mapping, 5
- ratio test, 531
- rational numbers
  - set of, 3
- Rayleigh's quotient, 1426
  - minimum property, 1426
- real numbers
  - set of, 3
- real part, 182

- rectangular unit vectors, 24
- reduction of order, 947
  - and the adjoint equation, 948
  - difference equations, 1177
- region
  - connected, 240
  - multiply-connected, 240
  - simply-connected, 240
- regular, 361
- regular singular points
  - first order differential equations, 806
- regular Sturm-Liouville problems, 1420
  - properties of, 1428
- residuals
  - of series, 527
- residue theorem, 631, 2226
  - principal values, 643
- residues, 627, 2225
  - of a pole of order  $n$ , 627, 2226
- Riccati equations, 986
- Riemann zeta function, 528
- Riemann-Lebesgue lemma, 1471
- root test, 533
- Rouche's theorem, 502
- scalar field, 155
- scale-invariant D.E., 1000
- separable equations, 780
- sequences
  - convergence of, 525
- series, 525
  - comparison test, 529
  - convergence of, 525, 526
  - Gauss' test, 536
  - geometric, 527
  - integral test, 530
  - Raabe's test, 535
  - ratio test, 531
  - residuals, 527
  - root test, 533
  - tail of, 526
- set, 2
- similarity transformation, 1888
- single-valued function, 4
- singularity, 377
  - branch point, 377
- spherical chicken, 2277
- stereographic projection, 243
- Stirling's approximation, 1613
- subset, 3
  - proper, 3
- Taylor series, 550, 2226
  - first order differential equations, 805
  - table of, 2241
- transformations
  - of differential equations, 1018
  - of independent variable, 1024
  - to constant coefficient equation, 1025
  - to integral equations, 1027

trigonometric identities, 2264

uniform continuity, 55

uniform convergence, 536

of Fourier series, 1353

of integrals, 1470

union

of sets, 4

variation of parameters

first order equation, 795

vector

components of, 25

rectangular unit, 24

vector calculus, 154

vector field, 155

vector-valued functions, 154

Volterra equations, 1027

wave equation

D'Alembert's solution, 1933

Fourier transform solution, 1933

Laplace transform solution, 1934

Weber's function, 1644

Weierstrass M-test, 537

well-posed problems, 801

linear differential equations, 911

Wronskian, 906, 907

zero vector, 24