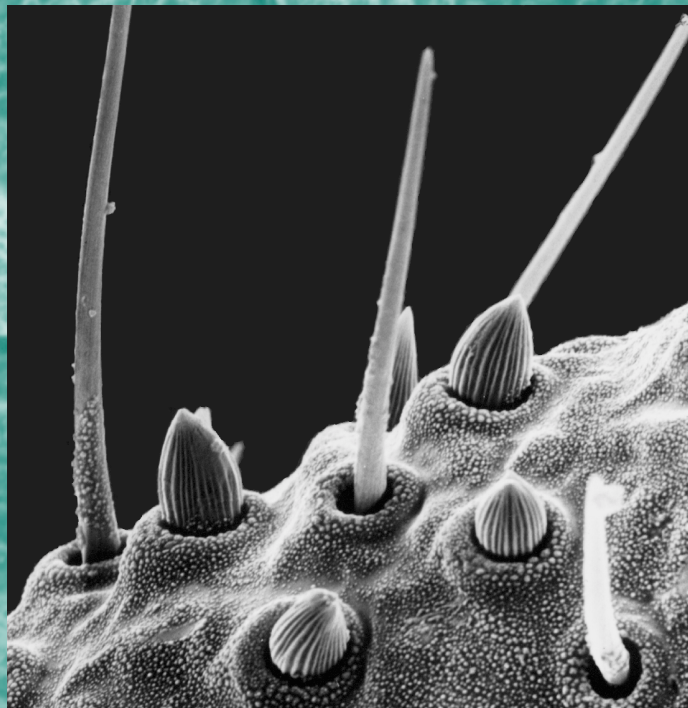


A SAFRINET MANUAL FOR ENTOMOLOGY AND
ARACHNOLOGY

Collecting and Preserving Insects and Arachnids



**Compiled by the
Biosystematics Division, ARC-PPRI, South Africa**

Sponsored by SDC, Switzerland

Collecting and Preserving Insects and Arachnids

A Manual for Entomology and Arachnology

by

SAFRINET, the Southern African (SADC) LOOP of
BioNET-INTERNATIONAL



Compiled by the
National Collections of Insects and Arachnids
Biosystematics Division
ARC – Plant Protection Research Institute
Pretoria, South Africa

Edited by I.M. Millar, V.M. Uys & R.P. Urban



Sponsored by
The Swiss Agency for Development and Cooperation
(SDC)



© 2000

ARC –Plant Protection Research Institute
Private Bag X134, Pretoria, 0001 South Africa

ISBN 1-868-49144-7

No part of this publication may be reproduced in any form or by any means, including photocopying and recording, without prior permission from the publisher.

Layout, design, technical editing & production
Isteg Scientific Publications, Irene

Imageset by Future Graphics, Centurion

Printed by Ultra Litho (Pty) Ltd, Heriotdale, Johannesburg

Preface

This manual is a guide to a course in practical entomology and arachnology for technical assistants of the SADC countries of the SAFRINET-loop of BioNET-INTERNATIONAL.

The course, presented by the staff of the National Collections of Insects and Arachnids of the Plant Protection Research Institute, comprises lectures, discussions and practical sessions aimed at teaching students to recognise the major groups of insects and arachnids. Techniques to collect, process and prepare insects and arachnids for study are presented, as well as important information on how to preserve and curate material in a reference collection. The manual also contains information on basic insect and arachnid morphology, classification and taxonomy. A list of pertinent literature is provided.

Acknowledgements

- Sincere thanks are due to Ms C. Craemer for coordinating the preparation and production of this manual and to Dr G.L. Prinsloo for guidance and advice. The generous funding by the sponsor, The Swiss Agency for Development and Cooperation (SDC), is greatly appreciated.

Contributing authors

C. Craemer

Dr A.S. Dippenaar-Schoeman

Dr C.D. Eardley

E. Grobbelaar

Dr M.W. Mansell

I.M. Millar

O.C. Nesor

Dr R.G. Oberprieler

M. Stiller

Dr E.A. Ueckermann

- Illustrated by Elsa van Niekerk.
- Cover design by Elsa van Niekerk and Nico Dippenaar.

This manual is based on the book **How to Collect and Preserve Insects and Arachnids** (PPRI Handbook No. 7, 1996), edited by Vivienne Uys and Rosalind Urban and illustrated by Elsa van Niekerk.

C ONTENTS

Preface — iii

Acknowledgements — iv

1. Importance of taxonomy and reference collections in applied research	1
2. Introduction to zoological nomenclature	3
3. The higher classification of insects and arachnids	5
3.1 Insects	5
3.2 Arachnids	25
4. Collecting methods	34
4.1 Collecting bag	34
4.2 Aspirators	35
4.3 Hand collecting	36
4.4 Collecting nets	37
4.5 Beating sheets	40
4.6 Knock-down sprays	40
4.7 Extractors	41
4.8 Baits and refuges	43
4.9 Traps	44
4.10 Rearing	51
4.11 Preferred methods of collecting insects and arachnids	53
5. Killing and temporary storage	56
5.1 Killing methods	56
5.2 Temporary storage	60
5.3 Recording field data	61
6. Preservation	63
6.1 Dry preservation	63
6.2 Wet preservation	74
6.3 Slide mounting	75
6.4 Preferred methods of preserving of insects and arachnids	77
7. Labelling, accessioning and dispatching	80
8. Permanent storage and curation	90
8.1 Types of collections	90
8.2 Curating a collection	94
9. Collector's code of practice	98
Glossary	100
Index	102

1. Importance of taxonomy and reference collections in applied research

The diversity of living organisms is so vast that a specialised branch of biology is required to study it. This is the science of taxonomy, which may be defined as the theory and practice of classifying organisms. Biologists classify plants and animals into groups of related species. They give formal names to these groups, and to each individual species. This procedure is explained in Chapter 2 below. An example of a group of related animals are insects, which have certain characteristics in common, such as six legs. Spiders are another group.

Taxonomy is fundamental to biology as it involves the accurate naming and identification of species. Once we know which particular species we are dealing with, we can retrieve information about it. For example, if we have identified a particular fruit fly from a crop, we can find out what is known about its life cycle, host plants, distribution and many other aspects of its biology.

Reference collections are important resources in applied research. Such collections may be generalised or specialised, and can grow very large to contain many thousands of specimens. Museums generally house specimens that represent many or all species that occur in particular geographic regions, as one of their goals is to gather material for biodiversity studies. Organisations involved in fields such as crop pest work, or biological control research, have more specialised collections that are relevant to their purposes. Examples of reference collections are:

- ☞ Insects or mites found on a certain plant species
- ☞ Mosquitoes that bite humans in a particular country
- ☞ Parasitic wasps that attack scale insects on crops
- ☞ Arthropods found in cargoes of grain in ships at ports

2 Importance of taxonomy and reference collections

Collections of specimens that are identified, properly labelled and arranged in good storage systems have the following important functions:

- ☞ They can be used to confirm identifications of further material
- ☞ Voucher specimens, or material on which published studies are based, can be deposited in collections for future reference
- ☞ Names of new species are based on reference specimens known as types, and these are stored in suitable, established collections, mainly in museums
- ☞ Biological specimens and their associated data serve as archives of information on many topics, such as distribution, host plants and seasonal occurrence of species.

2. Introduction to zoological nomenclature

People give names to animals and plants for the purpose of communication. However, any particular species of living organism often has many names, in various different languages. In the scientific world, each species is given a unique name that is accepted internationally as a standard means of referring to that particular plant or animal. This scientific name is expressed in Latin or a latinised form, in italics (or underlined). It consists of two parts, a genus name and a species name, forming a 'binomial'. By convention, the genus name always begins with a capital letter, whereas the species name is always written entirely in lower case letters. Thus the scientific name for the species 'house fly' is written as *Musca domestica*. When this name is used, it is clear to everybody which species is being referred to, even though 'house fly' has many different common names.

The rules and procedures for applying scientific names, as agreed upon by scientists in all countries, are known as international codes of nomenclature. There are separate (but fairly similar) sets of rules for naming plants, bacteria and animals. The procedures governing the usage of animal names are embodied in the International Code of Zoological Nomenclature, which is available in the form of a published book.

The scientific names of animals become accepted once they have been published. Biologists who study the diversity of animals and discover new species give them scientific names, which are published with descriptions of these new species in scientific journals and books. The author of the name is cited after the species name as follows: *Musca domestica* Linnaeus. Sometimes the author's name appears in brackets after the scientific name, e.g. *Locusta pardalina* (Walker), the brown locust. This means that a person called Walker named the species *pardalina* in a genus other than *Locusta*, and that this species name was subsequently moved from its original genus, as it was found to be better classified in *Locusta*.

Sometimes, a single species may inadvertently end up with two or more names. This can happen when it is discovered that two or more supposedly distinct species, which have already been named, are in fact the same species. The name which was first published becomes the valid or accepted name, while any other names, published later, become known as synonyms of the valid name. Synonyms are thus names that are associated with an animal, but which

Introduction to zoological nomenclature

may not be used as the standard or accepted way of referring to it.

It has been mentioned that taxonomy involves classifying organisms into related groups. A group of related species form a genus. In turn, genera are grouped into families, families into orders, and so on. The following are the levels in biological classification, with the house fly classified in the system as an example:

Level	Name
Kingdom	Animalia
Phylum	Arthropoda
Class	Insecta
Order	Diptera
Family	Muscidae
Genus	<i>Musca</i>
Species	<i>domestica</i>

There are conventions for name usage at some levels, e.g. family names have to end with *-idae*. Also, the groups are subdivided, e.g. families contain subfamilies, which in turn are divided at the next level into tribes, and again into subtribes.

It is necessary to understand the application of zoological nomenclature in order to:

- ☞ label named specimens correctly
- ☞ arrange them properly into groups
- ☞ update the names in collections where necessary

Further reading

INTERNATIONAL COMMISSION ON ZOOLOGICAL NOMENCLATURE. 1985. *International Code of Zoological Nomenclature*, third edition. International Trust for Zoological Nomenclature, London. 338 pp.

JEFFREY, C. 1977. *Biological Nomenclature*, second edition. Edward Arnold, London. 72 pp.

3. **T**he higher classification of insects and arachnids

Insects and arachnids belong to the phylum Arthropoda, which are animals with jointed appendages, a segmented body and a chitinous exoskeleton. The phylum is divided into about ten classes, of which the classes Insecta and Arachnida contain the largest number of species in the animal kingdom.

3.1

Insects

Insects are characterised by three pairs of legs, two pairs of wings and the body divided into head, thorax and abdomen. There are exceptions, especially in immature stages, but all insects manifest one or more of these features during their life cycles. The term *insect* is derived from Latin *insectum* – to cut into, referring to the segmented body of insects.

Insects are of great importance as many species destroy crops and stored products, or are detrimental to the health of humans and livestock. Others are beneficial as parasites, predators and pollinators.

The class Insecta comprises about 27 orders, of which 25 occur in southern Africa and are classified as follows.

Insects may be divided into two main groups:

Subclass Apterygota – primitively wingless insects, and **subclass Pterygota** – insects with wings, or that are secondarily wingless.

The subclass Pterygota comprises two subdivisions:

Hemimetabola (or Exopterygota) – insects with a life cycle that does not include a pupal stage, i.e. with an incomplete metamorphosis. Immature stages (nymphs) often resemble the adults.

Holometabola (or Endopterygota) – insects with a life cycle that involves a complete metamorphosis, i.e. including a pupal stage. Immatures (larvae) differ entirely from adults in appearance and habits.

☛ ORDERS OF INSECTS

Subclass Apterygota

☛ Order Archaeognatha (bristletails) • Fig. 1

Elongate, greyish-brown, wingless, with three long tail-like appendages at the end of the abdomen, body laterally compressed and compound eyes large and touching. Bristletails are active jumpers and occur in leaf litter and under bark and stones.

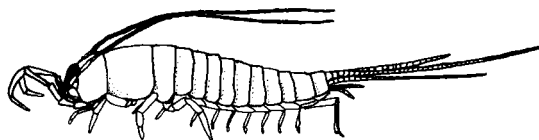


Fig. 1. Archaeognatha

☛ Order Thysanura (fishmoths, silverfish) • Fig. 2

Elongate, silvery, wingless, with three long tail-like appendages at the end of the abdomen, body dorsoventrally flattened and compound eyes small and widely separated. Fishmoths are often encountered in houses where they feed on starch-containing compounds such as paper and linen, and may cause severe damage to books and documents.

Subclass Pterygota HEMIMETABOLA

☛ Order Ephemeroptera (mayflies) • Fig. 3

Mayfly nymphs live in water (aquatic), have abdominal gills, and two or three long filaments (cerci) at the tip of the abdomen. Adults are delicate, short-lived insects, characterised by two or three long cerci on the abdomen. Nymphs may be found clinging to rocks in pristine streams and are good indicators of water quality. Adults do not feed and often form large mating swarms.

☛ Order Odonata (dragonflies, damselflies) • Fig. 4

Nymphs are aquatic and predacious, with a unique extendible labium modified for capturing prey. Adults have two pairs of similar clear wings with many veins. The wings are held outstretched (dragonflies) or over the body (damselflies) when at rest. Odonata have large eyes and tiny bristle-like antennae. They are good fliers, and are usually brightly coloured.

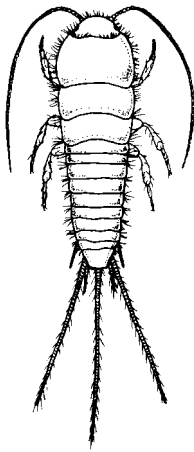


Fig. 2. Thysanura

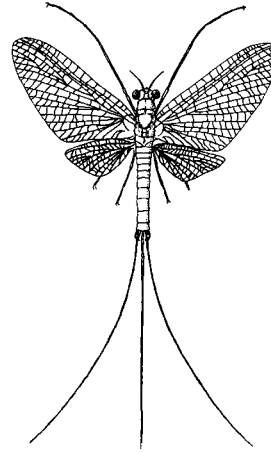


Fig. 3. Ephemeroptera

☛ Order Blattodea (cockroaches) • Fig. 5

Cockroaches may be winged or wingless, and are dorsoventrally flattened. Antennae are long and thread-like and the head is usually concealed by a large shield-like pronotum. Legs are adapted for running. They run actively and feed on organic matter. Cockroaches are often pests in houses where they can contaminate food and often emit an unpleasant odour.

☛ Order Mantodea (praying mantids) • Fig. 6

Mantids are usually green or brown, with an elongated prothorax, and are easily recognised by their raptorial forelegs. Eggs are laid in a hard sponge-like ootheca. Both adults and nymphs are voracious predators.

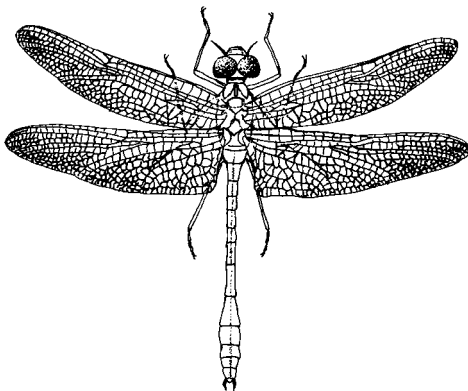


Fig. 4. Odonata

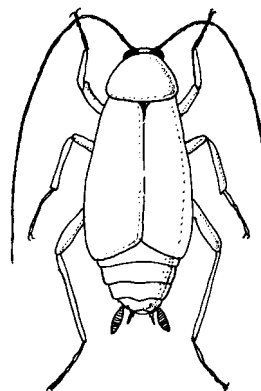


Fig. 5. Blattodea

☛ Order Phasmatodea (stick insects) • Fig. 7

Phasmids are very long, slender insects that resemble sticks. They are highly cryptic and are seldom seen. Some species have well-developed wings. They are all vegetarians and some lay beautifully sculptured eggs.

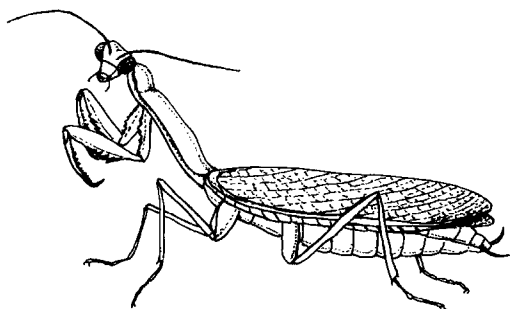


Fig. 6. Mantodea

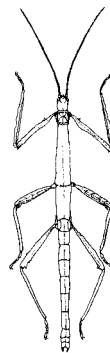


Fig. 7. Phasmatodea

☛ Order Dermaptera (earwigs) • Fig. 8

Earwigs may be winged or wingless. Their main characteristic is a pair of forceps-like cerci at the end of the abdomen. They are elongate, flattened and usually dark-brown to black. Dermaptera usually live under logs or stones and feed on organic matter.

☛ Order Embioptera (webspinners) • Fig. 9

Webspinners are small, elongate, brown insects that live in silk-lined tunnels. Silk is produced by the foretarsi which are characteristically swollen. They feed on dead plant material.

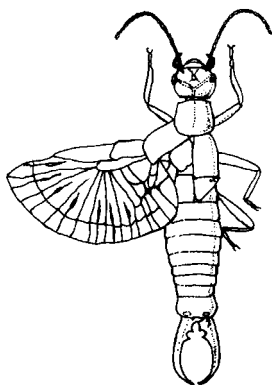


Fig. 8. Dermaptera

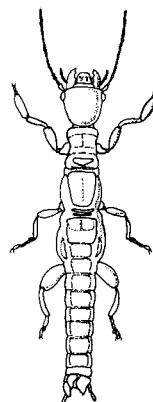


Fig. 9. Embioptera

☛ Order Plecoptera (stoneflies) • Fig. 10

Nymphs live on rocks in fresh water. Adults are elongate, dorsoventrally flattened and brownish, with two pairs of similar, membranous wings. Adults and nymphs have a pair of cerci on the tip of the abdomen. They feed mostly on plant material and detritus, but the larvae of a few species are predators.

☛ Order Zoraptera (zorapterans) • Fig. 11

Very small insects, often wingless and seldom collected. Zorapterans resemble elongate termites. They occur worldwide but are not known from southern Africa.

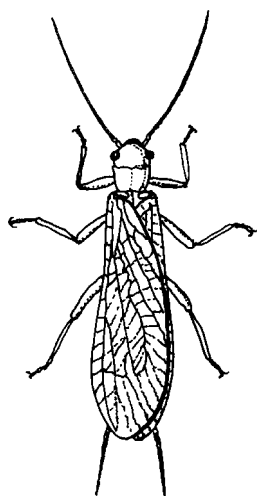


Fig. 10. Plecoptera

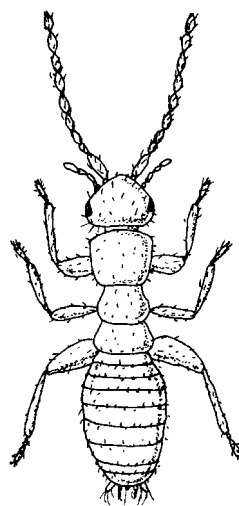


Fig. 11. Zoraptera

☛ Order Psocoptera (booklice, psocids) • Fig. 12

Small soft-bodied insects, with or without wings. When present, wings are held roof-like over the abdomen when at rest. Booklice have large mobile heads with bulging 'faces' and hair-like antennae. They feed on dry organic matter and often damage books and insect collections.

☛ Order Phthiraptera (lice) • Fig. 13

Lice are small, dorsoventrally flattened, wingless insects that are ectoparasitic on birds and mammals, including humans. The mouthparts are either adapted for chewing or for sucking. *Phthirus pubis* (crab louse) and *Pediculus humanus* (body and head lice) are two sucking forms that infest humans.

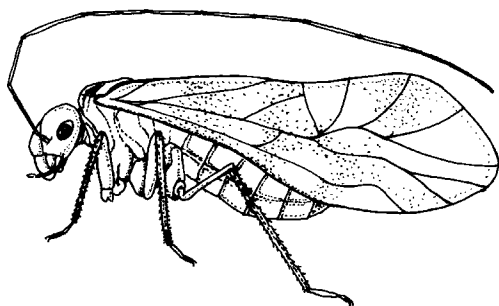


Fig. 12. Psocoptera

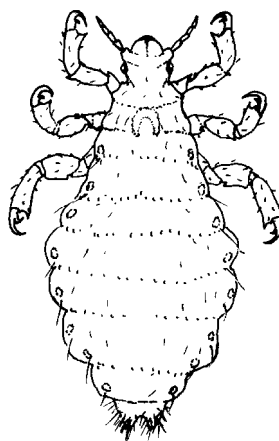


Fig. 13. Phthiraptera

☛ Order Orthoptera (crickets, grasshoppers, locusts) • Fig. 14

Orthopterans generally have two pairs of wings, with the front pair thickened and known as tegmina. The hind legs are modified for jumping, and the mouthparts are adapted for biting and chewing. The capacity for producing sound is well developed in this order. There are two suborders: Caelifera – the short-horned grasshoppers; and Ensifera – long-horned grasshoppers and crickets. Locusts are the most notorious members of this order. They form huge swarms that are capable of destroying crops and pastures over wide areas.

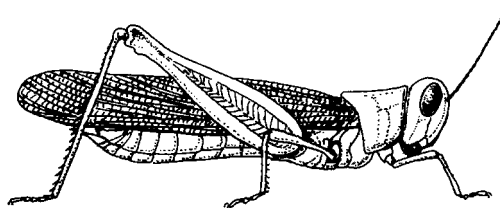


Fig. 14. Orthoptera

☛ Order Isoptera (termites, white ants) • Fig. 15

Termites are small, soft-bodied, social insects. The antennae are short and bead-like. Wings of alates are elongate, similar and without cross-veins. Workers are wingless. They live in mounds (termitaria), underground or in wood. Each nest is a highly organised society with separate castes (queen, king, workers, soldiers and alates) that perform specific functions such as reproduction, defence and foraging. Termites are very destructive to timber. Some feed on grass and cause considerable damage to grazing areas.

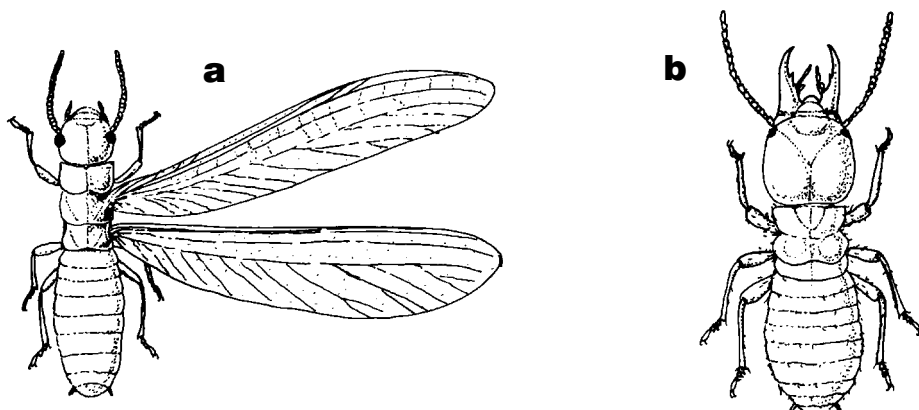


Fig. 15. Isoptera (a) alate; (b) soldier

☛ **Order Hemiptera (bugs, aphids, scale insects) • Fig. 16**

All bugs have mouthparts modified into a beak or rostrum. Two pairs of wings are usually present in adults, while some are wingless and sessile (e.g. scale insects). Many bugs damage crops with their piercing and sucking mouthparts, and some are also vectors of plant virus diseases. A few are beneficial as predators of pests, or control agents of alien invasive weeds.

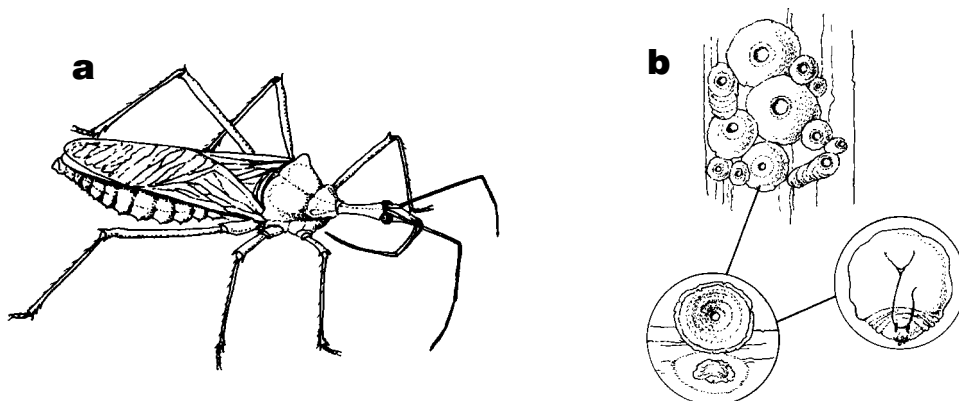


Fig. 16. Hemiptera (a) assassin bug; (b) scale insects

☛ **Order Thysanoptera (thrips) • Fig. 17**

Thrips are usually small, elongate, blackish insects, often with two pairs of narrow, hair-fringed wings. The tips of the tarsi are swollen and bladder-like. Mouthparts are asymmetrical, forming a short triangular piercing beak. Some

are important pests of crops such as *Citrus*, and they also transmit plant diseases.

HOLOMETABOLA

☛ Order Megaloptera (alderflies) • Fig. 18

Alderfly larvae are aquatic predators and live in mountain streams or ponds. Adults are soft-bodied, dull-brown insects with two pairs of similar membranous wings and long filamentous antennae. The two pairs of wings are usually wrapped around the body when folded.

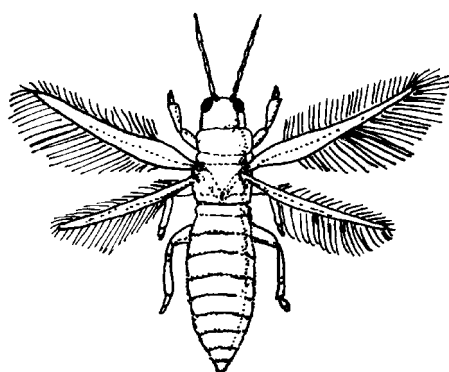


Fig. 17. Thysanoptera

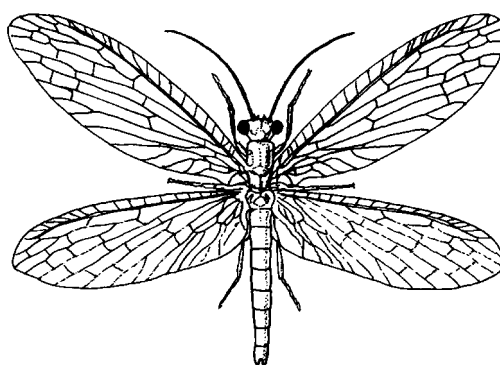


Fig. 18. Megaloptera

☛ Order Raphidioptera (snakeflies) • Fig. 19

Snakeflies are elongate, brownish insects with a long thorax and two pairs of clear membranous wings. Adults and larvae are predacious. Larvae usually occur under bark. Snakeflies do not occur in sub-Saharan Africa.

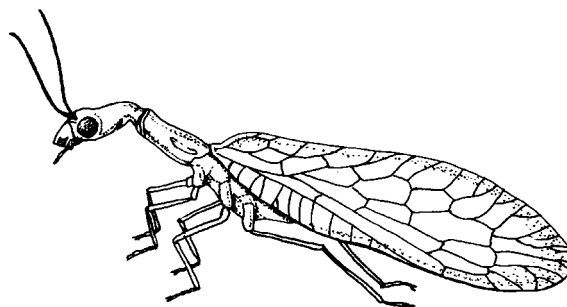


Fig. 19. Raphidioptera

☛ Order Neuroptera (lacewings, antlions, owlflies) • Fig. 20

Characterised by two pairs of membranous wings, with numerous cross-veins, held roof-like over the body when at rest. Antennae are variable but always conspicuous, and mouthparts of adults are adapted for biting and chewing. Larval mouthparts are unique among insects, and are usually stout and curved, adapted for piercing and sucking. Larvae of all families are predacious, and are significant in agriculture and the environment as predators of other insects.

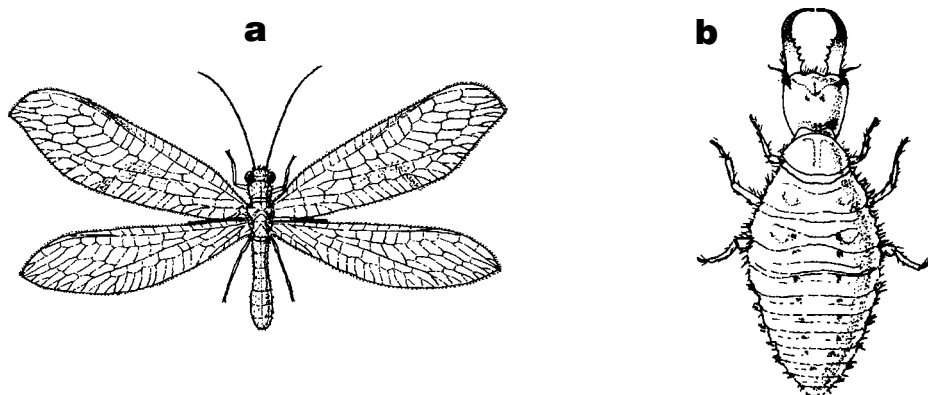


Fig. 20. Neuroptera (a) adult; (b) larva

☛ Order Mecoptera (scorpionflies, hangingflies) • Fig. 21

Adults have very long legs and two pairs of similar wings. The head is modified into an elongate rostrum. Adults are usually found in damp, shaded habitats and have elaborate courtship behaviour. They are predacious insects.

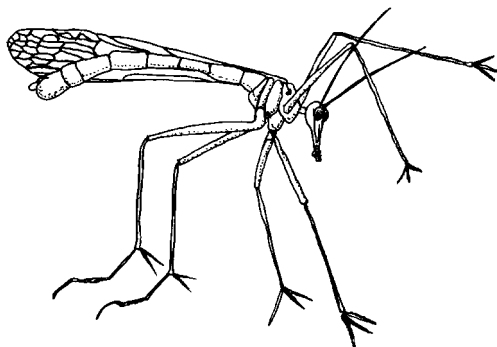


Fig. 21. Mecoptera

☛ Order Trichoptera (caddisflies) • Fig. 22

The larvae are aquatic and many live in cases that they construct from small stones or twigs. They feed on water-borne detritus. Adults are soft-bodied, hairy, have long antennae and resemble moths.

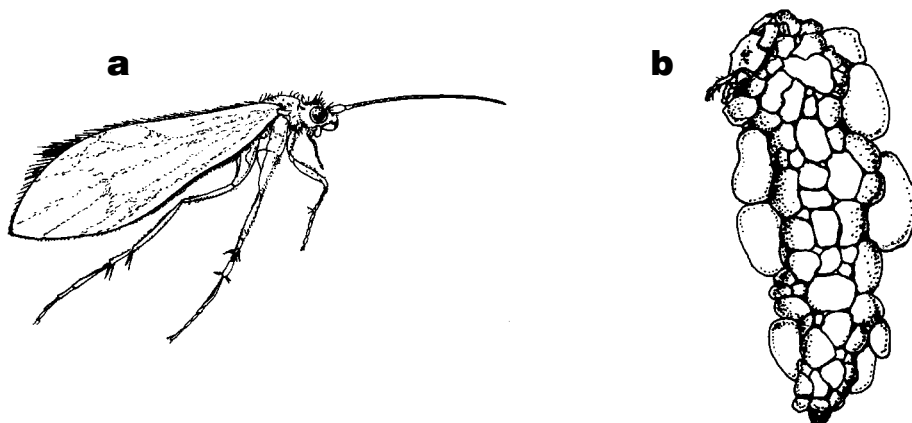


Fig. 22. Trichoptera (a) adult; (b) larva

☛ Order Siphonaptera (fleas) • Fig. 23

Fleas are small, lack wings and are laterally flattened. They jump well and are parasitic on birds and mammals, including humans. They transmit several diseases, such as bubonic plague.

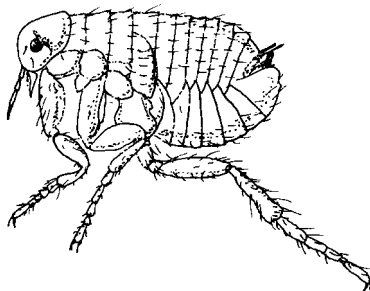


Fig. 23. Siphonaptera

☛ Order Diptera (flies, mosquitoes, midges) • Fig. 24

Flies are characterised by only one pair of wings, with the hind wings modified to form halteres. Many are secondarily wingless. Mouthparts are usually adapted for sucking or piercing. The larvae are maggot-like and true thoracic

legs are never present. Flies are highly adaptable and have evolved a great variety of lifestyles, often bringing them into direct conflict with man. Many are important agricultural pests, some parasitise other insects and many families are vectors of diseases in animals and humans.

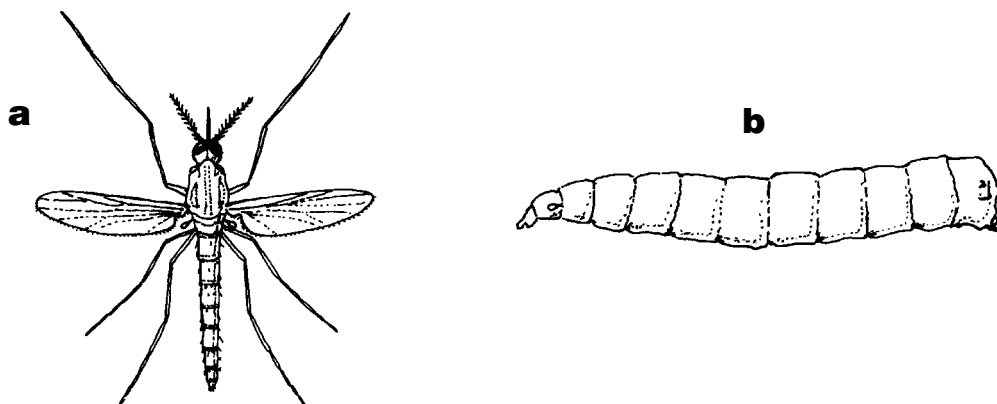


Fig. 24. Diptera (a) adult; (b) maggot

☛ Order Lepidoptera (butterflies, moths) • Fig. 25

Adults have two pairs of wings that are covered in scales, and the mouthparts are modified into a long tube which is usually coiled at rest. Larvae are generally caterpillars with a heavily sclerotised head capsule and chewing mouthparts. Three pairs of segmented legs are present on the thorax, and the abdomen has a series of prolegs bearing crotchets (hooks). The larvae damage crops and are important agricultural pests. Beneficial Lepidoptera include *Cactoblastis*, a biocontrol agent of prickly pear, and the silkworm.

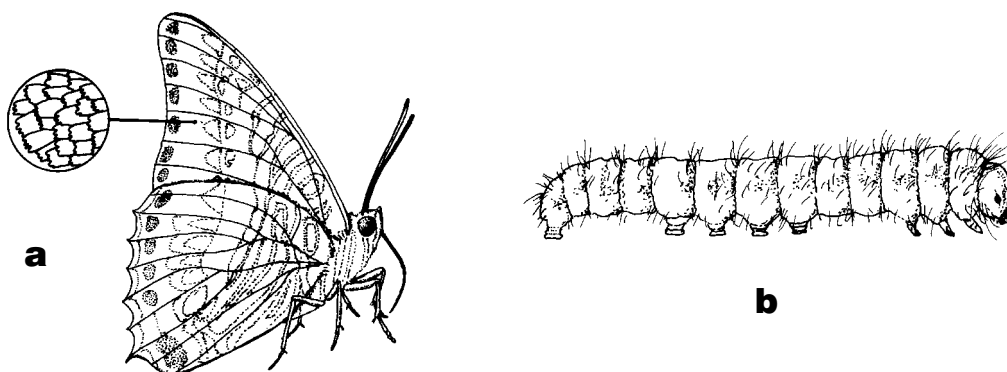


Fig. 25. Lepidoptera (a) adult, with enlargement showing scales; (b) larva

☛ Order Coleoptera (beetles) • Fig. 26

Coleoptera have two pairs of wings, with the front pair thickened to form sclerotised elytra, which cover the membranous hind wings and the abdomen. Mouthparts are adapted for biting and chewing. Larvae have a well-developed head capsule with chewing mouthparts, and usually three pairs of thoracic legs. A large number of beetle species are pests. They feed on fruits and leaves, or bore into plants, and many species damage stored products, timber and furniture.

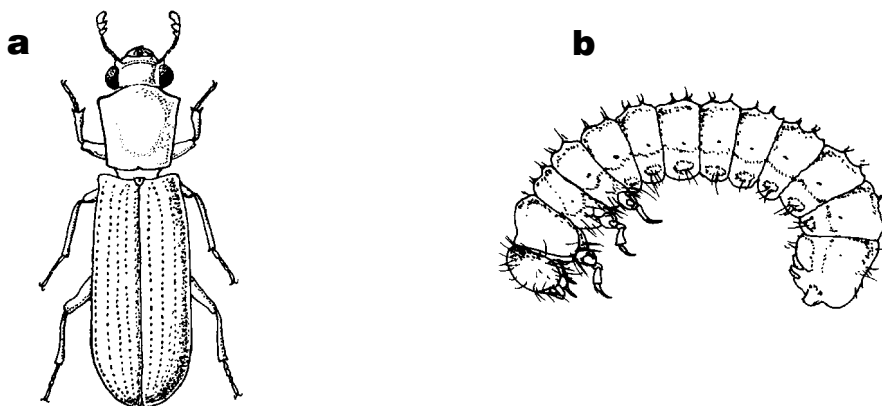
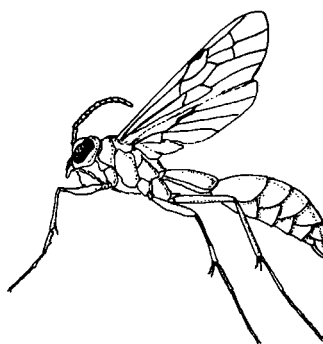


Fig. 26. Coleoptera (a) adult; (b) larva

☛ Order Hymenoptera (ants, bees, wasps) • Fig. 27

Adults usually have two pairs of membranous wings, and the base of the abdomen has a marked constriction. Mouthparts are generally chewing. Many female Hymenoptera have a defensive sting. Social behaviour is often highly developed in this order. Larvae usually lack legs and develop in nests or as parasites of other insects. A few Hymenoptera are pests whereas the majority are beneficial insects. Many species are parasitic on other insects and are important biocontrol agents, while bees produce honey and pollinate crops.

Fig. 27. Hymenoptera



Key to the orders of insects

The following key employs a minimum of specialized terminology, and will work for most adult insects. Immature stages are not included, as the identification of larval forms requires a knowledge of insect morphology that is beyond the scope of this manual.

Basic insect morphology is illustrated in Figs 28 & 29.

Consult these diagrams and the glossary on page 100 if you are unfamiliar with any of the terms used in the key.

- 1. Wings present, the front pair transparent or membranous, similar in texture to the hind pair (hind wings may be absent); forewings generally with obvious veins; wings sometimes covered with scales or hairs 2
- Wings present, the forewings leathery, thickened over the basal half, or forming hard veinless covers, folded over the body at rest and covering membranous hind wings; or wings absent 20
- 2. Wings densely covered with minute overlapping scales which rub off easily, and usually opaque; mouthparts modified as a coiled tube (Figs 25 & 29a) **Lepidoptera**
- Wings not densely covered with minute scales, and usually transparent; mouthparts otherwise 3
- 3. Wings short and narrow, with not more than 2 longitudinal veins, and with a wide marginal fringe of hairs; ends of tarsi swollen, bladder-like, lacking evident claws; very small elongate insects, usually less than 5 mm long . . (Fig. 17) **Thysanoptera**
- Wings otherwise; tarsi generally with evident claws, sometimes with terminal pads but not ending in bladder-like tips 4
- 4. End of abdomen bearing 2 or 3 long filaments, which are similar in length to the body, or longer; wings somewhat triangular, held upright at rest; hind wings small (Fig. 3) **Ephemeroptera**

Higher classification of insects and arachnids

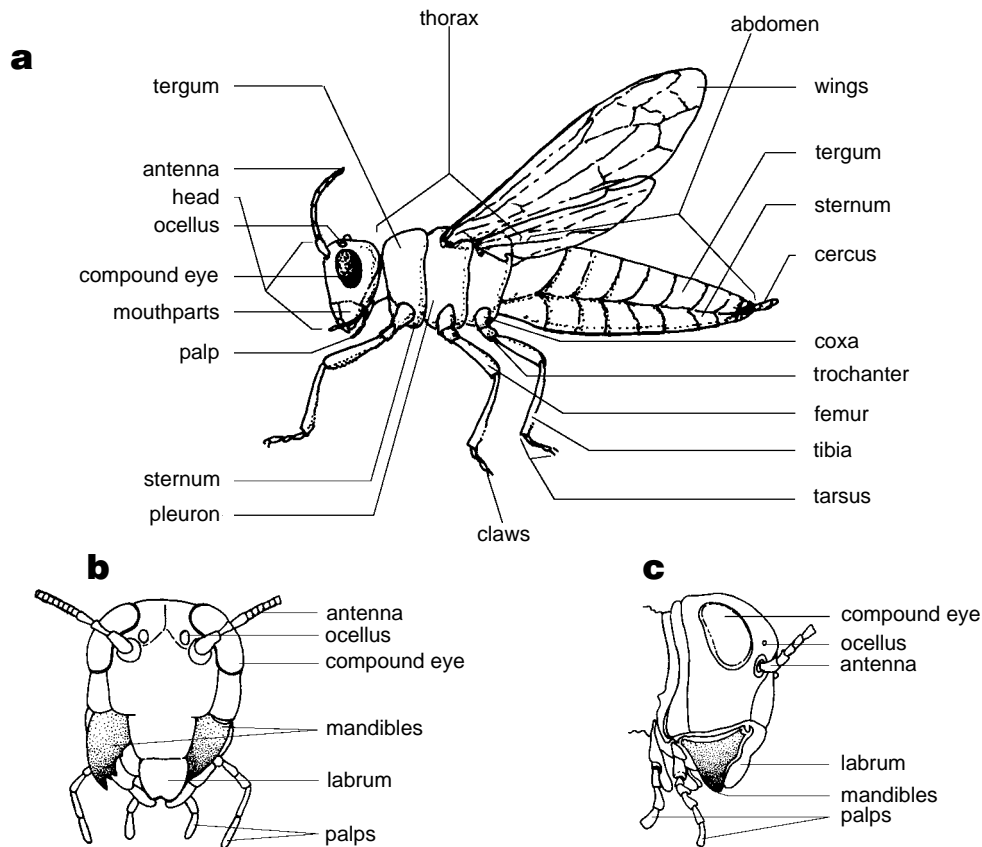


Fig. 28. (a) Basic insect morphology; (b) anterior aspect of head; (c) lateral aspect of head

- Abdomen with short terminal filaments, or none at all 5
- 5.** With only 1 pair of wings, the hind wings being reduced to a pair of halteres (small club-shaped organs, comprising a knob borne on a slender stalk). (Fig. 24) **Diptera**
- With 2 pairs of wings 6
- 6.** Forewings clearly longer than hind wings, and larger in area 7
- Forewings similar in length to hind wings, perhaps only slightly longer, sometimes smaller in area than the hind wings 10

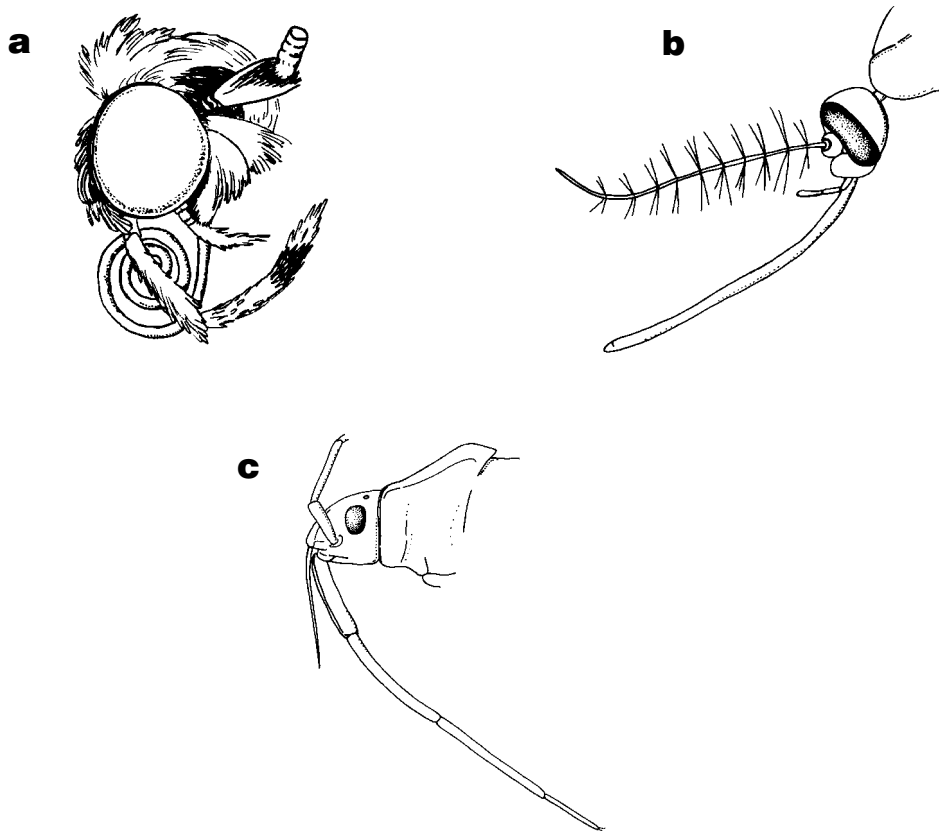


Fig. 29. Examples of modified mouthparts: (a) Lepidoptera; (b) Diptera; (c) Hemiptera

- 7. Mouthparts modified as a beak-like rostrum, adapted for piercing and sucking; palps absent (Figs 16 & 29c) **Hemiptera**
- Mouthparts adapted for chewing or biting, not forming a piercing rostrum; palps often evident. **8**
- 8. Moth-like insects with hairy, opaque wings; palps long; antennae about the same length as the body or much longer (Fig. 22) **Trichoptera**
- Wings transparent or translucent, not hairy or at most with hairs along the veins; palps short or inconspicuous; antennae usually shorter than the body. **9**
- 9. Tarsi usually 5-segmented (sometimes with 3 or 4 segments);

- abdomen generally constricted into a narrow 'waist' close behind the thorax (Fig. 27) **Hymenoptera**
- Tarsi 2- or 3-segmented, abdomen not constricted into a 'waist'; small delicate insects less than 7 mm long, with large mobile head, bulging 'face'; wings usually folded roof-wise over abdomen at rest, and with distinct venation (Fig. 12) **Psocoptera**
- 10.** Head prolonged to form a beak-like structure, bearing chewing mouthparts; legs long and thin (Fig. 21) **Mecoptera**
- Head not elongated and beak-like 11
- 11.** Antennae very short, bristle-like; eyes large; legs situated well forward on thorax and wings placed far back (Fig. 4) **Odonata**
- Antennae not short and bristle-like; eyes medium-sized to small 12
- 12.** Hind wings much broader than forewings, cerci conspicuous (Fig. 10) **Plecoptera**
- Hind wings only slightly broader than forewings, or narrower; cerci absent 13
- 13.** Wings very hairy and opaque; moth-like insects with antennae as long as body or longer; mouthparts weak with vestigial mandibles. (Fig. 22) **Trichoptera**
- Wings not hairy, usually transparent; antennae generally shorter than body; mandibles nearly always well developed. 14
- 14.** Wings with numerous cross-veins, tarsi 5-segmented; often large insects, over 10 mm long (sometimes smaller) 15
- Wings with few cross-veins, tarsi 2- to 4-segmented; small insects, mostly less than 10 mm long 18
- 15.** Prothorax very elongate. 16
- Prothorax not elongate, or if slightly so, then hardly longer than wide 17

- 16.** Front legs raptorial (adapted for seizing prey), and attached to the anterior part of the prothorax . . . (Fig. 20) **Neuroptera**
- Front legs adapted for walking, similar to the other pairs, and attached to the posterior part of the prothorax (Fig. 19) **Raphidioptera**
- 17.** Wing veins with marginal furcations ('end-twigging'); ocelli (simple eyes) usually absent (Fig. 20) **Neuroptera**
- Wings lacking marginal furcations; ocelli often present (Fig. 18) **Megaloptera**
- 18.** Tarsi 4-segmented; antennae moniliform (bead-like) with 10 or more segments; insects that live in social units with numerous sterile soldiers and workers (Fig. 15) **Isoptera**
- Tarsi 2- or 3-segmented. 19
- 19.** Tarsi 3-segmented, first segment of foretarsus very enlarged, bulbous; antennae with 12 or more segments (Fig. 9) **Embioptera**
- Tarsi 2-segmented, first segment of foretarsus not greatly enlarged; antennae 9-segmented (Fig. 11) **Zoraptera**
- 20.** Wings present, forewings thickened 21
- Wings completely absent. 27
- 21.** Abdomen with a pair of forceps-like appendages at the end (Fig. 8) **Dermaptera**
- Abdomen lacking forceps-like appendages 22
- 22.** Mouthparts modified to form a piercing, sucking rostrum (Figs 16 & 29c) **Hemiptera**
- Mouthparts chewing or biting, not modified into a piercing, sucking rostrum 23
- 23.** Very long stick-like insects, with elongate mesothorax and metathorax; legs long, all pairs adapted for walking; medium-sized to very large insects (Fig. 7) **Phasmatodea**

22	Higher classification of insects and arachnids	
—	Not with the above combination of features	24
24.	Forewings modified into rigid wing cases, lacking evident veins and meeting in a straight line down the centre, partly or entirely covering hind wings and abdomen; hind wings membranous and folded beneath forewings when at rest (Fig. 26)	Coleoptera
—	Forewings with veins, folded roof-like over abdomen at rest, or overlapping	25
25.	Hind legs modified for jumping (Fig. 14)	Orthoptera
—	Hind legs adapted for walking or running	26
26.	Forelegs raptorial (adapted for seizing prey) (Fig. 6)	Mantodea
—	Forelegs not raptorial; adapted for running (Fig. 5)	Blattodea
27.	End of abdomen with 3 long multi-segmented appendages	28
—	End of abdomen lacking appendages, or with only 2 short ones	29
28.	Eyes dorsally contiguous (meeting each other) (Fig. 1)	Archaeognatha
—	Eyes dorsally separated, or absent (Fig. 2)	Thysanura
29.	Body flattened laterally (from side to side); small jumping insects, usually 2–4 mm long, living as ectoparasites on birds or mammals. (Fig. 23)	Siphonaptera
—	Body seldom laterally flattened; insects that generally do not jump	30
30.	Abdomen constricted behind thorax to form a distinct ‘waist’ (Fig. 27)	Hymenoptera
—	Abdomen without a waist-like constriction	31
31.	Body flattened dorsoventrally (from top to underside); small insects, up to 10 mm long but often much less, living as ectoparasites on birds or mammals. (Fig. 13)	Phthiraptera

Higher classification of insects and arachnids**23**

- Body generally not markedly flattened dorsoventrally; not living as ectoparasites on birds or mammals **32**
- 32.** Body narrow, tarsi swollen and bladder-like at their tips, lacking claws; small insects less than 5 mm long (Fig. 17) **Thysanoptera**
- Tarsi generally with evident claws, sometimes with terminal pads but not ending in bladder-like tips **33**
- 33.** Mouthparts modified to form a piercing, sucking rostrum (Figs 16 & 29c) **Hemiptera**
- Mouthparts adapted for chewing or biting, not modified to form a piercing, sucking rostrum **34**
- 34.** Very long stick-like insects, with elongate mesothorax and metathorax; legs long, all pairs adapted for walking; medium-sized to very large insects (Fig. 7) **Phasmatodea**
- Not with the above combination of features. **35**
- 35.** Hind legs modified for jumping. (Fig. 14) **Orthoptera**
- Hind legs adapted for walking or running **36**
- 36.** First tarsal segment of foreleg conspicuously enlarged, bulbous. (Fig. 9) **Embioptera**
- First tarsal segment of foreleg not conspicuously swollen. **37**
- 37.** Cerci absent, head large and mobile with bulging 'face', tarsi 2- or 3-segmented (Fig. 12) **Psocoptera**
- Cerci present **38**
- 38.** Tarsi nearly always 5-segmented; body dorsoventrally flattened, pronotum enlarged, antennae long, multi-segmented; cerci elongate and conspicuous, multi-segmented; large insects, mostly over 10 mm long (Fig. 5) **Blattodea**
- Tarsi 2- to 4-segmented; cerci short; small insects, less than 10 mm long **39**

- 39.** Tarsi 4-segmented; antennae moniliform (bead-like) with 10 or more segments; insects that live in social units with numerous sterile soldiers and workers (Fig. 15) **Isoptera**
- Tarsi 2-segmented; antennae 9-segmented (Fig. 11) **Zoraptera**

Further reading

- BLACKMAN, R.L. & EASTOP, V.F. 1984. *Aphids on the World's Crops: An Identification and Information Guide*. John Wiley & Sons, Chichester. 466 pp.
- BORROR, D.J., DE LONG, D.M. & TRIPLEHORN, C.A. 1981. *Introduction to the Study of Insects*. Saunders College Publishing, Philadelphia. 827 pp.
- BORROR, D.J. & WHITE, R.E. 1972. *A Field Guide to the Insects of America North of Mexico*. Houghton Mifflin Co., Boston. 404 pp.
- CSIRO. 1991. *The Insects of Australia*. 2 Vols. Melbourne University Press, Carlton, Victoria. 1137 pp.
- HOLM, E. & DE MEILLON, E. 1986. *Insects*. Struik Pocket Guides for Southern Africa. Cape Town. 64 pp.
- LONDT, J.G.H. 1984. *A Beginner's Guide to the Insects*. The Wildlife Society of Southern Africa. 100 pp.
- PALMER, J.M. 1990. Identification of the Common Thrips of Tropical Africa (Thysanoptera: Insecta). *Tropical Pest Management* 36(1): 27–49.
- RICHARDS, O.W. & DAVIES, R.G. 1978. *Imms' Outlines of Entomology*. Chapman & Hall, London. 254 pp.
- SCHOLTZ, C.H. & HOLM, E. (Eds.) 1985. *Insects of Southern Africa*. Butterworths, Durban. 502 pp.
- SKAIFE, S.H. 1979. *African Insect Life*. C. Struik Publishers, Cape Town, Johannesburg. 279 pp.
- WILLIAMS, D.J. & WATSON, G.W. 1988a. *The Scale Insects of the Tropical South Pacific Region. Part 1. The Armoured Scales (Diaspididae)*. C.A.B. International Institute of Entomology, London. 290 pp.
- WILLIAMS, D.J. & WATSON, G.W. 1988b. *The Scale Insects of the Tropical South Pacific Region. Part 2. The Mealybugs (Pseudococcidae)*. C.A.B. International Institute of Entomology, London. 262 pp.

3.2

Arachnids

Arachnids are characterised by four pairs of legs, the absence of antennae or wings, and only two body regions – a cephalothorax and an abdomen. The term *arachnida* is derived from Greek *arachne*, which means 'spider'.

As with insects, arachnids are of great significance to man. While most are predators, and therefore beneficial, many are pests of crops or are detrimental to the health of livestock and humans.

The class Arachnida comprises 11 orders, 8 of which occur in southern Africa. These are discussed briefly below:

☛ Order Acari (mites, ticks) • Fig. 30

Very small animals, with body segments fused into one unit. Oval, sac- or worm-like in appearance, with no demarcation between the cephalothorax and abdomen. Eyes are usually absent. The chelicerae consist of 3 segments and are often pincer-like in shape. Pedipalpi comprise 1–6 segments, and are generally in the form of free limbs. The first two body segments, including chelicerae and pedipalpi, form a separate movable gnathosoma (mouth region). There are usually 8 legs in the adult stage, but the number may vary from 2–8. Mites are very small, usually less than 1 mm long; engorged ticks may be much larger. Few animal groups illustrate the enormous diversity in form, habitat and behaviour as do the Acari. They have colonised almost every

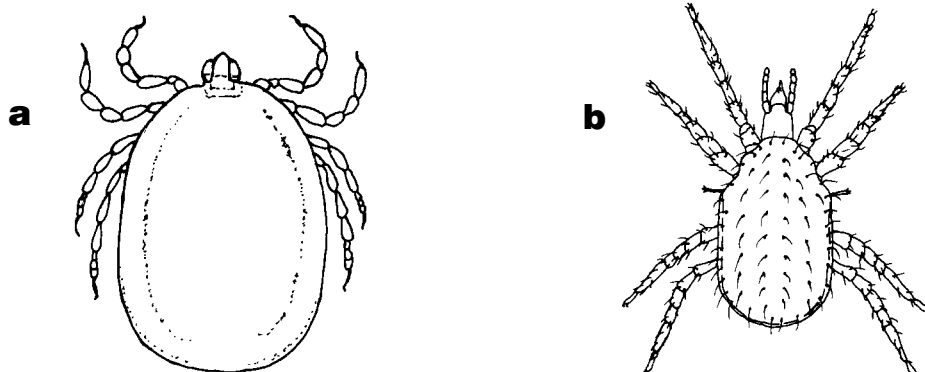


Fig. 30. Acari (a) tick; (b) mite

terrestrial, marine and fresh water habitat. Some are phytophagous or predacious, others are external or internal parasites of both vertebrates and invertebrates, whereas others are free-living in soil.

☛ Order Amblypygi (whip-spiders or tail-less whip-scorpions) • Fig. 31

Dark brown arthropods, characterised by a very long, whip-like pair of front legs. The cephalothorax is wide and attached to the segmented abdomen by a pedicel. Eight eyes are present. The chelicerae consist of 2 segments. The pedipalpi, which are large and powerful are used to grab prey. Their size ranges from 11–20 mm. They are nocturnal hunters and prey on any invertebrate which can be overpowered. Amblypygi are widespread in more humid areas and live in narrow crevices, under stones or bark. They are often found in houses or in the exfoliations of banana trees.

☛ Order Araneae (spiders) • Fig. 32

Spiders vary considerably in shape and colour. The cephalothorax is connected to the unsegmented abdomen by a thin pedicel. They usually have 8 eyes but the number varies from none to six. The chelicerae are strong and bear fangs with a venom gland opening at each tip. The pedipalpi are leg-like, tactile and are used by males as secondary sexual organs. Spinnerets are present on the posterior end of the abdomen. Spiders range in size from 0,8–120 mm. They are a large, diverse group of predators occurring in many habitats.

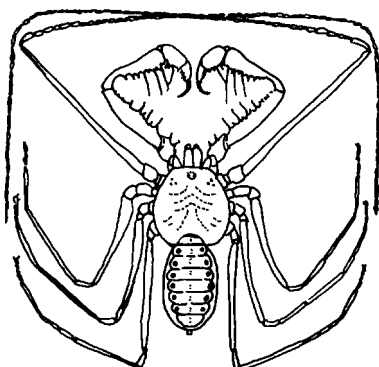


Fig. 31. Amblypygi

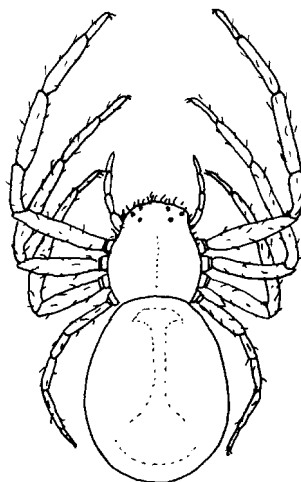


Fig. 32. Araneae

☛ Order Opiliones (harvestmen) • Fig. 33

The cephalothorax is joined broadly to the abdomen without a pedicel. Only 2 eyes are present in the middle of the head region. The chelicerae consist of 3 segments and are pincer-like in shape. The pedipalpi have 6 segments. The legs are usually very long, and are often pseudo-segmented and flexible. Their size ranges from 2–4,5 mm. Harvestmen are generally small and seldom seen. Most species occur in forested areas with high humidity. They climb shrubs and trees or are found under logs and stones. They feed mainly on living insects, snails and sometimes on dead animals or plant sap. Some harvestmen are nocturnal, while others are diurnal.

☛ Order Pseudoscorpiones (pseudoscorpions) • Fig. 34

Small arachnids with the cephalothorax broadly connected to the segmented abdomen, without a pedicel. The abdomen lacks a telson. They usually have 2 or 4 eyes, while some species are blind. The chelicerae consist of 2 segments and are pincer-like, with the distal segment bearing a spinneret that produces silk. The pedipalpi are large, 6-segmented, with venom glands opening near the tip of the metatarsus or tarsus. Most species are less than 5 mm long.

Pseudoscorpions are common everywhere, but are not easily seen because of their small size and secretive habits. The smaller forms live in debris and fertile soil, the larger forms under bark, in trees or under rocks and stones. They also occur abundantly in the nests of mammals and birds, and may be associated with bats in caves. Pseudoscorpions feed on small animals such as mites, ants and a wide variety of other insects.

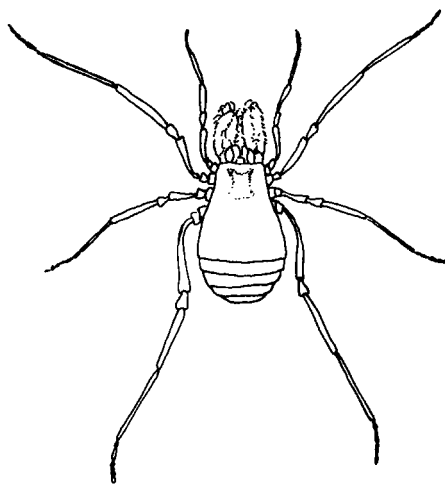


Fig. 33. Opiliones

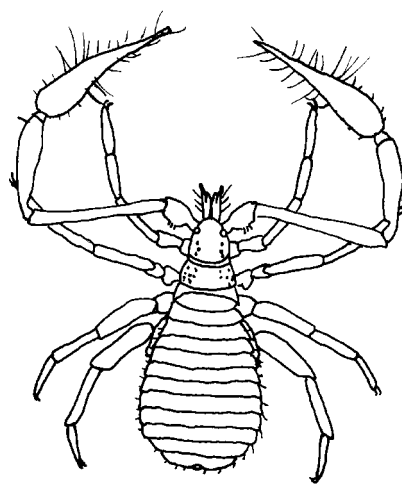


Fig. 34. Pseudoscorpiones

☛ Order Schizomida • Fig. 35

Small, weakly sclerotised animals with the carapace divided into three regions. They lack eyes. The chelicerae are 2-segmented and the pedipalpi are leg-like. The front legs are long and antenna-like. The abdomen bears a short flagellated telson at the end. Their size ranges from 4–6 mm. They are very rare, living in hidden areas, usually in plant debris and nearly always near the ground, where they prey on small insects.

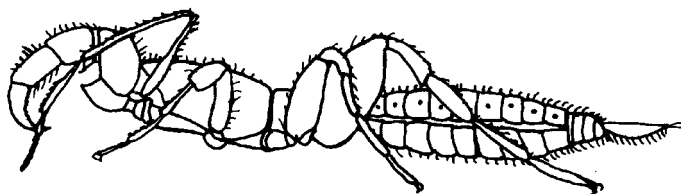


Fig. 35. Schizomida

☛ Order Scorpiones (scorpions) • Fig. 36

Cephalothorax covered by an undivided carapace broadly connected to the segmented abdomen. There are 2 eyes situated medially, and 2–5 lateral pairs. The chelicerae are small, chelate and 3-segmented. The pedipalpi are characteristically large and powerful and used to grab prey. The abdomen bears a tail formed by 5 cylindrical metasoma, with a telson in the form of a venomous sting. The venom is used to subdue prey. Their size ranges from 40–210 mm from head to tail. Most scorpions live in burrows, under or between rocks or under the bark of trees. Scorpions are predators and prey on a wide range of invertebrates and vertebrates.

☛ Order Solifugae (sun-spiders, wind-scorpions, romans) • Fig. 37

Cephalothorax consists of a head region with 2, 4 or 6 eyes, followed by 3 tergites. The chelicerae project forwards and are very conspicuous. They consist of 2 parts, each bearing strong teeth and forming a pincer, which acts like the blades of shears. The pedipalpi are leg-like in appearance and have suckers on the tips of the tarsi, enabling them to climb any surface. The cephalothorax is broadly connected to the segmented abdomen. Their size ranges from 15–50 mm. Solifugids live in retreats or burrows in sand, or under rocks and logs or in termite mounds. They are common in desert-scrubland and are seen mostly during summer. They prey on a variety of insects.

Key to the orders of southern African arachnids

Basic arachnid morphology is illustrated in Figs 42 & 43.
 Consult these diagrams and the glossary on page 100 if you are unfamiliar with any of the terms used in the key.

- 1. Cephalothorax and abdomen joined by a pedicel (Fig. 38) 2
- Cephalothorax and abdomen joined across body, lacking a pedicel 4
- 2. Carapace segmented, divided into 3 regions; last 4 segments of abdomen narrowed to form short flagellated telson (Fig. 39) (Fig. 35) **Schizomida**
- Carapace undivided; flagellated telson absent 3
- 3. First pair of legs very long, whip-like in appearance, not used for walking but as tactile organs (Fig. 31) **Amblypygi**
- First pair of legs used for walking, not whip-like . . . (Fig. 32) **Araneae**
- 4. Abdomen with metasoma consisting of 5 cylindrical segments forming a tail with a terminal sting (Fig. 40); pectines present ventrally (Fig. 41) (Fig. 36) **Scorpiones**

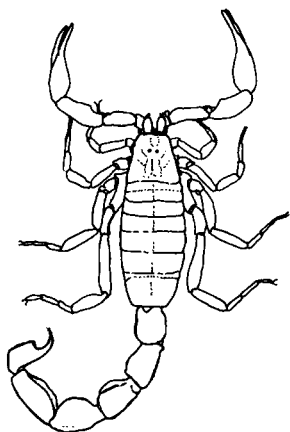


Fig. 36. Scorpiones

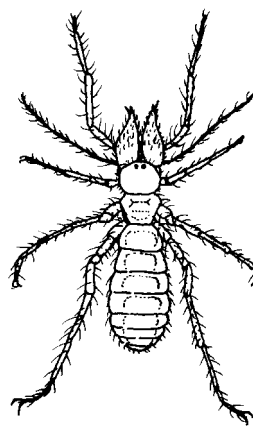


Fig. 37. Solifugae

30 Higher classification of insects and arachnids

- Posterior part of abdomen not tail-like **5**
- 5.** Cephalothorax consisting of head region and 3 tergites; chelicerae very large and distinct, consisting of 2 parts, each bearing strong teeth (Fig. 44) (Fig. 37) **Solifugae**
- Cephalothorax not as above; chelicerae not as large **6**
- 6.** Pedipalpi very large, 6-segmented, and chelate (Fig. 45) (Fig. 34) **Pseudoscorpiones**
- Pedipalpi small, not chelate **7**
- 7.** Abdomen divided into about 9 somites (Fig. 46); legs long and slender (Fig. 33) **Opiliones**
- Abdomen not divided; legs usually short (Fig. 30) **Acari**

☛ **The following arachnid orders do not occur in southern Africa:**
 Palpigradi, Uropygi and Ricinulei.

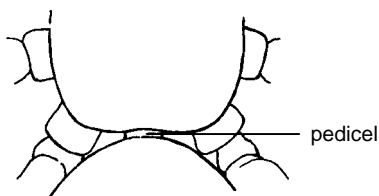


Fig. 38. Pedicel joining cephalothorax & abdomen

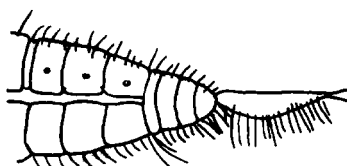


Fig. 39. Abdomen of Schizomida with flagellated telson

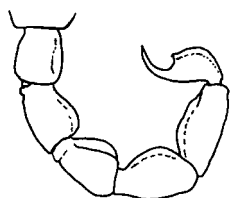


Fig. 40. Tail of Scorpiones with terminal sting

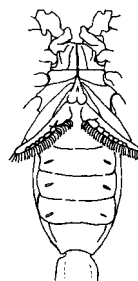


Fig. 41. Ventral aspect of Scorpiones showing pectines

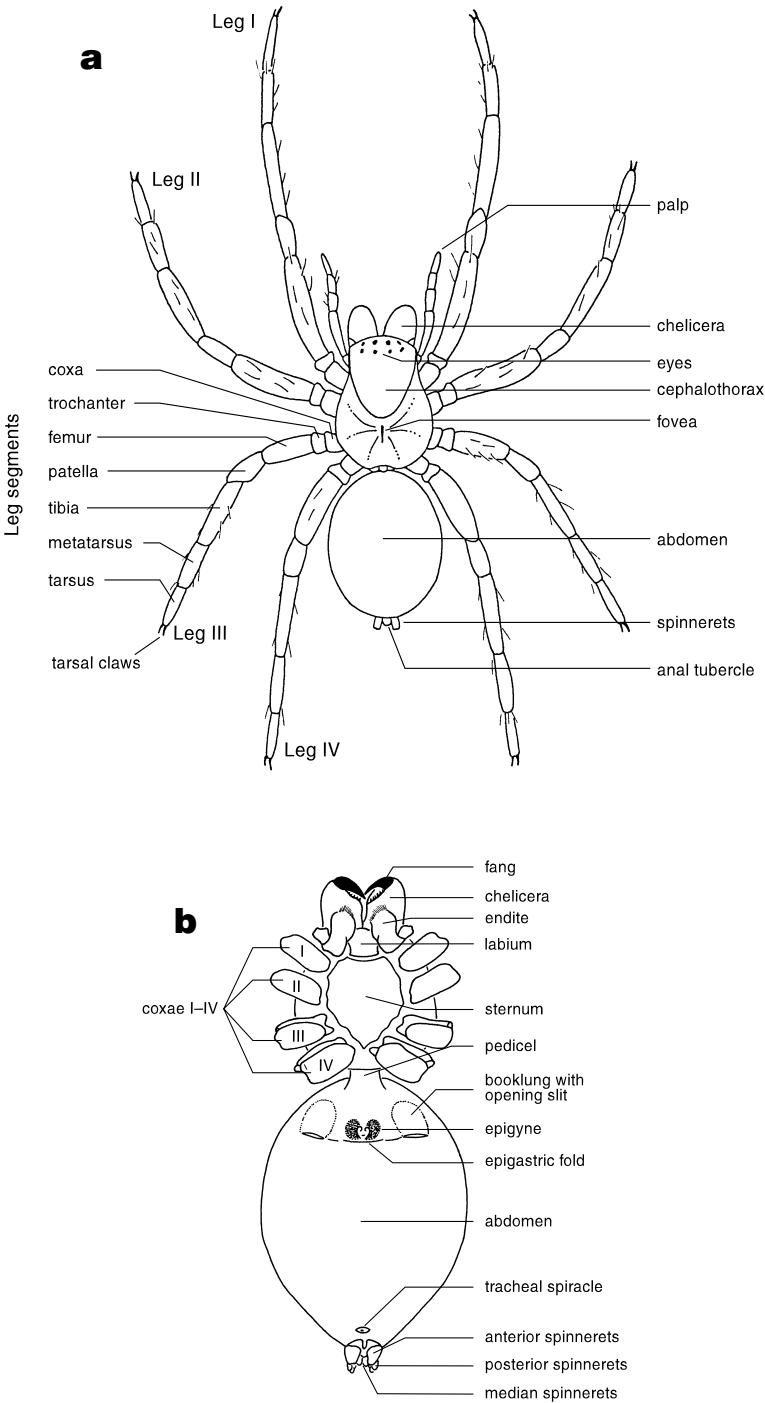


Fig. 42. Basic spider (Araneae) morphology: (a) dorsal view; (b) ventral view

Higher classification of insects and arachnids

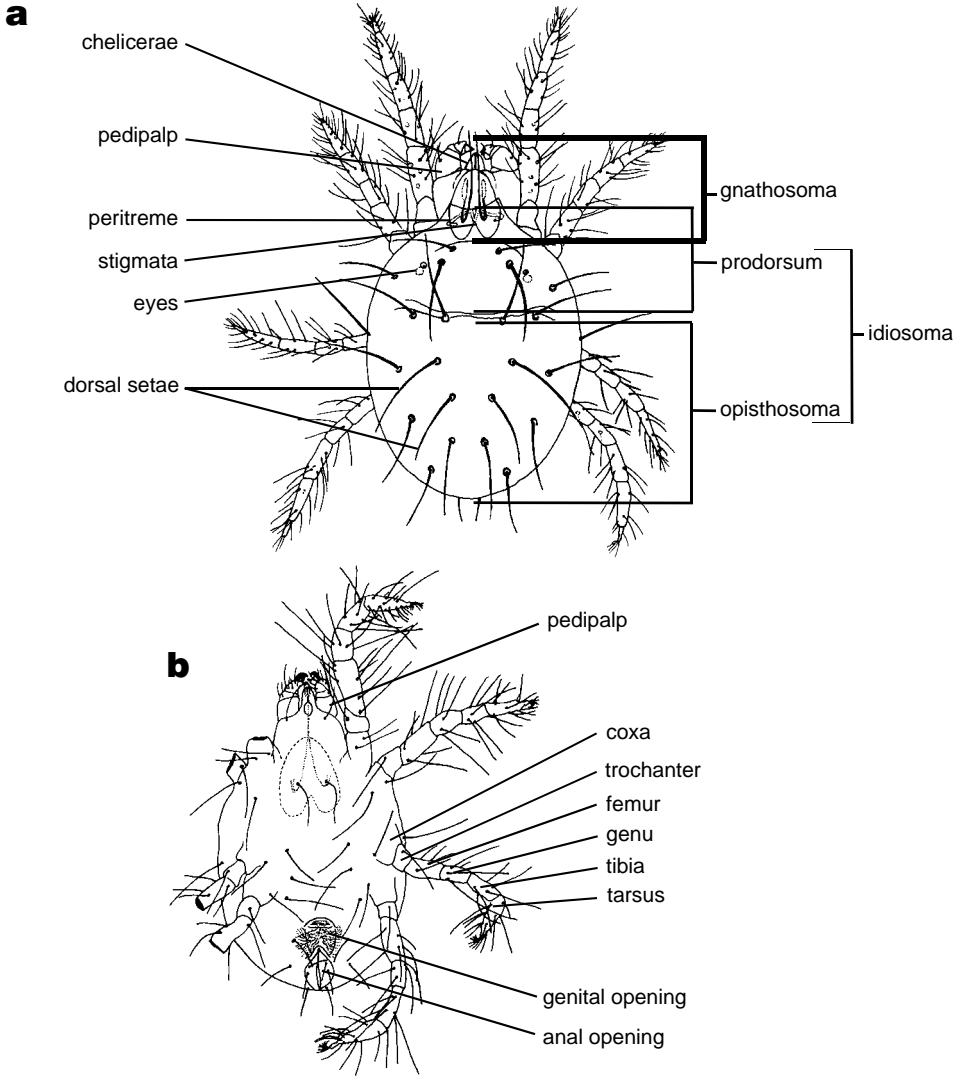


Fig. 43. Basic mite (Acari) morphology: (a) dorsal view; (b) ventral view

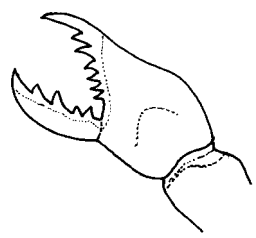


Fig. 44. Large chelicera of Solifugae

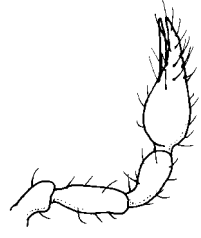


Fig. 45. Large pedipalp of Pseudoscorpiones

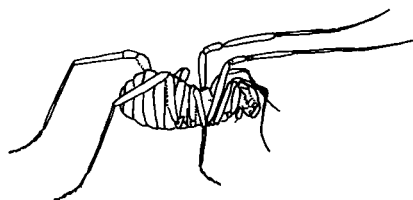


Fig. 46. Abdomen of Opiliones divided into 9 somites

Further reading

- BURTON, M. & BURTON, R. 1977. *Encyclopedia of Insects & Arachnids*. Evans Brothers Limited. 252 pp.
- COMSTOCK, J.H. 1977. *The Spider Book*. Cornell University Press, Ithaca & London. 729 pp.
- DIPPENAAR, A. & DIPPENAAR, N. 1987. *Spiders*. Insight Series. De Jager-Haum, Pretoria. 47 pp.
- DIPPENAAR-SCHOEMAN, A.S. & JOCQUÉ, R. 1997. *African Spiders: An Identification Manual*. ARC – Plant Protection Research Institute Handbook No. 9, Pretoria. 400 pp.
- FILMER, M.R. 1991. *Southern African Spiders, An Identification Guide*. Struik, Cape Town. 128 pp.
- JONES-WALTERS, L.M. 1989. Keys to the Families of British Spiders. *Field Studies* 9: 365–443.
- KASTON, B.J. 1980. *How to know the Spiders*. The Picture Key Nature Series. C. Brown Company Publishers, Dubuque, Iowa. 272 pp.
- KRANTZ, G.W. 1978. *A Manual of Acarology*. Second Edition. Oregon State University Book Stores, Corvallis. 509 pp.
- LEVI, H.W. & LEVI, R.R. 1968. *A Guide to Spiders and Their Kin*. Golden Press, New York. 160 pp.
- NEWLANDS, G. 1987. *Spinnekoppe & Skerpioene*. Struik, Cape Town. 25 pp.
- NEWLANDS, G. 1987. *Scorpions*. Insight Series. De Jager-Haum, Pretoria. 40 pp.
- NEWLANDS, G. 1990. *Spiders*. Struik, Cape Town. 64 pp.
- PRINS, A. & LE ROUX, V. 1986. *South African Spiders & Scorpions*. Annubis Press, Cape Town. 72 pp.
- SAVORY, T. 1977. *Arachnida*. Second Edition. Academic Press, London. 339 pp.
- SMITH-MEYER, M.K.P. 1981. *Mytplae van Landbougewasse in Suid-Afrika*. Wetenskap Pamflet, Departement van Landbou en Visserye. 92 pp.
- SMITH-MEYER, M.K.P. 1996. *Mite Pests and their Predators on Cultivated Plants in Southern Africa*. ARC – Plant Protection Research Institute Handbook No. 6, Pretoria. 90 pp.

4. **C**ollecting methods

A large variety of methods have been devised for collecting insects and arachnids. Some methods are suitable for collecting a wide range of arthropod groups that occur in many different habitats, whereas others are designed for catching specific types of insects and arachnids in particular habitats. The collecting method chosen will depend on the particular species or groups that are being sought (see the list on page 53), and whether live or dead specimens are required.

4.1

Collecting bag

A lightweight bag with a shoulder or waist strap is required for carrying collecting equipment in the field.

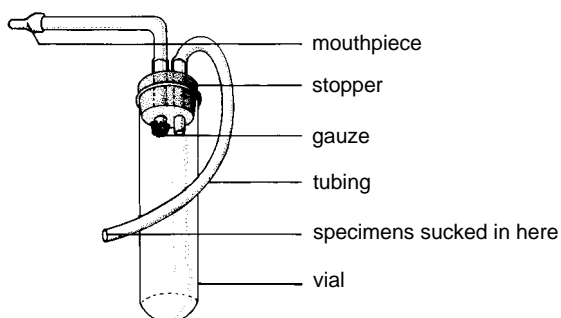
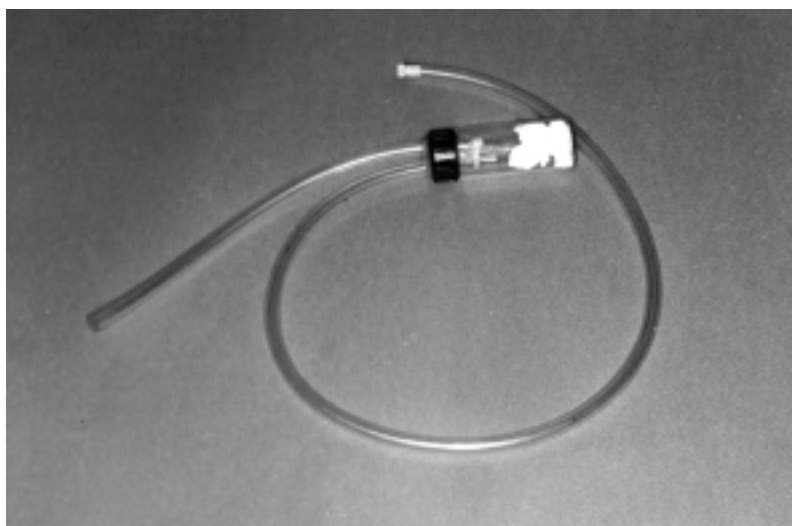
A basic kit of items for collecting arthropods consists of the following:

- ☞ Killing bottles of various sizes
- ☞ Aspirators
- ☞ Forceps
- ☞ Tissue paper for lining killing bottles and aspirators
- ☞ Plastic and paper bags for plant specimens
- ☞ Paper towelling to absorb moisture in bags of plant samples
- ☞ Small paint brush for picking up small specimens
- ☞ Pocket knife for opening galls, fruit, seeds etc.
- ☞ Field notebook and pencil
- ☞ Vials with alcohol or other preservative
- ☞ Handlens
- ☞ Containers for specimens, e.g. paper envelopes, small boxes, vials
- ☞ Secateurs (plant shears)

4.2

Aspirators

An aspirator (also called a pooter) is used for catching small specimens by sucking them into a container. It is also useful for collecting small specimens that need to be kept alive. An aspirator consists of a glass or Perspex vial, with a stopper pierced by two flexible tubes, as illustrated in Fig. 47. The end of one of the tubes is covered by a small piece of gauze to prevent specimens from being drawn into the operator's mouth. Specimens are collected by sucking on the end of the gauze-covered pipe while holding the end of the other tube close to them. A piece of absorbent paper should be placed in the vial to absorb moisture. Specimens that have been caught in the aspirator can be killed by introducing a small piece of cotton wool dipped in ethyl acetate into the vial. This ball of wool can be blown down the open-ended tube into the vial, to avoid having to remove the stopper and risk specimens escaping. Aspirators are commercially available but can easily be home-made.

**Fig. 47. Aspirator**

4.3

Hand collecting

Sedentary or slow-moving arthropods may be collected by hand. As many insects and arachnids can bite or sting, forceps should be used to pick them up, unless one is certain that they are harmless.

A wide variety of specimens can be found by searching on plants, which are a food source, refuge or place to lay eggs for many species. Specimens occur on or in various parts of the plant, such as leaves, roots, stems, seeds, fruit and flowers. These places are habitats for spiders, adult and immature insects like moths, flies, butterflies and wasps as well as mites, harvestmen, pseudoscorpions, scale insects, planthoppers, stick insects and mantids. Crevices in the rough bark of trees are also home to spiders, scorpions and various insects. Brushing the bark with a soft brush will dislodge them into a convenient receptacle such as a white tray. Some arthropods, such as mites, parasitic wasps and flies, can be detected by the damage they cause to plants. Galls, bud-scales, shoot- and twig-clustering, twig-rosettes and brooming should be collected and examined under a stereo-microscope for specimens. Healthy plant samples should also be examined as some phytophagous mites do not cause visible damage.

An abundance of spiders, scorpions, earwigs, beetles, fishmoths and pseudoscorpions can be found by looking under stones and logs and in leaf litter. A number of spiders and scorpions live in burrows in the soil and under stones. Burrows of spiders are always lined with silk. The well-camouflaged burrows of trapdoor spiders can be exposed by sweeping the ground with a brush or broom with stiff bristles. The burrow is then excavated with a hand shovel but care should be taken to keep the burrow intact.

Web-dwelling spiders can be readily collected directly from their webs, although larger specimens should first be sprayed with alcohol to prevent them from escaping. A miner's headlamp is effective in locating nocturnal spiders, especially those with reflective eyes, such as wolf spiders. Warm, damp and dark places in buildings harbour cockroaches, booklice, fishmoths, spiders, pseudoscorpions and whip-spiders. Stored grain may be infested with a variety of beetles, moths, booklice and mites. Bedbugs and house-dust mites may be found in bedding and crevices in neglected rooms. The timber of buildings may be inhabited by termites and wood-boring beetles.

Scorpions fluoresce when exposed to ultraviolet light, making it easy to detect them at night. A portable fluorescent light (used for camping) can easily be equipped with ultraviolet bulbs. The best results are obtained at new moon or when the moon is half full or at first and last quarter, making the scorpions visible from up to 15 m. The scorpions are placed in a suitable container like a bucket, large bottle or a small plastic bag, using long forceps. Collecting with

an ultraviolet light is suitable for burrowing and rock-dwelling scorpions. The collector should wear safety glasses to protect his/her eyes from ultraviolet rays.

4.4

Collecting nets

There are three basic types of nets:

Aerial nets

Aerial nets are used to collect flying insects like butterflies, antlions, flies, dragonflies, grasshoppers, wasps and bees. The net should be lightweight, made of a fine, soft, durable material. White fabric is generally used, but Lepidoptera collectors prefer black nets as white alarms butterflies. Aerial nets have a circular frame made from an aluminium strip to which the net is attached (Fig. 48). Holes are made at regular intervals in the metal frame for tying on the net, as shown in Fig. 49. A frame can also be made of thick wire. A band of cloth, with a deep hem to allow the frame of the net to pass through, is

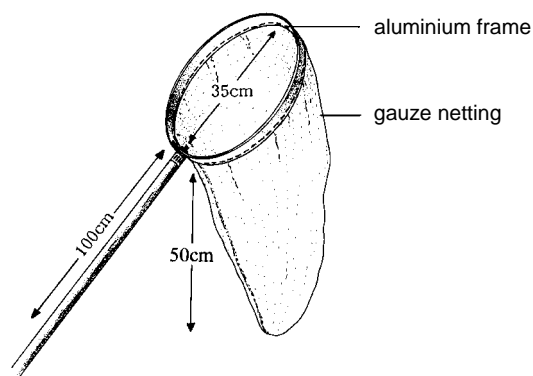


Fig. 48. Aerial net

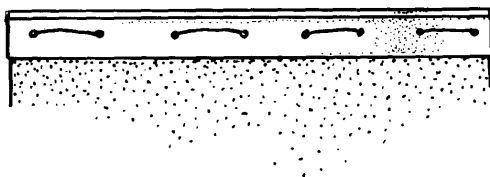


Fig. 49. Attachment method of net to frame

sewn around the top of the net (Fig. 50). This band should be of durable material, like calico, to withstand knocks of the frame against stones, trees and other hard objects. The handle of the net can be of wood or aluminium, and should have a comfortable grip. An angler's landing net with the mesh bag replaced by suitable gauze makes a very acceptable net. A detachable extension to the handle is useful for collecting insects flying or sitting out of normal reach. Once the insect has been caught, the end of the net must be flipped over to prevent it escaping (Fig. 51). Specimens can be removed from the net with the fingers if harmless, or directed into a killing bottle or vial of preservative. An aspirator is convenient for collecting small specimens caught in the net.

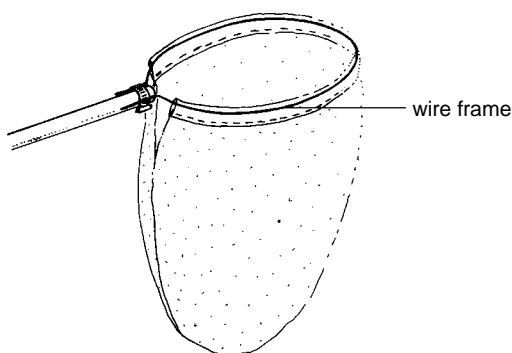


Fig. 50. Net with wire frame

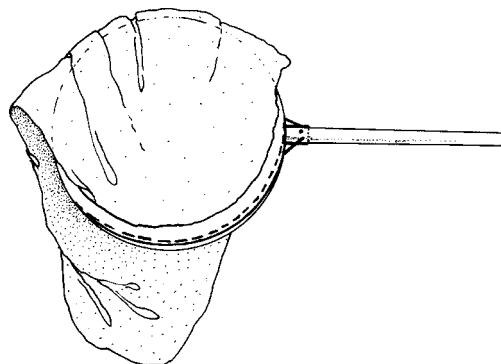


Fig. 51. Net flipped over to prevent insects escaping

Sweep nets

A most effective way of collecting large numbers of specimens, especially the many small bugs, beetles, pseudoscorpions, spiders and parasitic wasps found in grass and plant foliage, is by means of a sweep net. These types of nets are swung through the vegetation to dislodge the specimens, which are knocked

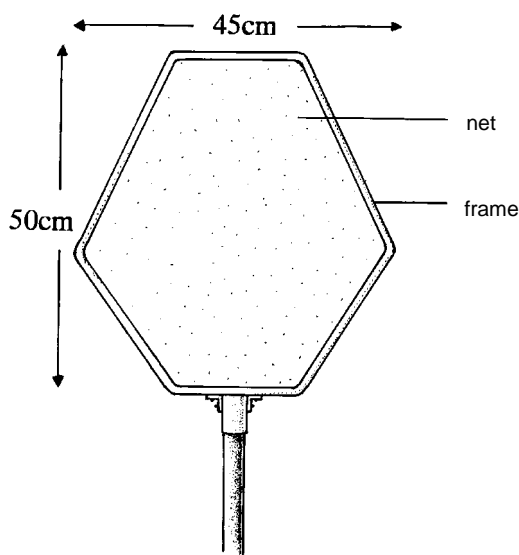


Fig. 52. Sweep net

off plants into the bag of the net. Sweep nets are more sturdy than aerial nets, with a wider diameter (Fig. 52). They usually have a hexagonal shape which allows better contact with the foliage being swept. As with aerial nets, a handle extension can also be used for sampling foliage which would otherwise be out of reach.

Care should be taken to prevent too much plant debris accumulating in the bag, since this will damage the specimens and make it difficult to extract them. As specimens tend to crawl towards the light, the sun should always be at one's back when removing specimens from the bag. An aspirator should be used for catching smaller insects in the net, such as bugs, parasitic wasps, flies and beetles. To avoid small specimens escaping, the rim of the bag can be placed over the collector's head while the insects are collected from inside the net with the aspirator.

Aquatic nets

An aquatic net should offer minimum resistance when dragged through water, but have a fine enough mesh to capture small specimens. The bag of the net need not be deep, and should be made of a synthetic mesh such as nylon. Transparent material is preferable, to make viewing of the catch possible. The band at the top of the net, as in other nets, must be of strong material. The arthropods caught in the net can be tipped into a white tray or similar receptacle to facilitate sorting.

4.5

Beating sheets

Well-camouflaged or hidden species on plants are best collected with a beating sheet. This method is useful for collecting sessile or wingless groups such as some beetles and bugs, stick insects, caterpillars, pseudoscorpions, spiders and mites. These are knocked from the vegetation, by beating it with a stick, onto a sheet placed beneath the plants (Fig. 54). A hand-held beating sheet is especially convenient for sampling vegetation. This consists of a shallow canvas bag, preferably white, stretched over a folding frame (Figs 53 & 54).

A white enamel plate is more suitable than a beating sheet for collecting mites. They can be picked up from the plate with the aid of a $\times 10$ handlens and a moistened camel-hair brush.

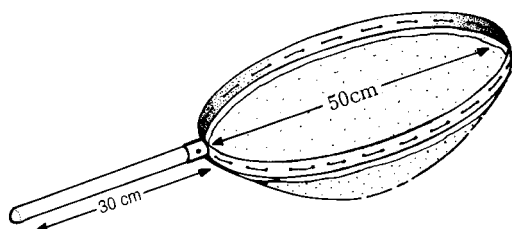


Fig. 53. Beating sheet



Fig. 54. Method of using beating sheet

4.6

Knock-down sprays

Knock-down sprays enable the collector to sample areas of a plant that are inaccessible to a net or beating sheet.

White sheets are placed beneath a tree or shrub, which is then sprayed with a fast-acting pesticide, such as a synthetic pyrethroid. The dead specimens fall from the tree onto the sheets. This technique does not work well for fast-flying insects that are easily disturbed, such as wasps, flies and grasshoppers.

4.7

Extractors**Leaf-litter and humus extraction devices**

Many tiny insects and arachnids live in leaf-litter, humus, decomposing wood, detritus and the nest litter of small mammals and birds. Examples include fishmoths, bristletails, booklice, Schizomida, pseudoscorpions, spiders, mites, wingless parasitic wasps and cockroaches. These species are generally photophobic, usually preferring moist conditions. A Berlese (Tullgren) funnel is a very effective way of sampling them. Leaf- and stem-mining species, such as the potato tuber moth, can also be extracted from plants with this device. A sample of humus or leaf-litter is placed on a gauze tray in a funnel. A light bulb is positioned above the sample, and a bottle of alcohol below the funnel (Fig. 55). The bright light and the drying effect of the hot bulb on the sample drive the specimens down into the funnel until they fall into the alcohol. Care must be taken not to dry the sample out too rapidly as this will kill the slow-moving specimens before they reach the bottom of the funnel.

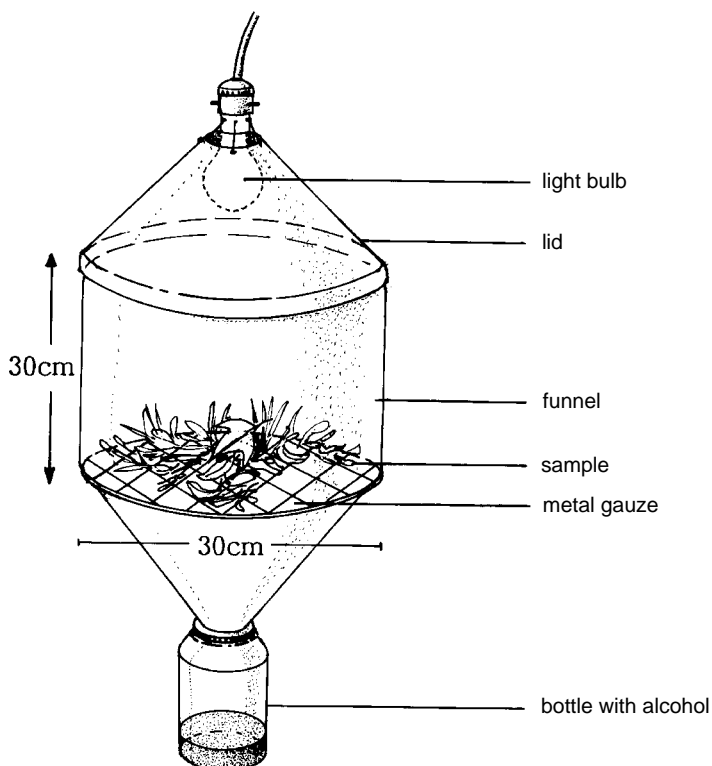


Fig. 55. Berlese (Tullgren) funnel

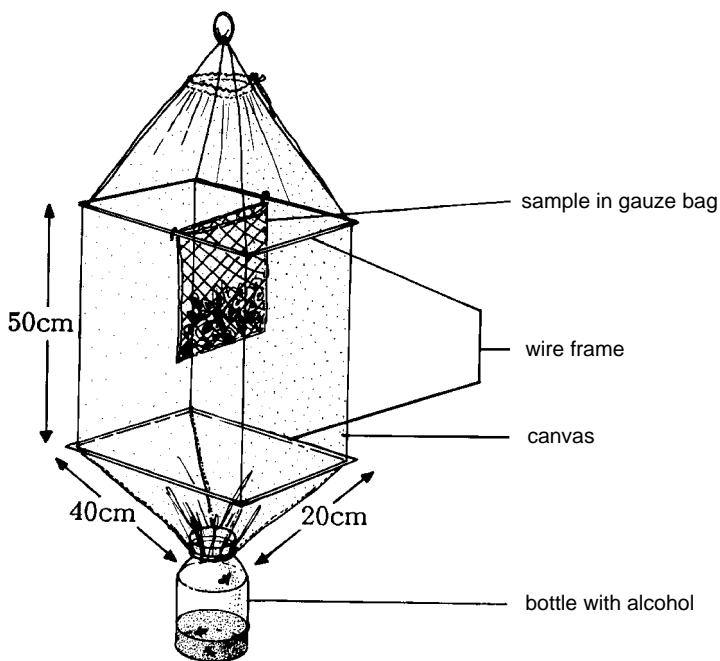


Fig. 56. Moczarsky-Winkler selector

The Moczarsky-Winkler selector is another type of extractor that works on the same principle as the Berlese funnel, but is made of canvas and allows the sample to dry out under natural conditions. It is designed for use in the field where there is no electricity (Fig. 56).

Sieves

Sieving is another way of extracting specimens from a habitat. This method is particularly suitable for collecting arthropods living in soil (e.g. antlion larvae and spiders), on plant foliage (e.g. mites, spiders and pseudoscorpions), or aquatic species in mud and streams. Arthropods that

live in leaf-litter or decomposing wood can also be collected by sieving. Any frame with a wire mesh, such as a kitchen sieve, can be used. A small net made from silk stockings or a tea strainer is ideal for collecting small specimens, such as mites, from water. The size of the mesh will depend on the size of the specimens being sought. Plant material to be sifted is placed on the wire mesh and the sieve shaken over a white surface. The specimens that drop through can then be picked up using a paint brush, aspirator or forceps.

4.8

Baits and refuges

Many species are attracted to fermenting fruit, dung or carrion. These can be used as baits or attractants to lure specimens into a trap, or to an area where they can be collected. Carrion flies and beetles can be collected at a carcass. Porcelain or plastic discs, flat strips of formica or squares of oilcloth on the ground in an infested area will quickly attract unengorged chiggers. Carbon dioxide emitted from dry ice will attract ticks and other parasitic Acari from vegetation. Ticks may also be collected by dragging a flannel cloth over infected areas, like game tracks.

Various beetles, earwigs, spiders and scorpions seek refuge under stones and old pieces of wood, and can be attracted to such shelters laid purposefully on the ground.

Many wasps and bees nest in small holes and can be attracted to holes made in blocks of wood, known as trap-nests. When the insects have made their nests, these are collected and placed in an emergence box until the progeny emerge.

Mammals such as rodents can be placed in a screen cage suspended over water to collect engorged ticks. Avian parasites can be collected from a live bird placed in a container with the head and neck protruding through a hole in the upper lid. The bottom of the container should consist of a coloured tile, or it can be equipped with a funnel leading into a vial of 70 % alcohol. If a few drops of chloroform are added to the container and the bird encouraged to flutter, the anaesthetised parasites will drop off. This procedure should be carried out by someone who is qualified to handle birds.

Dead birds and small animals should be examined under a stereo-microscope as parasites are often site-specific. The host can also be immersed in a detergent and agitated vigorously to detach the parasites, which are then collected with a camel-hair brush or eye-dropper.

Ectoparasites of invertebrates may also be collected using a fine camel-hair brush or a pin while the host is examined under a stereo-microscope. Mites on museum specimens will be dry and brittle, and can be moistened with a

droplet of alcohol and carefully removed with a pin or fine brush. If removing mites from museum material is likely to damage them, the material can first be relaxed for an hour in distilled water at 60 °C.

Marine mites may be collected from algae and coral. Infested substrate samples can be broken up and placed in a 5 litre plastic bucket filled with fresh sea water and 5 ml of chloroform or a halogenated ether compound. The sample should be agitated vigorously after 30 minutes, and removed from the bucket. The water is then filtered through a muslin bag, which is sealed, labelled and placed in 95 % alcohol for subsequent examination.

4.9

Traps

Yellow-pan traps

Yellow-pan traps are used mainly to collect aphids. They can be made from trays measuring about 40 cm in diameter and painted yellow. These are filled with water containing a little detergent to break the surface tension.

Sticky traps

Spiders, certain mites, and small flying insects such as aphids, wasps, psyllids, thrips and flies can be collected using sticky traps. These usually consist of a small yellow plate about 15 cm square, or a yellow cylinder with a diameter of about 15 cm and 20 cm long. The plate or cylinder is covered with a sticky substance, such as 'Flytac', and attached to a pole. The cylinder has the advantage of attracting specimens from all directions and is suitable for areas where the wind direction varies. The sticky substance is dissolved with a suitable solvent, like xylene or ethyl acetate, to release the trapped specimens. As sticky traps tend to damage specimens, they are mostly used for monitoring populations.

A glass Petri-dish or tile covered with firm grease and suspended in grass will collect spiders that disperse by ballooning. If placed on the ground, it will catch jumping spiders. The trap should be left for 2–3 days. The grease can be dissolved in a mixture of benzene and isopropyl alcohol to free the specimens. Fruit-tree banding gum can be used instead of grease, and is more adhesive, but the solvents recommended for banding gum (trichloroethylene, ether, hot paraffin) are unpleasant to work with and render the specimens brittle.

Paper-band traps

Spiders and insects that live in crevices in the bark of trees, and species that migrate up tree trunks after overwintering in the ground, can be caught using

paper-band traps. Strips of brown corrugated paper, about 15 cm wide, are wrapped twice around the trunk of a tree and fastened with string. The corrugations should be approximately 3 mm in diameter. The traps should be positioned at different heights on the tree, and left for several days or longer (up to a month). The tunnels of the paper provide a refuge for spiders and insects. Each band should be carefully removed, and placed in a plastic bag containing a wad of cotton wool moistened with a few drops of chloroform to anaesthetise them. The paper strip is then examined over a tray whilst pulling the layers apart.

Pitfall traps

Containers such as small plastic buckets, plant pots, glass jars or jam tins are sunk into the ground to trap flightless, ground-living insects and arachnids, especially beetles (ground beetles and toktokkies), cockroaches, crickets, spiders, solifugids, pseudoscorpions, harvestmen and mites.

The container should be placed in a hole with the upper rim flush with the ground surface (Fig. 57). A killing agent and preservative, such as ethylene glycol, should be placed in traps that are not emptied daily. Radiating vanes, such as wooden planks, placed in the substrate will increase the effective area of the trap.

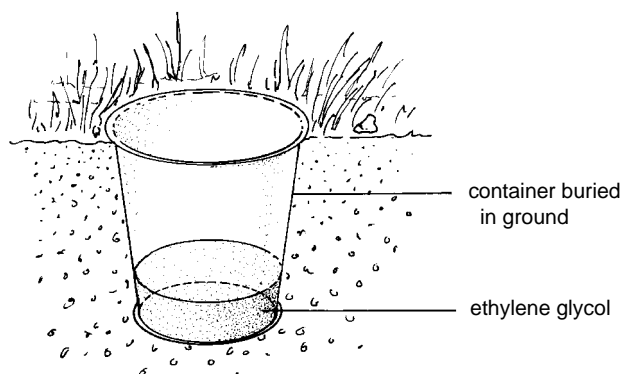


Fig. 57. Pitfall trap

A bait can be added to the trap to increase its effectiveness. The type of bait will depend on the specimens one wishes to catch. Decomposing meat or fish is ideal for attracting carrion beetles, whereas fermenting fruit is used to lure fruit beetles. The trap should be partly closed when collecting fruit beetles and other insects that can fly. The bait should be placed in a separate container, covered with gauze, inside the trap. This prevents the specimens from becoming embedded in the bait (Fig. 58).

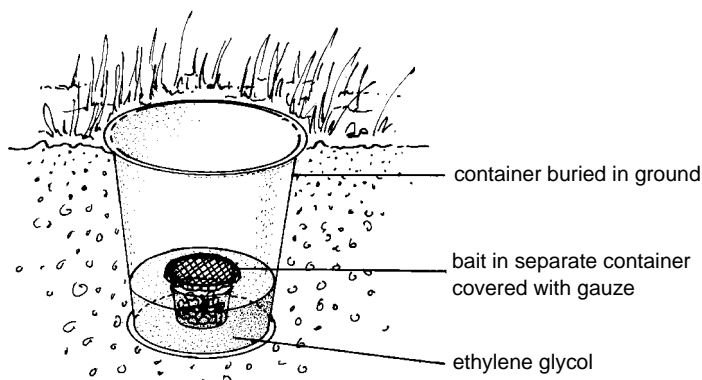


Fig. 58. Baited pitfall trap

A funnel must be placed over the opening of the trap when collecting spiders, as they are very agile and can easily escape. Traps for collecting scorpions and solifugids must have an opening large enough to capture specimens up to 75 mm in length. Pieces of vegetation added to the trap will provide some protection from predators.

Butterfly traps

These traps are specifically designed to capture fast-flying butterflies, such as nymphalids and *Charaxes*, that dwell in tree canopies and cannot otherwise be reached. These butterflies are attracted to a bait in the trap (Fig. 59). A butterfly trap is made from a vertical gauze cylinder, closed at the top, with a landing platform at the bottom. A gap is left between the bottom edge of the cylinder and the platform. The bait is placed in a small bowl positioned in the centre of the platform. The trap is hoisted over a high tree branch with a rope, and lowered to remove the catch. The butterflies alight on the platform, walk under the edge of the cylinder to feed on the bait, and then fly upwards to settle inside the trap. Butterfly traps should be monitored regularly, as they can fill quite quickly and specimens will be damaged if they flutter against each other. An effective bait consists of over-ripe banana mixed with a little rum. Sugar should not be added as this forms a thick layer over the bait, making it less attractive. Rotten meat or fish and animal dung also attract many species.

Pheromone traps

Pheromones are chemical substances emitted by insects for communication. Sexual pheromones can be used in traps to attract specimens of the opposite sex. Live females of some species, like emperor moths, that are confined in a trap will attract males over a long distance. A trap placed in a field will give an

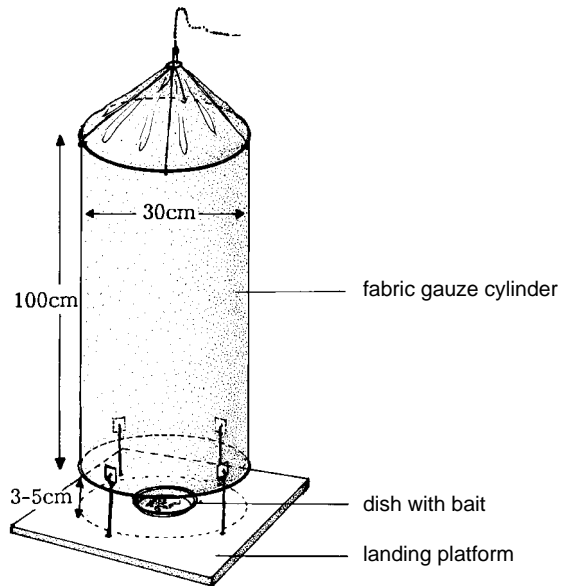


Fig. 59. Butterfly trap

indication of the presence and numbers of a pest. These traps can also be used to remove large numbers of specimens from a population, thus reducing reproductive capacity. Many of these traps are commercially available and are specifically designed to target particular pest species (Fig. 60).



Fig. 60. Pheromone trap for moths

Suction traps

Suction traps draw specimens into a receptacle or net by creating a down-draught (Fig. 61). They are used to collect ballooning spiders and small flying insects such as flies, aphids and wasps. Although mostly used in quantitative ecological studies, museum specimens can also be collected this way.

A portable vacuum cleaner can be modified to form a suction trap by simply placing a small gauze bag into the pipe to catch specimens.

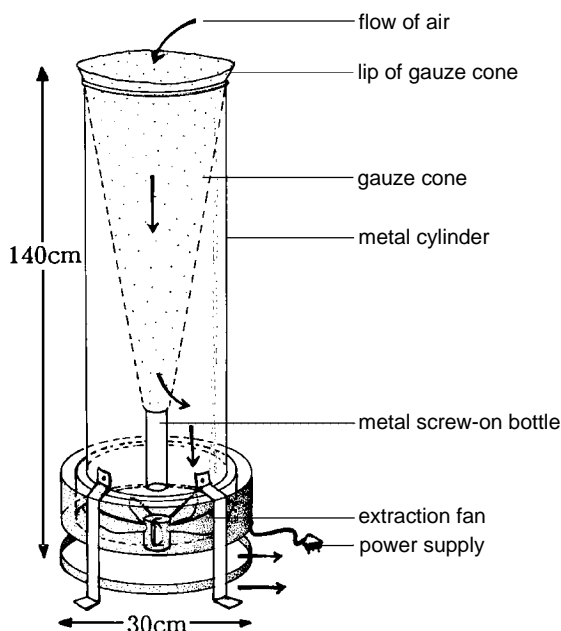


Fig. 61. Suction trap

Light traps

This is the most common method of collecting nocturnal specimens that hide or rest during the day in places where they are unlikely to be seen. Large numbers of insects and a wide variety of species can be caught at night using light traps. The simplest light trap consists of a suspended white sheet with a light hung in front of it. Specimens that settle on the sheet can be collected in killing bottles or with an aspirator. The trap in Fig. 62 shows a refinement of the light sheet trap, consisting of a white gauze cylinder. Light tubes are attached to the central pole inside the gauze cylinder. Ultraviolet lights are most effective, but specimens will be attracted to any white light. Where electricity is not available, a generator or battery can be used, otherwise gas and paraffin lamps will

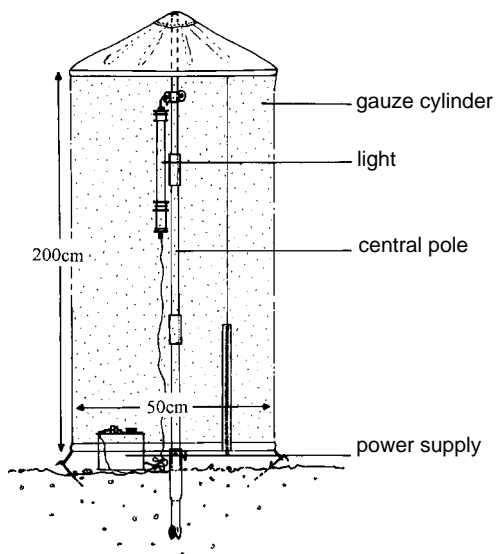


Fig. 62. Light trap (partly opened in photograph to display light bulbs inside)

suffice. This type of trap has the advantage of attracting specimens from all directions.

The best time to trap is on a dark night. Light trapping is most unproductive during the phase of full moon. Weather conditions such as wind speed and humidity will also affect the numbers of specimens coming to a trap. Warm, still, humid, dark nights are generally most productive.



Flight-interception traps

☛ Windowpane trap

This trap consists of a vertical pane of glass, plastic or gauze placed across the flight path of insects, above a trough of soapy water or ethylene glycol

(Fig. 63). Insects flying into the pane drop into the trough below. This method is particularly suitable for heavy bodied insects such as beetles.

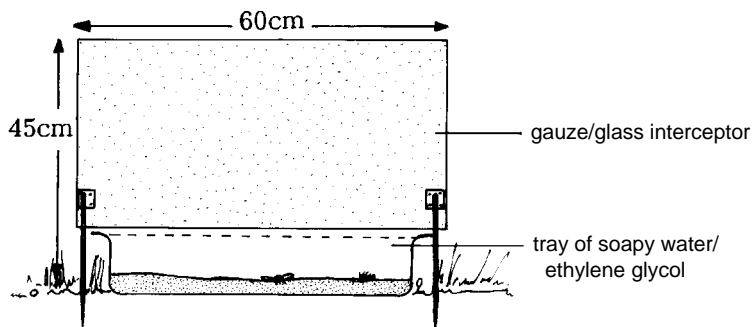


Fig. 63. Interception trap

Malaise trap

Large numbers of specimens will be taken with very little effort by using this method. Malaise traps are mainly used to catch bees, wasps and flies.

This type of trap resembles a tent with two open sides. A vertical gauze wall in the middle intercepts flying insects, which are directed upwards into a killing bottle fixed to the highest point of the trap (Fig. 64). As insects tend to fly along clearings in the vegetation, like footpaths, the trap should be erected across such a flight path, especially where it narrows. The insects that enter the trap move slowly upwards into the bottle, which usually contains alcohol to kill and preserve the insects. Hairy and waxy insects will be damaged in alcohol, so a fumigant such as dichlorophos ('Vapona') must be used in the bottle for these.

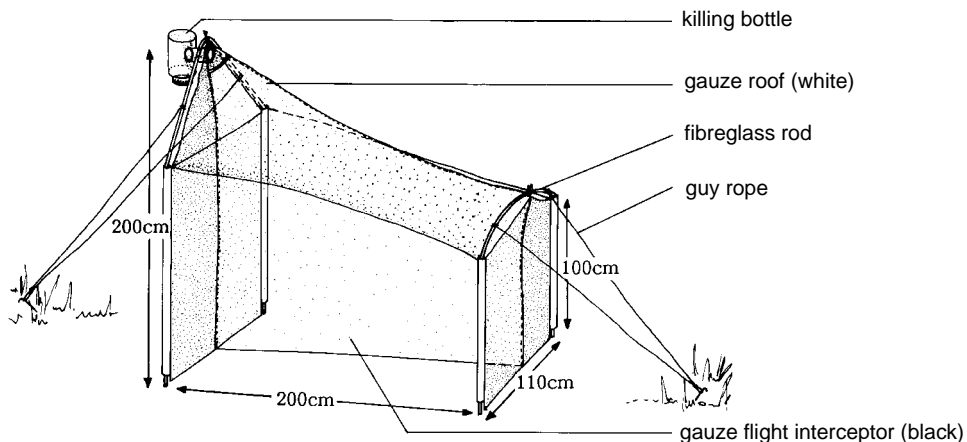


Fig. 64. Malaise trap



Fig. 64 (continued)

4.10

Rearing

Rearing produces perfect specimens and provides information on life stages and hosts. Appropriate conditions are required, such as temperature, humidity, and food. Most insects and arachnids can only be identified in the adult stage, as immatures are poorly known. Thus, if only live immature specimens are available, they can be reared to the adult stage for identification.

Rearing in cages

The larvae of ground-dwelling insects, spiders, scorpions, and beetles that burrow in soil, can be reared to the adult stage. Containers like empty aquariums are convenient for doing this. It is important to take note of the temperature, depth and moisture of the soil when collecting specimens, so that these conditions can be simulated.

Mites and insects like moths, butterflies, beetles and bugs can be reared on their host plants in a gauze cage (Fig. 65). They can also be confined in a gauze sleeve placed over the branch or stem of the plant on which they are feeding. Parasites and predators must be removed from the rearing cage. Avoid overcrowding, as this can lead to cannibalism. Cages should be cleaned regularly, and dead and unhealthy specimens removed to prevent disease. Some insects, like most caterpillars, need not be enclosed. As long as

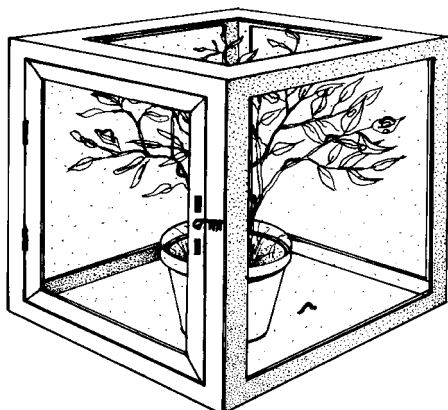


Fig. 65. Gauze rearing cage

suitable food-plant material is provided, they will not wander until they are ready to pupate. Pupation and emergence sites that simulate natural conditions should be prepared. For example, some caterpillars pupate in moist soil, whereas others spin a cocoon amongst plant debris.

Rearing in aquaria

Aquatic insects can be reared in an aquarium. The water should be aerated when rearing insects like mayflies, which live in running water. Stagnant water is suitable for various other insects, like mosquitoes. Suitable food should also be provided. The aquarium should be closed at the top with gauze to prevent emerging adults from escaping. A perch above the water should also be provided for the adults.

Rearing in emergence boxes

Parasitic wasps, gall-forming flies, moths and seed beetles can be reared in an emergence box. These insects emerge from galls, pods, insect eggs, oothecae, larvae, puparia, spiders' egg-sacs or scale insects and mealybugs. The plant material is placed in the emergence box (Fig. 66), and the vial directed towards a light source, such as a window. Most insects are attracted to light and will crawl through the funnel into the vial where they can be collected. The vial should be emptied daily to prevent specimens from being eaten by spiders or other predators that may be on the plant sample.

Large insects such as wood-boring longicorn beetles can be reared by placing infested logs in an emergence box. This container should be of metal, as wood-borers will chew through a cardboard box and escape. A square 25 litre paraffin drum, with a large bottle attached to a hole in one side, is ideal.

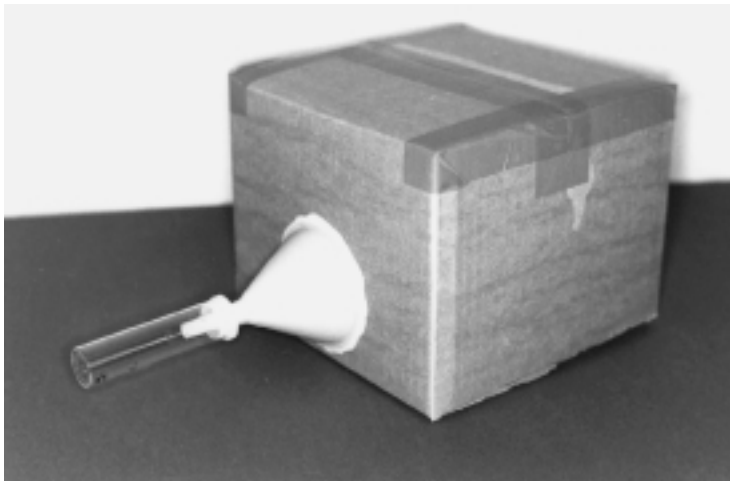
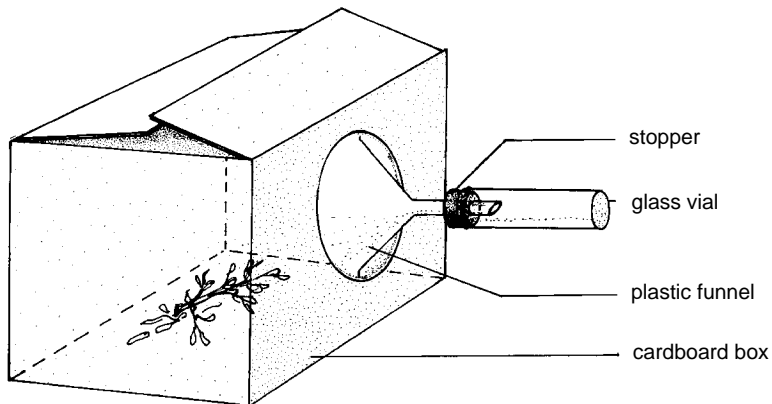


Fig. 66. Emergence box

4.11

Preferred methods of collecting insects and arachnids

Insects and arachnids are listed here according to their common names; the corresponding scientific names of the orders may be found in the index at the end of this manual. Refer also to Chapter 3 ('Higher Classification of Insects and Arachnids') to locate the common names of the orders under the scientific names.

Alderflies: larvae: aquatic net
adults: aerial net

Antlions and Lacewings: larvae: sieving
adults: aerial net, light trap, rearing

Ants: hand collecting

Aphids: yellow-pan trap, hand collecting, suction trap

Aquatic bugs: aquatic net

Bedbugs: hand collecting

Beetles (aquatic): aquatic net

Bees: malaise trap, aerial net

Beetles: most methods, especially pitfall trap, light trap, beating sheet

Booklice: hand collecting, rearing

Bristletails: Berlese (Tullgren) funnel

Bugs: sweep net, beating sheet

Butterflies: larvae: hand collecting, beating sheet

adults: aerial net, rearing

Caddisflies: larvae: aquatic net, hand collecting

adults: aerial net

Cockroaches: pitfall trap, light trap

Crickets: light trap, sweep net

Dragonflies and Damselflies: nymphs: aquatic net

adults: aerial net, rearing

Earwigs: baits and refuges, hand collecting

Fishmoths: hand collecting, Berlese (Tullgren) funnel

Fleas: baits and refuges, hand collecting

Flies: most methods, especially aerial net, sweep net, rearing, malaise trap

Grasshoppers and Locusts: light trap, sweeping

Harvestmen: hand collecting, pitfall trap

Lice: baits and refuges, hand collecting

Mayflies: nymphs: aquatic net

adults: light trap, aerial net

Mealybugs: hand collecting

Mites: hand collecting, baits and refuges, beating plate, Berlese (Tullgren) funnel,

sticky traps, pitfall traps

Moths: larvae: hand collecting, beating sheet

adults: light trap, rearing

Parasitic wasps: sweep net, suction trap, rearing

Praying mantids: light trap, hand collecting, aerial net

Pseudoscorpions: hand collecting, beating sheet, sieving, Berlese (Tullgren) funnel

Scale insects: hand collecting

Schizomida: Berlese (Tullgren) funnel, hand collecting

Scorpionflies: aerial net

Scorpions: hand collecting

Spiders: most methods, especially beating sheet, pitfall trap, paper-band trap,

hand collecting, sweep net, Berlese (Tullgren) funnel, sieving

Stick insects: sweep net, beating sheet

Stoneflies: nymphs: aquatic net

adults: sweep net, hand collecting, beating sheet, light trap

Sun-spiders: pitfall traps, hand collecting

Termites: hand collecting

Thrips: beating sheet, sweep net, Berlese (Tullgren) funnel, sticky trap

Ticks: baits and refuges, hand collecting

Wasps: aerial net, malaise trap

Whip-spiders: hand collecting

Further reading

ENDRÖDY-YOUNGA, S. 1979. Collecting Methods and Material Processing of Arthropoda in the Transvaal Museum. *Bulletin of the Transvaal Museum* 17: 20–26.

KROMBEIN, K.V. 1967. *Trap-nesting Wasps and Bees: Life Histories, Nests, and Associates*. Smithsonian Press, Washington, D.C. 570 pp.

LONDT, J.G.H. 1984. *A Beginner's Guide to the Insects*. The Wildlife Society of Southern Africa. 100 pp.

NORRIS, K.R. & UPTON, M.S. 1974. *The Collection and Preservation of Insects*. The Australian Entomological Society, Miscellaneous Publication No. 3. 33 pp.

OBERPRIELER, R.G. 1984. An Improved Light Trap for Obtaining Undamaged Insect Specimens. *Journal of the Entomological Society of Southern Africa* 47: 329–335.

OLDROYD, H. 1958. *Collecting, Preserving and Studying Insects*. Hutchinson, Scientific and Technical, London. 336 pp.

PINHEY, E.C.G. 1968. *Introduction to Insect Study in Africa*. Oxford University Press, London. 235 pp.

PRINSLOO, G.L. 1980. An Illustrated Guide to the Families of African Chalcidoidea (Insecta: Hymenoptera). *Science Bulletin, Department of Agriculture and Fisheries, Republic of South Africa* 395: 1–66.

STEYSKAL, G.C., MURPHY, W.L. & HOOVER, E.M. (Eds.) 1986. *Insects and Mites. Techniques for Collection and Preservation*. U.S. Department of Agriculture, Miscellaneous Publication No. 1443. 103 pp.

TOWNES, H. 1972. A Light-Weight Malaise Trap. *Entomological News* 83: 239–247.

UPTON, M.S. 1991. *Methods for Collecting, Preserving, and Studying Insects and Allied Forms*. The Australian Entomological Society, Miscellaneous Publication No. 3. 86 pp.

UYS, N.M. & URBAN, R.P. (eds) 1996. *How to Collect and Preserve Insects and Arachnids*. ARC – Plant Protection Research Institute Handbook No. 7, Pretoria. 66 pp.

WOODHALL, S.E. (Ed.) 1992. *A Practical Guide to Butterflies and Moths in Southern Africa*. Lepidopterists' Society of Southern Africa, Florida Hills. 223 pp.

5. **K**illing and temporary storage

Once insects and arachnids have been collected, they must be killed and stored until they are mounted and/or preserved permanently. Killing and storage methods vary according to the type of arthropod that has been collected. These procedures are explained below.

5.1

Killing methods

Use of liquid

All arachnids, soft-bodied insects (e.g. aphids and termites) and all eggs and larvae must not be allowed to dry out once they are dead. They should either be placed directly into a liquid preservative (usually 70–95 % ethyl alcohol) or, where required, into a fixative such as Pampel's fluid (see below). Large spiders and whip-spiders should first be killed with chloroform or ethyl acetate before being transferred to alcohol. Formalin (formaldehyde) should not be used for storing insects and arachnids as it makes specimens hard and difficult to examine.

Robust, non-hairy arthropods like beetles, scorpions and ticks can be killed by immersing them in near-boiling water. Scorpions should be left in the water for approximately 5 seconds, until the metasoma straightens. (They can also be placed directly into alcohol, but this may cause contortion of their bodies). Once dead they should then be stored in Kahle's fluid (see below). The chelicerae may be pulled forwards and one of the fingers opened to facilitate subsequent examination. Small delicate specimens should be placed in a glass tube before immersion in hot water. Larvae of Lepidoptera and Coleoptera should be placed live into near-boiling water to denature their body proteins and prevent decay. They should then be placed in a fixative like Pampel's fluid before being transferred to a preservative (see page 74). Each sample should be collected into a separate vial.

The following insects should NEVER be placed in liquid: those with scales on their wings (e.g. Lepidoptera), hairy insects (e.g. some Diptera and Hymenoptera), and insects covered with a waxy bloom (some Coleoptera).

Recipe for Pampel's fluid:

- ☞ 95 % ethanol (750 ml)
- ☞ distilled water (1375 ml)
- ☞ 40 % formalin (250 ml)
- ☞ glacial acetic acid (125 ml)

Recipe for Kahle's fluid:

- ☞ 6 parts formalin
- ☞ 15 parts isopropyl or n-propyl alcohol (99 %)
- ☞ 1 part glacial acetic acid
- ☞ 30 parts distilled water

Freezing

Insects and arachnids can be killed by placing them in a freezer. This method is particularly suitable for reared moths and butterflies. Care should be taken to ensure the specimens are dead before removing them from the freezer, which may take up to 48 hours.

Pinching

Larger butterflies can be stunned or killed by pinching the thorax between the thumb and fore-finger (Fig. 67).

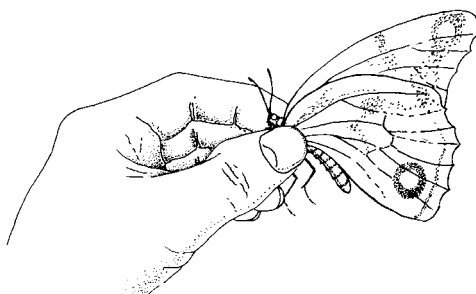


Fig. 67. 'Pinching' to kill or stun butterflies

Killing bottles

Most insects and small arachnids can be killed in a killing bottle. The bottle should be wide-mouthed and made of glass, polypropylene or polyethylene

(ethyl acetate dissolves many other plastics). Absorbent paper should be placed inside the bottle to soak up condensation, regurgitated or defaecated liquid and to prevent insects from damaging each other.

Many species, such as large beetles, can take several hours to die after becoming immobile in the killing bottle, and should not be removed too soon. Note that delicate specimens can be damaged if left too long in the killing bottle.

Delicate specimens, and all butterflies and moths, should be killed in separate bottles from other insects, otherwise they may be damaged by more robust specimens such as large beetles. Other types of insects will also be covered in scales if placed in the same killing bottle as Lepidoptera.

The poisons used in killing bottles are hazardous and should be handled with great care. Bottles should be held away from the face when opening them, and care must be taken to avoid inhaling their fumes. They should be kept away from foodstuffs and preferably cleaned outdoors. All killing bottles should be labelled POISON and kept out of reach of children.

Cyanide killing bottles that are no longer effective should be disposed of by burying them.

Ethyl acetate bottles

Preparation procedure:

1. Make a paste of plaster of Paris and water, and place a thick layer on the bottom of a bottle. A pad of cotton wool can also be used in place of plaster of Paris, but it should be covered with a tight-fitting piece of cardboard to prevent specimens from becoming entangled in the cotton fibres.
2. Allow the plaster of Paris to dry in a well-ventilated place.
3. Saturate the plaster of paris with ethyl acetate. Any excess liquid should be poured off.
4. Place crumpled absorbent paper on top of the plaster of Paris.
- 5 Let the bottle dry out before recharging it with ethyl acetate.

Ethyl acetate bottles (Fig. 68) are easy to prepare and are less toxic to humans than potassium cyanide bottles. Green insects should be removed from the bottle as soon as they are dead, as ethyl acetate discolours them.

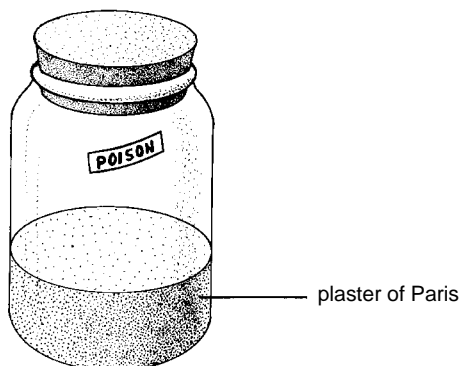


Fig. 68. Ethyl acetate killing bottle

Ammonia, benzene, chloroform, carbon tetrachloride and trichloroethylene can also be used, but most of these are hazardous to the collector's health.

☛ Potassium cyanide bottles

Preparation procedure:

1. Place crushed potassium cyanide crystals mixed with sawdust or cotton wool to a depth of 15 mm in a suitable bottle.
2. Cover the crystals with a fairly thick layer of plaster of Paris mixed into a paste. A removable porous stopper, made from foam plastic can also be used, which allows for periodic recharging with cyanide.
3. Allow the plaster of Paris to dry in a well-ventilated place.
4. Add crumpled absorbent paper to the bottle and close the bottle.
5. Add a few drops of water to the plaster of Paris (or foam stopper) to activate the bottle an hour or so before use. The water will react with the crystals to produce hydrogen cyanide gas.

Cyanide bottles (Fig. 69) are effective for killing most insects except certain Coleoptera. Besides being very toxic to humans, cyanide has a tendency to cause brittleness in specimens and discolouration of yellow-coloured bees and wasps. If a killing bottle is used only occasionally, cyanide is not recommended.

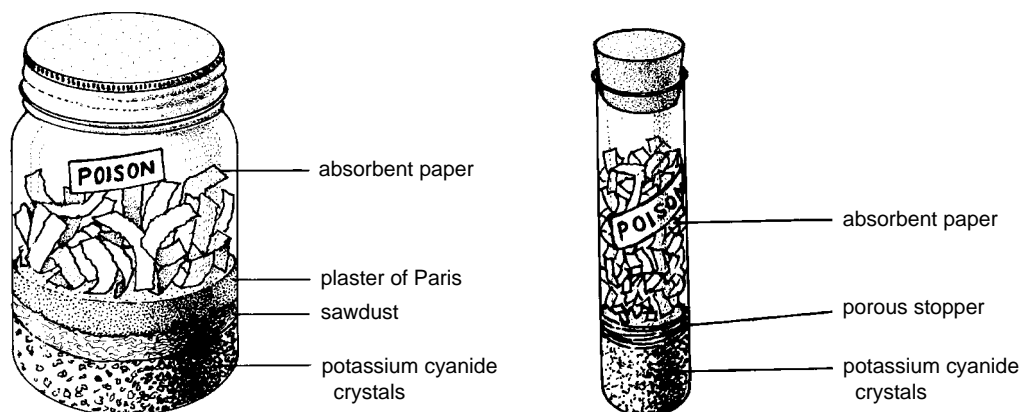


Fig. 69. Cyanide killing bottles

5.2

Temporary storage

Dry specimens

Butterflies and other large-winged insects can be stored in folded protective paper envelopes (preferably waxpaper), as illustrated in Fig. 70. Most arthropod specimens can be conveniently stored between layers of absorbent paper. Any sturdy container can be used to store insects or arachnids. Small cardboard or wooden boxes are especially useful, as they permit the specimens to dry out. It is very important to realise that freshly-killed specimens will develop mould if sealed in non-porous containers, such as plastic or glass vials with tight stoppers. Allow the material to dry out thoroughly first, before closing the container. A fungicide such as phenol, chlorocresol, ethyl acetate or 'Dettol', should be added to the container if the material is not yet completely dry. Care should be taken to ensure that the fungicide does not damage the specimens; ethyl acetate can damage hairy insects and those with a waxy bloom. If the container is not sealed, an insect repellent such as naphthalene should be added to prevent attack by pests such as ants and museum beetles.

Note: if available, a fridge or deep freeze is ideal for the temporary storage of material. Not only is the risk of mould and infestation by pests eliminated, but the specimens will remain relaxed for some time.

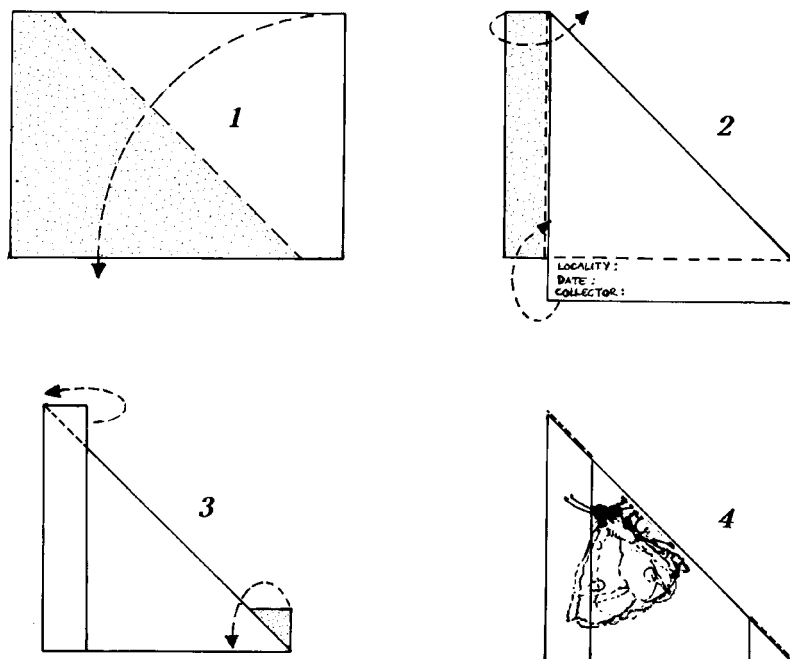


Fig. 70. Folding sequence for paper triangles

Specimens in liquid

Specimens that are to be preserved in liquid are usually killed by placing them directly into a vial of preservative or fixative. Material that has first been placed in a fixative medium should be transferred to a preservative fluid for temporary storage. Vials of samples can be stored in specially made racks or boxes.

5.3

Recording field data

All relevant data must be recorded at the time of collecting. It is essential to note the locality, date, collector's name, and other information, such as host plant. This is best done by writing the information on a small piece of paper,

using a pencil or pen with indelible drawing ink, and placing the label inside the container with the insect or arachnid sample. A numbering system can also be used to record collecting data, where the samples are numbered with small labels, and the associated collecting information recorded against the numbers in a field book.

Further reading

- BORROR, D.J., DE LONG, D.M. & TRIPLEHORN, C.A. 1981. *Introduction to the Study of Insects*. Saunders College Publishing, Philadelphia. 827 pp.
- LONDT, J.G.H. 1984. *A Beginner's Guide to the Insects*. The Wildlife Society of Southern Africa. 100 pp.
- NEWLANDS, G. 1969. Scorpion Preparation for Scientific Study and Display. *Journal of the Entomological Society of Southern Africa* 32: 491–493.
- NORRIS, K.R. & UPTON, M.S. 1974. *The Collection and Preservation of Insects*. The Australian Entomological Society, Miscellaneous Publication No. 3. 33 pp.
- OLDROYD, H. 1958. *Collecting, Preserving and Studying Insects*. Hutchinson, Scientific and Technical, London. 336 pp.
- POLIS, G.A. (Ed.) 1990. *The Biology of Scorpions*. Stanford University Press, Stanford, California. 587 pp.
- PINHEY, E.C.G. 1968. *Introduction to Insect Study in Africa*. Oxford University Press, London. 235 pp.
- STEYSKAL, G.C., MURPHY, W.L. & HOOVER, E.M. (Eds.) 1986. *Insects and Mites. Techniques for Collection and Preservation*. U.S. Department of Agriculture, Miscellaneous Publication No. 1443. 103 pp.
- UPTON, M.S. 1991. *Methods for Collecting, Preserving, and Studying Insects and Allied Forms*. The Australian Entomological Society, Miscellaneous Publication No. 3. 86 pp.
- UYS, N.M. & URBAN, R.P. (eds) 1996. *How to Collect and Preserve Insects and Arachnids*. ARC – Plant Protection Research Institute Handbook No. 7, Pretoria. 73 pp.
- WOODHALL, S.E. (Ed.) 1992. *A Practical Guide to Butterflies and Moths in Southern Africa*. Lepidopterists' Society of Southern Africa, Florida Hills. 223 pp.

6. **P**reservation

Insects can be permanently preserved either dry, in fluid, or on microscope slides. Arachnids are always preserved in liquid or on microscope slides. The method of preservation depends on the type of arthropod (see the list on page 77).

6.1

Dry preservation

Insects that are to be preserved dry are best mounted in ways that facilitate study and permanent storage. Specimens should be mounted soon after killing, if possible while still soft. Unmounted material that has been temporarily stored dry can be relaxed, to make it flexible enough for pinning.

Relaxing methods

☛ Relaxing dishes

A flat plastic container with an airtight lid makes an ideal relaxing dish. The base is lined with moist cotton wool covered with blotting paper. Glass desiccators, with water in the base, are also suitable. A thymol or phenol crystal must be added to the water in the relaxing container to prevent fungal growth (Fig. 71). A few drops of 'Dettol' or 'Milton' can also be used as a fungicide. The dry insects are placed inside the relaxing dish in open containers, such as Petri dishes or saucers, and the dish is sealed and left for at least a day. Large insects usually take longer to soften than small ones.

☛ Other relaxing techniques

- ☞ Robust insects (e.g. most beetles) will be relaxed quickly by dropping them into near-boiling water. Small specimens soften in a few seconds, whereas large ones require a minute or more.
- ☞ Large moths and butterflies can be relaxed by injecting a 10 % solution of ammonia or hot water into the thorax.
- ☞ Barber's relaxing fluid (see below) is used to relax insects such as beetles, grasshoppers, crickets, bugs, flies and some wasps. Soaking in this liquid for half an hour relaxes dry specimens sufficiently for setting or pinning. Individual limbs or joints can also be relaxed by applying a drop of this liquid.

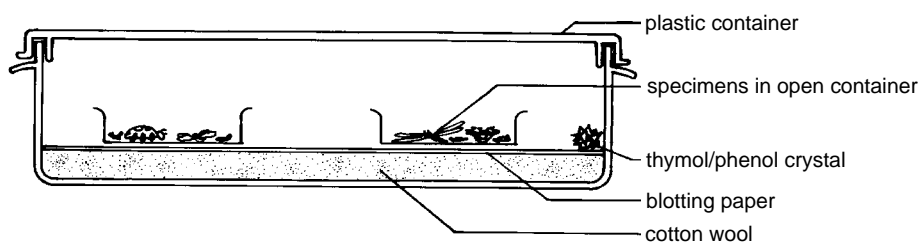


Fig. 71. Relaxing dish

Recipe for Barber's fluid:

- ☞ 95 % ethanol (1000 ml)
- ☞ distilled water (1000 ml)
- ☞ ethyl acetate (375 ml)
- ☞ benzene (125 ml)

Cleaning

Some specimens may require cleaning. Once the specimens have been relaxed, they should be gently washed in alcohol or soapy water, using a fine paint brush to dislodge adhering particles. Greasy specimens require a solvent such as ethyl acetate, benzene, ether or alcohol. Mouldy specimens can be cleaned in chloroform or ethyl acetate.

Mounting large insects

Insects longer than about 8 mm are usually mounted on pins pushed through the thorax. Insect pins are longer than ordinary pins, and are made of stainless steel that does not rust. A No. 2 or No. 3 entomological pin is suitable for most insects, although those with delicate bodies may require a size No. 0 or No. 1.

Once mounted, insects should be left to dry in a ventilated drying cabinet or cupboard for about a week. Insects left to dry in the open may be eaten by ants or cockroaches, so take care to protect them.

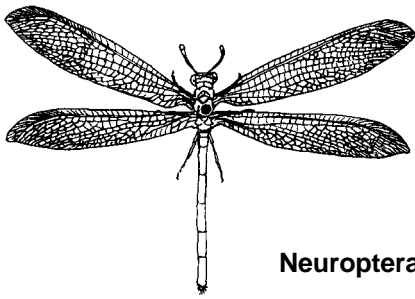
Pinning

1. Prepare a mounting board made of polystyrene covered with paper or expanded polyethylene ('EPX'), at least 30 mm thick.
2. Push the pin vertically through the thorax, avoiding the legs as the point of the pin emerges on the underside of the body (Fig. 72). The pin should be inserted slightly to the right of the centre of the mesothorax. Figure 73 indicates the conventional position of the pin for eight different orders.

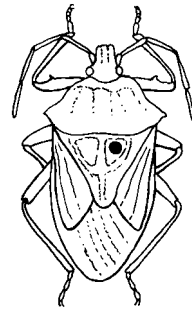


Fig. 72. Orientation of an insect on a pin

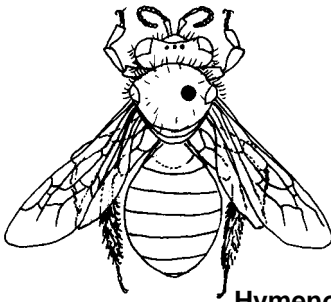
3. Using a pinning block (constructed from hard wood with vertical holes drilled to different depths (Fig. 74)), adjust the specimen on the pin at a height which leaves the top 8–10 mm of the pin projecting above the insect, to facilitate handling.
4. Push the pin with the insect into the mounting board until the underside of the body rests on the board. Arrange the legs and antennae close to the



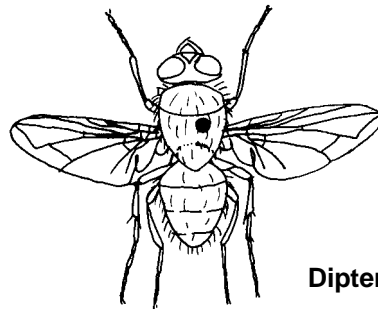
Neuroptera



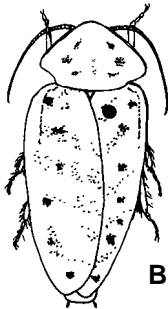
Hemiptera



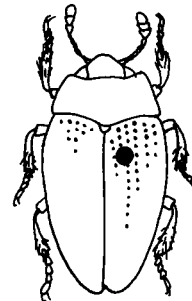
Hymenoptera



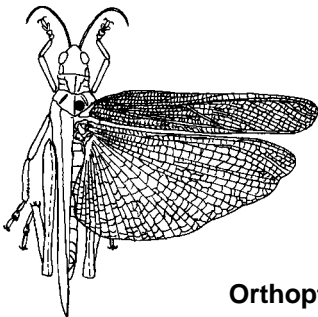
Diptera



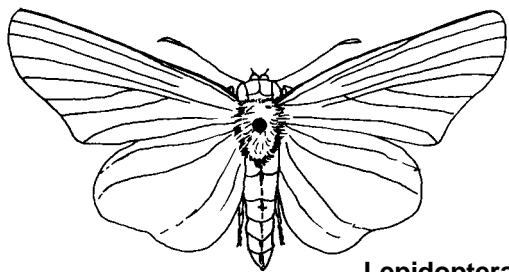
Blattodea



Coleoptera



Orthoptera



Lepidoptera

Fig. 73. Conventional position of pin for 8 orders

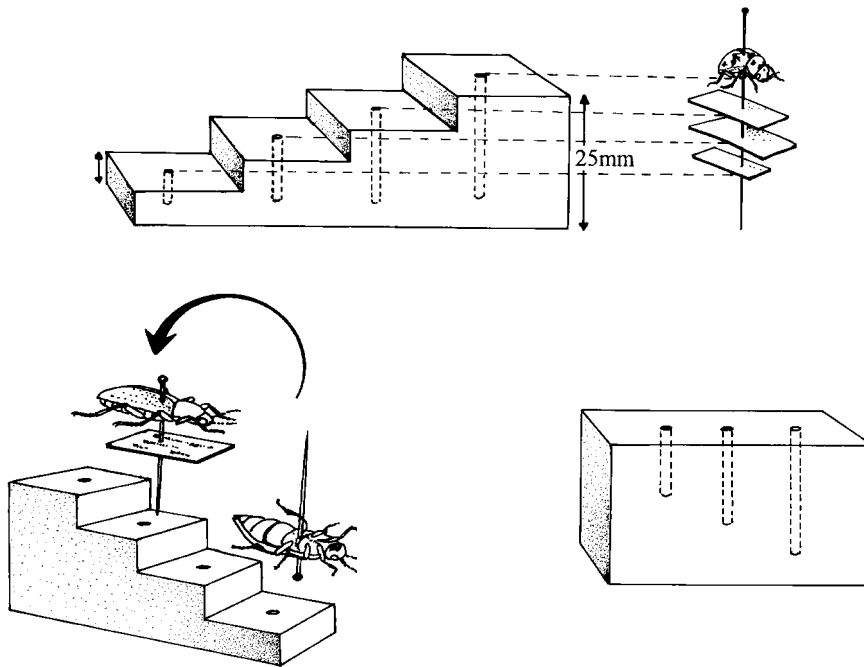


Fig. 74. Pinning blocks

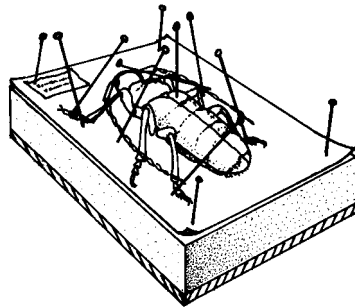


Fig. 75. Insect braced on mounting board

body (to reduce the likelihood of damage) and secure them in their positions with bracing pins (Fig. 75). Most insects are pinned with their wings folded (Fig. 73: e.g. bugs, cockroaches, bees, wasps and beetles).

5. Secure a data label next to the insect.
6. Remove the bracing pins when the specimen is dry.

Setting

The wings of certain insects must be spread, because the wing venation or wing pattern is important for identification. These insects require special setting boards. Moths, butterflies, lacewings, antlions and dragonflies are conventionally set with both pairs of wings spread, whereas grasshoppers (Fig. 73), cockroaches, mantids, stick insects and occasionally bees, are set with only one pair of wings extended.

1. Make a simple setting board by glueing a sheet of thick polystyrene to the smooth side of a masonite board. Cut a groove down the middle, as wide and deep as the body of the insect to be set (Fig. 76a). Cover the upper surface of the polystyrene with ruled paper to facilitate alignment of the wings. The wings of moths and butterflies tend to sag, even after the insect has dried completely, so angled setting boards are used for Lepidoptera (Fig. 76b). Setting boards can also be purchased from commercial entomological dealers.

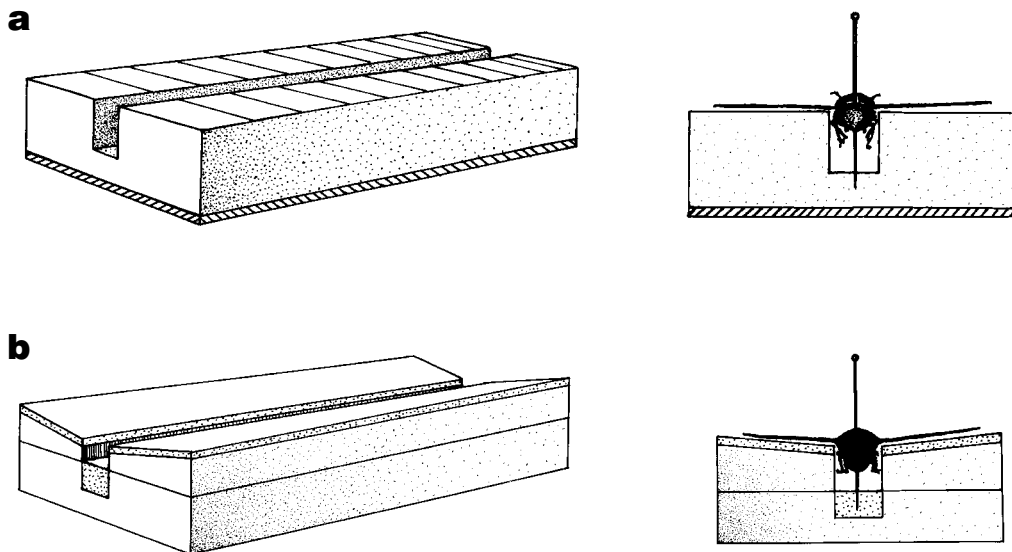


Fig. 76. (a) Standard setting board; (b) angled setting board

2. Pin the insect through the thorax, and insert the pin into the middle of the groove in the setting board so that the wings are level with the board. Brace the body if necessary by placing a pin on either side of the base of

the abdomen. Lepidoptera are mounted with their legs folded under the body, whereas in other groups (e.g. lacewings, antlions, dragonflies and damselflies) the legs are displayed next to the wings.

3. Carefully arrange the wings by moving them with a fine pair of forceps or insect pins hooked behind the veins. Hold the wings in position with strips of plastic, paper or cellophane and secure these with pins inserted alongside the outer wing margins (see Fig. 77). The wings of moths and butterflies are set with the rear margin of the forewing at right angles to the body (Figs 73 & 77). In grasshoppers, dragonflies, lacewings and most other insects, the front margins of the hind wings should be at right angles to the body, with the forewings set forward and clear of the hind wings (Fig. 73).
4. Support the insect's abdomen with a wad of cotton wool or pairs of crossed pins to prevent it from sagging.
5. Secure a data label next to the specimen.
6. Remove the bracing pins when the specimen is dry.

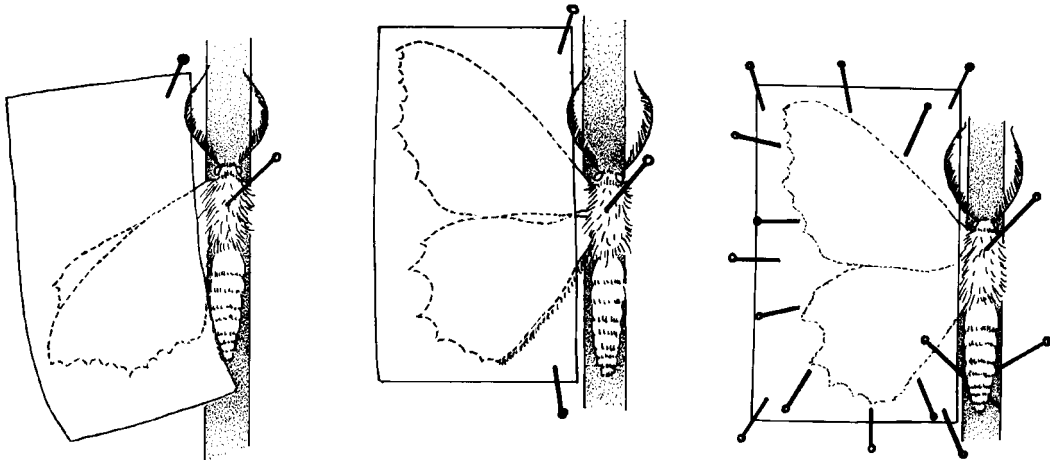


Fig. 77. Method for setting wings of butterflies and moths

Mounting small insects

Insects that are too small for mounting directly on standard pins are double-mounted on card points, card platforms, minuten pins or in gelatine capsules. They can also be glued to a pin.

☛ Card points

Small bugs, wasps and flies are mounted on card points about 12 mm long and 3 mm wide. These can be purchased or made by cutting up good quality drawing card. Points can also be made with a commercial punch designed for this purpose. Each card point is set at a consistent height on a pin, using a pinning block (Fig. 74).

This mounting technique is explained below, using a leafhopper as an example.

1. Under a dissection microscope, position the insect, ventral side up, on the edge of a small block.
2. Carefully spread the legs, using forceps or fine needles, so that the mouthparts and genitalia are not obscured.
3. Place a small drop of glue on the tip of a card point mounted on an insect pin. Use only enough glue to attach the insect to the point. Clear-drying, non water-soluble project or wood glue is most suitable. For slightly larger insects, bend the point of the card downwards before applying the glue, to make a bigger adhesive area.
4. Press the drop of glue on the card point tip against the right side of the insect's thorax (Fig. 78).

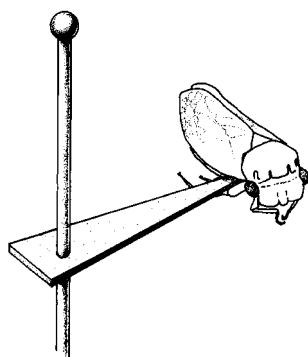


Fig. 78. Leafhopper glued to a card point

☛ Card platforms

Small insects, particularly certain beetles and parasitic wasps (but not bugs or moths) are suitable for mounting on card platforms measuring 5 × 10 mm. These may be purchased from a supplier or cut to size from good quality drawing card or Bristol board. A standard insect pin is pushed through one end of the platform (Fig. 79).

This mounting method is explained below, using a beetle as an example.

1. Under a dissecting microscope, pin the card platform to the surface of a block of polystyrene or 'EPX' (Fig. 79).
2. Place the insect upside down in front of the card and spread the legs and antennae.
3. Turn the specimen over with forceps or a fine, damp paintbrush, and place it on a small drop of water-soluble glue on the card platform, with its head facing away from the pin.
4. When the glue starts to dry, arrange the legs and antennae neatly around the body.
5. Position the platform with the mounted specimen on the pin using a pinning block.

Small beetles which are difficult to mount, or are likely to be damaged easily, can be glued on their right sides to card platforms. Minute wasps are glued on their right sides with the lower set of wings spread out on the card platform.

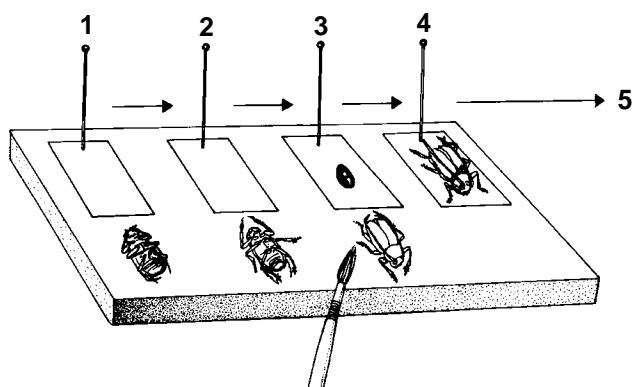


Fig. 79. Technique for mounting a small insect (beetle) on a card platform

☛ Minuten pins

These are used for very small moths and other small insects, such as flies and bugs (e.g. jumping plant lice (Psyllidae)). Stainless steel minuten pins are small,

10–15 mm long, without heads.

1. Under a dissecting microscope, pin the specimen through the thorax, onto a mounting board or block of 'EPX'.
2. Arrange the legs and antennae with fine forceps and brace them with minuten pins. Secure the body of small moths by bracing the abdomen on either side with minuten pins (Fig. 80).
3. Position and brace the wings and antennae with minuten pins.
4. Remove the bracing pins when the specimen is dry.
5. Push a large insect pin (size No. 3) through the end of a strip of cork or *Polyporus*, measuring $3 \times 10\text{--}15$ mm. Moulded sheets of commercially available silicone rubber, cut into small blocks (3×3 mm), can also be used for very small insects.
6. Using fine forceps, remove the minuten pin with the specimen from the mounting board and push it into the other end of the strip (Fig. 81).

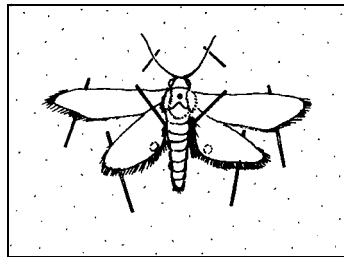


Fig. 80. Microlepidopteran set with minuten pins

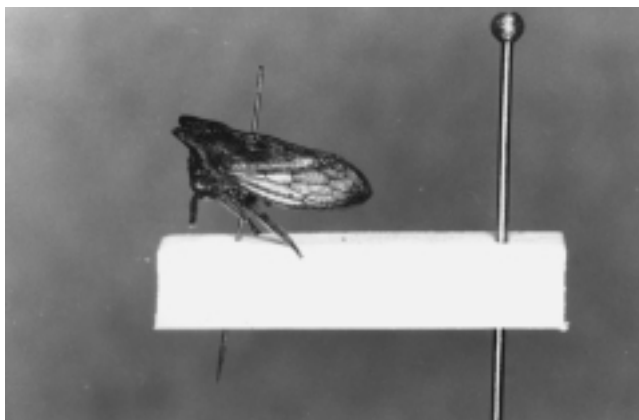


Fig. 81. Insect on minuten pin mounted on *Polyporus*

Very delicate specimens can be mounted on minuten pins set horizontally into a short strip of *Polyporus*, inside a gelatine capsule (Fig. 82).

☛ Glueing to pins

Small bees and wasps can be glued to a standard insect pin. The right side of the thorax is attached to the pin with waterproof glue or nail varnish (Fig. 83).

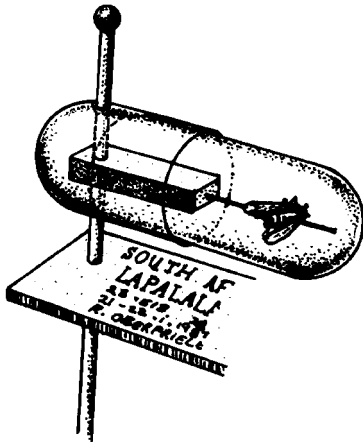


Fig. 82. Insect on a minuten pin mounted on *Polyporus* inside a gelatine capsule

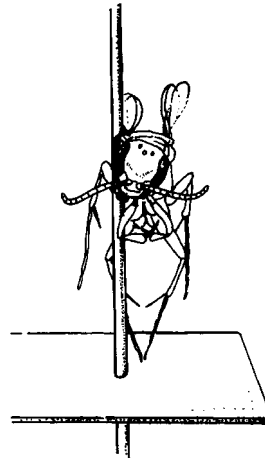


Fig. 83. Wasp glued to an insect pin

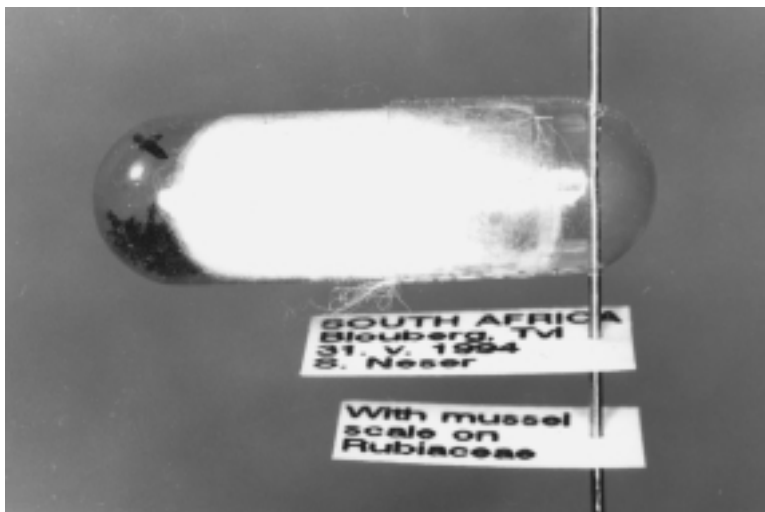


Fig. 84. Small insects in a gelatine capsule on a standard insect pin

☛ Gelatine capsules

Small insects, like parasitic wasps, may be stored in gelatine capsules held on a standard insect pin. A small wad of cotton wool is placed inside the capsule to prevent the specimens being shaken about (Fig. 84). Smoothing and compacting the cotton-wool plug before inserting it helps to prevent the insects becoming entangled in the fibres.

6.2

Wet preservation

Most arachnids and soft-bodied insects become very distorted when they dry out, as do eggs and immature stages. They have to be stored permanently in a suitable liquid. Ethanol (70–95 %) is generally used, with the following few exceptions:

- ☛ **Scorpions** – Kahle's fluid (see page 57)
- ☛ **Soft scale insects and mealybugs** – mixture of 4 parts 90 % ethanol and 1 part glacial acetic acid.
- ☛ **Thrips** – a mixture of 9 parts 60 % ethanol and 1 part glacial acetic acid.

When preserving larvae, particularly those of moths, butterflies and beetles, specimens should be killed in near-boiling water and put into a fixative for about a week. Pampel's fluid (see page 57) is generally used for larvae. The specimens are then transferred to glycerine or 70 % ethanol for about two weeks to replace the fixative. Finally, they should be stored permanently in pure glycerine (small larvae), which does not evaporate, or in ethanol (small or large larvae).

Scorpions are also killed by immersion in near-boiling water. They should be stored in Kahle's fluid (see page 57). The chelicerae may be pulled forwards and the pincers opened to facilitate examination of the specimens.

Specimens stored in liquid are usually placed in small glass vials, plugged with cotton wool, which secures them and minimises damage. The vials are then placed in a larger container (like a wide-mouthed honey jar), filled with the same liquid (Fig. 85a). Commercially available, self-shrinking cellulose bands can be used to seal the lid of the large container to reduce evaporation (Fig. 85b). **It is very important to periodically check and top up containers of a liquid collection.**

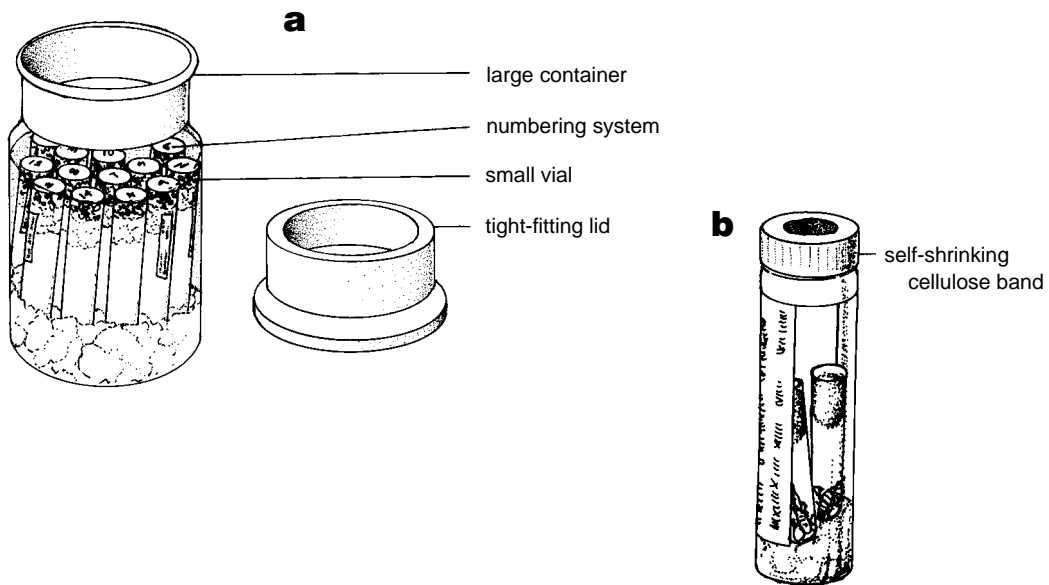


Fig. 85. (a) insects stored in liquid in glass vials (b) container sealed with cellulose band

6.3

Slide mounting

Small specimens have to be mounted on microscope slides so that they can be studied under a compound microscope. These include groups such as thrips, aphids, parasitic wasps, scale insects, booklice, lice and mites. Insect and spider body parts (e.g. mouthparts and genitalia), and larvae often have to be slide-mounted. Microscope slide mounts may be temporary or permanent, but specimens maintained in collections require permanent mounts.

Each particular arthropod group requires a specialised preparation and mounting technique, so it is advisable to consult a specialist or the relevant literature before attempting to make slides. The section below outlines the basic procedures involved in slide preparation of insects.

Clearing and cleaning

The soft internal tissues are destroyed, leaving the hard chitinous parts and membranous cuticle of the specimen intact. This may be achieved by dissection or maceration. A 10 % potassium hydroxide solution is the most commonly-used macerating fluid, but sodium hydroxide, lactic acid,

chloralphenol, glycerolactic and lactophenol are used in certain cases. Specimens are placed in the fluid, which renders them translucent.

Rinsing

Material should be thoroughly rinsed to neutralise the action of these fluids. Water or ethanol, containing a few drops of acetic acid (white vinegar), is effective.

Staining or bleaching

Where required, pale or transparent material is stained in acid fuchsin. Very dark material can be bleached in peroxide.

Dehydration

Dehydration in acetic acid or ethanol must be done if the mountant to be used is not water-soluble. Delicate specimens (e.g. parasitic wasps) are dehydrated in a series of increasing ethanol concentrations (30 %, 50 %, 90 % and 96 %; 10–15 minutes in each; see below for recipe) to prevent distortion.

Clearing

Material is cleared in clove oil or xylene if the mountant to be used is not water-soluble. Other clearing fluids, such as chloralphenol, are used for specimens to be mounted in water-based media.

Mounting

The prepared material is transferred to a drop of mountant on a glass slide and covered with a circular cover-slip carefully lowered onto the mount. Canada balsam, Euparal, Berlese's fluid, Hoyer's medium, or polyvinyl alcohol are commonly-used mounting media. Lactic acid can be used for temporary mounts. If a water-based mounting medium is used, the coverslip must be sealed with a ring of colourless nail varnish or Canada balsam, when the medium is dry, to prevent excessive dehydration and discoloration.

Prepared material, such as insect genitalia, can be stored in a drop of glycerine in a glass or plastic microvial on the same pin as a specimen. Such material can be removed at any time and mounted temporarily on a slide in glycerine for examination.

Examples of slide preservation methods can be found in Williams and Watson (1988a, 1988b) [armoured scale insects and mealybugs]; Blackman and Eastop (1984) [aphids]; Mound and Pitkin (1972) and Palmer (1990) [thrips]; Prinsloo (1980) [parasitic wasps]; Harney (1993) [larvae and genitalia of beetles

and genitalia of moths] and Krantz (1978) [mites].

Recipes for different alcohol strengths:

Ethyl alcohol is usually approximately 96 % pure, when purchased. Lower percentages can be made up by diluting the alcohol as follows:

Percentage required	Percentage 96 % alcohol	Percentage distilled water
90	93.5	6.5
80	83.3	16.7
70	72.9	27.1
60	62.5	37.5
50	52.1	47.9
30	31.2	68.8

6.4

Preferred methods of preserving insects and arachnids

Insects and arachnids are listed here according to their common names; the corresponding scientific names of the orders may be found in the index at the end of this manual. Refer also to Chapter 3 ('Higher Classification of Insects and Arachnids') to locate the common names of the orders under the scientific names.

Alderflies: set, both wings spread

Antlions and Lacewings: set, both wings spread

Ants: preserved wet; card platforms

Aphids: preserved wet; microscope slides

Armoured scale insects: preserved dry (or wet); microscope slides

Bees: larger than 8 mm: pinned
smaller than 8 mm: glued to pin

Bedbugs: preserved wet; microscope slides

Beetles: larger than 8 mm: pinned
smaller than 8 mm: card platforms

Booklice: preserved wet; microscope slides

Bristletails: preserved wet; microscope slides

Bugs: larger than 8 mm: pinned
smaller than 8 mm: card points

Butterflies: set, both wings spread

- Caddisflies:** pinned
- Cockroaches:** pinned
- Crickets:** pinned
- Dragonflies and Damselflies:** set, both wings spread
- Earwigs:** pinned; card platforms
- Eggs:** preserved wet
- Fishmoths:** preserved wet
- Fleas:** preserved wet; microscope slides
- Flies:** larger than 8 mm: pinned
smaller than 8 mm: minuten pins
- Grasshoppers and Locusts:** pinned, one wing spread
- Harvestmen:** preserved wet
- Larvae:** preserved wet
- Lice:** preserved wet; microscope slides
- Mayflies:** preserved wet
- Mealybugs:** preserved wet; microscope slides
- Mites:** microscope slides; preserved wet
- Moths:** larger than 8 mm: set, both wings spread
smaller than 8 mm: minuten pins
- Nymphs:** preserved wet
- Parasitic wasps:** card platforms; card points; microscope slides
- Praying mantids:** pinned
- Pseudoscorpions:** preserved wet
- Schizomida:** preserved wet
- Scorpionflies:** set, both wings spread
- Scorpions:** preserved wet
- Soft scale insects:** preserved wet; microscope slides
- Spiders:** preserved wet
- Stick insects:** pinned
- Stoneflies:** preserved wet
- Sun-spiders:** preserved wet
- Termites:** preserved wet
- Thrips:** preserved wet; microscope slides
- Ticks:** preserved wet
- Wasps:** larger than 8 mm: pinned
smaller than 8 mm: glued to pin
- Whip-spiders:** preserved wet

Further reading

- BLACKMAN, R.L. & EASTOP, V.F. 1984. *Aphids on the World's Crops: An Identification and Information Guide*. John Wiley & Sons, Chichester. 466 pp.
- BORROR, D.J., DE LONG, D.M. & TRIPLEHORN, C.A. 1981. *Introduction to the Study of Insects*. Saunders College Publishing, Philadelphia. 827 pp.

- ENDRÖDY-YOUNGA, S. 1979. Collecting Methods and Material Processing of Arthropoda in the Transvaal Museum. *Bulletin of the Transvaal Museum* 17: 20–26.
- HARNEY, M. 1993. *A Guide to the Insects of Stored Grain in South Africa*. ARC – Plant Protection Research Institute Handbook No. 1, Pretoria. 129 pp.
- HOLM, E. & DE MEILLON, E. 1986. *Insects*. Struik Pocket Guides for Southern Africa. Cape Town. 64 pp.
- KRANTZ, G.W. 1978. *A Manual of Acarology*. Second Edition. Oregon State University Book Stores, Corvallis. 509 pp.
- LANDRY, J.-F. & LANDRY, B. 1994. A Technique for Setting and Mounting Microlepidoptera. *Journal of the Lepidopterists' Society* 48(3): 205–227.
- LONDT, J.G.H. 1984. *A Beginner's Guide to the Insects*. The Wildlife Society of Southern Africa. 100 pp.
- MOUND, L.A. & PITKIN, B.R. 1972. Microscopic Whole Mounts of Thrips. *Entomologist's Gazette* 23: 121–125.
- NORRIS, K.R. & UPTON, M.S. 1974. *The Collection and Preservation of Insects*. The Australian Entomological Society. Miscellaneous Publication No. 3. 33 pp.
- OLDROYD, H. 1958. *Collecting, Preserving and Studying Insects*. Hutchinson, Scientific and Technical, London. 336 pp.
- PALMER, J.M. 1990. Identification of the Common Thrips of Tropical Africa (Thysanoptera: Insecta). *Tropical Pest Management* 36(1): 27–49.
- PINHEY, E.C.G. 1968. *Introduction to Insect Study in Africa*. Oxford University Press, London. 235 pp.
- PRINSLOO, G.L. 1980. An Illustrated Guide to the Families of African Chalcidoidea (Insecta: Hymenoptera). *Science Bulletin, Department of Agriculture and Fisheries, Republic of South Africa* 395: 1–66.
- SKAIFE, S.H. 1979. *African Insect Life*. C. Struik Publishers, Cape Town, Johannesburg. 279 pp.
- STEYSKAL, G.C., MURPHY, W.L. & HOOVER, E.M. (Eds.) 1986. *Insects and Mites. Techniques for Collection and Preservation*. U.S. Department of Agriculture, Miscellaneous Publication No. 1443. 103 pp.
- UPTON, M.S. 1991. *Methods for Collecting, Preserving, and Studying Insects and Allied Forms*. The Australian Entomological Society, Miscellaneous Publication No. 3. 86 pp.
- UPTON, M.S. 1993. Aqueous Gum-Chloral Slide Mounting Media: An Historic Review. *Bulletin of Entomological Research* 83: 267–274.
- WILLIAMS, D.J. & WATSON, G.W. 1988a. *The Scale Insects of the Tropical South Pacific Region. Part 1. The Armoured Scales (Diaspididae)*. C.A.B. International Institute of Entomology, London. 290 pp.
- WILLIAMS, D.J. & WATSON, G.W. 1988b. *The Scale Insects of the Tropical South Pacific Region. Part 2. The Mealybugs (Pseudococcidae)*. C.A.B. International Institute of Entomology, London. 262 pp.
- WOODHALL, S.E. (Ed.) 1992. *A Practical Guide to Butterflies and Moths in Southern Africa*. Lepidopterists' Society of Southern Africa, Florida Hills. 223 pp.

7. Labelling, accessioning and dispatching

7.1

Labelling

Insects and arachnids that are collected for ecological, taxonomic, physiological or any other studies must always be labelled. The correct labelling of specimens cannot be overemphasised. Specimens without labels are of no scientific value, while incorrect information on labels can lead to misinterpretation of results, often with serious consequences. Great care should therefore be taken to ensure that all specimens are labelled correctly.

All available information pertaining to a specimen should be recorded on a label attached to the specimen. Specimens that are being processed should also be labelled, so that collecting data do not get lost.

- ☞ The precise collecting locality must always be recorded – a specimen is useless without at least a locality label. The name of the country, province, and the distance and direction from the nearest town or city should be noted. Map coordinates of the locality (see below) should be obtained, as names of countries, cities and towns may change over time. Altitude details may be of value for certain groups, like beetles and antlions.
- ☞ The date of collection should be cited as follows: '22.i.1995'. Never use Arabic numerals for the month.
- ☞ The name(s) of the collector(s) (for practical reasons not more than two) should be listed.
- ☞ The host/habitat record (preferably the scientific name) including any relevant data, such as the part of plant sampled, symptoms on plant, type of trap and rearing details, should also be added.
- ☞ An accession number, which corresponds with a number in an accession system (or field book) is always kept with the specimen.
- ☞ If the specimen has been identified, the name of the determiner must be noted, along with the details of the identification. Type specimens

(see page 94) are labelled as such, usually with coloured labels. Type labels should never be removed.

The exact position of a place can be determined by using the grid pattern of latitudes and longitudes on a 1:50 000 or 1:250 000 map.

The latitude (Fig. 86) represents the distance north or south of the equator measured in degrees, and is always quoted first. The equator is at 0 degrees, the poles at 90 degrees and the latitudes are concentric circles in between. The longitude represents the distance east or west of the Greenwich Meridian, which is at 0 degrees, and is measured east or west of this line, to a maximum of 180 degrees exactly opposite the Greenwich Meridian on the other side of the globe. The longitudes are semicircles stretching from pole to pole.

First determine how far south or north your locality is, then how far to the east or west. The exact locality is where these two lines meet, and is quoted in a standard way: 39.20S 30.37E. (39 degrees and 20 minutes South; 30 degrees and 37 minutes East). There are 60 minutes in a degree.

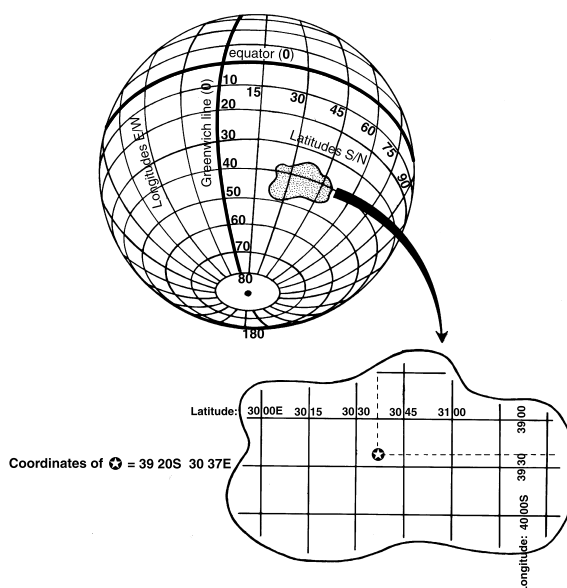


Fig. 86. Method for determining map coordinates

Pinned material

Good quality thin card or 'Ivory board' is suitable for labels on pinned material. Labels should be small and neat. Where there is too much information for a single small label, data may have to be condensed, or the information divided, and smaller, separate labels used (Fig. 87). Small, neat labels can be typed and reduced using a photocopier, or produced by computer, using

appropriate software and a laser printer with scalable fonts. A fine-point pen and Indian ink is recommended for handwritten labels. Never include data on the underside of a label – the information will be overlooked! Labels should always be trimmed close to the edge of the printed data.

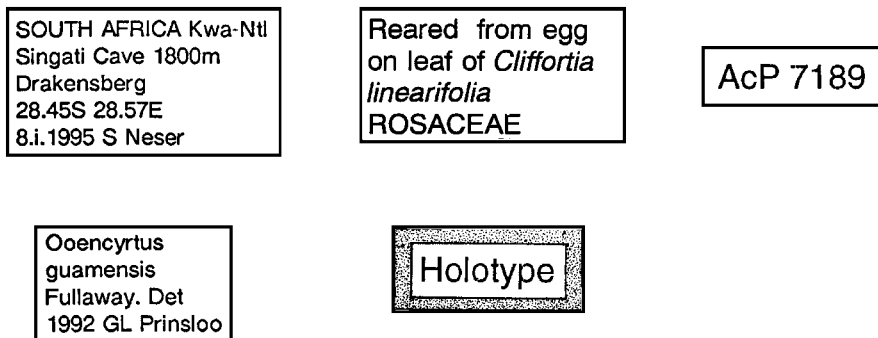


Fig. 87. Examples of labels

A pinning block or height gauge is used for spacing labels neatly on the pin (Fig. 74). In double-mounted specimens, the pin should be inserted through the right-hand side of the label, near the edge (Fig. 88a,b), and in single-mounted specimens, through the middle of the label (Fig. 88c). Labels should be spaced in such a way that they can be read without being moved (Fig. 89).

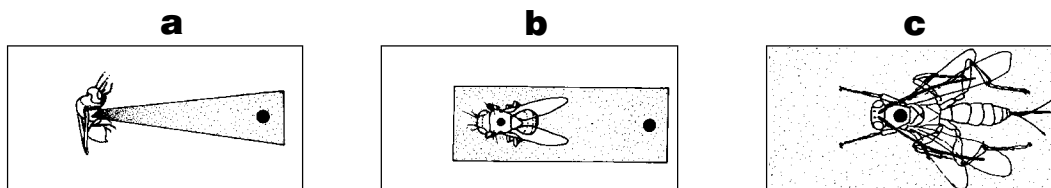


Fig. 88. Position of pin through label, (a & b) double-mounted specimens; (c) single-mounted specimen

Fluid-preserved material

Labels for material preserved in liquid should be handwritten in pencil or Indian ink, or printed with alcohol-proof print on acid-free paper. Preferably only one label, reflecting all the data, should be used. A label of stiff card should be cut to fit snugly inside the vial so that it does not move around and damage the contents, and positioned with the printed side facing outwards so that it can be read through the glass (Fig. 90). If an adhesive label is stuck to the outside of the vial, ensure that the glue or ink will not dissolve if the vial leaks.

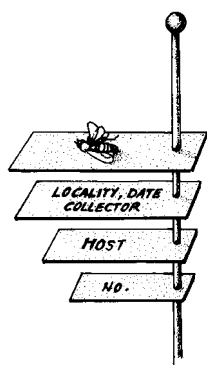


Fig. 89. Position of labels on an insect pin

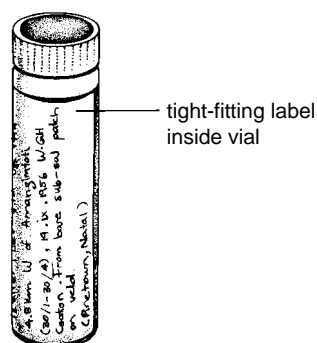


Fig. 90. Labelling of wet material

Microscope slides

The spaces on either sides of the cover slip can be used for labelling (Fig. 91). A good quality glue should be used to fix the labels to the slides. These labels can also be computer-generated.

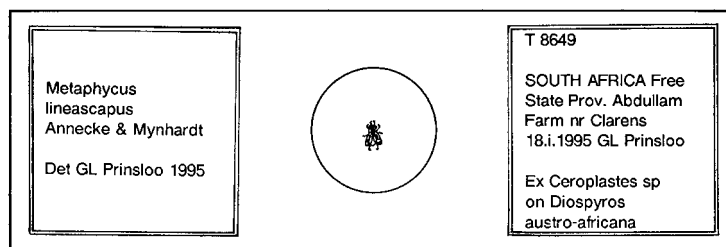


Fig. 91. Labelling of microscope slides

7.2

Accessioning

Accessioning entails the recording of specimen or sample data in a permanent system against a unique number. Besides serving as an inventory, accessioning facilitates data retrieval and cross-referencing and provides a backup database of specimens. A numbering system also makes cross-referencing between different parts of a collection possible.

Each sample is given a unique number associated with all relevant taxonomic and biological data pertaining to that sample. This information is usually recorded in an accession book or on an index card. There are also commercially available computer programs designed specifically for this purpose. These have distinct advantages over books or cards because they

occupy very little physical space and several backups can be kept. Their biggest advantage is the speed at which data can be searched for, retrieved and cross-referenced.

Accessioning should complement, not replace, labelling, and material should never be placed in a collection or dispatched for identification if it is labelled with accession numbers only.

7.3

Dispatching

Dead specimens

Specimens to be dispatched for study or identification usually have to be sent by mail, and precautions must be taken to ensure that they are not damaged in the post.

Great care must be taken to ensure that fragile material will not break when parcels are handled, that specimens do not become mouldy when stored in closed containers, and that vials of fluid-preserved specimens do not leak.

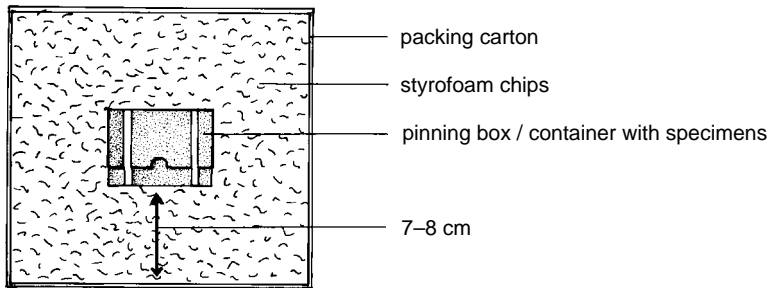
Specimens are always dispatched in a box or parcel that is placed in the centre of a larger, sturdy carton box filled with light, shock-absorbing material such as styrofoam chips, paper shavings or wood wool (Fig. 92a,b). At least one clear warning label, in red, should be fixed on the parcel in a prominent position, reading 'DRIED INSECTS – VERY FRAGILE' or 'HANDLE WITH CARE' (Fig. 92c). It is also advisable to have a label on the parcel stating that the material is for scientific study only and of no commercial value. This should avoid unnecessary confusion and opening of parcels by customs and postal officials.

Pinned specimens should be dispatched in a sturdy wooden or cardboard box with a lid. The pins must be pushed firmly into a layer of cork or 'EPX' foam, which is securely glued to the bottom of the box. The specimens must be braced with pins (Fig. 93) to prevent them from swinging around. Boxes of specimens are usually sealed by sticking a sheet of transparent cellophane or plastic wrap tightly over the box before the lid is put on, to prevent dislodged specimens or body parts from being lost (Fig. 94). The lid of the box must be taped closed.

a



b



c



Fig. 92. (a) Placing dispatching box in sturdy carton filled with shock-absorbing material; (b) cross-section of completed parcel; (c) completed parcel with labels

Labelling, accessioning and dispatching

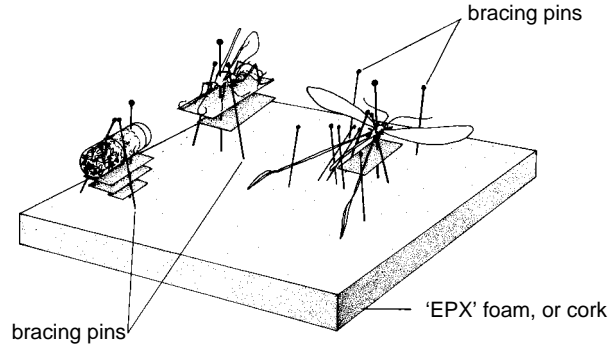


Fig. 93. Specimens braced for dispatching

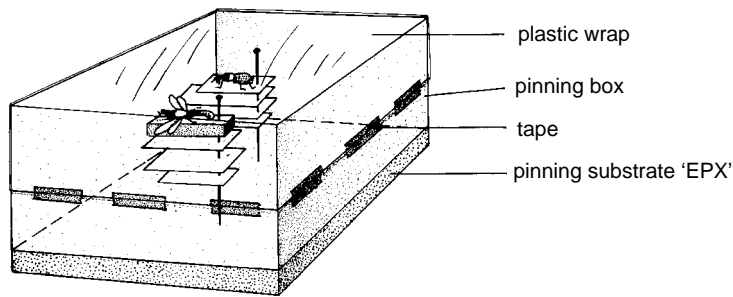


Fig. 94. Dispatching box sealed with plastic wrap

Dry, unpinned specimens are generally placed in a glass or plastic vial for dispatching (Fig. 95). Such vials should not be closed with a plastic or rubber stopper or the specimens will decay. The vial is plugged tightly enough with cotton wool to prevent the specimens from shaking around, but without

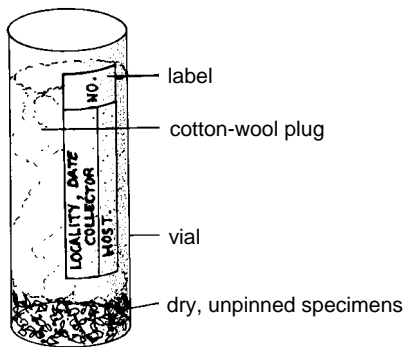


Fig. 95. Unpinned specimens in vial for dispatching

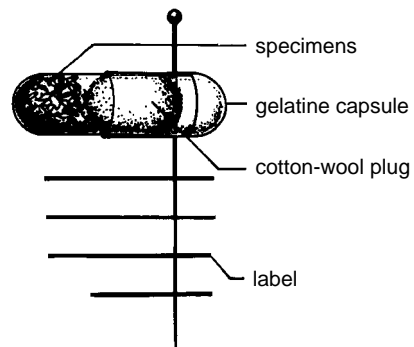


Fig. 96. Small insects in gelatine capsule for dispatching

squashing them or entangling them in the filaments of the cotton wool. The vials are then individually wrapped in paper towelling for protection before placing them in a box.

Very small insects are dispatched in transparent gelatine capsules, also secured by a small wad of cotton wool or tissue paper placed inside the capsule (Fig. 96). The capsules can be pinned and packed for posting in the same way as pinned specimens.

Alternatively, unpinned specimens can be placed between layers of tissue in a flat cigarette box, Petri dish or other suitable container, taped closed, and then put into a larger box.

Specimens preserved in liquid are also dispatched in vials. Very small specimens are secured with a plug of cotton wool in the bottom of a small tube filled with the preserving fluid, being careful not to compress them (Fig. 97). The tubes are then placed in a larger vial filled with the same fluid, secured with cotton wool and closed with a screwtop or a tight-fitting rubber stopper. Narrow vials require less alcohol, reducing the parcel weight. Larger specimens can be placed directly into a larger vial, secured with a plug of cotton wool and sealed.

The following measures should be taken:

- ☞ Each vial must be labelled.
- ☞ The screwtops or stoppers should be taped down to prevent them from coming loose.
- ☞ The vial should be filled with alcohol with no air bubble remaining, as the air may expand in an aircraft or under hot conditions and push out the stopper.
- ☞ The vials should be individually wrapped in tissue or paper towelling, sealed in individual non-perforated plastic bags in case they leak, then wrapped in bubble wrap or other shock-resistant material before being packed in a sturdy box.

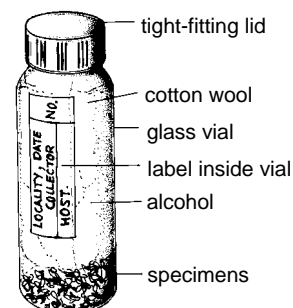


Fig. 97. Wet material in vial for dispatching

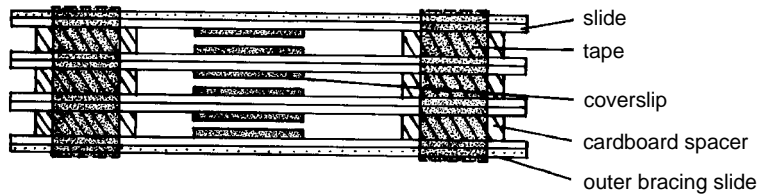


Fig. 98. Slide mounts stacked back-to-back for dispatching

Slide mounts should be stacked back-to-back with cardboard spacers separating the slides (Fig. 98), using blank slides on either side for bracing and finally taped together to form a sturdy unit. Alternatively, slides can be packed in specially made, commercially available boxes (Fig. 99).

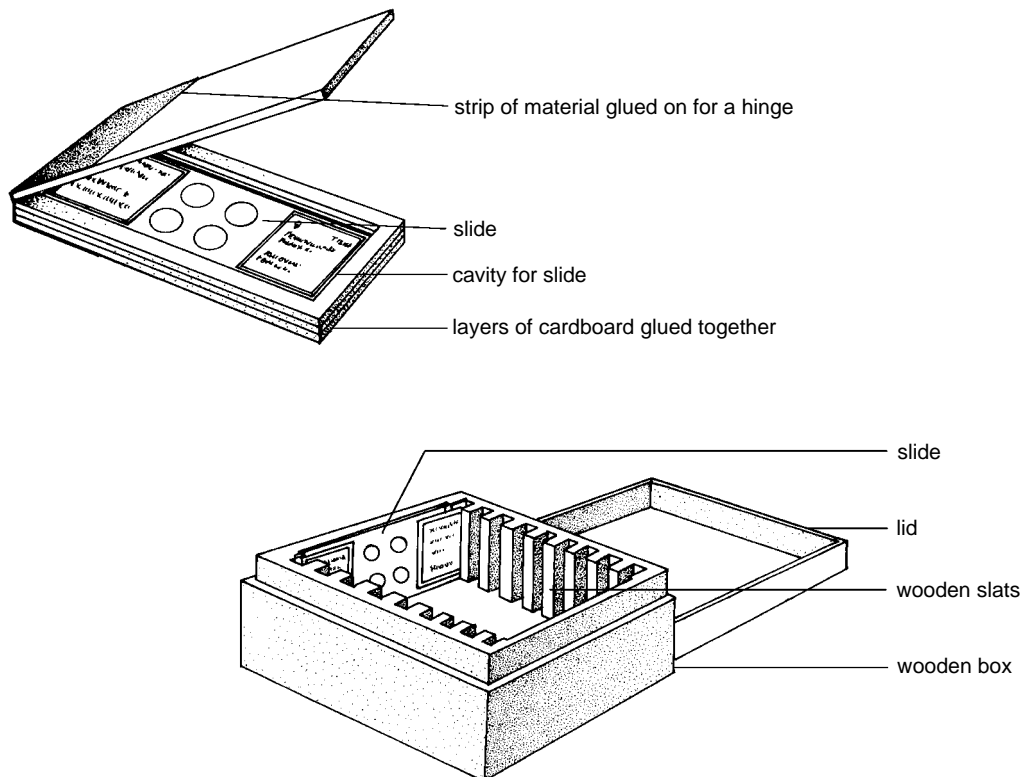


Fig. 99. Specially made boxes for dispatching slide mounts

Live specimens

Dispatching live specimens requires specialised packing methods to ensure that they arrive at their destination alive. If live animals are sent on plant material, the sample should not be sealed in a plastic bag, as it will go mouldy. It should be lightly wrapped in paper towelling and placed in an unsealed plastic bag. This can be packed in a box in the same way as dead specimens. Import and/or export permits are required for dispatching live specimens across national borders. These are usually available from quarantine authorities in government departments, such as Agriculture or Customs.

Further reading

- ENDRÖDY-YOUNGA, S. 1979. Collecting Methods and Material Processing of Arthropoda in the Transvaal Museum. *Bulletin of the Transvaal Museum* 17: 20–26.
- NORRIS, K.R. & UPTON, M.S. 1974. *The Collection and Preservation of Insects*. The Australian Entomological Society, Miscellaneous Publication No. 3. 33 pp.
- OBERPRIELER, R. 1991. Labelling Insect Specimens. Some Do's and Don'ts. *Metamorphosis* 2(3): 30–37.
- OLDROYD, H. 1958. *Collecting, Preserving and Studying Insects*. Hutchinson, Scientific and Technical, London. 336 pp.
- UPTON, M.S. 1991. *Methods for Collecting, Preserving, and Studying Insects and Allied Forms*. The Australian Entomological Society, Miscellaneous Publication No. 3. 86 pp.
- WOODHALL, S.E. (Ed.) 1992. *A Practical Guide to Butterflies and Moths in Southern Africa*. Lepidopterists' Society of Southern Africa, Florida Hills. 223 pp.

8. **P**ermanent storage and curation

Much effort and money goes into collecting and preserving specimens, and they should therefore be properly stored and protected.

Biological collections are of immense value as archives of biodiversity, and as a scientific resources for taxonomic and applied research. Types of storage facilities needed for collections will depend on the manner of preservation of the specimens.

8.1

Types of collections

Dry collections

These mostly comprise pinned specimens that are usually stored in glass-topped drawers slotting into special wooden or steel cabinets. The drawers have tight-fitting lids to keep out museum pests, dust and moisture. The drawer bottoms are lined with a soft substrate into which the pins are inserted. This substrate is traditionally cork, but modern plastic products such as expanded polyethylene ('EPX', 'DEP') are generally more suitable. The drawer

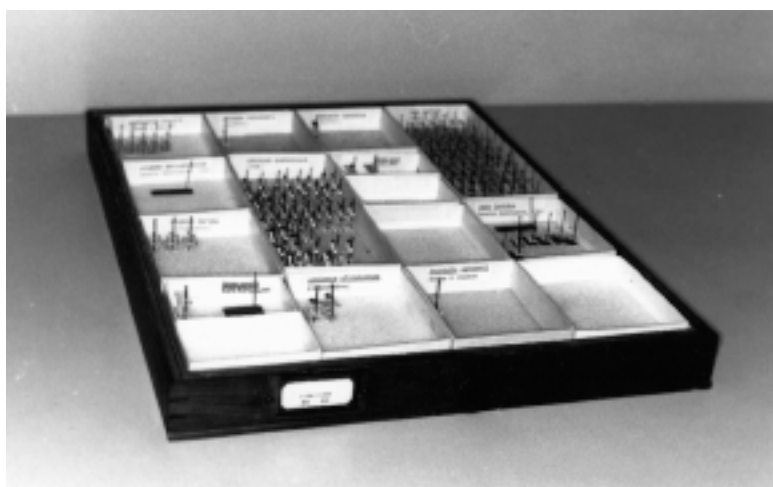


Fig. 100. Drawer containing interchangeable unit trays

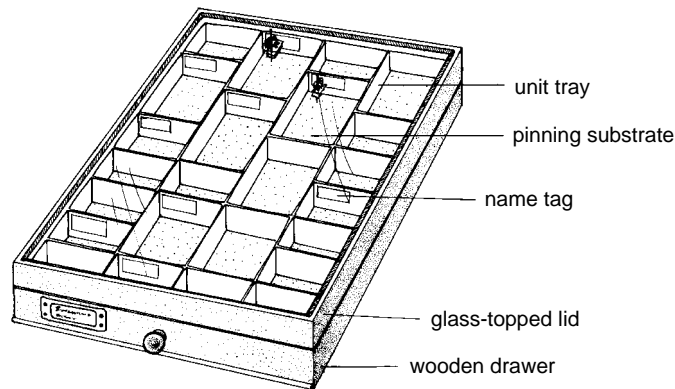


Fig. 100 (continued)

may be lined with a single sheet of substrate. However, a system of interchangeable unit trays made of cardboard or plastic (Fig. 100), and lined with pinning substrate will facilitate rearrangement of the collection.

A simpler way of storing pinned insects is to house them in hinged wooden boxes (Fig. 101). The inside of both sides is lined with a layer of 'EPX' or similar pinning substrate, and the specimens are pinned onto both surfaces. The box must be deep enough to accommodate standard insect pins on both sides without them touching, and must close tightly to prevent insect pests from entering. Such boxes are stored in an upright position on shelves.

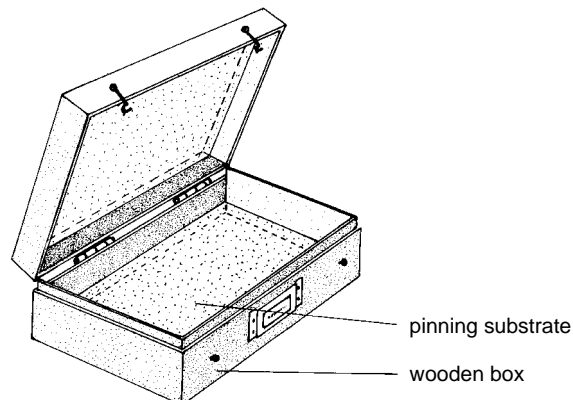


Fig. 101. Hinged wooden boxes for storing pinned insects

Wet collections

These are mostly collections of specimens stored in ethanol, or other preserving fluid, in glass vials with tight-fitting stoppers. Ideally, the vials should be of

uniform size, and are best stored upright in single rows in specially made racks (Fig. 102). These racks are stored on shelves in cabinets. Honey jars are also convenient containers for preserving specimens in liquid (Fig. 103).

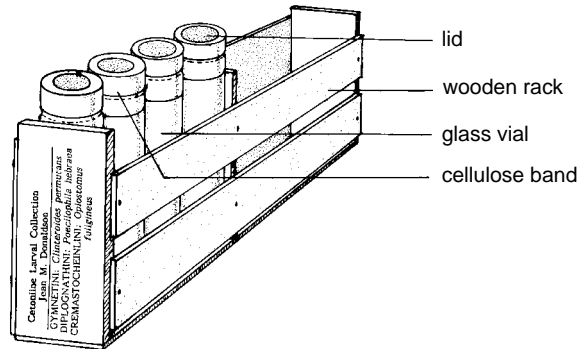


Fig. 102. Uniform-sized vials stored in specially made racks



Fig. 103. Vials of specimens stored in a honey jar filled with alcohol

Slide mount collections

Slide mounts are stored in special commercially available slide boxes. These have grooves to hold the slides in position and apart from each other (Fig. 104). They are stored on shelves in an upright position, so that the slides inside lie horizontally, with the side containing the specimen facing upwards. Alternatively, cabinets made specifically for this purpose can be used. These

cabinets, which occupy relatively little space, consist of trays that hold the slides horizontally (Fig. 105). Small collections can be stored in flat cardboard trays, with flap-over lids.

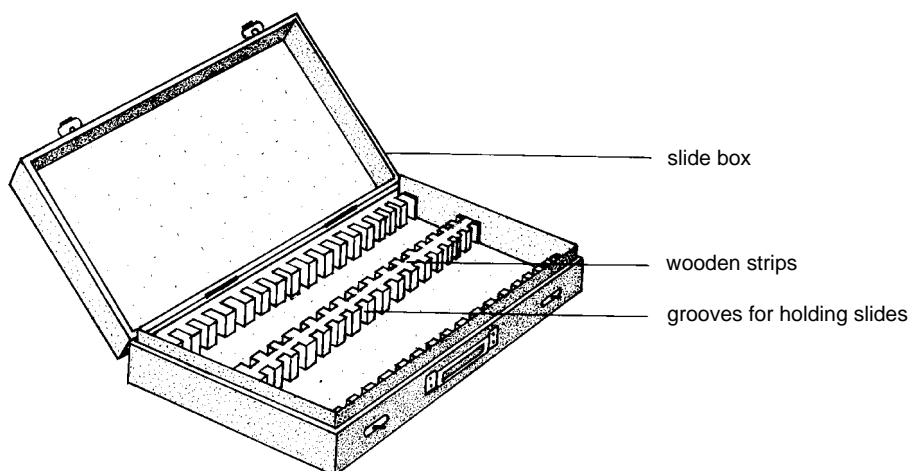


Fig. 104. Slide box

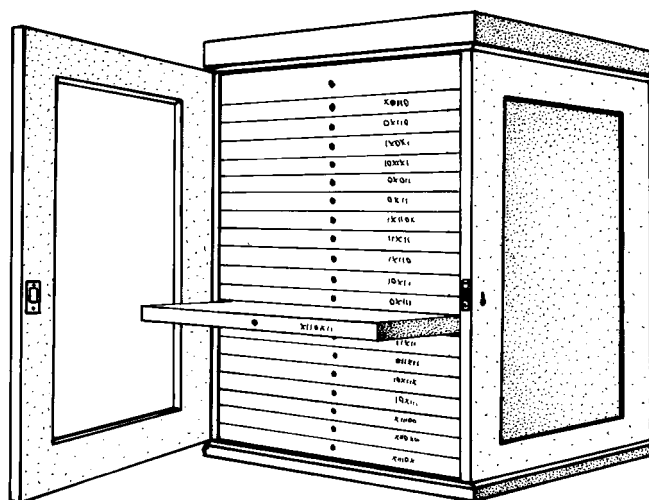


Fig. 105. Cabinet for storing slide mounts

Associated collections

Collections of insect and arachnid specimens often have other specialised collections associated with them, such as genitalia preparations, immature stages, hosts of parasites, photographic records, feeding lesions and galls. A

cross-referencing accession system (see page 83) is required to link associated collections.

Specimens of special significance

☛ Type specimens

Type specimens are those on which published species descriptions are based. Each is the scientific reference to the name of any particular species, and they are therefore of special significance in taxonomy. Types are the most valuable specimens in any collection and are usually stored and protected in special drawers or strongrooms. Most museums also number and index their types. Because of their special significance, type specimens must be available to all scientists and should therefore be deposited only in recognised public institutions (preferably in their country of origin), and not in private collections to which other scientists have only limited access and where their fate is uncertain. When describing new species, the depository of the types must be clearly stated in the publication. The type specimens must also be labelled as such; their status can be denoted by using coloured card for the labels, such as red for holotypes, yellow for paratypes, etc.

☛ Voucher specimens

Voucher specimens are specimens on which a scientific study has been based, and are preserved as a reference for any name published in a non-taxonomic sense. Examples are specimens imported for biological control, species used in a physiological study, or specimens collected during environmental impact surveys. Such specimens should be deposited in a recognised major collection (a taxonomic institution), preferably in their country of origin. This depository and the accession number of the specimens should be mentioned in the published study.

8.2

Curating a collection

Collections should be stored in a safe place, adequately protected against fire and other hazards, and should be inspected on a regular basis for any sign of damage.

Arranging a collection

Identified specimens of the same species are usually placed together in the same drawer, row or unit tray. A larger label with the name of the species is placed inside the drawer or unit tray, or ahead of the row containing all the

specimens of the particular species. This allows easy reference to the species. Alcohol collections are usually arranged within genera or even families and then numbered, allowing easy retrieval when linked to an accession system. Specimens may also be arranged according to localities or host plants, making such information easy to access.

A correct species identification is the key to any information pertaining to an organism and is essential for a meaningful comparison of research results. One can go a long way in identifying specimens oneself to family, and even genus level in some groups, by consulting available publications and books. As insects and arachnids are such large groups, more often than not one will need to consult a specialist in order to obtain an accurate genus and species identification. In some of the lesser-known groups, even an identification to family level may require the input of a specialist. Museums and other institutions can be consulted for identifications, and joining an appropriate society will put one in contact with other enthusiasts.

Preventing insect damage

A number of insects, such as museum beetles, booklice and certain moths, feed on dried insects.

Tight-fitting lids and sealed drawers will exclude these pests from an insect collection to a large extent, but additional measures are required to eliminate them altogether. Insect repellents like naphthalene, or insecticides such as dichlorophos (commercially available as 'Vapona'), may be placed in the drawers, but their fumes are hazardous to humans and they must be replaced periodically.

☛ A safer, yet effective strategy entails:

- ☛ Fumigation of all new material being incorporated into the collection to eliminate sources of infestation (a 10–15 mm block of 'Vapona' is sufficient for a drawer).
- ☛ Visual inspection of all drawers at least twice a year for any sign of damage, indicated by a little heap of dust-frass at the base of the pin, or exuviae of museum beetles. Infested drawers should be fumigated immediately.
- ☛ Fumigation of the collection room twice a year (using aerosol room foggers) to kill resident populations of such pests.

Preventing mould

Mould (fungus) on specimens occurs under moist conditions, and is usually only a problem in the rainy season and in coastal areas with high levels of humidity.

Mould is very detrimental to insect specimens as it causes them to disintegrate totally, and it is usually impossible to save specimens attacked by mould.

Insect drawers may be treated with a fungicide such as phenol, thymol, chlorocresol or ethyl acetate to prevent the development of mould, but these substances are again hazardous to humans and also quite corrosive, attacking the metal of insect pins. Placing a sachet of silica gel crystals in each drawer is a better and safer method. Silica gel is a desiccator that absorbs moisture from the air and discolours when saturated. The crystals can be dried out and used again.

The development of mould can also be prevented by controlling the environment (particularly the humidity) of the collection room by means of air-conditioning systems.

Protection from light

Strong light causes colours of insects and arachnids to fade, and valuable specimens should be stored in darkness. This can be done by storing specimens in closed cabinets, or in tight-fitting drawers in open cabinets.

Evaporation of preservative fluids

Evaporation occurs through even the tightest seals, and regular inspection and topping up of the preservative in a liquid collection is essential. Constant levels of temperature and humidity reduce evaporation to some extent, but regular inspections are still required. A layer of petroleum jelly, applied to the inside of a lid or seal, will also retard evaporation, as will the use of self-shrinking cellulose bands.

Further reading

LONDT, J.G.H. 1984. *A Beginner's Guide to the Insects*. The Wildlife Society of Southern Africa. 100 pp.

NORRIS, K.R. & UPTON, M.S. 1974. *The Collection and Preservation of Insects*. The Australian Entomological Society, Miscellaneous Publication No. 3. 33 pp.

- OLDROYD, H. 1958. *Collecting, Preserving and Studying Insects*. Hutchinson, Scientific and Technical, London. 336 pp.
- PINHEY, E.C.G. 1968. *Introduction to Insect Study in Africa*. Oxford University Press, London. 235 pp.
- UPTON, M.S. 1991. *Methods for Collecting, Preserving, and Studying Insects and Allied Forms*. The Australian Entomological Society, Miscellaneous Publication No. 3. 86 pp.
- WOODHALL, S.E. (Ed.) 1992. *A Practical Guide to Butterflies and Moths in Southern Africa*. Lepidopterists' Society of Southern Africa, Florida Hills. 223 pp.
- YOSHIMOTO, C.M. 1978. Voucher Specimens for Entomology in North America. *Bulletin of the Entomological Society of America* 24(2): 141–142.

9. **C**ollector's code of practice

The following guidelines are suggested for collecting insects and arachnids in a responsible manner:

- ☞ Specimens should be killed as quickly and efficiently as possible and not allowed to suffer or starve to death
- ☞ No more specimens than are strictly required for any purpose should be killed
- ☞ If only routine identification of a species is required, captured specimens should be examined or photographed alive and then released
- ☞ Species known to be endangered, localised or otherwise rare should be collected with the greatest restraint, i.e. not more than one pair at a time
- ☞ Species should not be collected year after year in the same place, but rather new populations should be discovered and explored
- ☞ When trapping arthropods, methods should be used that keep the trapped specimens alive and do not kill them indiscriminately; all unwanted specimens should be released in an appropriate place and at an appropriate time of day
- ☞ If for some reason traps have to be used that kill all trapped specimens, the unwanted ones should not be discarded but offered to other researchers for their collections
- ☞ The species' habitat and environment should be disturbed as little as possible, and collecting sites rehabilitated as far as possible (overturned rocks, logs, bark, leaf litter, water plants, nests etc. replaced, plants damaged as little as possible)
- ☞ Permission from the landowner should be obtained before collecting on private land, and all conditions of official collecting permits should be complied with
- ☞ Species used for commercial purposes should be bred and not taken from the wild in large numbers
- ☞ Specimens should not be used for the manufacture of 'jewellery' or similar ornaments
- ☞ Collected specimens should be properly preserved (e.g. pinned) and

furnished with full collecting data, to enable science to derive maximum information from them

- ☞ Long series of specimens collected at the same time (especially type series of new species) should be disseminated among several collections to minimise the risk of all being destroyed in the event of an accident
- ☞ All or a selection of specimens collected for applied research projects and experiments should be properly preserved and sent to a taxonomic institution as voucher specimens
- ☞ The specimens and their collecting data should be made accessible to science, either by publishing on them oneself or by giving specialists access to them

Glossary

Terms in this glossary should be interpreted in the context of this manual only.

abdomen: posterior part of the body; also called opisthosoma in arachnids

basal: pertaining to the base

carapace: the large dorsal sclerite covering the cephalothorax in arachnids

caudal: of or pertaining to the anal end of a specimen

cercus (pl. cerci): paired appendage(s) of the last abdominal segment

cephalothorax: also called prosoma, anterior part of arachnid body covered by carapace, bearing eyes, legs and mouthparts

chelate: pincer-like, having 2 opposing claws

chelicerae: pincer-like first pair of appendages of arachnids, inserted at the front of the carapace

chitin: substance forming the hard exoskeleton

class: subdivision of a phylum

distal: farthest from the body

dorsal: pertaining to the upper surface

ectoparasite: an external parasite

elytron (pl. elytra): the leathery forewing(s) of beetles, serving as a covering for the hind wing(s)

exoskeleton: hard chitinous skeleton covering the outside of the body

exuviae: the caste skins of larvae and nymphs at moulting

fangs: distal parts of chelicerae

flagellate: having a whip-like structure

gnathosoma: mouth region of Arachnida, including oral appendages of the Acari

haltere (pl. halteres): knob-like modification of hind wing(s) in flies

integument: the outer layer of an arthropod

labium: lower lip

lateral: pertaining to the side

mesosoma: anterior part of the abdomen in scorpions

metasoma: the five-segmented 'tail' of the scorpion

metatarsus: the basal tarsomere

morphology: study of form and structure

- ocellus (pl. ocelli):** simple eye(s)
- ootheca:** a collection of eggs enclosed in secretions, usually of the female accessory glands
- pectines:** in Arachnida, paired ventral comb-like appendages in scorpions making up the second mesosomal segment; mechanoreceptors
- pedicel:** narrow connection between cephalothorax and abdomen
- pedipalp (pl. pedipalpi):** also called palp(i); the second pair of appendages on the cephalothorax
- phylum (pl. phyla):** major division(s) of the animal kingdom
- phytophagous:** feeding on plants
- proleg:** any process that serves the purpose of, but is not homologous with, a leg
- prothorax:** the first thoracic segment in insects, bearing the anterior legs but no wings
- rostrum:** a snout-like projection bearing mouthparts distally
- sclerite:** any plate of the body wall bound by membrane or sutures
- sclerotised:** hardening of the integument
- spinnerets:** appendages on the posterior region of the abdomen arranged in three pairs, provided with small spigots from which silk exudes
- spigot:** structure of the spinneret used to control the flow of silk
- suture:** junction between plates of hardened cuticle of exoskeleton
- tarsomere:** subdivision of the tarsus
- tarsus (pl. tarsi):** last leg segment(s), consisting of tarsomeres
- taxonomy:** the process of classifying organisms
- telson:** last segment of tail in Arachnida, present as a venom-bearing sting in scorpions
- tergites:** dorsal part of a segment or sclerite
- thorax:** middle portion of the body in insects, between the head and abdomen
- ventral:** pertaining to the under surface

Index

A

- Acari 25, 30
- Accessioning 83
- Alderflies (see also Megaloptera)
 - Collecting 53
 - Preserving 77
- Amblypygi 26, 29
- Antlions (see also Neuroptera)
 - Collecting 53
 - Preserving 77
- Ants (see also Hymenoptera)
 - Collecting 54
 - Preserving 77
- Aphids (see also Hemiptera)
 - Collecting 54
 - Preserving 77
- Apterygota 5, 6
- Araneae 26, 29
- Archaeognatha 6, 22
- Arthropoda 5
- Aspirators (pooters) 35

B

- Baits 43
- Barber's relaxing fluid 64
- Beating sheets 40
- Bees (see also Hymenoptera)
 - Collecting 54
 - Preserving 77
- Beetles (see also Coleoptera)
 - Collecting 54
 - Preserving 77
- Berlese (Tullgren) funnel 41
- Blattodea 7, 22, 23
- Booklice (see also Psocoptera)
 - Collecting 54
 - Preserving 77
- Bristletails (see also Archaeognatha)
 - Collecting 54
 - Preserving 77
- Bugs (see also Hemiptera)
 - Collecting 54
 - Preserving 77
- Butterflies (see also Lepidoptera)
 - Collecting 54

Preserving 77

Butterfly traps 46

C

- Caddisflies (see also Trichoptera)
 - Collecting 54
 - Preserving 78
 - Card platforms 70
 - Card points 70
 - Chemical formulae 56
 - Cleaning of specimens 64
 - Cockroaches (see also Blattodea)
 - Collecting 54
 - Preserving 78
 - Coleoptera 16, 22
 - Collecting
 - Bag 34
 - Preferred methods 53
 - Collections
 - Associated collections 93
 - Dry collections 90
 - Slide mount collections 92
 - Wet collections 91
 - Collector's code of practice 98
 - Coordinates (map) 80, 81
 - Crickets (see also Orthoptera)
 - Collecting 54
 - Preserving 78
 - Curating a collection 94
 - Arranging a collection 94
 - Evaporation of preservative fluids 96
 - Preventing insect damage 95
 - Preventing mould 96
 - Protection from light 96
- ## D
- Damselflies (see also Odonata)
 - Collecting 54
 - Preserving 78
 - Dermaptera 8, 21
 - Diptera 14, 18
 - Dispatching 84
 - Dead specimens 84
 - Live specimens 89
 - Dragonflies (see also Odonata)

Collecting 54
Preserving 78

E

Earwigs (see also Dermaptera)

Collecting 54
Preserving 78

Eggs

Preserving 78

Embiodera 8, 21, 23

Ephemeroptera 6, 17

Ethyl alcohol

Dilutions 77

Extractors 41

F

Field data 61

Fishmoths (see also Thysanura)

Collecting 54
Preserving 78

Fleas (see also Siphonaptera)

Collecting 54
Preserving 78

Flies (see also Diptera)

Collecting 54
Preserving 78

Flight-interception traps 49

G

Glossary 100

Grasshoppers (see also Orthoptera)

Collecting 54
Preserving 78

H

Hand collecting 36

Hanging flies (see also Mecoptera)

Harvestmen (see also Opiliones)

Collecting 54
Preserving 78

Hemimetabola 5, 6

Hemiptera 11, 19, 21, 23

Holometabola 5, 12

Hymenoptera 16, 20, 22

I

Isoptera 10, 21, 24

K

Kahle's fluid 57

Killing bottles 57

Killing methods 56
Knock-down sprays 40

L

Labelling 80

Lacewings (see also Neuroptera)

Collecting 53
Preserving 77

Larvae

Preserving 78

Lepidoptera 15, 17

Lice (see also Phthiraptera)

Collecting 54
Preserving 78

Light traps 48

Locality, calculating map coordinates 81

Locusts (see also Orthoptera)

Collecting 54
Preserving 78

M

Malaise trap 50

Mantodea 7, 22

Mayflies (see also Ephemeroptera)

Collecting 54
Preserving 78

Mealybugs

Preserving 78

Mecoptera 13, 20

Megaloptera 12, 21

Midges (see also Diptera)

Minuten pins 71

Mites (see also Acari)

Collecting 54
Preserving 78

Moczarsky-Winkler selector 42

Mosquitoes (see also Diptera)

Moths (see also Lepidoptera)

Collecting 54
Preserving 78

Mounting

Large specimens 65
Small specimens 69

N

Nets

Aerial 37
Aquatic 39
Sweep 38

Neuroptera 13, 21

104

Nymphs

- Preserving 78

O

Odonata 6

Opiliones 27, 30

Orthoptera 10, 20, 22, 23

Owlfly (see also Neuroptera)

P

Palpigradi 30

Pampel's fluid 57

Paper-band traps 44

Permanent storage of specimens 90

Permits, collecting 98

Phasmatodea 8, 21, 23

Pheromone traps 46

Phthiraptera 9, 22

Pinning 65

Pitfall traps 45

Plecoptera 9, 20

Pooters (see aspirators)

Praying mantids (see also Mantodea)

- Collecting 54

- Preserving 78

Preservation 63

- Dry preservation 63

- Preferred methods 77

- Slide preservation 75

- Wet preservation 74

Pseudoscorpiones 27, 30

Pseudoscorpions (see also Pseudoscorpiones)

- Collecting 54

- Preserving 78

Psocids (see also Psocoptera)

Psocoptera 9, 20, 23

Pterygota 5, 6

R

Raphidioptera 12, 21

Rearing 51

Refuges 43

Relaxing methods 63

Resources 43

Ricinulei 30

Romans (see also Solifugae)

S

Scale insects

- Collecting 54

Index

- Preserving 77, 78

Schizomida 28, 29

- Collecting 54

- Preserving 78

Scorpiones 28, 29

Scorpionflies (see also Mecoptera)

- Collecting 54

- Preserving 78

Scorpions (see also Scorpiones)

- Collecting 54

- Preserving 78

Setting 68

Sieves 42

Silverfish (see also Thysanura)

Siphonaptera 14, 22

Snakeflies (see also Raphidioptera)

Solifugae 28, 30

Spiders (see also Araneae)

- Collecting 54

- Preserving 78

Stick insects (see also Phasmatodea)

- Collecting 54

- Preserving 78

Sticky traps 44

Stoneflies (see also Plecoptera)

- Collecting 54

- Preserving 78

Storage

- Permanent storage 90

- Temporary storage 60

Suction traps 48

Sun-spiders (see also Solifugae)

- Collecting 55

- Preserving 78

T

Tail-less whip-scorpions (see also Amblypygi)

Temporary storage of specimens 60

Termites (see also Isoptera)

- Collecting 55

- Preserving 78

Thrips (see also Thysanoptera)

- Collecting 55

- Preserving 78

Thysanoptera 11, 17, 23

Thysanura 6, 22

Ticks (see also Acari)

- Collecting 55

- Preserving 78

Traps

- Butterfly 46

- Flight-interception 49

Light 48
Malaise 50
Paper-band 44
Pheromone 46
Pitfall 45
Sticky 44
Suction 48
Windowpane 49
Yellow-pan 44
Trichoptera 14, 19, 20
Type specimens 94

U

Uropygi 30

V

Voucher specimens 94

W

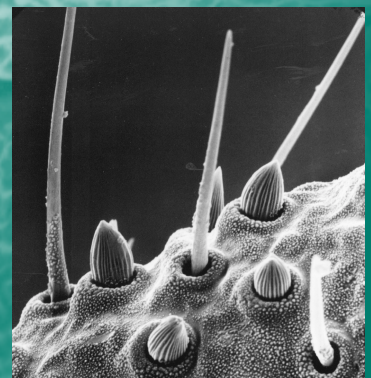
Wasps (see also Hymenoptera)
Collecting 55
Preserving 78
Webspinners (see also Embioptera)
Whip-scorpions (see also Solifugae)
Whip-spiders (see also Amblypygi)
Collecting 55
Preserving 78
White ants (see also Isoptera)
Windowpane trap 49

Y

Yellow-pan traps 44

Z

Zoraptera 9, 21, 24
Zorapterans (see also Zoraptera)



ARC – Plant Protection Research Institute, Pretoria

ISBN 0-620-23564-0