

INTRODUCTION

1. Purpose

This manual is an outdoor sports facilities reference source primarily containing site planning information. Some design information and details are included as planning aids and general guidance.

2. Scope

Appendices A through F illustrate layouts for most outdoor recreational activities commonly played at military installations. Each sport has an outline text page of site planning and design criteria. The typical criteria categories are: Source used for Development; Recommended Area; Size and Dimension; Orientation; Surface and Drainage; and Special Considerations. Opposite this text page is a page showing details and site layout diagrams.

3. Application

Layouts and construction details in this manual are based on the published rules for the sport and will serve as guidance material. Design professionals will prepare actual construction drawings through selection of the appropriate layouts and details and site adaptation with proper grading and drainage to fit local conditions. Changes in playing rules may affect the dimensions and shapes of outdoor sports facilities. Therefore, the latest official rules of the governing body for each sport will be verified with the project drawings prepared in conformance with those rules.

4. Planning and design considerations

Some general planning and design considerations are listed below to complement the specific information found in this manual for each sport. Additional minor construction details are shown in appendix G, figures G-1 through G-5.

a. Lighting requirements. When lighting is required for extending the playing time of a sports facility, it must be justifiable in view of the Government Energy Reduction Program. The Illuminating Engineering Society (IE 5) publication "*Recommended Practice for Sports Lighting*," and pending illuminational levels given in the rules and regulations of the various classes of sports, will be consulted.

b. Support facilities. The availability of support facilities may influence the site planning and design of the facilities given in this manual.

(1) *Bleachers.* The number of seats and location will be dependent on the particular sport and service requirements. The structure may be portable in nature.

(2) *Storage facilities.* Equipment required for the support of a sport activity should be provided near the playing area. This unit may also house pertinent maintenance equipment.

(3) *Handicapped.* Design of all facilities will consider the needs of the handicapped, especially where spectators are involved.

c. Soil conditions. Existing soils affect site planning, design and maintenance of sports facilities for that area. Soils information and technical advice is available from local representatives of the U.S. Army Corps of Engineers.

(1) For sports played on natural turf surfaces, obtaining the best possible playing surface requires that special consideration be given to the nutrient qualities of the topsoil and irrigation as well as to the drainage characteristics of the subsoils.

(2) For sports requiring a paved surface of concrete, bituminous or other hard material, the subbase for the paving type required will be of inorganic material, well drained, and of sufficient depth to prevent frost heave.

(3) For structures such as the One, Three and Four Wall Handball Walls, the bearing capacity of the soils will be determined before the structures can be properly designed.

d. Metric dimensions. Some sports facilities shown are dimensioned in metric units. Metric units are used when the governing body of the sport has specified metric units in the rules and regulations. Many sports organizations do not yet recognize the metric system in their official rules and regulations and therefore, their playing areas are dimensioned in English units.

5. References

Appendix H provides a list of organizations whose rules, regulations, layout designs and construction details were used in the development of this manual. These organizations should be consulted for additional information as required.

PLANNING AND DESIGN OF OUTDOOR SPORTS FACILITIES

	<i>Paragraph</i>	<i>Page</i>
Purpose	1	1
Scope	2	1
Application	3	1
Planning and design considerations	4	1
References	5	1
APPENDIX A. SPORTS COURTS		A-0
APPENDIX B. SPORTS FIELDS		B-0
APPENDIX C. TRACK AND FIELD		C-0
APPENDIX D. MULTIPLE SPORTS COMPLEXES		D-0
APPENDIX E. RECREATIONAL SHOOTING RANGES		E-0
APPENDIX F. MOTOR SPORTS		F-0
APPENDIX G. CONSTRUCTION DETAILS		G-0
APPENDIX H. REFERENCES		H-1

LIST OF FIGURES

<i>Figure</i>	<i>Title</i>	<i>Page</i>
A-1.	Badminton	A-1
A-2.	Basketball (ABAUSA)	A-3
A-3.	Basketball (NCAA)	A-5
A-4.	Biddy basketball	A-7
A-5.	Goal-hi basketball	A-9
A-6.	Boccie	A-11
A-7.	Croquet	A-13
A-8.	One wall handball	A-15
A-9.	Three and four wall handball	A-17
A-10.	Hopscotch	A-19
A-11.	Horseshoes	A-21
A-12.	Ice hockey	A-23
A-13.	Lawn bowling	A-25
A-14.	Roque	A-27
A-15.	Shuffleboard	A-29
A-16.	Deck tennis	A-31
A-17.	Paddle tennis	A-33
A-18.	Platform tennis	A-35
A-19.	Tennis	A-37
A-20.	Tetherball	A-39
A-21.	Volleyball	A-41
B-1.	Baseball—official, Babe Ruth, and Senior League	B-1
B-2.	Bronco League baseball (9-12 yrs.)	B-3
B-3.	Pony League baseball (13-14 yrs.)	B-5
B-4.	Colt League baseball (15-16 yrs.)	B-7
B-5.	Little League baseball (9—12 yrs.)	B-9
B-6.	Softball 12 inch (fast and slow pitch)	B-11
B-7.	Softball 16 inch (slow pitch)	B-13
B-8.	11-man football, (NCAA), Pop Warner Junior League football	B-15
B-9.	Touch and flag football	B-17
B-10.	Lacrosse (men's)	B-19
B-11.	Lacrosse (women's)	B-21
B-12.	Soccer (men's and boys')	B-23
B-13.	Soccer (women's and girls')	B-25
B-14.	Field hockey	B-27
B-15.	Flickerball	B-29
B-16.	Speedball	B-31
B-17.	Team handball	B-33
B-18.	Golf driving range	B-35

*This manual supersedes TM 5-803-10/AFR 88-33 dated 1 October 1975.

LIST OF FIGURES (Cont'd)

<i>Figure</i>	<i>Title</i>	<i>Page</i>
C-1.	400 meter running track	C-1
C-2.	400 meter running track details	C-3
C-3.	Shot Put	C-5
C-4.	Hammer throw	C-7
C-5.	Discus throw	C-9
C-6.	Javelin throw	C-11
C-7.	Long jump and triple jump	C-13
C-8.	Pole vault	C-15
C-9.	High jump	C-17
D-1.	Combination basketball—volleyball court complex	D-1
D-2.	Combination tennis, volleyball, basketball, badminton court complex	D-3
D-3.	Multiple sports court	D-5
D-4.	Combination sports fields	D-7
D-5.	Sports fields within running tracks	D-9
D-6.	Multiple field events within running track	D-11
E-1.	Archery, target range	E-1
E-2.	International shooting union automatic trap	E-3
E-3.	Skeet field	E-5
E-4.	Trap field	E-7
E-5.	Combination skeet and trap field	E-9
F-1.	Go Kart (oval track)	F-1
F-2.	Go Kart (road track)	F-3
G-1.	Fixed net posts	G-0
G-2.	Removable net posts	G-1
G-3.	Football and basketball goal and posts details	G-2
G-4.	Typical grading and drainage details	G-3
G-5.	Typical playing surface	G-4

APPENDIX A

SPORTS COURTS

A-1. Badminton (see fig A-1)

- a. Source of information.* United States Badminton Association, (USBA).
- b. Recommended area.* Ground space is 1,620 square feet (0.04 acres) minimum to edge of pavement.
- c. Size and dimension.* Singles court is 17 feet by 44 feet, doubles court is 20 feet by 44 feet with a 6-foot minimum unobstructed area on all sides.
- d. Orientation.* Preferred orientation is for the long axis to be north-south.
- e. Surface and drainage.*
 - (1) Surface is to be concrete or bituminous material with optional protective colorcoating for permanent installation. Turf may be used for general recreation use with surface drainage as described in (2) below except a minimum slope of 2 percent and adequate underdrainage will be used.
 - (2) Drainage is to be end to end, side to side or corner to corner diagonally at the minimum slope of 1 inch in 10 feet (0.8 percent).

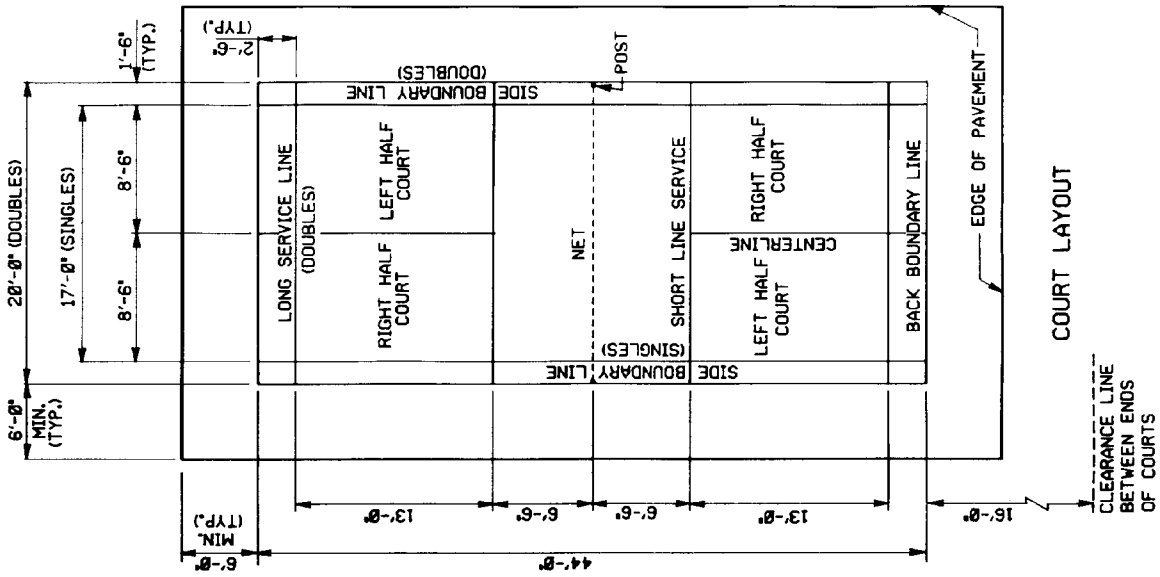

NOTES:

- All court markings to be 1½" wide and preferably white.
- All measurements for court markings are to the outside of lines except for those involving the center service line which is equally divided between right and left service courts.
- Width of lines on service court (long & short service lines) fall within the 13 feet given as the service court.
- Minimum distance between sides of parallel courts to be 6'-0".
- Post should be positioned on the line, flush with outside of line.
- For net post details see figure G-1 or G-2.
- For surfacing details see figure G-5.
- Manufacturers have combination tennis, volleyball and badminton standards available.

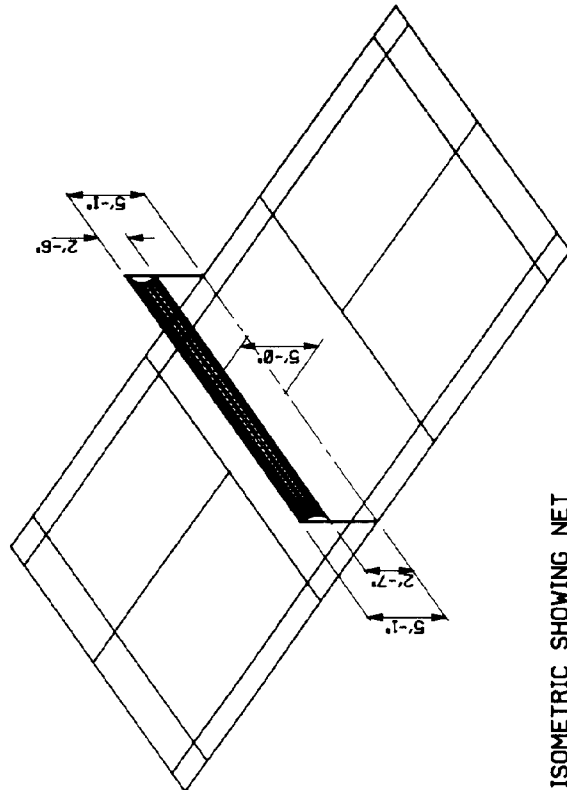

ISOMETRIC SHOWING NET

Figure A-1. Badminton.

A-2. Basketball (ABAUSA) (see fig. A-2)

- a. *Source of information.* American Basketball Association, USA (ABAUSA).
- b. *Recommended area.* Ground space is 448 square meters (0.11 acre) minimum to 540 square meters (0.13 acre) recommended, including unobstructed space.
- c. *Size and dimension.* Playing court is 14 meters by 26 meters with an unobstructed space of 1 meter minimum to 2 meters recommended on all sides.
- d. *Orientation.* Preferred orientation is for the long axis to be north-south.
- e. *Surface and drainage.*
 - (1) Surface is to be concrete or bituminous material with optional protective colorcoating.
 - (2) Drainage is to be end to end, side to side or corner to corner diagonally at the minimum slope of 1 inch in 10 feet (0.8 percent).

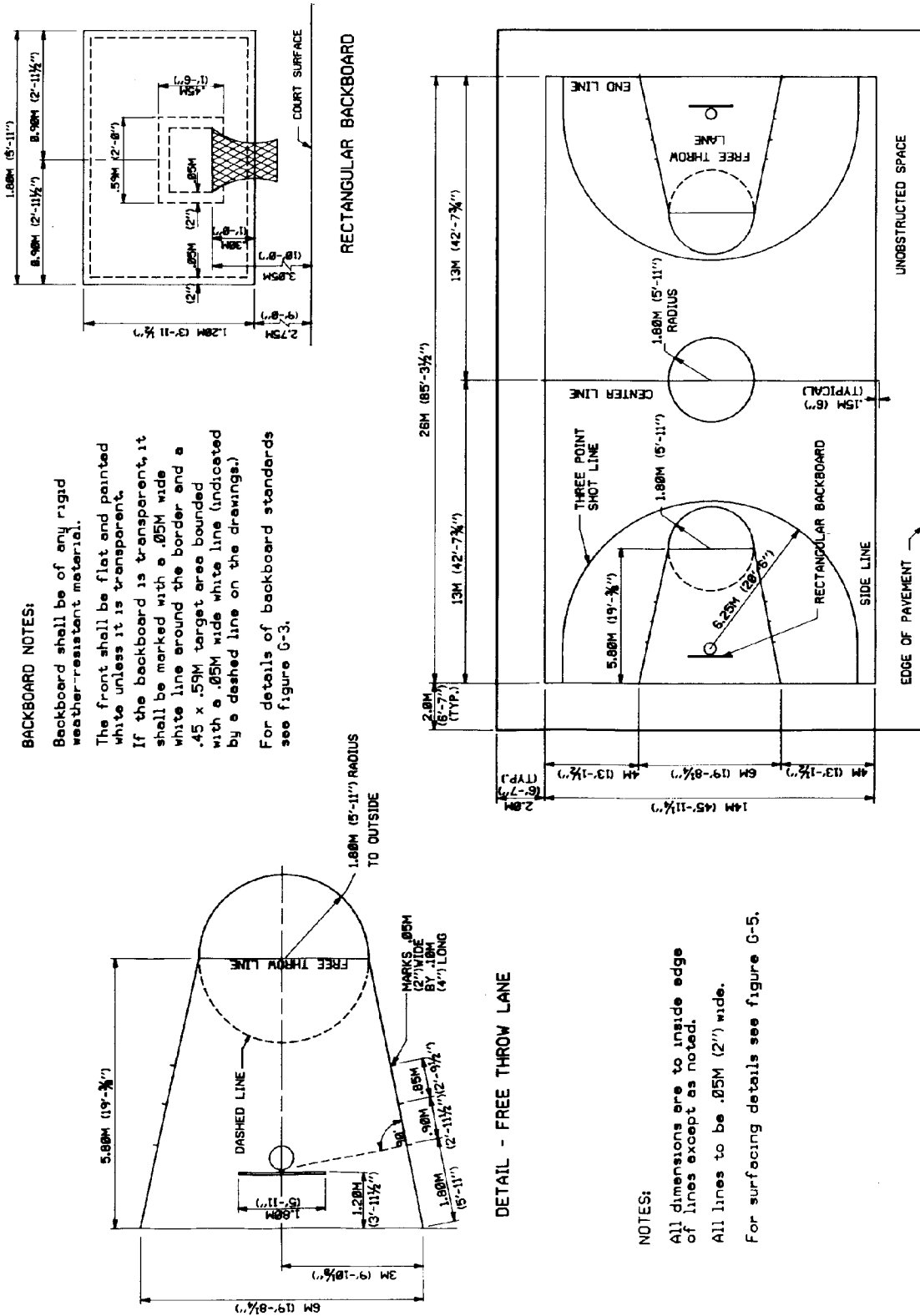

Figure A-2. Basketball (ABAUSA).

A-3. Basketball (NCAA) (see fig A-3)

- a. *Source of information.* National Collegiate Athletic Association (NCAA).
- b. *Recommended area.*
 - (1) High School — ground space is 5,040 square feet (0.12 acre) minimum to 7,280 square feet (0.17 acre) maximum.
 - (2) Collegiate — ground space is 5,600 square feet (0.13 acre) minimum to 7,980 square feet (0.18 acre) maximum.
- c. *Size and dimension.*
 - (1) High School recommended court is 84 feet by 50 feet with a 10-foot unobstructed space on all sides (3-foot minimum).
 - (2) Collegiate recommended court is 94 feet by 50 feet with a 10-foot unobstructed space on all sides (3-foot minimum).
- d. *Orientation.* Preferred orientation is for the long axis to be north-south.
- e. *Surface and drainage.*
 - (1) Surface is to be concrete or bituminous material with optional protective colorcoating.
 - (2) Drainage is to be end to end, side to side or corner to corner diagonally at the minimum slope of 1 inch in 10 feet (0.8 percent).

A-4. Bidy basketball (see fig A-4)

- a. *Source of information.* Bidy Basketball Association, Inc.
- b. *Recommended area.* Ground space is 4,680 square feet (0.11 acre) to 5,040 square feet (0.12 acre) including clear space.
- c. *Size and dimension.* Playing court is 46 feet 0 inch to 50 feet 0 inch wide and 84 feet 0 inch long with an unobstructed space of at least 3 feet recommended on all sides.
- d. *Orientation.* Preferred orientation is for the long axis to be north-south.
- e. *Surface and drainage.*
 - (1) Surface is to be concrete or bituminous materials with optional protective colorcoating.
 - (2) Drainage is to be end to end, side to side or corner to corner diagonally at a minimum slope of 1 inch in 10 feet (0.8 percent).

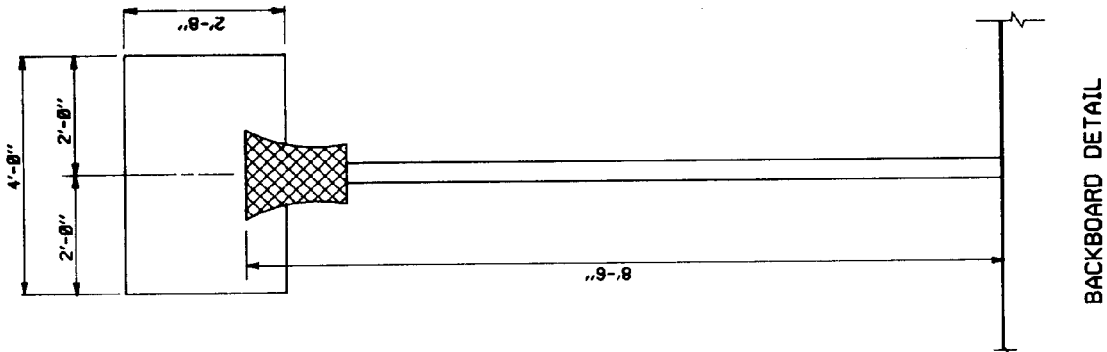
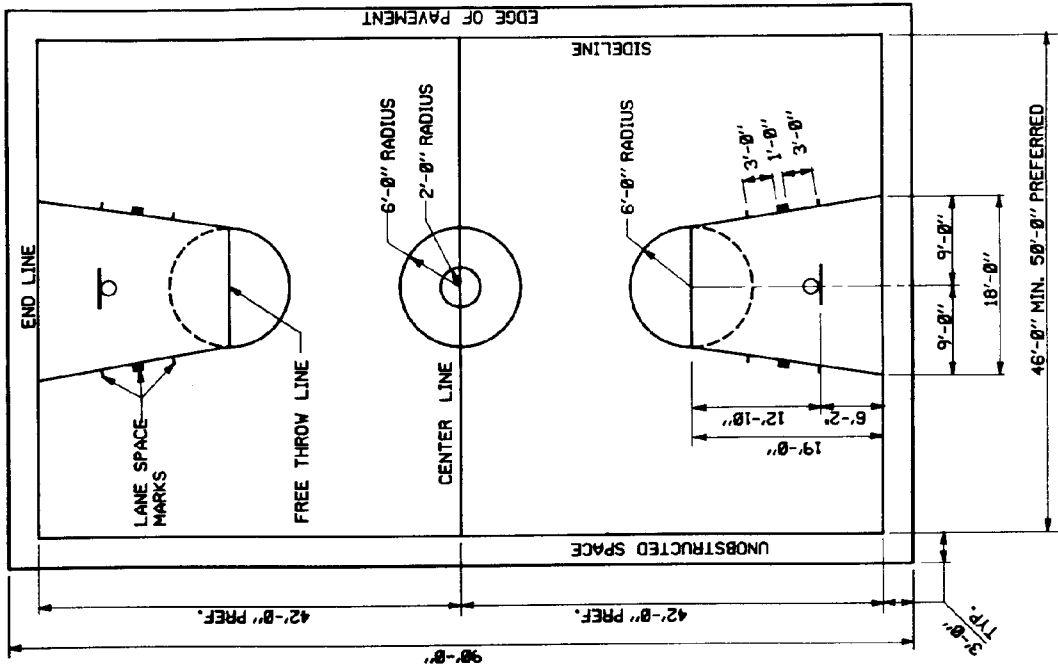

Figure A-4. Biddy basketball.



- NOTES:**
- All dimensions are to inside edge of lines except as noted.
 - All lines shall be 2" wide.
 - For standard details see figure G-3.
 - For surfacing details see figure G-5.

COURT LAYOUT

A-5. Goal-Hi basketball (see fig A-5)

- a. *Source of information.* AMF Voit Corporation.
- b. *Recommended area.* Ground space minimum is 1,256 square feet (0.03 acre); maximum is 2,82 square feet (0.06 acre).
- c. *Size and dimension.* Playing court is to be an outer court circle with a minimum radius of 20 feet 0 inch and a maximum radius of 30 feet 0 inch, surrounding a concentric inner court circle with a minimum radius of 10 feet 0 inch and a maximum radius of 15 feet 0 inch.
- d. *Orientation.* Optional.
- e. *Surface and drainage.*
 - (1) A resilient synthetic surface is preferred for safety and comfort. However, concrete or bituminous surface may be used for minimum maintenance.
 - (2) Minimum slope is 1 inch in 10 feet (0.8 percent) for drainage in any direction.

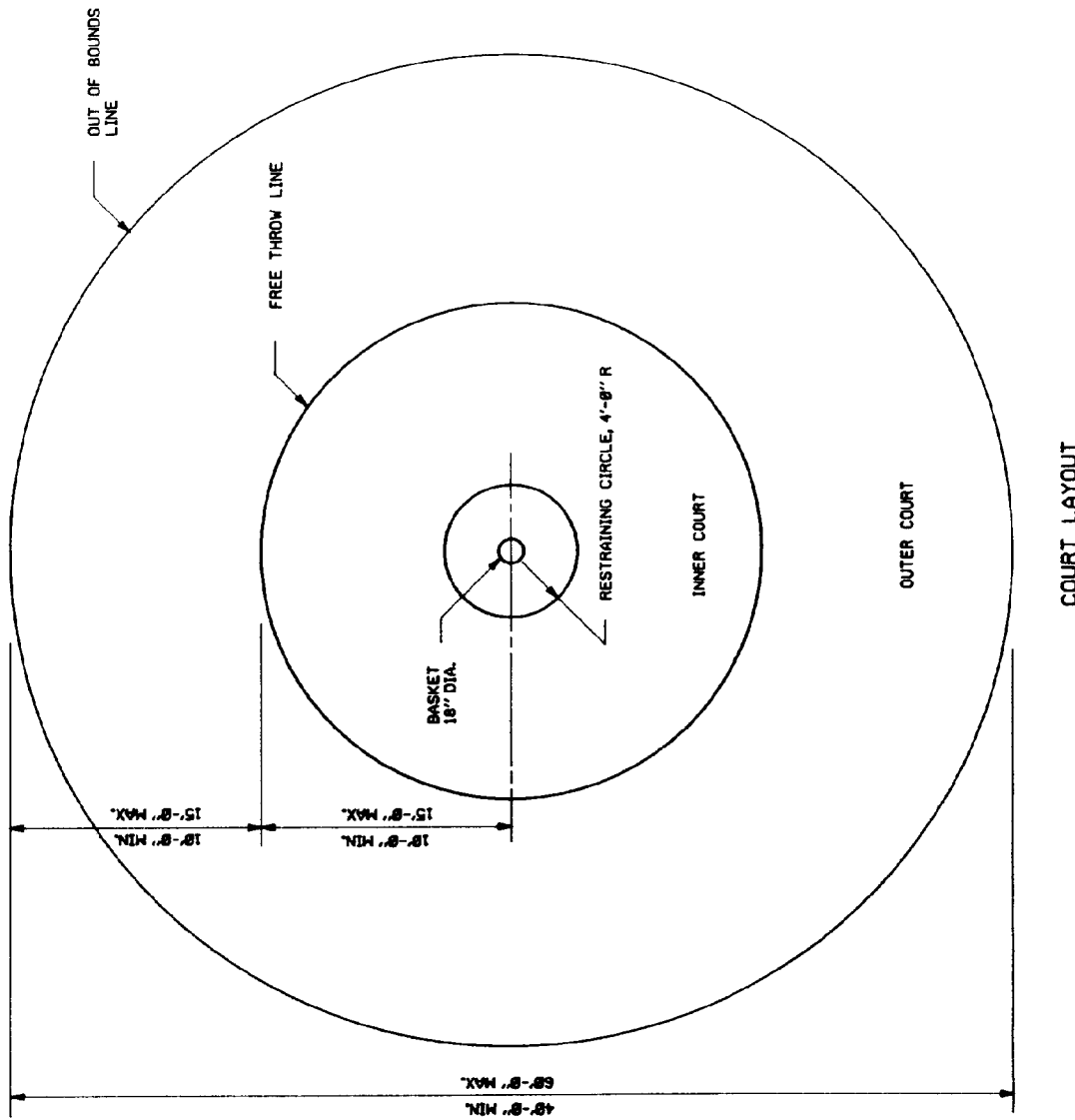

NOTES:

- All court markings to be 2" wide.
- For surfacing details see figure G-5.
- Goal Hi standard may be permanently mounted, removable flush mounted, or portable as shown.
- For fixed or removable post details see figures G-1 or G-2.

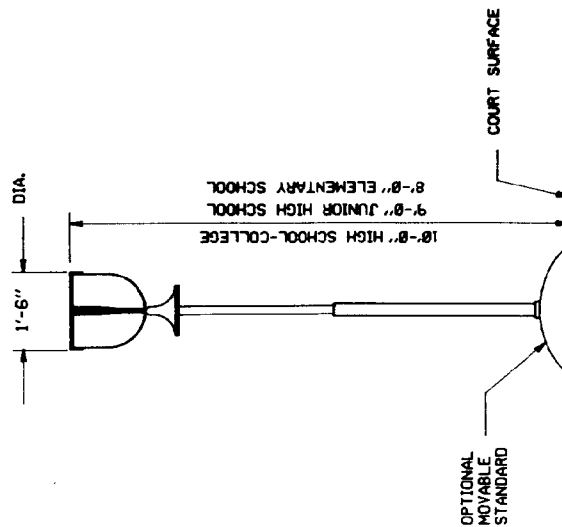

SECTION OF GOAL HI STANDARD

Figure A-5. Goal-Hi basketball.

A-6. Boccie (see fig A-6)

- a. *Source of information.* General Sportcraft Company, Ltd.
- b. *Recommended area.* Ground space is 1,824 square feet (0.04 acre) to 2,805 square feet (0.06 acre).
- c. *Size and dimension.* Overall court dimensions range from 13 feet 0 inch to 19 feet 6 inches wide by 78 feet 0 inch to 92 feet 0 inch long. Additional space of at least 3 feet 0 inch on each side and 9 feet 0 inch on each end is recommended.
- d. *Orientation.* Preferred orientation is for the long axis to be north-south. It may be adjusted to suit local topographic conditions.
- e. *Surface and drainage.*
 - (1) Surface is to be preferably turf, although a mixture of sand and clay may be used.
 - (2) Drainage may be in any direction at a recommended slope of 1 percent for turf and level for sand-clay with subdrainage.
- f. *Special considerations.* Optional low wooden barrier should be provided at each end and/or side of court.

A-7. Croquet (see fig A-1)

- a. *Source of information.* National Croquet Association, Inc. (NCA).
- b. *Recommended area.* Ground space is 3,000 square feet (0.07 acre).
- c. *Size and dimension.* Playing area is 35 feet 0 inch by 70 feet 0 inch, plus minimum 2 feet 6 inches on each end and side.
- d. *Orientation.* Orientation may be adjusted to suit local topographic conditions.
- e. *Surface and drainage.* Playing surface is to be turf closely cropped and rolled with a maximum 2 percent slope (preferably level) and adequate subdrainage.

NOTES:

Stakes shall be made of steel and shall be firmly anchored. They shall be 1 1/2" high and set 1/2" outside the playing line halfway between the end corners.

Playing lines may be either imaginary, marked with white chalk or with smaller twine wired close to the ground
For surfacing details see figure G-5.

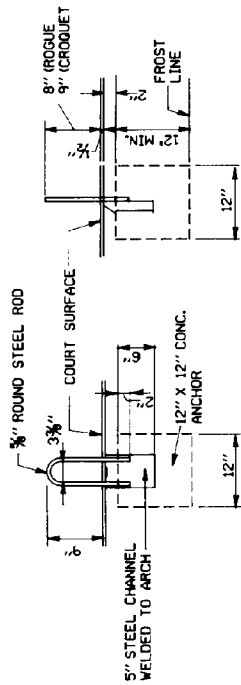

ARCH DETAILS

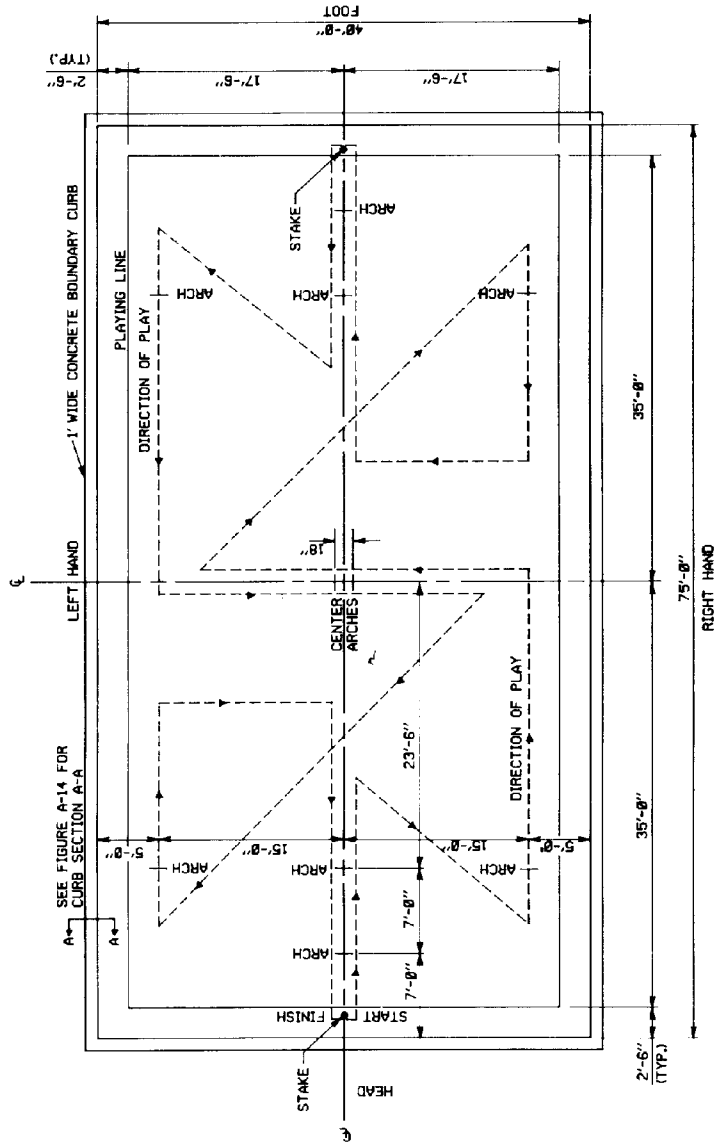

COURT LAYOUT

Figure A-7. Croquet.

A-8. One wall handball (see fig A-8)

- a. *Source of information.* United States Handball Association (USHA).
- b. *Recommended area.* Ground space is 1,665 square feet (0.04 acre) plus walls and footings.
- c. *Size and dimension.* Playing court is 20 feet 0 inch wide by 34 feet 0 inch long plus a required 11 feet 0 inch minimum width of surfaced area to the rear and a recommended 8 feet 6 inches minimum width on each side. Courts in battery are to be a minimum of 6 feet 0 inch between courts.
- d. *Orientation.* Preferred orientation is for the long axis to be north-south with the wall at the north end.
- e. *Surface and drainage.* Floor surface is to be smooth concrete with a minimum slope of 1 inch in 10 feet (0.08 percent) from the wall to the rear of the court. Wall to be concrete with very smooth finish, free of irregularities.
- f. *Special considerations.* Court area will be fenced with a 10-foot high chain link fence.

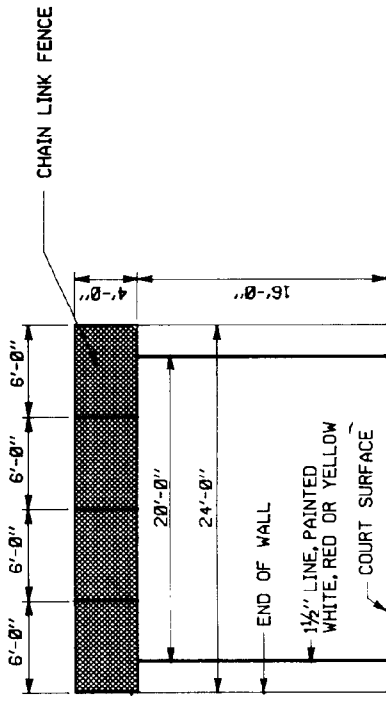

ELEVATION

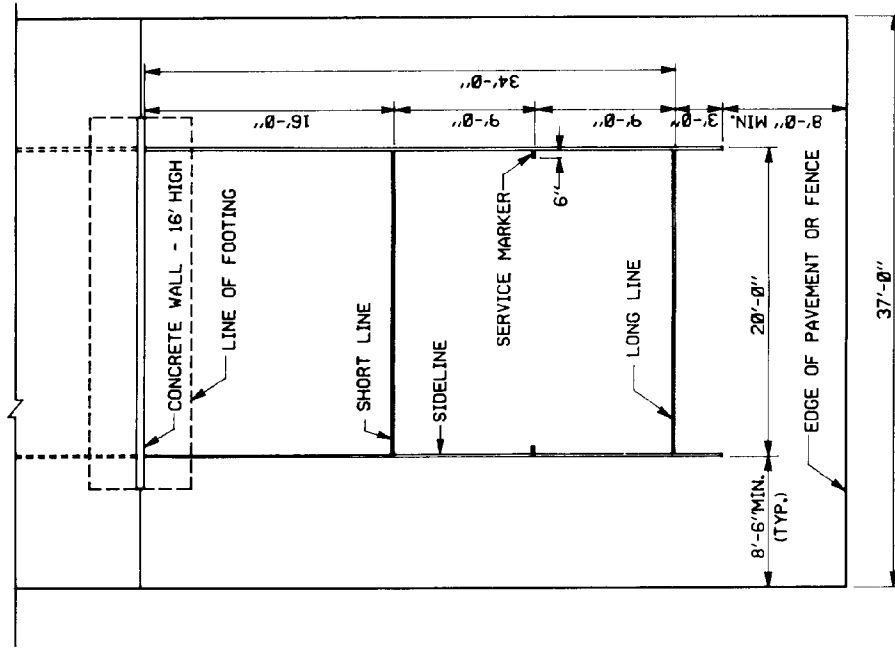

COURT LAYOUT

NOTES:

Court markings 1 1/2" wide lines painted white, red or yellow.

For surfacing details see figure G-5.

Walls and footings shall be designed for site-specific conditions.

Figure A-8. One wall handball.

A-9. Three and four wall handball (see fig A-9)

a. *Source of information.* American Amateur Racquetball Association (AARA).

b. *Recommended area.* Ground space for four wall handball is 800 square feet (0.02 acre), plus walls and footing. Allow an additional 200 square feet for three wall handball.

c. *Size and dimension.* Playing court is 20 feet 0 inch wide by 40 feet 0 inch long plus a minimum 10 feet 0 inch to the rear of the three wall court. Overhead clearance required is 20 feet 0 inch minimum.

d. *Orientation.* Preferred orientation is for the long axis to be north-south with the front wall at north end.

e. *Surface and drainage.* Floor surface is to be smooth concrete preferably with a minimum slope of 1 inch in 10 feet (0.8 percent) from front to rear of the court. Walls to be concrete with very smooth finish, free of irregularities.

f. *Special considerations.*

(1) Alternate four wall court. Layout is the same for three wall with the exception of a minimum 12-foot 0-inch high back wall at the rear of the court (long line) and necessary wall footings.

(2) Drainage. Special provisions for drainage must be made and access provided through the back wall for four wall courts.

(3) Fencing. An optional 10-foot high chain link fence may be provided at the rear of the pavement for three wall courts.

(4) Marking of receiving line. See Section 2, paragraph A(2)(e) of AARA rules for correct marking of receiving line.

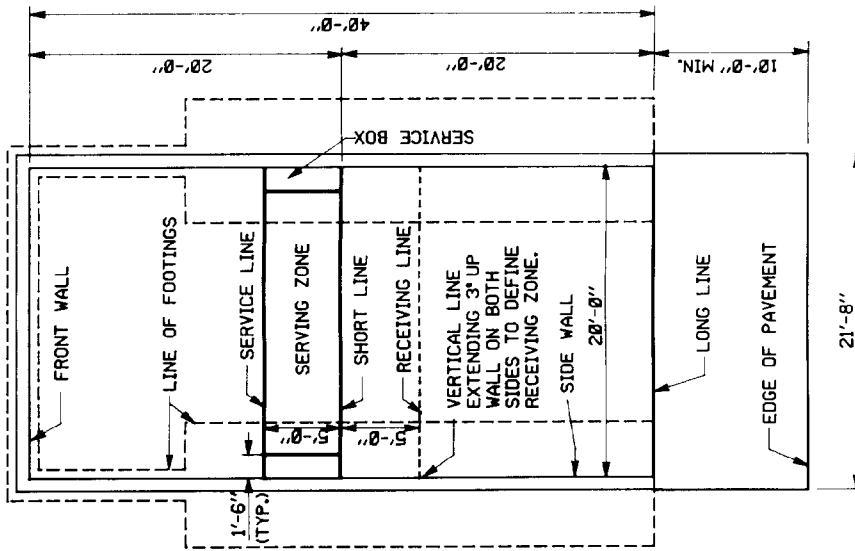

COURT LAYOUT - 3-WALL

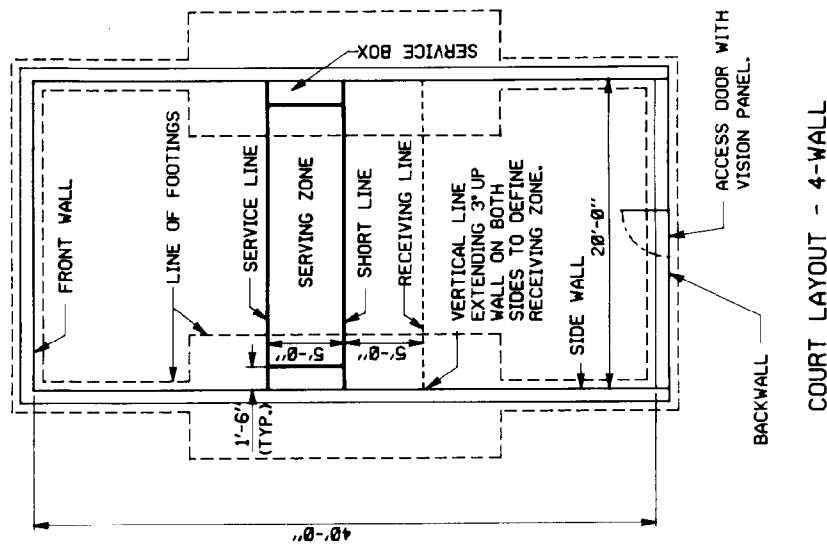

COURT LAYOUT - 4-WALL

NOTES:

All court markings to be 1½" wide and painted white, red or yellow.

Walls and footings shall be designed for site-specific conditions.

For surfacing details see figure G-5.

Figure A-9. Three and four wall handball.

A-10. Hopscotch (see fig A-b)

- a. *Source of information.* AMF Voit Corporation.
- b. *Recommended area.* Ground space is 62.5 square feet (0.001 acre).
- c. *Size and dimension.* Playing court is 5 feet 0 inch wide by 12 feet 6 inches long.
- d. *Orientation.* Optional.
- e. *Surface and drainage.* Surface is to be concrete or bituminous material with a lateral slope of 1 inch in 10 feet (0.8 percent) and a longitudinal slope of 1 inch in 10 feet (0.8 percent) minimum.

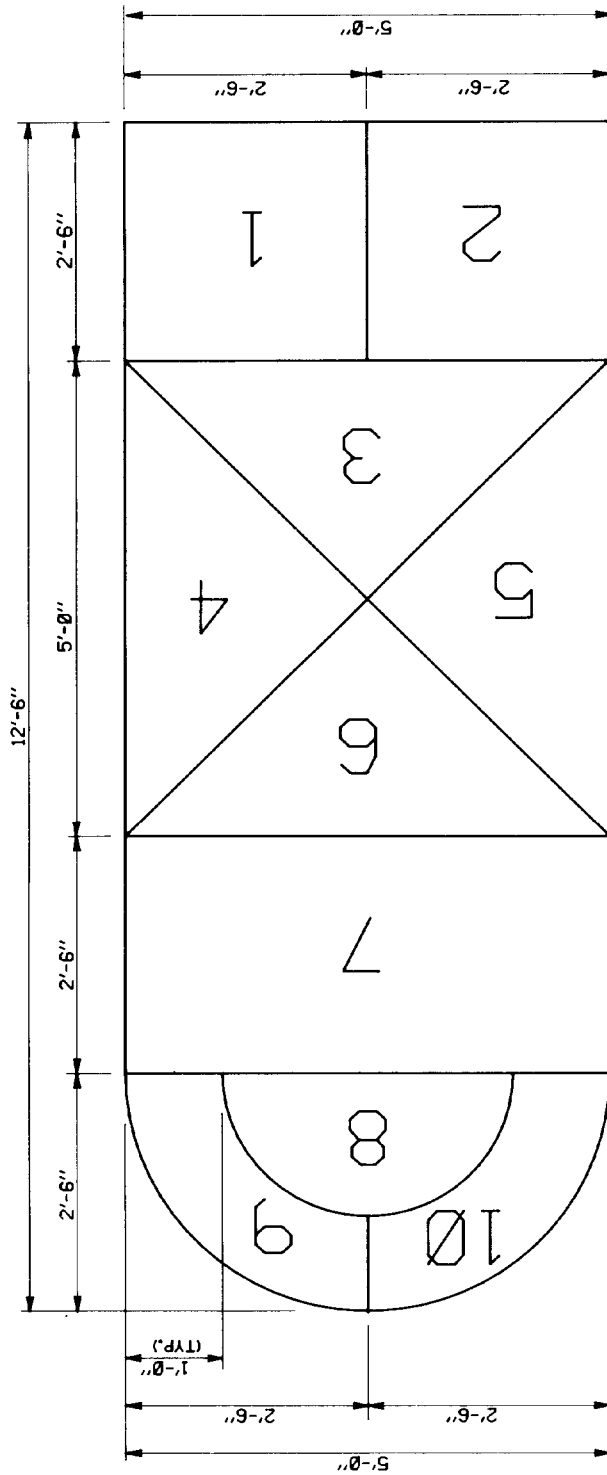

COURT LAYOUT

NOTES:

All lines to be 1½" wide painted with white or black acrylic paint to contrast with court surface.

For surfacing details see figure G-5.

Figure A-10. Hopscotch.

A-11. Horseshoes (see fig A-11)

- a. *Source of information.* National Horseshoe Pitchers' Association of America (NHPAA), 1974.
- b. *Recommended area.* Ground space is 1,540 square feet (0.04 acre), including clear space.
- c. *Size and dimension.* Playing court is 12 feet 0 inch by 50 feet 0 inch plus a recommended 10-foot unobstructed area on each end and a 5-foot minimum wide zone on each side.
- d. *Orientation.* Recommended orientation is for the long axis to be north-south.
- e. *Surface and drainage.* Surface of playing area, except for boxes and optional concrete walkways, should be turf. Area should be pitched to the side at a maximum slope of 2 percent. Elevation of top of steel pegs should be equal.
- f. *Special consideration.* Safety: A 1-foot 10-inch minimum high backstop should be constructed at the end of the box to intercept overthrown or bounding shoes.

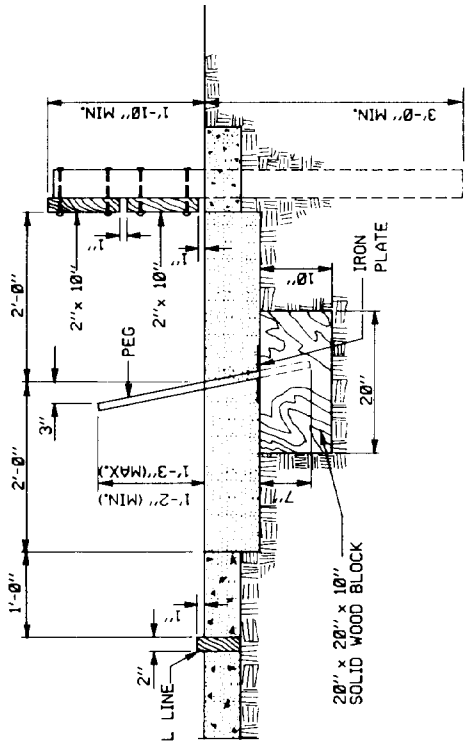

SECTION A-A

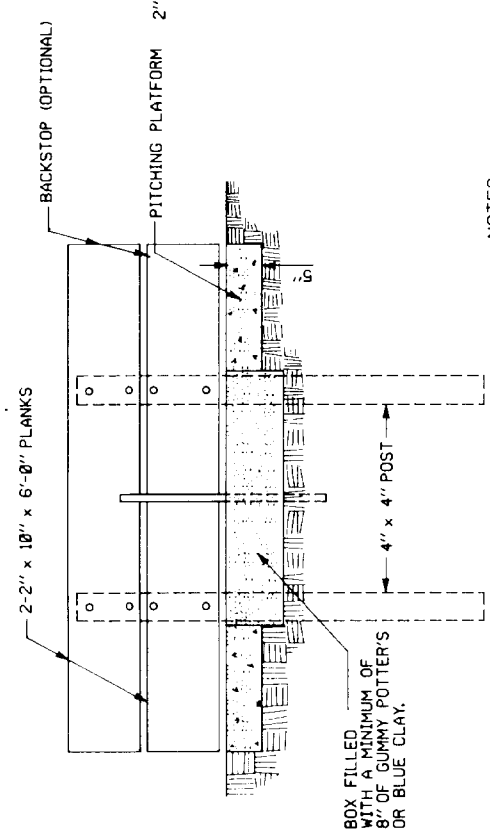

SECTION B-B

NOTES:

Adjacent courts may be no closer than 10'-0" from stake to stake.

For court surfacing details see figure C-5.

All wood members to be pressure treated with a paintable oil-borne preservative.

ALTERNATE 2" x 6" PLANKS AROUND BOX, FASTENED BY 2" x 4" x 2"-Ø" STAKES AT CORNERS, AND CAPPED WITH 1/4" x 1-5/8" STEEL STRAP

BACKSTOP OPTIONAL

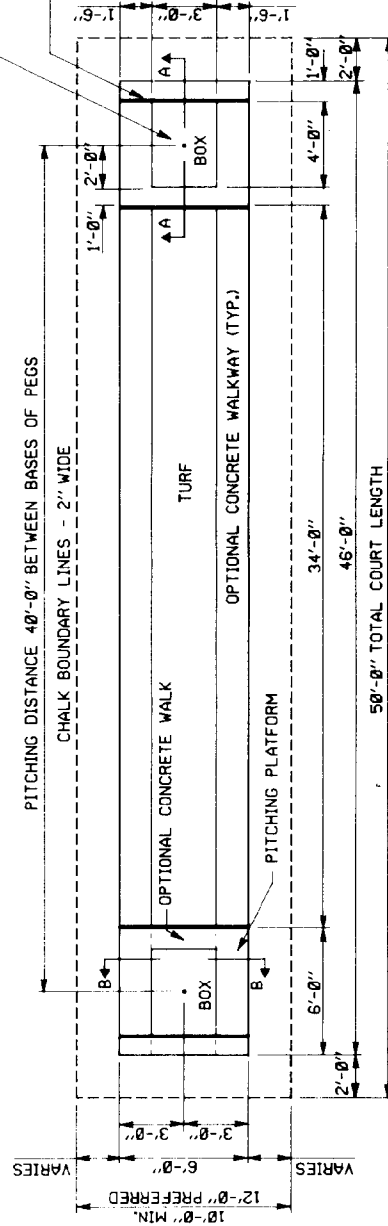

COURT LAYOUT

Figure A-11. Horseshoes.

A-12. Ice hockey (see fig A-12)

- a. *Source of information.* Amateur Hockey Association of the United States (AHAUS).
- b. *Recommended area.* Ground space is 22,000 square feet (0.51 acre), including support area.
- c. *Size and dimension.* Playing rink is 85 feet 0 inch wide by 200 feet 0 inch long, plus an additional 5,000 square feet (0.11 acre) of support area.
- d. *Orientation.* Preferred orientation is for the long axis to be north-south.
- e. *Surface and drainage.* The ice surface will be level over either sand-clay or bituminous surface. Provisions for drainage should be made on the surface beneath the ice and around the rink.
- f. *Special consideration.* Ice: Unless situated in northern climates, provisions for artificial ice will be required.

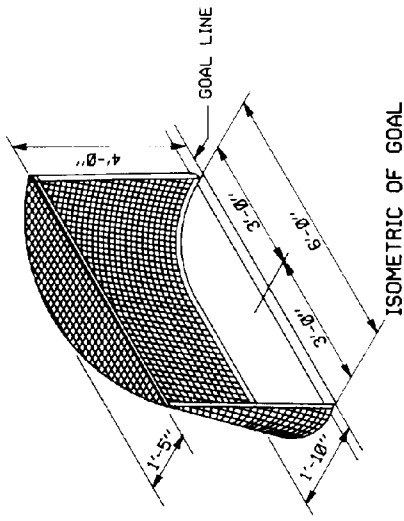

NOTES:

- The rink shall be surrounded by a wooden wall or fence known as the "BOARDS" which shall extend not less than 40" nor more than 48" above the level of the ice surface. Ideal 42".
- The surface of the boards facing the ice shall be smooth and free from obstructions. All access doors to the playing surface must swing away from the ice surface.
- A protective screening of heavy gauge wire or safety glass is recommended above the boards, except for the bench areas, for the protection of the spectators around the rink.
- The center line and the two blue lines shall extend across the rink end vertically to the top of the boards.

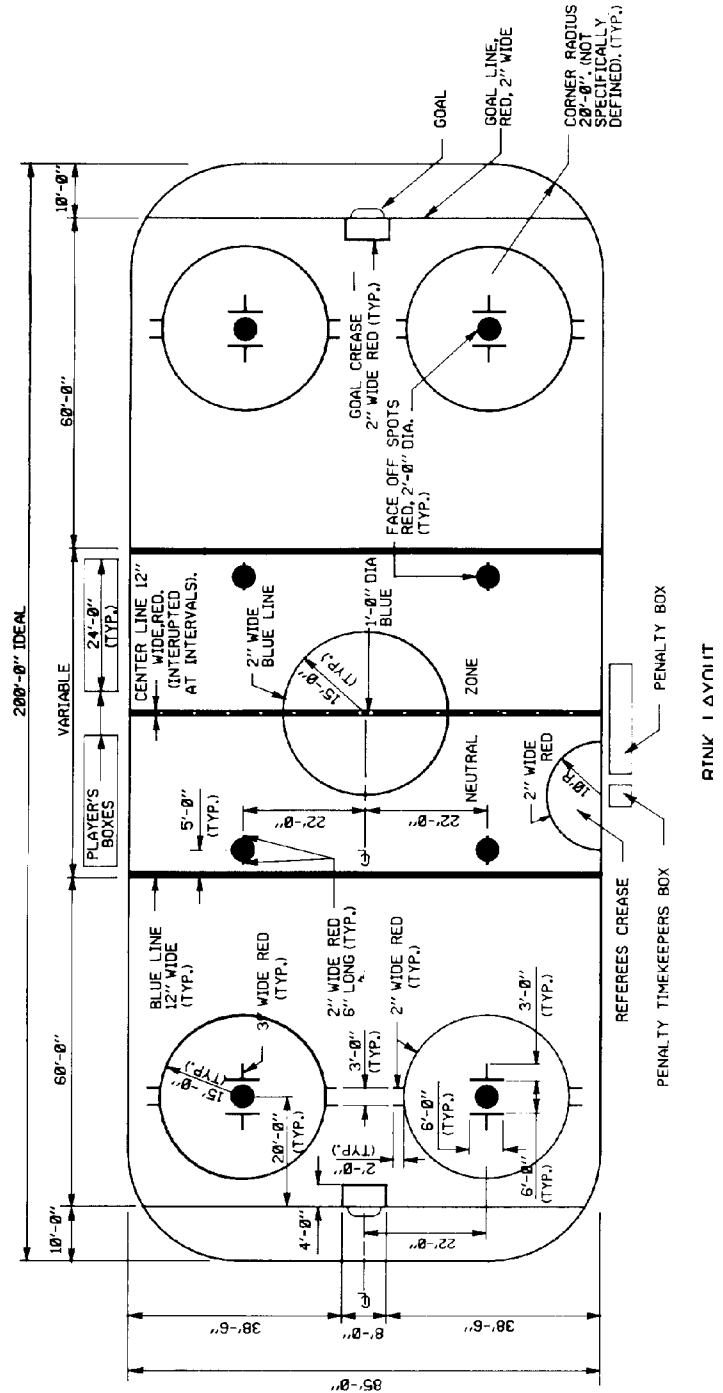

Figure A-12. Ice hockey.

A-13. Lawn bowling (see fig A-13)

- a. *Source of information.* American Lawn Bowls Association (ALBA).
- b. *Recommended area.* Square green with six rinks is 15,376 square feet (0.35 acre) minimum to 19,321 square feet (0.44 acre) maximum.
- c. *Size and dimension.* Rink length ranges from 120 feet 0 inch minimum to 132 feet 0 inch maximum on each side. Additional width of 2 feet 0 inch minimum to 3 feet 6 inches maximum is required on all sides for ditch and backslope. Rink width ranges from 14 feet 0 inch minimum to 19 feet 0 inch maximum.
- d. *Orientation.* Optional.
- e. *Surface and drainage.*
 - (1) Surface will be closely cropped bent grass or sand-clay. If grass surface is used, contact ALBA for specific information about construction and maintenance.
 - (2) Entire green will be level, with adequate subdrainage.
- f. *Special consideration.* Ditch: Depth ranges from minimum 2 inches to maximum 8 inch below surface of green. Width ranges from minimum 8 inches to maximum 15 inches.

NOTES:

- Side boundaries of rinks to be marked with 2" wide green linen tape attached with pins.
- The four corners of the rinks shall be indicated by pins driven flush with the face of the ban on each end.
- Center line of each rink shall be marked by pin or number panel.
- For surfacing details see figure G-5.

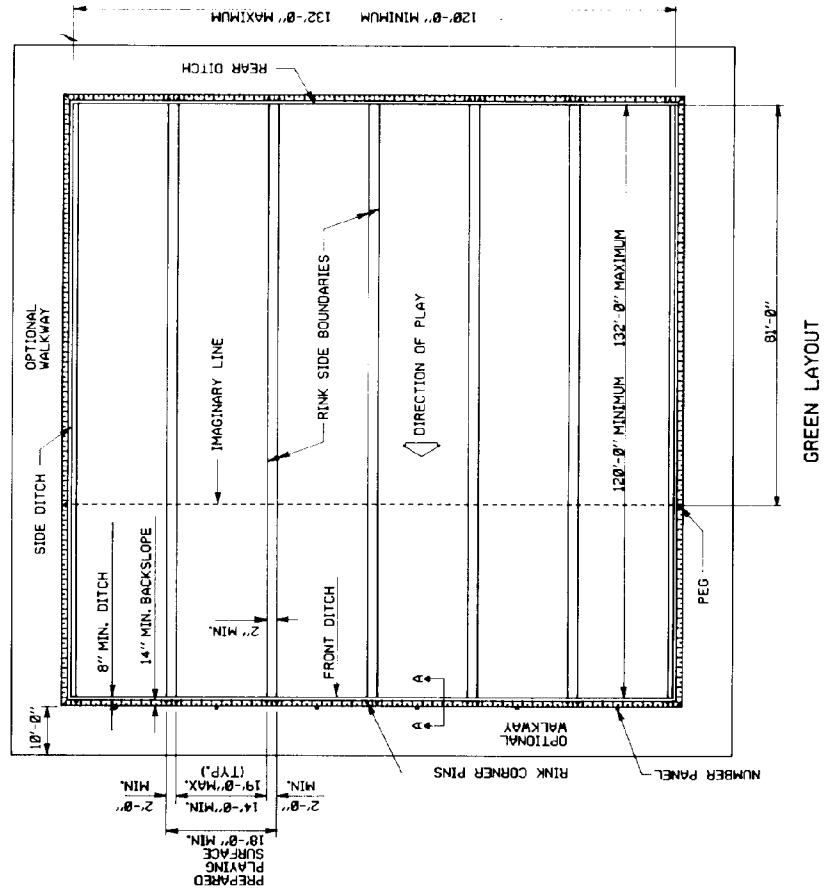
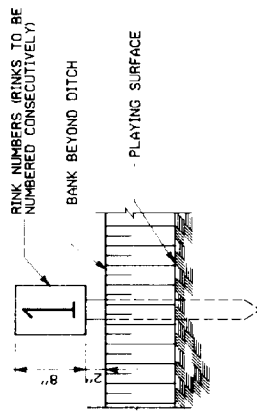

ELEVATION-RINK NUMBER PANEL

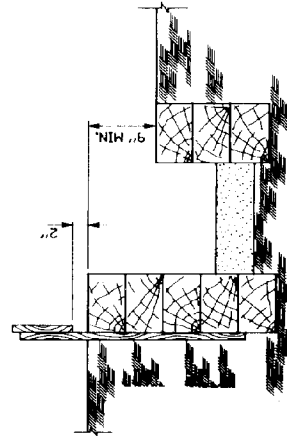
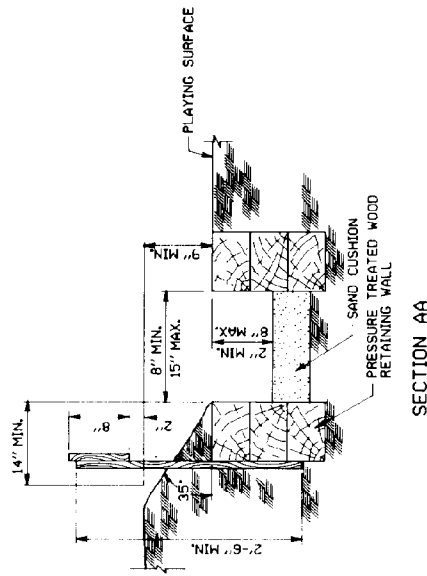

ALTERNATE SECTION AA
(See SECTION AA for additional labeling and dimensioning)

Figure A-13. Lawn bowling.

A-14. Roque (see fig A-14)

- a. *Source of information.* The American Roque League Incorporated (ARL).
- b. *Recommended area.* Ground space is 1,800 square feet minimum (0.04 acres), plus curb.
- c. *Size and dimension.* Playing court is 30 feet 0 inch wide by 60 feet 0 inch long.
- d. *Orientation.* Preferred orientation is for the long axis to be north-south.
- e. *Surface and drainage.*
 - (1) Surface is to be level and sand-clay mixture.
 - (2) Drainage is to be through perimeter system and/or through underdrains.
- f. *Special considerations.* Concrete curb is to be provided on all sides.

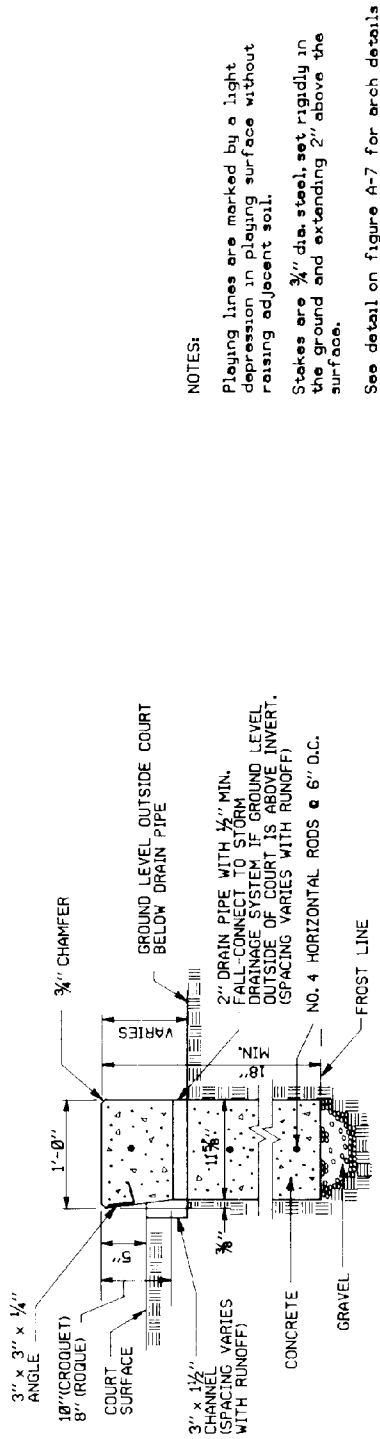

NOTES:

Playing lines are marked by a light depression in playing surface without raising adjacent soil.

Stakes are 3/4" dia. steel, set rigidly in the ground and extending 2" above the surface.

See detail on figure A-7 for arch details

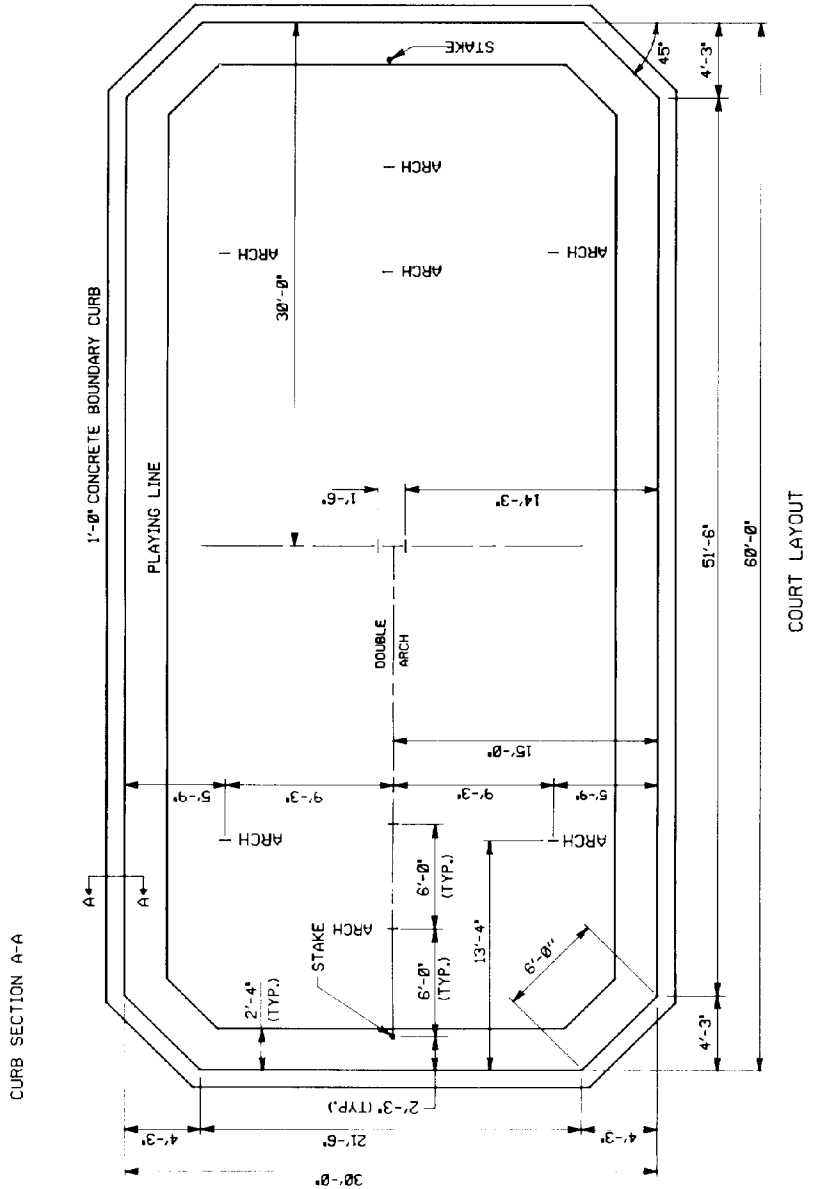

Figure A-14. Roque.

A-15. Shuffleboard (see fig A-15)

- a. *Source of information.* General Sportcraft Company, Ltd.
- b. *Recommended area.* Ground space is 312 square feet (0.01 acre) minimum.
- c. *Size and dimension.* Playing court is 6 feet 0 inch by 52 feet 0 inch plus a recommended minimum of 2 feet 0 inch on each side or 4 feet 0 inch between courts in battery.
- d. *Orientation.* Recommended orientation is for the long axis to be north-south.
- e. *Surface and drainage.*
 - (1) Surface is to be concrete with a burnished finish.
 - (2) Court surface is to be level with drainage away from the play surface on all sides.

NOTES:

- All dimensions are to centers of lines and to edge of court.
- Maximum line width $1\frac{1}{2}$ "', minimum $\frac{3}{4}$ "'.
- Lines and figures shall be marked with black shoe dye or black acrylic paint.
- Court to be constructed of concrete without expansion joints.
- A depressed alley at least 24" wide and not less than 4" deep at midcourt, should be constructed between courts and on the outside of end courts.
- The alley should slope 1" in the first 6' of the length of the alley from each base line, then slope to a minimum depth of 4" at midcourt where a suitable water drain should be provided.

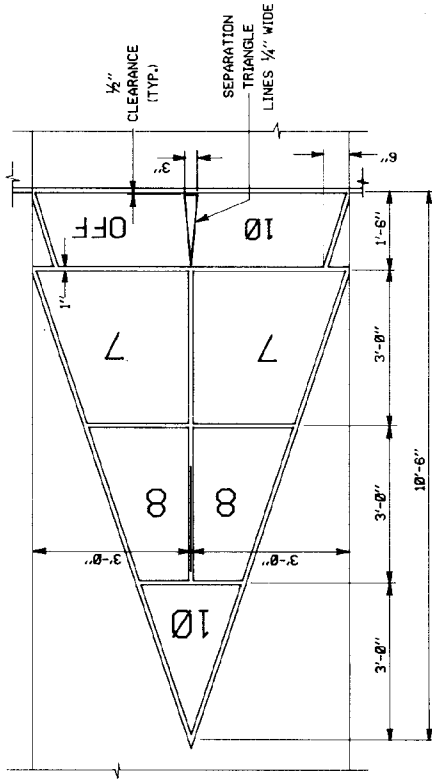

COURT MARKING DETAIL

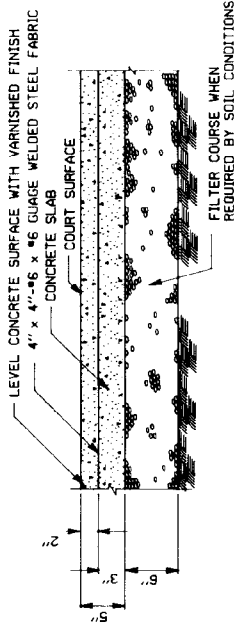

TYPICAL SECTION

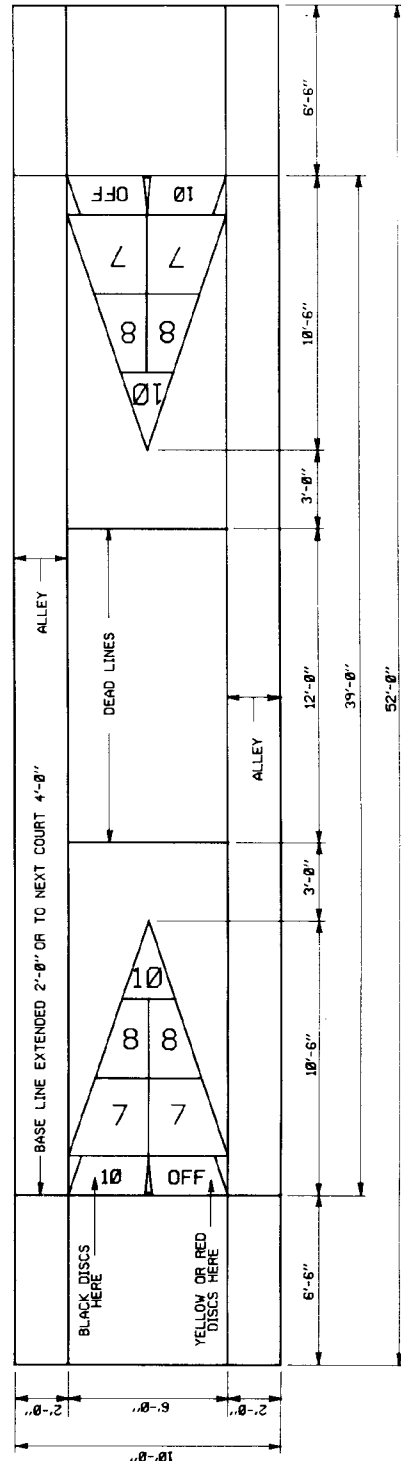

COURT LAYOUT

Figure A-15. Shuffleboard.

A-16. Deck tennis (see fig A-16)

- a. *Source of information.* General Sportcraft Company, Ltd.
- b. *Recommended area.* Ground space is 1,300 square feet (0.03 acre) including clear space.
- c. *Size and dimension.* Singles court is 12 feet 0 inch by 40 feet 0 inch. Doubles court is 18 feet 0 inch by 40 feet 0 inch. Additional paved area at least 4 feet 0 inch on sides and 5 feet 0 inch on ends is recommended for both.
- d. *Orientation.* Preferred orientation is for the long axis to be north-south.
- e. *Surface and drainage.*
 - (1) Surface is to be concrete or bituminous material with optional protective coating.
 - (2) Drainage is to be end to end, side to side, or corner to corner diagonally at a minimum slope of 1 inch in 10 feet (0.8 percent).
- f. *Special considerations.* Fencing: 10-foot high chain link fence is recommended on all sides of the court.

A-17. Paddle tennis (see fig A-17)

- a. *Source of information.* United States Paddle Tennis Association (USPTA).
- b. *Recommended area.* Ground space is 3,200 square feet (0.07 acre) minimum to edge of pavement.
- c. *Size and dimension.* Playing court is 20 feet 0 inch by 50 feet 0 inch plus a 15-foot minimum space on each end and a 10-foot minimum space on each side or between courts in battery.
- d. *Orientation.* Preferred orientation is for the long axis to be north-south.
- e. *Surface and drainage.*
 - (1) Surface is to be concrete or bituminous material with optional protective colorcoating.
 - (2) Drainage is to be end to end, side to side or corner to corner diagonally at a minimum slope of 1 inch in 10 feet (0.8 percent).
- f. *Special considerations.* Fencing: 10-foot high chain link fence is recommended on all sides of the court.

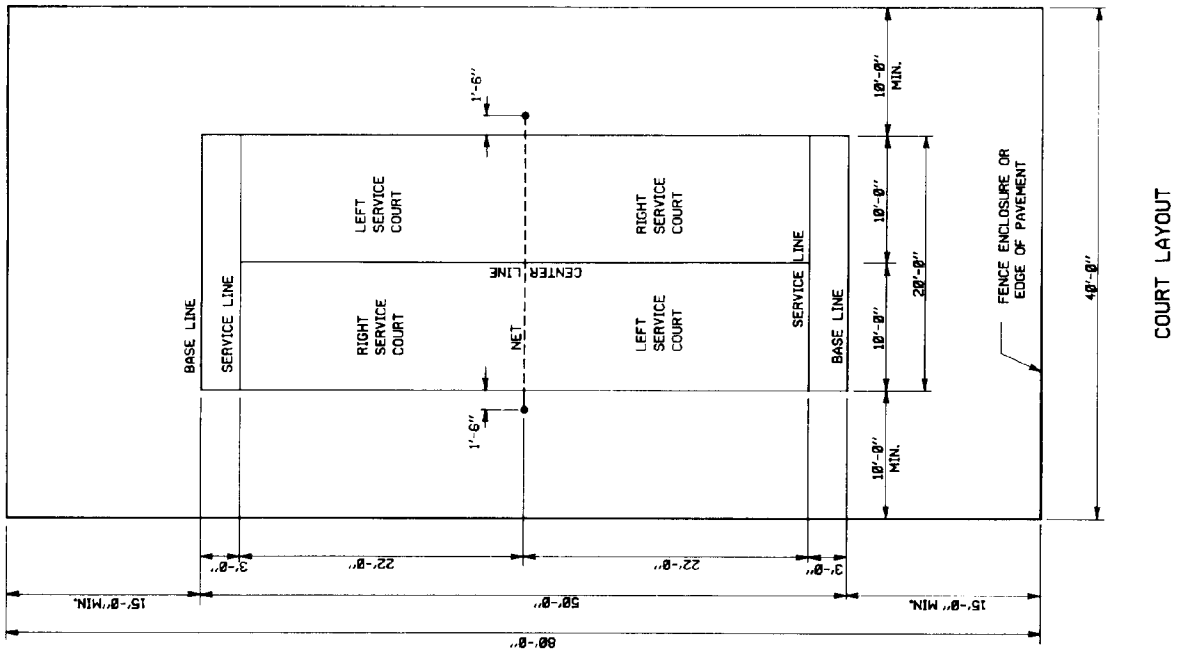

NOTES:

All measurements for court markings are to the outside of lines except for those involving the center service line, which is equally divided between right and left service court.

All court markings to be 2" wide.

For net post details see figure G-1 or G-2.

For surfacing details see figure G-5.

Manufacturers have combination tennis, volleyball, and badminton standards available.

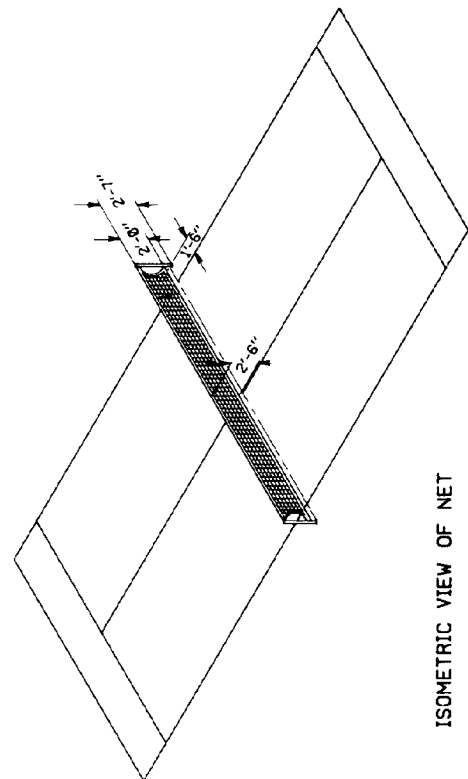

Figure A-17. Paddle tennis.

A-18. Platform tennis (see fig A-18)

- a. *Source of information.* American Platform Tennis Association (APTA).
- b. *Recommended area.* Ground space is 1,800 square feet (0.04 acre) to the playable perimeter fence.
- c. *Size and dimension.* Playing court is 20 feet 0 inch by 44 feet 0 inch plus an 8-foot 0-inch space on each end and a 5-foot 0-inch space on each side.
- d. *Orientation.* Preferred orientation is for the long axis to be north-south.
- e. *Surface and drainage.*
 - (1) Raised level platform is normally constructed of treated wood or aluminum superstructure with carriage set on concrete piers to permit construction on slopes.
 - (2) Drainage is provided by 1/4-inch space between 6-inch deck planks or channels. Snow removal is facilitated by hinged panels (snow gages) between posts around bottom of perimeter fence.
- f. *Special considerations.*
 - (1) Tension fencing must be provided on all sides of the court.
 - (2) Prefabricated courts are available from several manufacturers.

NOTES:

All measurements for court markings are to the outside of lines except for those involving the center service line, which is equally divided between right and left service court.

All court markings to be 2" wide.

For net post details see manufacturers' literature.

Net height to be 3'-1" at post and 2'-10" at center court.

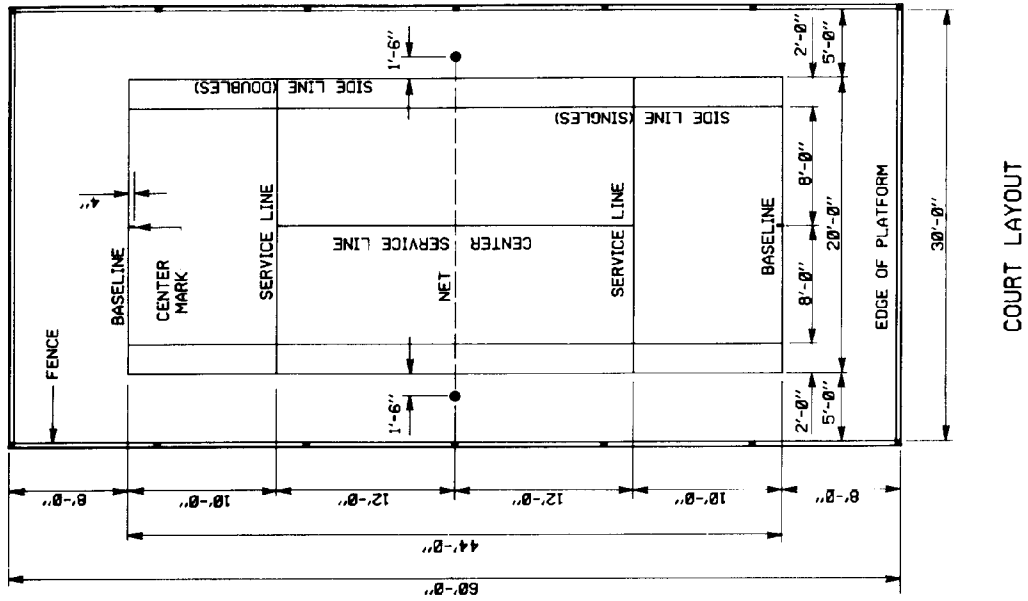

COURT LAYOUT

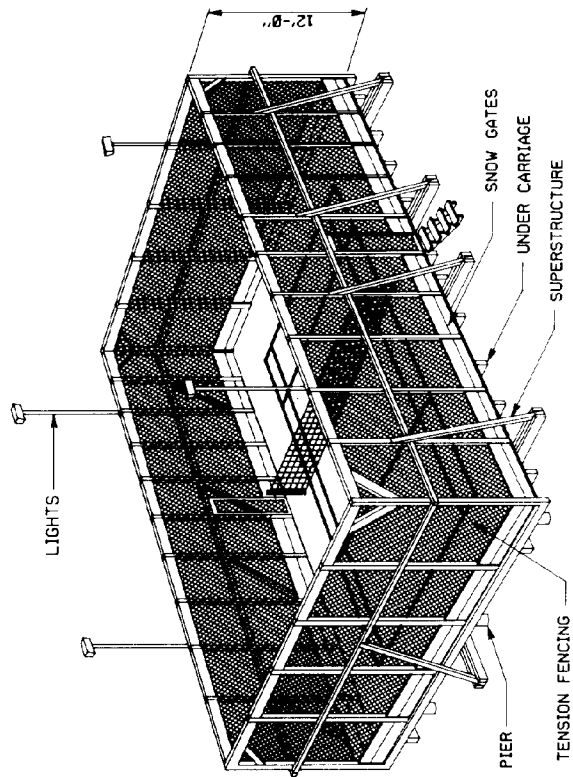

ISOMETRIC SHOWING FENCE (TYPICAL WOOD CONSTRUCTION)

Figure A-18. Platform tennis.

A-19. Tennis (see fig A-19)

- a. *Source of information.* United States Tennis Association (USTA).
- b. *Recommended area.* Ground space is 7,200 square feet (0.17 acre) minimum.
- c. *Size and dimension.* Playing court is 36 feet 0 inch by 78 feet 0 inch plus 12 feet 0 inch minimum clearance on both sides or between courts in battery and 21 feet 0 inch clearance on each end. Minimum distance between baselines of end-to-end courts will be 42 feet 0 inch.
- d. *Orientation of long axis is to be north-south.*
- e. *Surface and drainage.*
 - (1) Surface may be concrete, or bituminous material with specialized protective colorcoating, or sand-clay.
 - (2) Drainage may be from end to end, side to side, or corner to corner diagonally at a minimum slope of 1 inch in 10 feet (0.8 percent) for pavement and level for sand-clay with subdrainage.
- f. *Special considerations.* Fencing: Recommended 10-foot high chain link fence on all sides.

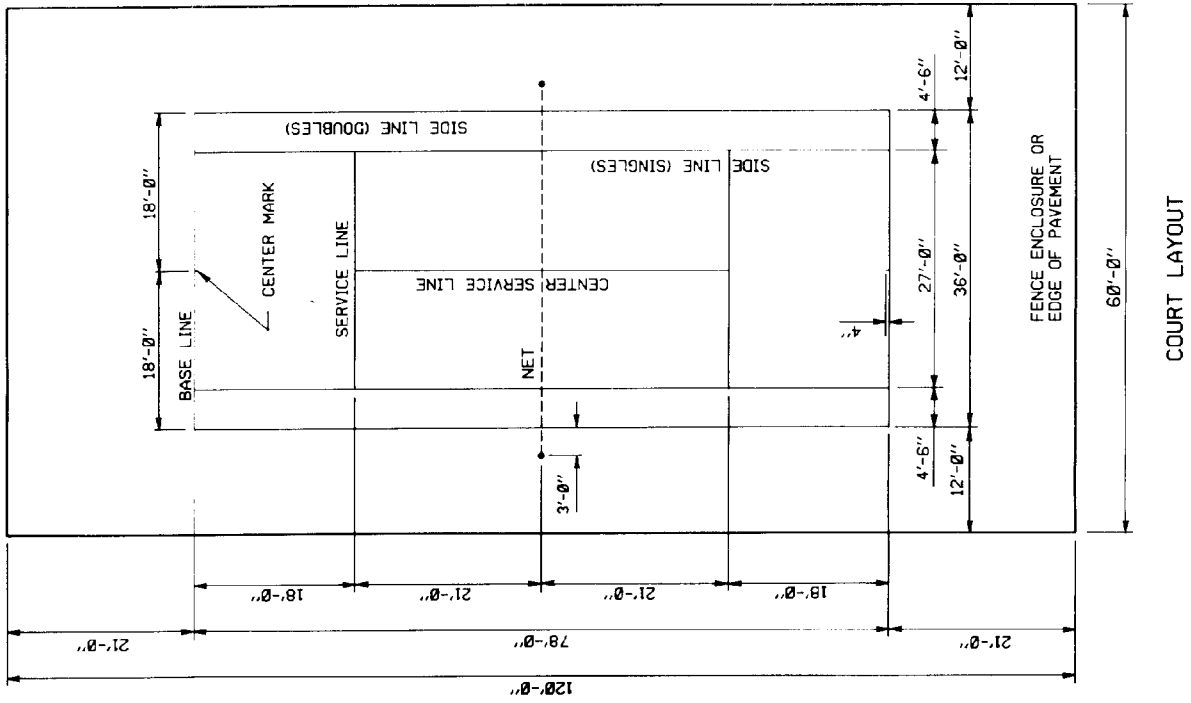

NOTES:

All measurements for court markings are to the outside of line except for those involving the center service line which is equally divided between the right and left service courts.

All court markings to be 2" wide.

For net post details see figure G-1 or G-2.

For surfacing details see figure G-5.

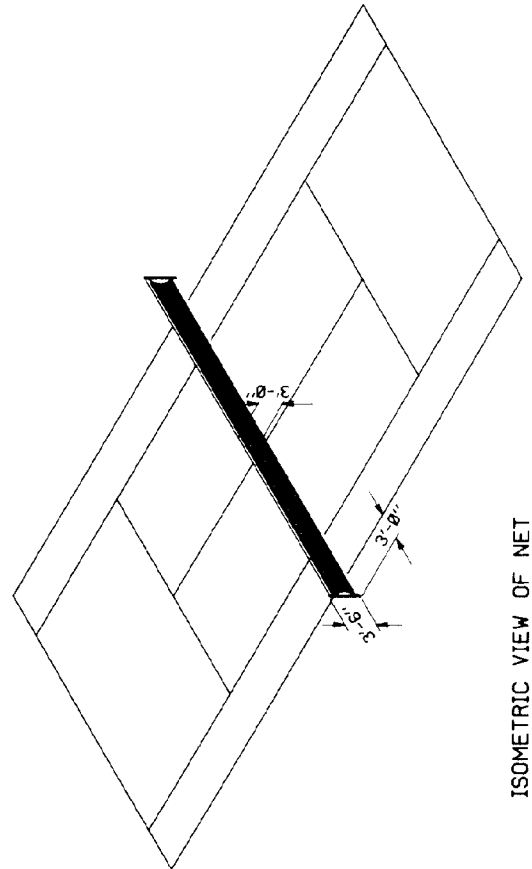

ISOMETRIC VIEW OF NET

Figure A-19. Tennis.

A-20. Tetherball (see figure A-20)

- a. *Source of information.* General Sportcraft Company, Ltd.
- b. *Recommended area.* Ground space is 314 square feet (0.01 acre) minimum to circumference of outer circle.
- c. *Size and dimension.* Playing court is a circle 20 feet 0 inch in diameter. Pole height is 10 feet.
- d. *Orientation.* Recommended axis through playing zone is north-south.
- e. *Surface and drainage.* Concrete or bituminous surface may be used for minimum maintenance, but a resilient synthetic surface or wood chips with adequate subdrainage is preferred for safety and comfort. Minimum slope is 1 inch in 10 feet (0.8 percent) for drainage in any direction.

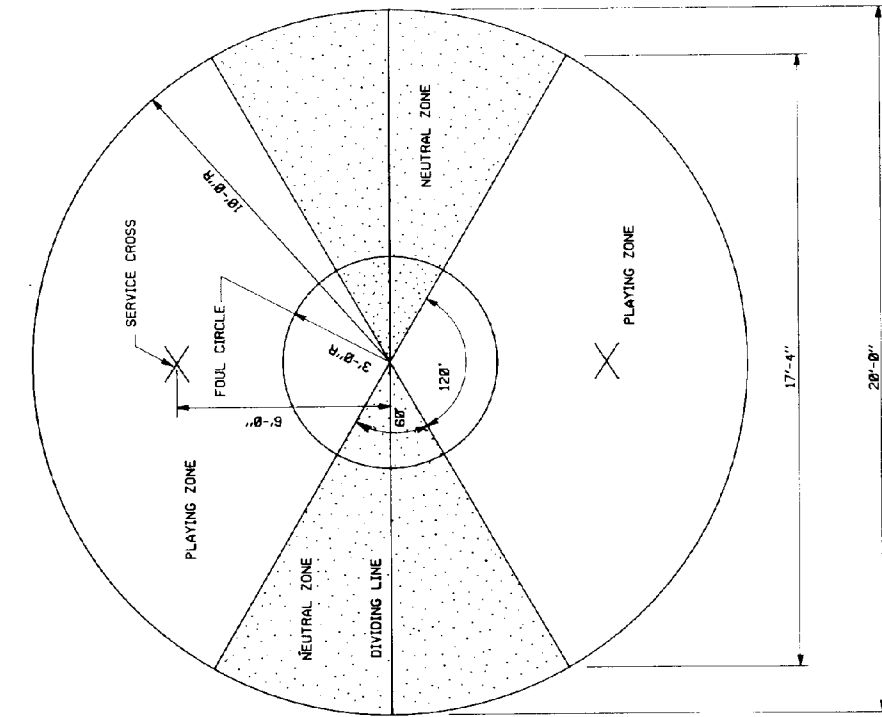

COURT LAYOUT

NOTES:

All measurements for court markings are to center of lines.

All court markings to be 2" wide.

If colorcoating is used, the neutral zones and the playing zones shall be of contrasting colors

For surfacing details see figure G-5.

For removable post detail see Figure G-2

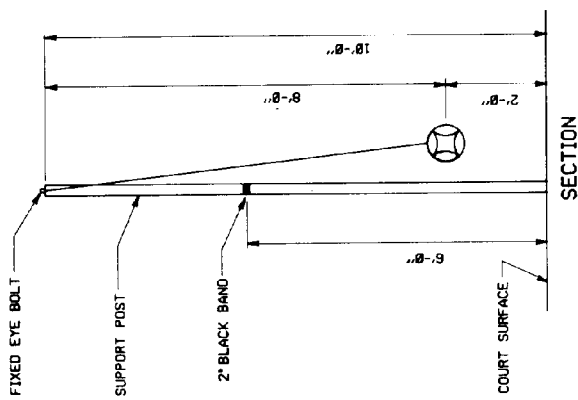

Figure A-20. Tetherball.

A-21. Volleyball (see fig A-21)

- a. *Source of information.* United States Volleyball Association (USVBA).
- b. *Recommended area.* Ground space is 3,935 square feet (0.9 acre).
- c. *Size and dimension.* Playing court is 29 feet 6 inch by 59 feet 0 inch plus 10-foot unobstructed space on all sides.
- d. *Orientation.* Preferred orientation is for the long axis to be north-south.
- e. *Surface and drainage.* Recommended surface for intensive use is to be bituminous material or concrete, but sand-clay or turf may be used for informal play. Drainage is to be end to end, side to side or corner to corner at a minimum slope of 1 inch in 10 feet (0.8 percent).

NOTES:

All measurements for court markings are to the outside of lines except for the center line.

All court markings to be 2" wide.

For surfacing details see figure G-5.

Net height at center to be: men 7'-11⁵/₈"; women 7'-4¹/₈"; Jr. high school boys 7'-4¹/₈"; girls 7'-2¹/₈"; elementary school boys and girls 6'-1".

Net height at post can exceed net height at center by no more than ³/₄".

For net and post details see figure G-1 or G-2.

Manufacturers have combination tennis, volleyball, and badminton standards available.

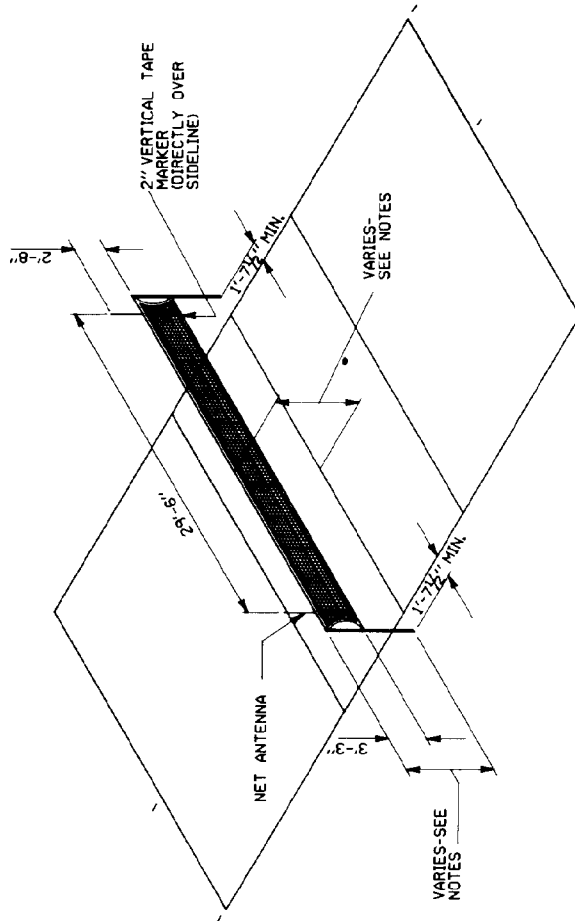
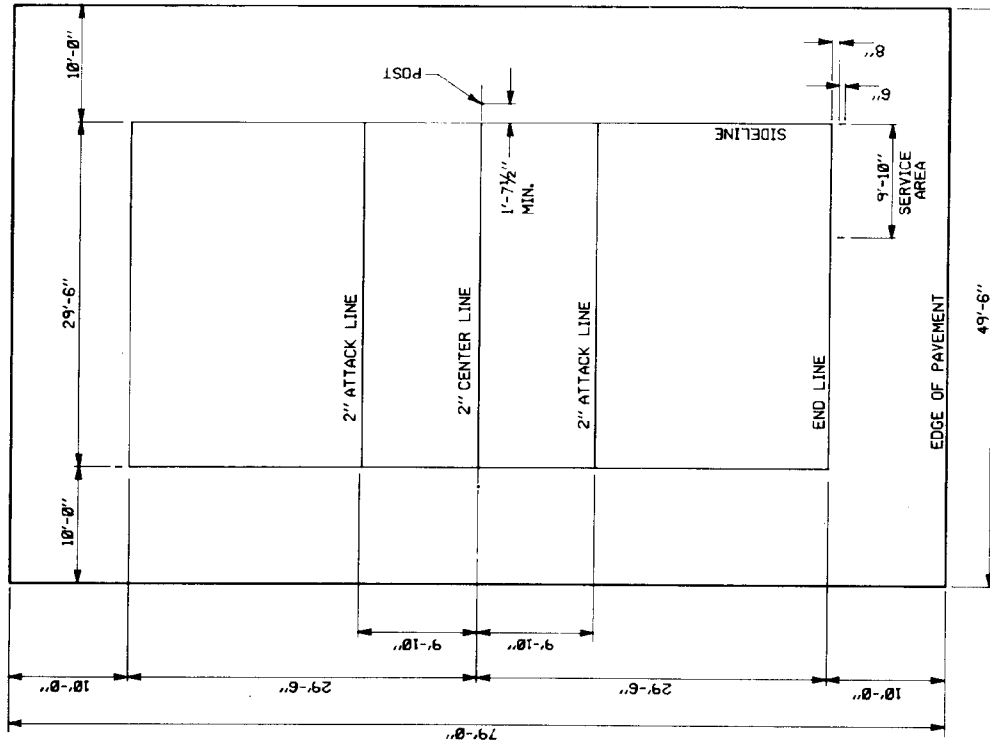

Figure A-21. Volleyball.

APPENDIX B

SPORTS FIELDS

B-1. Official baseball (including Babe Ruth and Senior League) (see fig B-1)

a. Source of information. The Official Playing Rules Committee, 1974. Babe Ruth Baseball, Little League Baseball, Inc.

b. Recommended area. Ground space is 3.0 to 3.5 acres minimum.

c. Size and dimensions. Baselines are 90 feet 0 inches. Pitching distance is 60 feet 6 inches. Pitchers mound is 10 inches above the level of home plate. Distance down foul lines is 325 feet minimum, 350 preferred. Outfield distance to center field is 400 plus feet. For Senior League Baseball the recommended distance from plate to outfield fence at all points is 300 plus feet. All distances are from home plate.

d. Orientation. Optimum orientation is to locate home plate so that the pitcher is throwing across the sun and the batter is not facing it. The line from home plate through the pitchers mound to second base should run east-northeast.

e. Surface and drainage. Surface is to be turf. Infield may be skinned, and shall be graded so that the baselines and home plate are level.

f. Special considerations. Backstop is to be provided at a minimum distance of 40 feet or preferably 60 feet behind home plate.

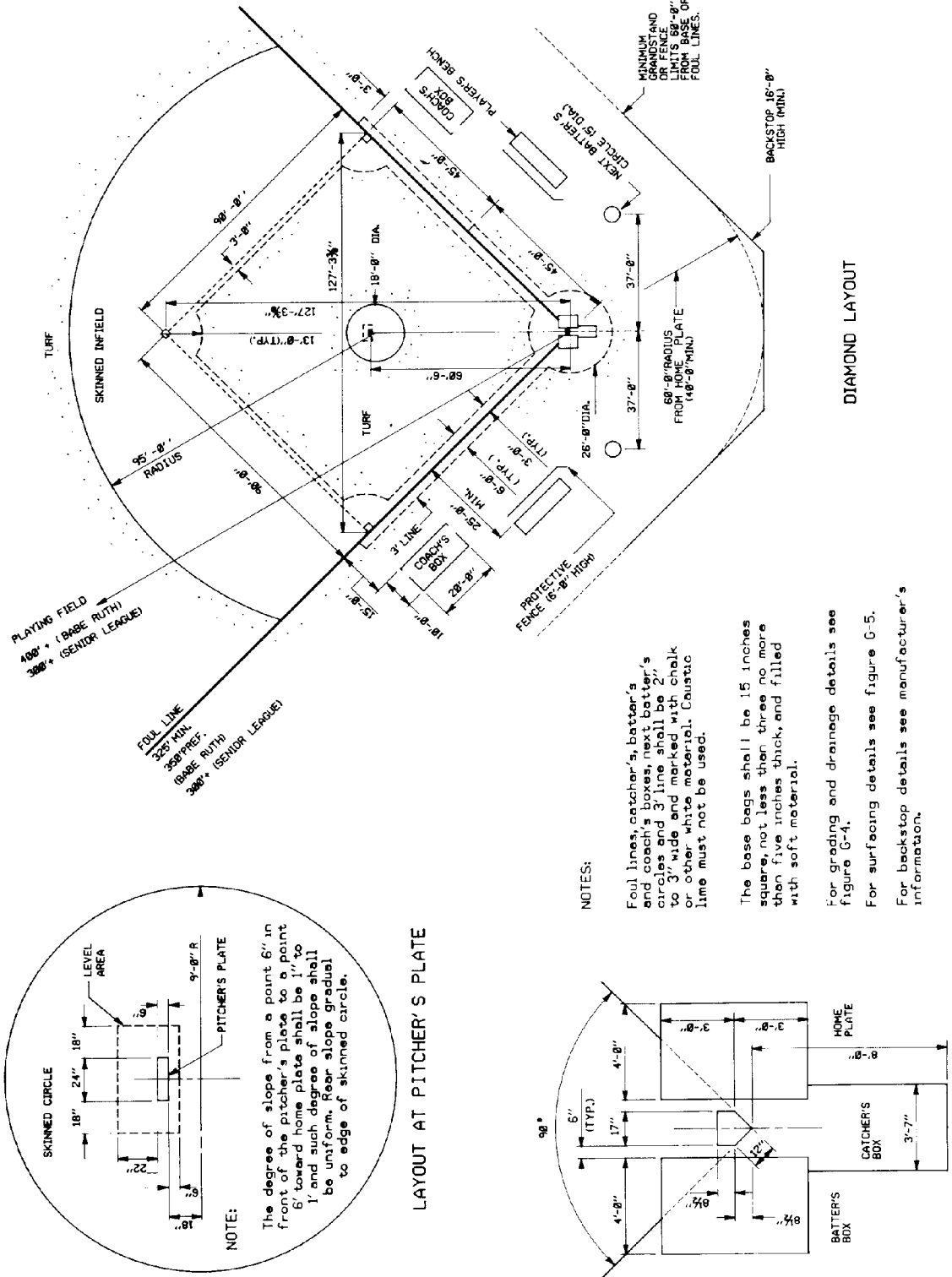

DIAMOND LAYOUT

NOTES:

Foul lines, catcher's, batter's and coach's boxes, next batter's circles and 3' line shall be 2" to 3" wide and marked with chalk or other white material. Caustic lime must not be used.

The base bags shall be 15 inches square, not less than three no more than five inches thick, and filled with soft material.

For grading and drainage details see figure G-4.

For surfacing details see figure G-5.

For backstop details see manufacturer's information.

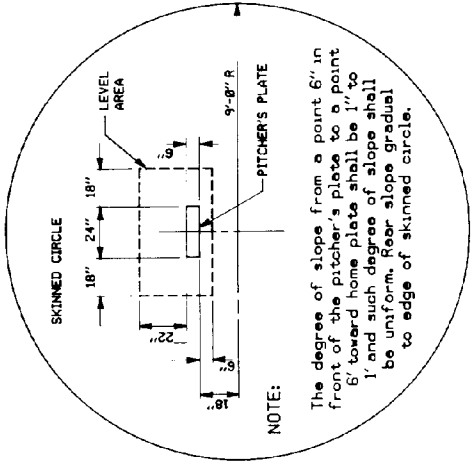

LAYOUT AT PITCHER'S PLATE

NOTE:

The degree of slope from a point 6" in front of the pitcher's plate to a point 6' toward home plate shall be 1" to 1' and such degree of slope shall be uniform. Rear slope gradual to edge of skinned circle.

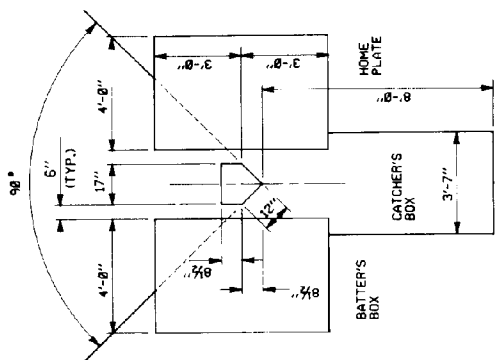

LAYOUT AT HOME PLATE

Figure B-1. Baseball—official, Babe Ruth, and Senior League.

B-2. Bronco League baseball (9-12 yrs.) (see fig B-2)

- a. *Source of information.* Pony Baseball, Inc.
- b. *Recommended area.* Ground space is 1.0 acre minimum.
- c. *Size and dimension.* Baselines are 70 feet 0 inch. Pitching distance is 48 feet 0 inch. Pitcher's plate is 6 inches above the level of home plate. Distance down foul line is 200 feet. Outfield distance to pocket in center field is 250 feet.
- d. *Orientation.* Optimum orientation is to locate home plate so that the pitcher is throwing across the sun and the batter is not facing it. The line from home plate through the pitcher's mound and second base should run east-northeast.
- e. *Surface and drainage.* Surface is to be turf. Infield may be skinned, and shall be graded so that the baselines and home plate are level.
- f. *Special considerations.* Backstop is to be provided at a recommended distance of 30 feet behind home plate.

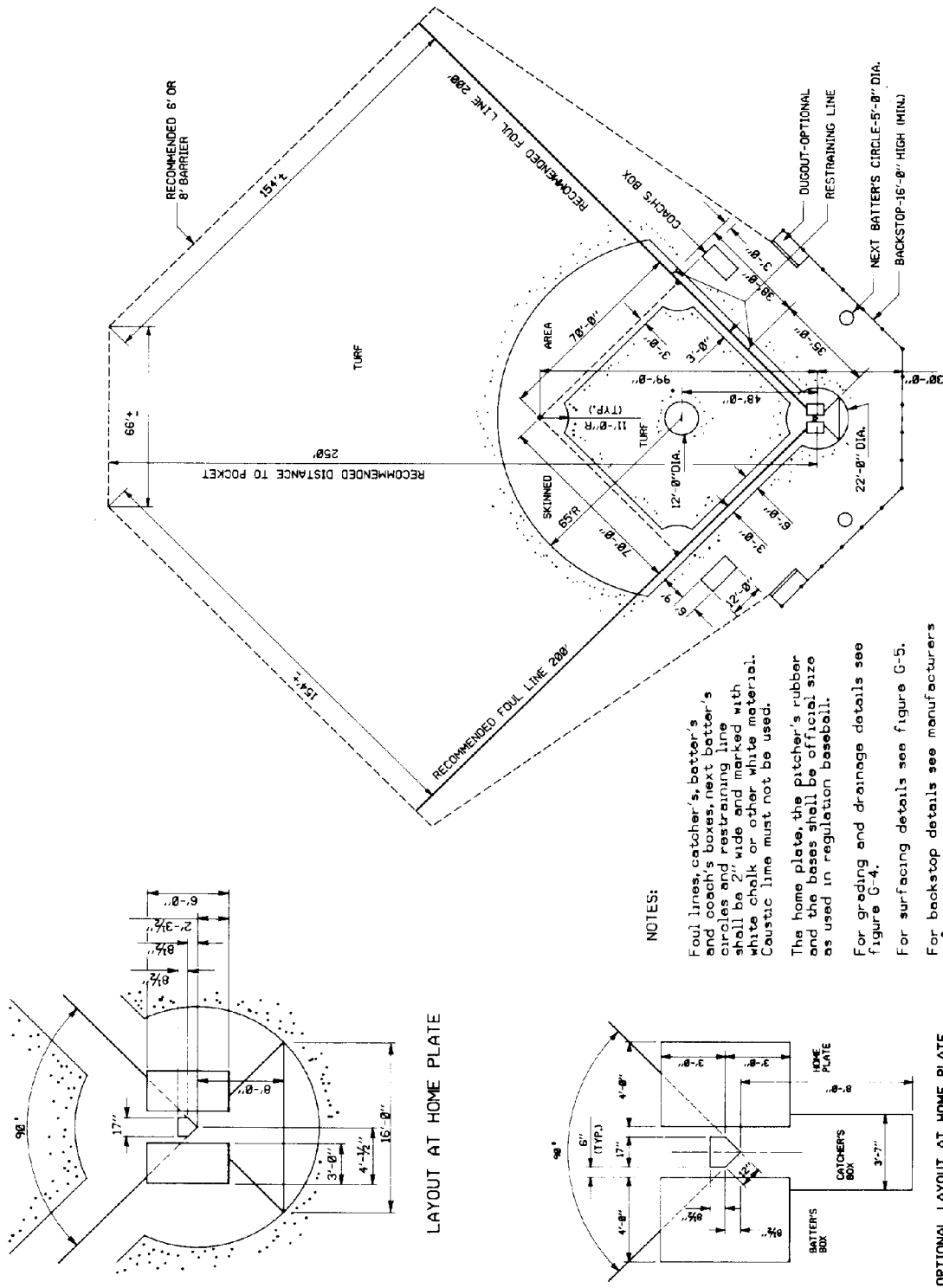

PLAYING FIELD LAYOUT

Figure B-2. Bronco League baseball (9-12 yrs.).

B-3. Pony League baseball (13-14 yrs.) (see fig B-3).

- a. *Source of information.* Pony League, Boy's Baseball, Inc.
- b. *Recommended area.* Ground space is 2.0 acres minimum.
- c. *Size and dimension.* Baselines are 80 feet 0 inch. Pitching distance is 54 feet 0 inch. Pitcher's plate is 8 inches above the level of home plate. Distance down foul line is 250 feet. Outfield distance to pocket in center field is 300 feet.
- d. *Orientation.* Optimum orientation is to locate home plate so that the pitcher is throwing across the sun and the batter is not facing it. The line from home plate through the pitcher's mound and second base should run east-northeast.
- e. *Surface and drainage.* Surface is to be turf. Infield may be skinned, and shall be graded so that the baselines and home plate are level.
- f. *Special consideration.* Backstop is to be provided at a recommended distance of 40 feet behind home plate.

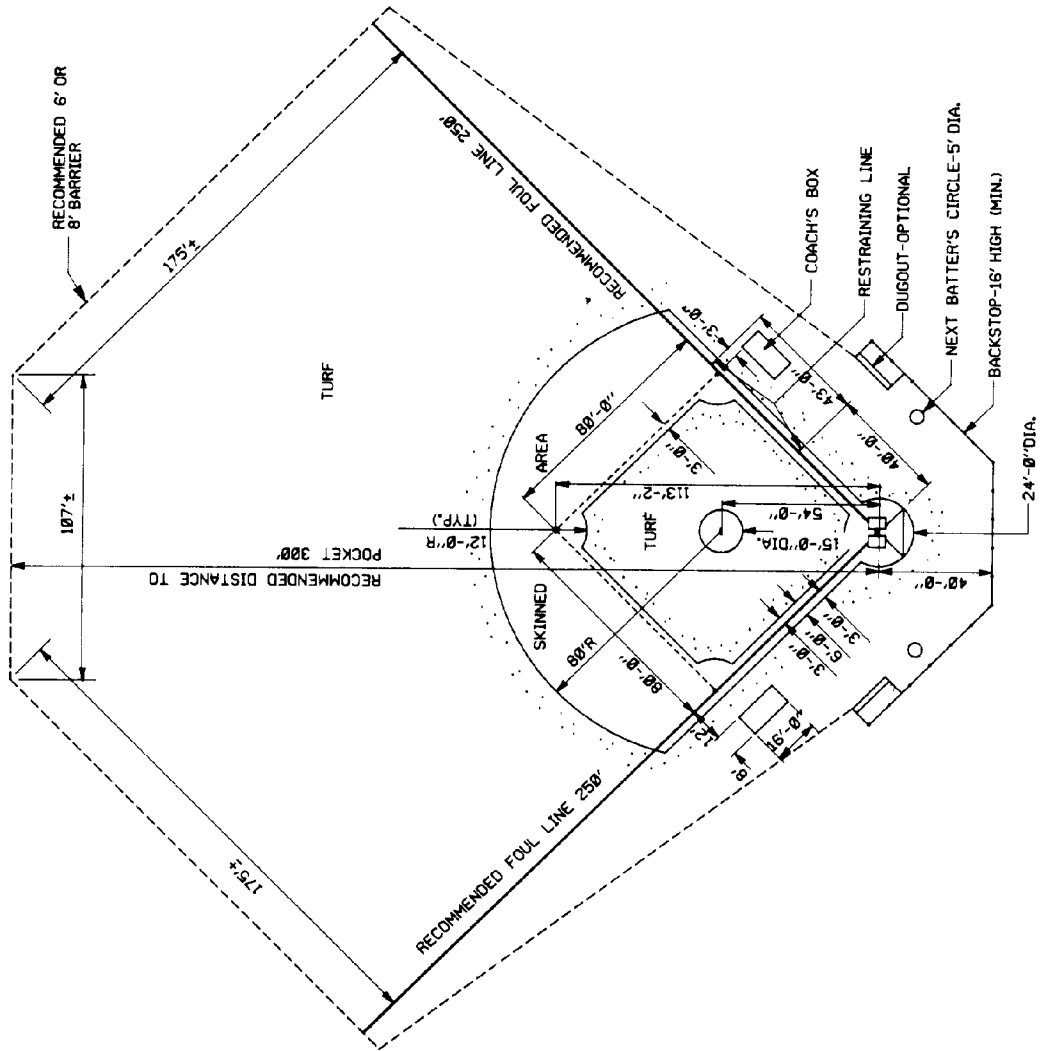

PLAYING FIELD LAYOUT

NOTES:

- Foul lines, catcher's, batter's and coach's boxes, next batter's circles and restraining line shall be 2" wide and marked with white chalk or other white material. Caustic lime must not be used.
- The home plate, the pitcher's rubber and the bases shall be official size as used in regulation baseball.
- For layouts at home plate see figure B-2.
- For grading and drainage details see figure G-4.
- For surfacing details see figure G-5.
- For backstop details see manufacturers information.

Figure B-3. Pony League baseball (13-14 yrs.).

B-4. Colt League baseball (15-16 yrs.) (see fig B-4)

- a. *Source of information.* Pony Baseball, Inc.
- b. *Recommended area.* Ground space is 3.0 acres minimum.
- c. *Size and dimension.* Baselines are 90 feet 0 inch. Pitching distance is 60 feet 6 inches. Pitcher's plate is 10 inches above the level of home plate. Distance down foul line is 300 feet. Outfield distance to pocket in center field is 350 feet.
- d. *Orientation.* Optimum orientation is to locate home plate so that the pitcher is throwing across the sun and the batter is not facing it. The line from home plate through the pitcher's mound and second base should run east-northeast.
- e. *Surface and drainage.* Surface is to be turf. Infield may be skinned, and shall be graded so that the baselines and home plate are level.
- f. *Special considerations.* Backstop is to be provided at a recommended distance of 50 feet behind home plate.

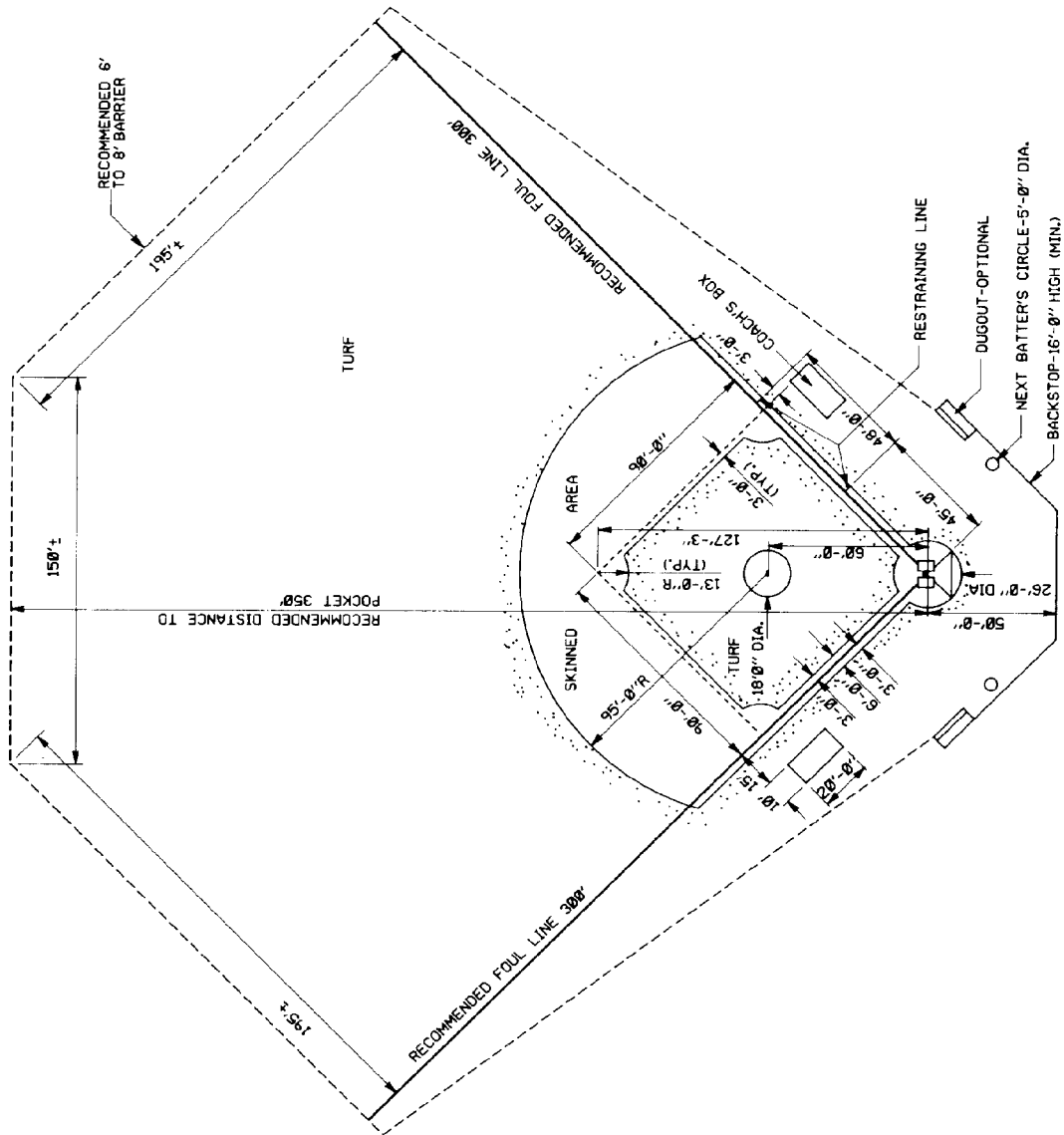

NOTES:

Foul lines, catcher's, batter's and coach's boxes, next batter's circles and restraining line shall be 2" wide and marked with white chalk or other white material. Caustic lime must not be used.

The home plate, the pitcher's rubber and the bases shall be official size as used in regulation baseball.

For layouts at home plate see figure B-2.

For grading and drainage details see figure G-4.

For surfacing details see figure G-5.

For backstop details see manufacturers information.

Figure B-4. Colt League baseball (15-16 yrs.).

B-5. Little League baseball (9-12 yrs.) (see fig B-5)

- a. *Source of information.* Little League Baseball, Inc.
- b. *Recommended area.* Ground space is 1.2 acres minimum.
- c. *Size and dimension.* Baselines are 60 feet 0 inch. Pitching distance is 46 feet 0 inch. Pitcher's plate is 6 inches above the level of home plate. Distance down foul line is 200 feet. Outfield distance to pocket in center field is 200 feet to 250 feet optional.
- d. *Orientation.* Optimum orientation is to locate home plate so that the pitcher is throwing across the sun and the batter is not facing it. The line from home plate through the pitcher's mound and second base should run east-northeast.
- e. *Surface and drainage.* Surface is to be turf. Infield may be skinned, and shall be graded so that the baselines and home plate are level.
- f. *Special considerations.* Backstop is to be provided at a recommended minimum distance of 25 feet behind home plate.

B-6. Softball 12 inch (fast and slow pitch) (see fig B-6)

- a. *Source of information.* Amateur Softball Association of America (ASA).
- b. *Recommended area.* Ground space is 40,000 square feet (0.9 acres) to 90,000 square feet (2.0 acres).
- c. *Size and dimension.* Field size varies depending on player's age group (see table on figure B-6).
- d. *Orientation.* Optimum orientation is to locate home plate so that the pitcher is throwing across the sun and the batter is not facing it.
- e. *Surface and drainage.* Surface is to be turf. Infield may be skinned. The infield shall be graded so that the baselines and home plate are level.
- f. *Special considerations.* Backstop is to be located at a minimum distance of 25 feet behind home plate.

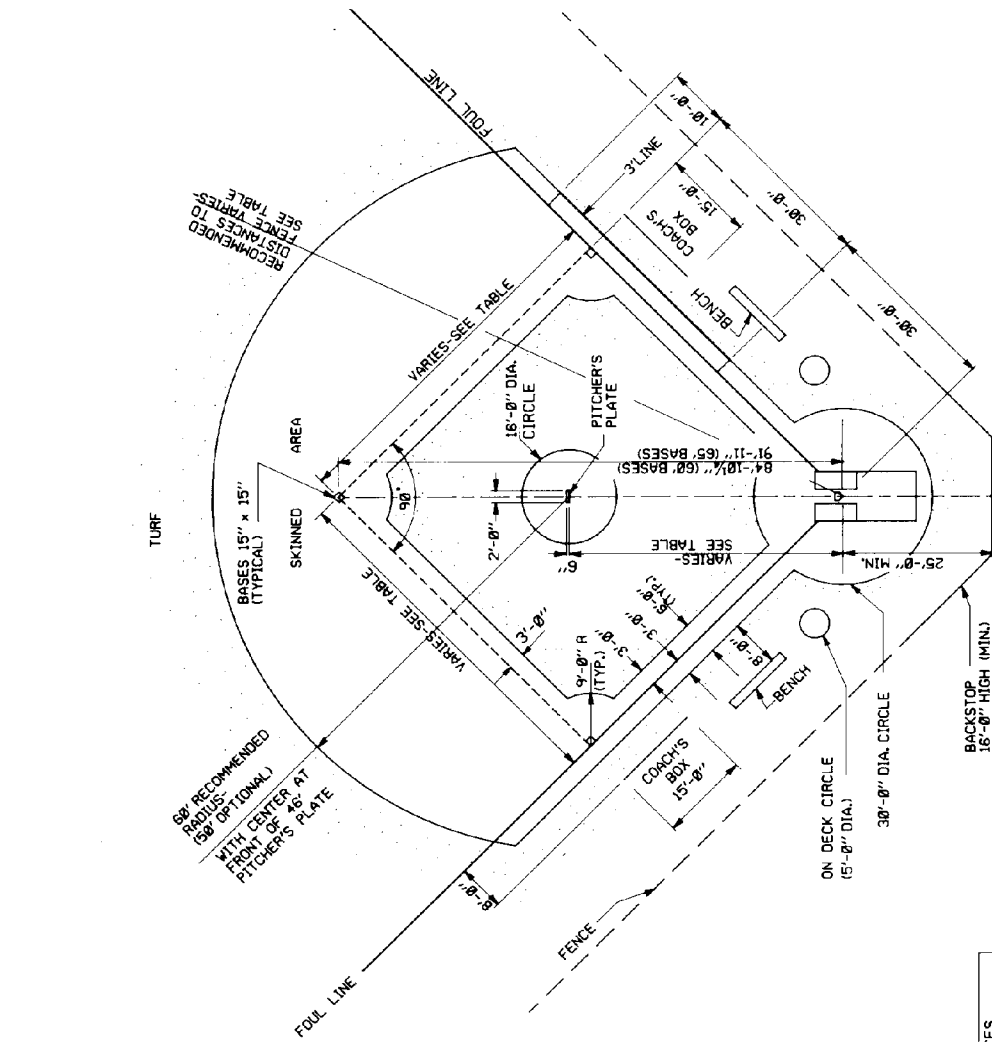

DIAMOND LAYOUT

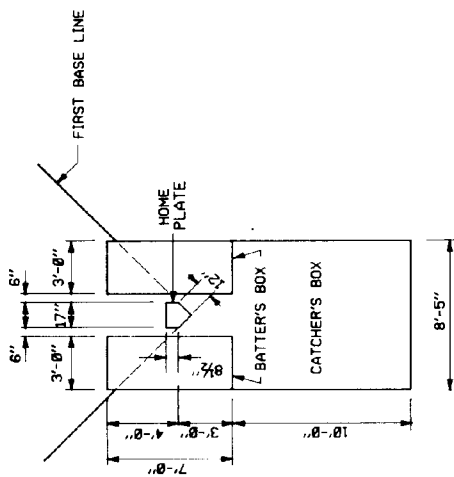

LAYOUT AT HOME PLATE

NOTES:

Foul lines, catcher's, batter's and coach's boxes, and 3' lines are 2" to 3" chalk lines.

For backstop details see manufacturer's information.

For grading and drainage details see figure G-4.

For surfacing details see figure G-5.

TABLE OF DIMENSIONS

DIMENSION	BASES		PITCHING		FENCES	
	SLOW	FAST	SLOW	FAST	SLOW	FAST
FEMALE	60'	60'	46'	40'	250'	200'
MALE	65'	60'	46'	46'	300'	300'
GIRLS (16-18)	60'	60'	46'	40'	225'-250'	225'-250'
BOYS (16-18)	65'	60'	46'	46'	275'-300'	275'-300'
GIRLS (13-15)	60'	60'	40'	40'	175'-200'	175'-200'
BOYS (13-15)	60'	60'	46'	46'	225'-250'	175'-200'
GIRLS (12 & UNDER)	60'	60'	35'	35'	175'-200'	175'-200'
BOYS (12 & UNDER)	60'	60'	40'	40'	175'-200'	175'-200'

Figure B-6. Softball 12 inch (fast and slow pitch).

B-7. Softball 16 inch (slow pitch) (see fig B-7)

- a. *Source of information.* Amateur Softball Association of America (ASA).
- b. *Recommended area.* Ground space is 50,625 square feet (1.2 acres) to 75,625 feet (1.7 acres).
- c. *Size and dimension.* Baselines are 55 feet 0 inch for men and women. Pitching distance is 38 feet 0 inch for men and women. Playing field radius from home plate between foul lines is 250 feet for men, 200 feet for women.
- d. *Orientation.* Optimum orientation is to locate home plate so that the pitcher is throwing across the sun and the batter is not facing it.
- e. *Surface and drainage.* Surface is to be turf. Infield may be skinned. The infield shall be graded so that the baselines and home plate are level.
- f. *Special considerations.* Backstop is to be located at a minimum distance of 25 feet behind homeplate.

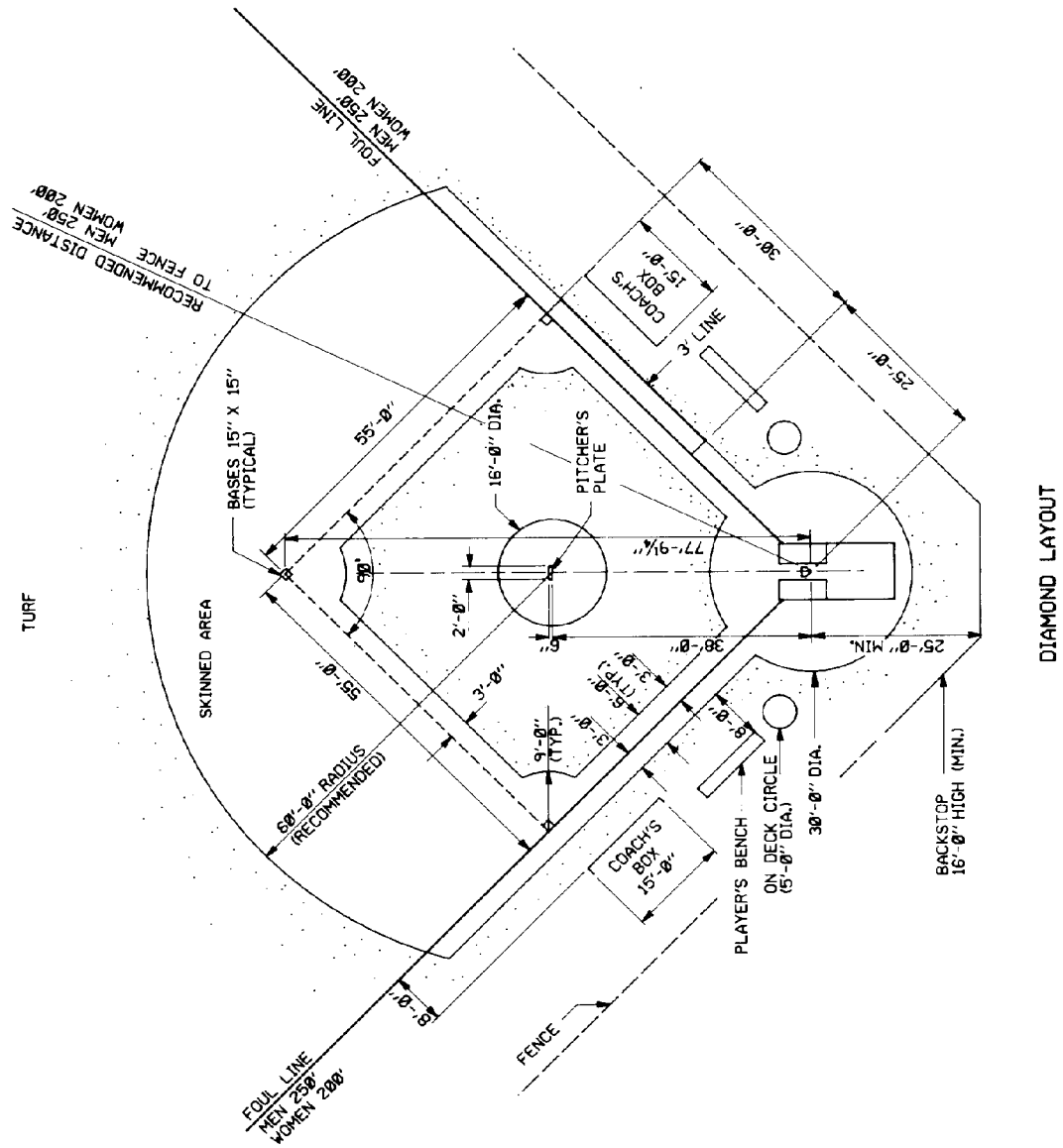

For notes and "Layout At Home Plate" see figure B-6.

Figure B-7. Softball 16 inch (slow pitch).

B-8. 11-man football (NCAA), Pop Warner Junior League football (see fig B-8)

a. *Source of information.* National Collegiate Athletic Association, (NCAA), Pop Warner Junior League Football.

b. *Recommended area.* Ground space is 70,700 square feet (1.6 acres) minimum.

c. *Size and dimension.* Playing field width is 160 feet 0 inch. Length is 260 feet 0 inch. Additional area required is 12 feet 0 inch minimum unobstructed space on all sides.

d. *Orientation.* Preferred orientation is for the long axis to be northwest-southeast to suit the angle of the sun in the fall playing season, or north-south for longer periods.

e. *Surface and drainage.*

(2) Preferred grading is a longitudinal crown with a 1 percent slope from center to each side and adequate subdrainage.

(3) Grading may be from side to side or corner to corner diagonally if conditions do not permit the preferred grading.

f. *Special consideration.* Goal posts are to be provided at each end of the playing field. Pylons are to be provided as required by rules.

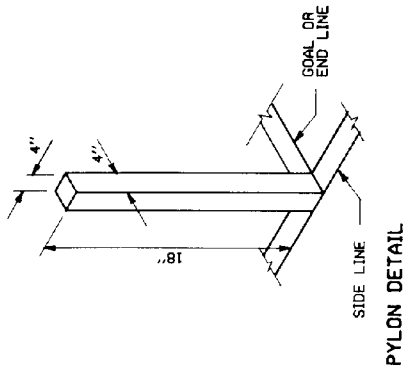

NOTES:

- All measurements shall be made from the inside edge of lines marking boundaries.
- All field dimension lines shown must be marked 4" in width with a white, nontoxic material which is not injurious to the eyes or skin.
- If cross hatching in end zone is white, it shall be no closer than four feet to the boundary lines.
- Pylon to be constructed of soft flexible material, red or orange in color.
- For goal post construction details see figure G-3.
- For grading and drainage details see figure G-4.
- For surfacing details see figure G-5.

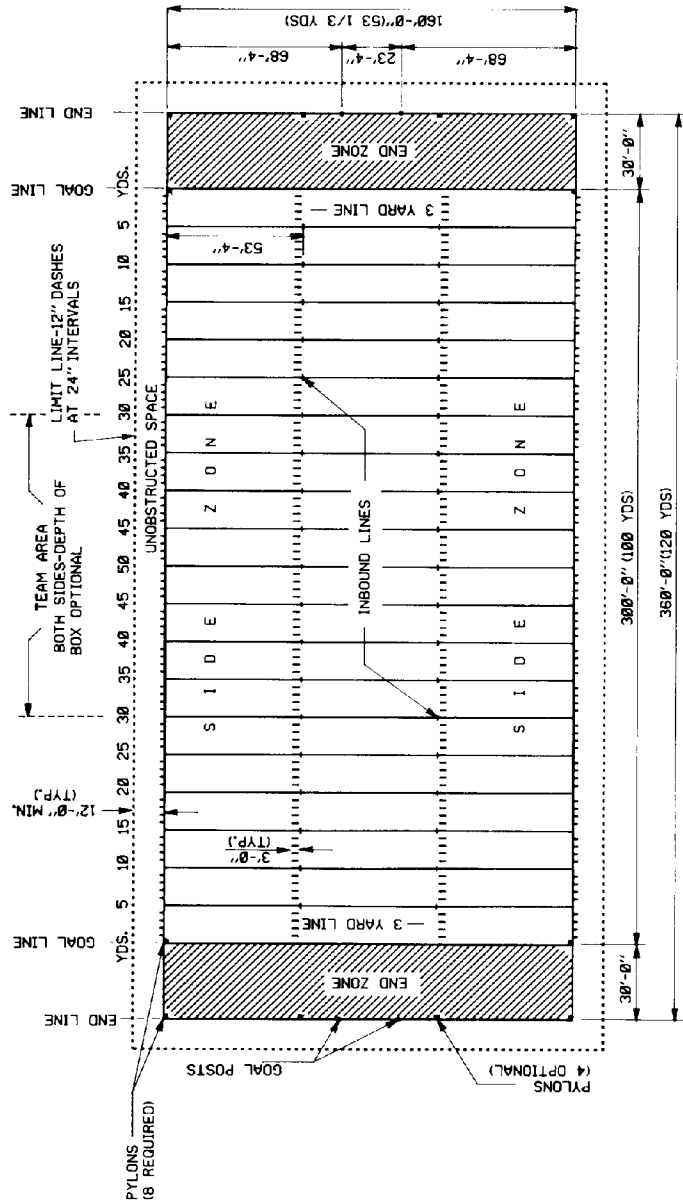

Figure B-8. 11-man football, (NCAA), Pop Warner Junior League football.

B-9. Touch and flag football (see fig B-9)

- a. *Source of information.* National Touch and Flag Football Rules, The Athletic Institute.
- b. *Recommended area.* Ground space is 41,200 square feet (.94 acre) minimum.
- c. *Size and dimension.* Playing field width is 120 feet 0 inch. Length is 300 feet 0 inch. Additional area recommended is 6 feet 0 inch minimum unobstructed space on all sides.
- d. *Orientation.* Preferred orientation is for the long axis to be northwest-southeast to suit the angle of the sun in the fall playing season, or north-south for longer periods.
- e. *Surface and drainage.*
 - (1) Surface is to be turf.
 - (2) Preferred grading is a longitudinal crown with a 1 percent slope from center to each side and adequate subdrainage.
 - (3) Grading may be from side to side or corner to corner diagonally if conditions do not permit the preferred grading.
- f. *Special considerations.* Goal posts are to be provided at each end of the playing field. Pylons are to be provided as required by rules.

NOTES:

All measurements shall be made from the inside edge of lines marking boundaries.

All field dimension lines shown must be marked 4" in width with a white, nontoxic material which is not injurious to the eyes or skin.

If cross hatching in end zone is white, it shall be no closer than four feet to the boundary lines.

Pylon to be constructed of soft flexible material, red or orange in color.

When teams are composed of more than 7 players, a field 360'-0" (120 yds.) long with five 60'-0" (20 yds.) zones and two 30'-0" (10 yds.) end zones is recommended.

For goal post construction details see figure G-3.

For grading and drainage details see figure G-4.

For surfacing details see figure G-5.

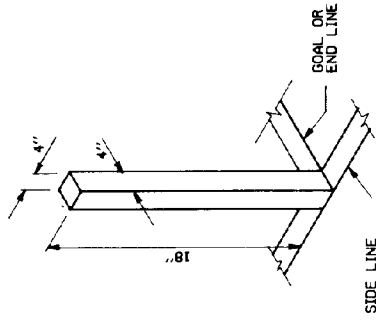

PYLON DETAIL

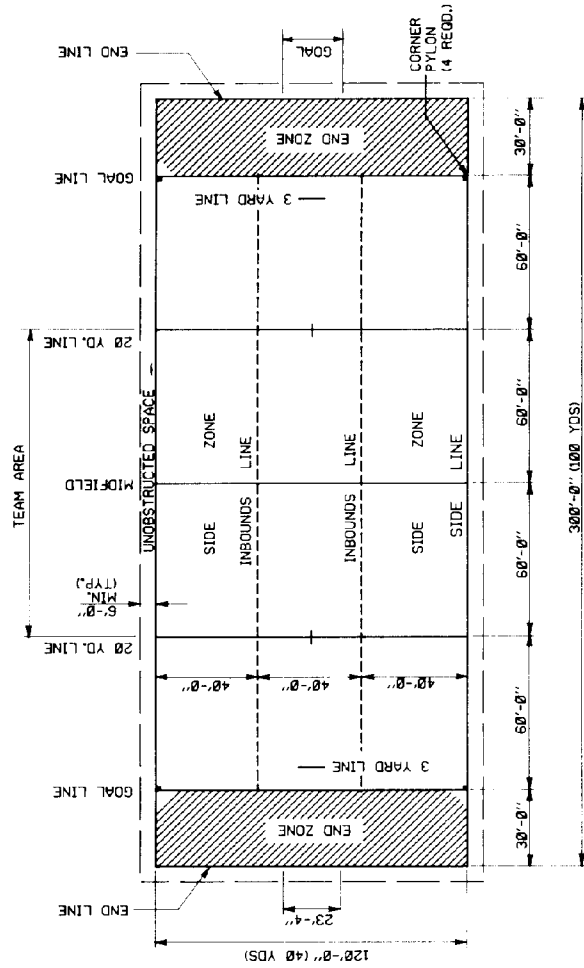

PLAYING FIELD LAYOUT

Figure B-9. Touch and flag football.

B-10. Lacrosse (men's) (see fig B-10)

- a. *Source of information.* National Collegiate Athletic Association (NCAA).
- b. *Recommended area.* Ground space is 63,000 square feet (1.4 acres) to 81,400 square feet (1.9 acres).
- c. *Size and dimension.* Playing field width ranges from 160 feet 0 inch to 180 feet 0 inch. Length is 330 feet 0 inch. Additional area recommended is 10 feet 0 inch minimum unobstructed space around entire perimeter of field with 5 feet 0 inch or 6 feet 0 inch high barrier fence, or 20 feet 0 inch without fence.
- d. *Orientation.* Preferred orientation is for the long axis to be northwest-southeast to suit the angle of the sun in the fall playing season, or north-south for longer periods.
- e. *Surface and drainage.*
 - (1) Surface is to be turf.
 - (2) Preferred grading is a longitudinal crown with a 1 percent slope from center to each side and adequate subdrainage.
 - (3) Grading may be from side to side or corner to corner diagonally if conditions do not permit the preferred grading.

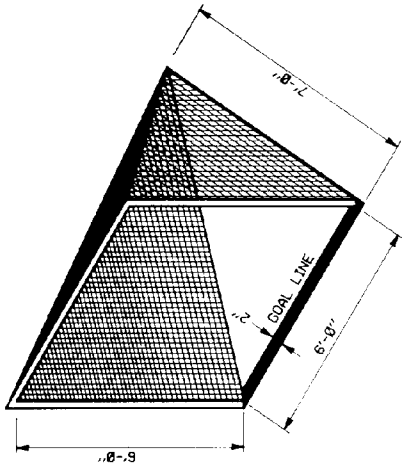

GOAL NOTES:

- Goal net should be cord netting with openings of not more than 1 1/2".
- Bottom of net must be held close to the ground with pegs or staples.
- Posts to be pipe, painted orange and secured to the ground.

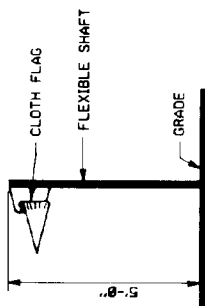

FLAG DETAIL

DETAIL OF GOAL

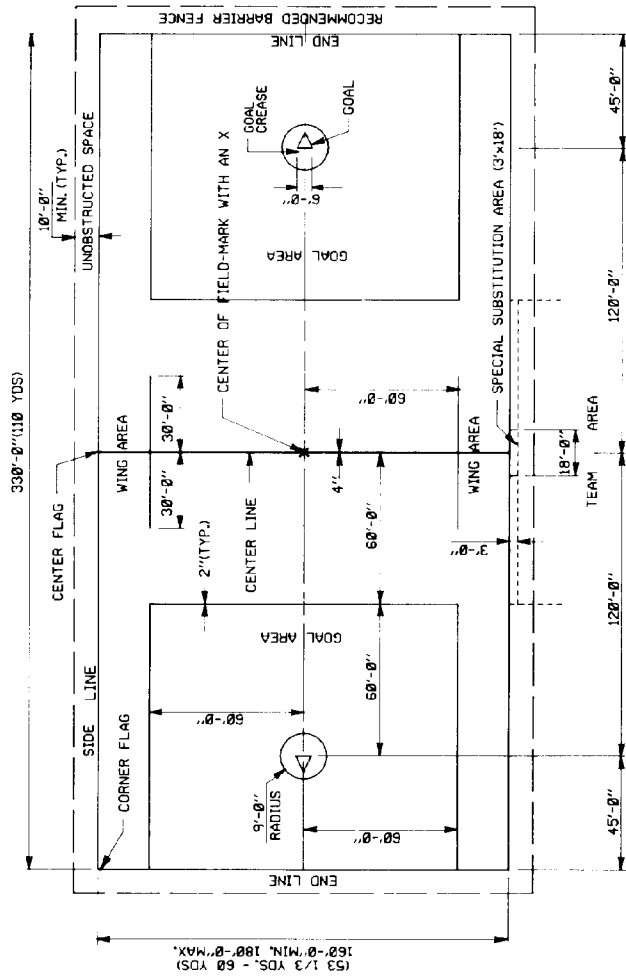

PLAYING FIELD LAYOUT

NOTES:

- Lines must be marked with a white non-toxic material which is not injurious to the eyes or skin.
- All lines shall be 2" wide except the center or offside line which should be 4" wide.
- All dimensions are to inside of lines except at center line.
- Flexible flag markers shall be placed at the four corners of the field and at each end of the center line.
- For grading and drainage details see figure G-4.
- For surfacing details see figure G-5.

Figure B-10. Lacrosse (men's).

B-11. Lacrosse (women's) (see fig B-11)

- a. *Source of information.* National Association for Girls and Women in Sport (NAG WS).
- b. *Recommended area.* Ground space is optional 69,300 square feet (1.6 acres) to 75,600 square feet (1.7 acres).
- c. *Size and dimension.* Playing field minimum width is 210 feet 0 inch. Length ranges from 330 feet 0 inch to 360 feet 0 inch. As in the original Indian game, there are no definite boundaries or shape for the field of play, but before a match the officials decide on the boundaries and declare specified obstructions out of bounds.
- d. *Orientation.* Preferred orientation is for the long axis to be northwest-southeast to suit the angle of the sun in the fall playing season, or north-south for longer periods.
- e. *Surface and drainage.*
 - (1) Surface is to be turf.
 - (2) Preferred grading is a longitudinal crown with a 1 percent slope from center to each side with adequate subdrainage.
 - (3) Grading may be from side to side or corner to corner diagonally if conditions do not permit the preferred grading.

B-12. Soccer (men's and boy's) (see fig B-12)

- a. *Source of information.* United States Soccer Federation (USSF).
- b. *Recommended area.* Ground space is 75,250 square feet (1.7 acres) to 93,100 square feet (2.1 acres).
- c. *Size and dimension.* Playing field width ranges from 150 feet 0 inch to 300 feet 0 inch. Length ranges from 300 feet 0 inch to 390 feet 0 inch. Additional area recommended is 10 feet 0 inch minimum unobstructed space on all sides.
- d. *Orientation.* Preferred orientation is for the long axis to be northwest-southeast to suit the angle of the sun in the fall playing season, or north-south for longer periods.
- e. *Surface and drainage.*
 - (1) Surface is to be turf.
 - (2) Preferred grading is a longitudinal crown with a 1 percent slope from center to each side and adequate subdrainage. Grading may be from side to side or corner to corner diagonally if conditions do not permit the preferred grading.

GOAL NOTES:

Goal posts to be pressure treated with paintable, oil-borne preservative and painted above ground with three coats of white lead and oil.

The goalposts and crossbar shall present a flat surface to the playing field, not less than four inches nor more than five inches in width.

Nets shall be attached to the posts, crossbar and ground behind the goal.

The top of the net must extend backward 2'-0" level with the crossbar.

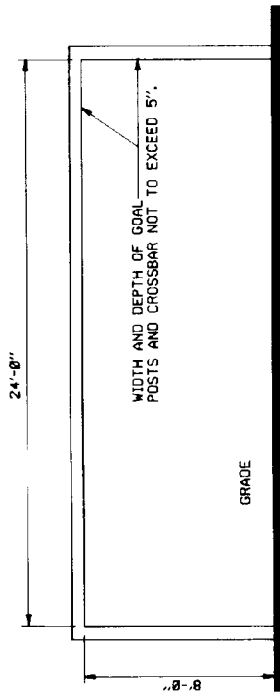

GOAL POSTS

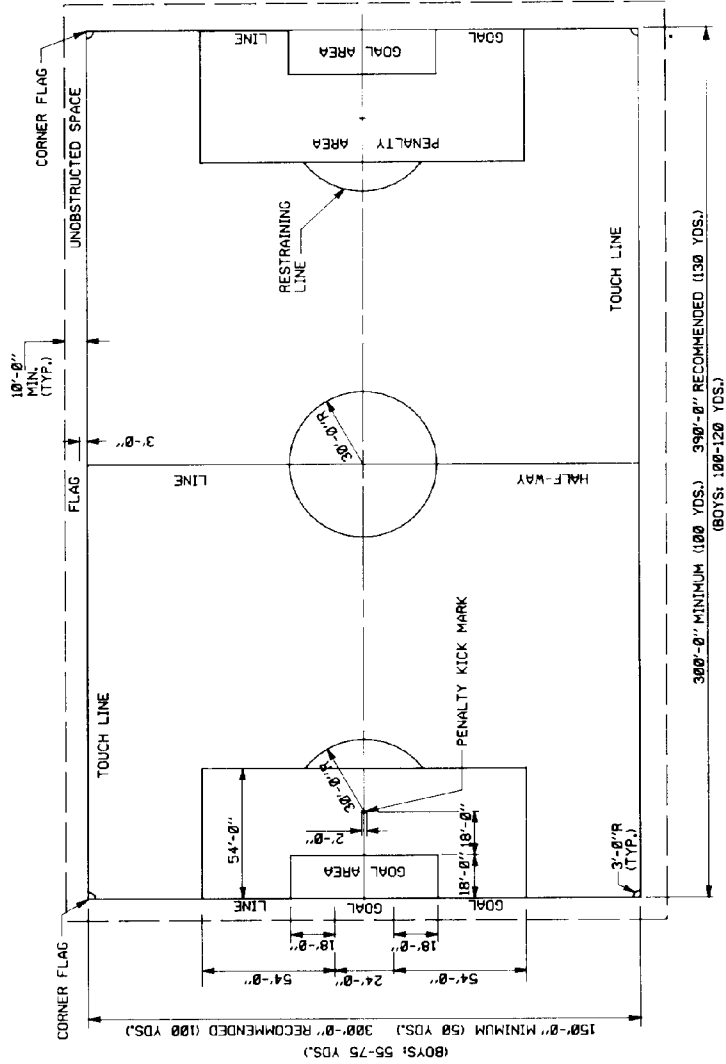

NOTES:

All dimensions are to the inside edge of lines.

All lines shall be 2" wide and marked with a white, non-toxic material which is not injurious to the eyes or skin.

For flag detail see figure B-10.

For grading and drainage details see figure G-4.

For surfacing details see figure G-5.

PLAYING FIELD LAYOUT

Figure B-12. Soccer (men's and boy's)

B-13. Soccer (women's and girl's) (see fig B-13)

- a. *Source of information.* United States Soccer Federation (USSF).
- b. *Recommended area.* Ground space is 72,250 square feet (1.7 acre) to 93,100 square feet (2.1 acres).
- c. *Size and dimension.* Playing field width is 195 feet 0 inch to 225 feet 0 inch. Length is 330 feet 0 inch to 360 feet 0 inch. Additional area recommended is 15 feet 0 inch minimum unobstructed space on all sides.
- d. *Orientation.* Preferred orientation is for the long axis to be northwest-southeast to suit the angle of the sun in the playing season, or north-south for longer periods.
- e. *Surface and drainage.*
 - (1) Surface is to be turf.
 - (2) Preferred grading is a longitudinal crown with a 1 percent slope from center to each side and adequate underdrainage.
 - (3) Grading may be from side to side or corner to corner diagonally if conditions do not permit the preferred grading.

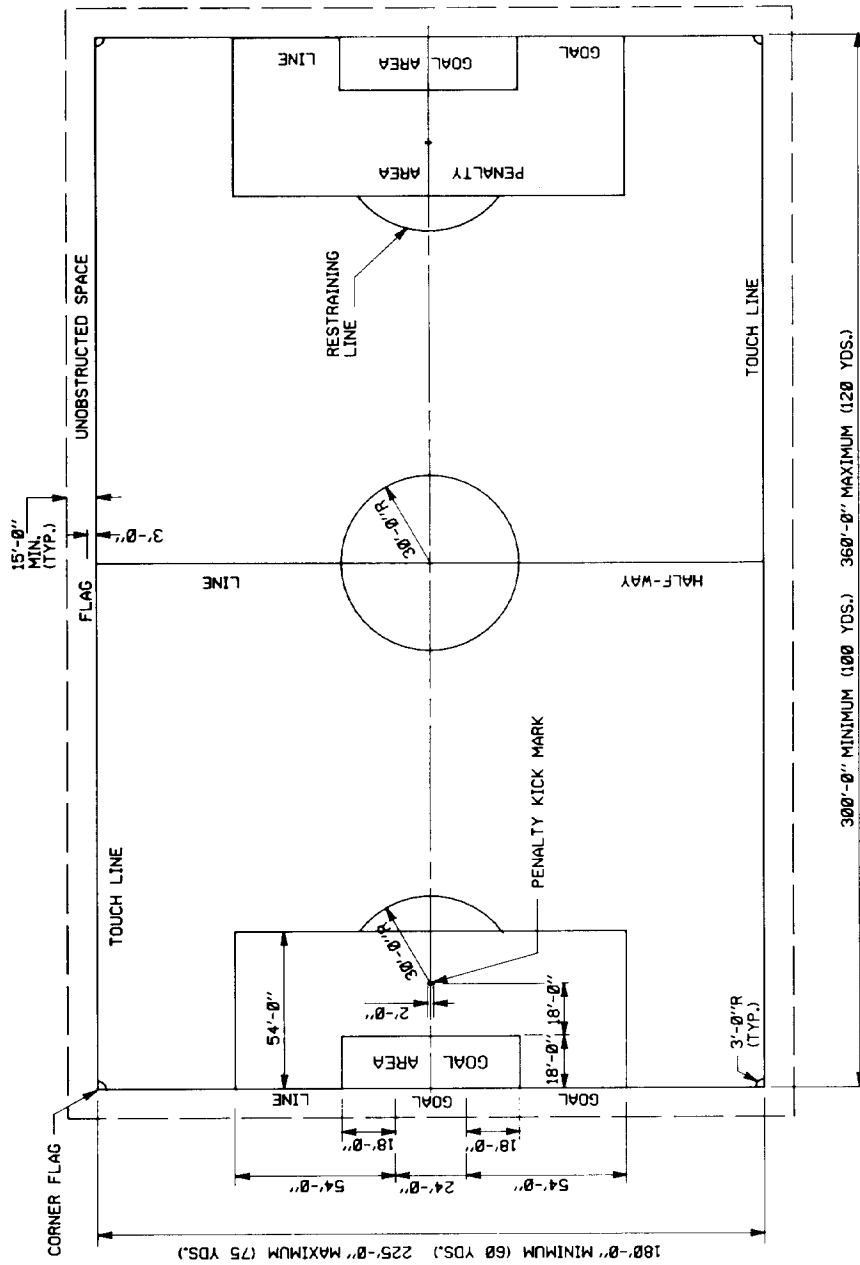

PLAYING FIELD LAYOUT

NOTES:

All dimensions are to the inside edge of lines.

All lines shall be 2" wide and marked with a white, non-toxic material which is not injurious to the eyes or skin.

For flag detail see figure B-10.

For grading and drainage details see figure G-4.

For surfacing details see figure G-5.

For goal post details and notes see figure B-12.

Figure B-13. Soccer (women's and girl's).

B-14. Field hockey (see fig B-14)

- a. *Source of information.* Field Hockey Association of America (FHAA).
- b. *Recommended area.* Ground space is 64,000 square feet (1.5 acres) minimum.
- c. *Size and dimension.* Playing field width is 180 feet 0 inch. Length is 300 feet 0 inch. Additional area recommended is 10 feet 0 inch minimum unobstructed space on all sides.
- d. *Orientation.* Preferred orientation is for the long axis to be northwest-southeast to suit the angle of the sun in the fall playing season, or north-south for longer periods.
- e. *Surface and drainage.*
 - (1) Surface is to be turf.
 - (2) Preferred grading is a longitudinal crown with a 1 percent slope from center to each side and adequate subdrainage.
 - (3) Grading may be from side to side or corner to corner diagonally if conditions do not permit the preferred grading.

B-15. Flickerball (see fig B-15)

- a. Source of information.* Rules furnished by United States Air Force.
- b. Recommended area* Ground space is 17,600 square feet (.4 acre) minimum.
- c. Size and dimension.* Playing field width is 90 feet 0 inch. Length is 160 feet 0 inch. Goals are 15 feet 0 inch beyond each end line. Additional area recommended is 6 feet 0 inch minimum unobstructed space on all sides.
- d. Orientation.* Preferred orientation is for the long axis to be northwest-southeast to suit the angle of the sun in the fall playing season, or north-south for longer periods.
- e. Surface and drainage.*
 - (1) Surface is to be turf.
 - (2) Preferred grading is a longitudinal crown with a 1 percent slope from center to each side and adequate subdrainage.
 - (3) Grading may be from side to side or corner to corner diagonally if conditions do not permit the preferred grading.

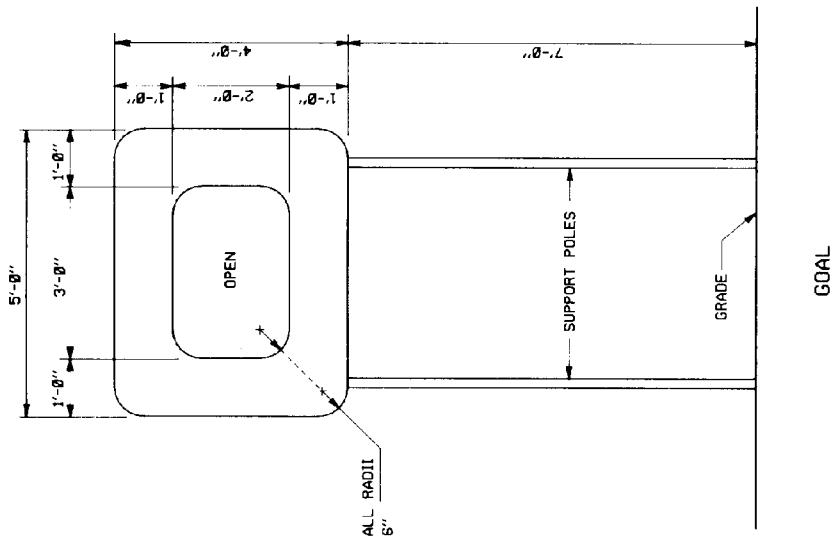
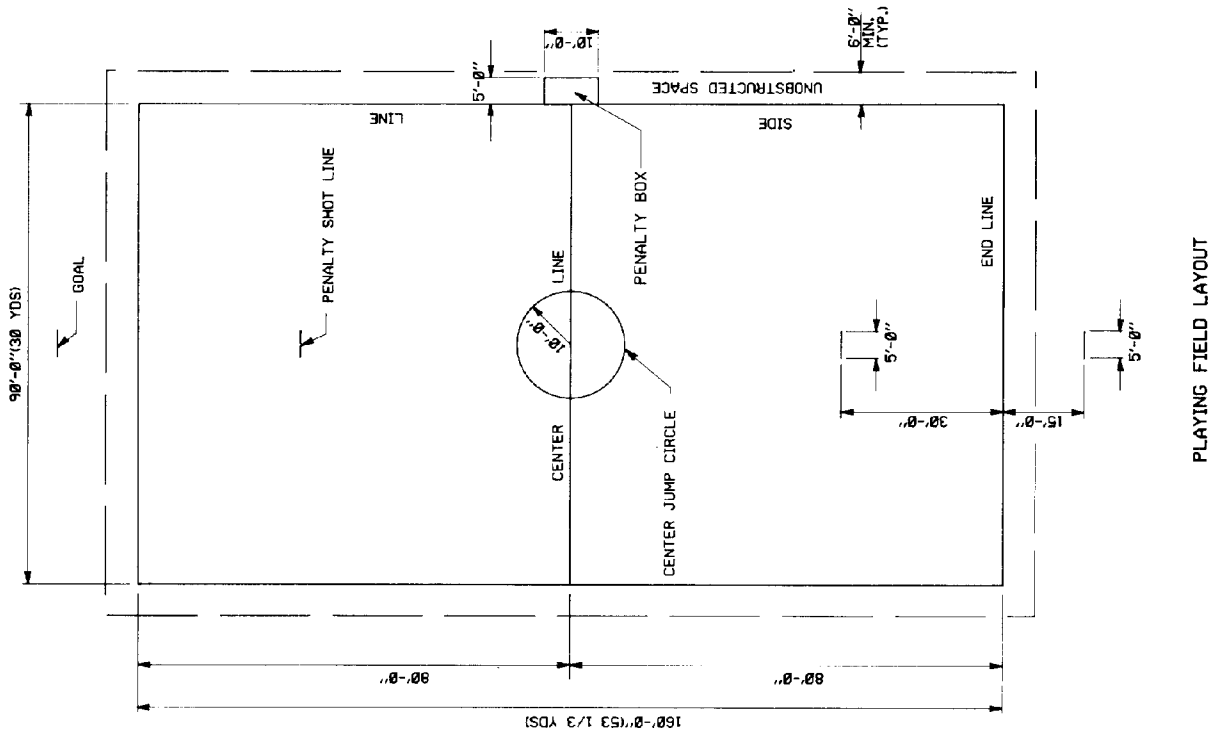

Figure B-15. Flickerball.

NOTES:

All measurements shall be made from the inside edge of lines marking boundaries.
 Lines shall be white and 3" wide and marked with a non-toxic material which is not injurious to the eyes or skin.
 For grading and drainage details see figure G-4.
 For surfacing details see figure G-5.

B-16. Speedball (see fig B-16)

- a. *Source of information.* National Association for Girls and Women in Sport (NAGWS).
- b. *Recommended area.* Ground space is 36,400 square feet (0.8 acre) (high school) to 76,000 square feet (1.7 acres).
- c. *Size and dimension.* Playing field width is 180 feet 0 inch. Length is 300 feet 0 inch. An additional 30 feet by 180 feet out of bounds touchdown area is recommended on each end and unobstructed space of 10 feet 0 inch on all sides. High school field may be 120 feet wide by 240 feet long.
- d. *Orientation.* Preferred orientation is for the long axis to be northwest-southeast during the fall playing season, or north-south for longer periods.
- e. *Surface and drainage.*
 - (1) Surface is to be turf.
 - (2) Preferred grading is a longitudinal crown with a 1 percent slope from center to each side and adequate underdrainage.
 - (3) Grading may be from side to side or corner to corner diagonally if conditions do not permit the preferred grading.

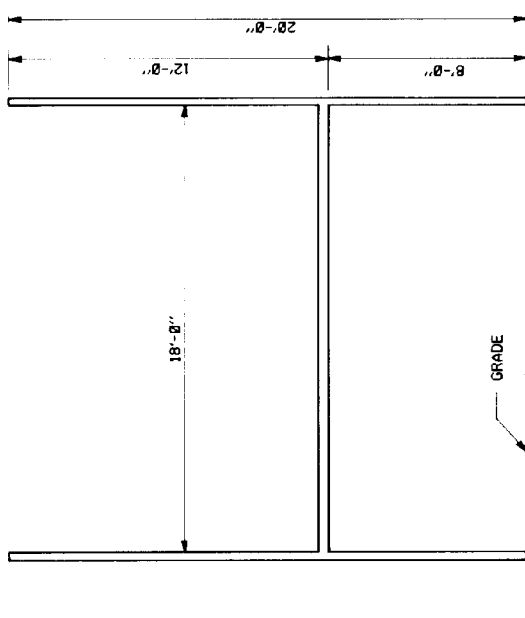
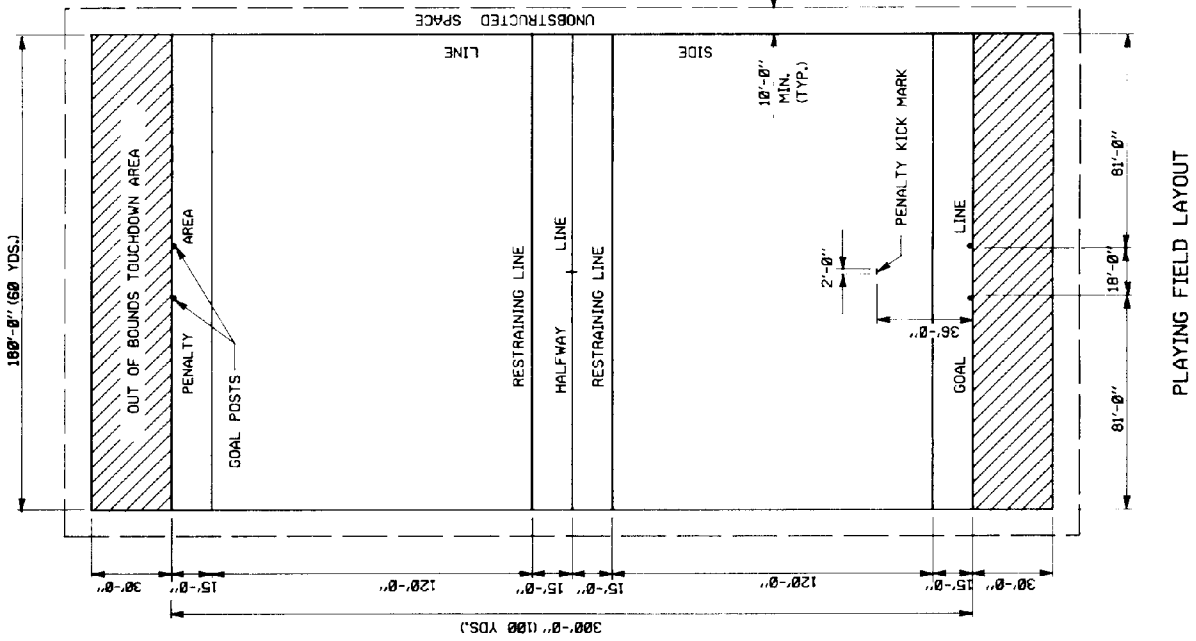

GOAL POSTS

NOTES:

All dimensions are to inside edge of lines.

All field markings to be 2" wide and marked with a white non-toxic material which is not injurious to the eyes or skin.

For goal post details see figure G-3.

For grading and drainage details see figure G-4.

For surfacing details see figure G-5.

Figure B-16. Speedball.

B-17. Team handball (see fig B-17)

- a. *Source of information.* United States Team Handball Federation (USTHF).
- b. *Recommended area.* Ground space is 1,033 square meters (11,120 square feet (0.26 acre)).
- c. *Size and dimension.* Playing field width is 20 m (65 feet 7-½ inches). Length is 40 m (131 feet 3 inches). Additional area recommended is 2.0 m (6 feet 7 inches) minimum unobstructed space on all sides.
- d. *Orientation.* Preferred orientation is for the long axis to be northwest-southeast during the fall playing season, or north-south for longer periods.
- e. *Surface and drainage.*
 - (1) Surface is to be turf.
 - (2) Preferred grading is a longitudinal crown with a 1 percent slope from center to each side and adequate subdrainage.
 - (3) Grading may be from side to side or corner to corner diagonally if conditions do not permit the preferred grading.

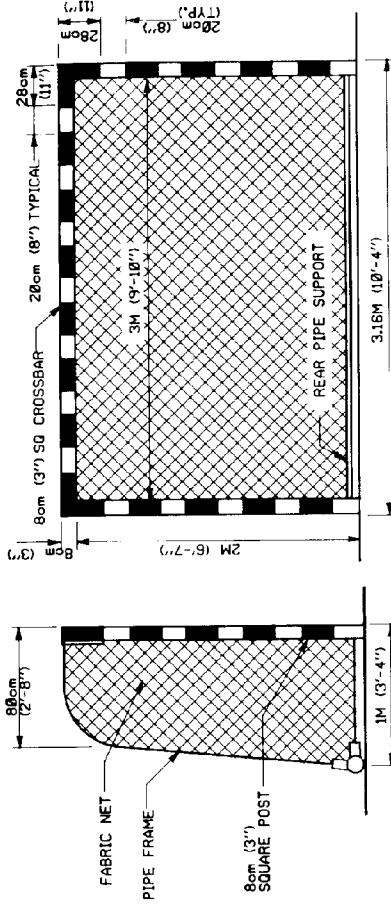

GOAL POSTS AND CROSSBAR

NOTES:

Team handball goal posts and crossbar are metal or wood painted on all sides in two contrasting colors. Goals will be fixed to the ground with hooked stakes.

The goal line between the goal posts is the same width as the posts.

Back edge of goal posts shall be in line with outer edge of goal line.

The radius locating the goal area line and free throw lines are measured from the back inside corner of the goal posts and include the width of the line.

All field markings are 5cm (2") wide and form part of the area they enclose.

Lines shall be marked with a white, non-toxic material which is not injurious to eyes or skin.

For grading and drainage details see figure G-4.

For surfacing details see figure G-5.

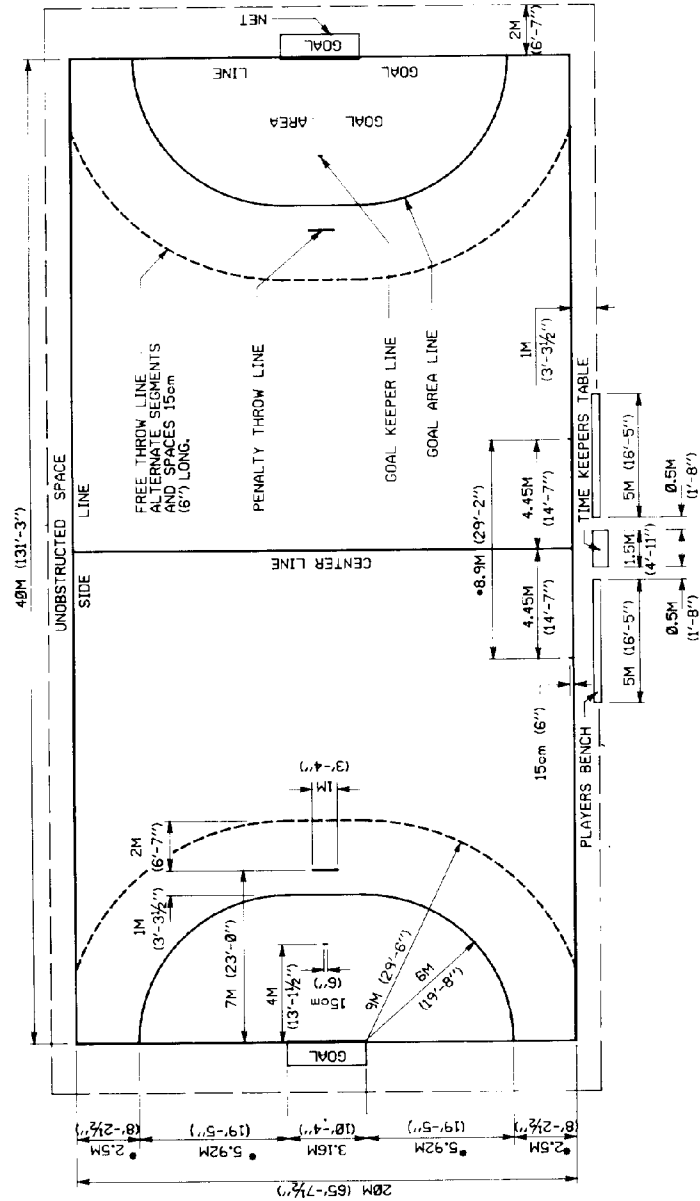

PLAYING FIELD LAYOUT

*Notes: measurement made to the outside edge of lines.

Figure B-17. Team handball.

B-18. Golf driving range (see fig B-18)

- a. *Source of information.* National Golf Foundation, Inc.
- b. *Recommended area.* Ground space for minimum of 25 tees is 13.5 acres.
- c. *Size and dimension.* Minimum length is 900 feet (300 yards). Minimum width, including buffer area on each side, is 620 feet (206.7 yards). Add 12 feet width per additional tee.
- d. *Orientation.* Preferred orientation is for the long axis to run southwest to northeast with the golfer driving toward the northeast.
- e. *Surface and drainage.*
 - (1) Surface is to be turf closely mowed in center for ball collection. Side buffer areas are to be rough cut.
 - (2) Drainage is to be away from raised tee area and preferably across the axis of play. Side buffer areas may rise to help contain stray drives.
- f. *Special consideration.*
 - (1) The use of tee mats reduces maintenance. Automatic ball tees enable golfers to hit more balls in a shorter period and is a convenience.
 - (2) Target greens are recommended as they give golfers something at which to aim drives.

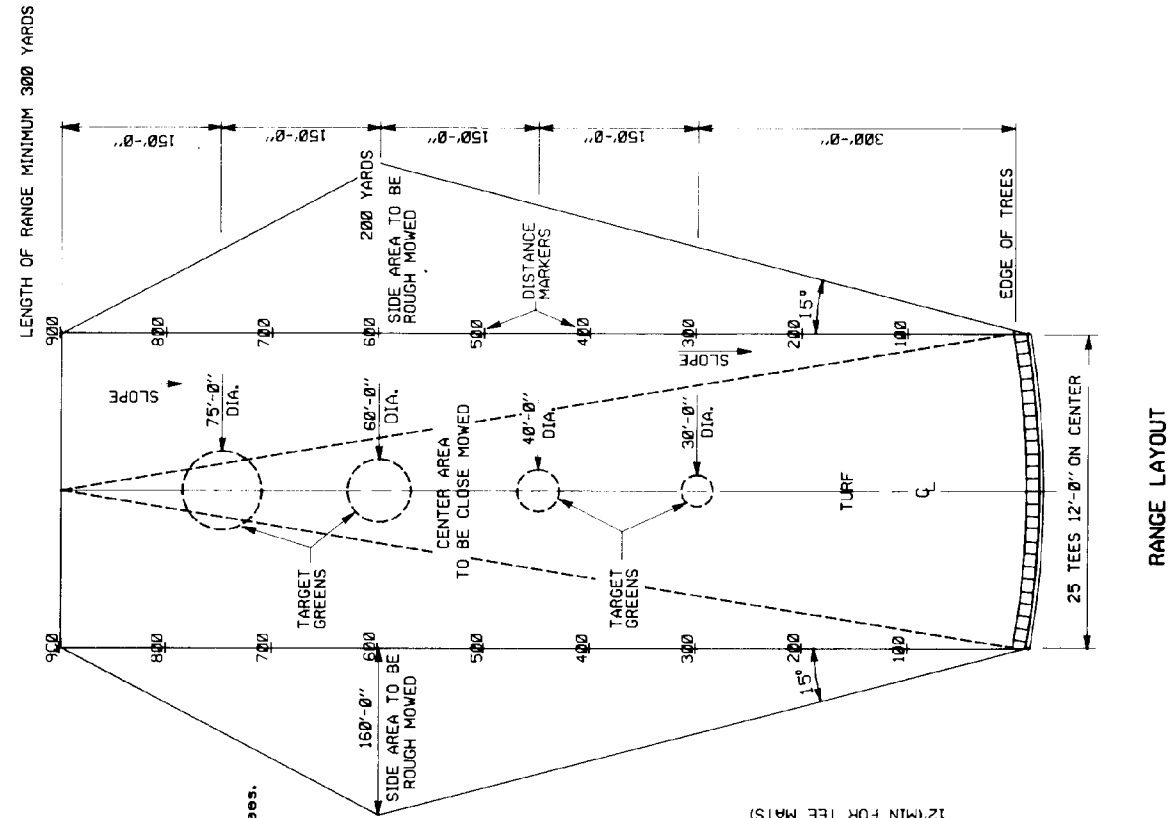

NOTES:

Tee mats should lie on wood platforms, cement or asphalt.

Keep tees 6' (min.) away from curb to protect spectators. Separate adjacent tees by wood or netting partitions about 3' high.

Fences may be needed to keep balls on range.

Select range site to accommodate any future expansion.

The range and the target greens should slope gently from back down toward tees.

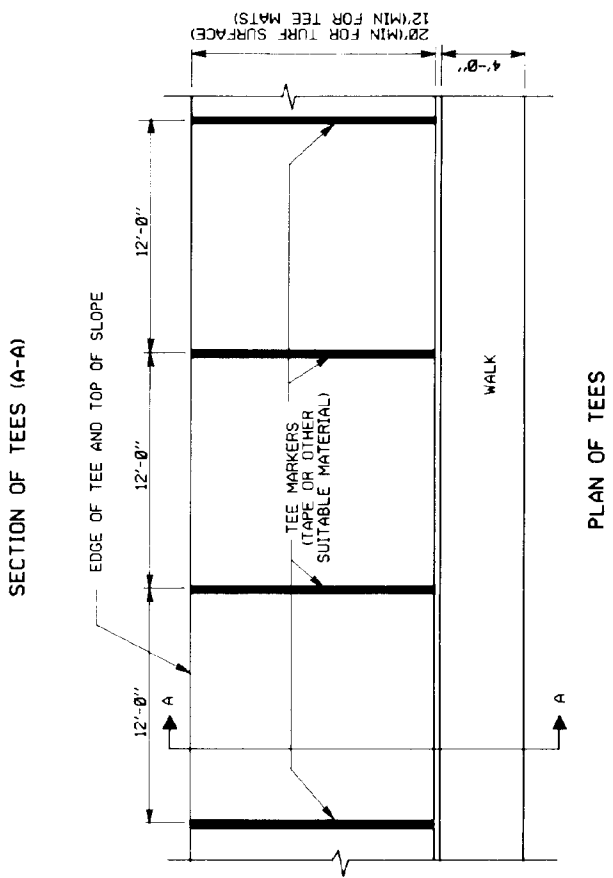
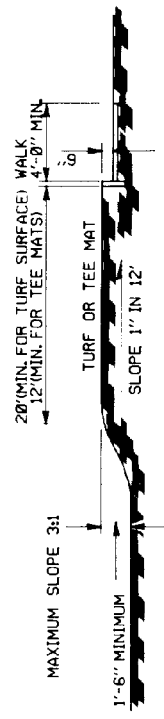

Figure B-18. Golf driving range.

APPENDIX C

TRACK AND FIELD

C-1. 400 meter running track (see fig C-1 and fig C-2)

- a. Source of information.* The Athletic Congress.
- b. Recommended area.* Ground space is approximately 4.1 acres.
- c. Size and dimension.* Radius to trackside face of curb is 31.533 m (103.44 feet). Track width is 8.534 m (28 feet) for 8 lanes 1.067 m (3.50 feet) wide each.
- d. Orientation.* The track will be oriented with the long axis in a sector from north-northwest to south-southeast. The finish line will be on the north.
- e. Surface and drainage.*
 - (1) Track surface is to be preferably bituminous material with a hot plant cushion course mix. Protective colorcoating is optional.
 - (2) Maximum slopes for the running track are 2 percent (1:50) inward in the center of curves, 1 percent (1:100) inward in the straightaways and 0.1 percent (1:1000) in the running direction.
- f. Special consideration.* Drainage must be provided for the track surface, but will be dependent upon site grading.

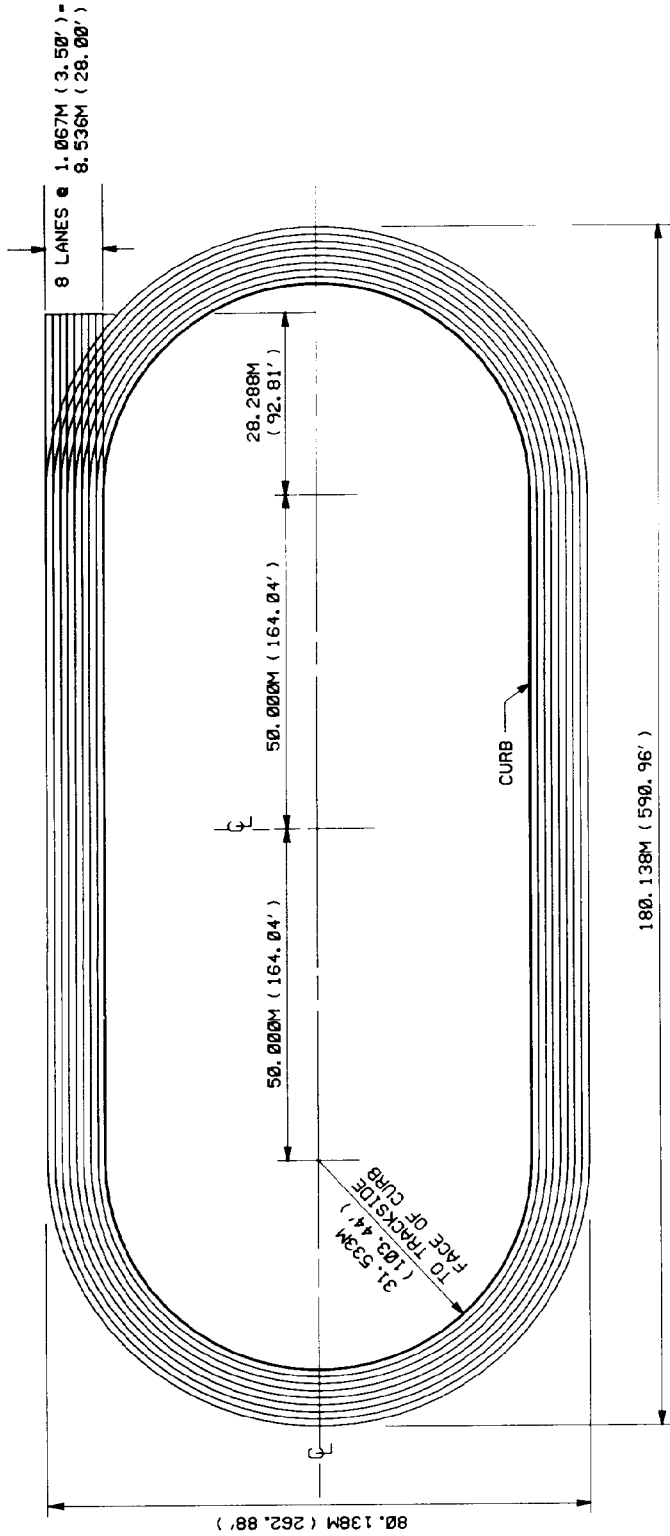

400-METER RUNNING TRACK LAYOUT

NOTES:

- Lane #1 is innermost lane.
- Instructions can be ordered from NCAA for marking 400-meter track events on an existing 1/4-mile track.
- See figure C-2 for location of lane measurement lines and other track data.

Figure C-1. 400 meter running track.

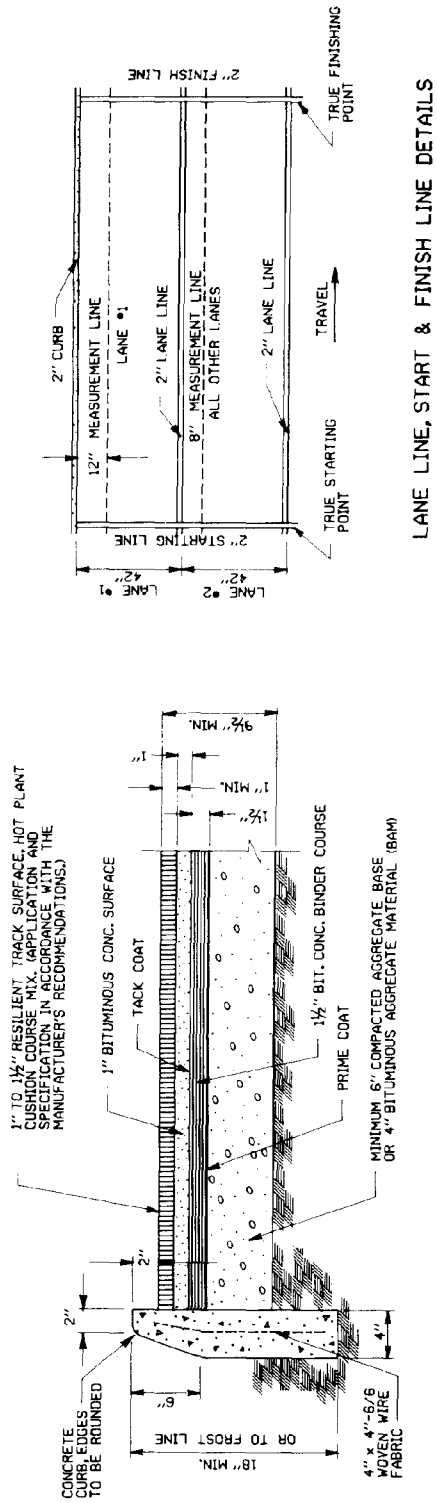

LANE LINE, START & FINISH LINE DETAILS

TYPICAL SECTION - RUNNING TRACK

NOTES:

World records will be recognized only if performed on a track bordered on the inside by a curb 2" high and 2" wide.

Order engineer's drawings from NCAA containing additional track information including drainage data and start and finish line layout data for 400-meter track events.

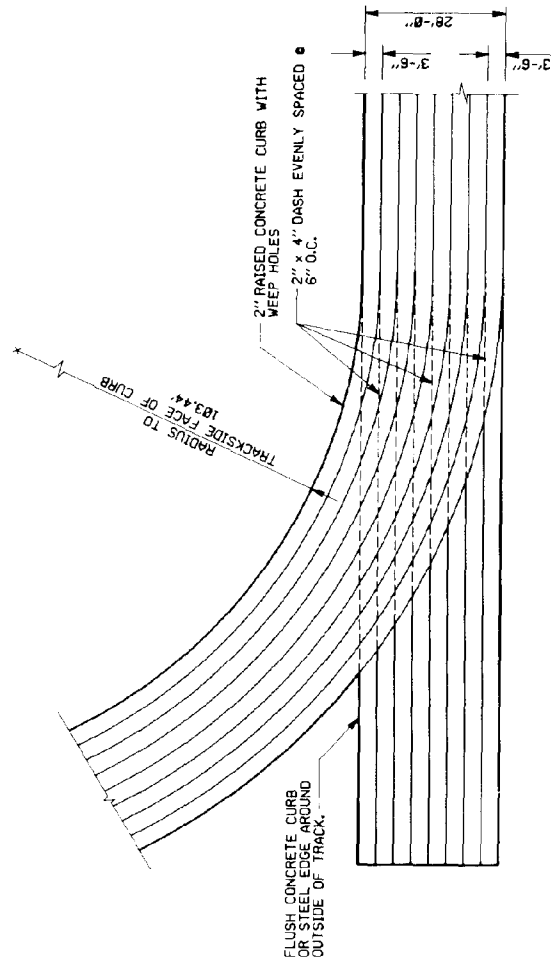

LANE MARKING DETAILS

Figure C-2. 400 meter running track detail.

C-2. Shot Put (see fig C-3)

- a. *Source of information.* The Athletic Congress.
- b. *Recommended area.* Ground space is 2,100 square feet (0.05 acre) minimum.
- c. *Size and dimension.* Shot Put circle is 7 feet 0 inch (2.134 m) in diameter. Throwing sector is 40-degree angle and 70 feet (21.33 m) minimum radius.
- d. *Orientation.* Preferred orientation is for the throwing direction to be toward the northeast quadrant.
- e. *Surface and drainage.* Surface of inner circle is to be concrete or similar material. Throwing sector is to be turf at the same level as the top of the metal ring.
- f. *Special consideration.*
 - (1) Stopboard must be firmly fixed so that its inner edge coincides with the inner edge of the Shot Put circle.
 - (2) Sector flags are required to mark end of landing zone at distance required by the competition.

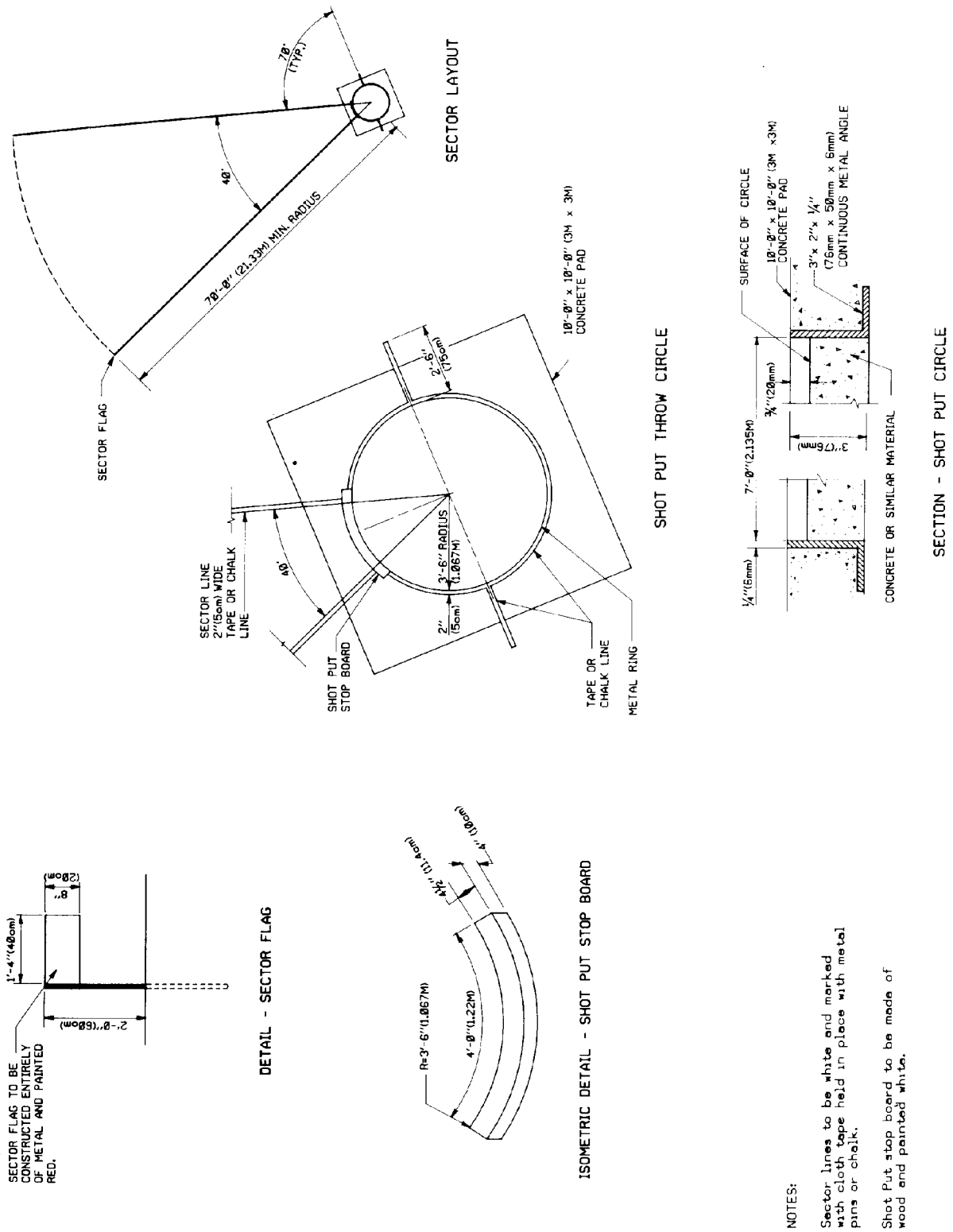
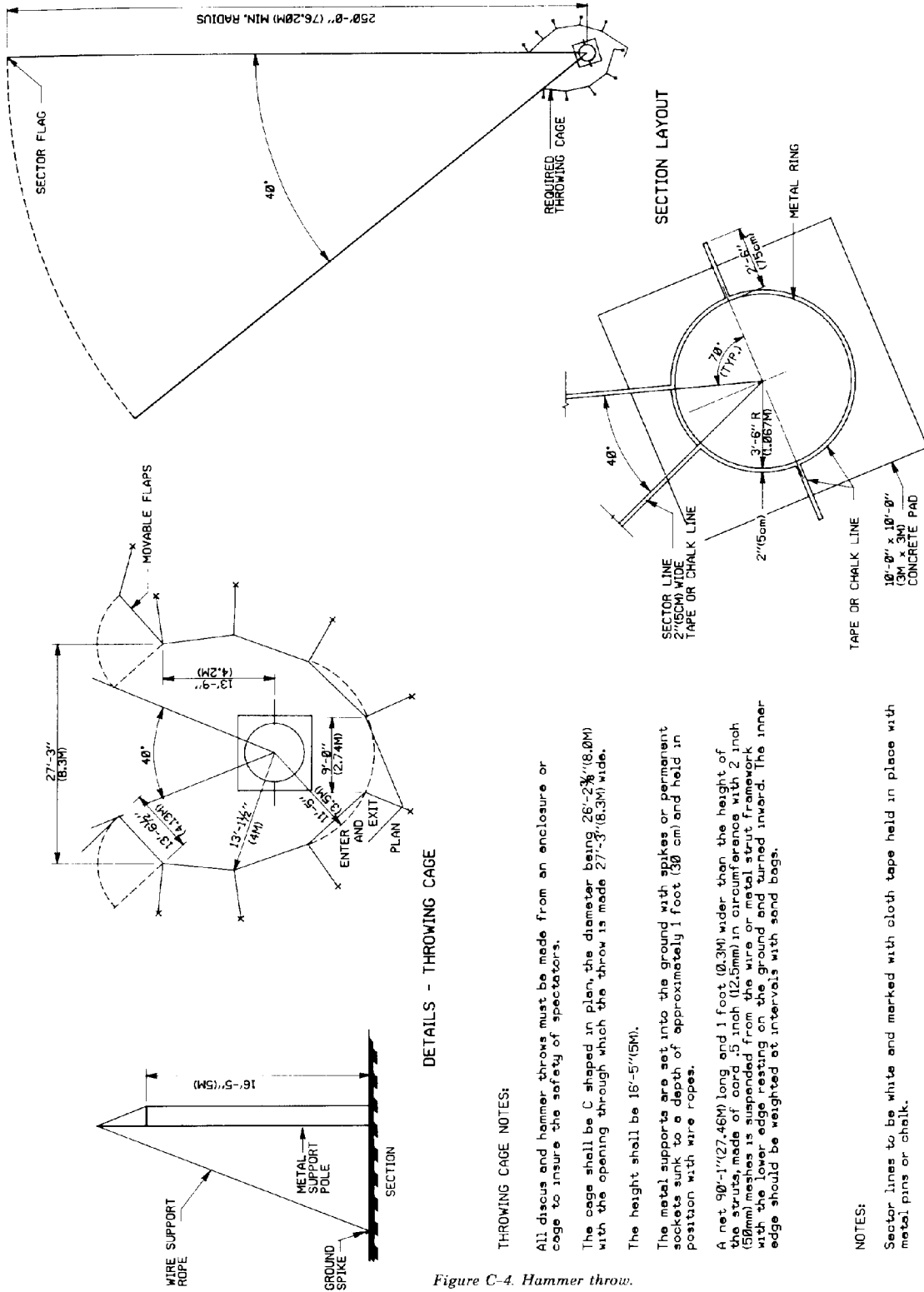

Figure C-3. Shot Put.

C-3. Hammer throw (see fig C-4)

- a. *Source of information.* The Athletic Congress.
- b. *Recommended area.* Ground space is 23,000 square feet (0.5 acre) minimum.
- c. *Size and dimension.* Hammer throw circle is 7 feet 0 inch (2.134 m) in diameter. Throwing sector is 40-degree angle and 250 feet (76.20 m) minimum radius.
- d. *Orientation.* Preferred orientation is for the throwing direction to be toward the northeast quadrant.
- e. *Surface and drainage.* Throwing sector is to be turf at the same level as the top of the metal ring.
- f. *Special considerations.* Section flags are required to mark end of landing zone at distance required by the competition.



DETAILS - THROWING CAGE

HAMMER THROW CIRCLE

THROWING CAGE NOTES:

- All discs and hammer throws must be made from an enclosure or cage to insure the safety of spectators.
- The cage shall be C shaped in plan, the diameter being 26'-2 3/8" (8.0M) with the opening through which the throw is made 27'-3" (8.3M) wide.
- The height shall be 16'-5" (5M).
- The metal supports are set into the ground with spikes or permanent sockets sunk to a depth of approximately 1 foot (30 cm) and held in position with wire ropes.
- A net 90'-1" (27.46M) long and 1 foot (0.3M) wider than the height of the struts, made of cord 5 inch (12.5mm) in circumference with 2 inch (50mm) mesh is suspended from the wire or metal support flange with the lower edge resting on the ground and turned inward. The inner edge should be weighted at intervals with sand bags.

NOTES:

- Sector lines to be white and marked with cloth tape held in place with metal pins or chalk.
- For sector flag detail and sectional view of hammer throw circle see "Section of Shot Put" figure C-3.

Figure C-4. Hammer throw.

C-4. Discus throw (see fig C-5).

- a. *Source of information.* The Athletic Congress.
- b. *Recommended area.* Ground space is 18,100 square feet (0.4 acre) minimum.
- c. *Size and dimension.* Discus throwing circle is 8 feet 2-½ inch (2.50 m) in diameter. Throwing sector is 40-degree angle and 220 feet (67.06 m) minimum radius.
- d. *Orientation.* Preferred orientation is for the throwing to be toward the northeast quadrant.
- e. *Surface and drainage.* Throwing sector is to be turf at the same level as the top of the metal ring.
- f. *Special considerations.* Sector flags are required to mark end of landing zone at distance required by the competition.

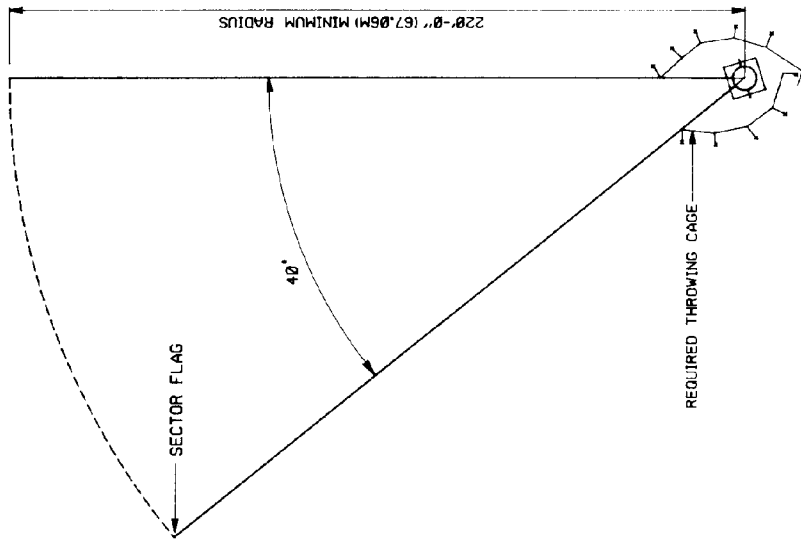

SECTOR LAYOUT

NOTES:

Sector lines to be white and marked with cloth tape held in place with metal pins or chalk.
 For sector flag details see figure C-3.
 For throwing cage details see figure C-4.

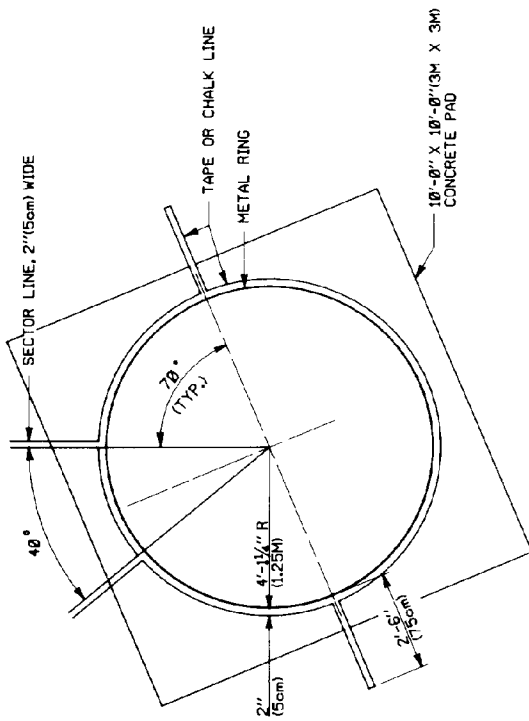

DISCUS THROW CIRCLE

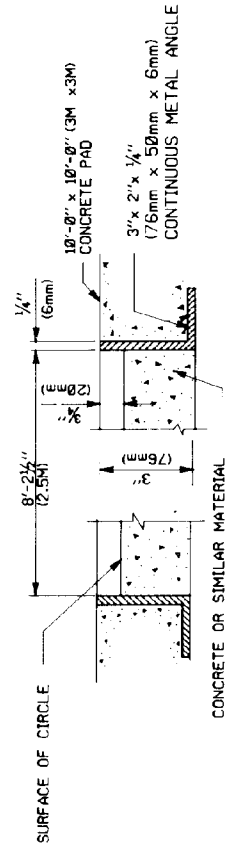

SECTION - DISCUS THROW CIRCLE

Figure C-5. Discus throw.

C-5. Javelin throw (see fig C-6)

- a. *Source of information.* The Athletic Congress.
- b. *Recommended area.* Ground space is 24,000 square feet minimum.
- c. *Size and dimension.* Runway length is minimum 120 feet 0 inch (36.5 m). Runway width is 13 feet 1-1/2 inch (4.0 m). Throwing sector is 30-degree angle with a 300-foot 0-inch (91.5 m) minimum radius.
- d. *Orientation.* Preferred orientation is for the throwing direction to be toward the northeast quadrant.
- e. *Surface and drainage.*
 - (1) Runway may be turf or specialized bituminous surfacing with a maximum slope of 1 percent (1:100) laterally and 0.1 percent (1:1000) in the running direction.
 - (2) Throwing sector is to be turf at the same level as the runway behind the throwing arc.
- f. *Special considerations.* Sector flags are required to mark end of landing zone at distance required by the competition.

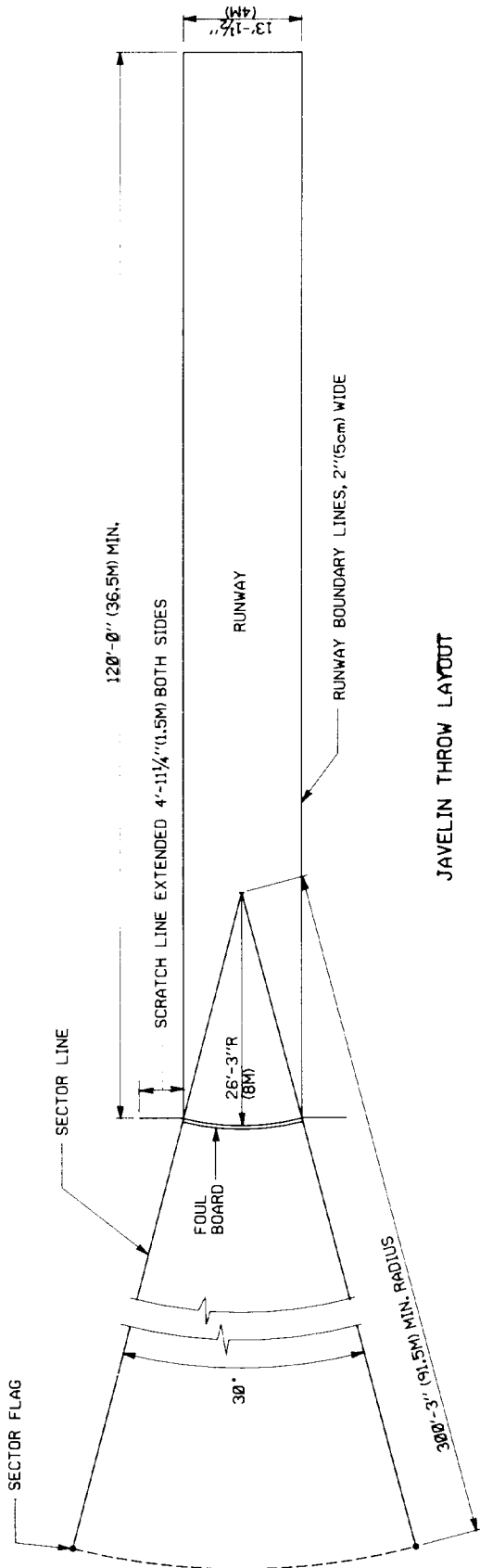

JAVELIN THROW LAYOUT

NOTES:

Sector lines to be white, 2" (5cm) wide and marked with cloth tape held in place with metal pins or chalk.

Runway may be either turf or bituminous material.

For runway surfacing details see figure C-2.

For sector flag detail see figure C-3.

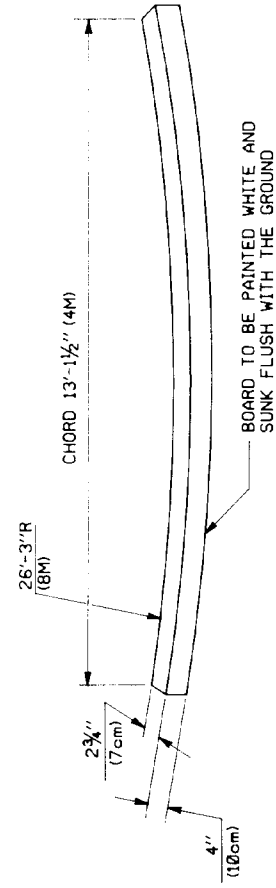

ISOMETRIC DETAIL - JAVELIN THROW FOUL BOARD

Figure C-6. Javelin throw.

C-6. Long jump and triple jump (see fig C-7)

- a. *Source of information.* The Athletic Congress.
- b. *Recommended area.* Ground space is 1,500 square feet (0.03 acre) minimum.
- c. *Size and dimension.* Runway length is 130 feet 0 inch (36.92 m) minimum. Runway width is 4 feet 0 inch (1.22 m) minimum. Landing pit width is 9 feet 0 inch (2.75 m) minimum. Landing pit length is 32 feet 10 inch (10 m) minimum.
- d. *Orientation.* Preferred orientation is for the running direction to be toward the north or northeast.
- e. *Surface and drainage.*
 - (1) Runway preferably is to be bituminous material with a hot plant cushion course mix. Protective colorcoating is optional.
 - (2) Maximum slope is to be 1 percent (1:100) laterally and 0.1 percent (1:1000) in the running direction.
 - (3) Landing pit is to be sand at the same elevation as the take-off board.
- f. *Special considerations.* Take-off board is to be of wood and must be fixed in the runway.

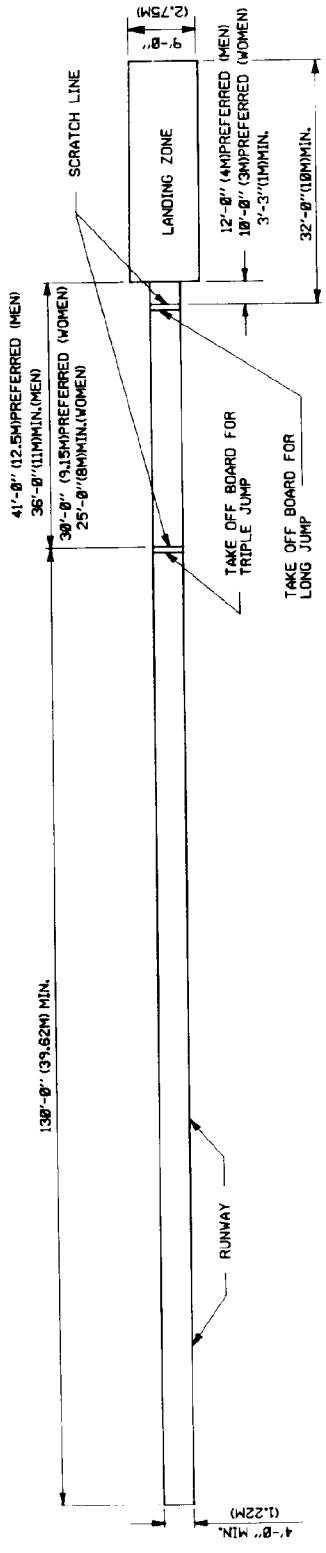

2" x 6" RETAINING BOARD TO BE SET WITH THE TOP SURFACE AT THE SAME ELEVATION AS THE TAKE-OFF BOARD.

TOP EDGE TO BE USED AS A SCREENING SURFACE FOR THE SAND LANDING ZONE.

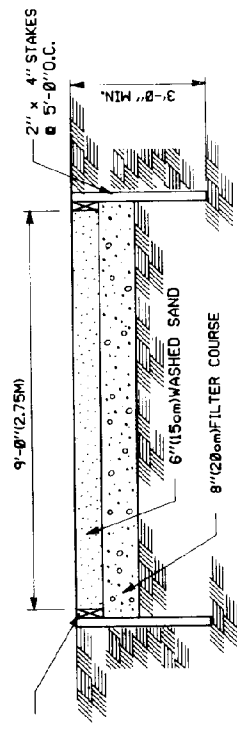

SECTION - LANDING ZONE

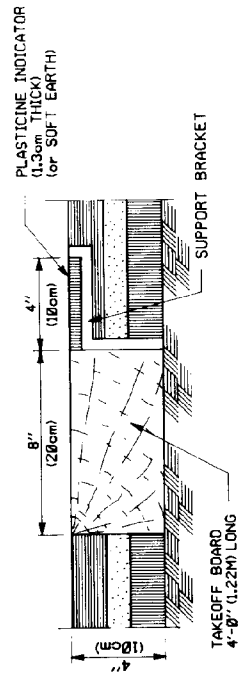

NOTES:

The edge of the takeoff board nearest the landing pit shall be the scratch, or foul line.

The construction and material of the runway shall be extended beyond the takeoff board to the nearer edge of the landing pit.

For runway surfacing details see figure C-2.

Figure C-7. Long jump and triple jump.

C-7. Pole vault (see fig C-8)

- a. *Source of information.* The Athletic Congress.
- b. *Recommended area.* Ground space is 1,500 square feet minimum.
- c. *Size and dimension.* Runway length is 125 feet 0 inch (38.10 m) minimum. Runway width is 4 feet 0 inch (1.22 m) minimum. Vault pit width is 16 feet 0 inch (5 m) minimum and depth ranges from 12 feet 0 inch (3.66 m) minimum to 16 feet 0 inch (5 m) preferred. Height of material in jumping pit ranges from 18 inches (0.46 m) minimum to 36 inches (0.92 m) preferred, with a connecting apron of the same material and decreasing height around the vaulting box.
- d. *Orientation.* Preferred orientation is for the running direction to be toward the north to east-northeast.
- e. *Surface and drainage.*
 - (1) Runway preferably is to be bituminous material with a hot plant cushion course mix. Protective colorcoating is optional.
 - (2) Maximum slope is to be 1 percent (1:100) laterally and 0.1 percent (1:1000) in the running direction.
- f. *Special considerations.* Pole vault box must be fixed in the ground with its entire front edge flush with the front edge of the jumping pit.

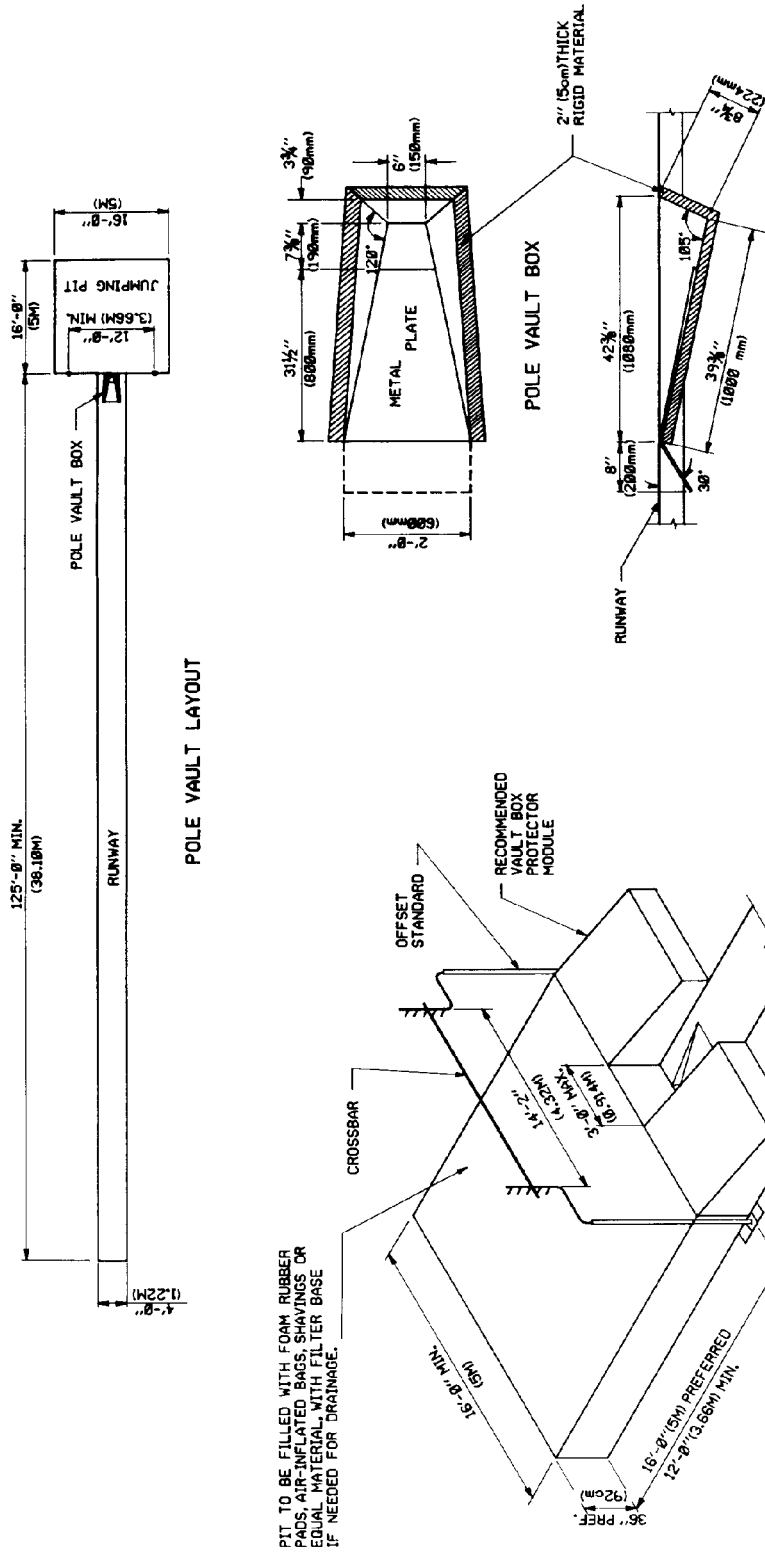
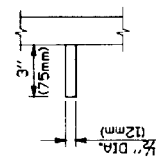

Figure C-8. Pole vault.

NOTES:
 Any style of uprights or standards may be used, provided they are rigid and supported by a base not to exceed 4" in height above the ground.
 The crossbar shall be of metal or other suitable material and triangular or circular in section with flat ends.
 For runway surfacing details see figure C-2.



DETAIL - CROSSBAR SUPPORT

C-8. High jump (see fig C-9)

- a. *Source of information.* The Athletic Congress.
- b. *Recommended area.* Ground space is 4,100 square feet (0.09 acre) minimum.
- c. *Size and dimension.* High jump runway is 50 feet (15.24 m) minimum radius and preferably 70 feet (21.3 m) radius semi-circle. High jump pit width is 16 feet (5 m) by 8 feet (2.5 m) depth minimum. Height of material in jumping pit is 28 inches (0.7 m) minimum. Take-off area is 10 feet 0 inch (3 m) radius semi-circle with centerpoint directly under center of cross bar, and no point within this area may be higher than the point of measurement.
- d. *Orientation.* Preferred orientation is for the direction of jumping to be toward the north to east-northeast.
- e. *Surface and drainage.*
 - (1) Runway preferably is to be constructed of bituminous material.
 - (2) Synthetic surface is optional.
 - (3) Maximum approach apron slope is 1 percent laterally (1:100) and 0.1 percent (1:1000) in the running direction.

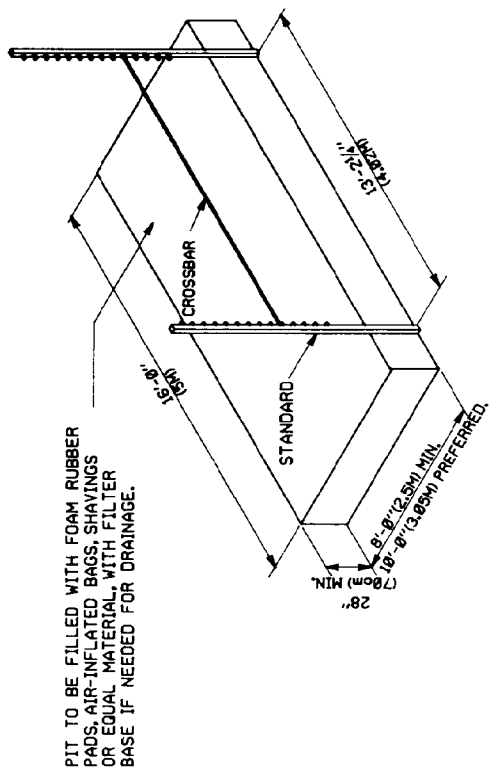

ISOMETRIC SHOWING JUMPING PIT, STANDARDS AND CROSSBAR

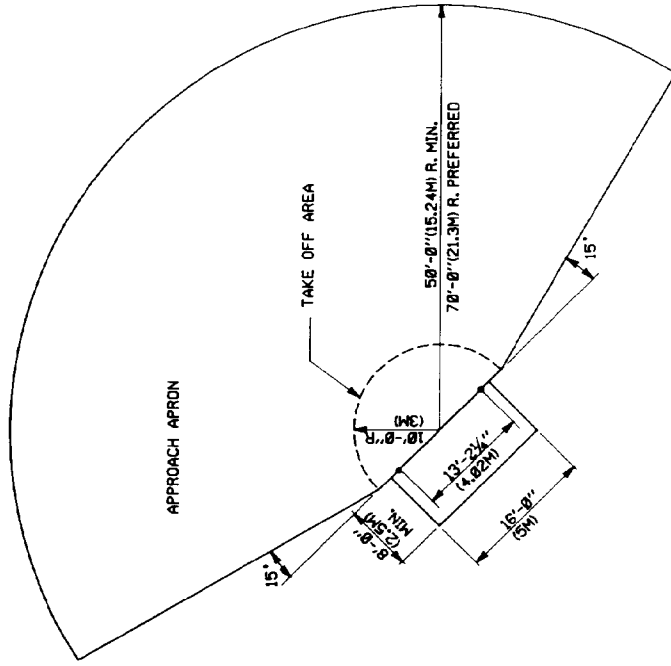

HIGH JUMP LAYOUT

NOTES:

The uprights shall extend at least 4" (100mm) at all heights above the crossbar.

The crossbar shall be of metal or other suitable material and triangular circular in section with flat ends. Length shall be 13'-1 1/2" (4M).

For surfacing details see figure C-2.

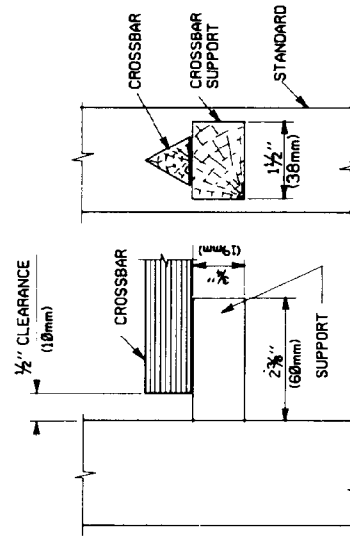

CROSSBAR SUPPORT DETAILS

Figure C-9. High jump.

APPENDIX D

MULTIPLE SPORTS COMPLEXES

D-1. Combination basketball-volleyball court complex (see fig D-1)

a. Source of information. Basketball: National Collegiate Athletic Association (NCAA); Volleyball: United States Volleyball Association (USVBA).

b. Recommended area. Ground space is 0.2 acres (9,120 square feet) for 1 basketball and 1 volleyball courts.

c. Size and dimensions. Overall length is 114 feet. Overall width is 80 feet.

d. Orientation. Preferred orientation is north-south for the long axis of the court expected to have primary use.

e. Surface and drainage.

(1) Surface will be concrete or bituminous material. Protective colorcoating is optional.

(2) Drainage is to be end to end, side to side or corner to corner diagonally at a minimum slope of 1 inch in 10 feet (0.8 percent).

f. Special considerations. Removal post with flush-mounted deck plate must be used for the center volleyball net post to allow unobstructed use of the basketball court.

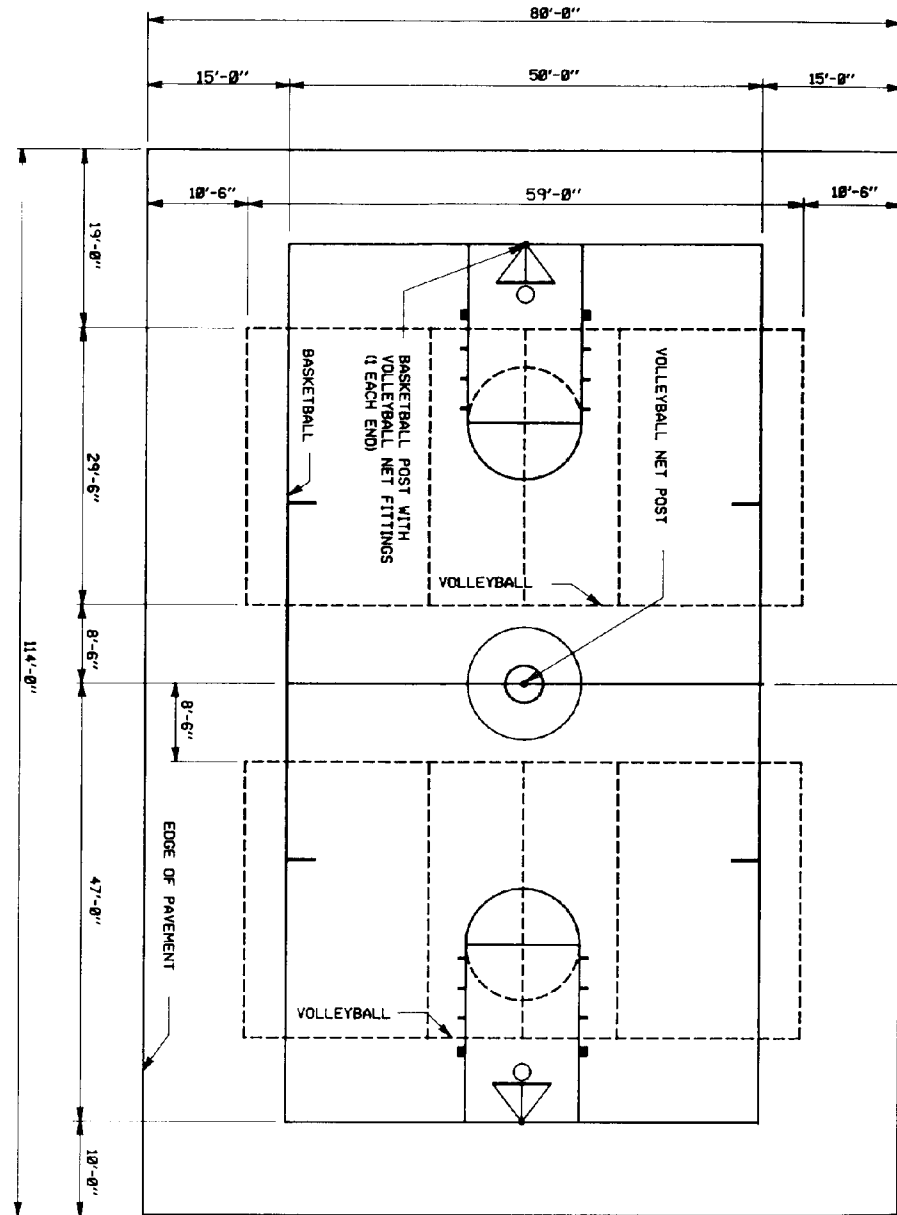

COURT LAYOUT

NOTES:

For individual court dimensions and details, see figure A-3 (basketball) and figure A-21 (volleyball).
 For removable volleyball net post details see figure G-2.
 For surfacing details see figure G-5.

Figure D-1. Combination basketball-volleyball court complex.

D-2. Combination tennis, volleyball, basketball, badminton court complex (see fig D-2).

a. Source of information. Basketball: National Collegiate Athletic Association (NCAA); Volleyball: United States Volleyball Association (USVBA); Badminton: United States Badminton Association (USBA); Tennis: United States Tennis Association (USTA).

b. Recommended area. Ground space is 24,720 square feet (0.6 acres) for four tennis courts with one basketball, one volleyball and one badminton court superimposed thereon.

c. Size and dimension. Overall length is 206 feet 0 inch. Overall width is 120 feet 0 inch.

d. Orientation. Preferred orientation is north-south for the long axis of all courts.

e. Surface and drainage.

(1) Surface is to be concrete or bituminous material. Protective colorcoating is optional.

(2) Drainage is to be end to end, side to side or corner to corner diagonally at a minimum slope of 1 inch in 10 feet (0.8 percent).

f. Special considerations.

(1) Special provisions must be made to allow the various net posts to be erected for different court games.

(2) Fencing will be provided 10 feet 0 inch on all sides.

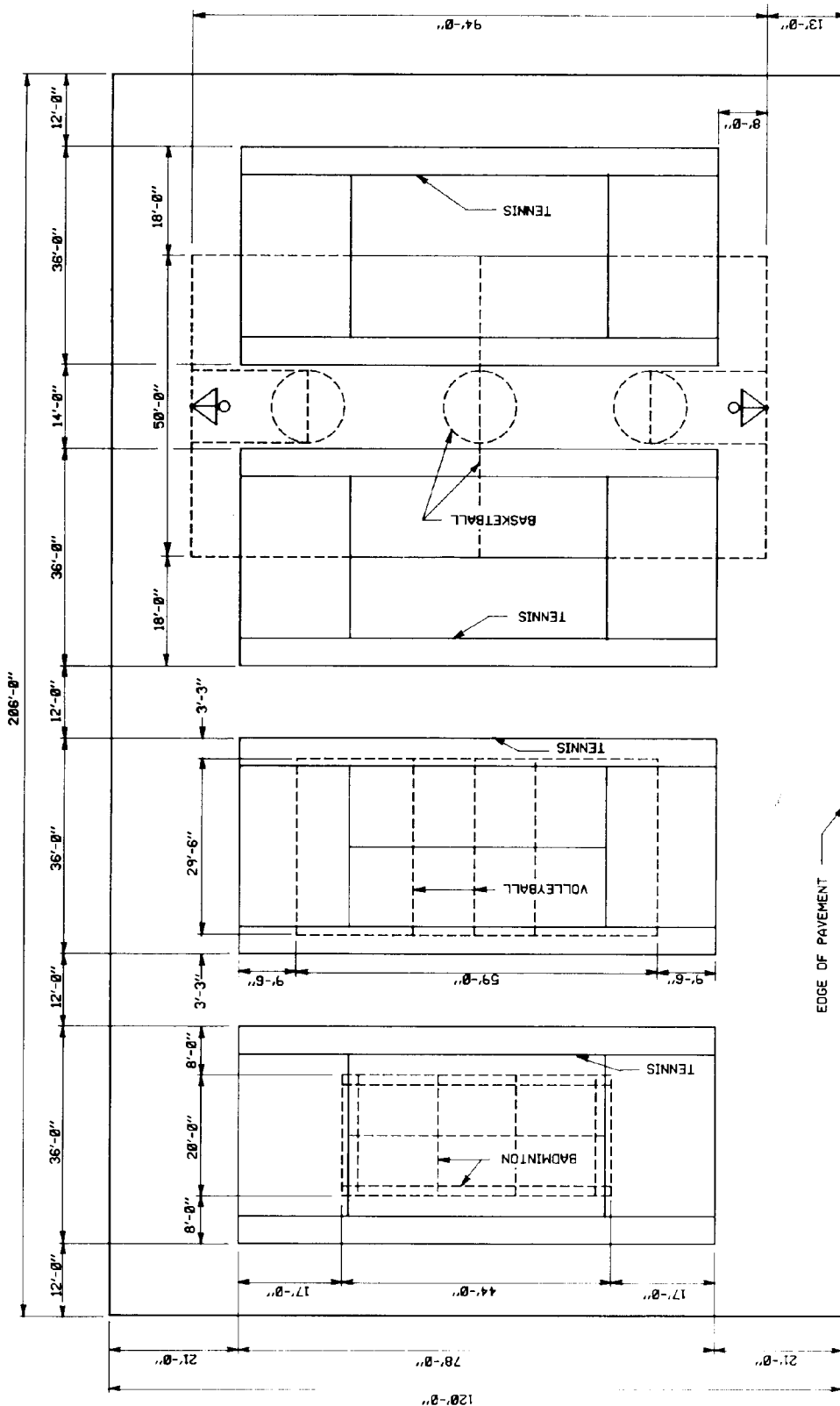

Figure D-2. Combination tennis, volleyball, basketball, badminton court complex.

COURT LAYOUT

NOTES:

For individual court dimensions and details see figure A-1 (Badminton), figure A-3 (Basketball), figure A-19 (Tennis) and figure A-21 (Volleyball).

For surfacing details see figure G-5.

D-3. Multiple sports court (see fig D-3)

a. Source of information. Basketball: National Collegiate Athletic Association (NCAA); Volleyball: United States Volleyball Association (USVBA); Tennis: United States Tennis Association (USTA); Shuffleboard: General Sportcraft.

b. Recommended area. Ground space is 9,840 square feet (0.2 acre).

c. Size and dimension. Overall length is 120 feet 0 inch. Overall width is 82 feet 0 inch.

d. Orientation. Preferred orientation is north-south for the long axis of the court expected to have primary use.

e. Surface and drainage.

(1) Surface is to be concrete or bituminous material. Protective colorcoating is optional. Shuffleboard courts must be concrete.

(2) Preferred drainage is from end to end at a slope of 1 inch in 10 feet (0.8 percent). The 12 feet 0 inch areas on each end will be level for the shuffleboard courts.

f. Special considerations.

(1) Removable posts with flush-mounted deck plates must be used for tennis and volleyball to allow unobstructed use of other courts.

(2) Fencing will be provided 10 feet 0 inch high on all sides.

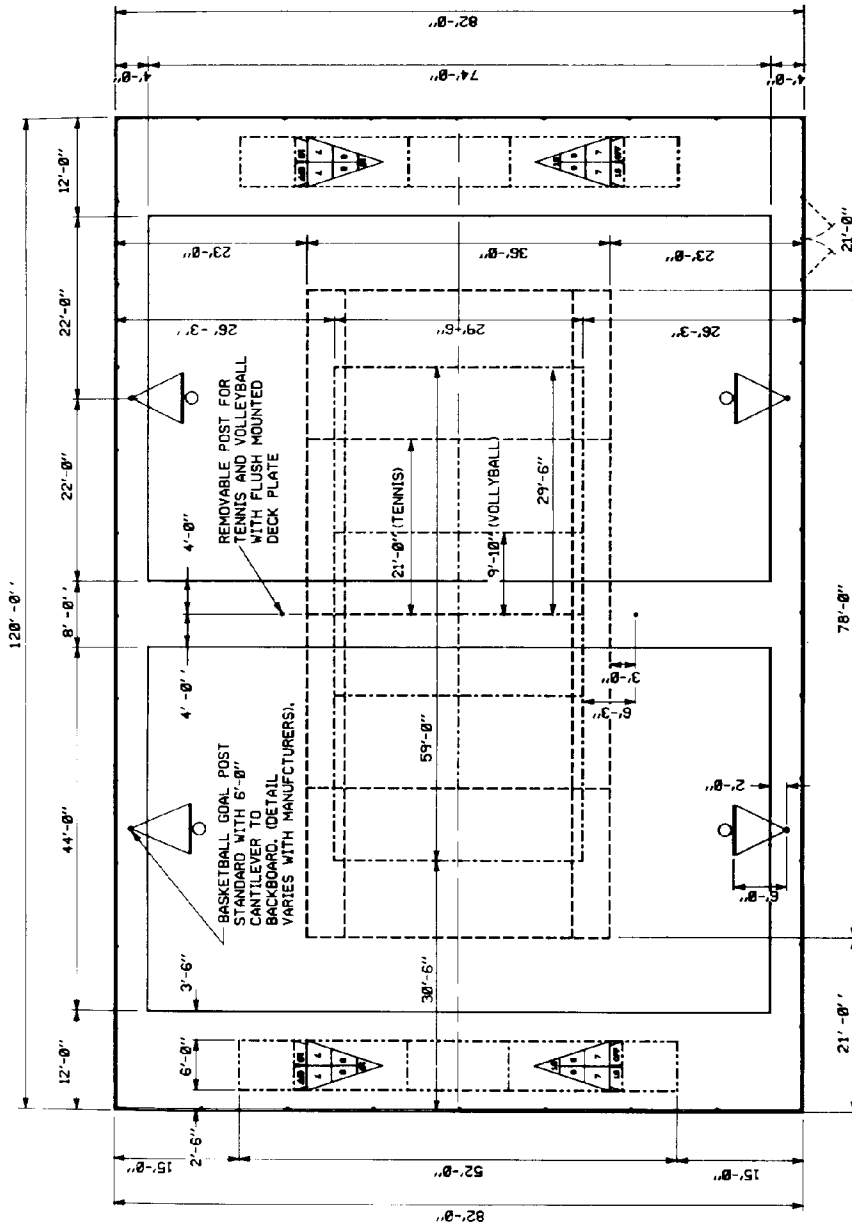

COURT LAYOUT

NOTES:

For individual court dimensions and details see figure A-3(Basketball), figure A-15(Shuffleboard), figure A-19(Tennis) and figure A-21(Volleyball).

The area in which shuffleboard courts are located must be paved as an overrun for the tennis court whether or not the shuffleboard courts are installed; end to end modified drainage scheme must be used if they are installed.

To accommodate regulation-sized basketball courts, paved area must be increased to at least 102' x 132'.

For removable net post details see figure G-2.

For drainage details see figure G-4.

For surfacing details see figure G-5.

COURT IDENTIFICATION LEGEND:

- BASKETBALL
- SHUFFLEBOARD
- TENNIS
- VOLLEYBALL

Color key for painted court lines

- Basketball.....Light Green
- Tennis.....White
- Volleyball.....Yellow
- Shuffleboard.....Black

Figure D-3. Multiple sports court.

D-4. Combination sports fields (see fig D-4)

a. Source of information. Baseball: The Official Playing Rules Committee, Official Baseball Rules; Softball: Amateur Softball Association of America (ASA); Touch and Flag Football: National Touch and Flag Football Rules, The Athletic Institute. Football, 11 man: National Collegiate Athletic Association (NCAA).

b. Recommended area. Varies with number of fields and configuration.

c. Size and dimension. Varies with number of fields and configuration.

d. Orientation. Preferred orientation varies when combinations are used. Selection for priority should be based on anticipated use, time of play, and local site conditions.

e. Surface and drainage.

(1) Surface is to be turf.

(2) Drainage is to be provided following guidelines for individual sports.

f. Special considerations. Safety aspects of each sport will not be compromised when multi-use concepts are employed.

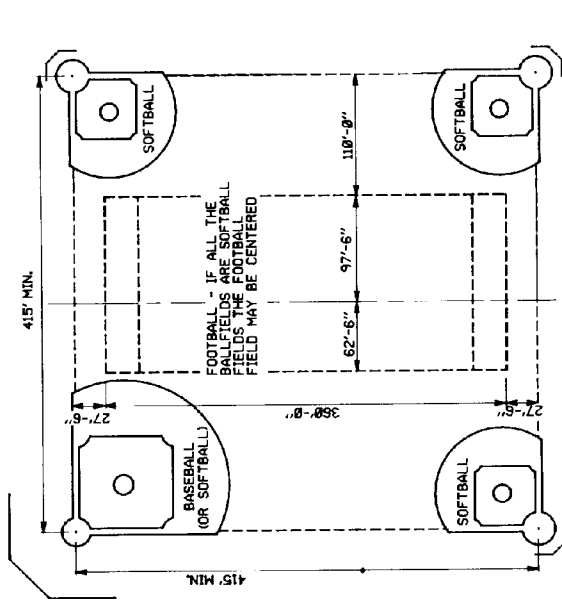

MULTIPLE BASEBALL, SOFTBALL AND FOOTBALL FIELDS

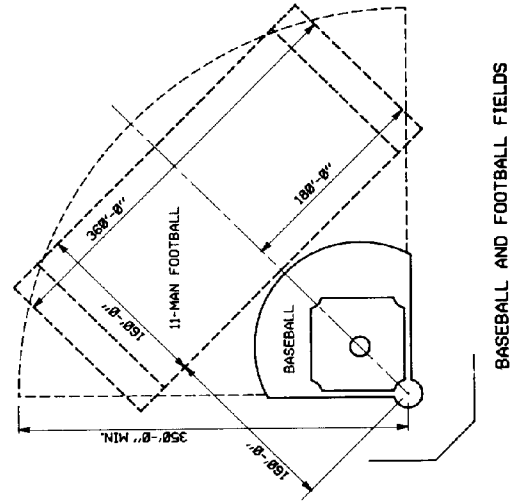

BASEBALL AND FOOTBALL FIELDS

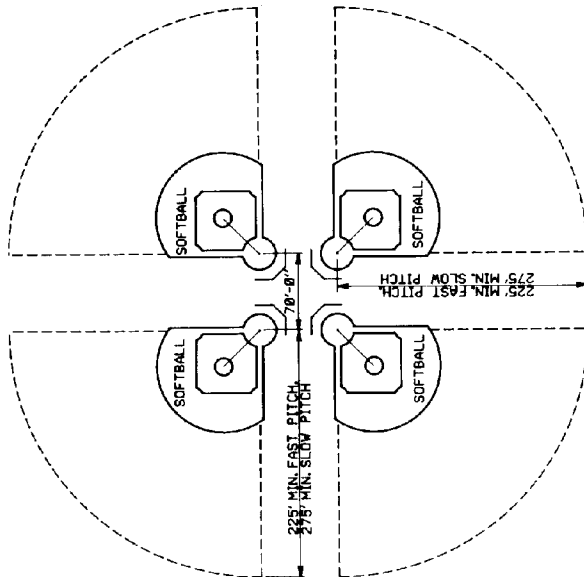

MULTIPLE SOFTBALL FIELDS

NOTES:

For individual field dimensions and details see figure B-1 (Baseball), figure B-8 (Football), and figure B-6 (Softball).

For grading and drainage details see figure G-4.

For surfacing details see figure G-5.

Figure D-4. Combination sports fields.

D-5. Sports fields within running tracks (see fig D-5)

a. *Source of information.* Football: National Collegiate Athletic Association (NCAA); Soccer: United States Soccer Federation (USSF).

b. *Recommended area.* Ground space is approximately 4.1 acres.

c. *Size and dimensions.* See figures C-1 and C-2 for track details. See figures B-8 and B-9 for football field details and figures B-12 and B-13 for soccer field details. Overall length is 600 feet. Overall width is 276 feet.

d. *Orientation.* See paragraph C-id for orientation details.

e. *Surface and drainage.*

(1) Surfaces will be in accordance with the provisions as stated in appendix C for the particular sports field.

(2) Drainage. Details for drainage may be obtained from the NCAA. See figures C-I and C-2 for 400 m track grading and drainage.

f. *Special considerations.* Special considerations will be those stated for the particular sport or event as stated in appendix C.

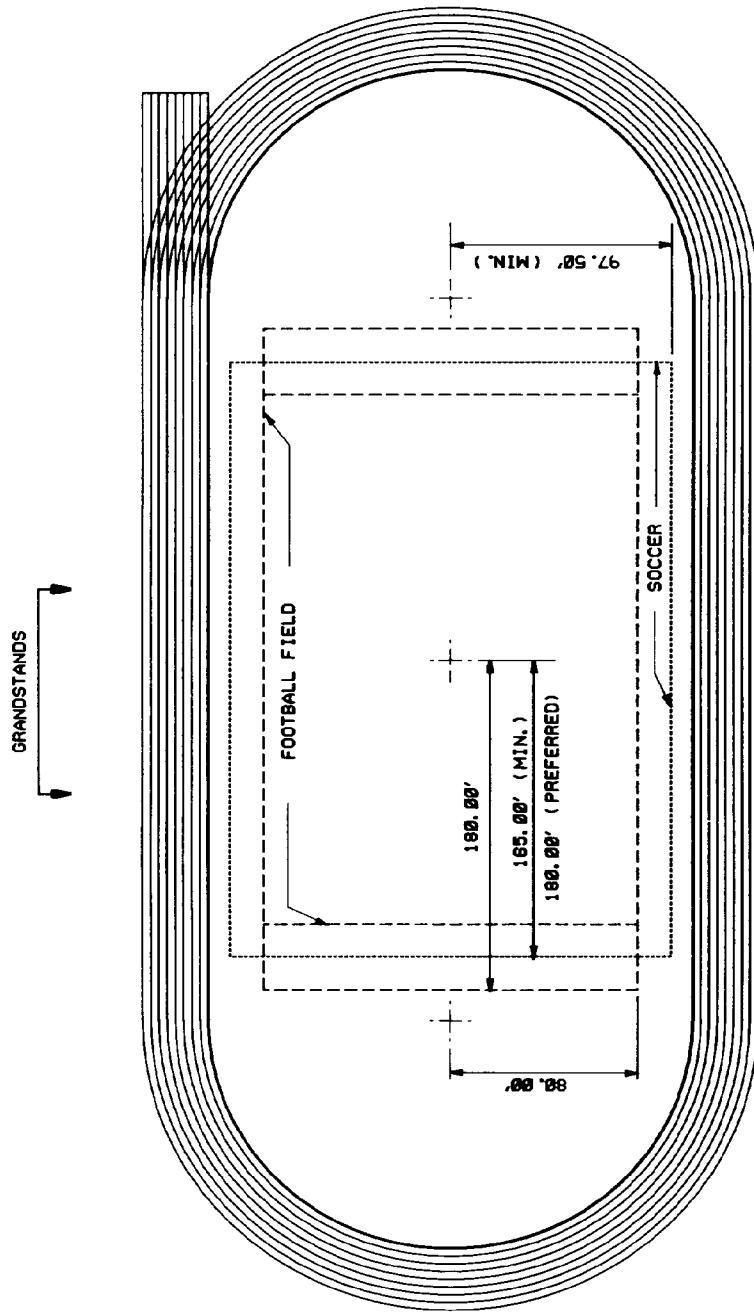

TRACK AND FIELDS LAYOUT

NOTES:

For dimensions and details see figure B-8 (Football), figure B-12 (Soccer), and figure C-1 (400-Meter Running Track).

For grading and drainage details see figure G-4.

For surfacing details see figure G-5.

Figure D-5. Sports fields within running tracks.

D-6. Multiple field events within running tracks (see fig D-6)

- a. Source of information.* National Collegiate Athletic Association (NCAA).
- b. Recommended area.* Ground space is approximately 4.1 acres.
- c. Size and dimensions.* See figures C-1 and C-2 for track details. See figure C-3 for shot put, figure C-7 for long jump and triple jump, figure C-8 for pole vault, and figure C-9 for high jump.
- d. Orientation.* See paragraph C-id for orientation details.
- e. Surface and drainage.*
 - (1) Surface will be in accordance with the provisions as stated in appendix C for the particular event.
 - (2) Drainage. Details for drainage may be obtained from the NCAA.
- f. Special considerations.* Special considerations will be those stated for the particular sport or event as stated in appendix C.

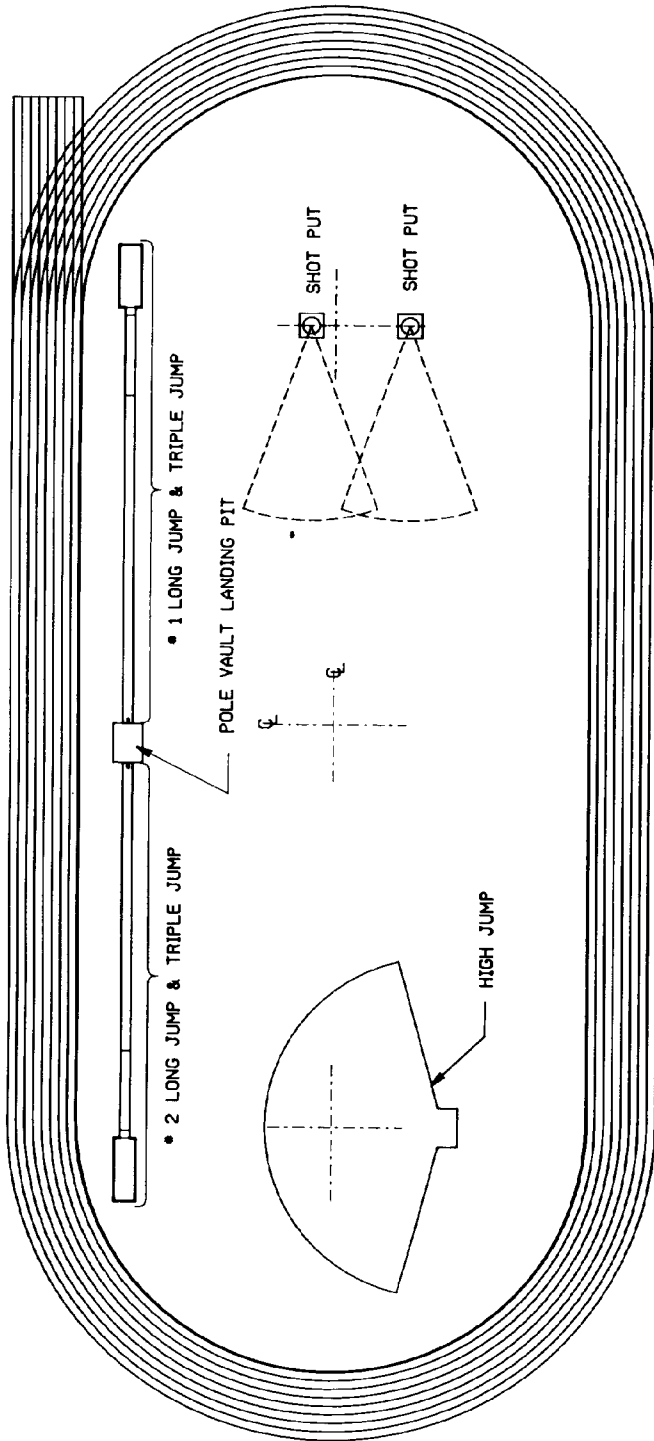

TRACK AND FIELD EVENTS LAYOUT

NOTES:

Discus, hammer, and javelin throwing areas shall be located outside of track for safety.

Pole vault landing pit may have to be removed to provide minimum runway length when #2 long jump and triple jump area is used.

See figures C-1, C-2, C-3, C-7, C-8, and C-9 for details and layout data for individual events. Grading and drainage information and other data can be ordered from NCAA.

Figure D-6. Multiple field events within running tracks.

APPENDIX E

RECREATIONAL SHOOTING RANGES

E-1. Archery, target range (see fig E-1)

- a. Source of information.* National Archery Association (NAA).
- b. Recommended area.* Ground space is 1.1 acres (49,000 square feet) minimum.
- c. Size and dimension.* Shooting range is 426.51 feet long with 16.40 feet minimum between targets. Roped clear space on each side of range is 32.81 feet minimum. Roped clear space behind targets should be at least 82 feet or 41 feet with bunker.
- d. Orientation.* Range will be located so that the archer is facing north plus or minus 45 degrees.
- e. Surface and drainage.*
 - (1) Surface is to be turf and free from obstructions or hard objects.
 - (2) Drainage is to be preferably from side to side to maintain a constant, relatively level elevation between the target and the archer at the various shooting distances.
- f. Special considerations.* Range warning signs will be provided on the sides and rear to warn people of the range.

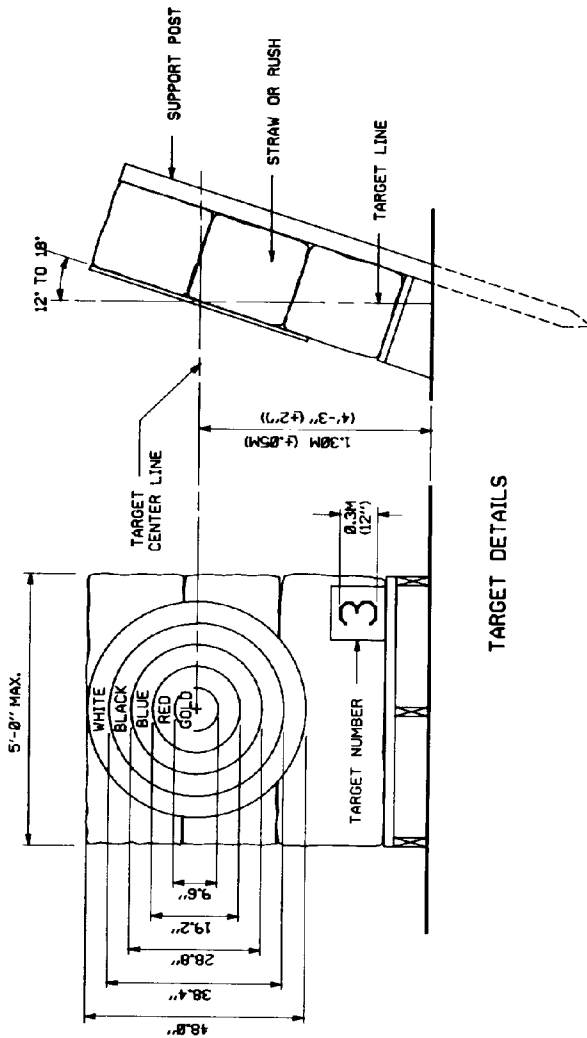

TARGET DETAILS

NOTES:

Background behind targets to be preferably dense trees, natural or manmade hills or protective shields.

F.I.T.A. (Olympic) rounds require 80cm(31.5") target faces and a 90M range. See the official N.A.A. rulebook for details.

Targets may be mounted on a round butt of spirally sewn straw or rush supported by a portable soft wood target stand. Colors may be painted on an oilcloth cover.

NAA CHAMPIONSHIP ROUNDS

DIVISION	FIRING DISTANCE	ARROWS PER DISTANCE
900 METRIC	60, 50, 40 METERS	30, 30, 30
COLLEGIATE	50, 40, 30 METERS	20, 20, 20
JUNIOR 900 (UNDER 15 YRS)	50, 40, 30 METERS	30, 30, 30
CADET 900 (UNDER 12 YRS)	40, 30, 20 METERS	30, 30, 30
EASTON (TEAMS)	60, 50, 40 METERS	20, 20, 20

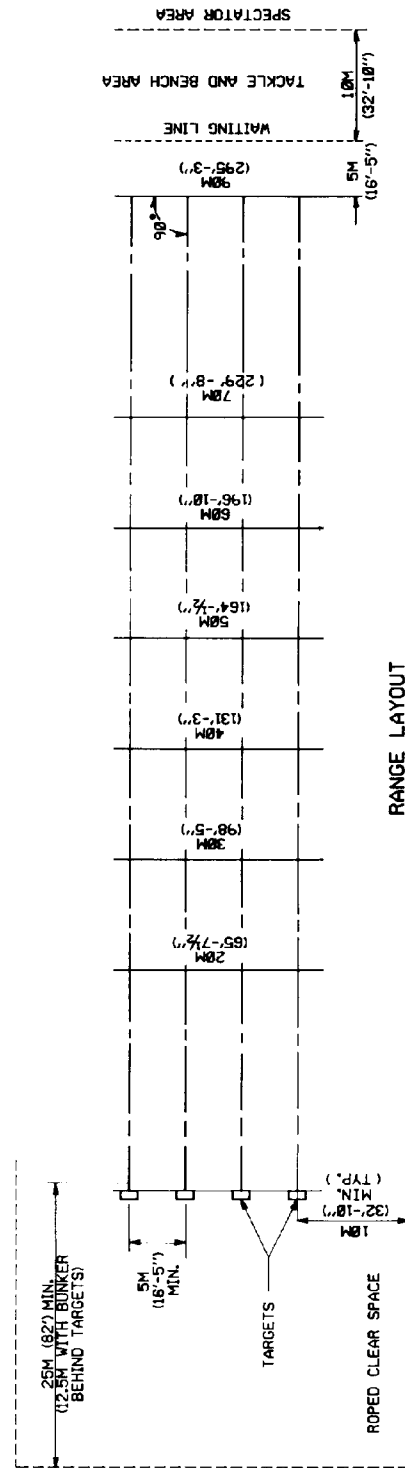

RANGE LAYOUT

Figure E-1. Archery, target range.

E-2. International shooting union automatic trap (see fig E-2)

- a. *Source of information.* National Rifle Association (NRA).
- b. *Recommended area.* Allow 15 acres for a single field.
- c. *Size and dimension.*
 - (1) Walks and structure occupy an overall area approximately 60 feet deep by 45 feet wide.
 - (2) Shooting stations may be 36 inches to 40 inches square.
- d. *Orientation.* Preferred orientation is for the center line through station No. 3 to run northeast-southwest with the shooter facing northeast.
- e. *Surface and drainage.* Shooting stations are to be portland cement concrete (PCC). Walkways may or may not be paved. Shooting area and 75 to 82 yard radius minimum cleared area are to be turf. The 300 yard radius shotfall danger zone outside of the cleared area may be turf, water, or left in natural condition, and the entire field should be located in a relatively flat area with an open background.
- f. *Special considerations.*
 - (1) If shooting is entirely over land there should be safety provisions for fencing, posting of warning signs and clearing away of concealing brush.
 - (2) If shooting is over water, warnings posted on buoys or other signs are required and the trap house should be back far enough from the water's edge to permit recovery of unbroken targets.
 - (3) Range safety will be in accordance with installation safety requirements and outdoor range safety manuals.
 - (4) Contact the National Rifle Association for information on trap house construction and trap machines.

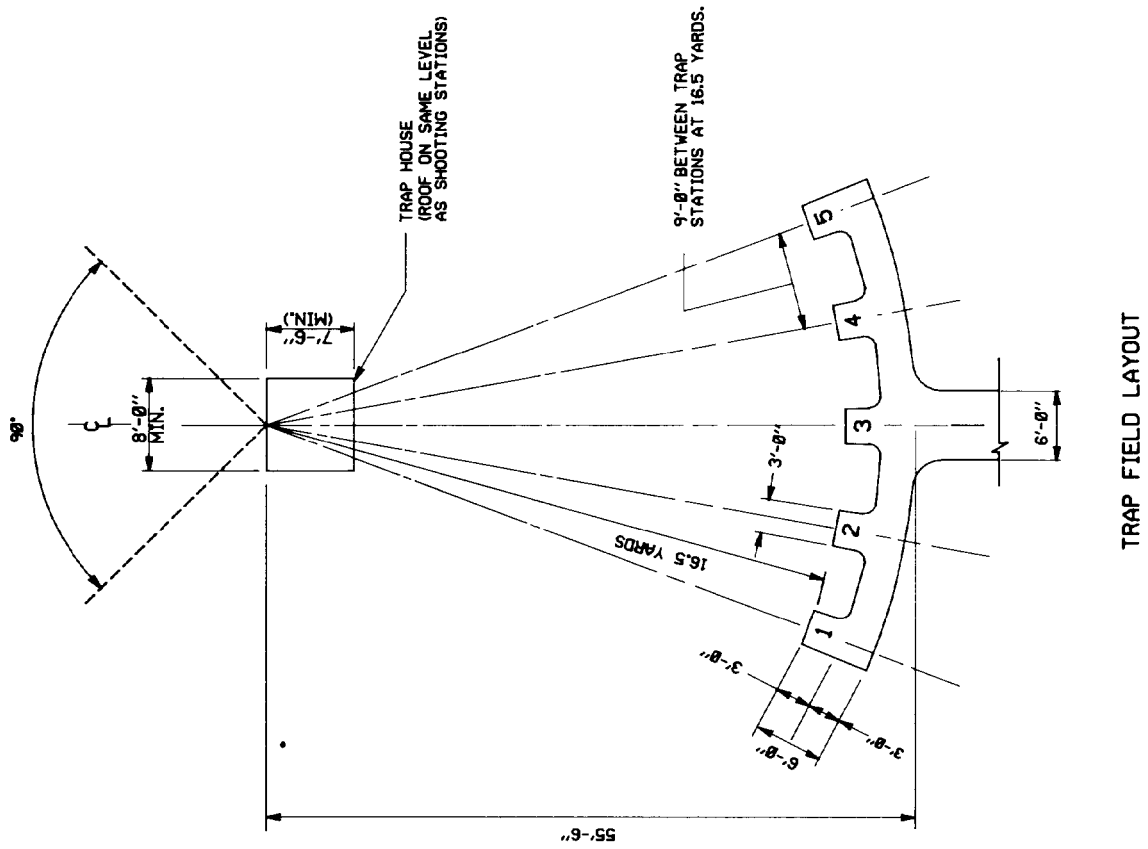

TRAP FIELD LAYOUT

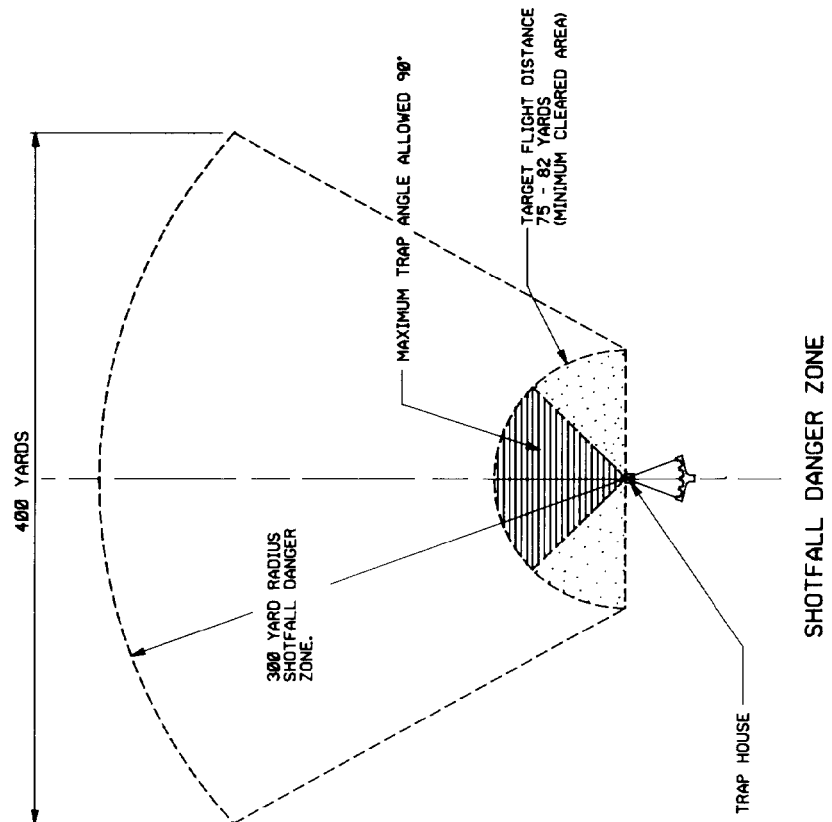

SHOTFALL DANGER ZONE

Figure E-2. International shooting union automatic trap.

E-3. Skeet field (see fig E-3)

a. *Source of information.* National Skeet Shooting Association (NSSA), 1974.

b. *Recommended area.* Allow 29 acres for a single field. Shotfall danger zones of adjacent fields partially overlap and require only 2 acres additional land.

c. *Size and dimension.* Walks and structures occupy an area approximately 130 feet wide by 80 feet deep. Minimum cleared area is semi-circle with a radius of 100 yards (3.25 acres). Shotfall danger zone is a semi-circle with a radius of 300 yards (29 acres).

d. *Orientation.* Preferred orientation is for the center line from station No. 4 through station No. 8 to run northeast-southwest with the shooter facing northeast.

e. *Surface and drainage.* Shooting stations are to be portland cement concrete (PCC). Walkways may or may not be paved. Shooting area and 100-yard radius minimum cleared area are to be turf. The 300-yard radius shotfall danger zone may be turf, water, or left in natural condition, and the entire field should be located in a relatively flat area with an open background.

f. *Special considerations.*

(1) If shooting is entirely over land, there should be safety provisions for fencing, posting of warning signs and clearing away of concealing brush.

(2) If shooting is over water, warnings posted on buoys or other signs are required, and skeet houses should be back far enough from the water's edge to permit recovery of unbroken targets.

(3) Range safety will be in accordance with installation safety requirements and outdoor range safety manuals.

(4) Contact the National Rifle Association for information on skeet house construction and trap machines.

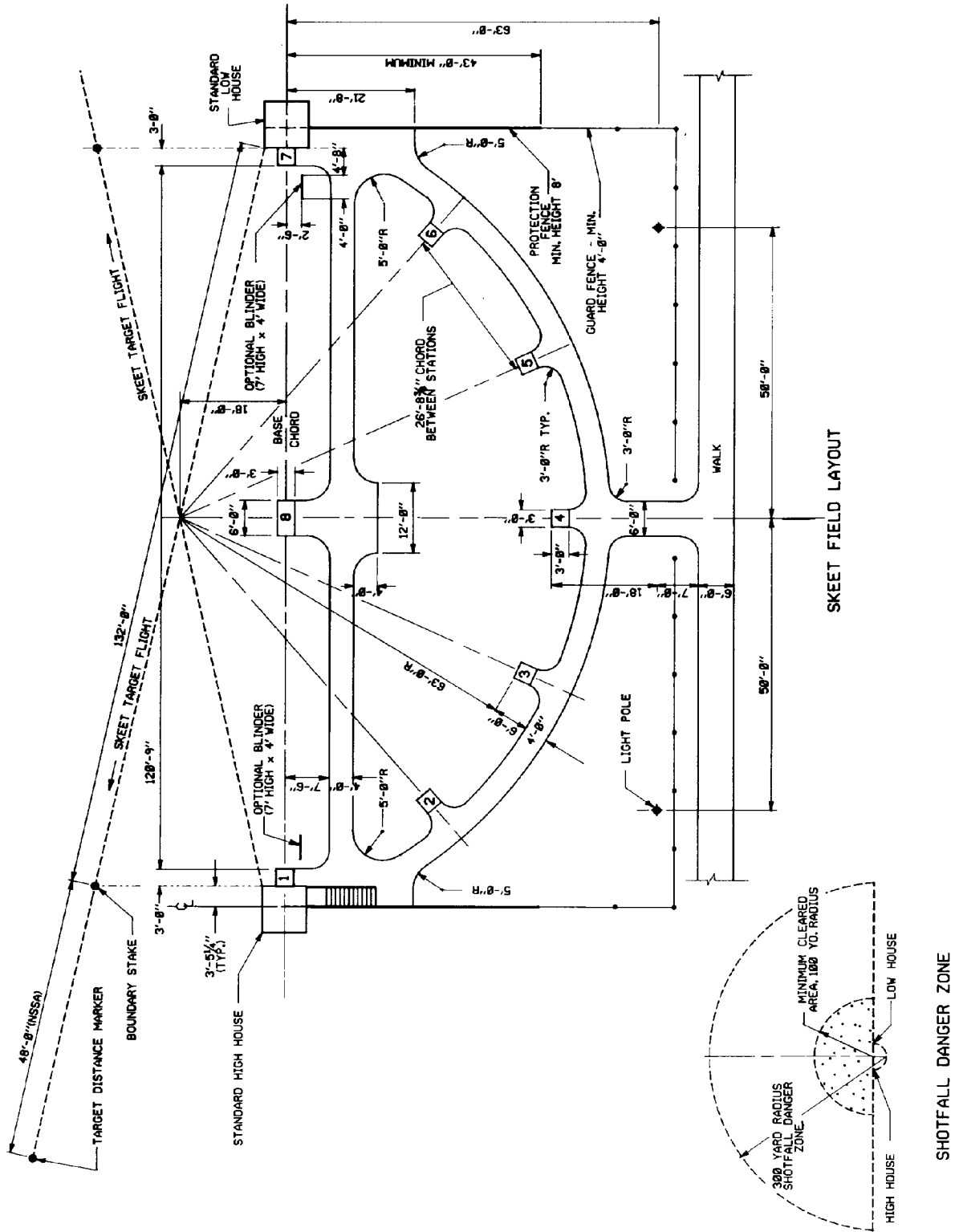

Figure E-3. Skeet field.

SHOTFALL DANGER ZONE

E-4. Trap field (see fig E-4)

- a. *Source of information.* Amateur Trapshooting Association (ATA).
- b. *Recommended area.* Allow 18 acres for a single field. Shotfall danger zones of adjacent trap fields may overlap.
- c. *Size and dimension.* Walks and structures occupy an overall area approximately 100 feet deep by 65 feet wide. Minimum cleared area is a section with a radius of 100 yards (3.0 acres). Shotfall danger zone is a section with a radius of 300 yards (14.8 acres).
- d. *Orientation.* Preferred orientation is for the center line through shooting station No. 3 to run northeast-southwest with the shooter facing northeast.
- e. *Surface and drainage.* Shooting stations are to be portland cement concrete (PCC). Walkways may or may not be paved. Shooting area and 100-yard radius minimum cleared areas are to be turf. The 300-yard radius shotfall danger zone may be turf, water or left in natural condition, and the entire field should be located in a relatively flat area with an open background.
- f. *Special considerations.*
 - (1) If shooting is entirely over land there should be safety provisions for fencing, posting of warning signs and clearing away of concealing brush.
 - (2) If shooting is over water, warnings posted on buoys or other signs are required, and the trap house should be back far enough from the water's edge to permit recovery of unbroken targets.
 - (3) Range safety will be in accordance with installation safety requirements and outdoor range safety manuals.
 - (4) Contact the National Rifle Association for information on trap house construction and trap machines.

E-5. Combination skeet and trap field (see fig E-5)

a. *Source of information.* Skeet: National Skeet Shooting Association (NSSA). Trap: Amateur Trapshooting Association (ATA).

b. *Recommended area.* Allow 30 acres for a combination field.

c. *Size and dimension.* All walks and structures occur within an area approximately 130 feet wide by 115 feet deep. Minimum cleared area is contained within two superimposed segments with a 100-yard radii (4 acres). Shotfall danger zone is contained within two superimposed segments with 300-yard radii (36 acres).

d. *Orientation.* Preferred orientation is for the center line from skeet station No. 4 through trap station No. 3 to skeet station No. 8 to run northeast-southwest with the shooter facing northeast.

e. *Surface and drainage.* Shooting stations are to be portland cement concrete (PCC). Walkways may or may not be paved. Shooting area and minimum cleared area are to be turf. Shotfall danger zone may be turf, water, or left in natural condition, and the entire field should be located in a relatively flat area with an open background.

f. *Special considerations.*

(1) If shooting is entirely over land there should be safety provisions for fencing, posting of warning signs and clearing away of concealing brush.

(2) If shooting is over water, warnings posted on buoys or other signs are required, and the trap house should be back far enough from the water's edge to permit recovery of unbroken targets.

(3) Range safety will be in accordance with installation safety requirements and outdoor range safety manuals.

(4) Contact the National Rifle Association for information on skeet and trap house construction and trap machines.

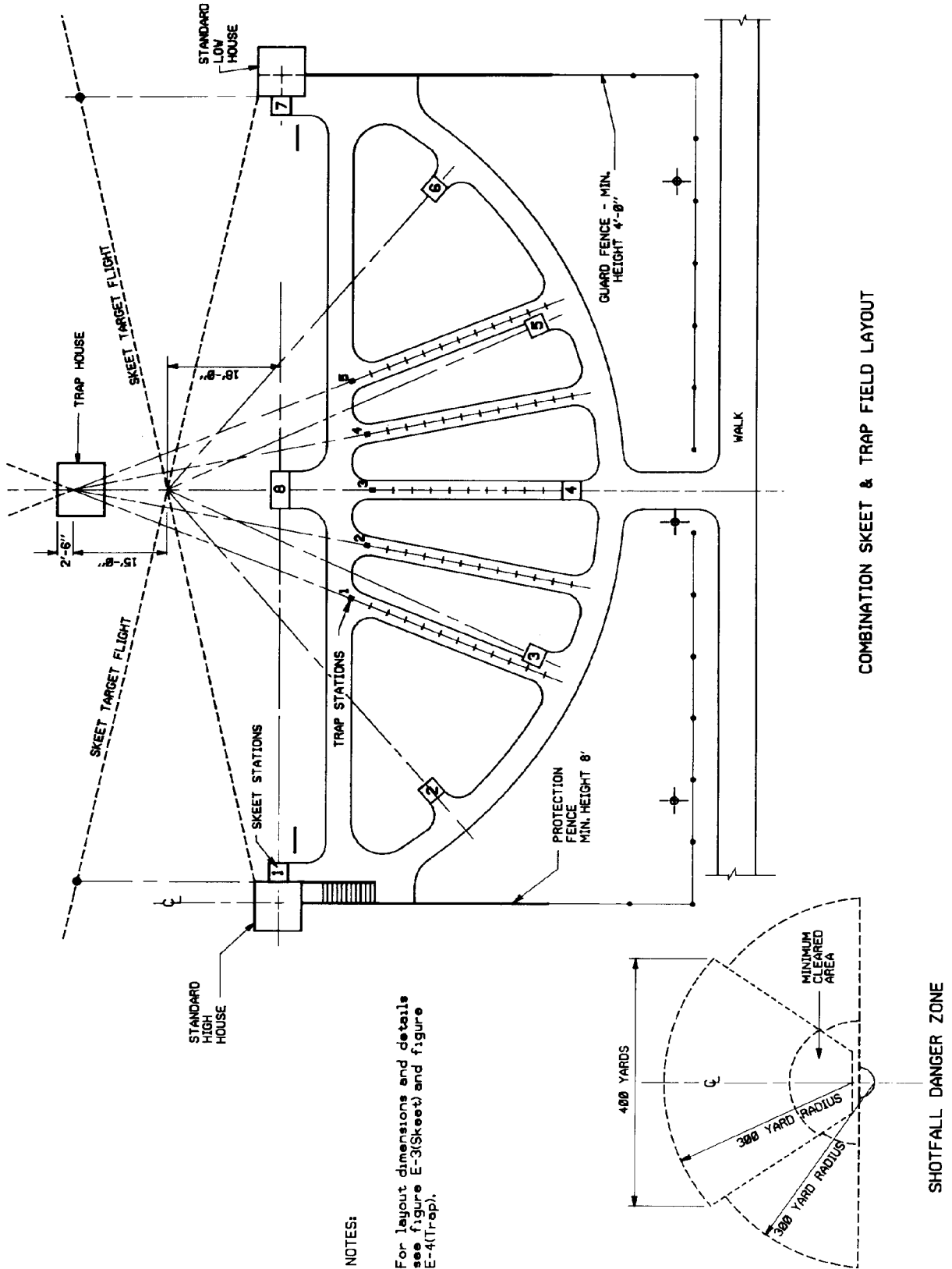

NOTES:
 For layout dimensions and details see figure E-3(Skeet) and figure E-4(Trap).

Figure E-5. Combination skeet and trap field.

APPENDIX F

MOTOR SPORTS

F-1. Go kart (oval track) (see fig F-1)

- a. *Source of information.* International Kart Federation, Inc. (IKF).
- b. *Recommended area.* Ground area varies from 2.0 to 2.7 acres.
- c. *Size and dimension.* Specific track layout data are given in figure F-1. Track surface width in a turn should be a minimum of 5 feet wider than straightaway width.
- d. *Orientation.* The track should be located so that the long axis points roughly north-south. The start-finish line should be located so that karts cross the line traveling north.
- e. *Surface and drainage.*
 - (1) Track surfaces can be asphalt, concrete or dirt graded to a smooth surface, free of holes and rough spots. Gravel surfaces are not permitted. Banked turns are permitted, but flat tracks with no banked turns are strongly recommended.
 - (2) Inlets and underground pipes are normally needed to drain the inside of oval.
- f. *Special considerations.*
 - (1) A 35-foot minimum width safety apron should be maintained around entire track on all sides. This area must be free of ditches, holes, trees and all other obstacles. Safety apron should be loose dirt graded flat or with a maximum 2 percent slope for drainage.
 - (2) If a paved track is used, the pit area should be paved also.

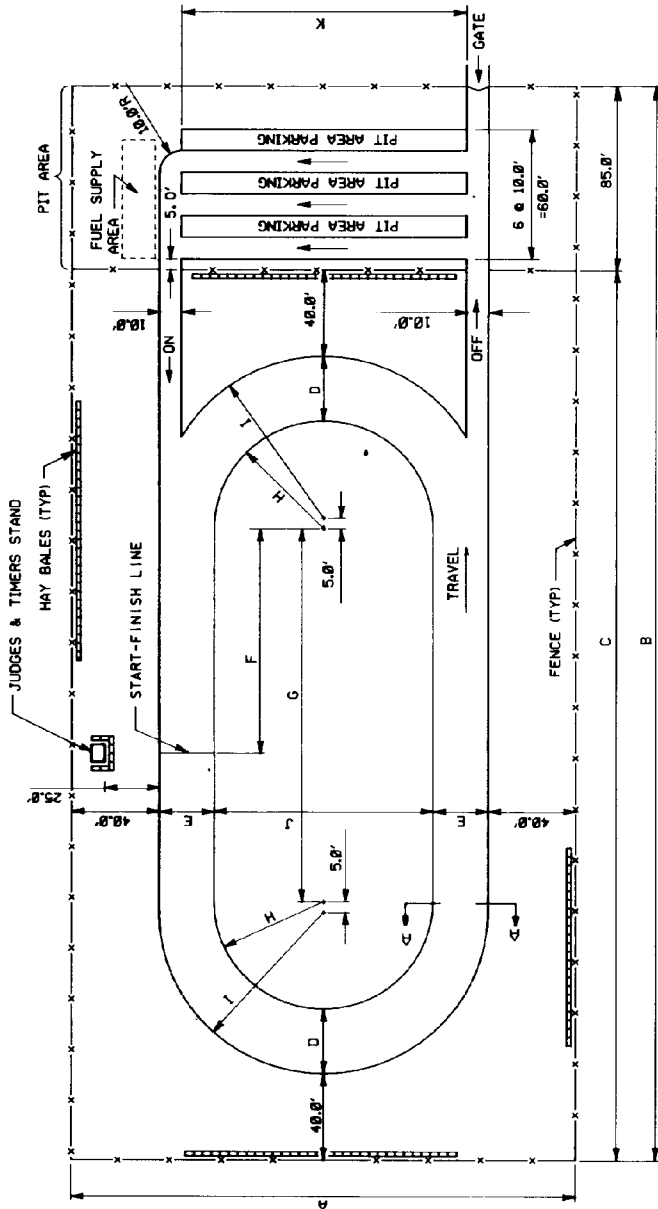

GO KART OVAL TRACK LAYOUT

OVAL TRACK LAYOUT DATA (ALL DIMENSIONS IN FEET)

TRACK LENGTH	A	B	C	D	E	F	G	H	I	J	K
1/12 MILE OVAL	210	415.1	330.1	35	30	66.00	110.1	35	65	70	110
1/10 MILE OVAL	210	443.4	358.4	30	25	83.04	138.4	40	65	80	110
1/8 MILE OVAL	230	498.0	413.0	30	25	103.80	173.0	50	75	100	130

NOTES:

See figure F-2 for SECTION A-A.

IKF recommends a track length of at least 1/8 mile for national competition.

Protective hay bales shall be placed 2' away from fences and judges stand.

Track length measurement shall be along the inside edge of track.

A maximum grade of 10% is permitted in direction of travel.

Track, pit, and spectator area shall each be separated by a fence.

The layout in this figure and in figure F-2 are suggested. For more layouts and safety information, contact IKF.

Figure F-1. Go kart (oval track).

F-2. Go kart (road track) (see fig F-2)

- a. *Source of information.* International Kart Federation, Inc. (IKF).
- b. *Recommended area.* Ground space is approximately 5.5 acres.
- c. *Size and dimension.* Track surface width in an oval turn should be a minimum of 5 feet wider than straightaway track width.
- d. *Orientation.* The track long axis will point north-south. Kart will cross start-finish line traveling north.
- e. *Surface and drainage.* Track surfaces may be asphalt, concrete or dirt graded to a smooth surface, free of holes and rough spots. Gravel surfaces are not permitted. Banked turns are permitted, but flat tracks with no banked turns are strongly recommended. Inlets and underground pipes are required for draining the inside of track.
- f. *Special considerations.*
 - (1) A 35-foot (minimum width) safety apron will be maintained around entire track on all sides. This area must be free of ditches, holes, trees and all other obstacles. Safety apron will be loose dirt graded flat or with a maximum of 2 percent slope for drainage.
 - (2) When a paved track is used, the pit area will be paved also.

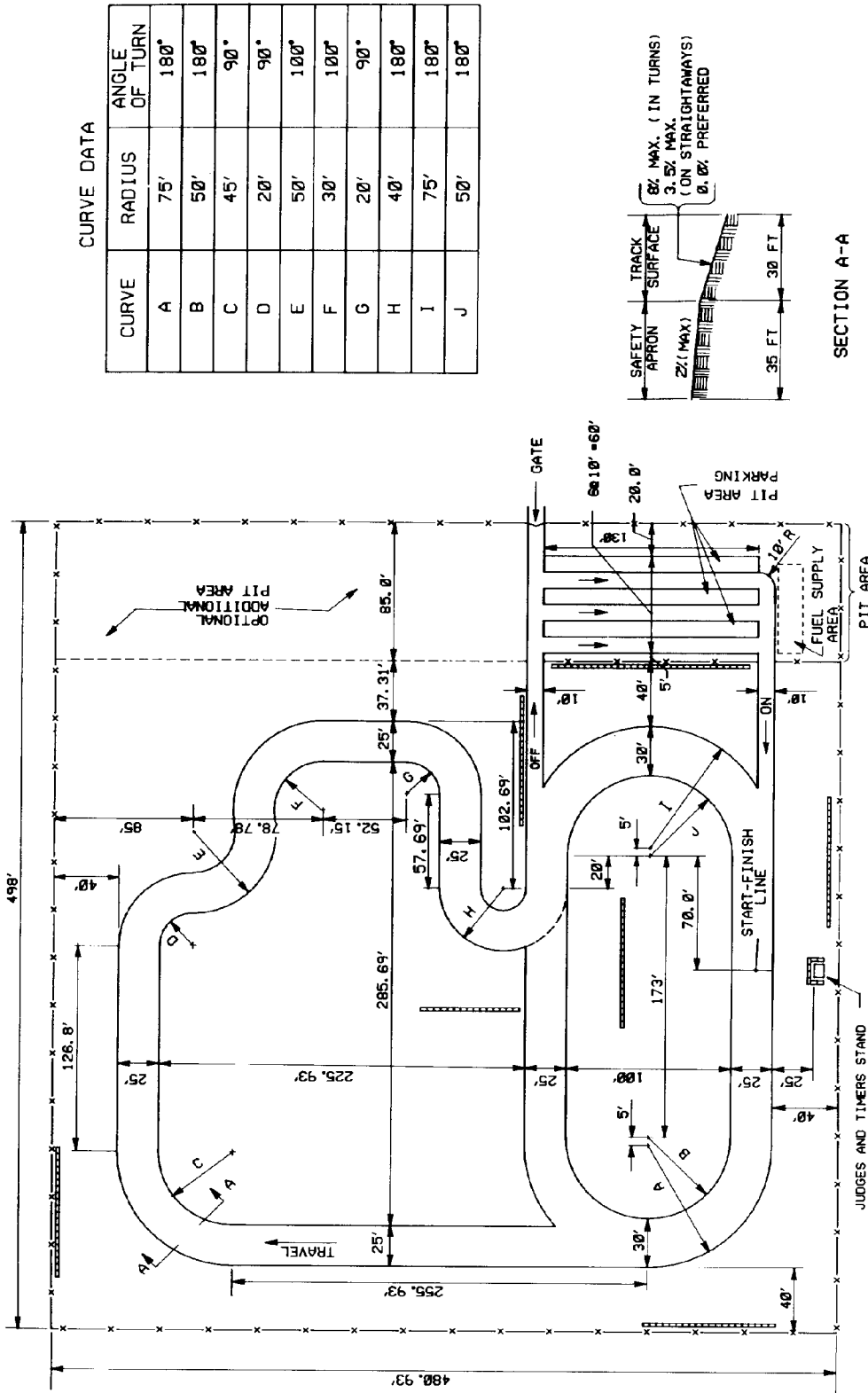

CURVE DATA

CURVE	RADIUS	ANGLE OF TURN
A	75'	180°
B	50'	180°
C	45'	90°
D	20'	90°
E	50'	100°
F	30'	100°
G	20'	90°
H	40'	180°
I	75'	180°
J	50'	180°

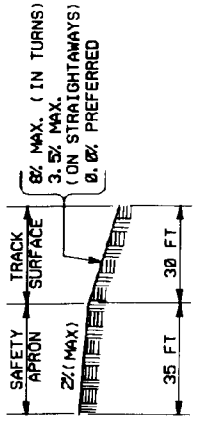

SECTION A-A

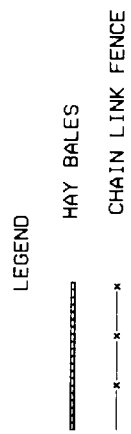

COMBINATION 1/4 MILE ROAD TRACK AND 1/8 MILE OVAL TRACK LAYOUT

NOTE:
See figure F-1 for notes.

Figure F-2. Go kart (road track).

APPENDIX G
CONSTRUCTION DETAILS

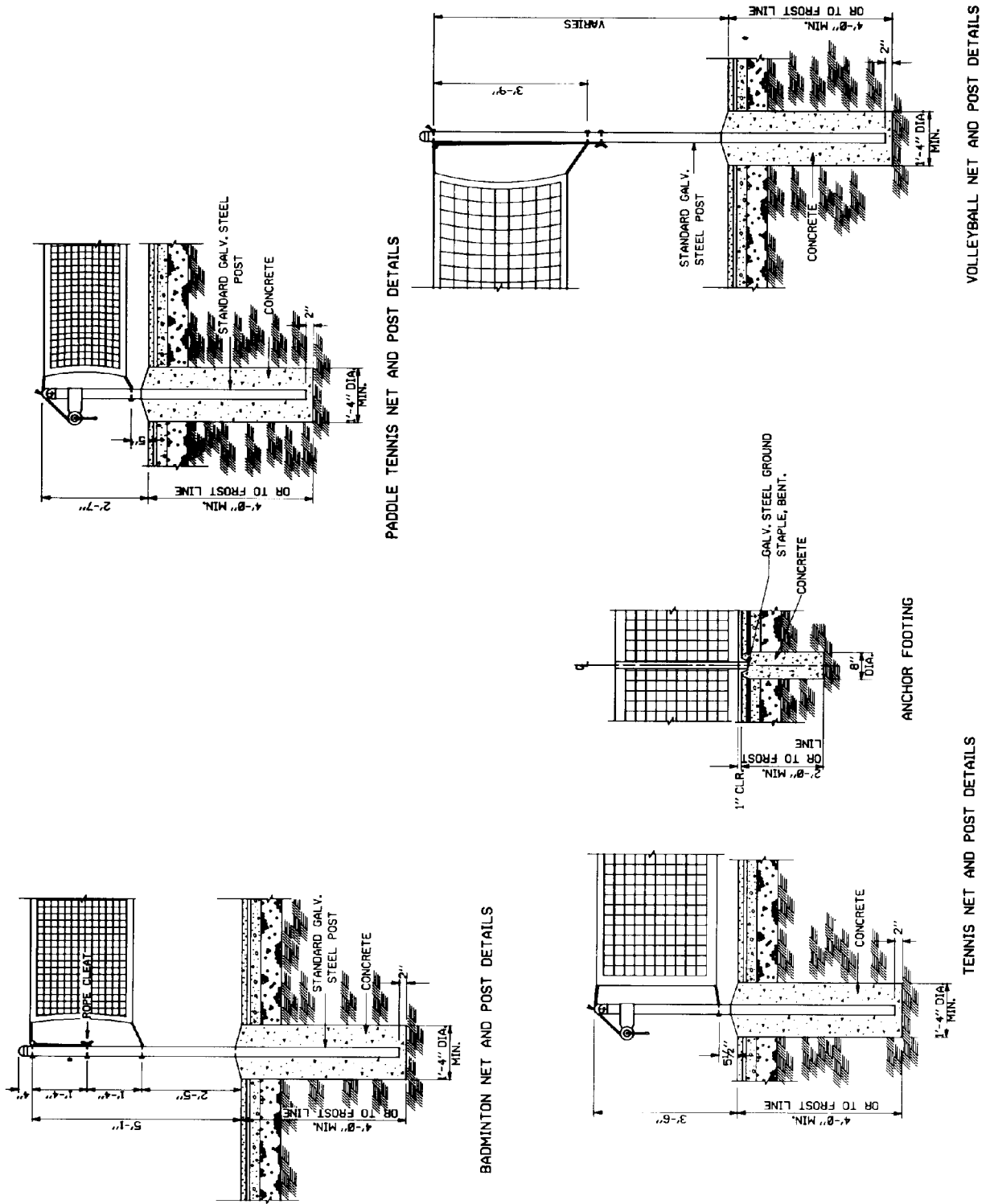
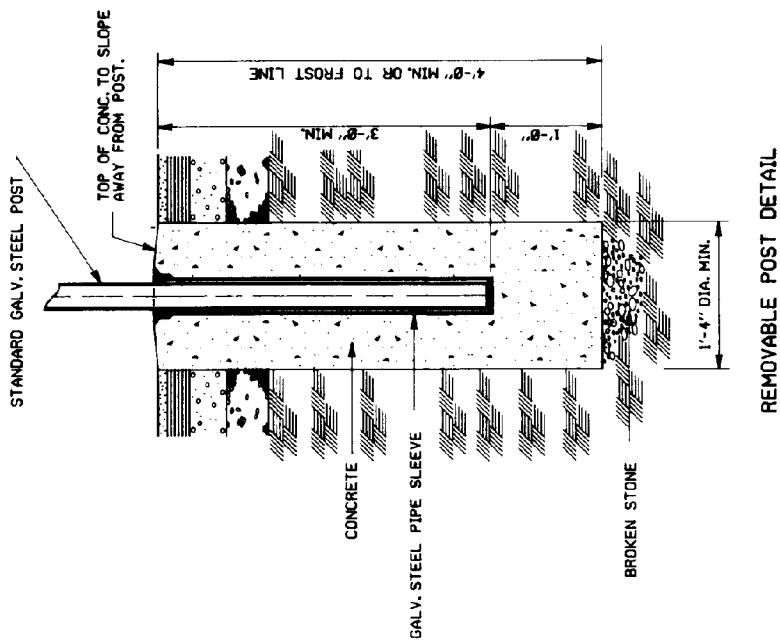

Figure G-1. Fixed net posts.



NOTES:

- Opening in pipe sleeve to be closed with deck plate when post is removed.
- If posts are to be painted, they shall be etched with acid, primed and painted with a good exterior enamel.

Figure G-2. Removable net posts.

BASKETBALL GOAL POST NOTES:
 Adjustable standard for handicapped is available.

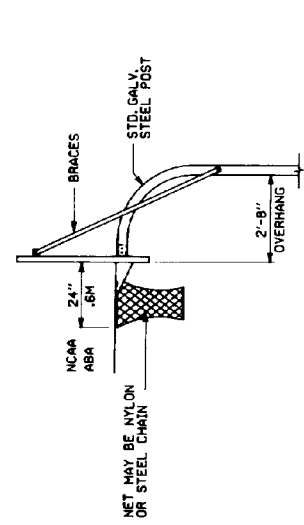

DETAIL-BASKETBALL GOAL WITH NON-REGULATION OVERHANG

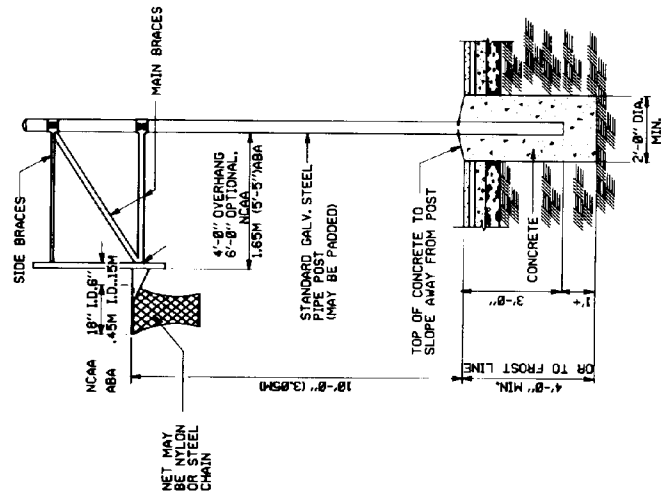

DETAIL-BASKETBALL GOAL WITH REGULATION OVERHANG

FOOTBALL GOAL POST NOTES:

All pipe should be etched with acid before painting and then primed before applying a good exterior enamel.

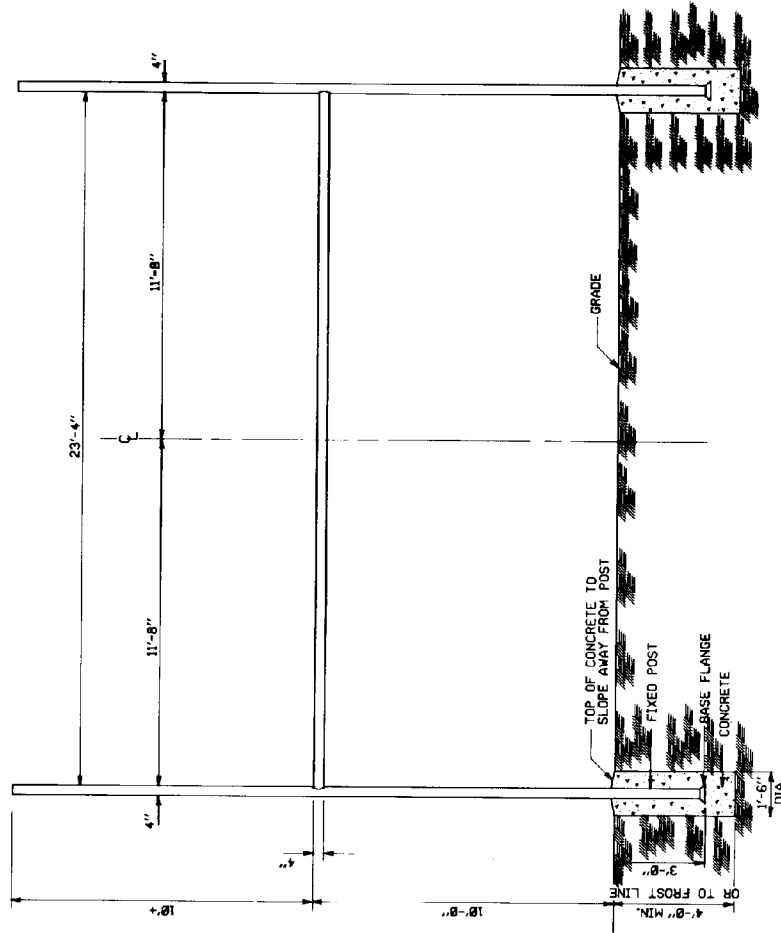

11 MAN & TOUCH AND FLAG FOOTBALL GOAL POSTS

Figure G-3. Football and basketball goal post details.

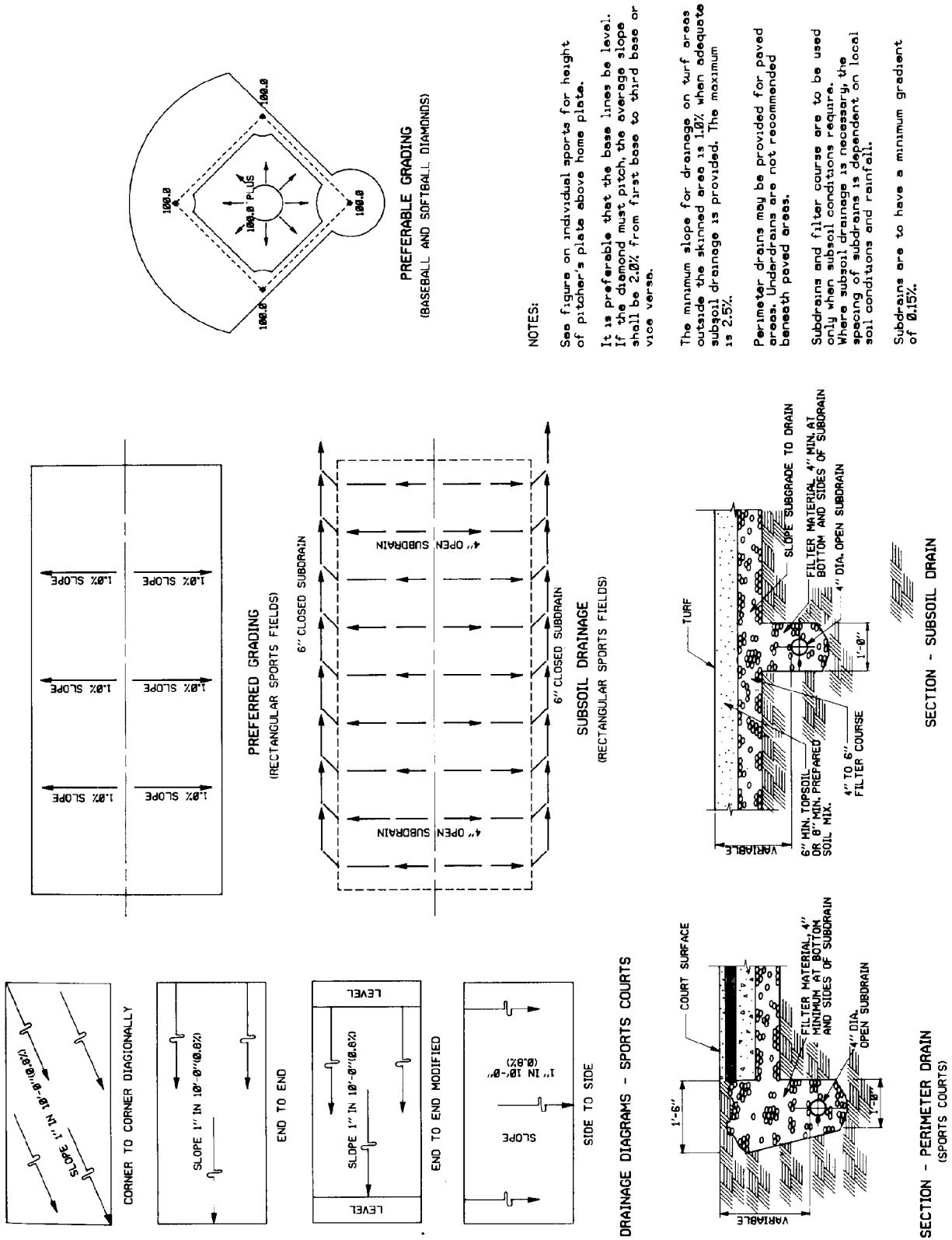
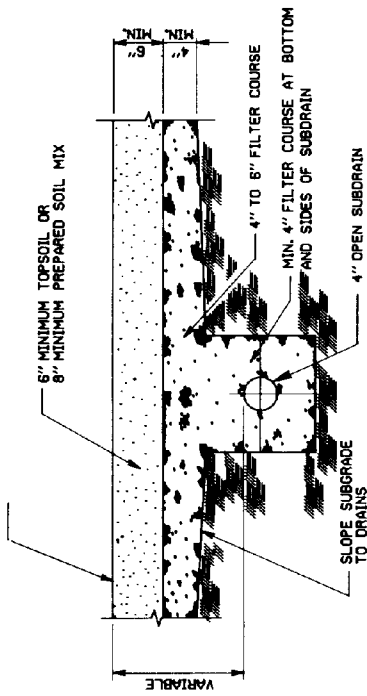
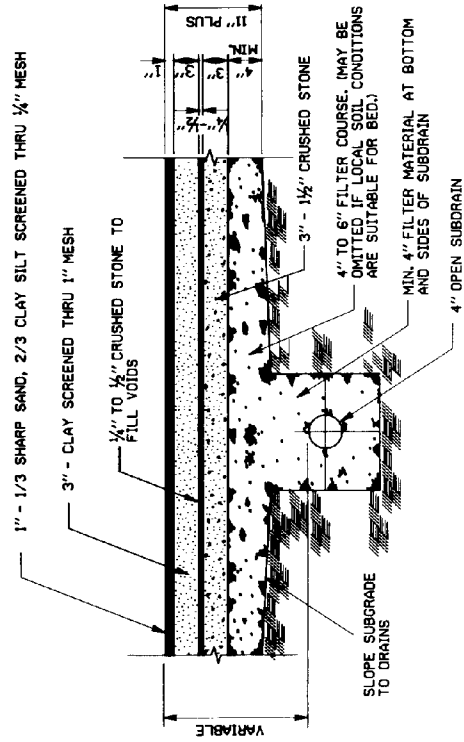

Figure G-4. Typical grading and drainage details.



TYPICAL SECTION - NATURAL TURF



TYPICAL SECTION - SAND CLAY

NOTES:

Install all underground utilities before constructing playing surfaces or walks.

Figure G-5. Typical playing surface.