

12

DOT/FAA/CT-82/130-I

# Flying Qualities of Relaxed Static Stability Aircraft - Volume I

## Flying Qualities Airworthiness Assessment and Flight Testing of Augmented Aircraft

Roger H. Hoh  
David G. Mitchell

Systems Technology, Incorporated  
13766 South Hawthorne Boulevard  
Hawthorne, California 90250

September 1982

Final Report

This document is available to the U.S. public through the National Technical Information Service, Springfield, Virginia 22161.

DTIC  
SELECTED  
JUN 1 1983  
S H D

AD A 128 758

DTIC FILE COPY



US Department of Transportation  
Federal Aviation Administration  
Technical Center  
Atlantic City Airport, NJ. 08405

83 05 31 112

1. Report No. DOT/FAA/CT-82/130-I		2. Government Accession No. AD-A128 758		3. Recipient's Catalog No.	
4. Title and Subtitle FLYING QUALITIES OF RELAXED STATIC STABILITY AIRCRAFT - VOLUME I				5. Report Date September 1982	
7. Author(s) Roger H. Hoh, David G. Mitchell (Volume I) Duane McRuer, Thomas T. Myers (Volume II)				6. Performing Organization Code	
9. Performing Organization Name and Address Systems Technology, Incorporated 13766 S. Hawthorne Boulevard Hawthorne, CA 90250				8. Performing Organization Report No. TR-1178-1-I	
12. Sponsoring Agency Name and Address Department of Transportation Federal Aviation Administration Technical Center Atlantic City Airport, NJ 08405				10. Work Unit No. (TRAIS)	
				11. Contract or Grant No. DTFA-03081-C-00069	
				13. Type of Report and Period Covered Final Report August 1981 - Oct. 1982	
				14. Sponsoring Agency Code	
15. Supplementary Notes Volume I. Flying Qualities Airworthiness Assessment and Flight Testing of Augmented Aircraft. Volume II. Ramifications of Flight-Essential/Critical Heavily-Augmented Airplane Characteristics on Flying Qualities.					
16. Abstract <p>Volume I of the report deals with airworthiness assessment and flying qualities evaluation of highly augmented aircraft covered by Parts 23 and 25 of the Federal Aviation Regulations. Particular emphasis has been placed on aircraft with relaxed static stability and on the use of active augmentation systems to achieve the minimum requirement for a level of safety in such aircraft. Significant modifications and expansion to the FAA Engineering Flight Test Guides are detailed.</p> <p>Volume II supports the work of Volume I and provides the more analytically oriented research results of this report. Emphasis is placed on determining the relative similarities and differences between heavily augmented and conventional aircraft. A number of important generic distinctions have been found and are described and explained.</p>					
17. Key Words Flying Qualities Relaxed Static Stability Augmented Flight Control Systems Minimum Requirements for Safety			18. Distribution Statement Document is available to the U.S. public through the National Technical Information Service, Springfield, Virginia 22161		
19. Security Classif. (of this report) Unclassified		20. Security Classif. (of this page) Unclassified		21. No. of Pages 100	22. Price

PREFACE

The research reported herein was accomplished under Contract DTFA-03-81-C-00069 for the Department of Transportation, Federal Aviation Administration Technical Center at Atlantic City Airport, New Jersey. The contracting officer's technical representative (COTR) was Mr. Joseph J. Traybar (ACT-340), Flight Safety Research Branch, Aircraft Safety Development Division.

The authors wish to express their gratitude to Mr. Joseph Traybar for his many helpful comments and guidance during the performance of this work as well as for his considerable contributions during the review of this report.



Accession For	
NTIS GRA&I	<input checked="" type="checkbox"/>
DTIC TAB	<input type="checkbox"/>
Unannounced	<input type="checkbox"/>
Justification	
By _____	
Distribution/ _____	
Availability Codes	
Dist	Avail and/or Special
A	

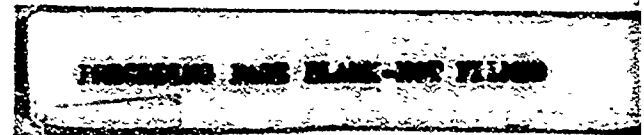

## TABLE OF CONTENTS

	<u>Page</u>
EXECUTIVE SUMMARY	xi
I. INTRODUCTION	
A. Background.....	1
B. Organization of Report (Volume I).....	2
II. EVALUATION FACTORS FOR FLIGHT TESTING OF AUGMENTED AIRCRAFT.....	4
A. Background.....	4
B. Pilot Centered Requirements.....	5
C. Recommended Piloting Tasks.....	9
III. BASIC CONCEPTS.....	11
A. Stick-Fixed and Stick-Free Static Stability.....	11
B. Effect of Center of Gravity Location on on Static and Dynamic Stability.....	15
IV. EFFECT OF AUGMENTATION ON STATIC AND DYNAMIC STABILITY.....	28
A. Functional Characteristics of Typical Stability Augmentors.....	28
B. Active Augmentation -- Reversible Flight Control Systems.....	33
C. Passive Augmentation -- Reversible Flight Control Systems.....	35
D. Active Augmentation -- Irreversible Flight Control Systems.....	41
E. Passive Augmentation -- Irreversible Flight Control Systems.....	57
F. Effect of Turbulence on Augmentation Systems.....	59
V. AUGMENTATION SYSTEM FAILURES.....	64
VI. CONSIDERATIONS FOR MODIFYING AND UPDATING THE ENGINEERING FLIGHT TEST GUIDES.....	67
A. General.....	67
B. Minimum Requirements for "a Level of Safety".....	67
C. Specific Recommendations for the Flight Test Guide.....	68
CONCLUSIONS.....	80
REFERENCES.....	83

## LIST OF FIGURES

	<u>Page</u>
1a. Cooper-Harper Pilot Rating Scale (Reference 7).....	7
1b. Elements of Control Loop That Influence Handling Qualities....	8
2. Effect of Evaluation Task on Pilot Ratings.....	10
3. Basic Notation Used for Defining Static Stability.....	12
4. Effect of C.G. Location on Classical Aircraft Stick-Free Response Characteristics (Same size and duration pulse input for all cases).....	16
5. Time Response of Classical Unaugmented Aircraft to a Pitch Control Pulse Input.....	22
6. Effect of Center of Gravity Location on the Pitch Attitude Poles and Zeros.....	24
7. Relationship Between Time Response and Aircraft Poles.....	25
8. Generic Augmentation Block Diagram.....	29
9. Generic Representation of Reversible and Irreversible Flight Control Systems.....	32
10. Effect of Control System on Augmentation.....	34
11. Effect of Increasing Downspring on the Phugoid Mode.....	37
12. Generic Survey of Pitch Attitude Control Systems.....	43
13. Generic Augmentation of Pitch Axis.....	47
14. Comparison of Conventional and Augmented Time Responses to a Pulse Input.....	48
15. Pitch Attitude Command System.....	51
16. Pitch Rate Command System.....	51
17. Derived Quantities for Which Significant Differences Occurred.....	54
18. Root Locus and Pulse Response for a System with Airspeed Feedback.....	56

**LIST OF FIGURES (CONCLUDED)**

	<u>Page</u>
19. High Speed Airliner Response With Simple Q-Type Artificial Feel System (From Reference 28).....	60
20. The 727 Feel System; and Empirical CG Computer System (From Reference 28).....	61
21. Modified Cooper-Harper Scale Suggested for Pass/Fail Guidance in Engineering Flight Test Guide.....	69

**LIST OF TABLES**

	<u>Page</u>
1. GUIDANCE VALUES RELATED TO FAR 25.181 OR FAR 23.181 (Taken from Reference 6 Para. 3.2.1.1).....	26
2. PITCH CONTROL SYSTEM FEATURES FOR CURRENT PART 25 AIRCRAFT....	58
3. MAXIMUM FORCES EXERTED ON AIRCRAFT CONTROL STICK (LBS) BY MEN AND WOMEN.....	71

$q$	Pitching angular velocity, rad/sec
$Q$	Dynamic pressure, lb/ft <sup>2</sup>
$s$	Laplace transform operator, sec <sup>-1</sup>
$S$	Reference planform area, ft <sup>2</sup>
$S_{wing}$	Wing area, ft <sup>2</sup>
$S_{tail}$	Area of horizontal tail, ft <sup>2</sup>
$t$	Time
$u$	Change in airspeed from trim, ft/sec
$V_o, U_o$	Trim speed, ft/sec
$V$	True air speed, ft/sec
$V_{trim}$	Trim airspeed, ft/sec
$\alpha$	Angle of attack, deg
$\gamma$	Flight path angle, deg
$\delta_e$	Elevator angle, deg
$\delta_{col}$	Cockpit control column deflection, deg
$\epsilon$	Downwash angle at tail, deg
$\zeta$	Damping ratio
$\omega$	Frequency, rad/sec

PROCESSED PAGE BLANK-NOT FILMED

## EXECUTIVE SUMMARY

Considerable attention has been given recently to the use of certain advanced aircraft configurations and flight control designs and the implementation of new system concepts in order to improve or optimize aircraft designs, flight characteristics, performance, and efficiency. Utilization of these new aircraft and system concepts to achieve these desired goals usually requires consideration of beneficial design factors (such as aft center of gravity and smaller sized tail-planes and empennage) that tend to cause poorer aircraft flying qualities characteristics for certain modes of flight. Therefore, for many new generation aircraft, it will be necessary to provide various tiers of stability and control augmentation to optimize the designs as well as compensate for potential problems associated with flying qualities safety requirements for failed-state conditions. The trend of using highly augmented flight systems is well established and indeed, in the recent NASA sponsored study for Energy Efficient Transports, the Boeing, Douglas, and Lockheed aircraft companies all recommend highly augmented airplanes for their proposed designs.

In the present study, the flying qualities of highly augmented aircraft are examined in the context of the current Federal Aviation Regulations (FAR) and supporting Engineering Flight Test Guides to determine if they require modification and/or updating. Also, attention is directed toward the determination of the data and information needed to adequately and efficiently assess the flying qualities airworthiness of highly augmented aircraft and systems to ensure that they meet the minimum requirements for a level of safety.

First, it must be clearly understood that the current flying qualities related FAR are based essentially on classical stability and control of unaugmented aircraft. Therefore, it was necessary to determine what specific differences exist between the flying qualities of classical unaugmented aircraft and the highly augmented (or super augmented) aircraft being proposed for greater performance and fuel efficiency. It has been the purpose of this study to make such determinations and updating of pertinent agency documents. The results of the study are presented in two volumes. Volume I contains a detailed review of the assessments as defined in the FAR and Engineering Flight Test Guides. Volume II contains a more detailed technical analysis of highly augmented and super augmented aircraft to provide analytical support for Volume I. The emphasis is on the longitudinal axis in keeping with the desire to provide fuel efficiency via relaxed static stability. However, some considerations of the lateral and directional axes have also been reviewed.

The difficulty in changing established regulations has been an overriding consideration, and suggestions to modify an existing FAR were made only when no alternative could be identified. In nearly all cases, the existing FAR have been found to be adequate with the important proviso that detailed interpretations and flight test procedures can be developed for inclusion in the supporting Engineering Flight Test Guide. However, it appears that the current versions of the Engineering Flight Test Guide do not provide adequate guidance to support the flying qualities airworthiness assessment of highly augmented aircraft and will require significant modifications and updating. In fact, many important sections in the Engineering Flight Test Guides are blank or missing and listed simply as "Reserved."

Specific areas of interest or possible activities needed to aid in upgrading the pertinent documents are detailed. Brief comments on some of these areas are: A synopsis of FAA pertinent data and information taken from applicable portions of flight test and simulations studies (as accomplished by NASA, DOD in the form of



reports and handbooks; e.g., MIL-F-8785C), should be culled and portions included in the FAA Engineering Flight Test Guides in a format that is readily usable to the agency and certification team members in the flying qualities airworthiness assessment process for minimum requirements for a level of safety. Specific piloting tasks should be defined for evaluation of critical aspects of certain features of highly augmented aircraft. Issues related to "long-term" dynamic stability requirements need to be fully and efficiently addressed. The idiosyncrasies of specific augmentation schemes should be discussed in some detail so FAA flight test engineers and test pilots can fully and efficiently evaluate such systems. For example, both active and passive augmentation schemes should be covered ranging from downsprings and bobweights all the way to highly redundant full-authority high-gain fly-by-wire systems. All aspects of augmentation system failures should be considered. For example, the Engineering Flight Test Guide should contain a clear interpretation of what constitutes "non-essential," "essential," and "critical" flight control functions. In addition, the effects of failure transients and critical conditions for failures should be spelled out in detail.

Currently, the minimum requirements for a level of safety are defined by several key phrases scattered throughout the FAR. For example, "without exceptional piloting skill, alertness, (attention) or strength" is the phrase used to distinguish between what is and what is not an acceptable level of safety in some paragraphs. A more definitive rating rationale and structure should be designed and considered for agency use by the FAA flight test pilots and engineers as an additional aid in determining more precisely what constitutes PASS/FAIL rating and compliance with "key-phrase" use for the evaluation of flying qualities minimum requirements for a level of safety. To this end, Volume I suggests that the well-known and widely used Cooper-Harper Rating Scale be more formally utilized, in truncated form, in the flying qualities appraisal process. That is, the Cooper-Harper "Rating" column, the Aircraft Characteristics column, and Demands on the Pilot (Workload) column are identically retained but the block diagram schematics for Adequacy for Selected Task have been excised and a new PASS/FAIL Judgment column (designed and calibrated specifically for FAA application) has been juxtaposed with the familiar 10-point rating scale for agency use in conjunction with the existing "key-phrases" of the FAR and flight test guides. This truncated version of the Cooper-Harper Flying Qualities rating system is offered here to reduce agency application difficulties and other past rating complexity issues. It provides an initial rationale with a more solid data foundation that should aid greatly in structuring all airworthiness PASS/FAIL appraisals. Also, use of this type of rating scale should eliminate or at least mitigate objections by some applicants related to relative rating comparisons (of "goodness" or "badness") of aircraft, systems, and products.

In the present study, we have defined specific areas of concern in aircraft flying qualities related Federal Aviation Regulations and associated Engineering Flight Test Guides when utilized for the airworthiness assessment of highly augmented aircraft.

## SECTION I

### INTRODUCTION

#### A. BACKGROUND

The current airworthiness standards for Transport Category Airplanes [Federal Aviation Regulations (FAR), Part 25] are primarily oriented towards classical unaugmented aircraft. Nonetheless, they are applicable in most cases to augmented aircraft if appropriate interpretations can be made in the Engineering Flight Test Guide For Transport Category airplanes [Federal Aviation Administration (FAA), Order 8110.8, Reference 1]. The purpose of this report is to analyze the interrelationships between various levels of augmentation and the FARs. Many of the areas covered in this report are also applicable to Part 23 aircraft and the associated engineering flight test guide (FAA Order 8110.7).

This report is organized in two volumes. Volume I is oriented towards a practical interpretation of stability augmentation systems with emphasis on the flying qualities airworthiness assessment of such aircraft. In keeping with this objective, the use of equations and analytical interpretations has been kept to a minimum. Volume II reports the more analytically oriented research results of this study.

While the report is intended to cover augmentation systems in general, the emphasis is on relaxed static stability in view of the current interest in this subject. For example, a Lockheed L-1011 is currently being flown at 1 percent static margin to explore the feasibility of flying at aft center of gravity locations. In the Energy Efficient Transport (EET) program sponsored by NASA (References 2, 3, and 4), it was found that relaxed static stability was a most important source of block fuel reduction (Reference 2, page 167). This suggests that a variety of pitch augmentation systems will be implemented to meet the agency's minimum flying qualities airworthiness requirements for a level of safety for the next generation transport aircraft that incorporate relaxed static stability concepts.

The basic objective of stability augmentation is to make the flight control system and feel system essentially transparent to the pilot. That is, the pilot should feel that the flying qualities characteristics are very desirable without being aware of the goings on necessary to achieve such characteristics. Clearly, when these objectives are met the flying qualities could exceed, by a considerable margin, the minimum requirements for a level of safety in the majority of flight conditions to be encountered. However, the certification pilot and engineers and other flying qualities airworthiness assessment team members should be aware of the generic characteristics of stability augmentation so that they can identify possible critical flight conditions. For example, an augmentation system using a limited authority series servo may tend to saturate in wind shear resulting in a reversion to the basic aircraft dynamics at a critical point in the landing flare. Such cases should be identified and tested on a flight simulator as well as in-flight, whenever possible. A primary objective of this volume is to provide information and data to support future expansion and revision of the Engineering Flight Test Guide for Transport Category Aircraft (Reference 1). In particular, it has been our intention to include guidance material to assist in identifying critical flight conditions that may arise as a consequence of stability augmentation.

#### **B. ORGANIZATION OF REPORT (VOLUME I)**

A discussion of the evaluation factors for flight testing of augmented aircraft is presented in Section II. Section III includes a review of the basic concepts of stability as related to the requirements discussed in Section II. The effect of augmentation on static and dynamic stability is discussed in Section IV. The primary emphasis in Section IV is on active augmentation which is expected on the next generation Part 25 aircraft. Section V contains a discussion on augmentation system failures and, in particular, how such failures can be accounted for within the framework of the current FARs. Finally, Section VI gives considerations for modifying the flight test guide to account for the effects of stability augmentation without making significant changes in

the FARs. It is hoped that the data contained in Section VI can be utilized along with other pertinent information to update and modify the Engineering Flight Test Guide for transport category aircraft so that augmented aircraft are accounted appropriately.

## SECTION II

### EVALUATION FACTORS FOR FLIGHT TESTING OF AUGMENTED AIRCRAFT

#### A. BACKGROUND

The determination of whether an aircraft meets certain flying qualities minimum requirements for compliance with "a level of safety" dictates a more structured approach for highly augmented aircraft than for conventional aircraft. This lesson has been learned on numerous occasions in developing data to support the flying boundaries for highly augmented aircraft in MIL-F-8785C (see References 5 and 6). As a specific example, it was found that small variations in the equivalent time delay between the aircraft pitch response and control input had a large impact on the pilot ratings (one (1) unit of Cooper-Harper rating per 0.05 sec of time delay). However, this rapid degradation in pilot rating with increasing time delay was only apparent when the pilot was given a task which required aggressive control of pitch attitude such as touching down at a precise point on the runway in the presence of turbulence and wind shear. The point of this discussion is that a significant deficiency existed that was not apparent from "normal" flight testing and that difficulties were encountered only when aggressive attitude control was required. Furthermore, the value of the equivalent time delay was found to depend on specific details of the augmentation system such as bending mode filters, stick filters, and digital flight control system throughput time. It is our intention in the current research to provide the necessary background which will allow the FAA to expand the Engineering Flight Test Guide to include appropriate flight test procedures which expose handling quality deficiencies unique to stability augmentation systems. In this section we shall discuss some general flying quality airworthiness flight test evaluation factors that have been found useful in checking highly augmented aircraft for compliance with the Military Flying Quality Specification (Reference 5).

## B. PILOT CENTERED REQUIREMENTS

An evaluation of the flying qualities of an augmented aircraft requires consideration of four basic factors. These are:

- 1) Unattended operation
- 2) Trim management
- 3) Maneuvering
- 4) Regulation

Unattended operation refers to portions of the flight where the pilot is performing functions other than flying the aircraft. Trim, of course, relates to the pilot's ability to remove constant control pressures in equilibrium flight. Some maneuvering and most regulation tasks involve continuous pilot involvement as part of a closed-loop pilot vehicle system. It is necessary to consider all of these factors in making a determination of the suitability of the aircraft flying qualities. Experience has shown that the critical high workload pilot operations involve precision path control and unfavorable environmental conditions such as low visibility, approach and landings in turbulence and wind shear. In evaluating the suitability of augmented aircraft, the engineering flight test guide should be explicit in terms of the operating environment to be tested, as well as the mission operational phases such as takeoff, climb, level flight, dive/descent, and landing. A format which accounts for unattended operation, trim management, maneuvering and regulation in the above operating environments should be considered for an expanded version of the flight test guide.

Certain key phrases are included in FAR Part 25 to insure compliance with minimum requirements for a level of safety. These are summarized below:

- "Without exceptional piloting skill, alertness, (attention), or strength" (FAR Part 25.143b, and 25.181b).
- "Suitable" (FAR 25.171)

- "Safe Operation" (FAR 25.171)
- "Exceptional attention not required" (FAR 25.173d).

While the semantic meaning of these phrases is generally understood, it is inevitable that certification pilots within and among the regions will disagree as to the associated magnitude of the flying quality deficiency. The military flying qualities specification (MIL-F-8785C) approaches this problem by defining levels of flying quality acceptability in terms of the Cooper-Harper rating scale (see Reference 7), which has become a standard reference in the flying quality community and is shown in Figure 1 (taken from Reference 7). Figure 1a shows the actual scale whereas Figure 1b indicates all of the factors which must be considered in the evaluation of aircraft handling qualities. The semantic meanings of the phrases on the Figure 1a scale were investigated in Reference 8 to determine the variability of their meanings amongst a large group of pilots. In addition, the scale was tested for linearity to see for example if the meanings of the phrases associated with the pilot rating of 4 were actually "twice as bad" as the meaning of the phrases for pilot ratings of 2. This experiment is reported in Reference 8 which shows that the variability is indeed quite low and that the scale is linear in the region of pilot ratings between 1 and 6. While the variability and linearity of the scale for ratings worse than 6 were somewhat degraded, the scale is still usable in this region. Nearly all flying quality experiments of any consequence performed in the last 15 years have utilized the Cooper-Harper pilot rating scale as primary source of data concerning pilots performance and workload of the tested configurations. It should be noted that we are not recommending a modification of the FARs to include the Cooper-Harper pilot rating scale, but rather the inclusion of the scale to assist in interpretation of the phrases noted above which are currently in the FARs. It is the opinion of the authors that a pilot rating of 5 would insure compliance with the FAR minimum requirements for a level of safety and would be consistent with the semantic meanings of the above phrases. This is based on the opinion that the semantic meanings of the phrases associated with a

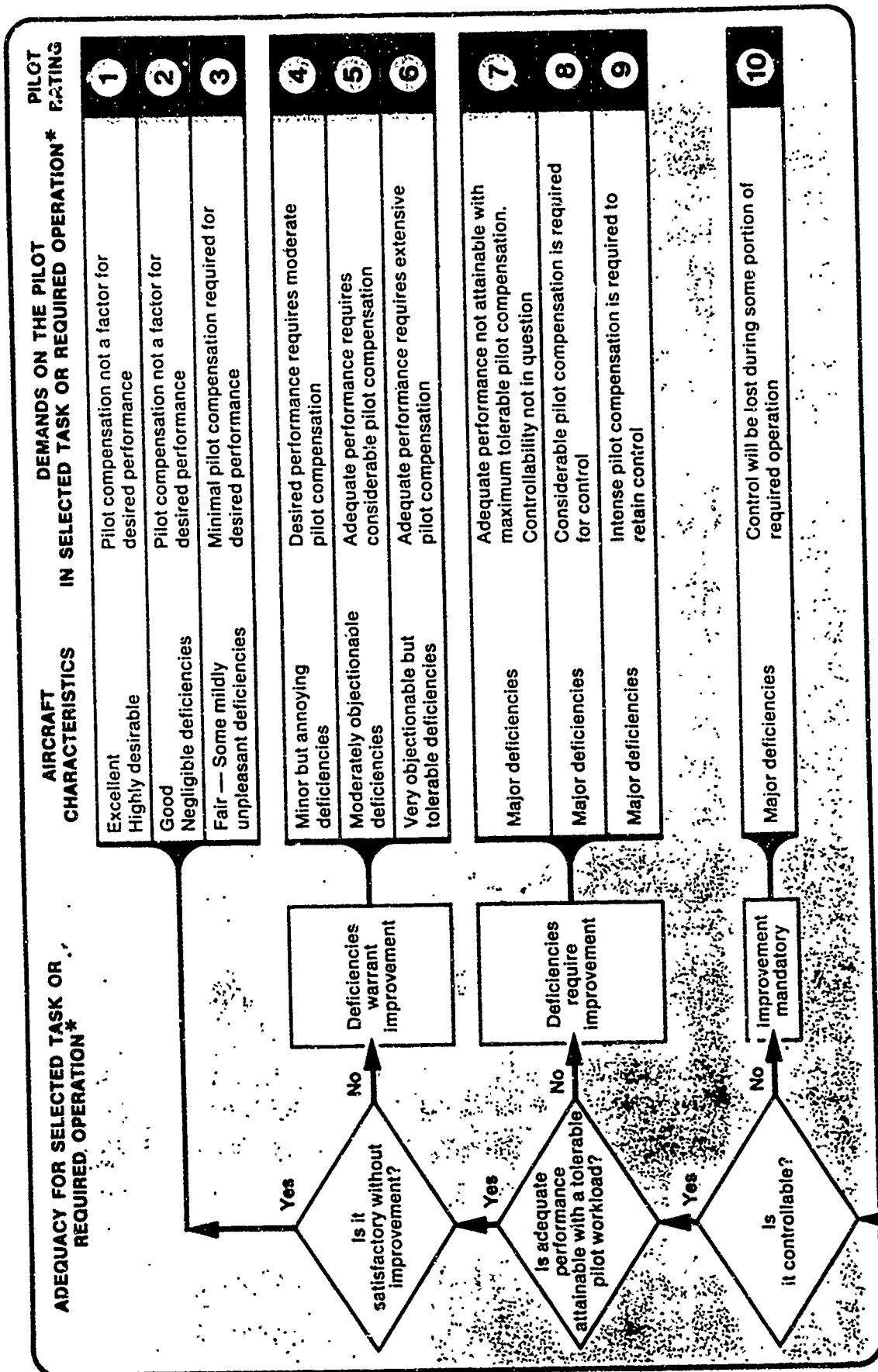

**DEMANDS ON THE PILOT IN SELECTED TASK OR REQUIRED OPERATION\***

**AIRCRAFT CHARACTERISTICS**

**ADEQUACY FOR SELECTED TASK OR REQUIRED OPERATION\***

**PILOT RATING**

<b>1</b>	Pilot compensation not a factor for desired performance	Excellent Highly desirable
<b>2</b>	Pilot compensation not a factor for desired performance	Good Negligible deficiencies
<b>3</b>	Minimal pilot compensation required for desired performance	Fair — Some mildly unpleasant deficiencies
<b>4</b>	Desired performance requires moderate pilot compensation	Minor but annoying deficiencies
<b>5</b>	Adequate performance requires considerable pilot compensation	Moderately objectionable deficiencies
<b>6</b>	Adequate performance requires extensive pilot compensation	Very objectionable but tolerable deficiencies
<b>7</b>	Adequate performance not attainable with maximum tolerable pilot compensation. Controllability not in question	Major deficiencies
<b>8</b>	Considerable pilot compensation is required for control	Major deficiencies
<b>9</b>	Intense pilot compensation is required to retain control	Major deficiencies
<b>10</b>	Control will be lost during some portion of required operation	Major deficiencies

\* Definition of required operation involves designation of flight phase and subphases with accompanying conditions.

Cooper-Harper Ref. NASA TND-5153

Figure 1a. Cooper-Harper Pilot Rating Scale (Reference 7)

Pilot decisions



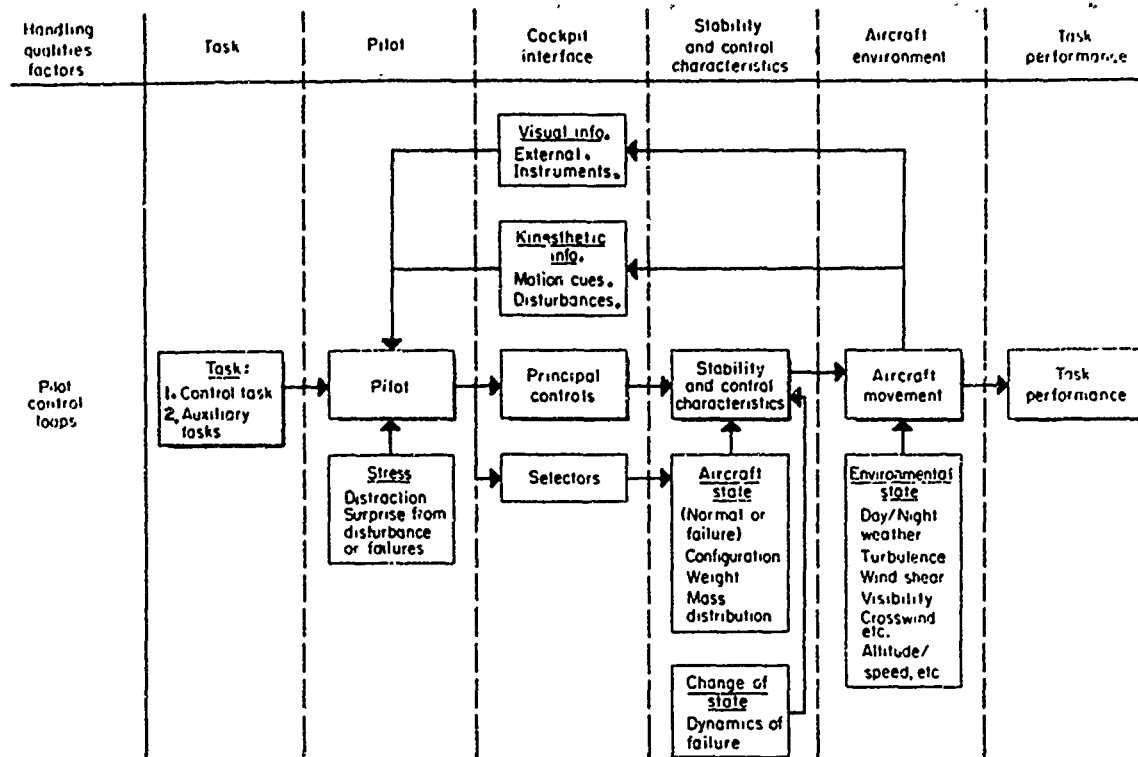

Figure 1b. Elements of Control Loop That Influence Handling Qualities

Cooper-Harper pilot rating of 6 would require pilot effort that exceeds a "minimum requirement for a level of safety" as described by the phrases, e.g., "without exceptional pilot skill, alertness, or strength." Specifically, it would seem that the Cooper-Harper phrases "very objectional deficiencies" and "adequate performance requires extensive pilot compensation" would be associated with something worse than "without exceptional pilot skill, alertness, or strength," "suitable," "safe operation," and "exceptional attention not required." Additional evidence that the 5 level is appropriate for defining the "pass/fail" boundary for the minimum requirements for a level of safety is given by the fact that FAA certification pilots utilized this value during an extensive STOL airworthiness simulation conducted for the purpose of generating airworthiness criteria for a STOL aircraft (see Reference-9).

### C. RECOMMENDED PILOTING TASKS

The Engineering Flight Test Guide should contain specific piloting tasks for each of the specified FARs. As a minimum these tasks should require:

- Aggressive tracking
- A level of turbulence which could be defined as moderate
- Precision landings in the presence of moderate wind shear (this requirement may have to be accomplished in simulation).
- Periods of unattended pilot operation. This task would be especially important in the presence of augmentation failures.

The effect of the piloting task on the flying quality evaluation is dramatically shown in Figure 2 where the Cooper-Harper pilot ratings are plotted vs. time delay; an important flying quality metric for augmented airplanes. Two sets of data are shown in Figure 2. Both involve a landing task and both utilize variable stability in-flight (airborne) simulators. The curve marked A represents an experiment where the piloting task was simply to land at any point on the runway. The curve marked B represents an experiment where the piloting task was to land at a specific point on the runway after accomplishing an aggressive side step maneuver. The effect of the flying quality parameter  $\tau_e$  (equivalent control system time delay) is seen to be significantly greater in the more aggressive piloting task which, in fact, makes the difference between meeting or not meeting the recommended minimum requirement for a level of safety in Figure 2. The key point to be made here is that an aggressive piloting task is required to reveal flying quality deficiencies that simply are not apparent during normal operation. Such rapid degradations in flying qualities has been termed "flying quality cliffs." A primary objective of the flight test guide should be to interpret the FARs in such a way as to expose such flying quality cliffs.

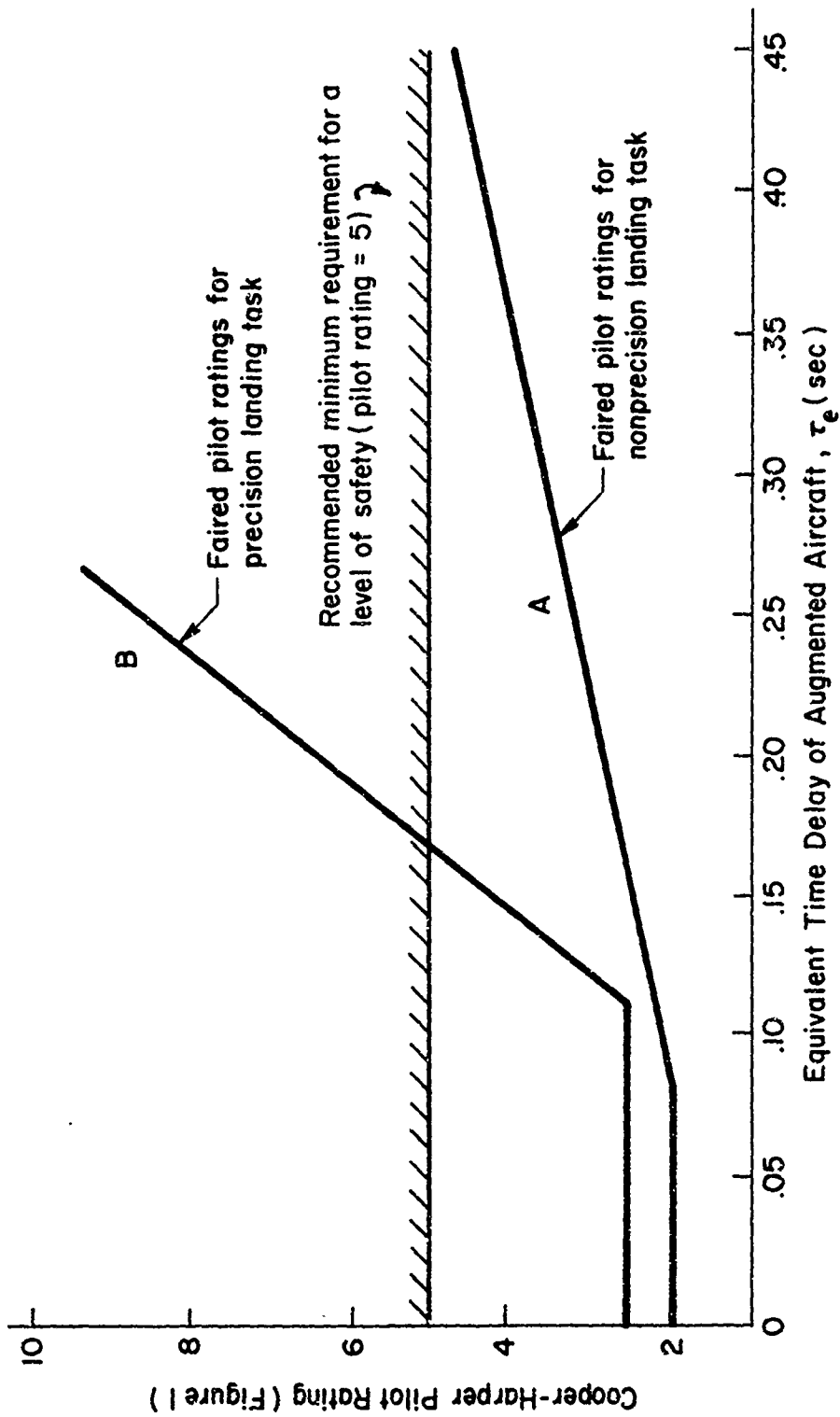

Figure 2. Effect of Evaluation Task on Pilot Ratings

SECTION III  
BASIC CONCEPTS

**A. STICK-FIXED AND STICK-FREE STATIC STABILITY**

Static stability is positive when the variation in pitching moment with angle of attack ( $dC_m/d\alpha$  or simply  $C_{m\alpha}$ ) is negative. Note that as long as the pitching moment variation with angle of attack is negative, the aircraft will always return to its trim pitch attitude and hence its trim airspeed after a disturbance. For conventional airplanes the major contribution to  $C_{m\alpha}$  is from the horizontal tail. That is,

$$(C_m)_{tail} = (C_{L\alpha})_{tail} \alpha_{tail} \frac{l_{tail}}{\bar{c}} \frac{S_{tail}}{S_{wing}} \quad (1)$$

The change in  $(C_m)_{tail}$  with wing angle of attack is obtained by taking the derivative of Equation 1,

$$\left( \frac{dC_m}{d\alpha_{wing}} \right)_{\text{due to tail}} = -(C_{L\alpha})_{tail} \frac{d\alpha_{tail}}{d\alpha_{wing}} \frac{l_{tail}}{\bar{c}} \frac{S_{tail}}{S_{wing}} \quad (2)$$

The change in angle of attack of the tail and wing differs by the change in downwash at the tail. From Figure 3,

$$\left( \frac{d\alpha_{tail}}{d\alpha_{wing}} \right) = 1 - \frac{d\epsilon}{d\alpha_{wing}}$$

$$\left( \frac{dC_m}{d\alpha_{wing}} \right)_{\text{due to tail}} = -(C_{L\alpha})_{tail} \left( 1 - \frac{d\epsilon}{d\alpha_{wing}} \right) \frac{l_{tail}}{\bar{c}} \frac{S_{tail}}{S_{wing}} \quad (3)$$

The total  $C_{m\alpha}$  is given as

$$C_{m\alpha} = (C_{m\alpha})_{wing} + (C_{m\alpha})_{tail} + (C_{m\alpha})_{fuselage} + (C_{m\alpha})_{flaps} + \dots \quad (4)$$

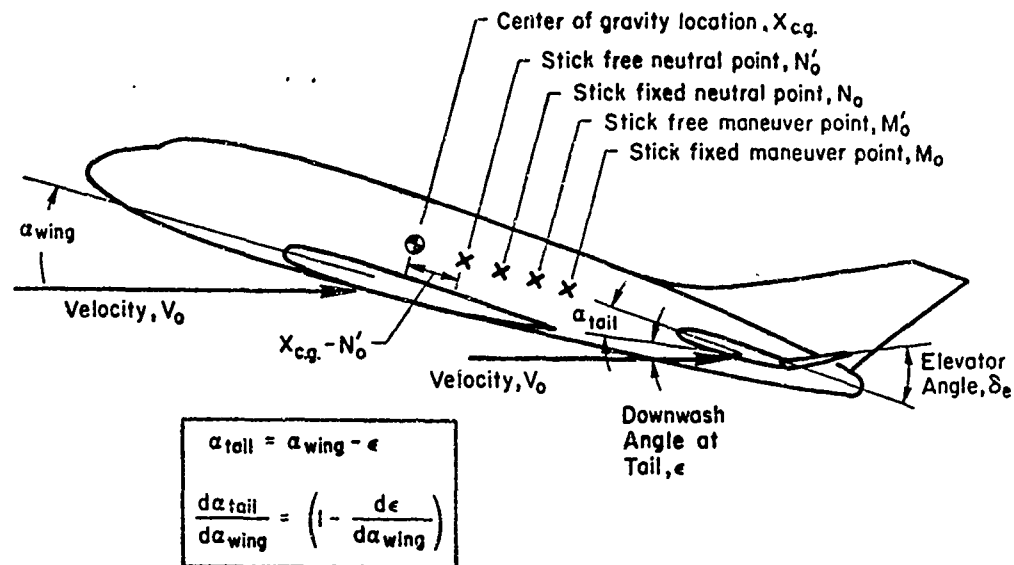

Figure 3. Basic Notation Used for Defining Static Stability

The term stick-fixed static and dynamic stability means that the tail contribution to  $C_{m\alpha}$  was obtained with the elevator fixed. However, if the elevator is not constrained it will tend to float trailing edge up as the angle of attack is increased. The net effect of this is to reduce  $(C_{L\alpha})_{tail}$  in Equation 3. Since the tail provides most of the stabilizing moment, (Equation 4), the effect of a floating elevator can be substantial. (The details of this are given in Reference 10 on pages 282-285). The term stick-free static and dynamic stability means that the tail contribution to  $C_{m\alpha}$  was obtained with the elevator allowed to float (not constrained). Since the elevator nearly always tends to float trailing edge up with increasing angle of attack, stick-free static stability is generally less than stick-fixed static stability.

Moving the center of gravity aft tends to increase the destabilizing moment due to the wing and to decrease the stabilizing effect of the tail. If all the  $C_{m\alpha}$  effects in Equation 4 are separated into aerodynamic dependent and c.g. dependent terms, the following expression results:

$$C_{m\alpha} = C_{L\alpha}(x_{cg} - N_0) \quad (5)$$

$N_0$  is called the neutral point, since neutral static stability results when the c.g. is moved far enough aft so that  $x_{cg} = -N_0$  ( $x_{cg}$  is always negative). If the elevator is constrained,  $N_0$  is the "stick-fixed neutral point." Likewise, when the elevator is allowed to float, a prime is added to denote the stick-free neutral point. That is,

$$(C_{m\alpha})_{free} = C_{L\alpha}(x_{cg} - N'_0) \quad (6)$$

Note that  $N'_0$  would be calculated by using a lower value of  $(C_{L\alpha})_{tail}$  in Equation 3 and that it would be smaller than  $N_0$ . Hence, as the c.g. is moved aft, stick-free static stability normally goes to zero before stick-fixed static stability. This is shown diagrammatically in Figure 3. The distance between the c.g. and  $N_0$  is termed the "static margin" and is usually given in percent of mean aerodynamic chord.

The physical significance of stick-free static margin is that it not only defines the tendency of the aircraft to return to trim with the elevator unconstrained, but it also defines the force required to intentionally hold the aircraft at some speed off trim. More precisely, the relationship between stick-free static stability,  $(C_{m\alpha})_{free}$ , and the stick force gradient with speed is given as:

$$\frac{dF_s}{dV} = K \frac{C_{h\delta_e}}{C_{m\delta_e}} \frac{(x_{cg} - N'_0)}{V_{trim}} = K \frac{C_{h\delta_e}}{C_{m\delta_e}} \frac{(C_{m\alpha})_{free}}{C_{L\alpha}} \frac{1}{V_{trim}} \quad (7)$$

where

$K$  Depends on control surface gearing and elevator wing geometry and weight (see Reference 10)

$C_{h\delta_e}$  Is the elevator hinge moment due to elevator deflection

$C_{m\delta_e}$  Is the aircraft pitching moment due to elevator deflection

$V_{trim}$  Is the trim airspeed

From Equation 7 it is clear that the gradient of stick force with speed ( $dF_s/dV$ ) is a measure of the stick-free static margin ( $x_{cg} - N'_0$ ) and

hence  $(C_{m_u})_{free}$  (see Equation 6). This was most likely the basis for requiring a stable stick force gradient in early flying quality specifications including the FARs. With the advent of augmentation it is possible to have zero or even negative static margin, i.e.,  $(C_{m_u})_{free}$  positive, and still have acceptable, and even desirable, pitch axis handling qualities. Hence, the basis for stick force gradient requirements should be reconsidered to determine how they apply for augmented aircraft.

The gradient of elevator position with speed ( $d\delta_e/dV$ ) is a measure of static stick-fixed stability, i.e.,  $(C_{m_u})_{fixed}$  is negative, when  $d\delta_e/dV$  is positive.\*

Experience has shown that control force cues are more dominant than control position cues. Hence, stick-free static stability is naturally a better measure of aircraft flying qualities characteristics than stick-fixed static stability. Furthermore, the physical impact of stick-fixed static stability on the pilot is very obscure, since it is not possible to constrain the elevator without feeling some force at the control column (short of engaging the gust lock). For this reason, FAR 25.173 only requires limits on stick-free static stability. Note that, from Equation 7, the limit of 1/6 lb/kt is a direct limitation on  $(x_{cg} - N'_0)$  and hence the aft c.g. boundary.

Amendment 25-7 in the preamble to FAR Part 25 (Reference 11) contains a discussion supporting the deletion of stick-fixed static stability requirements. The primary argument in that discussion centers about the fact that stick-fixed static stability is "unnecessary for minimum safety" and tends to "dictate design." These conclusions were based on comments by the Aerospace Industry Association and on experience gained in the type certification of turbine-powered transport aircraft. These conclusions are still valid. Furthermore, as will be shown subsequently in this report, a requirement for stick-fixed static stability is inappropriate for augmented aircraft. That is, the elevator motions

---

\*Positive elevator deflection is trailing edge down.

required to provide artificial stability do not necessarily exhibit the positive gradient ( $d\delta_e/dV > 0$ ) discussed above.

## **B. EFFECT OF CENTER OF GRAVITY LOCATION ON STATIC AND DYNAMIC STABILITY**

The general degradation in flying qualities as the center of gravity moves toward and behind its aft limit is certainly a well-documented and established fact. From a piloting standpoint, the aircraft pitch attitude response to control input tends to become progressively more sluggish, making precise and rapid changes in aircraft attitude difficult, if not impossible. Furthermore, if left unattended, the aircraft attitude does not return to trim as rapidly as it does at the forward c.g. locations. In fact, when the center of gravity is at the stick-free neutral point, there is no tendency for the attitude to return to its original value after a disturbance, and hence "trim" is essentially undefined. The "sluggishness" of pitch attitude which tends to interfere with rapid and precise control is associated with a simultaneous degradation of static and dynamic stability as the center of gravity moves aft. This behavior is discussed in some detail in the following subsections. Subsequently, we will show that with stability augmentation it is possible to observe an apparent degradation in static stability that is totally unrelated to the dynamic response of the aircraft.

### **1. Effect of Center of Gravity Location on Static Stability**

One test for positive static stability is to perform a pulse column input and to observe the steady state values of pitch attitude, angle of attack, and airspeed. Positive static stability is defined when these variables all return to trim (in the steady state) after the stick is released. Figure 4 shows time histories of pitch attitude, angle of attack, and airspeed away from their trim values following a pitch pulse for several values of center of gravity location. The typical range of responses within the center of gravity envelope are indicated by Cases a and b in Figure 4. FAR 25.173 requires that the airspeed must return to within a specified percent of the original trim speed after release of



$\theta$  - Pitch attitude with respect to initial trimmed value  
 $\alpha$  - Angle of attack with respect to initial trimmed value  
 $u$  - Airspeed change from initial trimmed value

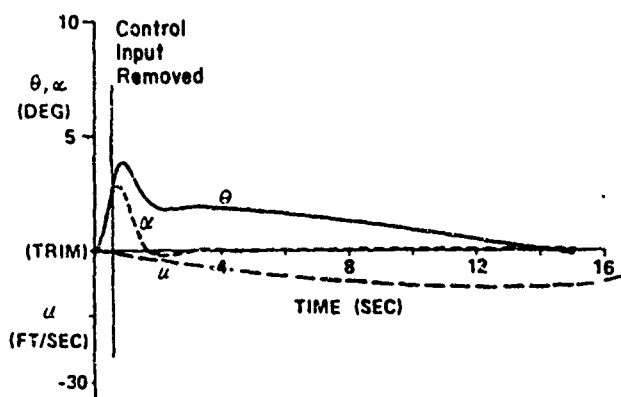

Case a: Pulse response for forward c.g.

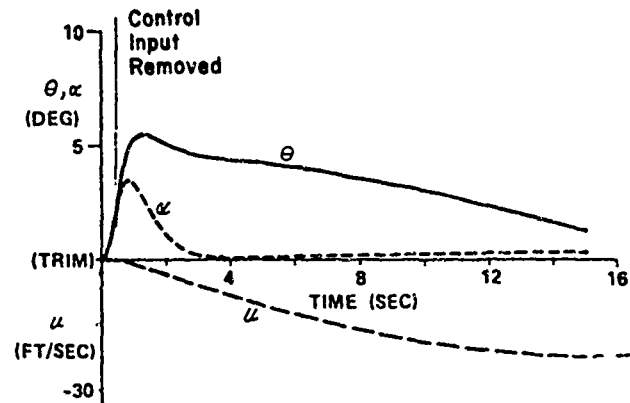

Case b: Pulse response for aft c.g.

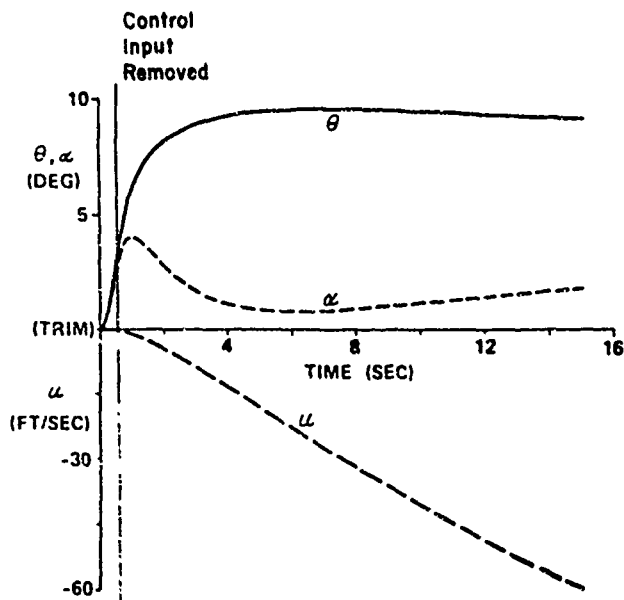

Case c: Pulse response for c.g. at neutral point ( $x_{cg} - N'_0 = 0$ )

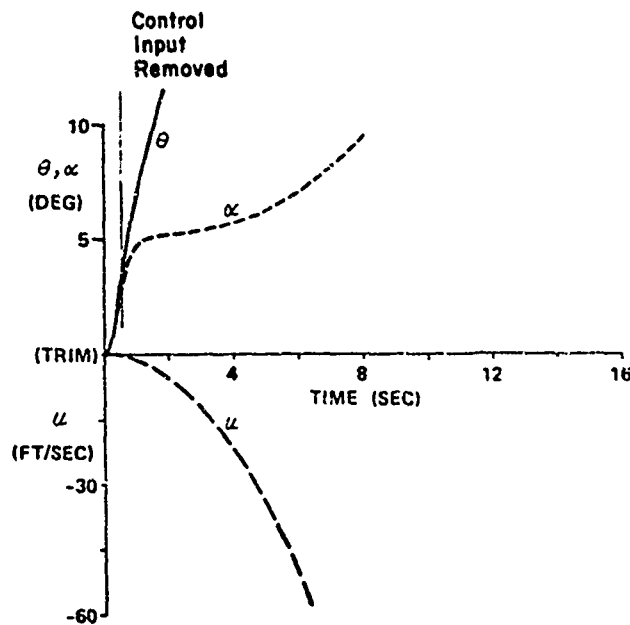

Case d: Pulse response for c.g. aft of neutral point ( $x_{cg} - N'_0 > 0$ )

Figure 4. Effect of C.G. Location on Classical Aircraft Stick-Free Response Characteristics (Same size and duration pulse input for all cases)

the control. While the scale in Figure 4 is not long enough to show that the airspeed returns to trim, the fact that angle of attack and attitude are returning to their trim values indicates that airspeed must also follow suit.

Neutral static stability is defined when pitch attitude and angle of attack do not return to "trim" and also do not diverge after the longitudinal control is released (Case c in Figure 4). Actually, "trim" is no longer defined, since the pitch attitude remains at whatever value it drifts to after the pilot releases the controls. For a fixed value of power, airspeed and pitch attitude always covary, that is, an increase in pitch attitude will always result in a decrease in airspeed. Since pitch attitude does not return to its original value, the airspeed will also seek a new "trim" value consistent with the new pitch attitude. It follows that since airspeed does not return to its initial "trim" value, FAR Part 25.173b would be violated by Case c.

Negative static stability\* is defined when pitch attitude continues to diverge after the longitudinal control is released. This is illustrated in Case d in Figure 4. Notice that speed diverges exponentially in this case. There is no question but that any instability is undesirable in terms of the pilot-centered requirements discussed in Section II-B. In particular, the unattended operation characteristics are of concern, since any lack of pilot attention to aircraft control will result in a divergence. The question of how much negative static stability constitutes an unacceptable level of safety is particularly relevant when considering the possibility of a failed augmentation system. This is studied in detail in Section V.

---

\*In the strictest sense, negative static stability is undefined since steady state values of pitch attitude and angle-of-attack cannot, by definition, exist. However, it is common practice to refer to cases when the c.g. is aft of the neutral point as having negative static stability.

## 2. Effect of Center of Gravity Location on Dynamic Stability

In terms of the time response characteristics (for example, Figure 4), dynamic stability can be said to describe the way in which the steady state is reached. Another way of looking at it is that dynamic stability defines the short-term response, and static stability defines the steady-state response following a disturbance or control input.

Looking at Figure 4, it can be seen that moving the center of gravity aft does not affect the forced response of pitch attitude appreciably. That is, the initial slope of pitch attitude and angle of attack (first one-half second) are about the same for Cases a, b, c, and d. However, when at the forward center of gravity limit, the pitch attitude stops increasing almost immediately upon removal of the control input (Case a). As the center of gravity is moved aft, the pitch attitude response tends to continue drifting up after the control is released. Also, pitch attitude shows a tendency to "hang up" and return to trim more slowly for aft center of gravity locations (compare Cases a and b). The pilot sees this as a sluggish response requiring more attention. Typical pilot comments for aircraft with aft center of gravity loadings are "It wallows in turbulence" and "I cannot make rapid and precise pitch attitude changes."

The dynamic response corresponding to neutral static stability (Case c) is characterized by a very sluggish pitch response which continues to drift upward until reaching a steady value at about 4 sec after removal of the control input. This is undesirable in that precise attitude control becomes difficult. It is noteworthy that excessive time to reach a steady attitude may be just as, if not more important than the fact that attitude does not eventually return to trim. The importance of this distinction will become more apparent when discussing rate-type attitude augmentation systems.

The dynamic and static responses are virtually not distinguishable for aircraft with significant instabilities (Case d). In these cases the instability dominates the response. As a general rule of thumb, the

time for the divergent airspeed to double amplitude can be used as a measure of whether or not the aircraft meets the minimum requirements for a level of safety. Reference 6 utilizes a time to double amplitude of 6 sec as a measure of acceptable (not desirable) flying qualities. Analysis of data in the MIL Handbook (Reference 6) indicates that utilization of the time to double amplitude as a measure of satisfactory flying qualities may not be sufficiently discriminatory. More research in this area is required.

### 3. Connection Between Dynamic and Static Stability

The Figure 4 example discussed above has shown that as static stability decreases due to an aft movement of the center of gravity, the dynamic stability tends to be such that attitude responses become sluggish in a fairly predictable way. Hence, for classical airplanes the requirement for static stability is to some extent an implicit requirement on the dynamic stability. Inasmuch as many of the pertinent sections of the FARs were written during a time when "classical airplanes" were the state of the art, it can be seen why there is very little emphasis on quantitative requirements for dynamic stability per se. It will be shown in the next section that this may not be true for augmented aircraft. That is, it is possible to have a very desirable dynamic response and, in fact, have zero static stability. It is therefore necessary to establish what features of "static stability" are important for defining the minimum requirements for a level of safety in FAR Part 25.173 for augmented aircraft. Based on the above discussion, the following pilot-centered requirements are associated with static stability as defined by FAR Part 25.173:

- As a prevention against large attitude and speed excursions during periods of unattended operation (FAR 25.173b).
- As a tactile speed cue (FAR Part 25.173c).
- As a measure of the dynamic response required for good closed-loop control (implicit in the classical simultaneous variation of dynamic and static stability discussed above).

Because of the above-noted factors there is considerably more attention paid to static stability than to dynamic stability in FAR Part 25 and Part 23. For example, FAR Part 25.181, entitled Dynamic Stability, specifies only that any short-period oscillation must be heavily damped with the controls fixed and free. This requirement clearly depends on the classical simultaneous degradation of static and dynamic stability since details of the dynamic response characteristics are not defined and specified. The long-period dynamic oscillation (termed the phugoid oscillation in classical stability and control theory) is not covered by this or any other requirement in Parts 25 or 23.

More recent flying qualities specifications, such as the Military Flying Qualities Specification, Reference 5, have been more specific in terms of required dynamic stability. This is done by identifying the "characteristic response modes" of the aircraft and specifying limits to the values of these modes consistent with some level of pilot workload, usually defined by the Cooper-Harper rating scale discussed in Section II. While it is not recommended that the FARs be expanded to include such definitions at this time, an appreciation for the characteristic modes of motion of augmented and unaugmented aircraft will be of great value in expanding the Engineering Flight Test Guide to provide for adequate airworthiness assessment flight testing. In this light, let us consider the variation in the characteristic modes of a classical aircraft as the center of gravity is moved from its forward limit to a point aft of the stick-free neutral point as defined by the time responses in Figure 4. The transfer function that relates the pitch attitude response to a stick force input for such an aircraft is shown in Equation 8:

$$\frac{\text{Pitch Attitude}}{\text{Control Force}} = \frac{\theta}{F_s} = \frac{\text{Control Sensitivity}}{\underbrace{(s^2 + 2\zeta_p\omega_p s + \omega_p^2)}_{\text{Phugoid Mode}} \underbrace{(s^2 + 2\zeta_{sp}\omega_{sp} s + \omega_{sp}^2)}_{\text{Short-Period Mode}}} \quad (8)$$

$1/T_{\theta 1} \sim$  Related to trim drag,  $C_{d0}$

$1/T_{\theta 2} \sim$  Related to lift curve slope,  $C_{L\alpha}$

$\zeta \sim$  Damping ratio

$\omega \sim$  Frequency

$s \sim$  Laplace operator

The numerator terms in Equation 8 ( $1/T_{\theta 1}$  and  $1/T_{\theta 2}$ ) are called the "zeros" of the transfer function. The denominator terms of Equation 8 are termed the "poles" of the transfer function and define shapes of the characteristic responses to control inputs. Large values of the frequency term,  $\omega$ , indicate a very rapid pitch attitude response to a stick input. Conversely, very small values of the frequency indicate a very sluggish response to a stick input. The initial dynamic response of the classical aircraft is usually quite rapid and is termed the short-period mode and denoted  $\omega_{sp}$  in Equation 8. The phugoid mode,  $\omega_p$ , is usually a very small value, indicating that this mode occurs at very low frequency. A classical aircraft, when given a rapid stick pulse, will respond initially at the short-period mode with a sharp pitch rate followed by very low-frequency oscillations which take several cycles to damp out. These are illustrated in Figure 5, taken from Reference 13. The initial response is characterized by the short-period mode,  $\omega_{sp}$  (Figure 5a) whereas the low-frequency oscillation is characterized by the phugoid mode,  $\omega_p$  (Figure 5b). For the purpose of defining what are, and what are not, acceptable dynamic response characteristics, limits can be placed on the sluggishness or rapidity of the attitude response by placing upper and lower bounds on  $\omega_p$  and  $\omega_{sp}$ . Indeed, this is what is done in MIL-F-8785C and the new MIL Standard (References 5 and 6). The number of cycles that occur before the mode is damped out following the release of the control input is determined by the short-period and phugoid damping ratios,  $\zeta_{sp}$  and  $\zeta_p$ , respectively. The relationship

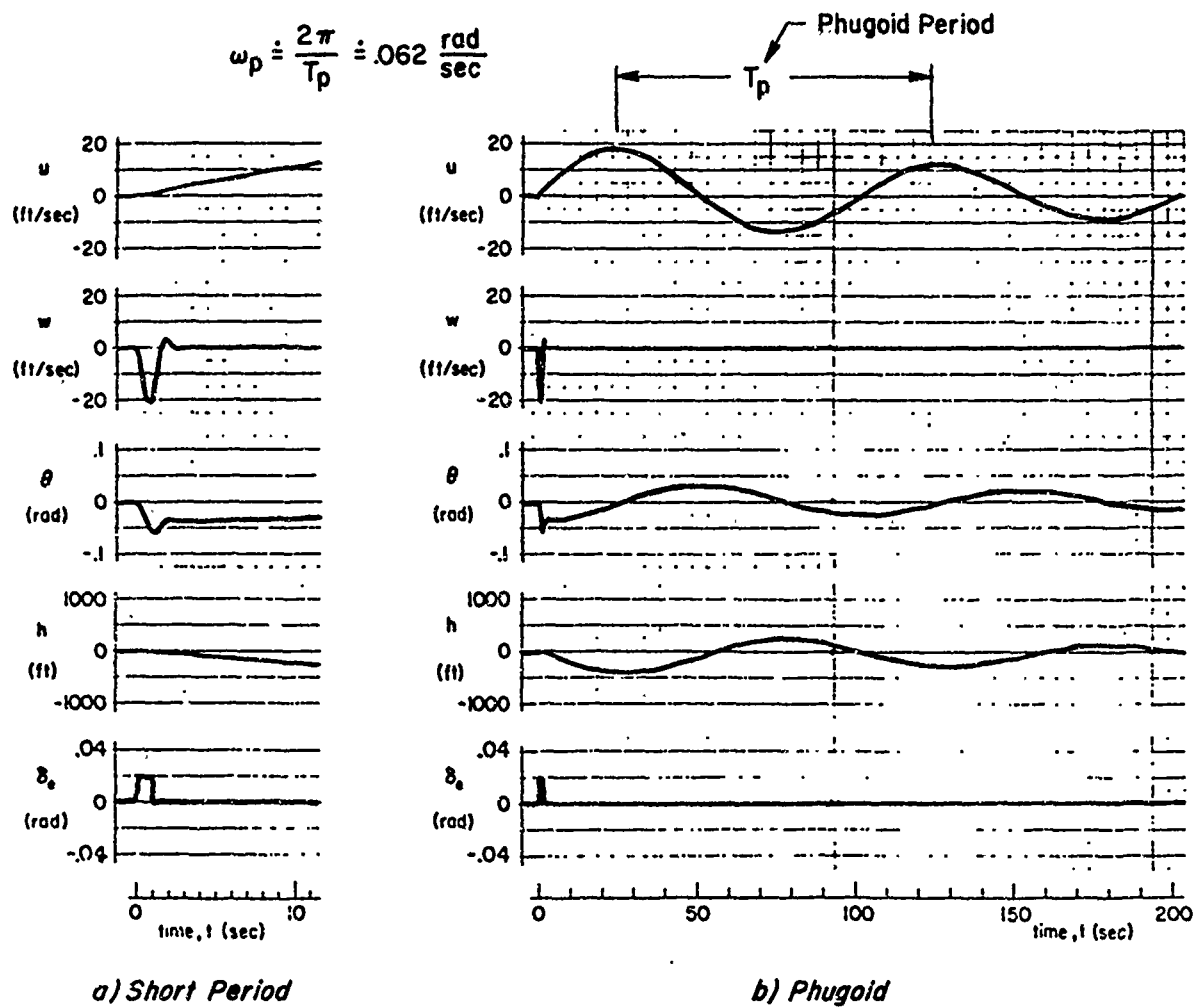

Figure 5. Time Response of Classical Unaugmented Aircraft to a Pitch Control Pulse Input

between damping ratio and cycles to damp to a specified amplitude is given by the following expressions:

$$C_x = -\frac{\ln x}{2\pi \zeta}$$

$\ln$  = natural log

$x$  = specified fraction of initial amplitude

$\zeta$  = damping ratio

For example,

$$\text{Cycles to } 1/2 \text{ amplitude} = C_{1/2} = -\frac{\ln .5}{2\pi\zeta} = \frac{.11}{\zeta}$$

$$\text{Cycles to } 1/10 \text{ amplitude} = C_{1/10} = -\frac{\ln .1}{2\pi\zeta} = \frac{.37}{\zeta}$$

Hence, it can be seen that the poles of the transfer function define the characteristic response (frequency and damping) following a disturbance or control input in the pitch axis. Inasmuch as the poles of the pitch attitude transfer function uniquely define the motions of the aircraft following a control input, their importance cannot be overemphasized. It is common practice to plot the poles of the pitch attitude transfer function on the complex plane as shown in Figure 6. While the mathematics of plotting poles and zeros on the complex plane can become somewhat involved, it is sufficient for our purposes to note that the frequency is represented by the distance from the origin to the position of the pole and the damping ratio by the cosine of the angle between the pole and the real axis, as shown in Figure 7. The forward c.g. case described as Case a in Figure 4 is shown as Case a in Figure 6 as well. This is typified by a large value of short-period frequency with moderate damping and a low value of phugoid frequency that is lightly damped. The corresponding time response is shown in Figure 5, where the short-period is over very quickly and the phugoid occurs for a considerable time thereafter at very low frequency. Case b in Figures 4 and 6 is indicative of an aft center of gravity. Here it is seen that the magnitude of the short-period frequency is considerably reduced, although the damping ratio is in fact increased. Low values of short-period frequency show up as a very sluggish pitch response, making precision tracking difficult. For this reason, MIL-F-8785C places a lower boundary on the short-period frequency. Flight test experiments have shown (see, for example, Reference 6) that the minimum value of short-period frequency is related to the  $1/T_{\theta 2}$  zero. Lower limits that have been established in the proposed MIL Standard (Reference 6) are summarized in Table 1 and could provide useful relative guidance material



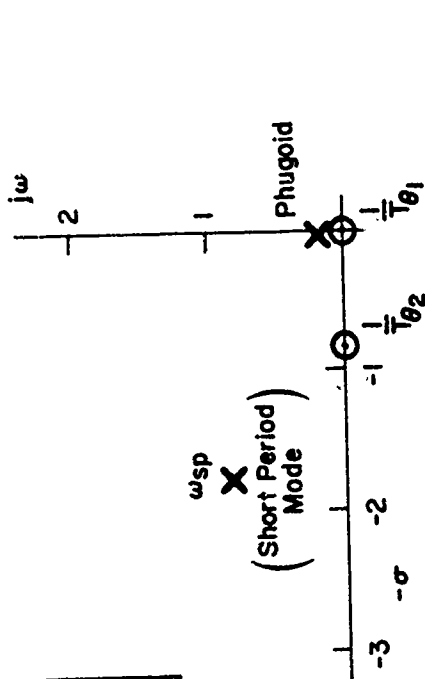

Legend:  
 X Poles  
 O Zeros

- Case a - Forward c.g.**
- Rapid and well damped initial pitch response (short period)
  - Lightly damped very low frequency speed response (phugoid)

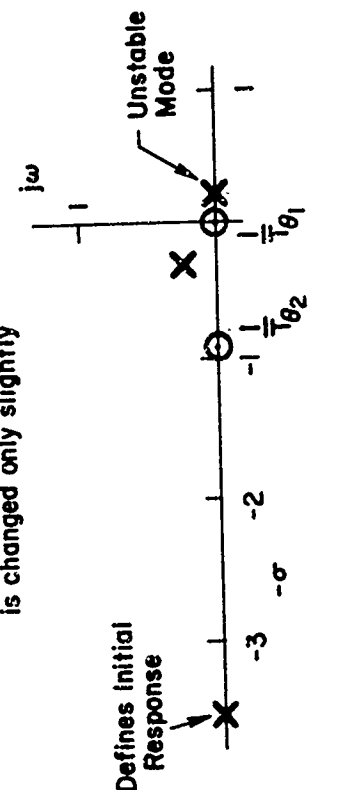

- Case b - Aft c.g.**
- Initial pitch response is well damped and occurs at low frequency (sluggish initial response)
  - Speed response (phugoid mode) is changed only slightly

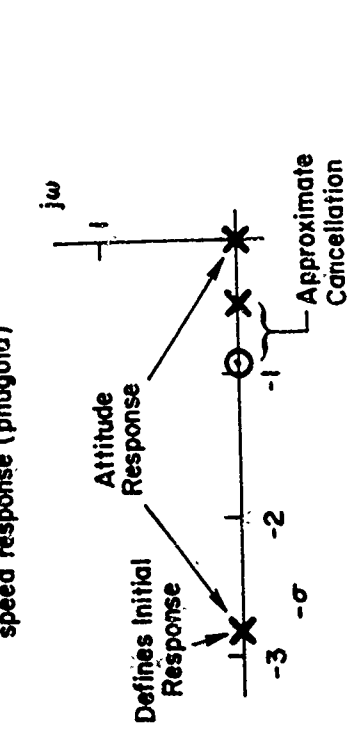

- Case c - c.g. at Stick Free Neutral Point**
- Short period and phugoid modes are no longer defined



- Case d - c.g. at Stick Free Maneuver Point**
- Short period and phugoid modes not defined
  - Initial response very rapid in this example
  - Unstable mode dominates response

Figure 6. Effect of Center of Gravity Location on the Pitch Attitude Poles and Zeros

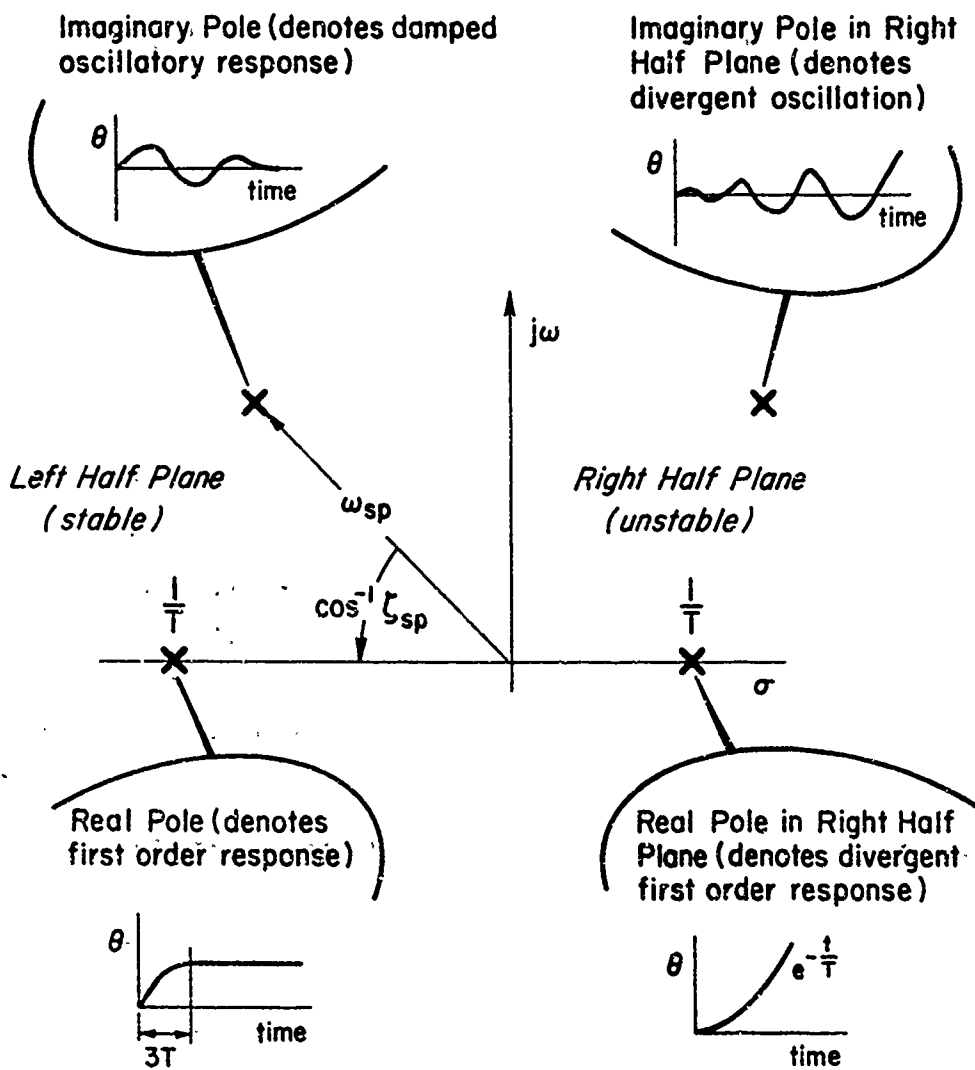

Figure 7. Relationship Between Time Response and Aircraft Poles

TABLE 1. GUIDANCE VALUES RELATED TO FAR 25.181 OR FAR 23.181 (Taken from Reference 6 Para. 3.2.1.1)

Short period frequency:	$\omega_{sp} > 1.0/T_{\theta 2}$	landing
Short period frequency:	$\omega_{sp} > 0.8/T_{\theta 2}$	Cruise
Damping ratio of short period	$1.5 > \zeta_{sp} > 0.30$	landing and cruise
Damping ratio of phugoid	$\zeta_p > 0$	

when determining compliance with the special objectives related to the agency's minimum requirements for a level of safety as specified in FAR 25.181 and 23.181. The limits on short-period and phugoid damping ratios from Reference 6 are also included in Table 1. A logical place to include such recommended "rules of thumb" would be the Engineering Flight Test Guide (FAA order 8110.8).

Case c in Figure 6 does not exhibit the classical separation between the short-period and phugoid modes. In fact, these modes are really no longer defined. This is indicative of the fact that the attitude response to a control input has taken on a different characteristic shape, as can easily be seen from the time response for Case c in Figure 4. The response characteristics denoted by Case c have received very little attention for classical aircraft inasmuch as the steady-state response represents neutral static stability, (which does not meet the minimum requirements for a level of safety in FAR 25.173). However, it will be shown later that rate command augmentation produces steady state response characteristics identical to those exhibited for Case c in Figures 4 and 6 although the dynamic response is considerably more rapid. Such characteristics have been found to be acceptable and even desirable in a number of research flight test programs when the dynamic

characteristics meet certain criteria. This subject will be further pursued in Section IV of this report.

Instabilities in the time response are denoted by transfer function poles that are in the "right half plane," that is, to the right of the  $j\omega$ -axis (Figure 7). The instability exhibited by Case d in Figure 4 is also shown in Case d in Figure 6, where the unstable mode is seen to exist on the real axis in the right half plane. A more detailed discussion of the effect of the unstable mode is given in References 6 and 16.

In summary, the static and dynamic stabilities for classical airplanes are seen to degrade simultaneously as the center of gravity is moved aft. The degradation in static stability is easily measured from the steady-state characteristics of the aircraft response to a control input or from the force required to keep the aircraft from returning to trim. The dynamic characteristics are not so easily measured and require consideration of the short-period frequency and damping to define the initial response and the phugoid frequency and damping to define the low-frequency dynamic stability. For classical airplanes, the tendency of dynamic stability to be adequate as long as static stability satisfies the requirements of 25.173 is sufficient, and no further requirements on short-term dynamic stability are necessary. The lack of a requirement on phugoid stability is a deficiency in the FARs for both augmented and unaugmented aircraft. In general, classical airplanes exhibit a very predictable phugoid, wherein the frequency is related to speed and the damping to the lift/drag ratio of the aircraft as follows:

$$\begin{aligned} \text{Phugoid frequency:} \quad \omega_p &= \sqrt{2} \frac{g}{U_0} \\ \text{Phugoid damping ratio:} \quad \zeta_p &= \frac{2g}{U_0} \frac{1}{L/D} \end{aligned} \tag{9}$$

However, the effects of control system friction and/or the incorrect implementation of a downspring or bobweight can, and have, caused the phugoid damping to become unstable.

## SECTION IV

### EFFECT OF AUGMENTATION ON STATIC AND DYNAMIC STABILITY

As was discussed in Section I, there are significant performance benefits which result from operation at values of the center of gravity which are in the vicinity of the aircraft neutral point. These performance benefits accrue from two factors:

- Reduction in tail size which reduces parasite drag and also has the effect of moving the neutral point ( $N_0$ , discussed in Section III) forward.
- Rearward shift in center of gravity motivated by the desire to minimize the download at the tail allowing operation at reduced angles of attack, i.e., minimum trim drag.

Aircraft utilizing these factors to improve operating efficiency have been termed relaxed static stability (RSS) aircraft. For example, see References 2, 3, and 4. As was shown in Section III, a degradation in both static and dynamic stability naturally occurs for RSS aircraft which therefore require some type of stability augmentation. Clearly it would be desirable to expand the engineering flight test guide to include the detailed information necessary to perform the airworthiness assessment for certification flight testing of relaxed static stability aircraft. The intention of this section is to provide background information on current and future augmentation systems envisioned for both Part 23 and Part 25 aircraft.

#### A. FUNCTIONAL CHARACTERISTICS OF TYPICAL STABILITY AUGMENTORS

The words stability augmentation have been used to mean a variety of things. In this report, stability augmentation refers to any device which modifies the feel characteristics and/or the aircraft responses to piloted control. A generic block diagram which encompasses all types of stability augmentation is shown in Figure 8. The dashed box in Figure 8

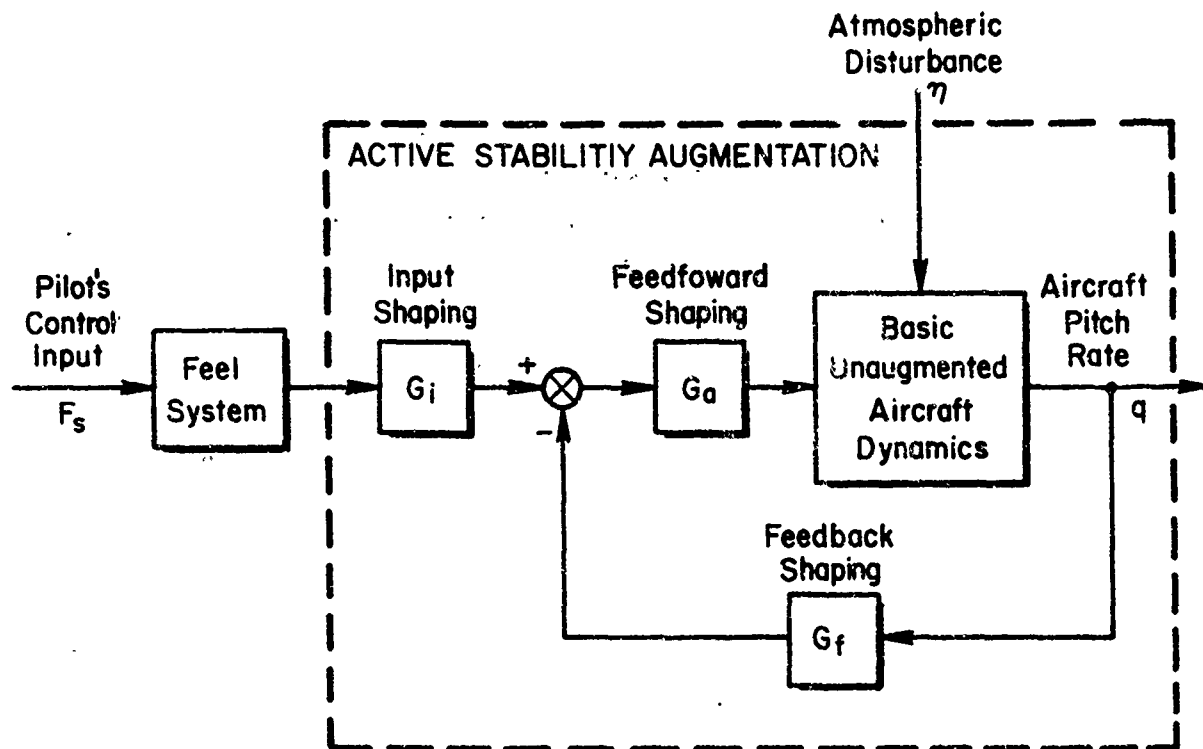

- Response to Pilot's Command

$$\frac{q}{F_s} \doteq \frac{G_i}{G_f} \quad \text{for } G_a, G_f \text{ large}$$

- Response to Atmospheric Disturbances

$$\frac{q}{\eta} \doteq 0 \quad \text{for } G_a, G_f \text{ large}$$

Figure 8. Generic Augmentation Block Diagram

denotes an active stability augmentor, meaning that the aircraft response characteristics are a result of sensing certain flight variables and feeding them back to the control surfaces. In the example shown, the flight variable is pitch rate,  $q$  which is fed to the aircraft elevator,  $\delta_e$ . An example of active stability augmentors used in current Part 25 aircraft are yaw dampers, where yaw rate or lateral acceleration is fed to the rudder actuator. To the best knowledge of the authors, there are no current Part 23 or Part 25 aircraft that utilize active stability augmentors for the pitch or roll axis. However, it is very likely that the next generation turbojet transport aircraft will utilize active stability augmentation (see for example, References 2, 3, and 4). The "G-terms" shown in Figure 8 represent electrical shaping of the input, feedforward, and feedback signals which are fed to the aircraft's actuators. As shown by the simple expressions below the block diagram in Figure 8, the aircraft pitch response to pilot stick force command,  $(q/F_s)$  can be totally determined by the nature of the input and feedback shaping networks if a "tight feedback loop" ( $G_a G_f \gg 0$ ) is utilized. This means that, at least in theory, basic aerodynamics no longer play an important role in the flying qualities of the aircraft. This concept is currently being used by Lockheed in a NASA sponsored simulator study involving an L1011 with center of gravity loadings aft of the neutral point. Their approach has been to utilize optimal control techniques to develop a feedback ( $G_f$ ) and feedforward ( $G_i$ ) structure that makes the aircraft response invariant to c.g. location. In the Lockheed study, pitch rate, normal acceleration, and airspeed signals are fed back and  $G_i/G_f$  are set so that the augmented short period and phugoid modes are always in a desirable location. A logical choice would be to use the phugoid and short period frequency and damping corresponding to a nominal c.g. location (say 25 percent MAC) as a reference value. Then, to the pilot, the aircraft response to control inputs always looks like that of an aircraft loaded so that the c.g. is at 25 percent MAC. Preliminary piloted simulation results being obtained by Lockheed have shown that this results in constant pilot ratings of 3 or better for a very wide range of c.g. locations including values aft of the neutral point.

Experience with highly augmented fighter aircraft has shown that while the ability to shape the response characteristics is indeed very desirable, the active stability augmentation system can introduce problems of its own. It is therefore important when flight testing such aircraft to understand the exact nature of these problems in order to determine the minimum requirements for a level of safety. An example of this is given in the discussion at the end of Section II and in Figure 2.

Aircraft that utilize high authority stability augmentors are the F-14, F-18, B-1, and the Concord. The Space Shuttle and F-16 are examples of aircraft using full authority active stability augmentation systems.

The feel system block in Figure 8 is required any time an irreversible flight control system is utilized and is not necessarily associated with active stability augmentation. For example, current day transports which typically utilize hydraulic irreversible flight control systems would be represented in Figure 8 as  $G_f = 0$  and  $G_a = G_1 = 1$ . That is to say that "augmentation" of a current day transport consists of a feel system block only. This is discussed in more detail in the following subsection.

The type of augmentation used is strongly influenced by whether the control system is reversible or irreversible. Examples of typical control systems are shown in Figure 9. Figure 9a illustrates a fully reversible control system wherein the aerodynamic hinge moments on the elevator are transmitted directly to the pilot stick via cables and linkage. This type of mechanization is typical of Part 23 aircraft. Figure 9b illustrates a servo tab operated control wherein motions of the pilot stick moves a tab on the back of the elevator which in turn creates a moment about the elevator hinge line. Hence the only force fed back to the pilot's control is that created by hinge moments of the tab. Such control systems for all practical purposes may be considered to be irreversible. This type of control system is used on some Part 25 aircraft such as the DC-9, DC-9-80 and Boeing 707. Most Part 25 aircraft utilize an irreversible hydraulically powered control system such



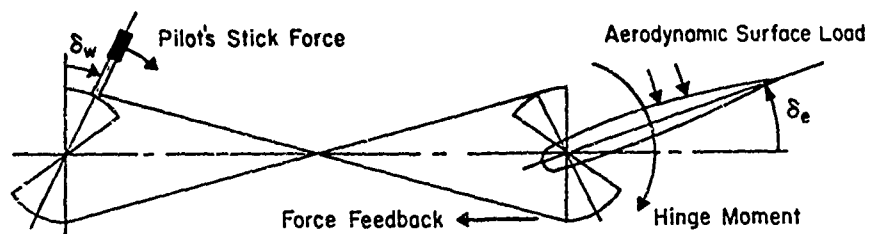

a) Reversible Control System  
(typical part 23 aircraft)

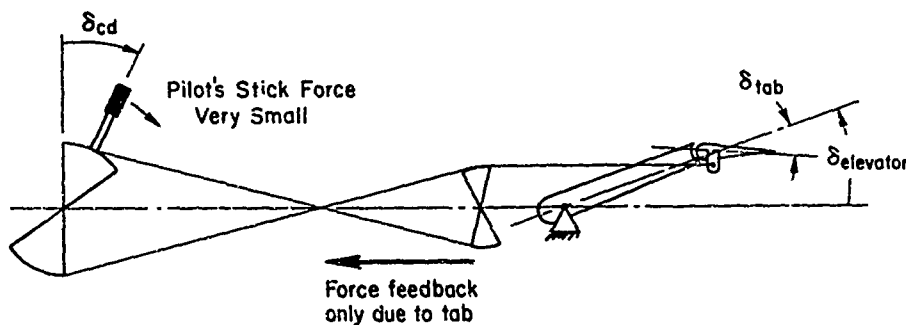

b) Servo Tab Operated Elevator  
(typical part 23 and some part 25 aircraft)

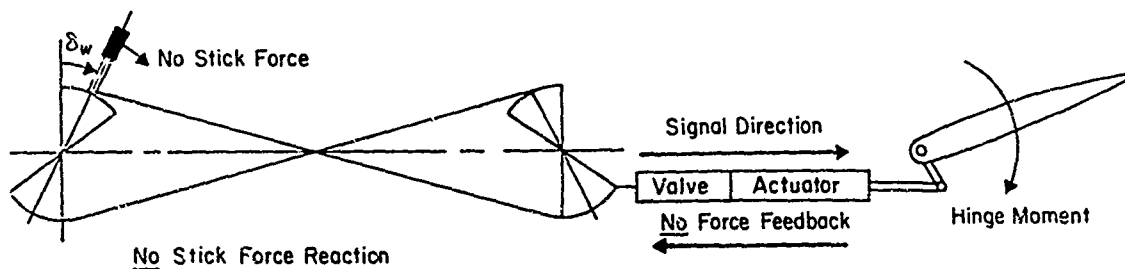

c) Irreversible Hydraulic Control System  
(typical part 25 aircraft)

Figure 9. Generic Representation of Reversible and Irreversible Flight Control Systems

as illustrated in Figure 9c. In this case there is no force feedback to the stick and motions of the cockpit controller only move a servo valve which in turn utilizes hydraulic pressure to move the aerodynamic control surfaces. Some aircraft such as the Boeing 727 use a combination of irreversible hydraulic and servo tab operated controls. The irreversible hydraulic system is usually primary with a servo tab or "aero boosted" controls acting as the backup flight control system. The Boeing 727 utilizes a dual irreversible hydraulic control system which is backed up by a single servo tab or aero boost.

The type of augmentation system employed tends to be a strong function of whether the control system is reversible or irreversible. The various types of augmentation associated with reversible and irreversible flight control systems is summarized in Figure 10. In the following subsections we shall briefly discuss each of the augmentation schemes listed in Figure 10 as they relate to airworthiness flight testing for compliance with FAR Part 23 and Part 25.

## **B. ACTIVE AUGMENTATION REVERSIBLE FLIGHT CONTROL SYSTEMS**

### **1. Reversible Flight Control Systems**

For all practical purposes there are no reversible flight control systems found on large turbo jet aircraft. However, there are some executive jets certified under Part 25 which utilize reversible flight control systems such as the Lear. Active augmentation on such aircraft is very difficult if not impossible due to the problems with implementing a series servo in a reversible flight control system\*. There are some light aircraft which utilize parallel servos for yaw damping. This

---

#### **\*Definitions:**

**Series servo:** A servo which moves the aircraft control surfaces without any apparent motion of the cockpit controls. It is connected to the control system "in series" and may be thought of as an extensible link.

**Parallel servo:** A servo which moves the entire control system (cockpit controls plus aerodynamic surfaces) at the same time.

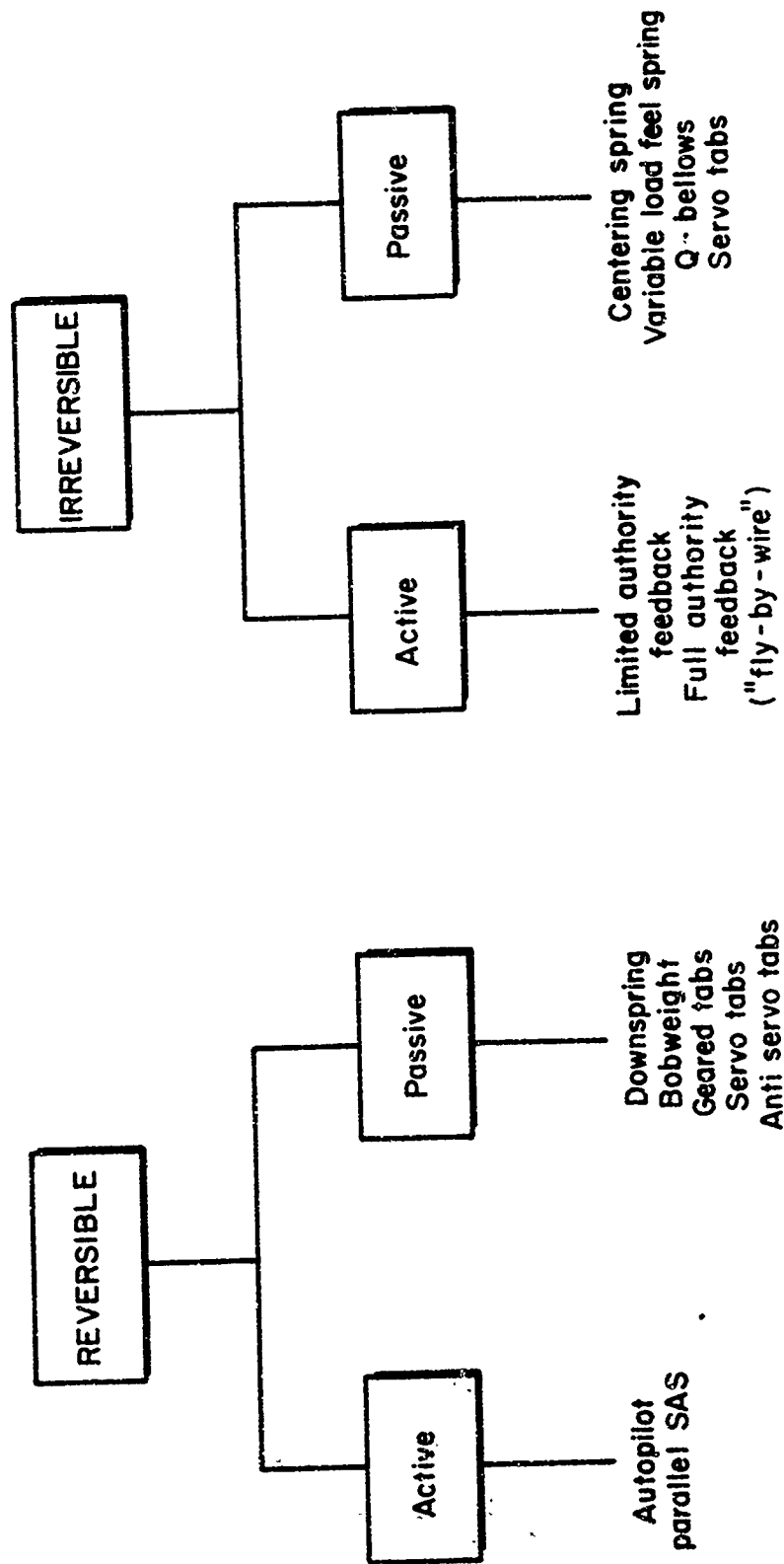

Figure 10. Effect of Control System on Augmentation

results in the rudder pedals moving as the aircraft regulates against disturbances, a feature which probably would be very objectionable in the pitch or roll controls, but goes essentially unnoticed in the rudder pedals. The flight test guide for Part 23 (FAA order 8110.7) should contain guidance relating to the force required to override the rudder servo during landing approach. If these forces are sufficiently low, there seems to be no reason to turn off the yaw damper during the final approach and landing where it is needed the most.

Autopilots are also listed as an active augmentation system for reversible controls. However because of the fact that auto pilots utilize parallel servos (which move the cockpit controls), they cannot be considered as augmentation in the true sense of the word. The reason for this is that the motions of the cockpit control due to auto pilot feedbacks make it essentially impossible to simultaneously "hand fly" the airplane. Flight test experiments utilizing parallel servos for augmentation have verified this conclusion (see for example, Reference 14).

### C. PASSIVE AUGMENTATION -- REVERSIBLE FLIGHT CONTROL SYSTEM

The passive augmentation devices typically used on reversible flight control systems are listed in Figure 10. Inasmuch as reversible flight control systems are not practical on large aircraft (due to extreme hinge moments), the discussion in this section is primarily oriented towards Part 23 aircraft as well as some executive jets that utilize reversible flight control systems such as the Lear. Unfortunately, there appears to be a myth circulating about that passive augmentation devices are "band-aids" that are necessary only because of inadequate aerodynamic design practice. In actuality, it is not possible to design an airplane with satisfactory handling qualities at the extreme limits of the forward and aft c.g. travel except for the most restrictive cases, i.e., two place airplanes. The problem with passive augmentation of reversible flight control systems has historically been with improper implementation as opposed to some fundamental drawback of the augmentor itself. In most cases, passive augmentation devices are utilized to

meet the static stability requirements of paragraphs .171 and .173. These paragraphs are basically requirements on stick free static stability, and as such address only the steady-state characteristics. The short term open loop dynamic characteristics of the airplane are covered by FAR Part 23.181 and 25.181. However, long term dynamic stability is not covered anywhere in FAR Part 23 or Part 25. This is a very significant oversight in that it allows the possibility of designing a downspring or bobweight which allows the aircraft to satisfy the static stability requirements of Paragraph .173 at the expense of long term dynamic stability.

#### 1. Downspring

The effect of a downspring is to increase the frequency and decrease the damping of the phugoid mode. This can result in aircraft which have a divergent phugoid mode which exists at a high enough frequency to directly affect the ability of the pilot to control the aircraft. Mechanizations have occurred where a variable rate downspring system was utilized so that it pulled the wheel forward at the command of an angle of attack vane. The system was mechanized in this way because the aircraft could not meet the FAR 23.173 requirement at speeds below certain cruise values. As discussed in Reference 15, pilots indicated that the aircraft utilizing this type of mechanization had a "wildly divergent" phugoid during operation in the high power climb mode. Variable stability flight tests were accomplished on Calspan's B-26 research aircraft to simulate the flying qualities of mechanizations like these. Sample pilot comments from that experiment (when simulating the aircraft at the aft c.g. limit) are excerpted from Reference 15 below.

- Pilot No. 1: Clearly not satisfied with speed and attitude control. High workload.
- Pilot No. 2: High workload; Stability problem in pitch; commercial operator would not be satisfied with pitch. Unsatisfactory.
- Pilot No. 3: Unstable in airspeed; hard to fly.

These pilot comments from the variable stability experiment (combined with other comments indicating a very divergent phugoid) suggest that these types of passive augmentation mechanizations can provide overall degraded flying qualities. However, it should be emphasized that one could successfully meet paragraph .173 with these types of mechanizations. The main point of this example is that the lack of a requirement on long term dynamic stability can result in augmentation schemes which are designed to improve static stability, but actually degrade the overall flying qualities significantly.

In light of the above discussion, consider the effect of a downspring on the phugoid mode for Case b (aft c.g. limit) for the example aircraft used in Figures 4 and 6. As shown in Figure 11, increasing the downspring causes the phugoid to increase in frequency while moving into the right-half plane. Physical interpretation of this (see Figure 7) is that the aircraft will experience a low to mid-frequency divergent oscillation. Experience with flying qualities has shown that pilots can easily damp a divergent oscillation at very low frequency such as the phugoid on most classical aircraft. However, as the frequency of the divergent oscillation increases, the pilot's ability to cope with it

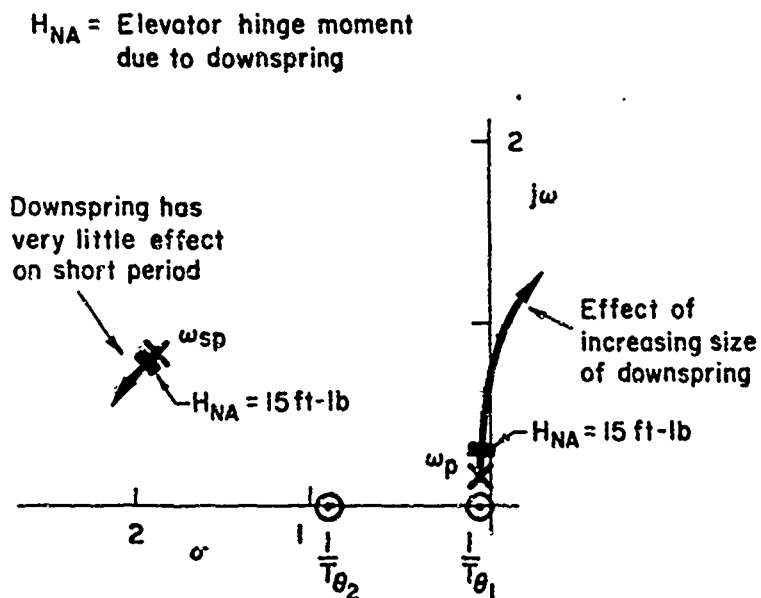

Figure 11. Effect of Increasing Downspring on the Phugoid Mode.

degrades rapidly. Strong evidence of this pilot rating trend is given in Reference 16 where it is shown that VSTOL pilots were willing to accept rather large instabilities as long as the frequency of the unstable mode was kept below 0.5 rad/sec.

For most aircraft, the size of the downspring required to meet Paragraph .173 is relatively small and does not have an appreciable effect on the phugoid mode. It is only in extreme cases that the phugoid characteristics will be modified to the extent shown in Figure 11. However, the example quoted above is evidence that such a divergence can occur in practice and that a requirement for long term dynamic stability is indeed necessary.

The need for a requirement on long term dynamic stability in Part 23 and Part 25 should not be viewed as having the effect of eliminating or minimizing the use of passive augmentation devices. Rather, such a requirement will simply insure that passive augmenters will be properly implemented. As discussed above, passive augmenters are not engineering "band-aids" but rather an integral part of the airframe-control system design necessary to achieve the center of gravity envelopes required for maximum utility. In this light, some specific design features of downsprings are discussed in the following paragraphs.

Consider first the effect of the downspring in the phugoid mode as shown in Figure 11. The shaded box labeled  $H_{NA} = 15$  ft-lb indicates the modified location of the phugoid and short period roots if a downspring which resulted in a net elevator hinge moment of 15 ft-lb were utilized ( $H_{NA}$  indicates a "non-aerodynamic" hinge moment). The effect of this fairly hefty downspring is seen to be negligible on the short period root (as would be expected) and to modify the phugoid mode, a relatively small amount; certainly not enough to noticeably affect the aircraft flying qualities. To put things in perspective, it would require a downspring of about 100 to 160 ft/lbs to drive the phugoid mode into the unstable right half plane in the example shown in Figure 11. The point being that for the majority of cases, the use of a downspring to improve longitudinal control feel at the aft center of gravity locations will have a very small effect on the long term dynamic stability.

The use of a downspring to improve the flying qualities at the aft c.g. limit has in many cases resulted in very poor flying qualities at the forward c.g. limit due to extreme stick forces. Examples of such aircraft can be found in many of the six and eight place single and twin engine aircraft certified under Part 23. These very large forces are most noticeable during flare and touchdown. Experience has shown that precision touchdowns are nearly impossible when operating with such extremely large stick force gradients inasmuch as the effect is amplified by the decreased elevator effectiveness which occurs in the presence of the ground plane. While it is not currently evident as to the exact rationale utilized to ensure meeting some standard of acceptable stick force requirements, this situation could be a good candidate area to be improved with appropriate updated guidance in Paragraph .143, Engineering Flight Test Guide.

## 2. Bobweights

Bobweights are generally included in the flight control systems to improve the steady-state maneuvering stability or stick force per g. It should be emphasized that the stick force per g measurements are taken in steady accelerated flight such as a steady turn or a constant pitch rate pullup. Actually, Part 25 does not have a requirements on stick force per g, whereas Part 23 does (23.155). It is not clear why Part 25 does not require maneuvering stability. Nonetheless, manufacturers of Part 25 aircraft invariably check for adequate maneuvering stability and utilize bobweights where such stability is "deficient." It should also be noted that a bobweight also improves the stick force vs. speed gradient by virtue of the fact that it produces a non-aerodynamic hinge moment about the elevator hinge line.

While the basic intent of the bobweight is to augment static maneuvering stability\*, incorrect implementation can have adverse effects for short-term dynamics. Dynamic problems which occur as a result of the

---

\*Static maneuvering stability refers to the fact that the normal acceleration is relatively constant.



implementation of a bobweight are somewhat insidious in that they do not effect the basic aircraft response characteristics, i.e., the response to an elevator pulse or step. Instead, the bobweight problems usually show up as a problem with aircraft feel characteristics; generally a tendency towards "stick force lightening." Such stick force lightening can result from the use of a bobweight in conjunction with an aerodynamically balanced elevator or a bobweight which is located too far aft. Such problems usually manifest themselves as a tendency towards pilot induced oscillations or pitch bobbling in tight tracking situations. They have occurred on numerous military aircraft starting with P-63A up through the A4D, F-4, and T-38A. As a result of these problems, the military flying qualities specification places a limit on the amount of phase lead that can exist between elevator position and elevator force. A detailed description of this phenomenon and of the military flying qualities specification used to prevent such problems, is given in Reference 16, pages 135 through 159.

In order to account for the pilot induced oscillation tendencies that can occur due to the implementation of a bobweight, specific guidance should be included in Paragraph 143 of the engineering flight test guide. In particular, the words "safely, controllable, and maneuverable" contained in Paragraph 25.143 and 23.143 need to be interpreted utilizing flight test maneuvers that would expose any tendency toward stick force lightening and/or pilot induced oscillations. The possibility of utilizing FAR Paragraph .181 (dynamic stability) to cover this problem was considered. However the wording of FAR Paragraph .181 does not include the effects of piloted control, and hence would not address the deficiency. In the long term, perhaps the best solution would be to formulate a requirement specifically oriented towards assuring against undesirable stick force lightening and the consequent pilot induced oscillations.

### 3. Elevator Tabs

The effective elevator hinge moments can be modified by means of geared tabs. As discussed above and shown in Figure 9b, the cockpit

control can be attached directly to the tab which in turn drives the elevator.

The primary safety concern with the use of tabs centers about flutter which is covered in other parts of the FARs.

#### **D. ACTIVE AUGMENTATION — IRREVERSIBLE FLIGHT CONTROL SYSTEMS**

This section will concentrate, in some detail, on the discussion of the application of stability augmentation to relaxed static stability (RSS) aircraft. The potential for the utilization of such aircraft in the not too distant future has already been discussed in Section I of this volume and is discussed at some length in Volume II. A significant portion of the research reported herein was devoted to analysis for establishing the so called minimum requirement for a level of safety for highly augmented RSS aircraft. The technical details of the analysis are the subject of Volume II. In this section, an overview is presented with just enough technical detail to provide the reader with sufficient background to develop a program for modification of the FAA Engineering Flight Test Guide (Reference 1) and possibly pertinent sections of the FAR's themselves, where necessary.

##### **1. Generic Characteristics of Pitch Axis Augmentation**

The potential performance benefits to be gained by the use of relaxed static stability airframes stabilized with full-time augmentation type Flight Control Systems (FCS) systems has been considered for many years. However, it has only been in the last few years that full-time, high-authority, high-gain stability augmentation systems have become feasible for operational use due to maturing of the technology and concomitant improvements in reliability. The advent of operational RSS aircraft such as the F-16 fighter and the Space Shuttle opens the door to general use of FCS significantly different from previous stability augmentation systems. Once the decision is made to operate with relaxed static stability, a unique primary requirement is introduced into the design of the stability augmentation system, i.e. it must stabilize the unstable real short-period pole shown in Case d of Figure 6.

## 2. Limited vs. Full Authority Augmentors

In cases where only minor modifications to the aircraft stability is required, a limited authority SAS may be more appropriate than the high gain full authority augmentation systems discussed in Volume II of this report. For example, if in the case of relaxed static stability aircraft the static margin remains positive but small, it may be possible to stabilize the aircraft to acceptable values with only a limited authority pitch damper. Such a mechanization is shown in Figure 12a. The total elevator travel in a limited authority SAS is driven by two servos; the parallel servo via the mechanical path and the series servo via the electrical path. The mechanical path (Figure 12a) allows full elevator travel (+10 to -15 degrees in this example) whereas the electrical path is limited to only a  $\pm 4$  deg of elevator. The important distinction here is that a hardover failure of the series servo will involve only 4 deg of elevator and will probably not result in a catastrophic divergence in aircraft pitch attitude. However, airworthiness assessment flight tests conducted for the certification of such a system must involve simulated hardover failure of this series servo at critical points in the flight envelope to determine the ability of the pilot to recover from such failures. As discussed in Section V, the results of such hardover testing will determine if the SAS is an "essential" or "critical" function (defined in Section V). Guidelines for such flight testing should be very specific in the engineering flight test guide.

Consider now a typical full authority augmentor as shown in Figure 12b. Notice that there is no longer a parallel servo and that the full travel of the elevator motion is commanded via the series servo. It should be noted that series servos isolate the aircraft control surface from the cockpit control so that the complex elevator motions required for stability augmentation are not reflected into the cockpit controls. Hence stability augmentation loops always involve a series servo. In the case of a full authority augmentation system, the series servo saturation limits are identical to full travel of the aircraft control surface. It can be seen that hard over failures of a series

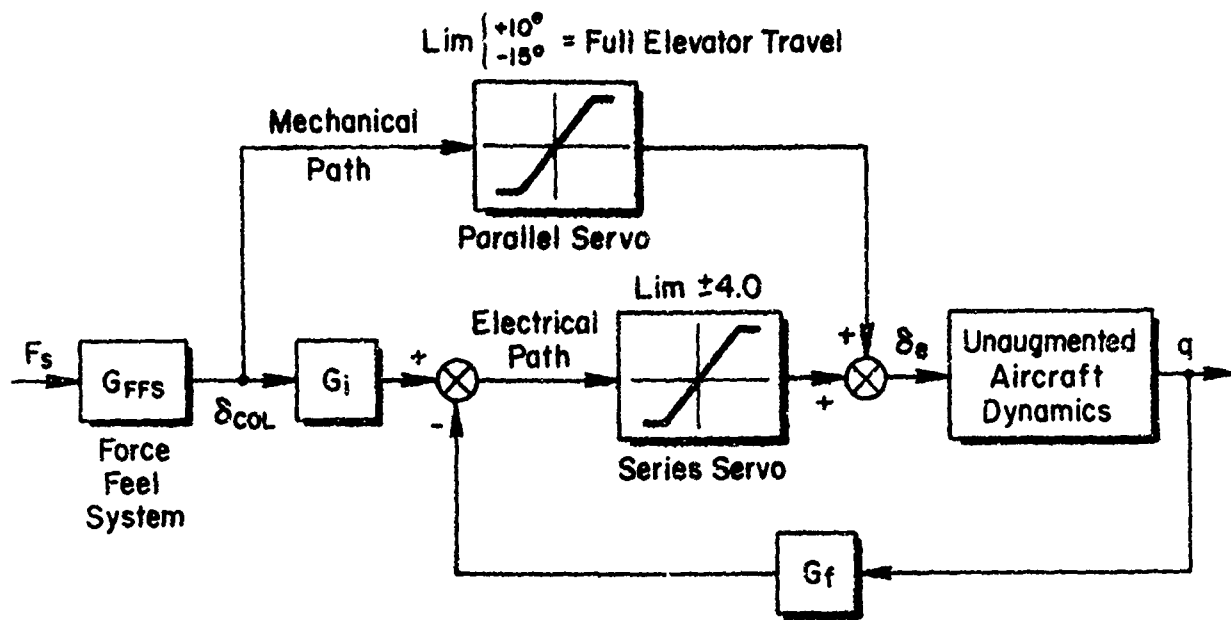

a) Typical Limited Authority Augmentation

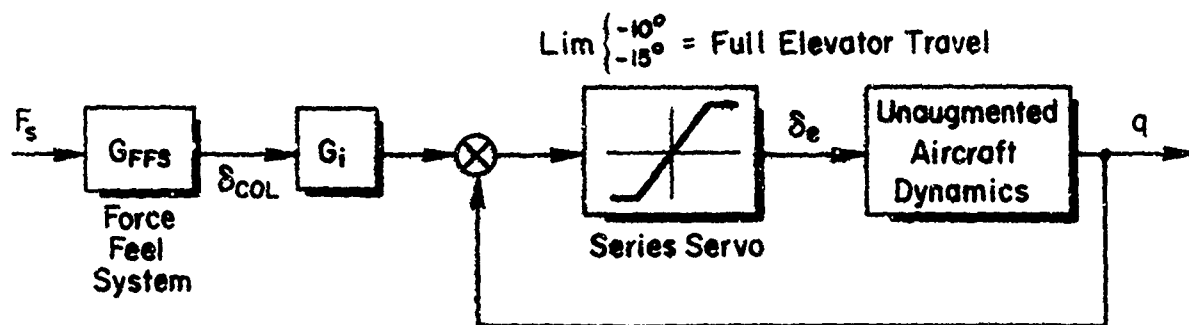

b) Typical Full Authority Augmentation ("Fly By Wire")

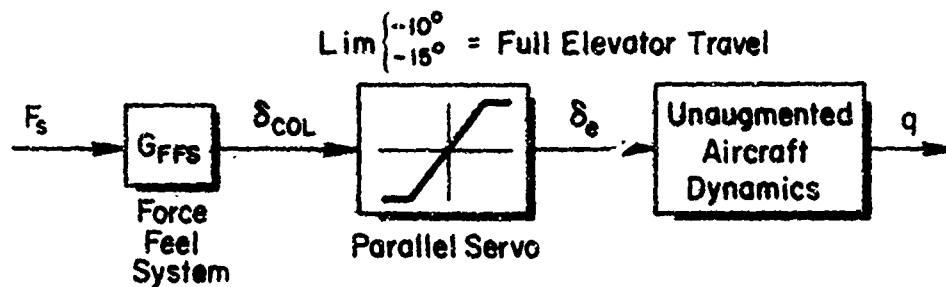

c) Typical Current Day Transport (Force Feel System With No Active SAS)

Figure 12. Generic Survey of Pitch Attitude Control Systems

servo would be catastrophic and hence, there is a need for sufficient redundancy to make the hard over failure extremely improbable. Such systems are frequently termed "fly-by-wire" because there is no direct link between the cockpit controls and the aircraft control surfaces. There is a considerable amount of controversy centered about the use of a fly-by-wire, full authority augmentation system on a commercial transport. Opponents of such a scheme point out that even though the probability of simultaneous failure of all four redundant channels is extremely remote, it nonetheless does exist and therefore constitutes an unacceptable risk. Those in favor of the scheme propose a highly redundant flight control system with an extremely reliable backup (dissimilar) flight control system. This concept was proposed by Boeing in the development of a commercial supersonic transport where the backup flight control system was referred to as a "hardened SAS". We should also note that in the recently completed Energy Efficient Transport studies, all three contractors proposed a full authority, fly-by-wire flight control system (see References 2, 3, and 4). Clearly, the concept of a hardened SAS as a, dissimilar, backup flight control system would have to be adequately demonstrated before certification of such an aircraft could be even considered. However, it seems pertinent to begin considerations of such backup flight control systems in the flight test guide at this time so as to be in a position to evaluate manufacturer's proposals for future transport aircraft.

Finally, in Figure 12c, the typical current day transport flight control system is shown. This consists typically of a fully powered, irreversible hydraulic servo (parallel servo) wherein the cockpit control simply operates the servo valves. A force feel system is included to provide "conventional control feel" for the pilot. This is discussed in more detail in Section IV-E.

### **3. Augmentation Possibilities for Relaxed Static Stability Aircraft**

As noted above, the first requirement for a relaxed static stability augmentation system is stabilization of the unstable real short-period

root. As noted in Section III, the primary physical cause of this instability is a positive value of the pitching moment due to angle-of-attack derivative,  $C_{m_{\alpha}}$ . Consequently, an obvious approach to stabilization would be to augment  $C_{m_{\alpha}}$  by feeding back measured angle-of-attack to the elevator. While in theory this would give a "natural" or conventional flying qualities characteristic to the aircraft, there are certain practical problems in implementing such systems. Primary among these is the difficulty measuring angle-of-attack and filtering out the effects of turbulence. While the very nature of feedback augmentation tends to make the response to control inputs insensitive to variations in the vehicle dynamics, biases and noise in the feedback path, in particular those introduced by the angle-of-attack sensor, are not similarly desensitized and thus high-quality measurements are critical. Furthermore, there is a need to generate a reference angle of attack for the system, which will vary with weight, c.g., and flight condition. These problems and others discussed in more detail in Volume II have led flight control system designers to consider alternative systems which may produce somewhat "unconventional" response characteristics.

A family of flight control systems of particular interest for RSS aircraft are those based on measurement of pitch attitude and/or pitch rate fed back to the elevator. An obvious precedent for such systems is the "conventional" pitch damper, in which pitch rate, sensed by a rate gyro, is fed back to elevator. Pitch rate gyros have less of a problem with noise or gust sensitivity as compared to angle-of-attack sensors. Since the reference pitch rate is always zero, at least in non-turning flight, the problem of finding a system reference condition is not nearly as complex as for an angle-of-attack sensor.

Conventional pitch damper systems augment the airframes intrinsic "pitching-moment-due-to-pitch-rate" stability derivative, which in turn helps to damp the short-period motions. The vehicle dynamics are otherwise still largely dominated by the basic airframe aerodynamic and inertial characteristics. However, if the gain of a pitch damper system were increased sufficiently, the basic airframe dynamics would be further suppressed, and the system would approach a "pitch rate command

system." That is, over a wide frequency range, the aircraft would be forced by the pitch rate feedback to follow a pitch rate command proportional to the stick deflection. Such systems have desirable characteristics for closed-loop manual control and tend to reduce the instability of an RSS, aircraft i.e., reduce the time to double amplitude of the unstable root. However, it can never (for finite gain) create a neutral or stable system and in this sense would not meet the requirements of the Federal Aviation Regulations as presently stated.

Complete stabilization can be accomplished by feeding pitch attitude,  $\theta$ , to elevator. This creates an artificial "pitching-moment-derivative-to-pitch-attitude" stability derivative for which there is no precedent in conventional aircraft dynamics. In effect, this feedback puts a "spring" between the aircraft pitch attitude and the horizon reference in place of the  $C_{m_x}$  "spring" between a conventional aircraft and its velocity vector. Mechanization of such a system requires a vertical gyro or inertial measurement unit (IMU) to provide the pitch attitude signal and the horizontal reference plane and a successful system would be combined with a pitch rate-to-elevator loop to provide damping.

In light of the above discussion, two generic augmentation schemes involving pitch attitude,  $\theta$ , and pitch rate,  $q$ , are presented in Figure 13. The basic characteristics of each augmentation scheme are summarized below the block diagrams. It is noted in Figure 13 that some pitch attitude feedback is required to drive the unstable root (Case d, Figure 6) into the left half plane. However, a reasonably tight pitch rate closure (Figure 13a) drives the unstable root very close to the origin and hence the instability occurs at a very low frequency. Physically, this means that noticeable effects of the divergence would occur very slowly and a long time after a control input. Most likely, the pilot would be unable to distinguish such a divergence from turbulence or inadvertent control inputs. Much like a conventional lightly damped phugoid, it would be somewhat of a nuisance if the pilot were to manually fly the aircraft for a long period of time.

Consider now the time response characteristics of the aircraft with neutral static stability (Case A in Figure 14) as compared to an air-

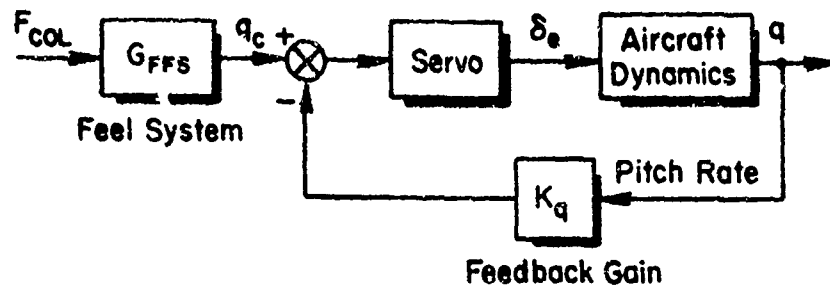

- Improves damping but will not stabilize an unstable mode
- Response looks like a pure rate ie step column gives ramp attitude response
- Aircraft will not return to trim when disturbed

a) Pure Rate Augmented

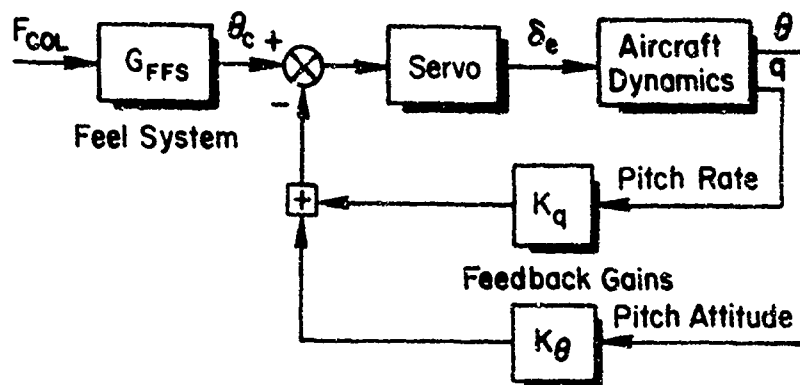

- Improves damping and will stabilize unstable modes
- Response looks like a classical airplane with good static stability
- Aircraft will return to trim when disturbed if power is held constant

b) Attitude Command System

Figure 13. Generic Augmentation of Pitch Axis



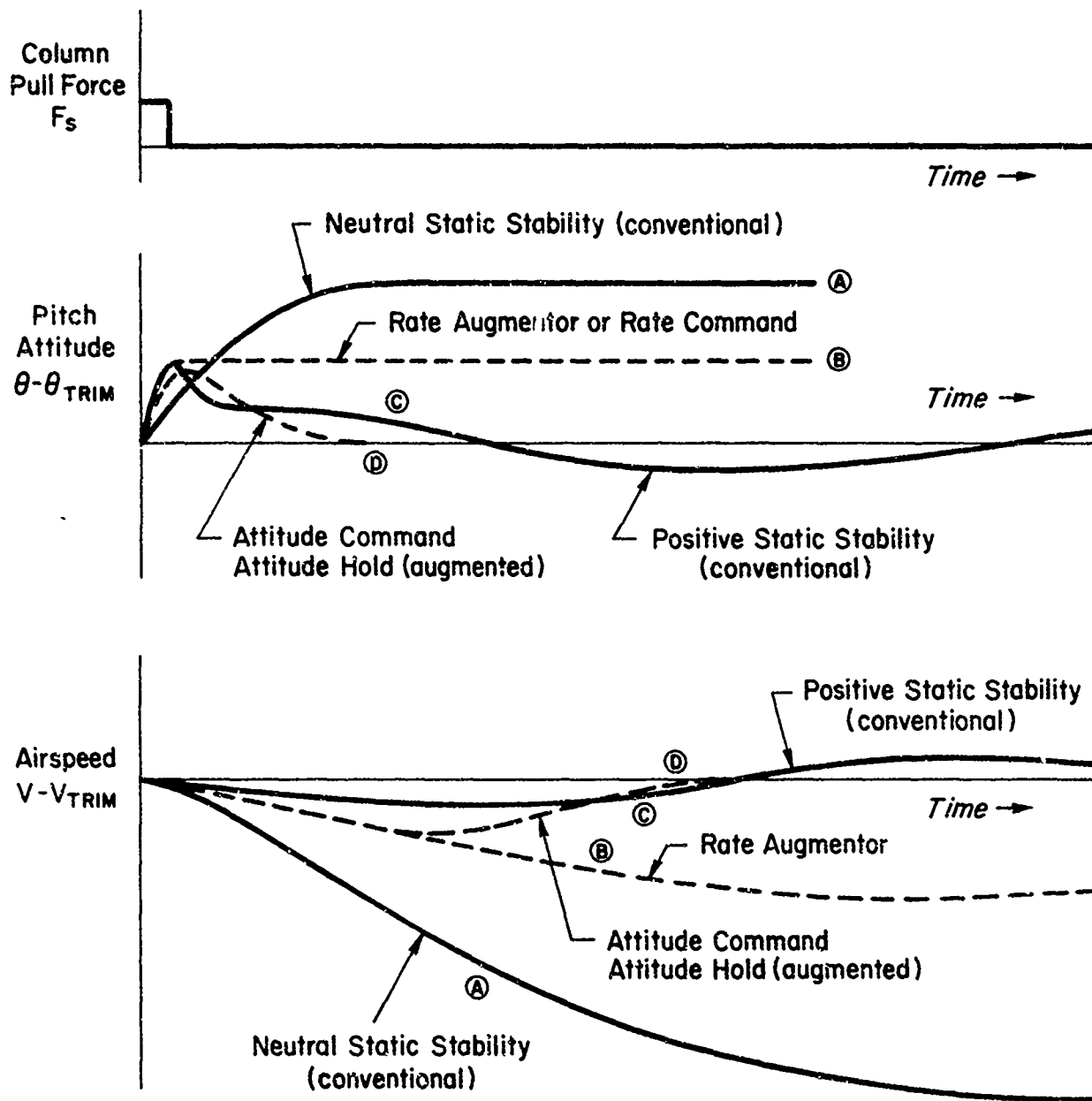

Figure 14. Comparison of Conventional and Augmented Time Responses to a Pulse Input

craft with pitch rate augmentation (Case B in Figure 14). The pitch attitude and airspeed responses to a pulse column input are seen to exhibit similar shapes, i.e., there is no tendency to return to trim and hence the stick force gradient,  $dF_s/dV = 0$  in both cases (compare A and B in Figure 14). However, to the pilot, the responses are drastically different in that the rate augmented pitch response is sharp and precise (Case B in Figure 14) whereas the unaugmented aircraft with neutral static stability has a very sluggish attitude response (case A in Figure 14). The key distinction to be made here is that static stability is not a valid measure of the quality of the dynamic pitch response for augmented aircraft. Hence we must re-evaluate the necessity of a negative stick force gradient on its own merit; a subject which is covered in the following subsection and in Volume II. The issue is an important one because of its implication on the validity of FAR Paragraph 23.173 and 25.173 for certain types of highly augmented aircraft.

Consider now the use of attitude feedback to obtain an attitude command system as shown in Figure 13b. The response of such a system looks very much like a conventional aircraft in almost every respect, i.e., the attitude response is crisp and the aircraft returns rapidly to its trim value (Figure 14D) thereby having positive effective static stability ( $dF_s/dV < 0$ ). Unlike conventional aircraft with good static margin, the attitude command augmentor also critically damps the phugoid mode. Comparison of the time histories C and D in Figure 14 illustrates these points, i.e., the attitude responses are crisp in both cases, the aircraft returns to trim in both cases, and the attitude augmentation critically damps out the phugoid oscillation. One "unnatural" tendency of an attitude augmented aircraft is the necessity for the pilot to retrim after an attitude change, even if speed is held constant with power. One NASA pilot commented adversely on this characteristic in the moving base simulator experiment of Reference 18. His primary objection centered about excessive trimming on the ILS approach. However, the primary disadvantage of attitude augmentation is the necessity for an attitude gyro in addition to the rate gyro. When redundancy requirements are considered, the cost of such a system can be very high.

The system mechanization can be simplified by computing pitch attitude from integration of pitch rate from the rate gyro, thus eliminating the need for a vertical gyro or IMU, i.e.,  $\theta \approx \int q \, dt$  in level flight. This system needs only a simple turn coordination provision to account for the non-zero body-axis pitch rate in a steady turn. One possible mechanization of a  $q, \int q \rightarrow \delta_e$  augmentation system, shown in Figure 15\*. This system provides feedback of  $q$  and attitude computed as the integral of pitch rate thereby eliminating the need for a pitch attitude gyro. Because the pilot's command,  $\delta_{col}$ , is inserted downstream of the integrator (i.e., the integrator is in the feedback loop) the system will tend to force the aircraft to follow pitch attitude commands,  $\theta_c$ , which are proportional to stick force,  $F_s$ .

Practical use of the above system would require provision for an attitude reference and there are potential problems with attitude drift due to integration of sensor noise. An alternative mechanization, shown in Figure 16, solves these problems. The feedback structure of the "pitch rate command system" of Figure 16 is identical of that of the pitch attitude command system of Figure 15 and stabilizes the unstable short-period root in exactly the same manner. The systems differ in the way the pilot's command input is inserted into the system. In the pitch rate command system the integrator is now in the forward loop, downstream of the pilot's input. Thus, the pilot's stick force (or equivalently deflection) produces a proportional pitch rate command from which the actual measured pitch rate is subtracted to form an error signal that is fed through the forward loop compensation (proportional and integral paths) to the elevator. Thus, for sufficiently high gain, this system will cause the aircraft to follow the commanded pitch rate,  $q_c$ , independent of aircraft dynamics over a wide frequency range. There is no requirement for a pitch attitude reference with this mechanization and hence it is more practical than the Figure 15 system. In fact, two

---

\* $q, \int q \rightarrow \delta_e$  refers to the use of pitch rate ( $q$ ) and integral of pitch rate ( $\int q$ ) in the control law. Note that the integral of pitch rate looks like pitch attitude in wings level flight.

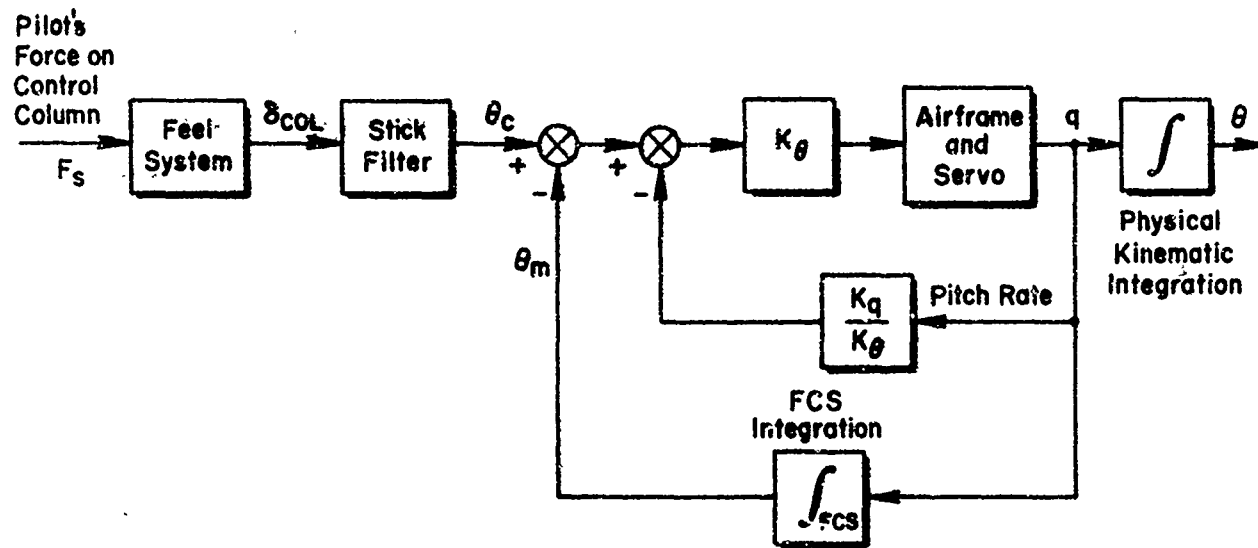

Figure 15. Pitch Attitude Command System

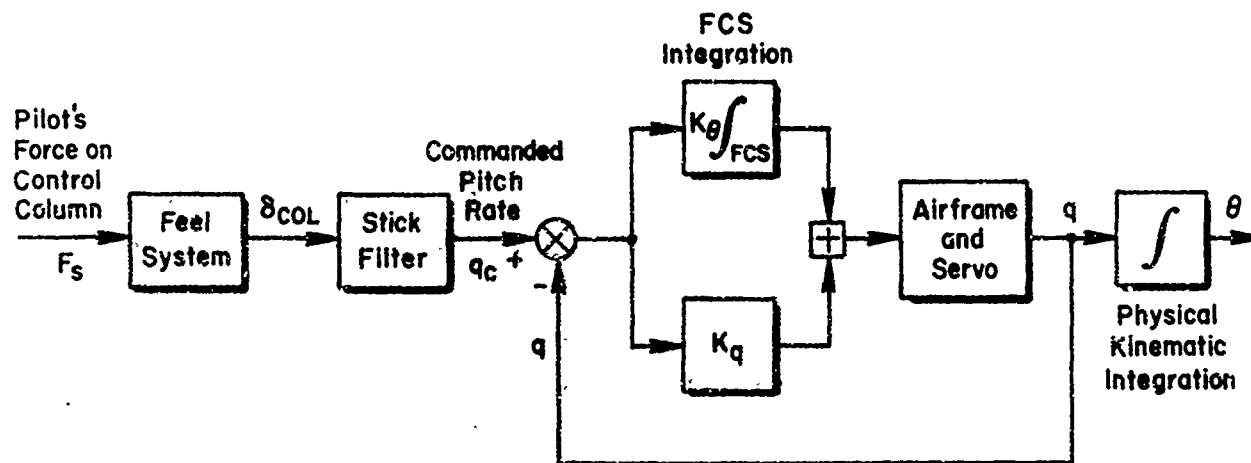

Figure 16. Pitch Rate Command System

examples of highly augmented aircraft currently flying, the F-16 and Space Shuttle both utilize the Figure 16 mechanization. The response characteristics of this system are very similar to the generic pure rate augmentor of Figure 13a. That is, the dynamic pitch response will be rapid and well damped and the apparent static stability will be zero, i.e.,  $dF_g/dV = 0$ . The implications of this are discussed in the following subsection.

#### 4. Stick Force vs. Speed Gradient

Experience has shown that the transition between a conventional aircraft and one with rate command augmentation (and hence, zero stick force gradient) can be accomplished without any significant problems for the majority of pilots. In terms of actual aircraft control, a good rate command augmentor is, in most cases, superior to conventional unaugmented aircraft for the following reasons:

- The aircraft tends to be very stable in turbulence.
- Controlled element (aircraft) is K/s-like (i.e., looks like a pure integrator) in the region of piloted control and therefore is ideal for closed-loop control. (See Ref. 13.)
- The pitch dynamics are not sensitive to changes in center of gravity variations.

The neutral speed characteristics of a rate command augmentor do however result in a requirement for unconventional piloting techniques in the landing flare. More specifically, as a conventional aircraft approaches touchdown, increasing back pressure on the column is usually required to increase the pitch attitude as necessary to arrest the sink rate and to counter the nosedown pitching moment due to decreasing airspeed and the change in downwash at the tail due to ground effect. These last two effects tend to increase very rapidly near touchdown, which accounts for the usual large increase in required back pressure. For a pitch rate command system, (Figure 16) the augmentation automatically counters the effect of decreasing airspeed and changing downwash at the tail so that small pulses on the control column are all that is

required to effect an increase in attitude to arrest the sink rate. During an FAA sponsored series of tests on the Princeton University Variable Stability NAVION, it was found that most pilots tended to overrotate the rate augmented configurations in the landing flare. In conventional aircraft, such an overrotation requires a lessening of the back pressure to decrease pitch attitude. However, for rate augmented configurations, a decrease in pitch attitude requires a push on the control column which is extremely unnatural for pilots trained and experienced on conventional aircraft. Nonetheless, all the pilots that participated in the Princeton experiment were able to consistently land in the designated touchdown zone with the pitch rate command augmented system after about 3 or 4 trials. Thus, it appears that while the technique is different, it is not difficult to learn. This conclusion has been supported during a number of experiments which are summarized below.

- Several of the short takeoff and landing (STOL) aircraft that have been tested at NASA/Ames Research Center have utilized rate command augmentation. The research pilots that have participated in this program are thoroughly convinced that rate command is a viable way to fly and that the concomitant neutral speed stability is not a problem.
- The Space Shuttle utilizes a rate command system and has a neutral stick force vs. speed gradient. The pilots initially objected to the neutral speed stability; however, as they gained experience with the system, this characteristic seemed to have little or no effect on the pilot ratings.
- Perhaps the most extensive study of pitch rate command systems including the impact of a neutral stick force vs. speed gradient is the research of Moolj and others at the National Aerospace Laboratory of The Netherlands, References 20-27. Specifically, References 24 and 25 analyzed approach and landing with three levels of stick force vs. speed gradient: zero, -0.2, and -0.5 lb/kt. The results of this flight experiment which involved a medium jet transport are summarized in Figure 17. A review of this figure indicates that a change in stick force gradient from zero to -0.2 lb/kt has very little effect on either the pilot ratings or performance. Further increasing the stick force gradient (negatively) to -0.5 lb/kt results in a degradation in both pilot ratings and performance.

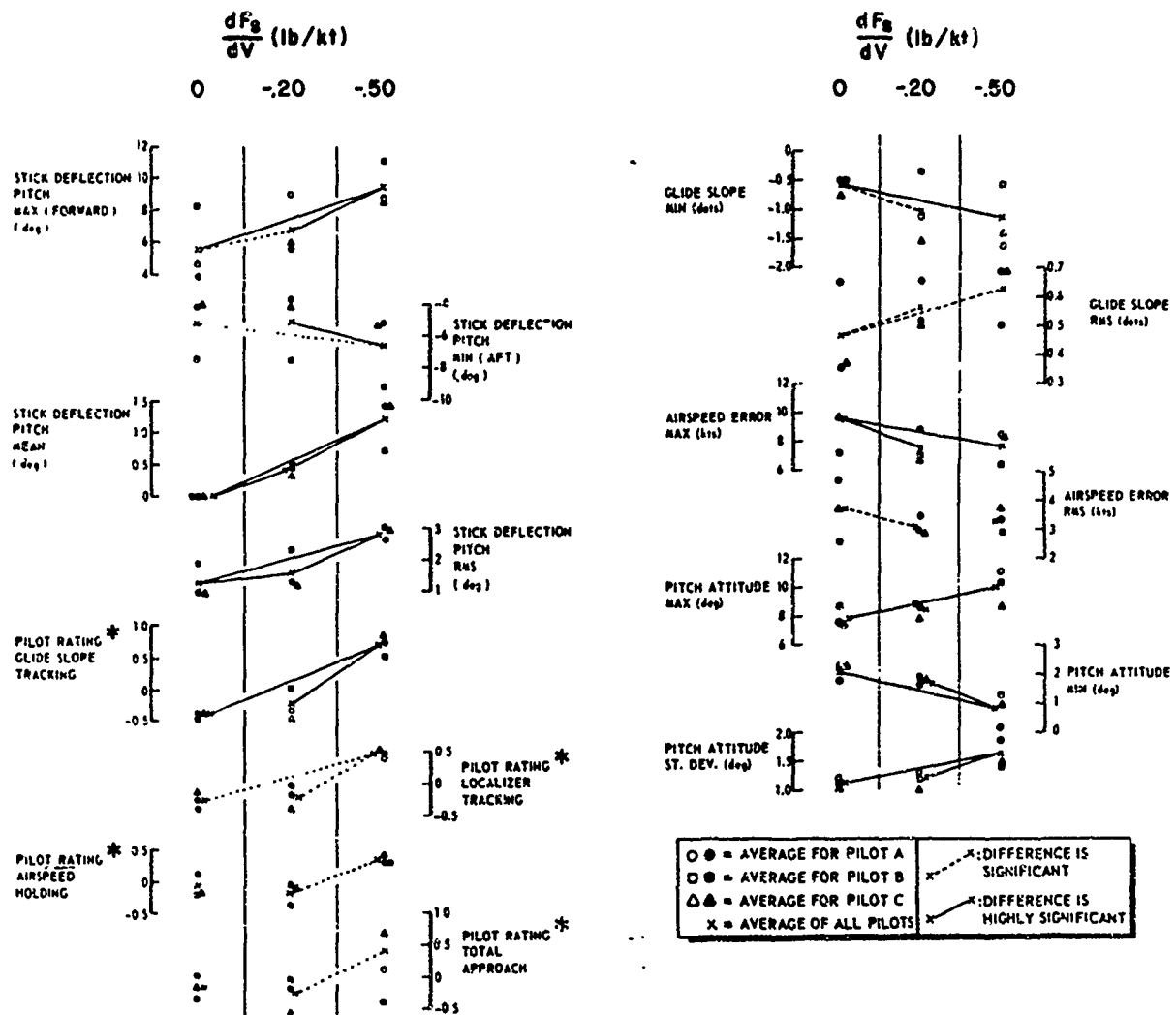

\*Pilot Rating: Standard normal form (zero mean, unity variance) for each pilot, positive increments indicate adverse changes

Figure 17. Derived Quantities for Which Significant Differences Occurred

- The F-16 utilizes a full authority rate command augmentation system. However, an angle of attack feedback is engaged in the power approach flight condition to provide a stable stick force gradient. Extensive flight testing has been performed over the past two years at the Air Force Flight Test Center in an effort to improve the flying qualities of the F-16 in the approach and landing flight condition. Many changes were made in the mechanization of the angle of attack feedback. Interestingly, the most favorable comments regarding control of the aircraft during flare and landing occurred when the angle of attack feedback was removed completely. However, it was feared that low time pilots could get into trouble in bad weather situations, if the stick force cue were removed completely, and a compromise was made in order to retain a stable stick force vs. airspeed gradient.
- Work recently completed on the Calspan variable stability Total In-Flight Simulation (TIFS) has shown that very desirable pilot ratings could be attained for rate augmented aircraft with neutral speed stability. The purpose of this study was to analyze very large aircraft on the order of 1 million pounds, and is therefore somewhat appropriate to the transport category of aircraft being certificated by Part 25. As in the Princeton NAVION variable stability experiment, the initial pilot ratings were somewhat unfavorable (on the order of 4) but as experience was gained with rate augmentation, pilot ratings increased to as high as "1" (see Pilot Rating Scale in Figure 1).

A review of the above experimental results certainly does not justify a requirement for speed stability or a stable stick force gradient. However, because of the possible safety implications of removing such a requirement from the Federal Aviation Regulations, such action does not seem warranted at this time. The above data is presented here only to indicate that our minds should not be closed to the possibility that augmented aircraft may not require a stable stick force gradient. Certainly more operationally oriented research is required in this area.

Before leaving this subject, it should be pointed out that the effect of feeding back airspeed to obtain a stable stick force gradient on the rate augmented system is to decrease the phugoid damping. As shown in Figure 18, not only is the phugoid damping decreased but the phugoid frequency is increased. As discussed earlier in this report, the combination of low phugoid damping and high phugoid frequency tends



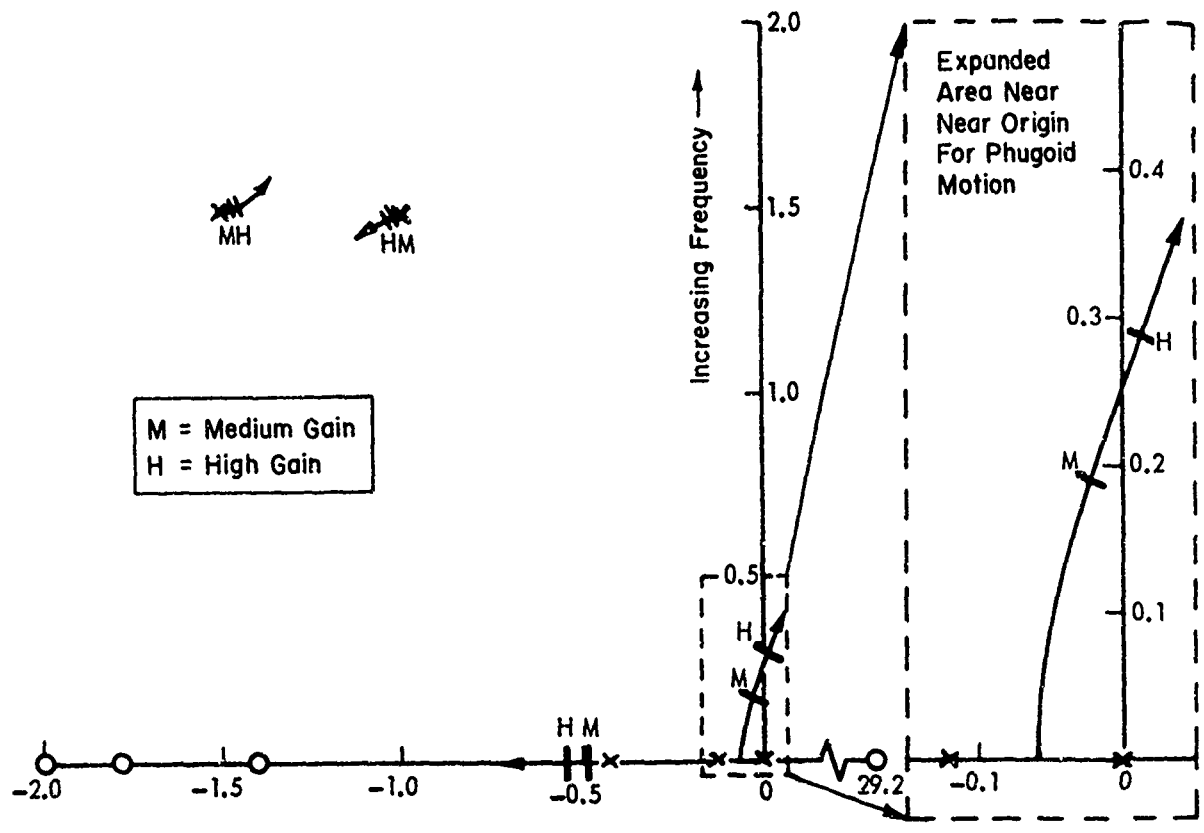

a) Root locus showing the effect of increasing stick force/speed gradient ( $u \rightarrow \delta_e$  gain) on phugoid mode.

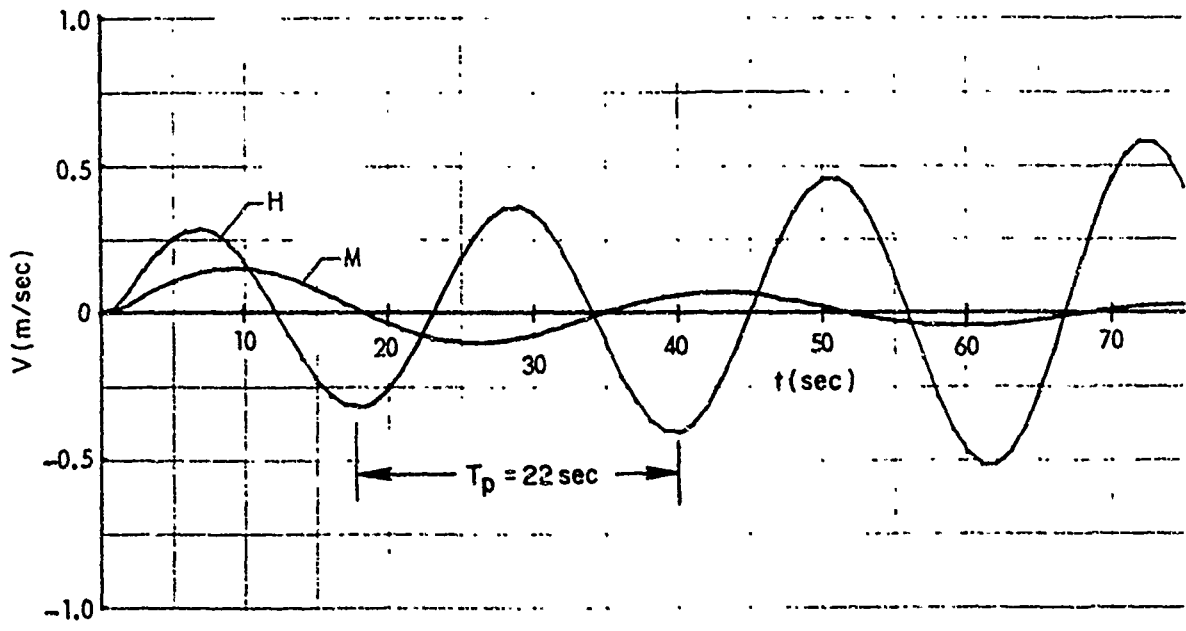

b) Pulse Response

Figure 18. Root Locus and Pulse Response for a System With Airspeed Feedback

to result in poor pilot ratings. (See discussion of Figure 11 in Section IVC.1.) Hence, we see that the requirement for positive stick force gradients could actually degrade the low frequency dynamics to the point where the net effect of augmentation would be to degrade the flying qualities. The lack of an FAR requirement on low frequency dynamics makes such a result significantly more probable. It therefore seems to be a matter of some urgency that the appropriate research be conducted to determine whether a positive stick force gradient is indeed necessary as a minimum requirement for a level of safety for aircraft utilizing rate augmentation. This research should, of course, include power-approach, and landing as major elements. However, considerations for unattended operation, such as will occur in a high workload environment and, the effect of failure transients should not be overlooked. Finally, if the stick force gradient is considered to be a means of stall protection, the effect of introducing a very large stick force vs. airspeed gradient only in the region near stall, should be considered as part of the experimental matrix.

#### **E. PASSIVE AUGMENTATION — IRREVERSIBLE FLIGHT CONTROL SYSTEMS**

The state of the art for current jet transport flight control systems may generally be described as passive augmentation (no feedback to the control surfaces). Irreversible control systems are virtually a necessity in view of the very high control forces that accompany such large aircraft. Table 2 summarizes the features for past-generation transports (DC-8, -9, Boeing 727), and modern transports (747, L-1011, DC-10, Concorde). This summary provides insight into the evolution of flight controls for Part 25 airplanes. It also serves as a starting point for investigating potential problems which might arise on RSS airplanes if the pitch control is not changed from that used on existing airplanes.

In the DC-8 and DC-9, pitch control is provided by aerodynamic boost elevator tabs, with the force feel for these reversible systems being supplied primarily by the surface hinge moments. A centering spring

TABLE 2. PITCH CONTROL SYSTEM FEATURES FOR CURRENT PART 25 AIRCRAFT

AIRCRAFT	PRIMARY FLIGHT CONTROLS	FEEL SYSTEM	TRIM SYSTEM
DC-8	2 aero boost tabs, 2 geared tabs	Load-feel and centering spring	Electrical or hydraulic stabilizer
DC-9	2 aero boost tabs, 2 geared tabs	2-rate centering spring (high gradient near neutral); M compensator in high M trim range ( $\delta F_s / \delta V$ )	Electrical stabilizer
B-727	Fully powered elevator; control tab for manual reversion (dual hydraulics)	Q diaphragm with stabilizer modulation, centering spring; reversion spring for manual	Electrical stabilizer -- parallel
B-747	4 fully powered elevator panels (quad hydraulics, dual tandem actuators). No manual reversion	Q diaphragm with stabilizer modulation, centering spring	Electrical or hydraulic stabilizer -- parallel
L-1011	All-moving tail, geared elevator (quad hydraulics). No manual reversion	Mechanical leaf springs; gain modulated by trim stabilizer and Mach No.	Stabilizer trim -- mixed parallel/series ("J-curve")
Concorde	3-segment fully powered elevons (triple hydraulics, 2 electrical and 1 mechanical signal to servos)	Unknown	Elevon trim -- parallel
DC-10	4 fully powered elevator panels (triple hydraulics). Mechanical to inboard panels.	Q diaphragm with stabilizer modulation, centering spring	Electrical or manual stabilizer -- parallel

(and for the DC-9, a Mach-compensator to improve  $\partial F_g/\partial V$  at high M) is generally the only additional feel element required. The Boeing 727 uses fully powered controls, but with only a dual hydraulic system so a manual backup is necessary. For the current large transports -- the DC-10, L-1011, B-747, Concorde -- irreversible fully powered controls with three or four hydraulic systems are used. Due to the large control forces involved, manual reversion is almost impossible so a high degree of redundancy, as well as a backup source of power in event of an all-engines-out condition, is necessary.

Artificial feel has to be provided on airplanes with fully powered controls. For the 727, 747, and DC-10 the feel system consists of a centering spring and a dynamic pressure (Q) sensing diaphragm. In the L-1011 a series of mechanical leaf springs is used. In all cases, the feel force (or gain) is varied as a function of Q (or Mach Number) and trim stabilizer setting. For a Q-feel system without stabilizer modulation, the variation in stick forces with c.g. and gross weight would be excessive. An example of such a system is shown in Figure 19 taken from Reference 28. A variable stabilizer cam, which acts as a c.g. computer, since stabilizer trim is a function of c.g., has the effect of suppressing the force increases encountered at high Q (high speed) as illustrated in Figure 20. Note that in Figures 19 and 20 the feel system inputs to the stick are only effective when sufficient force is applied by the pilot so that the control system is out of the detent. This is important because it means that the feel system does not modify the stick free dynamics of the aircraft. A review of Table 2 reveals that Figure 20 is representative of most current transports.

#### **F. EFFECT OF TURBULENCE ON AUGMENTATION SYSTEMS**

The use of stability augmentation generally improves the flying qualities of aircraft in turbulence when inertial feedback variables are employed, i.e., pitch attitude, pitch rate, roll attitude, roll rate, etc. However, when airmass referenced variables, such as angle of attack and airspeed are fed back to the aircraft control surfaces, the effect of turbulence can seriously degrade the flying qualities of the

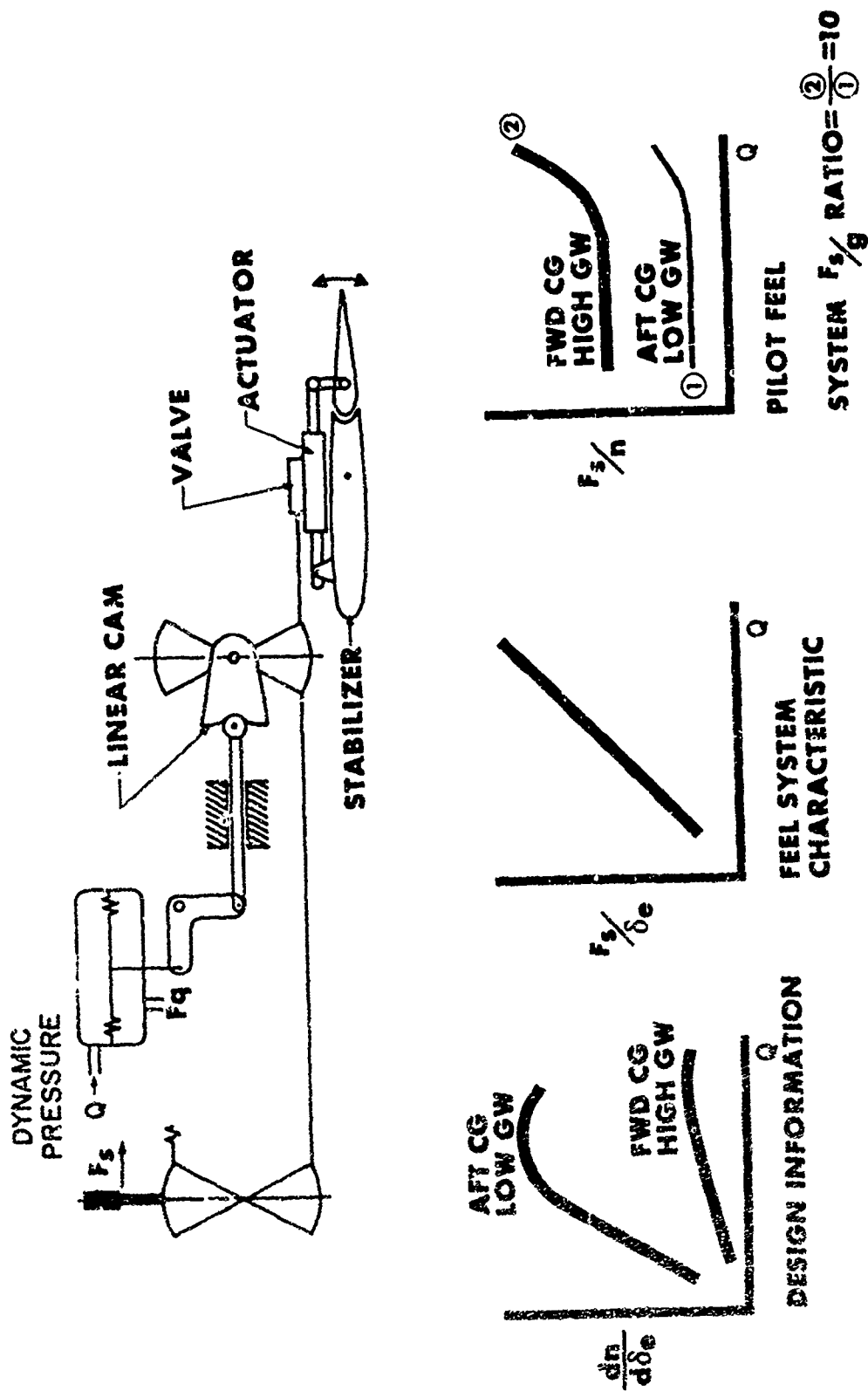

Figure 15. High Speed Airliner Response With Simple Q-Type Artificial Feel System (From Reference 28)

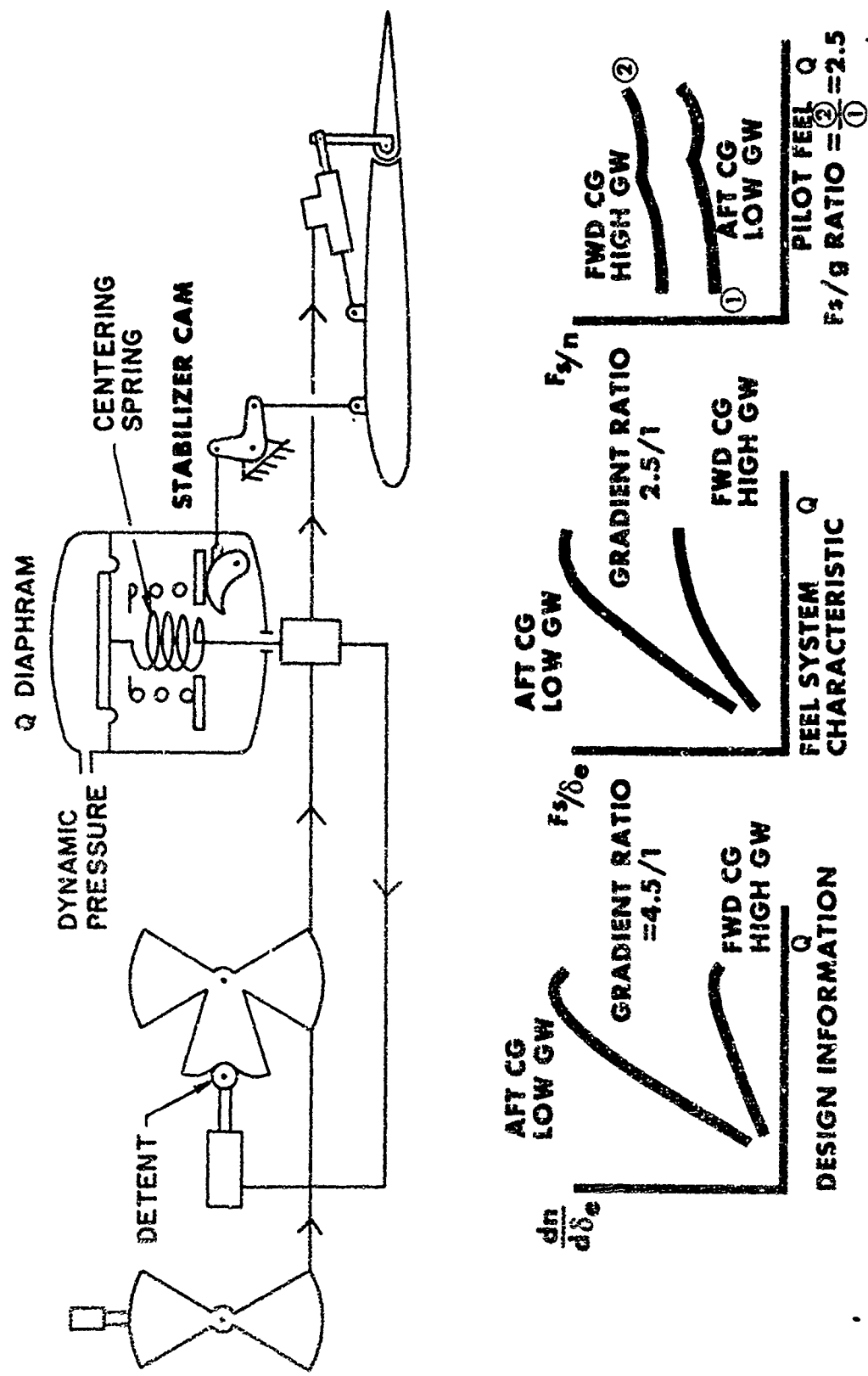

Figure 20. The 727 Feel System; and Empirical CG Computer System (From Reference 28)

aircraft. For example, a current highly augmented military fighter utilizes angle of attack feedback in the power approach flight condition. Pilots of this aircraft complain of excessive uncontrolled pitch activity in turbulence. This is not surprising since the angle of attack vane responds to gusts just as easily as to changes in aircraft angle of attack. Hence, in turbulent air, atmospheric disturbances are fed directly to the elevator; a situation which is of course very undesirable. This problem, like many others, can be overcome with complex, albeit, expensive complimentary filtering. In the case of an angle of attack vane, this would require blending normal acceleration,  $a_z$ , measured at the aircraft instantaneous center of rotation with filtered angle of attack. The details of such "complimentary filters" are not of great significance to individuals responsible for airworthiness assessment for certification of aircraft. However, the existence of the necessity for such filters should lead the airworthiness assessment test pilot to insist upon evaluation of the aircraft flying qualities in various levels of atmospheric turbulence whenever aerodynamic feedback (such as angle of attack) variables are utilized. Excessive uncontrolled aircraft responses in turbulence is indicative of a poorly designed complimentary filter or, as in the case of the fighter aircraft noted above, no complimentary filter at all. Aerodynamic feedback variables that would typically be used to augment Part 23 and Part 25 aircraft are listed below.

- Angle of attack,  $\alpha$
- Airspeed or mach number,  $V$  or  $M$
- Sideslip angle,  $\beta$
- Barometric rate of climb,  $\dot{h}$
- Barometric altitude,  $h$

If any of the above variables are utilized in the aircraft flight control system, the flying qualities of the aircraft in various levels of atmospheric disturbances should be carefully evaluated.

In cases of limited control power, atmospheric disturbances could saturate the aircraft control surface resulting in momentary loss of the augmentation system. In cases where the aircraft is highly unstable without the augmentation system, such saturation effects could lead to catastrophic divergences. Most high frequency "chop" type turbulence will not result in control surface saturation. Therefore, the FAA test pilot should insist on subjecting the aircraft to a large horizontal and vertical wind shears which would cause large low frequency control movements and are therefore the critical case when testing for saturation. Such large low frequency shears are difficult to find in flight test and should probably be examined in a piloted simulator experiment. It would seem highly desirable to include specific guidance for testing for atmospheric disturbance induced control saturation in the engineering flight test guides.



## SECTION V

### AUGMENTATION SYSTEM FAILURES

The subject of augmentation is covered by FAR 25.671 and FAR 25.1309. Additionally Advisory Circular 25.1309-XX (Reference 29) provides considerable guidance material to augment these FARs. The following definitions have been adapted from Reference 29 to provide a basis for establishing flight control system failure mode requirements for highly augmented aircraft.

- Nonessential flight control functions -- functions in the augmentation or flight control system which could not significantly degrade the capability of the airplane or the ability of the flight crew to cope with adverse operating conditions in the event of a failure.
- Essential flight control functions -- functions which would reduce the capability of the airplane or the ability of the flight crew to cope with adverse operating conditions in the event of a failure.
- Critical flight control system functions -- flight control system functions which would prevent the continued safe flight and landing of the airplane in the event of a failure.
- Continued safe flight and landing -- this phrase is used to require that an airplane be capable of continued controlled flight without exceptional pilot skill or strength after a specified failure condition.
- Probable flight control system failures -- failures which have a calculated frequency of occurrence on the order of  $10^{-3}$  or greater per hour of flight time. Probable failures may be expected during the operational life of each airplane.
- Improbable flight control system failures -- failures which have a calculated frequency of occurrence in the range from approximately  $10^{-5}$  to  $10^{-9}$  per hour of flight time. Improbable failures are not expected to occur during the total operational life of a single airplane of a particular type but are expected to occur during the total operational life of all airplanes of a particular type.

- Extremely improbable flight control system failures -- failures which are estimated to have a frequency of occurrence on the order of  $10^{-9}$  or less per hour of flight time. Such failures are extremely improbable events that are so unlikely that for the purpose of analyses, they need not be considered unless engineering judgment would require their consideration.

FAR Part 125.1309 indicates that flight control systems which have been determined to be "essential" must have a frequency of occurrence which is "improbable" (an estimated failure rate of  $10^{-5}$  to  $10^{-9}$  per flight hour). Likewise, flight control system functions considered to be "critical" must be "extremely improbable", i.e., have a frequency of occurrence on the order of  $10^{-9}$  or less per flight hour. It is clear that an augmentation system that has any appreciable effect on the aircraft dynamics will constitute at least an essential function and hence must have an estimated failure rate of less than  $10^{-5}$  per flight hour.

If the basic aircraft dynamics are so bad that a complete failure of the augmentation system would render the aircraft uncontrollable, the augmentor will become a critical function. In this case, the probability of failure must be less than  $10^{-9}$ , clearly an impractical value. Certainly it will be very important to develop guidelines on what constitutes essential and critical functions. For example, in the case of a relaxed static stability aircraft, some specific level of instability must be defined which separates "essential" from "critical".

The current state-of-the-art in flight control design would not support the development of a flight control system with an estimated failure rate as low as  $10^{-9}$ . One possible way out of this dilemma would be to design a completely independent flight control system which would provide flying qualities which meet the minimum requirements for level of safety (pilot rating equal to or better than 5) but would be somewhat less than optimum, i.e. would trade simplicity for reliability. Such an approach was utilized in the proposed Boeing Supersonic Transport (SST) wherein the backup (dissimilar) flight control system was termed a hardened SAS.

The concept of a "dissimilar" backup system infers that there is no commonalty between the backup and redundant primary channels. For example, Boeing proposed an all analog backup with simplified control laws for the SST which had a quadruply redundant digital primary flight control system.

## SECTION VI

### CONSIDERATIONS FOR MODIFYING AND UPDATING THE ENGINEERING FLIGHT TEST GUIDES

#### A. GENERAL

The Engineering Flight Test Guide for Transport Category Airplanes describes methods and procedures that have been employed in testing transport airplanes for type certification. It is based on past experience and therefore primarily oriented towards classical unaugmented aircraft. This section of the report is intended to point out specific areas of the Engineering Flight Test Guide that can be modified to allow interpretation of most of the existing Part 25 paragraphs to account for modern highly augmented aircraft. Clearly, this is an interim solution and at some point in the future the basic FAR's should be upgraded to account not only for highly augmented aircraft but the significant advances in the state of the art of flying qualities airworthiness assessment of piloted aircraft as well. Such a long term solution would probably take the form of a considerably more streamlined set of FAR's backed up by a more comprehensive Engineering Flight Test Guide. This Engineering Flight Test Guide would include not only flight test procedures but well substantiated flying qualities criteria to be used as rules of thumb to guide and interpret the flight test results.

Another reason for placing a great deal of emphasis on the Engineering Flight Test Guide will be to standardize flight test procedures among the various regions. In the following paragraphs, specific suggestions are offered as to areas of the existing flight test guide that can be modified based on existing knowledge and data.

#### B. MINIMUM REQUIREMENTS FOR "A LEVEL OF SAFETY"

While the FAR's are very specific, and the Engineering Flight Test Guide provides considerable guidance, the ultimate decision on whether an aircraft meets the minimum requirements for a level of safety lies with the FAA test pilots and engineers (and other affected certification team members). As discussed in Section II-B of this report, certain key

phrases are included in Part 25 to assist the engineering test pilots and other team members in determining what constitutes the minimum requirements for a level of safety. During the period of time between when the FARs were first written and the present, a flying qualities rating scale has been developed and refined. This scale is termed the Cooper-Harper Pilot Rating Scale after its authors and is given as Figure 1 of this report. For the purpose of determining whether or not an aircraft meets the minimum requirements for a pass/fail assessment for a level of safety, it is felt that the scale in Figure 1 could be simplified somewhat and used for guidance in the flight test guide. A simplified version of the scale which includes only aircraft characteristics and demands on the pilot is given in Figure 21. This scale is segregated into two parts. The first part being ratings from 1 to 5 which signify that the aircraft meets the minimum requirements for a level of safety. A lower half of this scale, rating 6-10 signify that the aircraft does not meet the minimum requirements for a level of safety. One objection to the use of such a scale is that it may lead to comparisons between the aircraft manufactured by different companies or may be used in product liability litigation. Such possibilities could be eliminated by not writing down the actual ratings and simply using the scale for guidance in a pass/fail fashion as noted on the right side of Figure 21.

### C. SPECIFIC RECOMMENDATIONS FOR THE FLIGHT TEST GUIDE

Specific recommendations for improvements and/or modification in certain areas of the Flight Test Guide are discussed in the following subsections.

#### 1. FAR 25.143 Controllability and Maneuverability — General

As discussed in Section IV-C1, the use of a downspring to provide static stability for an aircraft at the aft center of gravity loading can result in very high stick forces for the forward c.g. condition. Specific guidance should be included in the Engineering Flight Test Guide as to the precision required in maneuvers accomplished during a

AIRCRAFT CHARACTERISTICS	DEMANDS ON THE PILOT IN SELECTED TASK OR REQUIRED OPERATION	PILOT RATING	
Excellent Highly desirable	Pilot compensation not a factor for desired performance	1	Pass
Good Negligible deficiencies	Pilot compensation not a factor for desired performance	2	
Fair — Some mildly unpleasant deficiencies	Minimal pilot compensation required for desired performance	3	
Minor but annoying deficiencies	Desired performance requires moderate pilot compensation	4	
Moderately objectionable deficiencies	Adequate performance requires considerable pilot compensation	5	
Very objectionable but tolerable deficiencies	Adequate performance requires extensive pilot compensation	6	Fail
Major deficiencies	Adequate performance not attainable with maximum tolerable pilot compensation. Controllability not in question	7	
Major deficiencies	Considerable pilot compensation is required for control	8	
Major deficiencies	Intense pilot compensation is required to retain control	9	
Major deficiencies	Control will be lost during some portion of required operation	10	

Figure 21. Modified Cooper-Harper Scale Suggested For Pass/Fail Guidance in Engineering Flight Test Guide

high stick force condition. For example, it is very difficult, if not impossible, to accomplish a good short field landing in a gusty, turbulent environment when the stick forces are near the limit of ones strength. This problem is typically more related to Part 23 aircraft which do not have irreversible controls and rely on large downsprings to provide stability of the aft c.g. Pilots have been known to put sandbags in the baggage compartments of some of these aircraft in order to provide reasonable flight characteristics when operating with only the pilot and full fuel (forward c.g. limit).

The table of forces given in FAR, Part 25.143, seems somewhat excessive if precision tracking is required such as in a flare and landing maneuver. Furthermore, if female pilots are considered, the forces are almost certainly excessive. In the recently completed proposed MIL Standard and Handbook -- Handling Qualities of Piloted Airplanes, (Reference 6) some data on the strength of male and female pilots was compiled and is repeated below in Table 3. The requirement in FAR Part 25.143 is also shown for comparison. The numbers shown for the 5th, 50th, and 95th percentile men and women represent their maximum strength and did not include any tracking. If we compare the 75 lbs specified in the FARs for temporary applications with the numbers in Table 3 it can be seen that slightly less than 50 percent of the men and more than 95 percent of the women would not be capable of providing the required force in the aft direction (which is the most critical direction). That is only 5 percent of the women tested could pull more than 64 lb in a single application. It should be pointed out that these are maximum forces for a single application; clearly continuous operation, even for a short duration will require considerably lower forces. A rule of thumb given in the proposed MIL Handbook recommends that the maximum control force should be half the operator's greatest strength. Clearly, more data is required in this area. However, considerations such as the ones discussed above with special emphasis on performing the required operational task (such as short-field landings) should be included in the FAA Engineering Flight Test Guide. If, in the

TABLE 3. MAXIMUM FORCES EXERTED ON AIRCRAFT CONTROL STICK (LBS) BY MEN AND WOMEN

CONTROL STICK DIRECTION	MEN			WOMEN			FAR 25.143 (TEMPORARY APPLICATION)
	PERCENTILE			PERCENTILE			
	5th	50th	95th	5th	50th	95th	
Stick Forward (Push)	93	123	165	46	87	109	75
Stick Back (Pull)	64	85	106	48	52	64	

judgment of the engineering test pilot and other assessment team members, certain operational tasks cannot be done without the use of undue strength (or alternatively with a pilot rating of 5 or better in the Figure 21 scale) then the manufacturer should be required to either reduce the forces or limit the aircraft to less demanding tasks when the forces are excessively high (such as would occur at the forward c.g. location).

**2. FAR 25.145 Longitudinal Control and FAR 25.147 Directional and Lateral Control**

These paragraphs are quite comprehensive and no specific recommendations are made for change at this time.

**3. The FAR 25.161 Trim (Reserved)**

This FAR could be construed as a requirement for absolute stability in all axes. It is extremely important that this interpretation not be made inasmuch as trim is a totally separate issue from stability. The wording of the FARs is that the aircraft must "maintain trim" in all axes. Before the advent of stability augmentation, it was clear to many test pilots that most aircraft are spirally unstable and hence cannot



"maintain trim" in the lateral axes indefinitely. Hence, the appropriate interpretation was made in order to conform with common sense and good judgment. However, with the advent of stability augmentation, stabilization of the spiral mode is indeed possible. It follows that a strict interpretation of this requirement could, in fact, force the manufacturer to stabilize the spiral mode even though such augmentation could detract from the overall flying qualities of the aircraft. Hence, it should be made clear that the trim requirements of this paragraph are intended to provide control force relief and that long term stability is a subject of other sections in the FARs.

The issue of series vs. parallel trim should be addressed in the Engineering Flight Test Guide. Experience has shown that pilots find series trim to be undesirable. This is discussed in some detail in Reference 14. The undesirable aspects of series trim should be discussed to alert the FAA test pilot of a potential problem area. It is a significant issue with highly augmented aircraft because series trimmers are easy to mechanize with a full authority augmentation system. Specifically, series trim means that the control column can have zero force only in the neutral position. So, for example, if the pilot in slowing the airplane down finds himself carrying two to three inches of aft control deflection and several pounds of control force, the task of trimming off the force would also involve recentering the control column. Such recentering tends to induce pitch bobbling and hence results in adverse pilot opinion. Automatic trim followups are also very undesirable and tend to be a by-product of stability augmentors. Such trim systems automatically recenter the control column when the limit of a limited authority series servo is being approached. The result is that the pilot finds that the control column sometimes "has a mind of its own" and simply starts to change position without any apparent command. It is not difficult to imagine that such a situation is rated poorly by most pilots. An outline of these various trim systems associated with highly augmented aircraft should be included in the flight test guide so that the engineering test pilot is not only aware of how they are mechanized, but also has the benefit of the experience of pilots in other experiments..

#### 4. FAR 25.171 Stability — General (Reserved)

This paragraph clearly states a requirement for absolute stability in all axes, despite the fact that nearly all airplanes are spirally unstable. This is clearly a matter of interpretation which must be made by the appropriate regions in the current FAA structure. Specific interpretations of the amount of stability required in each axes should be included in this section of the Engineering Flight Test Guide to provide standardization among the regions. In the past, attempts to provide a specific requirement on acceptable lateral divergence rates for the spiral mode were overruled because of a lack of substantiating data. However, inclusion of such requirements as "guidance" does not require the rigorous substantiation of a regulation and still allows the use of such existing data in the certification process.

The requirement for absolute stability in this paragraph essentially disallows the use of pure rate augmentation for relaxed static stability aircraft (see Section IV-D). However, such augmentation can be highly effective and the degree of instability can be so small as to be unnoticeable, i.e. considerably less than the spiral divergence existing on current aircraft. Specific guidance should be provided in this area to evaluate the expected requests for deviation from this requirement for RSS aircraft.

Finally, the effect of failure modes on stability should be considered to assist the FAA test pilot in making determinations on specifically what constitutes "nonessential," "essential," and "critical" flight control functions.

#### 5. FAR 25.173 Static Longitudinal Stability (Reserved) FAR 25.175 Demonstration of Static Longitudinal Stability (Reserved)

Both of these requirements are reasonably self explanatory and little guidance is required. The entire issue of the requirement for the necessity for positive static stability for some types of augmentation has been discussed at some length in Chapter IV-D of this volume

and in Volume II of this report. The concept of allowing a reduction in static stability in the presence of very excellent dynamic response characteristics should be considered as a major part of the effort to expand the Engineering Flight Test Guide to account for highly augmented aircraft.

The value of stick force gradient required for desirable flying qualities should be made a function of flight condition. For example, in the power approach and landing flight condition, it is desirable to have a reasonably high value of stick force gradient to provide a sense of airspeed awareness when operating near the stall. However, in high speed cruise conditions, the need for a stick force gradient diminishes rapidly and in fact, as pointed out in Section III, Equation 7, the value of stick force gradient varies inversely with the trim speed. Hence, at very high speeds, the stick force gradient will be inherently very small. Allowances should be made for this fact in the Engineering Flight Test Guide.

Values of stick force gradient, which are excessively large, can lead to degraded flying qualities to the point where safety is a factor. This tends to be a problem more with Part 23 aircraft which employ a large downsprung to cure stick-free stability problems at the aft c.g. limit. The presence of this very large spring causes excessively high stick force gradients when operating at the forward c.g. limit. It would be desirable to establish a recommended upper limit on stick force gradient to prevent excessive maneuvering forces and gust sensitivity. If this upper limit is exceeded, the test pilot should be alerted to a potential safety problem. Aircraft with such "deficiencies" should be subjected to a special set of flight tests to demonstrate the ability to do precision maneuvering without exceeding the requirements for exceptional piloting skill, alertness, or strength (or alternatively a pilot rating of 5 or better on the scale in Figure 21). In most cases, this would involve demonstrated short field takeoffs and landings in moderate turbulence.

## 6. FAR 25.177 Static Directional and Lateral Stability

The flight test procedures outlined in the current Engineering Flight Test Guide for directional static stability are reasonable, but not very meaningful in terms of flying qualities. In order to make these tests more meaningful, some minimum and maximum force gradients should be specified. That is, in its present form, the flight test procedure requires only that the aircraft ultimately return to its trim value with no recommended limits on the control forces.

The lateral "stability" requirement is actually a requirement on dihedral effect (the requirement is intended to insure that the effective  $L_{\beta}$  is negative). There are really two issues that need to be addressed here. One is the need for an actual lateral stability requirement, which is a requirement on the spiral mode. The other is whether or not a negative dihedral effect should indeed be required.

Lateral or "spiral" stability is nearly always slightly negative and therefore is more of a dynamic requirement than a static requirement. That is, once an aircraft is perturbed from wings level flight, it tends to either stay at the bank angle where control release was effected or to slowly diverge. Hence the requirement on "lateral stability" should be included in a new paragraph oriented towards long term dynamic stability (see also discussion on 25.181).

There is a considerable body of data which shows that aircraft with zero effective dihedral do not pose any substantial flying quality problems and in fact, have been known to receive pilot ratings equal to or better than 3 on the Cooper-Harper rating scale in Figure 1; certainly well within the minimum requirements for a level of safety. A reasonable short term solution to this problem would be to present this data to the FAA engineering test pilots in the Engineering Flight Test Guide so that they may make the proper interpretation of this requirement, i.e., very low values of effective dihedral should be considered as acceptable. This would constitute a major improvement in the FARs in that many aircraft are outfitted with aileron to rudder spring interconnects in order to meet the requirements for effective dihedral or

"lateral stability" when  $L_{\beta}$  is marginally small, but not zero. These spring interconnects make the crosswind landing and takeoff characteristics of the aircraft somewhat undesirable and most likely constitute more of a safety hazard than the small or zero effective dihedral; which the data shows constitutes no safety hazard at all.

Finally, some specific flight test procedures should be developed to evaluate directional stability and dihedral effect in terms of operational requirements. For example, static directional stability should be evaluated in landing in large lateral gusts and at the maximum crosswind limit of the aircraft where rapid directional changes with rudder may be required on short final and just prior to touchdown. Likewise, the effective dihedral can be evaluated by examining the operational procedures to determine if there is a need to raise the low wing with rudder and more importantly, by investigating the effects of turbulence. Aircraft with very low values of dihedral tend to exhibit a snaking motion in turbulence and hence dutch roll damping becomes more important. However, meeting the requirements of Paragraph 177 as outlined in the Engineering Flight Test Guide will not improve turbulence response due to low effective dihedral. In fact, most manufacturers meet this requirement by incorporating an aileron to rudder interconnect which has no effect on augmenting  $L_{\beta}$ , the primary culprit in poor turbulence response. In summary, it seems worthwhile to establish a rigorous set of flight test procedures that would effectively evaluate directional stability and dihedral effect (or incorrectly "lateral stability") in terms of the actual operational requirements of the aircraft. This approach could eliminate the need for a large scale revision of the FARs which is unlikely in the near future and would also have the effect of standardizing the evaluation of these important flying quality considerations.

#### **7. FAR 25.181 Dynamic Longitudinal, Directional, and Lateral Stability**

As discussed in both volumes of this report, the dynamic response of highly augmented aircraft can be substantially different from classical

aircraft. Furthermore, the classical relationships between static and dynamic stability are typically no longer valid when significant amounts of augmentation are employed. Hence, there is a need for a very comprehensive methodology for making the distinction between what is and what is not the minimum requirement for an "acceptable" dynamic response characteristic in each axis. "Acceptable" here, would of course imply that the minimum requirements for a level of safety have been satisfied, i.e., a rating of 5 or better (a "pass") on the Figure 21 scale.. Clearly, simply stating that the responses must be well damped is not adequate. Fortunately, there has been a considerable body of research directed at this subject during the past decade. A great deal of this research is summarized in the proposed Mil Standard and Handbook for Flying Qualities of Piloted Airplanes (Reference 6). We hasten to note that the military mission is considerably different from that of the civil transport and hence the military flying quality criteria do not apply directly. However, a significant segment of the military data base involves a human pilot flying large aircraft with flying qualities very similar to the civil fleet (in many cases, identical aircraft). The proposed expansion of the Engineering Flight Test Guide would involve utilization of this data base in terms of the needs of the civil transport and its associated operational envelope. The flying quality criteria derived from this effort would be included in the Engineering Flight Test Guide as background material and would support the engineering test pilot in looking for critical areas that could cause safety related problems. For example, an aircraft with a large time delay (see Section II) should be subjected to aggressive tracking tasks such as precision landings to determine whether the time delay can result in unsafe operation. The Space Shuttle represents an example of a case where large time delays did result in near catastrophic results. This "aircraft" is extremely benign as long as gradual control inputs are made. However, as two separate astronauts have discovered, an attempt to make rapid corrections in the vicinity of touchdown can result in very large and potentially dangerous pilot induced oscillations. The main point of all this is that the flying quality criteria should not be necessarily utilized to modify existing FARs, but rather to guide the

flight test program to search out and examine regions where subtle but potentially dangerous problems may exist.

It is expected that a large portion of the effort to expand the Engineering Flight Test Guide would be expended on upgrading this paragraph. In summary, specific areas that should be addressed are

- Specific requirements on highly augmented pitch dynamics with emphasis on the fact that the conventional short period and phugoid modes may not be readily identifiable. This requires that a technique called "equivalent system matching" be utilized to identify the "effective" short-period parameters. (See Reference 6, Section 3.2.1.1.)
- Specification of criteria to define roll damping and spiral stability. In particular, roll damping tends to be critical for large transport aircraft and defines the dominant short-term dynamics in the roll axes. A specific flight test technique should be outlined to expose deficiencies in the roll mode time constant. Examples would be lateral offset maneuvers just prior to touchdown and landings in a crosswind shear.
- Values of dutch roll damping and frequency should be specified depending on the task in question. For example, it may be necessary to require higher values of dutch roll damping for ILS tracking than for high altitude cruise.
- Specific recommendations should be made on the allowable degradations that can occur in the presence of stability augmentation failures. In addition, the transient between the unfailed and failed state should also be investigated.

#### 8. FAR 25.671 and FAP 25.1309 Consideration of Augmentation System Failures

Inasmuch as the basic philosophy of the Federal Aviation Regulations is to require only the minimum flying qualities necessary to achieve "safe flight," degradations in the flying quality characteristics technically cannot be allowed. If such degradations were allowed to exist, the operation would, by definition, be unsafe; an unacceptable situation for commercial operation. In the real world situation, however, aircraft are designed to have considerably better flying qualities than those needed for minimum requirements for a level of safety. Hence, the flying qualities of an aircraft following failures of one or more

augmentation systems are inherently required to meet the basic regulations. Indeed, in the case of augmented aircraft, the regulations may be more oriented toward the failed state than the operational state. The Engineering Flight Test Guide should provide guidance for flight test pilots regarding "critical" failures of specific augmentation systems (see Section V for definition of "critical"). An important part of defining a "critical" failure is defining the worst-case critical operating points for failures. Advisory Circular 25.1309-XX (Reference 29) clearly states that continued safe flight and landing implies that an airplane be capable of continued controlled flight without exceptional pilot skill or strength after any failure condition which has not been shown to be "extremely improbable" (a probability of less than  $10^{-9}$ ). Most failures of an augmentation system cannot be shown to be extremely improbable and therefore it will be necessary to conduct flight demonstrations either in an airplane or on a satisfactory flight simulator of the worst-case failure conditions. It should be the role of the Engineering Flight Test Guide to define what constitutes the worst-case flight conditions and additionally what constitutes a satisfactory flight simulator for each of the identified flight conditions. Failure transients should be an important consideration when conducting such tests.



## CONCLUSIONS

The current Federal Aviation Regulation concerning aircraft flying qualities can nearly always be applied to the airworthiness assessment and certification of highly augmented aircraft with the appropriate interpretations. It is suggested that such interpretations be incorporated into the airworthiness assessment process by means of an updated version of the Engineering Flight Test Guides (FAA Orders 8110.7 and 8110.8). This would serve to provide a basis for standardizing procedures among the regions. It would also provide FAA engineering test pilots and certification teams with a synopsis of the latest available information obtained from Military, NASA and European flight test and piloted simulation programs. Such information will be essential in performing an efficient assessment of a highly augmented aircraft.

Some specific areas to be considered for upgrading the engineering flight test guide are summarized below.

- A standardized rating scale is needed to assist in the airworthiness assessment process. It is felt that a modified version of the Cooper-Harper Handling Qualities rating scale would be appropriate and that a rating of 5 or better should result in a "pass" (see Figures 1a and 21).
- The Engineering Flight Test Guide should recommend specific piloting tasks which would be particularly effective in exposing flying qualities deficiencies which may exist as a result of the mechanization of stability augmentation or failures of such augmentation (see Section II).
- There is a simultaneous degradation in static and dynamic stability which occurs as the center of gravity is moved aft with classical unaugmented aircraft. Hence, a detailed requirement on static stability inherently assures reasonable dynamic stability (see Sections III B.3 and IV D.3).

- Highly augmented aircraft may exhibit zero static stability and still possess excellent dynamic stability. Hence, the detailed requirements on static stability are not adequate to assure good dynamic stability for augmented aircraft (see Section IV D.3).
- The Engineering Flight Test Guide should contain guidelines to allow an airworthiness assessment of the short term dynamic stability of augmented aircraft. Such guidelines would be considered interpretations of the very general requirements on short-term dynamic stability in FAR 25.181 (see Section IV C.1).
- A requirement on low frequency (or "long term") dynamic stability does not currently exist in the FARs. This situation should be rectified (see Section IV C.1).
- The necessity for requiring a negative stick force per knot gradient ( $dF_s/dV$ ), even in the presence of excellent dynamic characteristics, should be investigated.
- The requirement for a negative  $dF_s/dV$  (FAR 25.173) disallows the use of rate command attitude augmentors thereby complicating the problem of augmenting RSS aircraft. Test pilots at NASA Ames Research Center have found rate command augmentors (with  $dF_s/dV$ ) to be not only acceptable but desirable. See Section V D.4 for more detail.
- Downsprings, bobweights, and elevator tabs can be used effectively to correct deficient static stability which tends to occur at aft center of gravity locations. However, the Engineering Flight Test Guide should provide specific guidance regarding: 1) the control forces at the extreme forward center of gravity and 2) long term dynamic stability (phugoid mode) when such devices are employed.
- Specific guidance should be provided in the Engineering Flight Test Guide regarding the possible deleterious effects of turbulence on stability augmentation systems (see Section IV F).

- The Engineering Flight Test Guide should provide guidance as to specifically what constitutes "nonessential, essential, and critical" flight control functions (see Section V). For example, how unstable must an RSS aircraft be before the flight control system (augmentation) is deemed to be "essential" or "critical?" Note that the reliability requirements, and hence cost, are a direct result of whether the control system is found to be nonessential, essential, or critical.

A detailed review of suggested modifications to the Engineering Flight Test Guide is given in Section VI.

## REFERENCES

1. Engineering Flight Test Guide for Transport Category Airplanes, Federal Aviation Admin., Order No. 8110.8, Sept. 1974.
2. "Selected Advanced Aerodynamics and Active Controls Technology Concept Development," in Fourth Annual Review Boeing D6-481677, Oct. 1980.
3. Development and Flight Evaluation of an Augmented Stability Active Controls Concept with a Small Tail, NASA1-15326, Oct. 1980.
4. Selected Advanced Aerodynamics and Active Controls Concepts for Commercial Transport Aircraft, NASA1-15327, Sept. 1981.
5. Flying Qualities of Piloted Airplanes, MIL-F-8785C, Nov. 1980.
6. Hoh, R. H., D. G. Mitchell, I. L. Ashkenas, R. H. Klein, R. K. Heffley, and J. Hodgkinson (MDAC), Proposed MIL Standard and Handbook -- Flying Qualities of Piloted Airplanes. Vol. II: Proposed MIL Handbook, AFWAL-TR-82-3081.
7. Cooper, G. E., and R. P. Harper, Jr., The Use of Pilot Rating in the Evaluation of Aircraft Handling Qualities, NASA TN D-5153, Apr. 1969.
8. McDonnell, J. D., Pilot Rating Techniques for the Estimation and Evaluation of Handling Qualities, AFFDL TR-68-76, Dec. 1968.
9. Hoh, R. H., S. J. Craig, and I. L. Ashkenas, Identification of Minimum Acceptable Characteristics for Manual STOL Flight Path Control. Vol. III: Detailed Analyses and Tested Vehicle Characteristics, FAA-RD-75-123, III, June 1976.
10. Perkins, C. D., and R. E. Hage, Airplane Performance Stability and Control, John Wiley & Sons, Inc., New York, 1949.
11. Airworthiness Standards: Transport Category Airplanes, FAR Part 25, June 1974.
12. Blakelock, J. H., Automatic Control of Aircraft and Missiles, John Wiley and Sons, Inc., New York, 1965.
13. McRuer, D., I. Ashkenas, and D. Graham, Aircraft Dynamics and Automatic Control, Princeton University Press, Princeton, N.J., 1973.
14. McRuer, D. T., and D. E. Johnston, Flight Control Systems Properties and Problems, Vol. I, NASA CR-2500, Feb. 1975.

15. Aviation Consumer, Vol. XI, No. 21, Nov. 1981.
16. Chalk, C. R., T. P. Neal, T. M. Harris, F. E. Pritchard, and R. J. Woodcock, Background Information and User Guide for MIL-F-8785B(ASG), "Military Specification - Flying Qualities of Piloted Airplanes", AFFDL-TR-69-72, Aug. 1969.
17. Hoh, R. H., and I. L. Ashkenas, Development of VTOL Flying Qualities Criteria for Low Speed and Hover, NADC-77052-30, Dec. 1979.
18. Hoh, R. H., and W. F. Jewell, Investigation of the Vulnerability of Powered Lift STOL's to Wind Shear, NASA CR-152064, Oct. 1976.
19. Franklin, J. A., R. C. Innis, G. H. Hardy, and J. D. Stephenson, Design Criteria for Flightpath and Airspeed Control for the Approach and Landing of STOL Aircraft, NASA TP 1911, Mar. 1982.
20. Mooij, H. A., Handling Quality Criteria Development for Transport Aircraft with Fly-By-Wire Primary Flight Control Systems, NLR TR 74141U, Aug. 1976.
21. Mooij, H. A., and M. F. C. van Gool, The Need for Stick Force Stability for Attitude Stabilized Aircraft, Part I, NLR TR 76125U, Mar. 1976.
22. Mooij, H. A., and M. F. C. van Gool, The Need of Stick Force Stability for Attitude Stabilized Aircraft, Part II, NLR TR 77027U, 1977.
23. Mooij, H. A., and M. F. C. van Gool, "Flight Test of a Stick Force Stability and Attitude Stabilized Aircraft,": AIAA J. Aircraft, Vol. 15, No. 9, Sept. 1978, pp. 562.
24. Mooij, D., and M. F. C. van Gool, Determination of Low Speed Longitudinal Maneuvering Criteria for Transport Aircraft from Advanced Flight Control Systems, NLR TR 79127U, 1979.
25. Mooij, D., and M. F. C. van Gool, "Handling Qualities of Transports with Advanced Flight Control Systems," paper presented at Aerodynamic Flight Mechanics Symposium on Criteria for Handling Qualities of Modern Aircraft, Ft. Worth, TX, Apr. 1982.
26. Weingarten, N. C., and C. R. Chalk, In-Flight Investigation of Large Airplane Flying Qualities for Approach and Landing, Calspan Report No. 6645-F-5, July 1981.
27. SAE Aerospace Recommended Practice, ARP842B, Revised 11/30/70, "Design Objectives for Flying Qualities of Civil Transport Aircraft".

28. Harris, P., "Some Aspects of the 727 Flight Control System,"  
Society of Automotive Engineers Committee A-18, July 1964.
29. Airplane System Design Analysis, Department of Transportation,  
AC 25.1309-XX.

## GLOSSARY

c.g. Center of gravity  
FAA Federal Aviation Agency  
FAR Federal Aviation Regulations  
FCS Flight Control System  
RSS Relaxed Static Stability  
SST Supersonic Transport