National
Hockey
League



**Official
Rules**

2007-2008

© Copyright 2007 National Hockey League

All rights reserved. This book may not be reproduced in whole or in part in any form or by any means, electronic or mechanical, including photocopying, recording, or by any information storage and retrieval system now known or hereafter invented, without written permission from the National Hockey League.

National Hockey League Official Rules 2007-2008

NHL and the NHL Shield are registered trademarks of the National Hockey League. All NHL logos and marks and team logos and marks depicted herein are the property of the NHL and the respective teams and may not be reproduced without the prior written consent of NHL Enterprises L.P. © NHL 2007. All rights reserved.

Diagrams of equipment and officials' signals reproduced courtesy of USA Hockey, Inc.

Printed in Canada.

Design, production by:
Dan Diamond and Associates, Inc.
194 Dovercourt Road
Toronto, Ontario M6J 3C8 416-531-6535 Fax 416-531-3939

Distributed in Canada by:
www.nhlofficialguide.com

Published in the United States of America by:
Triumph Books
542 South Dearborn Street, Suite 750
Chicago, Illinois 60605 312-939-3330 Fax 312-663-3557

ISBN: 978-1-894801-12-6

The National Hockey League
1185 Avenue of the Americas, New York, New York 10036
1800 McGill College Avenue, Suite 2600, Montreal, Quebec H3A 3J6
50 Bay Street, 11th Floor, Toronto, Ontario M5J 2X8

www.NHL.com

2007-2008 NHL OFFICIATING TEAM

<u>Jersey</u> No.	<u>REFEREES</u> Name	<u>Jersey</u> No.	<u>LINESMEN</u> Name
2	Fraser, Kerry	47	Schachte, Dan
3	Leggo, Mike	54	Devorski, Greg
4	McCauley, Wes	55	Heyer, Shane
5	Rooney, Chris	56	Wheler, Mark
6	Marouelli, Dan	57	Sharrers, Jay
7	McCreary, Bill	59	Barton, Steve
8	Jackson, Dave	60	Dapuzzo, Pat
10	Devorski, Paul	61	Seitz, Lyle
11	Sutherland, Kelly	65	Racicot, Pierre
12	Koharski, Don	66	Gibbs, Darren
13	O'Halloran, Dan	67	Champoux, Pierre
14	LaRue, Dennis	68	Driscoll, Scott
15	Auger, Stephane	70	Nansen, Derek
16	Shick, Rob	71	Kovachik, Brad
18	Kimmerly, Greg	73	Rody, Vaughan
19	McGeough, Mick	74	Cameron, Lonnie
20	Peel, Tim	75	Amell, Derek
21	Van Massenhoven, Don	76	Cormier, Michel
23	Watson, Brad	77	Nowak, Tim
25	Joannette, Marc	78	Mach, Brian
26	Martell, Rob	79	Pare, Mark
27	Furlatt, Eric	80	Nelson, Thor
28	Lee, Chris	82	Galloway, Ryan
29	Walsh, Ian	84	Sericolo, Anthony
30	Hasenfratz, Mike	86	Lazarowich, Brad
32	Kowal, Tom	88	Cvik, Mike
33	Pollock, Kevin	89	Miller, Steve
34	Meier, Brad	90	McElman, Andy
35	Warren, Dean	91	Henderson, Don
39	Dwyer, Gord	92	Shewchyk, Mark
40	Kozari, Steve	93	Murphy, Brian
42	O'Rourke, Dan	95	Murray, Jonny
45	St. Pierre, Justin	96	Brisebois, David
		97	Morin, Jean
	Minor League Team Members		Minor League Team Members
36	Morton, Dean	50	Cherrey, Scott
37	Rehman, Kyle		
38	St-Laurent, Francois		
41	Ciamaga, Chris		
43	Pochmara, Brian		
44	Banfield, David		
48	L'Ecuyer, Frederick		



RINK DIAGRAM, GOAL CREASE

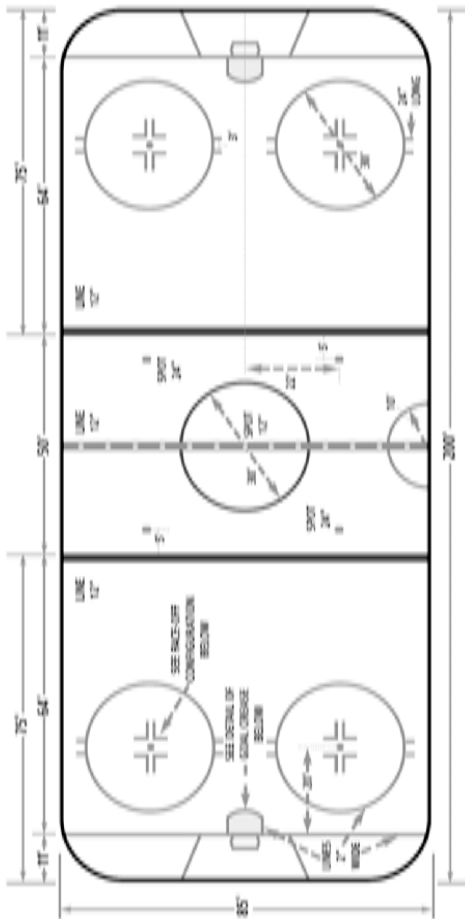

OFFICIAL DIMENSIONS OF RINK SURFACE

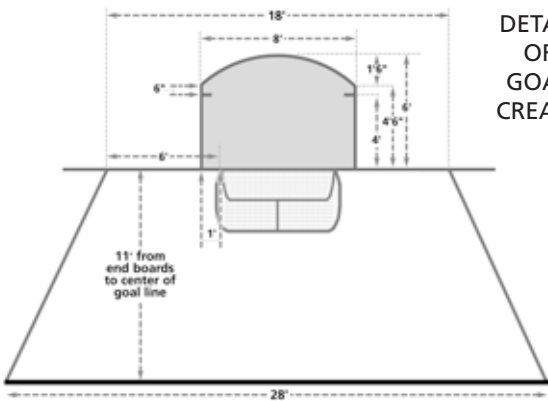

DETAIL OF GOAL CREASE

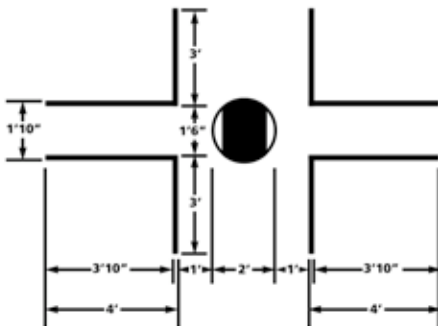

ALL LINES ARE 2" IN WIDTH

FACE-OFF CONFIGURATION

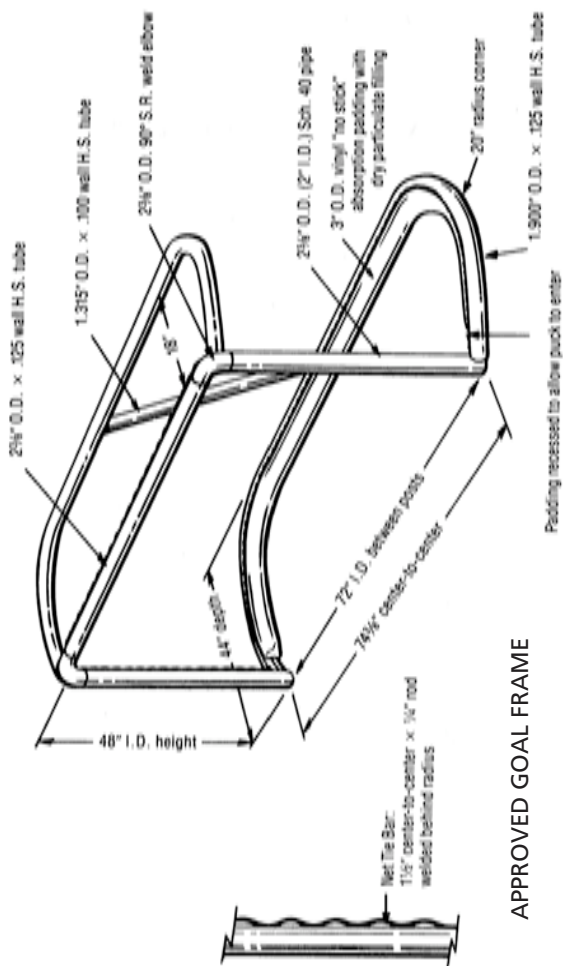

APPROVED GOAL FRAME

Table of Contents	vii
Section 1 – Playing Area.....	1
Section 2 – Teams	6
Section 3 – Equipment.....	11
Section 4 – Types of Penalties.....	23
Section 5 – Officials	45
Section 6 – Physical Fouls	63
Section 7 – Restraining Fouls	77
Section 8 – Stick Fouls	83
Section 9 – Other Fouls	86
Section 10 – Game Flow	106
Reference Tables.....	129
Index	168
2007-2008 NHL Schedule.....	217

Rule changes are highlighted.

Section 1 – Playing Area

Rule 1 – Rink	1
Rule 2 – Goal Posts and Nets.....	3
Rule 3 – Benches.....	4
Rule 4 – Signal and Timing Devices.....	4

Section 2 – Teams

Rule 5 – Team	6
Rule 6 – Captain and Alternate Captains.....	7
Rule 7 – Starting Line-up	8
Rule 8 – Injured Players.....	9

Section 3 – Equipment

Rule 9 – Uniforms	11
Rule 10 – Sticks	13
Rule 11 – Goalkeeper’s Equipment	18
Rule 12 – Illegal Equipment.....	21
Rule 13 – Puck.....	22
Rule 14 – Adjustment to Clothing or Equipment.....	22

Section 4 – Types of Penalties

Rule 15 – Calling of Penalties.....	23
Rule 16 – Minor Penalties.....	24
Rule 17 – Bench Minor Penalties.....	25
Rule 18 – Double-minor Penalties	25
Rule 19 – Coincidental Penalties.....	25
Rule 20 – Major Penalties.....	27
Rule 21 – Match Penalties	29
Rule 22 – Misconduct Penalties.....	29
Rule 23 – Game Misconduct Penalties.....	30
Rule 24 – (Not in use).....	32
Rule 25 – Penalty Shot	33
Rule 26 – Awarded Goals.....	36
Rule 27 – Delayed Penalties.....	37
Rule 28 – Goalkeeper’s Penalties.....	37
Rule 29 – Supplementary Discipline.....	39
Rule 30 – Signals.....	40

Section 5 – Officials

Rule 31 – Appointment of Officials.....	45
Rule 32 – Referees	45
Rule 33 – Linesmen	47
Rule 34 – Official Scorer.....	49
Rule 35 – Game Timekeeper.....	51
Rule 36 – Penalty Timekeeper.....	52
Rule 37 – Goal Judge	54
Rule 38 – Real Time Scorers.....	54

**Section 5 – Officials (continued)**

Rule 39 – Video Goal Judge	55
Rule 40 – Abuse of Officials	57
Rule 41 – Physical Abuse of Officials	60

Section 6 – Physical Fouls

Rule 42 – Boarding	63
Rule 43 – Charging	64
Rule 44 - Checking from Behind	64
Rule 45 – Clipping	65
Rule 46 – Elbowing	66
Rule 47 – Fighting	66
Rule 48 - Head-butting	72
Rule 49 – Kicking	72
Rule 50 – Kneeing	73
Rule 51 – Roughing	73
Rule 52 - Slew-footing	74
Rule 53 - Throwing Equipment	74

Section 7 – Restraining Fouls

Rule 54 – Holding	77
Rule 55 – Hooking	77
Rule 56 – Interference	78
Rule 57 – Tripping	80

Section 8 – Stick Fouls

Rule 58 – Butt-ending	83
Rule 59 – Cross-checking	83
Rule 60 – High-sticking	83
Rule 55 – Hooking	(77) 84
Rule 61 – Slashing	84
Rule 62 – Spearing	85

Section 9 – Other Fouls

Rule 63 – Delaying the Game	86
Rule 64 – Diving / Embellishment	89
Rule 65 – Equipment	89
Rule 66 - Forfeit of Game	90
Rule 67 – Handling Puck	90
Rule 68 – Illegal Substitution	92
Rule 69 – Interference on the Goalkeeper	93
Rule 70 – Leaving the Bench	95
Rule 71 – Premature Substitution	99
Rule 72 – Refusing to Play the Puck	100
Rule 73 – Refusing to Start Play	100
Rule 74 – Too Many Men on the Ice	102
Rule 75 - Unsportsmanlike Conduct	103



Section 10 – Game Flow

Rule 76 – Face-offs.....	106
Rule 77 – Game and Intermission Timing.....	111
Rule 78 – Goals	111
Rule 79 – Hand Pass	114
Rule 80 – High-sticking the Puck.....	114
Rule 81 – Icing	115
Rule 82 – Line Changes	118
Rule 83 – Off-side	120
Rule 84 – Overtime	122
Rule 85 – Puck Out of Bounds.....	125
Rule 86 – Start of Game and Periods.....	126
Rule 87 – Time-outs.....	128

Reference Tables

Table 1	
Summary of Penalties to Coaches and Non-playing Club Personnel	129
Table 2	
Summary of Minor Penalties.....	130
Table 3	
Summary of Bench Minor Penalties.....	131
Table 4	
Summary of Double-minor Penalties	132
Table 5	
Summary of Major Penalties.....	132
Table 6	
Summary of Major Penalties That Result in an Automatic Game Misconduct	133
Table 7	
Summary of Major Penalties That Result in an Automatic Game Misconduct When There is Injury to the Face or Head	133
Table 8	
Summary of Match Penalties	134
Table 9	
Summary of Misconduct Penalties.....	135
Table 10	
Summary of Game Misconduct Fouls Included in the “General Category”	136
Table 11	
Summary of Game Misconduct Fouls Included in the “Stick-Related Category”	137
Table 12	
Summary of Game Misconduct Penalties.....	138
Table 13	
Summary of Penalty Shots	139

**Reference Tables (continued)**

Table 14	
Summary of Awarded Goals (When Goalkeeper Has Been Removed for an Extra Attacker)	140
Table 15	
Summary of Goalkeeper Penalties.....	141
Table 16	
Goals Scored Against a Short-handed Team.....	142
Table 17	
Coincidental Penalties	154
Table 18	
Interference on the Goalkeeper Situations.....	158
Table 19	
Penalties in Effect Prior to the Start of Overtime – Regular Season	165
Table 20	
Penalties Assessed in Overtime – Regular Season	167
Index	168
2007-2008 NHL Schedule	217

SECTION 1 – PLAYING AREA

Rule 1 – Rink

- 1.1 **Rink** - National Hockey League games shall be played on an ice surface known as the "Rink" and must adhere to the dimensions and specifications prescribed by the League and these rules. No ice markings shall be permitted except those provided for under these rules unless express written permission has been obtained from the League. On-ice logos must not interfere with any official ice markings provided for the proper playing of the game.

In the interval between periods, the ice surface shall be flooded unless mutually agreed to the contrary.

- 1.2 **Dimensions** - The official size of the rink shall be two hundred feet (200') long and eighty-five feet (85') wide. The corners shall be rounded in the arc of a circle with a radius of twenty-eight feet (28'). See diagram on page iv preceding the table of contents.
- 1.3 **Boards and Glass** - The rink shall be surrounded by a wall known as the "boards" which shall extend not less than forty inches (40") and not more than forty-eight inches (48") above the level of the ice surface. The ideal height of the boards above the ice surface shall be forty-two inches (42"). Except for the official markings provided for in these rules, the entire playing surface and the boards shall be white in color except the kick plate at the bottom of the boards, which shall be light yellow in color.

Any variations from any of the foregoing dimensions shall require official authorization by the League.

The boards shall be constructed in such a manner that the surface facing the ice shall be smooth and free of any obstruction or any object that could cause injury to players.

Affixed to the boards and extending vertically shall be approved safety glass extending eight feet (8') above the boards at each end of the rink and not less than five feet (5') along both sides of the rink.

The glass and gear to hold them in position shall be properly padded or protected. Protective glass shall be required in front of the penalty benches to provide for the safety of the players on and off the ice. All equipment used to hold the glass or screens in position shall be mounted on the boards on the side away from the playing surface.

- 1.4 **Spectator Netting** – Spectator netting shall be hung in the ends of the arena, of a height, type, and in a manner approved by the League.
- 1.5 **Lines** - Eleven feet (11') from each end of the rink and in the center of a red line two inches (2") wide drawn completely across the width of the ice and continued vertically up the side of the boards, regulation goal posts and nets shall be set in such a manner as to remain stationary during the progress of a game.

The red line, two inches (2") wide, between the goal posts on the ice and extended completely across the rink, shall be known as the "GOAL LINE."

In front of each goal, a "GOAL CREASE" area shall be marked by

a red line two inches (2") in width.

The ice area between the two goals shall be divided into three parts by lines, twelve inches (12") in width, and blue in color, drawn sixty-four feet (64') out from the goal lines, and extended completely across the rink, parallel with the goal lines, and continued vertically up the side of the boards. (Paint code PMS 286.)

There shall also be a line, twelve inches (12") in width and red in color, drawn completely across the rink in center ice, parallel with the goal lines and continued vertically up the side of the boards, known as the "CENTER LINE." This line shall contain regular interval markings of a uniform distinctive design, which will readily distinguish it from the two blue lines, the outer edges of which must be continuous. (Paint code PMS 186.)

- 1.6 **Division of Ice Surface** - That portion of the ice surface in which the goal is situated shall be called the "DEFENDING ZONE" of the Team defending that goal; the central portion shall be known as the "NEUTRAL ZONE," and the portion farthest from the defended goal as the "ATTACKING ZONE."
- 1.7 **Goal Crease / Referee Crease** - The goal crease shall be laid out as follows: One foot (1') outside of each goal post a two-inch (2") line shall be painted extending four feet, six inches (4'6") in length. These lines shall be at right angles to the goal line. A semi-circle line six feet (6') in radius and two inches (2") in width shall be drawn using the center of the goal line as the center point and connecting both ends of the side of the crease. On the side of the crease lines, four feet (4') from the goal line, extend a five-inch (5") line into the crease. (see diagram on page iv preceding the table of contents)
- The goal crease area shall include all the space outlined by the crease lines and extending vertically four feet (4') to the level of the top of the goal frame. The area outlined by the crease line and the goal line shall be painted a light blue color. (Paint code PMS 298.)
- The area inside the goal frame to the goal line shall be painted a gloss white color.
- On the ice immediately in front of the Penalty Timekeeper's seat there shall be marked in red on the ice a semi-circle of ten foot (10') radius and two inches (2") in width which shall be known as the "REFEREE'S CREASE."
- 1.8 **Goalkeeper's Restricted Area** - A restricted trapezoid-shaped area behind the goal will be laid out as follows: Five feet (5') outside of each goal crease (six feet (6') from each goal post), a two-inch (2") red line shall be painted extending from the goal line to a point on the end of the rink ten feet (10') from the goal crease (eleven feet (11') from the goal post) and continuing vertically up the kick plate (see diagram on the page iv preceding the table of contents). (Paint code PMS 186).
- 1.9 **Face-off Spots and Circles** - A circular blue spot, twelve inches (12") in diameter, shall be marked exactly in the center of the rink; and with this spot as a center, a circle of fifteen feet (15') radius shall be marked with a blue line two inches (2") in width.

Two red spots two feet (2') in diameter shall be marked on the ice

in the neutral zone five feet (5') from each blue line. Within the face-off spot, draw two parallel lines three inches (3") from the top and bottom of the spot. The area within the two lines shall be painted red, the remainder shall be painted white. The spots shall be forty-four feet (44') apart and each shall be a uniform distance from the adjacent boards.

In both end zones and on both sides of each goal, red face-off spots and circles shall be marked on the ice. The face-off spots shall be two feet (2') in diameter. Within the face-off spot, draw two parallel lines three inches (3") from the top and bottom of the spot. The area within the two lines shall be painted red, the remainder shall be painted white.

The circles shall be two inches (2") wide with a radius of fifteen feet (15') from the center of the face-off spots. At the outer edge of both sides of each face-off circle and parallel to the goal line shall be marked two red lines, two inches (2") wide and two feet (2') in length and three feet (3') apart.

One foot away from the outer edge of the face-off spot, two lines shall be drawn parallel with the side boards that shall be four feet (4') in length and eighteen inches (18") apart. Parallel to the end boards, commencing at the end of the line nearest to the face-off spot, a line shall extend two feet ten inches (2'10") in length. All lines shall be two inches (2") in width. See diagram on page v preceding the table of contents.

The location of the face-off spots shall be fixed in the following manner:

Along a line twenty feet (20') from each goal line and parallel to it, mark two points twenty-two feet (22') on both sides of the straight line joining the center of the two goals. Each such point shall be the center of a face-off spot and circle.

Rule 2 – Goal Posts and Nets

- 2.1 **Goal Posts** - The goal posts shall be kept in position by means of flexible pegs affixed in the ice or floor. The flexible pegs shall be ten inches (10") in length and light green in color.

The goal posts shall be of approved design and material, extending vertically four feet (4') above the surface of the ice and set six feet (6') apart measured from the inside of the posts. A crossbar of the same material as the goal posts shall extend from the top of one post to the top of the other. See diagram on page v preceding table of contents.

The goal posts and crossbar shall be painted in red and all other exterior surfaces shall be painted in white.

- 2.2 **Nets** - There shall be attached to each goal frame a net of approved design made of white nylon cord which shall be draped in such a manner as to prevent the puck coming to rest on the outside of it, yet strung in a manner that will keep the puck in the net.

A skirt of heavy white nylon fabric or heavyweight white canvas shall be laced around the base plate of the goal frame in such a way

as to protect the net from being cut or broken. This protective padding must be attached in a manner that will not restrict the puck from completely crossing the goal line. This padding must be set back six inches (6") from the inside of the goal post. This skirt shall not project more than one inch (1") above the base plate.

The frame of the goal shall be draped with a nylon mesh net so as to completely enclose the back of the frame. The net shall be made of three-ply twisted twine (0.197 inch (5 mm) diameter) or equivalent braided twine of multifilament white nylon with an appropriate tensile strength of 700 pounds. The size of the mesh shall be two and one-half inches (2½") (inside measurement) from each knot to each diagonal knot when fully stretched. Knotting shall be made as to ensure no sliding of the twine. The net shall be laced to the frame with medium white nylon cord no smaller in size than No. 21.

Rule 3 – Benches

- 3.1 **Players' Benches** - Each rink shall be provided with seats or benches for the use of players of both teams. The accommodations provided, including benches and doors, **MUST** be uniform for both teams. Such seats or benches shall have accommodation for at least fourteen (14) persons of each team. The benches shall be placed immediately alongside the ice as near to the center of the rink as possible. Two doors for each bench must be uniform in location and size and as convenient to the dressing rooms as possible.

Each players' bench should be twenty-four feet (24') in length and when situated in the spectator area, shall be separated from the spectators by a protective glass of sufficient height so as to afford the necessary protection for the players. The players' benches shall be on the same side of the playing surface opposite the penalty bench and should be separated by a substantial distance, if possible.

Each players' bench shall have two doors which must be uniform in location and size. ("Mirrored image benches") All doors opening to the playing surface shall be constructed so that they swing inward.

- 3.2 **Penalty Bench** - Each rink must be provided with benches or seats to be known as the "PENALTY BENCH." These benches or seats must be capable of accommodating a total of ten persons including the Penalty Timekeepers. Separate penalty benches shall be provided for each Team and they shall be situated on opposite sides of the Timekeeper's area, directly across the ice from the players' benches. The penalty bench(es) must be situated in the neutral zone.

Each Penalty Bench shall be protected from the spectator area by means of a glass partition which shall not be less than five feet (5') above the height of the boards.

Rule 4 – Signal and Timing Devices

- 4.1 **Signal Devices** - Each rink must be provided with a siren, or other suitable sound device that will sound automatically at the conclusion of each period of play. Should the sound device fail to sound

automatically when time expires, the determining factor as to whether or not the period has ended shall be the timing device.

Behind each goal, electrical lights shall be set up for the use of the Goal Judges. A red light will signify the scoring of a goal and a green light will signify the end of a period or a game.

A goal cannot be scored when a green light is showing.

A light, normally red in color, will be situated at or near the Timekeeper's Bench and will be illuminated when a commercial time-out is in progress. This light will be extinguished when the commercial time-out is complete to indicate to the teams and the officials that play may resume. This light is controlled by an authorized National Hockey League Commercial Coordinator.

- 4.2 **Timing Devices** - Each rink shall be provided with some form of electronic clock for the purpose of keeping the spectators, players and game officials accurately informed as to all time elements at all stages of the game including the time remaining to be played in any period and the time remaining to be served by at least five penalized players on each Team.

Time recording for both game time and penalty time shall show time remaining to be played or served.

The game time clock shall measure the time remaining in tenths of a second during the last minutes of each period.

SECTION 2 - TEAMS

Rule 5 – Team

- 5.1 **Eligible Players** - A team shall be composed of 20 players (18 skaters and two goalkeepers) who shall be under contract to the Club they represent.

At the beginning of each game, the Manager or Coach of each team shall list the players and goalkeepers who shall be eligible to play in the game. Not more than eighteen (18) players and two (2) goalkeepers, shall be permitted. One non-uniformed player shall be permitted on the players' bench in a coaching capacity. He must be indicated on the Roster Sheet submitted by the Coach to the Referee or Official Scorer prior to the start of the game.

A list of names and numbers of all eligible players and goalkeepers must be handed to the Official Scorer before the game, and no change shall be permitted in the list or addition thereto shall be permitted after the commencement of the game.

Prior to the game, if an official (on-ice or off-ice) notices that a player or goalkeeper is in uniform but has not been included on the Official Game Report, the Referee shall bring this to the attention of the offending team so that the necessary correction can be made to the Official Game Report (and no penalty is assessed).

- 5.2 **Ineligible Player** - Only players and goalkeepers on the list submitted to the Official Scorer before the game may participate in the game. The determining factor when considering whether or not a player or goalkeeper is eligible is that the player or goalkeeper's name, and not necessarily the player or goalkeeper's number, must be correctly listed by the Manager or Coach of that team.

If a goal is scored when an ineligible player or goalkeeper is on the ice (whether he was involved in the scoring or not), the goal will be disallowed. This only applies to the goal scored at the stoppage of play whereby the player or goalkeeper was deemed to be ineligible. All other goals scored previously by the ineligible player or goalkeeper's team (with him on the ice or not) shall be allowed. The ineligible player will be removed from the game and the Club shall not be able to substitute another player from its roster. No additional penalties are to be assessed but a report of the incident must be submitted to the Commissioner. For an ineligible goalkeeper, see **5.3**.

- 5.3 **Goalkeeper** - Each team shall be allowed one goalkeeper on the ice at one time. The goalkeeper may be removed and another player substituted. Such substitute shall not be permitted the privileges of the goalkeeper.

Each team shall have on its bench, or on a chair immediately beside the bench, a substitute goalkeeper who shall, at all times, be fully dressed and equipped ready to play.

Except when both goalkeepers are incapacitated, no player in the playing roster in that game shall be permitted to wear the equipment of the goalkeeper.



In regular League and Playoff games, if both listed goalkeepers are incapacitated, that team shall be entitled to dress and play any available goalkeeper who is eligible. This goalkeeper is eligible to sit on the player's bench, in uniform. In the event that the two regular goalkeepers are injured in quick succession, the third goalkeeper shall be provided with a reasonable amount of time to get dressed, in addition to a two-minute warm-up (except when he enters the game to defend against a penalty shot).

The recalling of minor league goalkeepers (as a result of suspensions incurred to both goalkeepers under Rule 11 – Goalkeeper's Equipment) to ensure a complete lineup for subsequent games shall be deemed to be an emergency recall and subject to the twenty-three (23) man roster limitations.

- 5.4 **Coaches and Team Personnel** - No one but players and goalkeepers in uniform, non-playing team personnel duly registered on the Roster Sheet as the Manager, Coach(es), Trainer, Equipment Manager, etc. shall be permitted to occupy the benches so provided.

One non-uniformed player shall be permitted on the players' bench in a coaching capacity. He must be indicated on the Roster Sheet submitted by the Coach to the Official Scorer prior to the start of the game.

Rule 6 – Captain and Alternate Captains

- 6.1 **Captain** - One Captain shall be appointed by each team, and he alone shall have the privilege of discussing with the Referee any questions relating to interpretation of rules which may arise during the progress of a game. He shall wear the letter "C," approximately three inches (3") in height and in contrasting color, in a conspicuous position on the front of his sweater. No co-Captains are permitted. Either one Captain and no more than two Alternate Captains, or no Captain and no more than three Alternate Captains are permitted (see 6.2).

Only the Captain, when invited to do so by the Referee, shall have the privilege of discussing any point relating to the interpretation of rules. Any Captain, Alternate Captain or any player or goalkeeper who comes off the bench and makes any protest or intervention with the officials for any purpose shall be assessed a minor penalty for unsportsmanlike conduct under Rule 40 – Abuse of Officials. Should this protest continue, he may be assessed a misconduct penalty, and if it further continues, a game misconduct penalty shall be warranted.

A complaint about a penalty is NOT a matter "relating to the interpretation of the rules" and a minor penalty shall be imposed against any Captain, Alternate Captain or any other player or goalkeeper making such a complaint.

The Referee and Official Scorer shall be advised, prior to the start of each game, the name of the Captain and the Alternate Captains of both teams.

No playing Coach or playing Manager or goalkeeper shall be



permitted to act as Captain or Alternate Captain.

- 6.2 **Alternate Captains** – If the permanent Captain is not on the ice, Alternate Captains (not more than two) shall be accorded the privileges of the Captain. Alternate Captains shall wear the letter “A” approximately three inches (3”) in height and in contrasting color, in a conspicuous position on the front of their sweaters.

Only when the Captain is not in uniform, the Coach shall have the right to designate three Alternate Captains. This must be done prior to the start of the game.

Rule 7 – Starting Line-up

- 7.1 **Starting Line-up** - Prior to the start of the game, at the request of the Referee, the Manager or Coach of the visiting team is required to name the starting line-up to the Referee or Official Scorer.

Prior to the start of the game, the Manager or Coach of the home team, having been advised by the Official Scorer the names of the starting line-up of the visiting team, shall name the starting line-up of the home team. This information shall be conveyed by the Official Scorer to the Coach of the visiting team.

No change in the starting line-up of either team as given to the Official Scorer, or in the playing line-up on the ice, shall be made until the game is actually in progress.

- 7.2 **Violation** - For an infraction of this rule, a bench minor penalty shall be imposed upon the offending team, provided such infraction is called to the attention of the Referee before the second face-off in the first period takes place. This is an appeal play and must be brought to the Referee's attention prior to the second face-off in the game. There is no penalty to the requesting team if their appeal is unsustainable. The determining factor when considering whether or not a player or goalkeeper is listed in the starting line-up is that the player or goalkeeper's name, and not necessarily the player or goalkeeper's number, must be correctly listed by the Manager or Coach of that team.

In the event a team scores on the first shift of the game, and it is brought to the attention of the Referee by the opposing team that the team that scored did not have the correct starting line-up on the ice, the goal shall be allowed and a bench minor penalty assessed to the offending team for having an improper starting line-up. If the team that scores the goal on the first shift of the game challenges the starting line-up of the opposing team and the opposing team did not have the correct starting line-up, the scoring of the goal would nullify the bench minor penalty and no further penalties would be assessed.



Rule 8 – Injured Players

8.1 **Injured Player** - When a player is injured or compelled to leave the ice during a game, he may retire from the game and be replaced by a substitute, but play must continue without the teams leaving the ice.

During the play, if an injured player wishes to retire from the ice and be replaced by a substitute, he must do so at the players' bench and not through any other exit leading from the rink. This is not a legal player change and therefore when a violation occurs, a bench minor penalty shall be imposed.

If a penalized player has been injured, he may proceed to the dressing room without the necessity of taking a seat on the penalty bench. If the injured player receives a minor penalty, the penalized team shall immediately put a substitute player on the penalty bench, who shall serve the penalty until such time as the injured player is able to return to the game. He would replace his teammate on the penalty bench at the next stoppage of play. If the injured player receives a major penalty, the penalized team shall place a substitute player on the penalty bench before the penalty expires and no other replacement for the penalized player shall be permitted to enter the game except from the penalty bench. For violation of this rule, a bench minor penalty shall be imposed.

Should the injured penalized player who has been replaced on the penalty bench return to his players' bench prior to the expiration of his penalty, he shall not be eligible to play until his penalty has expired. If, however, there is a stoppage of play prior to the expiration of his penalty, he must then replace his teammate on the penalty bench and return to play once his penalty has expired.

When a player is injured so that he cannot continue play or go to his bench, the play shall not be stopped until the injured player's team has secured possession of the puck. If the player's team is in possession of the puck at the time of injury, play shall be stopped immediately unless his team is in a scoring position.

In the case where it is obvious that a player has sustained a serious injury, the Referee and/or Linesman may stop the play immediately.

When play has been stopped by the Referee or Linesman due to an injured player, or whenever an injured player is attended to on the ice by the Trainer or medical personnel, such player must be substituted for immediately. This injured player cannot return to the ice until play has resumed.

When play is stopped for an injured player, the ensuing face-off shall be conducted at the face-off spot in the zone nearest the location of the puck when the play was stopped. When the injured player's team has possession of the puck in the attacking zone, the face-off shall be conducted at one of the face-off spots outside the blue line in the neutral zone. When the injured player is in his defending zone and the attacking team is in possession of the puck in the attacking zone, the face-off shall be conducted at one of the defending team's



end-zone face-off spots.

- 8.2 **Injured Goalkeeper** - If a goalkeeper sustains an injury or becomes ill, he must be ready to resume play immediately or be replaced by a substitute goalkeeper and no additional time shall be allowed by the Referee for the purpose of enabling the injured or ill goalkeeper to resume his position. The substitute goalkeeper shall be allowed a two (2) minute warm-up during all pre-season games. No warm-up shall be permitted for a substitute goalkeeper in all regular League or Playoff games.

The Referee shall report to the Commissioner for disciplinary action any delay in making a goalkeeper substitution.

The substitute goalkeeper shall be subject to the regular rules governing goalkeepers and shall be entitled to the same privileges.

When a substitution for the regular goalkeeper has been made, such regular goalkeeper shall not resume his position until the next stoppage of play.

When play has been stopped by the Referee or Linesman due to an injured goalkeeper, such goalkeeper must be substituted for only if he has to proceed to the players' bench to receive medical attention. If the Trainer has come onto the ice to attend to the goalkeeper and there is no undue delay, the goalkeeper may remain in the game without substitute. However, no additional time shall be permitted by the Referee for the purpose of enabling the injured goalkeeper to resume his position (i.e. no warm-up).

- 8.3 **Blood** – At the discretion of the Referee, a player or goalkeeper who is bleeding shall be ruled off the ice at the next stoppage of play. Such player or goalkeeper shall not be permitted to return to play until the bleeding has been stopped and the cut or abrasion covered (if necessary). It is required that any affected equipment and/or uniform be properly decontaminated or exchanged.



SECTION 3 – EQUIPMENT

Rule 9 – Uniforms

- 9.1 **Team Uniform** – All players of each team shall be dressed uniformly with approved design and color of their helmets, sweaters, short pants, stockings and skates.

Altered uniforms of any kind, i.e. Velcro inserts, over-sized jerseys, altered collars, etc., will not be permitted. Any player or goalkeeper not complying with this rule shall not be permitted to participate in the game. For violations, refer to **9.5**.

Each member Club shall design and wear distinctive and contrasting uniforms for their home and road games, no parts of which shall be interchangeable except the pants. Any concerns regarding a player's uniform (including the goalkeeper) shall be reported by the Referee to the NHL Hockey Operations Department.

- 9.2 **Numbers** - Each player and each goalkeeper listed in the line-up of each team shall wear an individual identifying number at least ten inches (10") high on the back of his sweater. Sweater numbers such as 00, ½ (fractions), .05 (decimals), 101 (three digit) are not permitted. In addition, each player and goalkeeper shall wear his surname in full, in block letters three inches (3") high, across the back of his sweater at shoulder height.
- 9.3 **Player's Jersey** – The maximum jersey size is (see diagram).



No inserts or additions are to be added to the standard players' jersey as produced by the manufacturer. (Modifications at the manufacturer are not allowed unless approved in advance by the League)

No alteration of the neck opening is permitted.

Sleeves must extend into the cuff of the glove.

Jerseys must be "tied down" properly at all times.

9.4 Goalkeeper's Jersey – The maximum jersey size is (see diagram).

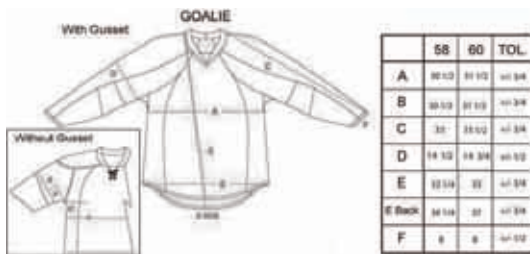

No inserts or additions are to be added to the standard goalkeeper-cut jersey as produced by the manufacturer. Modifications at the manufacturer are not allowed unless approved in advance by the League.

No "tying down" of the sweater is allowed at the wrists if it creates a tension across the jersey such that a "webbing effect" is created in the armpit area.

No other tie downs are allowed that create a "webbing effect."

The length of a jersey is illegal if it covers any area between the goalkeeper's legs.

9.5 Protective Equipment - All protective equipment, except gloves, headgear and goalkeepers' leg guards must be worn under the uniform. Should it be brought to the attention of the Referee that a player or goalkeeper is wearing, for example, an elbow pad that is not covered by his jersey, he shall instruct the player or goalkeeper to cover up the pad and a second violation by the same player or goalkeeper would result in a minor penalty being assessed.

All players of both teams shall wear a helmet of design, material and construction approved by the League at all times while participating in a game, either on the playing surface or the players' or penalty benches.

A player may continue to participate in the play without his helmet. However, if he goes to his players' bench to be substituted for, he may not return to the ice during play without a helmet. Should he do so, the play shall be stopped once his team has gained possession of the puck. If the play is stopped for such an infraction in the attacking zone, the ensuing face-off will take place at the nearest face-off spot in the neutral zone of the non-offending team. If the play is stopped for such an infraction in the defending or neutral zone, the ensuing face-off will take place at the nearest face-off spot to the location of the puck in that zone when the play was stopped.

When a goalkeeper has lost his helmet and/or face mask and his team has possession of the puck, the play shall be stopped immediately to allow the goalkeeper the opportunity to regain his helmet and/or face mask. When the opposing team has possession of the puck, play shall only be stopped if there is no immediate and

impending scoring opportunity. This stoppage of play must be made by the Referee. When play is stopped because the goalkeeper has lost his helmet and/or face mask, the ensuing face-off shall take place at one of the defending team's end zone face-off spots.

When a goalkeeper deliberately removes his helmet and/or face mask in order to secure a stoppage of play, the Referee shall stop play as outlined above and in this case assess the goalkeeper a minor penalty for delaying the game. If the goalkeeper deliberately removes his helmet and/or face mask when the opposing team is on a breakaway, the Referee shall award a penalty shot to the non-offending team. If the goalkeeper deliberately removes his helmet and/or face mask during the course of a penalty shot or shootout attempt, the Referee shall award a goal to the non-offending team.

Whenever it is deemed by the Referee that a player or goalkeeper is wearing protective equipment (including an altered jersey) that does not meet with League regulations, he shall instruct the player or goalkeeper to change or remove the piece of equipment. If he refuses to make the necessary change he shall be assessed a minor penalty for delay of game and should he return to the ice without making the necessary change he shall be assessed a misconduct penalty. Should this happen a third time, he shall be assessed a game misconduct penalty.

- 9.6 **Dangerous Equipment** - The use of pads or protectors made of metal, or of any other material likely to cause injury to a player or goalkeeper, is prohibited. Referees have the authority to prohibit any equipment they feel may cause injury to any participants in the game. Failure to comply to the Referees' instructions shall result in the assessment of a minor penalty for delay of game.

A mask or protector of a design approved by the League may be worn by a player who has sustained a facial injury.

In the first instance, the injured player shall be entitled to wear any protective device prescribed by the Club doctor. If any opposing Club objects to the device, it may record its objection with the Commissioner.

In cases where a stick may have been modified and it is evident that the edges have not been beveled, the Referee shall deem the stick to be dangerous equipment and removed from the game until the edges can be beveled sufficiently. No penalty is to be assessed initially unless the player returns to the ice with the unmodified stick, for which he will be assessed a minor penalty for delay of game.

Rule 10 – Sticks

- 10.1 **Player's Stick** - The sticks shall be made of wood or other material approved by the League, and must not have any projections. Adhesive tape of any color may be wrapped around the stick at any

place for the purpose of reinforcement or to improve control of the puck.

No stick shall exceed sixty-three inches (63") in length from the heel to the end of the shaft nor more than twelve and one-half inches (12½") from the heel to the end of the blade.

Requests for an exception to the length of the shaft (only) may be submitted in writing to and must be approved by the League's Hockey Operations Department prior to any such stick being approved for use. Maximum length of a stick granted an exception under this rule is sixty-five inches (65").

The blade of the stick shall not be more than three inches (3") in width at any point between the heel and ½" in from the mid-point of the tip of the blade, nor less than two inches (2"). All edges of the blade shall be beveled (see 9.6). The curvature of the blade of the stick shall be restricted in such a way that the distance of a perpendicular line measured from a straight line drawn from any point at the heel to the end of the blade to the point of maximum curvature shall not exceed three-quarters of an inch (¾").

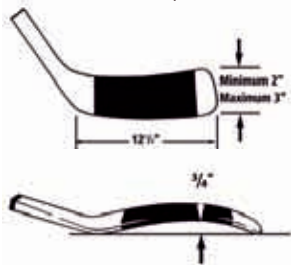

STICK MEASUREMENTS



- 10.2 **Goalkeeper's Stick** - In the case of a goalkeeper's stick, there shall be a knob of white tape or some other protective material approved by the League. This knob must not be less than one-half inch (½") thick at the top of the shaft.

Failure to comply with this provision of the rule will result in the goalkeeper's stick being deemed unfit for play. The goalkeeper's stick must be changed without the application of a minor penalty.

The blade of the goalkeeper's stick shall not exceed three and one-half inches (3½") in width at any point except at the heel, where it must not exceed four and one-half inches (4½") in width; nor shall the goalkeeper's stick exceed fifteen and one-half inches (15½") in length from the heel to the end of the blade.

There is to be no measurement of any of the dimensions of the goalkeeper's stick during the course of the game. The League's Hockey Operations Department is specifically authorized to make a check of all goalkeepers' sticks to ensure the compliance with the rule.

It shall report its findings to the Commissioner for his disciplinary action (see 11.8).

The widened portion of the goalkeeper's stick extending up the shaft from the blade shall not extend more than twenty-six inches (26") from the heel and shall not exceed three and one-half inches (3½") in width.

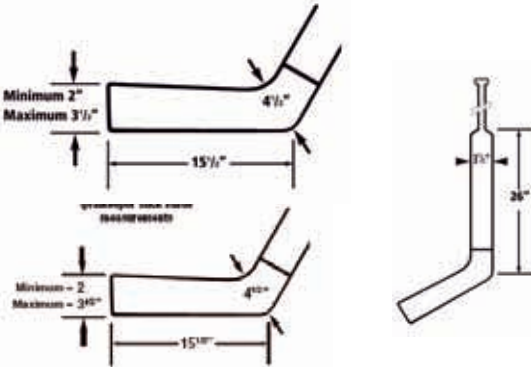

GOALKEEPERS' STICK MEASUREMENTS

- 10.3 **Broken Stick – Player** - A broken stick is one which, in the opinion of the Referee, is unfit for normal play.

A player without a stick may participate in the game. A player whose stick is broken may participate in the game provided he drops the broken stick. A minor penalty shall be imposed for an infraction of this rule.

A player who has lost or broken his stick may only receive a stick at his own players' bench or be handed one from a teammate on the ice. A player may not participate in the play using a goalkeeper's stick. A minor penalty shall be imposed for an infraction of this rule.

A player tendered a stick thrown on the ice from the players' or penalty bench will not receive a penalty. However, the person responsible for throwing the stick will receive a bench minor penalty.

- 10.4 **Broken Stick – Goalkeeper** - A goalkeeper may continue to play with a broken stick until a stoppage of play or until he has one legally handed to him by a teammate. The teammate must hand the stick to him. He cannot throw it or slide it to the goalkeeper (this includes situations where the goalkeeper has lost his stick and a teammate is trying to return it to him). For a violation of this rule, a minor penalty for throwing the stick shall be assessed to the offending player (no penalty to the goalkeeper for receiving the stick).

A goalkeeper whose stick is broken or illegal may not go to the players' bench for a replacement but must receive his stick from a teammate. A goalkeeper may participate in the play using a player's stick until such time as he is legally provided with a replacement

goalkeeper's stick.

For an infraction of this rule, a minor penalty shall be imposed on the goalkeeper.

- 10.5 **Stick Measurement** - A request for a stick measurement shall be limited to one request per team during the course of any stoppage in play.

When a formal complaint is made by the Captain or Alternate Captain of a team, against the dimensions of any stick of an opponent, that opponent must be on the ice at the time the request is made to the Referee. Once the request is made, and as long as the Officials maintain visual contact with the stick, it can be measured. This means that if the player whose stick is about to be measured steps off the ice onto his players' bench, his stick may still be measured provided the request was received prior to him leaving the ice surface and the stick remains in the view of at least one of the on-ice Officials.

The Referee shall take the stick to the penalty bench where the necessary measurement shall be made immediately. Players on both teams shall retire to their respective benches. To measure the curvature of the blade of the stick, the Referee must draw an imaginary line along the outside of the shaft to the bottom of the blade and then along the bottom of the blade - this will determine the location of the heel. Using a League-approved measuring gauge, the Referee shall secure the gauge at the heel of the stick and measure the curvature of the blade from the heel to any point along the toe of the blade. To measure any other dimension of the stick, the Referee shall use a measuring tape.

The result shall be reported to the Penalty Timekeeper, who shall record it on the back of the Penalty Record form. The Referee will convey the result of the measurement to Captain or Alternate Captain of the player whose stick was measured. If the stick proves to be illegal, the stick shall remain at the penalty bench until the end of the game.

A player whose stick has been measured and it is found not to conform to the provisions of this rule shall be assessed a minor penalty and a fine of two hundred dollars (\$200). For a second offense in the same season, the player shall (in addition to the minor penalty) be fined one thousand dollars (\$1000). For a third offense in the same season, the player shall (in addition to the minor penalty) be assessed a game misconduct and an automatic one game suspension. For all additional violations in the same season, the automatic suspension to the player shall (in addition to the minor penalty and game misconduct assessed during the game) double for each subsequent violation of this rule (i.e. first suspension - one game, second suspension - two games, third suspension - four games etc.)

If the complaint is not sustained, a bench minor penalty shall be imposed against the complaining Club in addition to a fine of one hundred dollars (\$100).

A player who participates in the play, who checks or who intentionally prevents the movement of an opponent, or who intentionally plays the puck while carrying two sticks (including while taking a replacement stick to his goalkeeper) shall incur a minor penalty under this rule but the automatic fine of two hundred dollars (\$200) shall not be imposed. If his participation causes a foul resulting in a penalty, the Referee shall report the incident to the Commissioner for disciplinary action.

A request for a stick measurement in regular playing time is permitted, including after the scoring of a goal, however, a goal cannot be disallowed as a result of the measurement. A request for a stick measurement following a goal in overtime (including one scored on a penalty shot in overtime) is not permitted. Stick measurements prior to or during the shootout are permitted, subject to the guidelines outlined in 10.7.

Any player or goalkeeper who deliberately breaks his stick or who refuses to surrender his stick for measurement when requested to do so by the Referee shall be assessed a minor penalty plus a ten-minute (10) misconduct. In addition, this player or goalkeeper shall be subject to a two hundred dollar (\$200) fine.

If, after a player's stick has been ruled illegal, he attempts to take a penalty shot with a second stick that is also ruled illegal prior to taking the penalty shot, the opportunity to take the penalty shot shall be disallowed. The player shall be assessed one minor penalty for the first illegal stick.

- 10.6 Stick Measurement – Prior to Penalty Shot** – A stick measurement request may be made prior to a penalty shot following the guidelines below:

First Stick

If the stick is “legal” the complaining Club is assessed a bench minor penalty, a player is placed in the penalty box immediately. Regardless as to the result of the penalty shot, the bench minor penalty is assessed and served.

If the stick is “illegal” the player will be assessed a minor penalty. He will be ordered to obtain a new (second) stick prior to the penalty shot. After he takes the shot he will be required to serve his penalty.

Second stick

The player will be told that the second stick will be measured prior to the penalty shot to verify the legality of the stick.

If the second stick is “legal”, proceed with the penalty shot.

If second stick is “illegal”, disallow the opportunity for the penalty shot and assess one minor penalty for the first illegal stick.

If the player refuses to surrender his stick for measurement prior to the penalty shot, the penalty shot shall not be permitted and the player shall be assessed a misconduct penalty.

10.7 Stick Measurement – Prior to Shootout Attempt – A stick measurement request must be made prior to the Referee blowing his whistle to begin the shootout attempt.

If the stick is “legal” the complaining Club forfeits their next shootout attempt. In addition, the complaining Club’s Coach shall be fined one thousand dollars (\$1000) and the Club shall be fined five thousand dollars (\$5000). Should this occur during the first set of three shooters, the next shooter listed becomes ineligible to shoot until such time as all eligible players have participated in the shootout. Their next shootout attempt would be recorded as “no goal”.

If the stick is “illegal”, the offending team forfeits that shootout attempt by that player, and the player becomes ineligible to participate in the shootout. In addition, the player is fined one thousand dollars (\$1000) and his Club is fined five thousand dollars (\$5000). This shootout attempt would be recorded as “no goal”.

Stick measurement violations during the shootout shall not be subject to the fines and suspensions outlined in **10.5**.

Rule 11 – Goalkeeper’s Equipment

11.1 Goalkeeper’s Equipment - With the exception of skates and stick, all the equipment worn by the goalkeeper must be constructed solely for the purpose of protecting the head or body, and he must not wear any garment or use any contrivance which would give him undue assistance in keeping goal.

The League’s Hockey Operations Department is specifically authorized to make a check of each teams’ equipment (including goalkeepers’ sticks) to ensure the compliance with the rule. It shall report its findings to the Commissioner for his disciplinary action.

11.2 Leg Guards – The leg guards worn by goalkeepers shall not exceed eleven inches (11") in extreme width when on the leg of the player. The maximum length from bottom mid-point to top mid-point of the pad is not to exceed thirty-eight inches (38"). The minimum length of the boot of the pad is to be no less than seven inches (7"). The boot channel of the goal pad must be flat or concave in appearance. No attachments such as plastic puck foils are permitted.

Calf protectors must follow the contour of the calf and ankle and can have a thickness of no greater than one and a half inches (1½"). No raised ridges will be permitted on the calf protector that would be deemed to act as deflectors of pucks.

The knee strap pad is not to exceed six inches (6") in length by five and one-half inches (5½") in width by one and one-half (1½") in thickness. The knee strap pad must be fastened to the inner risers. The total width measurement of the entire inner knee padding (pad risers) including the outer knee strap pad must not exceed two and a half inches (2½") in thickness. The inner kneepads are not to exceed seven inches (7") in length, five and a half inches (5½") in

width. The length of seven inches (7") is measured from where the inner padding attaches to the leg pad and back to the end of the inner padding. Medial rolls (raised seam ridges) will not be permitted. All knee protection must be worn under the thigh guard of the pant.

- 11.3 **Chest and Arm Pads** – No raised ridges are allowed on the front edges or sides of the chest pad, the inside or outside of the arms, or across the shoulders.

Layering at the elbow is permitted to add protection but not to add stopping area. This layering, both across the front and down the sides, to protect the point of the elbow shall not exceed seven inches (7").

Shoulder cap protectors must follow the contour of the shoulder cap without becoming a projection/extension beyond or above the shoulder or shoulder cap. This contoured padding must not be more than one inch (1") in thickness beyond the top ridge of the shoulder and shoulder cap.

On each side the shoulder clavicle protectors are not to exceed seven inches (7") in width. Their maximum thickness is to be one inch (1"). This protection is not to extend or project above or beyond the shoulder or shoulder cap nor extend beyond the armpit. No insert is allowed between the shoulder clavicle protector and the chest pad that would elevate the shoulder clavicle protector.

If, when the goalkeeper assumes his normal crouch position, the shoulder and/or shoulder cap protection is pushed above the contour of the shoulder, the chest pad will be considered illegal.

- 11.4 **Pants** – No internal or external or cheater padding is permitted on the pant leg or waist beyond that which is required to provide protection (no outside or inside ridges).

The maximum width (straight line) of the thigh pad across the front of the leg is ten inches (10"). If the groin and/or hip pads extend beyond the edge of the front thigh pad they are to be included in this ten-inch (10") measurement. This measurement is to be taken while the goalkeeper is in an upright standing position. This measurement is to be made five inches (5") up from the bottom of the pant.

All thigh pads must follow the contour of the leg. Square thigh pads are considered illegal.

All knee protection must be strapped and fit under the thigh pad of the pant leg and not exceed the ten inches (10") allowed for the width of the thigh pad.

- 11.5 **Catching Glove** – A maximum perimeter of forty-five inches (45") is permitted. The perimeter of the glove is the distance around the glove (see measurement procedures below).

The wrist cuff must be four inches (4") in width. The cuff of the glove is considered to be the portion of the glove protecting the wrist from the point where the thumb joint meets the wrist. Any protection joining/enhancing the cuff to the glove will be considered part of the glove rather than the cuff.

The wrist cuff is to be a maximum of eight inches (8") in length (this includes the bindings). All measurements follow the contour of the cuff.

The distance from the heel of the glove along the pocket and following the contour of the inside of the trap of the glove to the top of the "T" trap must not exceed eighteen inches (18"). The heel is considered to be the point at which the straight vertical line from the cuff meets the glove (see diagram at right).

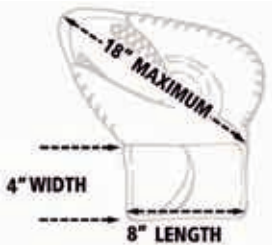

Measuring Procedures for Goalkeepers' Catching Glove

Suggested Equipment - binder clip, pins and a $\frac{5}{8}$ " fiberglass cloth measuring tape that measures eighth of an inch.

Procedure:

- 1) At the "starting point" of the measurement, anchor the tape with a pin or binder clip.
- 2) Ensure that the midpoint line of the measuring tape follows the outside top ridge of the edge/binding.
- 3) If at the junction of the cuff and catch portions of the glove there is a "jagged point," the measurement tape will follow the imaginary perpendicular line to the glove ridge above. (A "jagged joint" anywhere else on the glove will not be allowed this "straight line" privilege, i.e. where the trap joins the main glove).

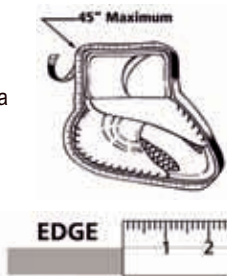

- 11.6 **Blocking Glove** – Protective padding attached to the back or forming part of the goalkeeper's blocking glove shall not exceed eight inches (8") in width nor more than fifteen inches (15") in length at any point (this includes the bindings). All measurements follow the contour of the back of the glove.

The blocking glove must be rectangular in shape.

The flap protecting the thumb and wrist must be fastened to the blocker and must follow the contour of the thumb and wrist. This thumb protection must not exceed seven inches (7") in extreme length when measured from the top of the blocking surface.

Raised ridges are not to be added to any portion of the blocking

glove.

All goalkeepers must use one of each a blocking glove and catching glove, meeting League-approved sizing specifications.

- 11.7 **Masks** – Protective masks of a design approved by the League may be worn by goalkeepers. Protective masks deemed to be worn only to increase stopping area will be considered illegal.
- 11.8 **League Inspections** - These inspections can take place any time, before, during, or after the game. A member of the League's Hockey Operations, Officiating and/or Security departments may obtain the equipment from any or all four participating goalkeepers. This equipment may be removed to a secure location for measuring.

Any violation of this rule will result in an automatic two (2) game suspension for the next League game to the offending goalkeeper. Should both goalkeepers on a Club have illegal equipment, both will be suspended in sequence. The goalkeeper who played the day/night of the measurement will be suspended for the next two (2) games, and the back-up goalkeeper will be suspended for the following two (2) games.

A goalkeeper who plays with equipment that has not been inspected and approved by the League's Hockey Operations Department, or who tampers with equipment after it has been inspected and approved by the League's Hockey Operations, Officiating and/or Security departments will be suspended for the next two (2) League games, his Club will be fined \$25,000.00 and his Equipment Manager will be fined \$1000.00 (to be deducted from his pay), regardless of whether or not such equipment previously complied with League standards. Each additional violation will result in all game suspensions and fines being doubled.

Refusal to submit the equipment for League measurement will result in the same sanctions as those imposed on a goalkeeper with illegal equipment.

Any violation of this rule shall be reported to the Club involved and to the Commissioner of the League.

Rule 12 – Illegal Equipment

- 12.1 **Illegal Equipment** - All protective equipment, except gloves, headgear and goalkeepers' leg guards must be worn under the uniform. For violation of this rule, after warning by the Referee, a minor penalty shall be imposed.

Players including the goalkeeper violating this rule shall not be permitted to participate in the game until such equipment has been corrected or removed.

- 12.2 **Gloves** - A glove from which all or part of the palm has been removed or cut to permit the use of the bare hand shall be considered illegal equipment and if any player wears such a glove in play, a minor

penalty shall be imposed on him.

When a complaint is made under this rule, and such complaint is not sustained, a bench minor penalty shall be imposed against the complaining Club for delaying the game.

- 12.3 **Elbow Pads** - All elbow pads which do not have a soft protective outer covering of sponge rubber or similar material at least one-half inch ($1/2$ ") thick shall be considered dangerous equipment.
- 12.4 **Fair Play** - These equipment regulations (Section 3) are written in the spirit of "fair play." If at any time the League feels that this spirit is being abused, the offending equipment will be deemed ineligible for play until a hearing has ruled on its eligibility.
- 12.5 **League Inspections** - The League's Hockey Operations, Officiating and/or Security departments are specifically authorized to make a check of each team's equipment to ensure the compliance with this rule. They shall report their findings to the Commissioner for his disciplinary action.

Rule 13 - Puck

- 13.1 **Dimensions** - The puck shall be made of vulcanized rubber, or other approved material, one inch (1") thick and three inches (3") in diameter and shall weigh between five and one-half ounces ($5\frac{1}{2}$ " oz.) and six ounces (6 oz.). All pucks used in competition must be approved by the League.
- 13.2 **Supply** - The home team shall be responsible for providing an adequate supply of official pucks which shall be kept in a frozen condition. This supply of pucks shall be kept at the penalty bench under the control of one of the regular off-ice Officials or a special attendant.
- 13.3 **Illegal Puck** - If at any time while play is in progress, a puck other than the one legally in play shall appear on the playing surface, the play shall not be stopped but shall continue with the legal puck until the play then in progress is completed by change of possession.

Rule 14 – Adjustment to Clothing or Equipment

- 14.1 **Adjustment to Clothing or Equipment** - Play shall not be stopped nor the game delayed by reasons of adjustments to clothing, equipment, skates or sticks.

The onus of maintaining clothing and equipment in proper condition shall be upon the player. If adjustments are required, the player shall leave the ice and play shall continue with a substitute.

No delay shall be permitted for the repair or adjustment of goalkeeper's equipment. If adjustments are required, the goalkeeper shall leave the ice and his place shall be taken by the substitute goalkeeper immediately.

SECTION 4 – TYPES OF PENALTIES

Rule 15 – Calling of Penalties

- 15.1 **Calling a Penalty** - Should an infraction of the rules which would call for a minor, major, misconduct, game misconduct or match penalty be committed by a player or goalkeeper of the side in possession of the puck, the Referee shall immediately blow his whistle and penalize the offending player or goalkeeper.

Should an infraction of the rules which would call for a minor, major, misconduct, game misconduct or match penalty be committed by a player or goalkeeper of the team not in possession of the puck, the Referee shall raise his arm to signal the delayed calling of a penalty. When the team to be penalized gains control of the puck, the Referee will blow his whistle to stop play and impose the penalty on the offending player or goalkeeper.

Refer to Reference Tables – Table 1 – Summary of Penalties to Coaches and Non-playing Club Personnel (page 129) for a list of infractions specific to those individuals.

- 15.2 **Calling a Minor Penalty – Goal Scored** - If the penalty to be imposed is a minor penalty and a goal is scored on the play by the non-offending side, the minor penalty shall not be imposed but major and match penalties shall be imposed in the normal manner regardless of whether or not a goal is scored.
- 15.3 **Calling a Double-minor Penalty – Goal Scored** - When the penalty to be imposed is applicable under Rule 48 for Head-butting or Rule 58 Butt-ending, Rule 60 High-sticking or Rule 62 Sparring, and a goal is scored, two minutes of the appropriate penalty will be assessed to the offending player or goalkeeper. (This will be announced as a double-minor for the appropriate foul and the player will serve two (2) minutes only.)
- 15.4 **Calling a Penalty – Short-handed Team – Goal Scored** - If when a team is “short-handed” by reason of one or more minor or bench minor penalties, the Referee signals a further minor penalty or penalties against the “short-handed” team and a goal is scored by the non-offending side before the whistle is blown, then the goal shall be allowed. The penalty or penalties signaled shall be assessed and the first of the minor penalties already being served shall automatically terminate under Rule 16 – Minor Penalties. Major and match penalties shall be imposed in the normal manner regardless of whether or not a goal is scored.

Should a penalty be signaled against a team already short-handed by reason of one or more minor or bench minor penalties, and the signaled penalty would result in the awarding of a penalty shot, but before the Referee can stop play to award the penalty shot, the non-offending team scores a goal, then the signaled penalty (that would have resulted in a penalty shot) shall be assessed as a minor (double-minor, major or match) penalty and the first of the minor penalties already being served shall automatically terminate under Rule 16 – Minor Penalties.

15.5 Face-off Locations - The resulting face-off shall be located at a face-off spot in the zone nearest to where the play was stopped when the offending team gained control of the puck, except when they do so in their attacking zone, to which the ensuing face-off will be conducted in the neutral zone near the defending team's blue line.

If the stoppage of play is caused by the defending team (puck frozen along the boards, frozen by the goalkeeper, shot out of play) and the attacking team is to be penalized, the resulting face-off shall be made at the nearest face-off spot in the defending zone. The only exception to this face-off location is if, prior to the stoppage of play for the assessment of the penalty, the non-offending team ices the puck. Then, the face-off following the stoppage shall take place at one of the two face-off spots in the neutral zone near the defending blue line of the team shooting the puck.

Rule 16 – Minor Penalties

16.1 Minor Penalty - For a minor penalty, any player, other than a goalkeeper, shall be ruled off the ice for two (2) minutes during which time no substitute shall be permitted.

16.2 Short-handed - "Short-handed" means that the team must be below the numerical strength of its opponent on the ice at the time the goal is scored. The minor or bench minor penalty which terminates automatically is the one with the least amount of time on the clock. Thus coincident minor penalties to both Teams do not cause either side to be "short-handed" (see Rule 19).

If while a team is "short-handed" by one or more minor or bench minor penalties, the opposing team scores a goal, the first of such penalties shall automatically terminate.

This rule shall also apply when a goal is awarded.

This rule does not apply when a goal is scored on a penalty shot (i.e. offending team's penalized player(s) do not get released on the scoring of a goal on a penalty shot).

Minor penalty expiration criteria:

- (i) *Is the team scored against short-handed?*
- (ii) *Is the team scored against serving a minor penalty on the clock?*

If both criteria are satisfied, the minor penalty with the least amount of time on the clock shall terminate except when coincidental penalties are being served. Refer to Reference Tables – Table 16 – Goals Scored Against a Short-handed Team (page 142).

No penalty shall expire when a goal is scored against a team on a penalty shot.

When the minor penalties of two players of the same team terminate at the same time, the Captain of that team shall designate to the Referee which of such players will return to the ice first and the

Referee will instruct the Penalty Timekeeper accordingly.

- 16.3 **Infractions** – Refer to Reference Tables – Table 2 – Summary of Minor Penalties (page 130), for a list of infractions that can result in a minor penalty being assessed (see specific rule numbers for complete descriptions).

Rule 17 – Bench Minor Penalties

- 17.1 **Bench Minor Penalty** - A bench minor penalty involves the removal from the ice of one player of the team against which the penalty is assessed for a period of two (2) minutes. Any player except a goalkeeper of the team may be designated to serve the penalty by the Manager or Coach through the playing Captain and such player shall take his place on the penalty bench promptly and serve the penalty as if it was a minor penalty imposed upon him.
- 17.2 **Short-handed** – see 16.2.
- 17.3 **Infractions** – Refer to Reference Tables – Table 3 – Summary of Bench Minor Penalties (page 131) for a list of infractions that can result in a bench minor penalty being assessed (see specific rule numbers for complete descriptions).

Rule 18 – Double-minor Penalties

- 18.1 **Double-minor Penalty** - For a double-minor penalty, any player, other than a goalkeeper, shall be ruled off the ice for four (4) minutes during which time no substitute shall be permitted.
- 18.2 **Short-handed** – see 16.2.

When a double-minor penalty has been signaled by the Referee and the non-offending team scores during the delay, one of the minor penalties shall be washed out and the penalized player will serve the remaining two minutes of the double-minor penalty. The penalty will be announced as a double-minor penalty but only two minutes would be shown on the penalty time clock.

- 18.3 **Infractions** – Refer to Reference Tables – Table 4 – Summary of Double-minor Penalties (page 132) for a list of infractions that can result in a double-minor penalty being assessed (see specific rule numbers for complete descriptions).

Rule 19 – Coincidental Penalties

- 19.1 **Coincidental Minor Penalties** - When coincident minor penalties or coincident minor penalties of equal duration are imposed against players of both teams, the penalized players shall all take their places on the penalty benches and such penalized players shall not leave the penalty bench until the first stoppage of play following the expiry of their respective penalties. Immediate substitution shall be made for an

equal number of minor penalties or coincident minor penalties of equal duration to each team so penalized and the penalties of the players for which substitutions have been made shall not be taken into account for the purpose of the delayed penalty rule (Rule 27). This rule only applies when at least one team is already serving a time penalty in the penalty box that causes them to be short-handed.

When one minor penalty is assessed to one player or goalkeeper of each team at the same stoppage in play, these penalties will be served without substitution provided there are no other penalties in effect and visible on the penalty clocks. Both teams will therefore play four skaters against four skaters for the duration of the minor penalties.

Should one or both of these players also incur a misconduct penalty in addition to their one minor penalty, this rule shall apply and the teams would still play four skaters against four skaters (the player incurring the misconduct penalty would have to serve the entire 12 minutes – minor plus misconduct – and his team would have to place an additional player on the penalty bench to serve the minor penalty and be able to return to the ice when the minor penalty expires).

When multiple penalties are assessed to both teams, equal numbers of minor and major penalties shall be eliminated using the coincident penalty rule and any differential in time penalties shall be served in the normal manner and displayed on the penalty time clock accordingly (see 19.5). If there is no differential in time penalties, all players will serve their allotted penalty time, but will not be released until the first stoppage of play following the expiration of their respective penalties.

- 19.2 **Coincidental Major Penalties** - When coincident major penalties or coincident penalties of equal duration, including a major and/or a match penalty, are imposed against players of both teams, the penalized players shall all take their places on the penalty benches and such penalized players shall not leave the penalty benches until the first stoppage of play following the expiry of their respective penalties. Immediate substitutions shall be made for an equal number of major penalties, or coincident penalties of equal duration including a major penalty to each team so penalized, and the penalties of the players for which substitutions have been made shall not be taken into account for the purpose of the delayed penalty rule, (Rule 27). In such situations, if one or both players have received a game misconduct in addition to their major penalties, no substitutes are required to take their places on the penalty benches.
- 19.3 **Coincidental Match Penalties** - When coincident match penalties or coincident penalties of equal duration, including a major and/or a match penalty, are imposed against players of both teams, the players with the match penalties shall be immediately removed from the game and their substitutes shall take their places on the penalty benches. These penalized players shall not leave the penalty benches until the first stoppage of play following the expiry of their respective penalties.

Immediate substitutions shall be made for an equal number of major and/or match penalties, or coincident penalties of equal duration including a major or match penalty to each team so penalized, and the penalties of the players for which substitutions have been made shall not be taken into account for the purpose of the delayed penalty rule, (Rule 27).

- 19.4 **Last Five Minutes and Overtime** - During the last five (5) minutes of regulation time, or at any time in overtime, when a minor penalty (or double-minor penalty) is assessed to one player or goalkeeper of Team A, and a major (or match) penalty is assessed to one player or goalkeeper of Team B at the same stoppage of play, the three-minute (or one-minute) differential shall be served immediately as a major penalty. This is also applicable when coincidental penalties are negated, leaving the aforementioned examples. In such instances, the team of the player or goalkeeper receiving the major penalty must place the replacement player in the penalty bench prior to expiration of the penalty. In the case of a match penalty, the team must place the replacement player in the penalty bench immediately. The differential will be recorded on the penalty clock as a three (3) minute or a one (1) minute penalty (as applicable), and served in the same manner as a major penalty.
- 19.5 **Applying the Coincidental Penalty Rule** – When multiple penalties are assessed to both teams at the same stoppage of play, the following rules are to be utilized by the Referees to determine the on-ice strength for both teams:
- (i) *Cancel as many major and/or match penalties as possible*
 - (ii) *Cancel as many minor, bench minor and or double-minor penalties as possible*

Refer to Reference Tables - Table 17 – Coincidental Penalties on page 154.

Rule 20 – Major Penalties

- 20.1 **Major Penalty** - For the first major penalty in any one game, the offender, except the goalkeeper, shall be ruled off the ice for five (5) minutes during which time no substitute shall be permitted.
- When one player or goalkeeper receives a major penalty and a minor penalty at the same time, the major penalty shall be served first by the penalized player (or substitute for the goalkeeper), except under Rule 19.2 where coincidental major penalties are in effect, in which case the minor penalty will be recorded and served first.
- 20.2 **Short-handed** – Although a major penalty does cause a team to be short-handed, the penalized player serving the major penalty does not leave the penalty bench when the opposing team scores. The player must wait for the entire major penalty to expire before he is permitted to exit the penalty bench.

- 20.3 **Substitution** – When a player has been assessed a major penalty and has been removed from the game or is injured, the offending team does not have to place a substitute player on the penalty bench immediately, but must do so at a stoppage of play prior to the expiration of the major penalty. He may then legally exit the penalty bench when the major penalty has expired.

Failure to place a player on the penalty bench prior to the expiration of the major penalty will result in that team having to continue to playing one player short (but not officially considered short-handed) until the next stoppage of play. Any replacement player who enters the game other than from the penalty bench shall constitute an illegal substitution under Rule 68 – Illegal Substitution calling for a bench minor penalty.

Furthermore, if the team fails to place a player on the penalty bench to return to the ice at the end of the major penalty, they continued to play short-handed but are not permitted to ice the puck as they are no longer short-handed by reason of a penalty.

- 20.4 **Automatic Game Misconduct** – An automatic game misconduct shall be applied to any player or goalkeeper who has been assessed a third major penalty in the same game.

An automatic game misconduct shall also be applicable whenever a player or goalkeeper is assessed a major penalty for any of the infractions listed in the Reference Tables – Table 6 – Summary of Major Penalties that Result in an Automatic Game Misconduct (page 133). See specific rule numbers for complete descriptions.

When a player or goalkeeper has been assessed a major penalty for any of the infractions listed in the Reference Tables – Table 7 – Summary of Major Penalties that Result in an Automatic Game Misconduct When There is an Injury to the Face or Head (page 133) and his opponent has suffered an injury to the face or head, a game misconduct must also be assessed. See specific rule numbers for complete descriptions.

When a major and automatic game misconduct are assessed, the player shall be ruled off the ice for the balance of the game, but a substitute shall be permitted to replace the player so suspended after five (5) minutes have elapsed.

- 20.5 **Fines** - An automatic fine of one hundred dollars (\$100) shall also be added when a major penalty is imposed for any foul causing injury to the face or head of an opponent by means of a stick.

When a player or goalkeeper is assessed a major penalty plus a game misconduct as outlined in 20.4 above, he also receives an automatic fine of two hundred dollars (\$200).

- 20.6 **Infractions** – Refer to the Reference Tables – Table 5 – Summary of Major Penalties (page 132) for a list of the infractions that can result in a major penalty being assessed (see specific rule numbers for complete descriptions).



Rule 21 – Match Penalties

- 21.1 **Match Penalty** - A match penalty involves the suspension of a player or goalkeeper for the balance of the game and the offender shall be ordered to the dressing room immediately.

A match penalty shall be imposed on any player or goalkeeper who deliberately attempts to injure an opponent in any manner.

A match penalty shall be imposed on a player or goalkeeper who deliberately injures an opponent in any manner.

- 21.2 **Short-handed** - A substitute player is permitted to replace the penalized player after five (5) minutes playing time has elapsed.

The match penalty, plus any additional penalties, shall be served by a player to be designated by the Manager or Coach of the offending team through the playing Captain, such player to take his place in the penalty box immediately.

For all match penalties, regardless of when imposed, or prescribed additional penalties, a total of ten minutes shall be charged in the records against the offending player or goalkeeper.

In addition to the match penalty, the player or goalkeeper shall be automatically suspended from further competition until the Commissioner has ruled on the issue. See also Rule 29 – Supplementary Discipline.

- 21.3 **Reports** - The Referee is required to report all match penalties and the surrounding circumstances to the Commissioner of the League immediately following the game in which they occur.

- 21.4 **Infractions** – Refer to the Reference Tables – Table 8 – Summary of Match Penalties (page 134) for a list of the infractions that can result in a match penalty being assessed (see specific rule numbers for complete descriptions).

Rule 22 – Misconduct Penalties

- 22.1 **Misconduct Penalty** - In the event of misconduct penalties to any players except the goalkeeper, the players shall be ruled off the ice for a period of ten (10) minutes each. A substitute player is permitted to immediately replace a player serving a misconduct penalty. A player whose misconduct penalty has expired shall remain in the penalty box until the next stoppage of play.

- 22.2 **Misconduct Penalty – Goalkeeper** - Should a goalkeeper on the ice incur a misconduct penalty, this penalty shall be served by another member of his team who was on the ice when the offense was committed. This player is to be designated by the Manager or Coach of the offending team through the Captain.

- 22.3 **Short-handed** – A player receiving a misconduct penalty does not cause his team to play short-handed unless he also receives a minor, major or match penalty in addition to the misconduct penalty.

When a player receives a minor penalty and a misconduct penalty at the same time, the penalized team shall immediately put a substitute player on the penalty bench and he shall serve the minor penalty without change. Should the opposing team score during the time the minor penalty is being served, the minor penalty shall terminate (unless **15.4** is applicable) and the misconduct to the originally penalized player shall commence immediately.

When a player receives a major penalty and a misconduct penalty at the same time, the penalized team shall place a substitute player on the penalty bench before the major penalty expires and no replacement for the penalized player shall be permitted to enter the game except from the penalty bench.

- 22.4 Reporting** – All misconduct penalties assessed for abuse of officials must be reported in detail to the League office.
- 22.5 Fines** - A misconduct penalty imposed on any player or goalkeeper at any time shall be accompanied with an automatic fine of one hundred dollars (\$100).
- 22.6 Infractions** – Refer to the Reference Tables – Table 9 – Summary of Misconduct Penalties (page 135) for a list of the infractions that can result in a misconduct penalty being assessed (see specific rule numbers for complete descriptions).

Rule 23 – Game Misconduct Penalties

- 23.1 Game Misconduct Penalty** - A game misconduct penalty involves the suspension of a player or goalkeeper for the balance of the game but a substitute is permitted to replace immediately the player or goalkeeper so removed.
- 23.2 Fines and Suspensions** - A player or goalkeeper incurring a game misconduct penalty shall incur an automatic fine of two hundred dollars (\$200) and the case shall be reported to the Commissioner who shall have full power to impose such further penalties by way of suspension or fine on the penalized player, goalkeeper or any other player involved in the altercation.

Any game misconduct penalty for which a player or goalkeeper has been assessed an automatic suspension or supplementary discipline in the form of game suspension(s) by the Commissioner shall not be taken into account when calculating the total number of offenses under this subsection.

The automatic suspensions incurred under this subsection in respect to League games shall have no effect with respect to violations during Playoff games.

Any request by a Club to have a game misconduct reviewed and rescinded by the League must submit their request in writing to the League's Hockey Operations Department within 48 hours of the conclusion of the game in which the game misconduct was assessed.

Failure to submit the written request within this time frame will automatically result in the game misconduct being upheld and no further review of the incident will be considered or entertained. This does not apply to infractions addressed under Rule 29 – Supplementary Discipline.

- 23.3 Fines and Suspensions – General Category** - In regular League games, any player or goalkeeper who incurs a total of three (3) game misconduct penalties in the “General Category” and exclusive of other designated categories, shall be suspended for the next League game of his team. For each subsequent game misconduct penalty, the automatic suspension shall be increased by one game. For each suspension of a player or goalkeeper, his Club shall be fined one thousand dollars (\$1,000).

In Playoff games, any player or goalkeeper who incurs a total of two game misconduct penalties in the “General Category” shall be suspended automatically for the next Playoff game of his team. For each subsequent game misconduct penalty during the Playoffs, the automatic suspension shall be increased by one game. For each suspension of a player or goalkeeper during Playoffs, his club shall be fined one thousand dollars (\$1,000).

For a list of infractions involving game misconducts that are included in the “General Category”, please refer to the Reference Tables – Table 10 – Summary of Game Misconduct Fouls Included in the “General Category” (page 136). See specific rule numbers for complete descriptions.

- 23.4 Fines and Suspensions – Abuse of Officials Category** - In regular League or Playoff games, any player or goalkeeper who incurs a total of two (2) game misconduct penalties for abuse of officials related infractions penalized under Rule 40 - Abuse of Officials, shall be suspended automatically for the next League or Playoff game of his team. For each subsequent game misconduct penalty, the automatic suspension shall be increased by one game.

- 23.5 Fines and Suspensions – Stick Infractions, Boarding and Checking from Behind Category** - In regular League games, any player or goalkeeper who incurs a total of two (2) game misconduct penalties for stick-related infractions, Boarding – Rule 42, or Checking from Behind – Rule 44, shall be suspended automatically for the next League game of his team. For each subsequent game misconduct penalty, the automatic suspension shall be increased by one game.

In Playoff games any player or goalkeeper who incurs a total of two (2) game misconduct penalties for stick-related infractions, Boarding – Rule 42, or Checking from Behind – Rule 44, shall be suspended automatically for the next Playoff game of his team. For each subsequent game misconduct penalty in this category during the Playoffs the automatic suspension shall be increased by one game.

Prior to the commencement of each Stanley Cup Finals, a player or goalkeeper will have his current stick-related, boarding and checking from behind game misconducts removed from his current

playoff record. They will remain part of his historical record.

When a player or goalkeeper has played in 41 consecutive regular League games without being assessed a stick-related major and a game misconduct penalty according to Rule 20 – Major Penalties or Rule 22 – Misconduct Penalties, he will have the previous game misconduct penalties removed from his current record. They will remain part of his historical record.

For a list of stick-related infractions, refer to the Reference Tables – Table 11 – Summary of Game Misconduct Fouls Included in the “Stick-Related Category” (page 137). See specific rule numbers for complete descriptions.

When a player or goalkeeper has played in 41 consecutive regular League games without being assessed a boarding and/or a checking from behind major and a game misconduct according to Rules 42 and 44, he will have the previous game misconduct penalties removed from his current record. They will remain part of his historical record.

A player or goalkeeper’s total games played will cover a two-year time period from the date of the first game misconduct penalty for each category of foul.

23.6 Automatic Game Misconduct – See 20.4.

23.7 **Other Infractions That Could Result in a Game Misconduct** – Refer to the Reference Tables – Table 12 – Summary of Game Misconduct Penalties (page 138) for a list of the infractions that can result in a game misconduct penalty being assessed (see specific rule numbers for complete descriptions).

In addition, the following list of infractions can also result in a game misconduct penalty being assessed:

- (i) *interfering with or striking a spectator.*
- (ii) *post-game verbal abuse from players, goalkeepers or non-playing club personnel (on or off the ice)*
- (iii) *racial taunts or slurs*
- (iv) *spitting on or at an opponent or spectator*

Any player, goalkeeper or non-playing Cub personnel who physically interferes with the spectators, becomes involved in an altercation with a spectator, or throws any object at a spectator, shall automatically incur a game misconduct penalty and the Referee shall report all such infractions to the Commissioner who shall have full power to impose such further penalty as he shall deem appropriate.

Rule 24 – (Not in use)

NOTE: Gross misconduct penalties have been re-classified as game misconduct penalties (see 23.7). The term “gross misconduct penalty” is no longer in use.

Rule 25 – Penalty Shot

- 25.1 **Penalty Shot** – A penalty shot is designed to restore a scoring opportunity which was lost as a result of a foul being committed by the offending team, based on the parameters set out in these rules.
- 25.2 **Procedure** - The Referee shall ask to have announced over the public address system the name of the player designated by him or selected by the team entitled to take the shot (as appropriate). He shall then place the puck on the center face-off spot and the player taking the shot will, on the instruction of the Referee (by blowing his whistle), play the puck from there and shall attempt to score on the goalkeeper. The puck must be kept in motion towards the opponent's goal line and once it is shot, the play shall be considered complete. No goal can be scored on a rebound of any kind (an exception being the puck off the goal post or crossbar, then the goalkeeper and then directly into the goal), and any time the puck crosses the goal line or comes to a complete stop, the shot shall be considered complete.

The lacrosse-like move whereby the puck is picked up on the blade of the stick and “whipped” into the net shall be permitted provided the puck is not raised above the height of the shoulders at any time and when released, is not carried higher than the crossbar. See also **80.1**.

The spin-o-rama type move where the player completes a 360° turn as he approaches the goal, shall be permitted as this involves continuous motion.

Only a player designated as a goalkeeper or alternate goalkeeper may defend against the penalty shot.

The goalkeeper must remain in his crease until the player taking the penalty shot has touched the puck.

If at the time a penalty shot is awarded, the goalkeeper of the penalized team has been removed from the ice to substitute another player, the goalkeeper shall be permitted to return to the ice before the penalty shot is taken.

The team against whom the penalty shot has been assessed may replace their goalkeeper to defend against the penalty shot, however, the substitute goalkeeper is required to remain in the game until the next stoppage of play.

While the penalty shot is being taken, players of both sides shall withdraw to the sides of the rink and in front of their own player's bench.

- 25.3 **Designated Player** – In cases where a penalty shot has been awarded to a player specifically fouled, that player shall be designated by the Referee to take the penalty shot.

In all other cases where a penalty shot has been awarded, the penalty shot shall be taken by a player selected by the Captain of the non-offending team from the players on the ice at the time when the foul was committed. Such selection shall be reported to the Referee

and cannot be changed.

If by reason of injury, the player designated by the Referee to take the penalty shot is unable to do so within a reasonable time, the shot may be taken by a player selected by the Captain of the non-offending team from the players on the ice when the foul was committed. Such selection shall be reported to the Referee and cannot be changed.

Should the player in respect to whom a penalty shot has been awarded himself commit a foul in connection with the same play or circumstances, either before or after the penalty shot has been awarded, be designated to take the shot, he shall first be permitted to do so before being sent to the penalty bench to serve the penalty except when such penalty is for a game misconduct or match penalty in which case the penalty shot shall be taken by a player selected by the Captain of the non-offending team from the players on the ice at the time when the foul was committed.

- 25.4 Violations During the Shot** – Should the goalkeeper leave his crease prior to the player taking the penalty shot has touched the puck, and in the event of violation of this rule or any foul committed by a goalkeeper, the Referee shall allow the shot to be taken and if the shot fails, he shall permit the penalty shot to be taken over again. When an infraction worthy of a minor penalty is committed by the goalkeeper during the penalty shot that causes the shot to fail, no penalty is to be assessed but the Referee shall permit the shot to be taken over again.

When a major or match penalty is committed by the goalkeeper that causes the shot to fail, the Referee shall permit the shot to be taken over again and the appropriate penalties shall be assessed to the goalkeeper.

The goalkeeper may attempt to stop the shot in any manner except by throwing his stick or any object, or by deliberately dislodging the goal, in which case a goal shall be awarded.

If, while the penalty shot is being taken, any player, goalkeeper, Coach or non-playing Club personnel of the opposing team shall have by some action interfered with or distracted the player taking the shot and, because of such action, the shot should have failed, a second attempt shall be permitted and the Referee shall impose a bench minor penalty to the offending team, and if a player or goalkeeper on the bench is responsible, a misconduct penalty on the player or goalkeeper so interfering or distracting shall be assessed.

If, while the penalty shot is being taken, any player, goalkeeper, Coach or non-playing Club personnel of the team taking the shot shall have by some action interfered with or distracted the goalkeeper defending the shot and, because of such action, the shot was successful, the Referee shall rule no goal and shall impose a bench minor penalty to the offending team, and if a player or goalkeeper on the bench is responsible, a misconduct penalty on the player or goalkeeper so interfering or distracting shall be assessed.



If, while the penalty shot is being taken, a spectator throws any object onto the ice or, in the judgment of the Referee, interferes with the player taking the shot or the goalkeeper defending the shot, he shall permit the shot be taken again.

If, after a player's stick has been ruled illegal, he attempts to take a penalty shot with a second stick that is also ruled illegal prior to taking the penalty shot, the opportunity to take the penalty shot shall be disallowed. The player shall be assessed one minor penalty for the first illegal stick.

- 25.5 **Face-Off Location** - If a goal is scored from a penalty shot, the puck shall be faced-off at center ice. If a goal is not scored, the puck shall be faced-off at either of the end face-off spots in the zone in which the penalty shot was tried.
- 25.6 **Results** - Should a goal be scored from a penalty shot, a further penalty to the offending player or goalkeeper shall not be applied unless the offense for which the penalty shot was awarded was such as to incur a major, match or misconduct penalty, in which case the penalty prescribed for the particular offense shall be imposed.

If the offense for which the penalty shot was awarded was such as to normally incur a minor penalty, then regardless of whether the penalty shot results in a goal or not, no further minor penalty shall be served.

If the offense for which the penalty shot was awarded was such as to incur a double-minor penalty, or where the offending team is assessed an additional minor penalty on the same play in which a penalty shot was awarded, the first minor penalty is not assessed since the penalty shot was awarded to restore the lost scoring opportunity. The second minor penalty would be assessed and served regardless of whether the penalty shot results in a goal. This will be announced as a double-minor penalty for the appropriate foul and the player will serve two (2) minutes only.

No penalty shall expire when a goal is scored against a team on a penalty shot.

Should two penalty shots be awarded to the same team at the same stoppage of play (two separate fouls), only one goal can be scored or awarded at a single stoppage of play. Should the first penalty shot result in a goal, the second shot would not be taken but the appropriate penalty would be assessed and served for the infraction committed.

- 25.7 **Timing** - If the foul upon which the penalty shot is based occurs during actual playing time, the penalty shot shall be awarded and taken immediately in the usual manner notwithstanding any delay occasioned by a slow whistle by the Referee to allow play to continue until the attacking side has lost possession of the puck to the defending side, which delay results in the expiry of the regular playing time in any period.

The time required for the taking of a penalty shot shall not be

included in the regular playing time or overtime.

25.8 Infractions – Refer to the Reference Tables – Table 13 – Summary of Penalty Shots (page 139) for a list of the infractions that shall result in a penalty shot being awarded (see specific rule numbers for complete descriptions).

There are four (4) specific conditions that must be met in order for the Referee to award a penalty shot for a player being fouled from behind. They are:

- (i) *The infraction must have taken place in the neutral zone or attacking zone, (i.e. over the puck carrier's own blue line);*
- (ii) *The infraction must have been committed from behind;*
- (iii) *The player in possession and control (or, in the judgment of the Referee, clearly would have obtained possession and control of the puck) must have been denied a reasonable chance to score (the fact that he got a shot off does not automatically eliminate this play from the penalty shot consideration criteria. If the foul was from behind and he was denied a "more" reasonable scoring opportunity due to the foul, then the penalty shot should be awarded);*
- (iv) *The player in possession and control (or, in the judgment of the Referee, clearly would have obtained possession and control of the puck) must have had no opposing player between himself and the goalkeeper.*

Rule 26 – Awarded Goals

26.1 Awarded Goal – A goal will be awarded to the attacking team when the opposing team has taken their goalkeeper off the ice and an attacking player has possession and control of the puck in the neutral or attacking zone on, without a defending player between himself and the opposing goal, and he is prevented from scoring as a result of an infraction committed by the defending team (see **26.3 Infractions – When Goalkeeper is Off the Ice**, below).

26.2 Infractions – When Goalkeeper is On the Ice – A goal will be awarded when an attacking player, in the act of shooting the puck into the goal (between the normal position of the posts and completely across the goal line), is prevented from scoring as a result of a defending player or goalkeeper displacing the goal post, either deliberately or accidentally.

26.3 Infractions – When Goalkeeper is Off the Ice – Refer to the Reference Tables – Table 14 – Summary of Awarded Goals (When Goalkeeper has been Removed for an Extra Attacker) (page 140) for a list of the infractions that shall result in an awarded goal being awarded when the goalkeeper has been removed for an extra attacker (see specific rule numbers for complete descriptions).

26.4 Infractions – During the Course of a Penalty Shot - A goal will be awarded when a goalkeeper attempts to stop a penalty shot by throwing his stick or any other object at the player taking the shot or

by deliberately dislodging the goal.

Rule 27 – Delayed Penalties

- 27.1 **Delayed Penalty** - If a third player of any team shall be penalized while two players of the same team are serving penalties, the penalty time of the third player shall not commence until the penalty time of one of the two players already penalized has elapsed. Nevertheless, the third player penalized must at once proceed to the penalty bench but may be replaced by a substitute until such time as the penalty time of the penalized player shall commence.
- 27.2 **Penalty Expiration** - When any team shall have three players serving penalties at the same time and because of the delayed penalty rule, a substitute for the third offender is on the ice, none of the three penalized players on the penalty bench may return to the ice until play has stopped. When play has been stopped, the player whose full penalty has expired may return to the ice.

During the play, the Penalty Timekeeper shall permit the return to the ice of the penalized players, in the order of expiry of their penalties, but only when the penalized team is entitled to have more than four players on the ice. Otherwise, these players must wait until the first stoppage of play after the expiration of their penalties in order to be released from the penalty bench.

When the penalties of two players of the same team will expire at the same time, the Captain of that team will designate to the Referee which of such players will return to the ice first and the Referee will instruct the Penalty Timekeeper accordingly (this is done to expedite the release of a player from the penalty bench when the opposing team scores on the power-play).

- 27.3 **Major and Minor Penalty** - When a major and a minor penalty are imposed at the same time on players of the same team, the Penalty Timekeeper shall record the minor as being the first of such penalties.

This applies to the case where the two penalties are imposed on different players of the same team.

Rule 28 – Goalkeeper's Penalties

- 28.1 **Minor Penalty to Goalkeeper** – A goalkeeper shall not be sent to the penalty bench for an offense which incurs a minor penalty, but instead, the minor penalty shall be served by another member of his team who was on the ice when the offense was committed. This player is to be designated by the Manager or Coach of the offending team through the playing Captain and such substitute shall not be changed.

A penalized player may not serve a goalkeeper's penalty.

- 28.2 **Major Penalty to Goalkeeper** – A goalkeeper shall not be sent to the

penalty bench for an offense which incurs a major penalty, but instead, the major penalty shall be served by another member of his team who was on the ice when the offense was committed. This player is to be designated by the Manager or Coach of the offending team through the playing Captain and such substitute shall not be changed.

Should a goalkeeper incur three major penalties in one game, he shall be ruled off the ice for the balance of the playing time and his place shall be taken by a member of his own Club, or by a regular substitute goalkeeper who is available. Such player will be allowed the goalkeeper's equipment. (Major penalty plus game misconduct penalty and automatic fine of two hundred dollars (\$200).)

- 28.3 **Misconduct Penalty to Goalkeeper** – Should a goalkeeper on the ice incur a misconduct penalty, this penalty shall be served by another member of his team who was on the ice when the offense was committed. This player is to be designated by the Manager or Coach of the offending team through the Captain and, in addition, the goalkeeper shall be fined one hundred dollars (\$100).
- 28.4 **Game Misconduct Penalty to Goalkeeper** – Should a goalkeeper incur a game misconduct penalty, his place will then be taken by a member of his own Club, or by a regular substitute goalkeeper who is available, and such player will be allowed the goalkeeper's full equipment. In addition, the goalkeeper shall be fined two hundred dollars (\$200).
- 28.5 **Match Penalty to Goalkeeper** – Should a goalkeeper incur a match penalty, his place will then be taken by a member of his own Club, or by a substitute goalkeeper who is available, and such player will be allowed the goalkeeper's full equipment.

The match penalty, and any additional penalties assessed to the goalkeeper, shall be served immediately by a member of the team on the ice when the offenses were committed. This player shall be designated by the Manager or Coach of the offending team through the Captain. However, when the match penalty is coincidental with a match or major penalty to the opposing team, no player is required to proceed to the penalty bench to serve the goalkeeper's match penalty.

- 28.6 **Leaving Goal Crease** – A minor penalty shall be imposed on a goalkeeper who leaves the immediate vicinity of his crease during an altercation. In addition, he shall be subject to a fine of two hundred dollars (\$200) and this incident shall be reported to the Commissioner for such further disciplinary action as may be required. However, should the altercation occur in or near the goalkeeper's crease, the Referee should direct the goalkeeper to a neutral location and not assess a penalty for leaving the immediate vicinity of the goal crease. Equally, if the goalkeeper is legitimately outside the immediate vicinity of the goal crease for the purpose of proceeding to the players' bench to be substituted for an extra attacker, and he subsequently becomes involved in an altercation, the minor penalty for leaving the crease would not be assessed.

In addition, during stoppages of play in the game, he must not proceed to his players' bench for the purpose of receiving a replacement stick or equipment or repairs thereto, or due to an injury, or to receive instructions, without first obtaining permission to do so from the Referee. Otherwise, he must be replaced by the substitute goalkeeper immediately (without any delay) or be assessed a bench minor penalty for delay of game.

- 28.7 **Participating in the Play Over the Center Red Line** - If a goalkeeper participates in the play in any manner (intentionally plays the puck or checks an opponent) when he is beyond the center red line, a minor penalty shall be imposed upon him. The position of the puck is the determining factor for the application of this rule.
- 28.8 **Restricted Area** – A goalkeeper shall not play the puck outside of the designated area behind the net. This area shall be defined by lines that begin six feet (6") from either goal post and extend diagonally to points twenty-eight feet (28') apart at the end boards. Should the goalkeeper play the puck outside of the designated area behind the goal line, a minor penalty for delay of game shall be imposed. The determining factor shall be the position of the puck. The minor penalty will not be assessed when a goalkeeper plays the puck while maintaining skate contact with his goal crease.
- 28.9 **Infractions – Unique to Goalkeepers** – Refer to the Reference Tables – Table 15 – Summary of Goalkeeper Penalties (page 141) for a list of the infractions that shall result in a penalty to the goalkeeper (see specific rule numbers for complete descriptions).







Rule 29 – Supplementary Discipline

- 29.1 **Supplementary Discipline** - In addition to the automatic fines and suspensions imposed under these rules, the Commissioner may, at his discretion, investigate any incident that occurs in connection with any Pre-season, Exhibition, League or Playoff game and may assess additional fines and/or suspensions for any offense committed during the course of a game or any aftermath thereof by a player, goalkeeper, Trainer, Manager, Coach or non-playing Club personnel or Club executive, whether or not such offense has been penalized by the Referee.

If an investigation is requested by a Club or by the League on its own initiative, it must be initiated within twenty-four (24) hours following the completion of the game in which the incident occurred.

- 29.2 **Pre-Season and Exhibition Games** - Whenever suspensions are imposed as a result of infractions occurring during pre-season and exhibition games, the Commissioner shall exercise his discretion in scheduling the suspensions to ensure that no team shall be short more players in any regular League game than it would have been had the infractions occurred in regular League games.







Rule 30 – Signals

30.1	Boarding	Striking the clenched fist of one hand into the open palm of the opposite hand in front of the chest.	
30.2	Butt-ending	Moving the forearm, fist closed, under the forearm of the other hand held palm down.	
30.3	Charging	Rotating clenched fists around one another in front of the chest.	
30.4	Checking from behind	A forward motion of both arms, with the palms of the hands open and facing away from the body, fully extended from the chest at shoulder level.	
30.5	Clipping	Striking leg with either hand behind the knee, keeping both skates on the ice.	
30.6	Cross-checking	A forward and backward motion of the arms with both fists clenched, extending from the chest for a distance of about one foot.	
30.7	Delayed off-side	Non-whistle arm fully extended above the head. To nullify a delayed off-side, the Linesman shall drop the arm to the side.	



SECTION 4 – TYPES OF PENALTIES



30.8	Delayed penalty	Extending the non-whistle arm fully above the head.	
30.9	Delaying the game	The non-whistle hand, palm open, is placed across the chest and then fully extended directly in front of the body.	
30.10	Elbowing	Tapping either elbow with the opposite hand.	
30.11	Goal scored	A single point directed at the goal in which the puck legally entered.	
30.12	Hand pass	With the palm open and facing forward, a pushing motion towards the front of the body once or twice to indicate the puck was moved ahead with the hand.	
30.13	Head-butting	No signal in the National Hockey League.	NO SIGNAL
30.14	High-sticking	Holding both fists clenched, one slightly above the other (as if holding a stick) at the height of the forehead.	
30.15	Holding	Clasping either wrist with the other hand in front of the chest.	
30.16	Holding the stick	Two stage signal involving the holding signal (30.15) followed by a signal indicating you are holding	



SECTION 4 – TYPES OF PENALTIES



onto a stick with two hands in a normal manner.

30.17 Hooking

A tugging motion with both arms as if pulling something from in front toward the stomach.



30.18 Icing (a)

The back Linesman signals a possible icing by fully extending either arm over his head. The arm should remain raised until the front Linesman either blows the whistle to indicate an icing or until the icing is washed out



Icing (b)

Once the icing has been completed, the back Linesman will then point to the appropriate face-off spot and skate to it, turning backwards somewhere near the blue line and crossing his arms across his chest to indicate icing.



30.19 Interference

Crossing arms stationary in front of the chest in an "X" formation.



30.20 Kicking

No signal in the National Hockey League.

NO SIGNAL

30.21 Kneeing

Slapping either knee with the palm of the hand, while keeping both skates on the ice.



30.22 Match penalty

No signal in the National Hockey League.

NO SIGNAL



SECTION 4 – TYPES OF PENALTIES



30.23 Misconduct Both hands on hips.



30.24 Penalty shot Non-whistle arm fully extended pointing to the center ice face-off spot.



30.25 Roughing Fist clenched and arm extended out to the side of the body.



30.26 Slashing A chopping motion with the edge of one hand across the opposite forearm.



30.27 Spearing Jabbing motion with both hands thrust out immediately in front of the body and then hands dropped to the side of the body (essentially the opposite to the hooking signal – away from the body rather than towards the body).



30.28 Throwing equipment No signal in the National Hockey League.

NO SIGNAL

30.29 Time-out Using both hands to form a "T" in front of the chest.



30.30 Too many men on the ice No signal in the National Hockey League.

NO SIGNAL



SECTION 4 – TYPES OF PENALTIES



30.31 Tripping

Striking leg with either hand below the knee, keeping both skates on the ice.



30.32

Unsportsmanlike conduct

Using both hands to form a "T" in front of the chest (same as time-out).



30.33 Wash out

A sweeping sideways motion of both arms across the front of the body at shoulder level with palms down. This signal is used by Referees to signal no goal; by the Linesmen to signal no icing and no off-side; and by all Officials to wash out a hand pass or a high-sticking the puck violation.



SECTION 5 - OFFICIALS

Rule 31 – Appointment of Officials

- 31.1 **Appointment of Officials by Commissioner** - The Commissioner shall appoint the Referees, the Linesmen, Video Goal Judge and all Off-ice Officials for each game.

The Commissioner shall forward to all Clubs a list of Referees, Linesmen, and Off-ice Officials, all of whom must be treated with proper respect at all times during the season by all players and officials of Clubs.

Rule 32 – Referees

- 32.1 **Attire and Equipment** - All Referees shall be dressed in black trousers, official sweaters and a League-approved black helmet.

They shall be equipped with approved whistles, tape measure and an official stick-measuring gauge.

- 32.2 **Disputes** - The Referees shall have general supervision of the game and shall have full control of all game officials and players during the game, including stoppages; and in case of any dispute, their decision shall be final.

As there is a human factor involved in blowing the whistle to stop play, the Referee may deem the play to be stopped slightly prior to the whistle actually being blown. The fact that the puck may come loose or cross the goal line prior to the sound of the whistle has no bearing if the Referee has ruled that the play had been stopped prior to this happening.

In the event of any dispute regarding time or the expiration of penalties, the matter shall be referred to the Referee for adjustment and his decision shall be final. He may use the Video Goal Judge to assist in rendering the final decision. See Rule 39 – Video Goal Judge.

- 32.3 **Face-offs** – One of the Referees shall face-off the puck to start each period and following the scoring of a goal. Linesmen are responsible for all other face-offs.

- 32.4 **General Duties** - It shall be the duty of the Referees to impose such penalties as are prescribed by the rules for infractions thereof and they shall give the final decision in matters of disputed goals. The Referees may consult with the Linesmen, Goal Judge or Video Goal Judge before making their decision.

The Referees shall not halt the game for any infractions of the rules concerning Rule 83 - Off-side, or any violation of Rule 81 - Icing. Determining infractions of these rules is the duty of the Linesmen unless, by virtue of some accident, the Linesman is prevented from doing so in which case the duties of the Linesman shall be assumed by a Referee until play is stopped.

32.5 Goals - The Referees shall have announced over the public address system information regarding the legality of an apparent goal. The Official Scorer, with the assistance of the Video Goal Judge, will confirm the goal scorer and any players deserving of an assist. See also Rule **78** – Goals.

The Referees shall have announced over the public address system the reason for not allowing a goal every time the goal signal light is turned on in the course of play. This shall be done at the first stoppage of play regardless of any standard signal given by the Referees when the goal signal light was put on in error.

The Referees shall report to the Official Scorer the name or number of the goal scorer but he shall not give any information or advice with respect to the awarding of assists.

The name of the scorer and any player or goalkeeper entitled to an assist will be announced over the public address system. In the event that the Referee disallows a goal for any violation of the rules, he shall report the reason for the disallowance to the Official Scorer who shall have announced the Referee's decision correctly over the public address system.

32.6 Off-ice Officials - The Referees shall, before starting the game, see that the appointed off-ice officials, including the Game Timekeeper and the Goal Judges are in their respective places and ensure that the timing and signaling equipment are in order.

32.7 Penalties - The infraction of the rules for which each penalty has been imposed will be announced correctly, as reported by the Referee, over the public address system. Where players of both teams are penalized on the same play, the penalty to the visiting player will be announced first.

When a penalty is imposed by the Referee which calls for a mandatory or automatic fine, only the time portion of the penalty will be reported by the Referee to the Official Scorer and announced over the public address system, and the fine will be collected through the League office.

32.8 Players' Uniforms - It shall be the duty of the Referees to see to it that all players are properly dressed, and that the approved regulation equipment (including the approved on-ice branded exposure program) is in use at all times during the game.

32.9 Reports - The Referee shall report to the Commissioner promptly and in detail the circumstances surrounding the following:

- (i) *The assessment of misconduct penalties for abuse of officials;*
- (ii) *The assessment of game misconduct penalties;*
- (iii) *The assessment of match penalties;*
- (iv) *The assessment of an instigator penalty;*
- (v) *Any time a goalkeeper leaves his crease during an altercation;*
- (vi) *Any time a stick or other object is thrown outside the playing area;*

- (vii) *Any time a player, goalkeeper or non-playing Club personnel are involved in an altercation with a spectator;*
- (viii) *Any unusual occurrence that takes place on or off the ice, before, during or after the game.*

32.10 Start and End of Game and Periods - The Referees shall order the teams on the ice at the appointed time for the beginning of a game and at the commencement of each period. If for any reason, there is more than a fifteen (15) minute delay in the commencement of the game or any undue delay in resuming play after the League approved intermission length between periods, the Referees shall state in their report to the Commissioner the cause of the delay and the Club or Clubs which were at fault.

The Referees shall remain on the ice at the conclusion of each period until all players have proceeded to their dressing rooms.

The Referees shall check club rosters and all players in uniform before signing the Official Report of Match form.

32.11 Unable to Continue - Should a Referee accidentally leave the ice or receive an injury which incapacitates him from discharging his duties while play is in progress, the game shall be automatically stopped. If the Referee is unable to continue, the game shall continue using the one Referee, two Linesmen system.

If, owing to illness or accident, one of the Referees is unable to continue to officiate, the remaining Referee shall perform the duties of the ill or injured Referee during the balance of the game. In the event that a member of the League's Hockey Operations or Officiating departments is in attendance at a game where a spare official is present, he shall have the authority to substitute the injured Referee with the spare official.

If, through misadventure or sickness, the Referees and Linesmen appointed are prevented from appearing, the League will make every attempt to find suitable replacement officials, otherwise, the Managers or Coaches of the two Clubs shall agree on Referee(s) and Linesman(men). If they are unable to agree, they shall appoint a player from each side who shall act as Referee and Linesman; the player of the home Club acting as Referee and the player of the visiting Club as Linesman.

If the regularly appointed officials appear during the progress of the game, they shall at once replace the temporary officials.

Rule 33 – Linesmen

33.1 Attire and Equipment – All Linesmen shall be dressed in black trousers, official sweaters and a League-approved black helmet.

They shall be equipped with approved whistles, tape measure and an official stick-measuring gauge.

- 33.2 **Face-offs** - The Linesman shall face-off the puck at all times except at the start of each period and following the scoring of a goal.
- 33.3 **General Duties** – The Linesmen are generally responsible for calling violations of off-side (Rule 83) and icing (Rule 81). They may stop play for a variety of other situations as noted in sections 33.4 and 33.5 below.
- 33.4 **Reporting to Referee** - The Linesman shall give to the Referees his interpretation of any incident that may have taken place during the game.

The Linesman may stop play and report what he witnessed to the Referees when:

- | | | |
|-------|--|---------|
| (i) | <i>There are too many men on the ice</i> | Rule 74 |
| (ii) | <i>Articles are thrown on the ice from the players' bench or penalty bench</i> | Rule 75 |
| (iii) | <i>When team personnel interfere with a game official</i> | Rule 40 |
| (iv) | <i>When a player or goalkeeper who has lost or broken his stick receives one illegally</i> | Rule 10 |

The Linesman must report upon completion of play, any circumstances pertaining to:

- | | | |
|--------|--|---------|
| (i) | <i>Major penalties</i> | Rule 20 |
| (ii) | <i>Match penalties</i> | Rule 21 |
| (iii) | <i>Misconduct penalties</i> | Rule 22 |
| (iv) | <i>Game Misconduct penalties</i> | Rule 23 |
| (v) | <i>Abuse of Officials</i> | Rule 40 |
| (vi) | <i>Physical Abuse of Officials</i> | Rule 41 |
| (vii) | <i>Unsportsmanlike Conduct</i> | Rule 75 |
| (viii) | <i>Double-minor penalty when it is apparent that an injury has resulted from a high-stick that has gone undetected by the Referees</i> | Rule 60 |

Should a Linesman witness a foul (above) committed by an attacking player or goalkeeper (undetected by the Referees) prior to the attacking team scoring a goal, the Linesman shall report what he witnessed to the Referees, the goal shall be disallowed and the appropriate penalty assessed.

- 33.5 **Stopping Play** - The Linesman shall stop play:

- | | | |
|-------|--|---------|
| (i) | <i>When premature substitution of the goalkeeper has occurred</i> | Rule 71 |
| (ii) | <i>When he deems that a player or goalkeeper has sustained a serious injury and this has gone undetected by either of the referees</i> | Rule 8 |
| (iii) | <i>For encroachment into the face-off area</i> | Rule 76 |



- | | | |
|--|----------------|----------------|
| (iv) <i>When the puck has been directed with a hand to a teammate in any zone other than the defending zone and this has gone undetected by either of the Referees</i> | <i>Rule 79</i> | |
| (v) <i>When the puck is struck by a stick above the normal height of the shoulders and this has gone undetected by either of the Referees</i> | <i>Rule 80</i> | |
| (vi) <i>When either team ices the puck</i> | <i>Rule 81</i> | |
| (vii) <i>When there has been interference by/with spectators</i> | <i>Rule 23</i> | |
| (viii) <i>For any infraction of the rules concerning off-side play at the blue line</i> | <i>Rule 83</i> | |
| (ix) <i>When the puck is out of bounds or unplayable</i> | <i>Rule 85</i> | |
| (x) <i>When a goal has been scored that has not been observed by the Referees.</i> | <i>Rule 78</i> | |
| (xi) <i>When the puck is interfered with by an ineligible player/person</i> | <i>Rule 5</i> | <i>Rule 78</i> |
| | <i>Rule 74</i> | <i>Rule 84</i> |
| (xii) <i>The calling of a penalty shot under</i> | <i>Rule 53</i> | |

33.6 Unable to Continue - Should a Linesman appointed be unable to act at the last minute or through sickness or accident be unable to finish the game, the Referees shall have the power to appoint another in his stead, if they deem it necessary, or if required to do so by the Manager or Coach of either of the competing teams. If no replacement Linesman is available, the two Referees will assist the remaining Linesman with his duties while still retaining their ability to assess penalties when deemed appropriate.

Rule 34 – Official Scorer

34.1 General Duties - Before the start of the game, the Official Scorer shall obtain from the Manager or Coach of both teams a list of all eligible players and the starting line-up of each team, which information shall be made known to the opposing Manager or Coach before the start of play.

The Official Scorer shall secure the names of the Captain and Alternate Captains from the Manager or Coach at the time the line-ups are collected and will indicate those nominated by placing the letter "C" or "A" opposite their names on the Official Report of Match form.

The Official Scorer shall keep a record of the goals scored, the scorers, and players to whom assists have been credited and shall indicate those players on the lists who have actually taken part in the game.

At the conclusion of the game, the Official Scorer shall complete and sign the Score Sheet form and forward same to the League office.

The Official Scorer shall prepare the Official Report of Match form

for signature by the Referees and forward it to the League office together with the Score Sheet and the Penalty Record forms.

Under the Report of Match section, the Official Scorer must explain if the start of the game is delayed for any reason, any goalkeeper substitutions, time-outs, empty net goals, any delays in the playing of the game due to injury or television, etc.

- 34.2 **Goals and Assists** - The Official Scorer shall award the points for goals and assists and his decision shall be final. The Official Scorer shall use the Video Goal Judge system to verify the proper awarding of goals and assists. The awards of points for goals and assists shall be announced twice over the public address system and all changes in such awards shall also be announced in the same manner.

No requests for changes in any award of points shall be considered unless they are made at or before the conclusion of actual play in the game by the Team Captain, or immediately following the game by a Team representative.

In the event that the Video Goal Judge reviews a play and a goal is awarded even though play went for any period of time, the Official Scorer awards the goal and any assists at the time the goal was scored. If he is unsure, he must check with the Video Goal Judge. The Game Timekeeper and the Penalty Timekeeper must also be informed in order to adjust the clock and the penalty clocks accordingly.

A goal is awarded to the last player on the scoring team to touch the puck prior to the puck entering the net. (A puck entering the net is considered to be between the posts, from in front of, and below the crossbar, and entirely across the goal line.)

An assist is awarded to the player or players (maximum two) who touches the puck prior to the goal scorer, provided no defender plays or possesses the puck in between.

- 34.3 **Line-ups** - It is the policy of the National Hockey League that the Coach of the visiting club provide to the Official Scorer, a list of eligible players, his starting line-up and designated Captain and Alternates, within five (5) minutes of the completion of the warm-up (twenty (20) minutes prior to face-off).

This twenty (20) minutes gives the Official Scorer time to obtain the completed home team line-up, return it to the visiting Coach and provide a copy of both line-ups to the Referees.

The Official Scorer should have an off-ice crew member assist him in order to save time and complete these duties.

The Official Scorer must file a report to the Commissioner or his designate if either Coach fails to cooperate within these recommended guidelines. This report should be forwarded to the National Hockey League Toronto office.

- 34.4 **Location** - The Official Scorer should view the game from an elevated position, well away from the players' benches, with house telephone



communication to the public address announcer. He should also have access to a television monitor to aid in the awarding of points. He must have access to the Video Goal Judge.

- 34.5 **Penalties** - The Official Scorer must help the Penalty Timekeeper with the numbers of the players on the ice, in the event a goalkeeper is assessed a penalty or a player is ejected from a game. He must also keep an eye on the players' benches during an altercation and record the numbers of any players who leave their respective players' or penalty benches and in the order that they so leave.

Rule 35 – Game Timekeeper

- 35.1 **General Duties** – The Game Timekeeper shall record the time of starting and finishing of each period in the game. During the game the Game Timekeeper will start the clock with the drop of the puck and stop the clock upon hearing the officials' whistle or the scoring of a goal.

The Game Timekeeper shall cause to be announced over the public address system at the nineteenth minute in each period that there is one minute remaining to be played in the period.

- 35.2 **Intermissions** - For the purpose of keeping the spectators informed as to the time remaining during intermissions, the Game Timekeeper will use the electronic clock to record the length of intermissions. The clock will start for the intermission immediately at the conclusion of the period.

Intermissions are seventeen minutes (17:00) in length, unless otherwise notified. If there are unusual delays for any reason, (e.g. building, ice, or ice resurfacing problems) it is important to use discretion in starting the clock.

- 35.3 **Overtime** - In the event of overtime in the regular season, the Game Timekeeper shall record a one (1) minute rest period on the clock. This time shall commence immediately following the end of the period. The rest period will be followed with a five (5) minute, sudden victory overtime period.

During overtime in the play-offs, each intermission will be completed in a normal manner.

- 35.4 **Signal Devices** - If the arena is not equipped with an automatic signaling device or, if such device fails to function, the Game Timekeeper shall signal the end of each period by blowing a whistle.
- 35.5 **Start of Periods** - The Game Timekeeper shall signal the Referees and the competing teams for the start of the game and each succeeding period and the Referees shall start the play promptly in accordance with Rule 77 – Game and Intermission Timing.

To assist in ensuring the prompt return to the ice of the teams and the officials, the Game Timekeeper shall give preliminary warnings of

five (5) minutes and two (2) minutes prior to the resumption of play in each period.

- 35.6 **Television** - The Game Timekeeper is required to synchronize his timing device with the television producer of the originating broadcast.
- 35.7 **Verification of Time** - Any loss of time on the game or penalty clocks due to a false face-off must be replaced as appropriate. The Video Goal Judge may be consulted to ensure the time is accurately replaced.

In the event of any dispute regarding time, the matter shall be referred to the Referees for adjudication and their decision shall be final. They may use the Video Goal Judge to assist in rendering their final decision. (See Rule 39 – Video Goal Judge.) The Game Timekeeper shall assist to verify game time using an additional timing device (League-approved stopwatch).

In the event that clock fails to operate when play resumes, the on-ice officials may elect to stop play provided there is no imminent scoring opportunity or wait until the next legitimate stoppage of play. In cooperation with the Game Timekeeper and the Video Goal Judge, the clock is to be re-set to the appropriate time.

In the event that a video replay shows a goal was scored prior to the play being stopped, the Video Goal Judge will inform the Game Timekeeper and Official Scorer of the time of goal and the amount of playing time left to be reset on the game clock.

Rule 36 – Penalty Timekeeper

- 36.1 **General Duties** – The Penalty Timekeeper shall keep, on the Penalty Record form, a correct record of all penalties imposed by the Referees including the names of the players penalized, the penalties assessed, the duration of each penalty and the time at which each penalty was imposed.

The Penalty Timekeeper shall inform penalized players and the Penalty Box Attendants as to the correct expiration time of all penalties. In the event of a dispute regarding the time a player is permitted to return to the ice, the game clock is the determining time clock. For example, a player is assessed a minor penalty at the 12:00 mark. A stoppage of play occurs at the 10:00 mark, however, the penalty time clock shows one second remaining in the penalty. Since the game clock is the determining time clock, the penalized player shall be permitted to return to the ice.

The infraction of the rules for which each penalty has been imposed will be announced twice over the public address system as reported by the Referee. Where players of both teams are penalized at the same time, the penalty to the visiting player will be announced first. In situations where multiple game misconducts have been assessed to any one player at the same stoppage of play, only one game misconduct should be announced.

Misconduct penalties and coincident major penalties should not be recorded on the timing device (penalty time clock) but such penalized players should be alerted and released at the first stoppage of play following the expiration of their penalties.

If a player leaves the penalty bench before the time has expired, the Penalty Timekeeper must note the time and notify the Referees at his first opportunity.

It is the responsibility of the Penalty Timekeeper to ensure that penalized players return to the penalty box before the puck is dropped for the start of a new period. In the event that a player should not be in the box, the Penalty Timekeeper should notify the Referees and prevent the game from resuming until the player is there.

- 36.2 **Equipment** - The Penalty Timekeeper shall have an official stick-measuring gauge and tape measure available for the Referees use during the game.
- 36.3 **Goalkeeper's Penalties** - In the event that a goalkeeper is penalized, the penalty shall be served by another member of his team who was on the ice when the offense was committed. Communication with the Official Scorer and/or Real Time Scorers is important at this time as they can inform the Penalty Timekeeper who was actually on the ice to ensure only the proper players can serve the time.
- 36.4 **Penalty Shot** - He shall report on the Penalty Record form each penalty shot awarded, the name of the player taking the shot and the result of the shot.
- 36.5 **Penalty Time Clock** - He shall be responsible for the correct posting of penalties on the scoreboard at all times and shall promptly call to the attention of the Referees any discrepancy between the time recorded on the clock and the official correct time and he shall be responsible for making any adjustments ordered by the Referees.

In the event that two players from one team and one player from the opposing team are penalized at the same time, the Penalty Timekeeper shall request through the Referee or the offending team's Captain, which penalty they prefer to have on the timing device.

- 36.6 **Reports** – Prior to each game, the Penalty Timekeeper shall obtain copies of the Instigator, Aggressor & Game Misconduct List provided by the League, retain one copy and provide one to the Referees. Should a player or goalkeeper be assessed a penalty that would result in an automatic suspension, this must be conveyed to the Referee at the time the penalty is assessed to ensure a Game Misconduct penalty is applied.

Upon the completion of each game, the Penalty Timekeeper shall complete and sign the Penalty Record form and forward same to the League office.

The Officiating Department shall be entitled to inspect, collect and forward to the League office the actual worksheets used by the Penalty Timekeeper in any game.

When a player or goalkeeper is ejected from a game, the Penalty Timekeeper must complete a report of the incident (Off-Ice Officials Report of Game Misconduct/Match Penalties). When there are more than one of these incidents, it is imperative to provide the Referee with accurate information for each incident so that his report(s) to the League office is correct.

- 36.7 **Stick Measurements** - He shall also record on the Penalty Record form the details and the result of any stick measurement performed by the Referees during the game.
- 36.8 **Verification of Time** - In the event that a goal is awarded by video review even though play continued, the Penalty Timekeeper must adjust any existing penalties, according to the situation. The clock must revert back to the original time the goal was scored. If a penalty was in the process of being called, it will revert back to that time also.

Rule 37 – Goal Judge

- 37.1 **General Duties** - He shall signal, normally by means of red light, his decision as to whether the puck passed between the goal posts and entirely over the goal line. His only decision is whether the puck actually entered the net, not how or when it went in. The light must be illuminated each time the puck enters the net regardless of circumstances. It is up to the Referees and/or Video Goal Judge to decide if it is a goal.

In concluding that the puck has indeed entered the net, the Goal Judge shall indicate so by illuminating the red light and holding it on to a count of five, allowing other off-ice and on-ice officials to see that the puck has entered the net.

- 37.2 **Communication** - The Goal Judge must be connected to the penalty bench by a form of communication (usually phone) in the event that the Referees finds it necessary to consult with him.
- 37.3 **Location** - There shall be one Goal Judge situated behind each goal. Goal Judges shall be stationed behind the goals during the progress of play, in properly protected areas, if possible, so that there can be no interference with their activities. They shall not change goals during the game.

Rule 38 – Real Time Scorers

- 38.1 **General Duties** – The duty of the Real Time Scorers is to correctly record electronically all of the required data concerning the performances of the individual players and the teams.

This data shall be compiled and recorded in strict conformity with the instructions provided by the League.

- 38.2 **Real Time Scorers** – There shall be appointed for duty at every game played in the League the following Real Time Scorers:

- (i) *Shot Scorer*
- (ii) *Action Scorer*
- (iii) *Penalty Scorer*
- (iv) *Time on ice – Home*
- (v) *Time on ice – Visitor*
- (vi) *Spotter*

38.3 Reports – Reports shall be generated at the end of each period and given to the each team’s Public Relations representative by the Real Time Scoring Manager for distribution to the media and the Coaches. These reports are known as the Event Summary and the Game Summary.

Rule 39 – Video Goal Judge

39.1 General Duties – The following are the general duties of the Video Goal Judge:

- (i) *He will review replays of disputed goals when requested to do so by the Referees.*
- (ii) *He will review replays of disputed goals when he observes an incident that was undetected by on-ice officials.*
- (iii) *After viewing the incident he will promptly convey his decision directly to the Referee at the penalty bench. When a play has been referred to the Video Goal Judge, his decision shall be final.*
- (iv) *During the review he may consult with a member of the League’s Hockey Operations or Officiating department staff if latter is in attendance at the game (or via telephone).*
- (v) *No goal may be awarded (or disallowed) as a result of video review once the puck has been dropped and play has resumed following the first stoppage of play after the potential goal.*

39.2 Goals – Every goal is to be reviewed by the Video Goal Judge.

Upon making contact with the off-ice official at ice level, the Video Goal Judge should say initially that he is “looking at the play”. If there is a need to delay the resumption of the play, the off-ice official at ice level should signal one of the Referees to delay the center ice face-off for a moment. Once the Video Goal Judge has reviewed the video and confirmed that the goal is valid, he should say that “it is a good goal”. The off-ice official will then signal to the Referee to resume play.

If there is a need to expand the review, the Video Goal Judge will advise the off-ice official at ice level and the Public Address Announcer that the “play is under review”. Once the play has been reviewed and deemed a goal, the goal will be announced in the normal manner. If the review reveals that the goal must be disallowed, the Public Address Announcer shall announce the reason for the disallowed goal as reported by the Referee.

When the Video Goal Judge observes an incident involving a

potential goal that was undetected by the on-ice officials he will contact the Referee at the first stoppage of play and inform him that a review of the play is in progress.

When a review is requested by either the Referee or Video Goal Judge, the Public Address Announcer shall make the following announcement: "The play is under review".

The Video Goal Judge will use all the facilities at his disposal to review the incident and reach a conclusion as to the accurate time of the goal. It is the responsibility of the Video Goal Judge to record the time of the disputed goal and the clock is to be reset accordingly.

He will report his findings to the Referee as quickly as possible ensuring all available video feeds and angles have been reviewed.

When the Referee indicates there is to be a video review, all players (with the exception of the goalkeepers) will go to their respective players' bench immediately and failure to do so would result in a game misconduct penalty with a fine to the Coach.

- 39.3 Reports** - Following every game, the Video Goal Judge must call the National Hockey League Toronto office and provide a verbal report of all video reviews conducted during the game.

Video Goal Judge reports are to be faxed or sent electronically to the National Hockey League Toronto office immediately following the game.

- 39.4 Situations Subject to Video Review** - The following situations are subject to review by the Video Goal Judge:

- (i) *Puck crossing the goal line.*
- (ii) *Puck in the net prior to the goal frame being dislodged.*
- (iii) *Puck in the net prior to, or after expiration of time at the end of the period.*
- (iv) *Puck directed or batted into the net by a hand or foot. With the use of a foot/skate, was a distinct kicking motion evident? If so, the apparent goal must be disallowed. A DISTINCT KICKING MOTION is one which, with a pendulum motion, the player propels the puck with his skate into the net. If the Video Goal Judge determines that it was put into the net by an attacking player using a distinct kicking motion, it must be ruled NO GOAL. This would also be true even if the puck, after being kicked, deflects off any other player of either team and then into the net. This is still NO GOAL. See also 49.2 and 67.6.*
- (v) *Puck deflected directly into the net off an Official.*
- (vi) *Puck struck with a high-stick, above the height of the crossbar, by an attacking player prior to entering the goal. The determining factor is where the puck makes contact with the stick. If the puck makes contact with the stick below the level of the crossbar and enters the goal, this goal shall be allowed.*
- (vii) *To establish the correct time on the official game clock, provided the game time is visible on the Video Goal Judge's monitors.*
- (viii) *The video review process shall be permitted to assist the referees in*

determining the legitimacy of all potential goals (e.g. to ensure they are “good hockey goals”).

- 39.5 Logistics and Equipment** - The Video Goal Judge must be located in a secluded area in the upper level of the building with an unobstructed view of both goals. The location must be large enough to seat three people (Video Goal Judge, Video Technician and Supervisor of Officials) and have space for necessary monitors, replay and recording equipment.

The Video Goal Judge shall have access to all replays that may be available by reason of any telecasts of the game and if there is no scheduled telecast the Club's internal telecast of the game will be used.

The Video Goal Judge must be supplied with a phone or communication system with direct contact to the penalty bench.

The “burn in” of the game clock is mandatory for the two overhead goal video feeds, and should be available on all feeds if such can be provided by the host broadcaster.

- 39.6 Verification of Time** - Any loss of time on the game or penalty clocks due to a false face-off must be replaced. The Video Goal Judge may be consulted to ensure the time is accurately replaced.

In the event of any dispute regarding time, the matter shall be referred to the Referee for adjustment and his decision shall be final. The Game Timekeeper shall assist to verify game time via an additional timing device. (NHL approved stop watch)

In accordance with Rule **39** – Video Goal Judge, the Officials may use the Video Goal Judge system to establish the correct time on the official game clock, provided the game time is visible on the Video Goal Judge's monitors.

In the event that a video replay shows a goal was scored prior to the play being stopped, the Video Goal Judge will inform the Game Timekeeper and Official Scorer of the time of goal and the amount of playing time left to be reset on the game clock.

Should the first stoppage of play following an apparent goal coincide with the end of a period, the on-ice officials must instruct both teams to remain at their respective players' benches until the video review has been completed.

Rule 40 – Abuse of Officials

- 40.1 General Description** – A player, goalkeeper, Coach or non-playing person shall not challenge or dispute the rulings of an official before, during or after a game. A player, goalkeeper, Coach or non-playing person shall not display unsportsmanlike conduct including, but not limited to, obscene, profane or abusive language or gestures, comments of a personal nature intended to degrade an official, or

persist in disputing a ruling after being told to stop or after being penalized for such behavior.

NOTE: When such conduct is directed at anyone other than an official, Rule **75** – Unsportsmanlike Conduct shall be applied.

40.2 Minor Penalty – A minor penalty for unsportsmanlike conduct shall be assessed under this rule for the following infractions:

- (i) *Any player or goalkeeper who challenges or disputes the ruling of an official.*
- (ii) *Any identifiable player or goalkeeper who uses obscene, profane or abusive language or gestures directed at any on or off-ice official.*
- (iii) *Any player or players (including goalkeepers) who bang the boards with their sticks or other objects at any time, or who, in any manner show disrespect for an official's decision. If this is done in order to get the attention of the on-ice officials for a legitimate reason (i.e. serious injury, illness, etc.), then discretion must be exercised by the Referees.*
- (iv) *When a Captain, Alternate Captain or any other player or goalkeeper comes off the players' bench to question or protest a ruling by an official on the ice.*
- (v) *If a player or goalkeeper bangs the glass in protest of the Goal Judge's ruling. If he persists, a misconduct penalty would then be assessed.*

40.3 Bench Minor Penalty - A bench minor penalty for unsportsmanlike conduct shall be assessed under this rule for the following infractions:

- (i) *Any Coach or non-playing person who bangs the boards with a stick or other object at any time, showing disrespect for an official's decision. If this is done in order to get the attention of the on-ice officials for a legitimate reason (i.e. serious injury, illness, etc.), then discretion must be exercised by the Referees.*
- (ii) *Any unidentifiable player or goalkeeper, or any Coach or non-playing person who uses obscene, profane or abusive language or gesture directed at an on or off-ice official or uses the name of any official coupled with any vociferous remarks. (see also **40.5 (ii)**)*
- (iii) *Any player, goalkeeper, Coach, or non-playing person interferes in any manner with any game official including the Referees, Linesmen, Game or Penalty Timekeepers or Goal Judges in the performance of their duties.*

40.4 Misconduct Penalty – Misconduct penalties shall be assessed under this rule for the following infractions:

- (i) *Once a penalized player has entered the penalty bench and play has resumed, if he challenges or disputes the ruling of an official, he is to be assessed a misconduct penalty.*
- (ii) *Any player or goalkeeper who persists in the use of obscene, profane or abusive language towards any on or off-ice official for which he has already been assessed a minor or bench minor penalty for unsportsmanlike conduct.*
- (iii) *Any player or goalkeeper who intentionally knocks or shoots the puck out of the reach of an official who is retrieving it.*

- (iv) *Any player or goalkeeper who, after being assessed an unsportsmanlike conduct minor penalty, persists in challenging or disputing the ruling of an official.*
- (v) *Any player or players (including goalkeepers) who bang the boards with their sticks or other objects at any time, showing disrespect for an official's decision, for which they have already been assessed a minor or bench minor penalty for unsportsmanlike conduct.*
- (vi) *Any player or players who, except for the purpose of taking their positions on the penalty bench, enter or remain in the Referee's crease while he is reporting to or consulting with any game official including the other Referee, the Linesmen, Game Timekeeper, Penalty Timekeeper, Official Scorer or Public Address Announcer.*
- (vii) *A misconduct penalty (or game misconduct penalty at the discretion of the Referee) shall be imposed on any player or goalkeeper who deliberately throws any equipment out of the playing area. When this is done in protest of an official's ruling, a minor penalty plus a game misconduct shall be assessed (see 40.5).*
- (viii) *If a player or goalkeeper who, after previously being assessed a minor penalty for unsportsmanlike conduct for banging the glass in protest of the Goal Judge's ruling, shall be assessed a misconduct penalty.*

40.5 Game Misconduct Penalty – Game misconduct penalties shall be assessed under this rule for the following infractions:

- (i) *Any player or goalkeeper who, after being assessed a misconduct penalty, persists in challenging or disputing the ruling of an official.*
- (ii) *When a Coach or non-playing person uses obscene, profane or abusive language or gesture directed at any on or off-ice official or uses the name of any official coupled with any vociferous remarks, after already being assessed a bench minor penalty (40.3 (ii)), this Coach or non-playing person is to be assessed a game misconduct and the situation reported to the Commissioner for further action. When this type of conduct occurs after the expiration of the game, on or off the ice, the game misconduct shall be applied without the necessity of having been assessed a bench minor penalty previously.*
- (iii) *Any player or goalkeeper who deliberately applies physical force in any manner against an official, in any manner attempts to injure an official, physically demeans, or deliberately applies physical force to an official solely for the purpose of getting free of such an official during or immediately following an altercation shall receive a game misconduct penalty and the guidelines set out in Rule 41 – Physical Abuse of Officials are to be applied.*
- (iv) *Any player who, having entered the penalty bench, leaves the penalty bench prior to the expiration of his penalty for the purpose of challenging an official's ruling, shall be assessed a game misconduct penalty. He shall also be automatically suspended for the next three (3) regular League and/or Play-off games of his Club. This rule does not replace any other more severe penalty that may be imposed for leaving the penalty bench for the purpose of starting or participating in an altercation. See Rule 70 – Leaving the Bench.*
- (v) *A minor penalty for unsportsmanlike conduct plus a game misconduct shall be imposed on a player or goalkeeper who throws*

his stick or any part thereof, or any other piece of equipment or object outside the playing area in protest of an official's decision.

- (vi) *Any player, goalkeeper, Coach or non-playing person who throws or shoots any equipment or other object in the general direction of an official but does not come close to making any contact. This action may occur on or off the ice.*

Any player, goalkeeper, Coach or non-playing Club personnel penalized under this section may be subject to supplemental discipline under Rule 29.

- 40.6 **Reports** - It is the responsibility of all game officials and all club officials to send a confidential report to the Commissioner setting out the full details concerning the use of obscene gestures or language by any player, goalkeeper, Coach or non-playing Club personnel. The Commissioner shall take such further disciplinary action as he shall deem appropriate.

Rule 41 – Physical Abuse of Officials

- 41.1 **Game Misconduct** - Any player or goalkeeper who deliberately applies physical force in any manner against an official, in any manner attempts to injure an official, physically demeans, or deliberately applies physical force to an official solely for the purpose of getting free of such an official during or immediately following an altercation shall receive a game misconduct penalty.
- 41.2 **Automatic Suspension – Category I** - Any player or goalkeeper who deliberately strikes an official and causes injury or who deliberately applies physical force in any manner against an official with intent to injure, or who in any manner attempts to injure an official shall be automatically suspended for not less than twenty (20) games. (For the purpose of the rule, "intent to injure" shall mean any physical force which a player or goalkeeper knew or should have known could reasonably be expected to cause injury.)
- 41.3 **Automatic Suspension – Category II** - Any player or goalkeeper who deliberately applies physical force to an official in any manner (excluding actions as set out in Category I), which physical force is applied without intent to injure, or who spits on an official, shall be automatically suspended for not less than ten (10) games.
- 41.4 **Automatic Suspension – Category III** - Any player or goalkeeper who, by his actions, physically demeans an official or physically threatens an official by (but not limited to) throwing a stick or any other piece of equipment or object at or in the general direction of an official, shooting the puck at or in the general direction of an official, spitting at or in the general direction of an official, or who deliberately applies physical force to an official solely for the purpose of getting free of such an official during or immediately following an altercation shall be suspended for not less than three (3) games.
- 41.5 **Automatic Suspension – Process** - Immediately after the game in which such game misconduct penalty is imposed, the Referees shall,

in consultation with the Linesmen, decide the category of the offense. They shall make a verbal report to the League's Director of Hockey Operations and advise of the category and of the offense. In addition, they shall file a written report to the Director of Hockey Operations in which they may request a review as to the adequacy of the suspension. The NHLPA, the player or goalkeeper and the Club involved shall be notified of the decision of the Referees on the morning following the game. The League will then hold a conference call with the NHLPA to review the Referees application of this rule, and will refrain from issuing public comment affirming the Referees application of Rule 41 until that call is complete.

The player, goalkeeper or the officials may request the Commissioner to review, subject to the provisions of this rule, the penalty imposed by the Referees. Such request must be filed with the Commissioner in writing not later than seventy-two (72) hours following notification of the penalty.

If a review of the incident is requested by either the player, goalkeeper or by the officials, a hearing will be conducted by the Commissioner on an expedited basis, and best efforts will be used to provide a hearing before the second game missed by the player or goalkeeper due to the automatic suspension imposed under this rule. The player or goalkeeper's suspension shall continue pending the outcome of the hearing by the Commissioner.

For Category III offenses only, the Commissioner may conduct the hearing by telephone. For Category I and II offenses, the hearing shall be conducted in person.

After any review as called for hereby, the Commissioner shall issue an order that:

- (i) *sustaining the minimum suspension, or*
- (ii) *increasing the number of games within the category, or*
- (iii) *changing to a lower category, or*
- (iv) *changing to a lower category and increasing the number of games within this category, or*
- (v) *in the case of a Category III suspension only, reducing the number of games of the suspension.*

The penalties imposed under this rule shall not be deemed to limit the right of the Commissioner with respect to any action that he might otherwise take pursuant to Article 18 of the CBA.

- 41.6 **Supplementary Discipline** - In the event that the player or goalkeeper has committed more than one offense under this rule, in addition to the penalties imposed under this offense, his case shall be referred to the Commissioner of the League for consideration of supplementary disciplinary action.
- 41.7 **Coach or Non-Playing Club Personnel** - Any Manager, Coach or non-playing Club personnel who holds or strikes an official shall be automatically suspended from the game, ordered to the dressing room



and the matter will be reported to the Commissioner for further disciplinary action.

- 41.8 **Police Protection and Security** - All Clubs shall provide adequate police or other protection for all players, goalkeepers and officials at all times.

The Referee shall report to the Commissioner any failure of this protection observed by him or reported to him with particulars of such failure.

SECTION 6 – PHYSICAL FOULS

Rule 42 - Boarding

42.1 Boarding – A boarding penalty shall be imposed on any player or goalkeeper who checks an opponent in such a manner that causes the opponent to be thrown violently in the boards. The severity of the penalty, based upon the degree of violence of the impact with the boards, shall be at the discretion of the Referee.

There is an enormous amount of judgment involved in the application of this rule by the Referees. The onus is on the player (or goalkeeper) applying the check to ensure his opponent is not in a vulnerable position and if so, he must avoid the contact. However, there is also a responsibility on the player with the puck to avoid placing himself in a dangerous and vulnerable position. This balance must be considered by the Referees when applying this rule.

Any unnecessary contact with a player playing the puck on an obvious “icing” or “off-side” play which results in that player being knocked into the boards is “boarding” and must be penalized as such. In other instances where there is no contact with the boards, it should be treated as “charging.”

42.2 Minor Penalty – The Referee, at his discretion, may assess a minor penalty, based on the degree of violence of the impact with the boards, to a player or goalkeeper guilty of boarding an opponent.

42.3 Major Penalty – The Referee, at his discretion, may assess a major penalty, based on the degree of violence of the impact with the boards, to a player or goalkeeper guilty of boarding an opponent (see **42.5**).

42.4 Match Penalty – The Referee, at his discretion, may assess a match penalty if, in his judgment, the player or goalkeeper attempted to or deliberately injured his opponent by boarding.

42.5 Game Misconduct Penalty - When a major penalty is imposed under this rule for a foul resulting in an injury to the face or head of an opponent, a game misconduct shall be imposed.

42.6 Fines and Suspensions - Any player or goalkeeper who incurs a total of two (2) game misconducts under Rule **42** and/or Rule **44**, in either Regular season or Play-offs, shall be suspended automatically for the next game of his team. For each subsequent game misconduct penalty the automatic suspension shall be increased by one game.

When a major penalty is imposed under this rule, an automatic fine of one hundred dollars (\$100) shall be imposed.

If deemed appropriate, supplementary discipline can be applied by the Commissioner at his discretion (refer to Rule **29**).

Rule 43 - Charging

- 43.1 **Charging** - A minor or major penalty shall be imposed on a player or goalkeeper who skates or jumps into, or charges an opponent in any manner.

Charging shall mean the actions of a player or goalkeeper who, as a result of distance traveled, shall violently check an opponent in any manner. A “charge” may be the result of a check into the boards, into the goal frame or in open ice.

A minor, major or a major and a game misconduct shall be imposed on a player who charges a goalkeeper while the goalkeeper is within his goal crease.

A goalkeeper is not “fair game” just because he is outside the goal crease area. The appropriate penalty should be assessed in every case where an opposing player makes unnecessary contact with a goalkeeper. However, incidental contact, at the discretion of the Referee, will be permitted when the goalkeeper is in the act of playing the puck outside his goal crease provided the attacking player has made a reasonable effort to avoid such contact.

- 43.2 **Minor Penalty** - The Referee, at his discretion, may assess a minor penalty, based on the degree of violence of the check, to a player or goalkeeper guilty of charging an opponent.
- 43.3 **Major Penalty** – The Referee, at his discretion, may assess a major penalty, based on the degree of violence of the check, to a player or goalkeeper guilty of charging an opponent (see **43.5**).
- 43.4 **Match Penalty** – The Referee, at his discretion, may assess a match penalty if, in his judgment, the player or goalkeeper attempted to or deliberately injured his opponent by charging.
- 43.5 **Game Misconduct Penalty** - When a major penalty is imposed under this rule for a foul resulting in an injury to the face or head of an opponent, a game misconduct shall be imposed.
- 43.6 **Fines and Suspensions** – When a major penalty and a game misconduct is assessed for a foul resulting in an injury to the face or head of an opponent, an automatic fine of one hundred dollars (\$100) shall be imposed.

If deemed appropriate, supplementary discipline can be applied by the Commissioner at his discretion (refer to Rule **29**).

Rule 44 – Checking from Behind

- 44.1 **Checking from Behind** – A check from behind is a check delivered on a player who is not aware of the impending hit, therefore unable to protect or defend himself, and contact is made on the back part of the body. When a player intentionally turns his body to create contact with his back, no penalty shall be assessed.

- 44.2 **Minor Penalty** - There is no provision for a minor penalty for checking from behind.
- 44.3 **Major Penalty** – Any player or goalkeeper who cross-checks, pushes or charges from behind an opponent who is unable to protect or defend himself, shall be assessed a major penalty. This penalty applies anywhere on the playing surface (see **44.5**).
- 44.4 **Match Penalty** - The Referee, at his discretion, may assess a match penalty if, in his judgment, the player or goalkeeper attempted to or deliberately injured his opponent by checking from behind.
- 44.5 **Game Misconduct** – A game misconduct penalty must be assessed anytime a major penalty is applied for checking from behind.
- 44.6 **Fines and Suspensions** - Any player or goalkeeper who incurs a total of two (2) game misconducts under Rule **42** and/or Rule **44**, in either the Regular season or Play-offs, shall be suspended automatically for the next game of his team. For each subsequent game misconduct penalty the automatic suspension shall be increased by one game.

If deemed appropriate, supplementary discipline can be applied by the Commissioner at his discretion (refer to Rule **29**).

Rule 45 - Clipping

- 45.1 **Clipping** - Clipping is the act of throwing the body, from any direction, across or below the knees of an opponent.
- A player or goalkeeper may not deliver a check in a “clipping” manner, nor lower his own body position to deliver a check on or below an opponent’s knees.
- An illegal “low hit” is a check that is delivered by a player or goalkeeper who may or may not have both skates on the ice, with his sole intent to check the opponent in the area of his knees. A player or goalkeeper may not lower his body position to deliver a check to an opponent’s knees.
- 45.2 **Minor Penalty** - A player or goalkeeper who commits these fouls will be assessed a minor penalty for “clipping.”
- 45.3 **Major Penalty** - If an injury occurs as a result of this “clipping” check, the player or goalkeeper must be assessed a major penalty (see **45.5**).
- 45.4 **Match Penalty** - The Referee, at his discretion, may assess a match penalty if, in his judgment, the player or goalkeeper attempted to or deliberately injured his opponent by clipping.
- 45.5 **Game Misconduct Penalty** - A game misconduct penalty must be assessed anytime a major penalty is applied for injuring an opponent by clipping.

45.6 **Fines and Suspensions** – There are no specified fines or suspensions for clipping, however, supplementary discipline can be applied by the Commissioner at his discretion (refer to Rule 29).

Rule 46 - Elbowing

- 46.1 **Elbowing** - Elbowing shall mean the use of an extended elbow in a manner that may or may not cause injury.
- 46.2 **Minor Penalty** - The Referee, at his discretion, may assess a minor penalty, based on the degree of violence, to a player or goalkeeper guilty of elbowing an opponent.
- 46.3 **Major Penalty** - A major penalty, at the discretion of the Referee, shall be imposed on any player or goalkeeper who uses his elbow to foul an opponent. A major penalty must be imposed under this rule for a foul resulting in an injury to the face or head of an opponent (see 46.5).
- 46.4 **Match Penalty** - The Referee, at his discretion, may assess a match penalty if, in his judgment, the player or goalkeeper attempted to or deliberately injured his opponent by elbowing.
- 46.5 **Game Misconduct Penalty** - When a major penalty is imposed under this rule for a foul resulting in an injury to the face or head of an opponent, a game misconduct penalty shall also be imposed.
- 46.6 **Fines and Suspensions** - When a major penalty and a game misconduct is assessed for a foul resulting in an injury to the face or head of an opponent, an automatic fine of one hundred dollars (\$100) shall be imposed.

If deemed appropriate, supplementary discipline can be applied by the Commissioner at his discretion (refer to Rule 29).

Rule 47 - Fighting

47.1 **Fighting** – A fight shall be deemed to have occurred when at least one player (or goalkeeper) punches or attempts to punch an opponent repeatedly or when two players wrestle in such a manner as to make it difficult for the Linesmen to intervene and separate the combatants.

The Referees are provided very wide latitude in the penalties with which they may impose under this rule. This is done intentionally to enable them to differentiate between the obvious degrees of responsibility of the participants either for starting the fighting or persisting in continuing the fighting. The discretion provided should be exercised realistically.

47.2 **Aggressor** – The aggressor in an altercation shall be the player (or goalkeeper) who continues to throw punches in an attempt to inflict punishment on his opponent who is in a defenseless position or who is an unwilling combatant.

A player (or goalkeeper) must be deemed the aggressor when he has clearly won the fight but he continues throwing and landing

punches in a further attempt to inflict punishment and/or injury on his opponent who is no longer in a position to defend himself.

A player or goalkeeper who is deemed to be the aggressor of an altercation shall be assessed a major penalty for fighting and a game misconduct.

A player or goalkeeper who is deemed to be the aggressor of an altercation will have this recorded as an aggressor of an altercation for statistical and suspension purposes.

A player or goalkeeper who is deemed to be both the instigator and aggressor of an altercation shall be assessed an instigating minor penalty, a major penalty for fighting, a ten-minute misconduct (instigator) and a game misconduct penalty (aggressor).

- 47.3 **Altercation** - An altercation is a situation involving two players (including goalkeepers), with at least one to be penalized.
- 47.4 **Clearing the Area of a Fight** - When a fight occurs, all players not engaged shall go immediately to the area of their players' bench and in the event the altercation takes place at a players' bench, the players on the ice from that team shall go to their defending zone. Goalkeepers shall remain in their goal crease, except in the event the altercation takes place in the vicinity of the goal crease, and therefore shall obey the directions of the Referee. Failure to comply can result in penalties incurred for their involvement in and around the area and fines as outlined in **47.18**.
- 47.5 **Continuing or Attempting to Continue a Fight** - Any player or goalkeeper who persists in continuing or attempting to continue a fight or altercation after he has been ordered by the Referee to stop, or who resists a Linesman in the discharge of his duties shall, at the discretion of the Referee, incur a misconduct or game misconduct penalty in addition to any penalties imposed.
- 47.6 **Face Protection** - If a player penalized as an instigator of an altercation is wearing a face shield (including a goalkeeper), he shall be assessed an additional unsportsmanlike conduct penalty.
- Should the player (including a goalkeeper) who instigates the fight be wearing a face shield, but removes it before instigating the altercation, the additional unsportsmanlike conduct penalty shall not apply.
- 47.7 **Fighting After the Original Altercation** - A game misconduct penalty shall be imposed on any player or goalkeeper who is assessed a major penalty for fighting after the original altercation.
- Notwithstanding this rule, at the discretion of the Referee, the automatic game misconduct penalty may be waived for a player or goalkeeper in the altercation if the opposing player was clearly the instigator of the altercation.
- 47.8 **Fighting Off the Playing Surface** - A misconduct or game misconduct penalty shall be imposed on any player or goalkeeper involved in fighting off the playing surface or with another player who

is off the playing surface. These penalties are in addition to any other time penalties assessed, including the major penalty for fighting.

Whenever a Coach or other non-playing Club personnel becomes involved in an altercation with an opposing player or goalkeeper, Coach or other non-playing Club personnel on or off the ice, shall be automatically suspended from the game, ordered to the dressing room and the matter will be reported to the Commissioner for further disciplinary action.

- 47.9 Fighting Other Than During the Periods of the Game** - Any teams whose players or goalkeepers become involved in an altercation, other than during the periods of the game, shall be fined pursuant to **47.20**, in addition to any other appropriate penalties that may be imposed upon the participating players or goalkeepers by supplementary discipline or otherwise.

Players involved in fighting other than during the periods of the game shall be assessed a major penalty and a game misconduct. Should one player be deemed the instigator of the fight, the game misconduct shall not be assessed to his opponent.

Any player or goalkeeper who would be deemed to be an instigator pursuant to this rule at a time other than during the periods of the game shall be suspended pursuant to **47.20**.

In the case of altercations taking place after the period or game the fine under this rule shall be assessed only in the event that an altercation is commenced after the period or game has terminated.

Should players come onto the ice from their players' benches after the period ends and prior to the start of an altercation, they shall not be penalized if they remain in the vicinity of their players' bench and provided they do not get involved in any altercations.

- 47.10 Fighting Prior to the Drop of the Puck** – Unless this occurs prior to the start of the game or any period (see **47.9**), a fight that occurs prior to the drop of the puck during the course of normal face-off, the altercation shall be penalized as if it occurred during the regular playing time.

When, in the opinion of the Referee that, specific personnel changes have been made by one or both teams late in a game and ultimately an altercation ensues, the appropriate penalties are to be assessed and the incident reported to the Commissioner immediately following the game for review and possible supplementary discipline under Rule **29**.

- 47.11 Instigator** - An instigator of an altercation shall be a player or goalkeeper who by his actions or demeanor demonstrates any/some of the following criteria: distance traveled; gloves off first; first punch thrown; menacing attitude or posture; verbal instigation or threats; conduct in retaliation to a prior game (or season) incident; obvious retribution for a previous incident in the game or season.

A player or goalkeeper who is deemed to be the instigator of an altercation shall be assessed an instigating minor penalty, a major penalty for fighting and a ten-minute misconduct.

If the same player or goalkeeper is deemed to be the instigator of a second altercation in the same game, he shall be assessed an instigating minor penalty, a major penalty for fighting and a game misconduct.

When a player or goalkeeper receives his third instigator penalty in one Regular season, he is automatically given a game misconduct following that third violation.

A player or goalkeeper who is deemed to be both the instigator and aggressor of an altercation shall be assessed an instigating minor penalty, a major penalty for fighting, a ten-minute misconduct (instigator) and a game misconduct penalty (aggressor).

47.12 Instigator in Final Five Minutes of Regulation Time (or Anytime in Overtime) - A player or goalkeeper who is deemed to be the instigator of an altercation in the final five (5) minutes of regulation time or at any time in overtime shall be assessed an instigator minor penalty, a major penalty for fighting, and a game misconduct penalty (see **47.22**).

47.13 Jerseys - A player or goalkeeper who deliberately removes his jersey prior to participating in an altercation or who is clearly wearing a jersey that has been modified and does not conform to Rule 9 – Uniforms, shall be assessed a minor penalty for unsportsmanlike conduct and a game misconduct. This is in addition to other penalties to be assessed to the participants of an altercation. If the altercation never materializes, the player or goalkeeper would receive a minor penalty for unsportsmanlike conduct and a ten-minute misconduct for deliberately removing his jersey.

A player or goalkeeper who engages in a fight and whose jersey is removed (completely off his torso), other than through the actions of his opponent in the altercation or through the actions of the Linesman, shall be assessed a game misconduct penalty.

A player or goalkeeper who engages in a fight and whose jersey is not properly “tied-down” (jersey properly fastened to pants), and who loses his jersey (completely off his torso) in that altercation, shall receive a game misconduct penalty. If the player or goalkeeper loses his jersey despite the tie down remaining in tact and attached to the pants, the game misconduct is not applicable, however this must be reported to the League office so that the jersey and the tie down can be examined.

A player or goalkeeper who is involved in an altercation, when the opponent has been identified as an instigator, shall not be assessed a game misconduct penalty if his jersey should be removed by an opponent or an official in the discharge of his duties, regardless as to whether or not he was properly “tied-down” (jersey properly fastened to pants).

- 47.14 **Major Penalty** – A major penalty shall be imposed on any player or goalkeeper who fights.
- 47.15 **Match Penalty** - Any player or goalkeeper wearing tape or any other material on his hands (below the wrist) who cuts or injures an opponent during an altercation will receive a match penalty in addition to any other penalties imposed including for fighting under this rule.
- A match penalty shall be assessed to a player or goalkeeper who punches an unsuspecting opponent and causes an injury.
- 47.16 **Third Man In** - A game misconduct penalty, at the discretion of the Referee, shall be imposed on any player or goalkeeper who is the first to intervene (third man in) in an altercation already in progress except when a match penalty is being imposed in the original altercation. This penalty is in addition to any other penalties incurred in the same incident.
- This rule also applies to subsequent players or goalkeepers who elect to intervene in the same or other altercations during the same stoppage of play.
- 47.17 **Fines and Suspensions – Aggressor** - A player or goalkeeper who is deemed to be the aggressor for the third time in one Regular season shall be suspended for the next two regular season games of his team.
- For the fourth aggressor penalty in the same Regular season, the player or goalkeeper will be suspended for the next four games of his team. For the fifth aggressor penalty in the same Regular season, the player or goalkeeper will be suspended for the next six games of his team.
- During the Play-offs, any player or goalkeeper who is deemed to be the aggressor for the second time shall be suspended automatically for the next Play-off game of his team. For each subsequent aggressor violation during the Play-offs, the automatic suspension shall be increased by one game.
- Prior to the commencement of each Stanley Cup Final, a player or goalkeeper will have his current aggressor violations removed from his current playoff record. They will remain part of his historical record.
- 47.18 **Fines and Suspensions – Clearing the Area of a Fight** - Failure by players (or goalkeepers as required) to clear the area of a fight shall, in addition to the other penalties that may be assessed, result in a fine to the team of \$1,000 and the Coach of said team in the amount of \$1,000.
- 47.19 **Fines and Suspensions – Failure to Proceed Directly to Penalty Bench** - Any player who, following a fight or other altercation in which he has been involved is broken up and for which he is penalized, fails to proceed directly and immediately to the penalty bench, or who causes any delay by retrieving his equipment (gloves, sticks, etc. shall be delivered to him at the penalty bench by teammates), shall incur an automatic fine of one hundred dollars (\$100) in addition to all other penalties or fines incurred.

- 47.20 **Fines and Suspensions – Fighting Other Than During the Periods of the Game** - Any teams whose players or goalkeepers become involved in an altercation, other than during the periods of the game, shall be fined automatically twenty-five thousand dollars (\$25,000) in addition to any other appropriate penalties that may be imposed upon the participating players by supplementary discipline or otherwise.

Any player or goalkeeper who would be deemed to be an instigator pursuant to this rule at a time other than during the periods of the game shall be suspended automatically for ten (10) games. Such determination may be made by the Referee at the time of the incident or subsequently by the Commissioner or his designee based upon such reports and other information as he deems sufficient, including but not limited to television tapes.

- 47.21 **Fines and Suspensions – Instigator** - A player or goalkeeper who is deemed to be the instigator of an altercation for the third time in one Regular season shall be suspended for the next two regular season games of his team.

For the fourth instigator penalty in the same Regular season, the player or goalkeeper will be suspended for the next four games of his team. For the fifth instigator penalty in the same Regular season, the player or goalkeeper will be suspended for the next six games of his team.

During the Play-offs, any player or goalkeeper who is deemed to be the instigator of an altercation for the second time shall be suspended automatically for the next Play-off game of his team. For each subsequent instigator violation during the Play-offs, the automatic suspension shall be increased by one game.

Prior to the commencement of each Stanley Cup Final, a player or goalkeeper will have his current instigator violations removed from his current playoff record. They will remain part of his historical record.

- 47.22 **Fines and Suspensions – Instigator in Final Five Minutes of Regulation Time (or Anytime in Overtime)** - A player or goalkeeper who is deemed to be the instigator of an altercation in the final five (5) minutes of regulation time or at anytime in overtime, shall automatically be suspended for one game. The Director of Hockey Operations will review every such incident and may rescind the suspension based on a number of criteria. The criteria for the review shall include, but not limited to, the score, previous incidents, etc. The length of suspension will double for each subsequent offense. This suspension shall be served in addition to any other automatic suspensions a player may incur for an accumulation of three or more instigator penalties.

When the one-game suspension is imposed, the Coach shall be fined \$10,000 – a fine that will double for each subsequent incident.

No team appeals will be permitted either verbally or in writing regarding the assessment of this automatic suspension.

Rule 48 – Head-butting

- 48.1 **Head-butting** – The act of head-butting involves a player or goalkeeper making intentional contact, or attempting to make contact, with an opponent by leading with his head and/or helmet.
- 48.2 **Double-minor Penalty** - A double-minor penalty shall be imposed on a player or goalkeeper who attempts to head-butt an opponent.
- 48.3 **Major Penalty** - A major penalty shall be imposed on a player or goalkeeper who head-butts an opponent (see **48.5**).
- 48.4 **Match Penalty** - A match penalty shall be imposed on a player or goalkeeper who injures an opponent as a result of a head-butt.
- 48.5 **Game Misconduct Penalty** – When a major penalty is assessed under this rule, a game misconduct penalty must be imposed.
- 48.6 **Fines and Suspensions** - There are no specified fines or suspensions for head-butting, however, supplementary discipline can be applied by the Commissioner at his discretion (refer to Rule **29**).

Rule 49 - Kicking

- 49.1 **Kicking** – The action of a player or goalkeeper deliberately using his skate(s) with a kicking motion to propel the puck or to contact an opponent.
- 49.2 **Goals** - Kicking the puck shall be permitted in all zones. A goal cannot be scored by an attacking player who uses a distinct kicking motion to propel the puck into the net. A goal cannot be scored by an attacking player who kicks a puck that deflects into the net off any player, goalkeeper or official.

A puck that deflects into the net off an attacking player's skate who does not use a distinct kicking motion is a legitimate goal. A puck that is directed into the net by an attacking player's skate shall be a legitimate goal as long as no distinct kicking motion is evident. The following should clarify deflections following a kicked puck that enters the goal:

- (i) *A kicked puck that deflects off the body of any player of either team (including the goalkeeper) shall be ruled no goal.*
- (ii) *A kicked puck that deflects off the stick of any player (excluding the goalkeeper's stick) shall be ruled a good goal. Any time the puck has been kicked, makes contact with any stick, and then deflects off any player (excluding the goalkeeper) into the net, it will be ruled a good goal.*
- (iii) *A goal will be allowed when an attacking player kicks the puck and the puck deflects off his own stick and then into the net.*

A goal cannot be scored by an attacking player who kicks any equipment (stick, glove, helmet, etc.) at the puck, including kicking the blade of his own stick, causing the puck to cross the goal line.

- 49.3 **Match Penalty** – A match penalty shall be imposed on any player or



goalkeeper who kicks or attempts to kick another player.

Whether or not an injury occurs, the Referee will impose a five (5) minute time penalty under this rule.

- 49.4 **Fines and Suspensions** - There are no specified fines or suspensions for kicking and opponent, however, supplementary discipline can be applied by the Commissioner at his discretion (refer to Rule 29).

Rule 50 - Kneeing

- 50.1 **Kneeing** - Kneeing is the act of a player or goalkeeper leading with his knee and in some cases extending his leg outwards to make contact with his opponent.
- 50.2 **Minor Penalty** - The Referee, at his discretion, may assess a minor penalty, based on the severity of the infraction, to a player or goalkeeper guilty of kneeing an opponent.
- 50.3 **Major Penalty** - The Referee, at his discretion, may assess a major penalty, based on the severity of the infraction, to a player or goalkeeper guilty of kneeing an opponent (see 50.5).
- 50.4 **Match Penalty** – The Referee, at his discretion, may assess a match penalty if, in his judgment, the player or goalkeeper attempted to or deliberately injured his opponent by kneeing.
- 50.5 **Game Misconduct Penalty** - When a player or goalkeeper has been assessed a major penalty for kneeing he shall also be assessed a Game Misconduct.
- 50.6 **Fines and Suspensions** - There are no specified fines or suspensions for kneeing, however, supplementary discipline can be applied by the Commissioner at his discretion (refer to Rule 29).

Rule 51 - Roughing

- 51.1 **Roughing** – Roughing is a punching motion with the hand or fist, with or without the glove on the hand, normally directed at the head or face of an opponent.
- Roughing is a minor altercation that is not worthy of a major penalty to either participant. (An altercation is a situation involving two players, including goalkeepers, with at least one to be penalized).
- 51.2 **Minor Penalty** - A minor penalty shall be imposed on a player or goalkeeper who strikes an opponent with his hand or fist.
- 51.3 **Match Penalty** - If, in the judgment of the Referee, a goalkeeper uses his blocking glove to punch an opponent in the head or face in an attempt to or to deliberately injure an opponent, a match penalty must be assessed.

- 51.4 **Fines and Suspensions** - There are no specified fines or suspensions for roughing, however, supplementary discipline can be applied by the Commissioner at his discretion (refer to Rule 29).

Rule 52 – Slew-footing

- 52.1 **Slew-footing** - Slew-footing is the act of a player or goalkeeper using his leg or foot to knock or kick an opponent's feet from under him, or pushes an opponent's upper body backward with an arm or elbow, and at the same time with a forward motion of his leg, knocks or kicks the opponent's feet from under him, causing him to fall violently to the ice.
- 52.2 **Match Penalty** - Any player or goalkeeper who is guilty of slew-footing shall be assessed a match penalty.
- 52.3 **Fines and Suspensions** - There are no specified fines or suspensions for slew-footing, however, supplementary discipline can be applied by the Commissioner at his discretion (refer to Rule 29).

Rule 53 – Throwing Equipment

- 53.1 **Throwing Equipment** – A player, including the goalkeeper, shall not throw a stick or any other object in any zone.
- 53.2 **Minor Penalty** - A minor penalty shall be imposed on any player or goalkeeper on the ice who throws his stick or any part thereof or any other object in the direction of the puck or an opponent in any zone, except when such act has been penalized by the assessment of a penalty shot or the awarding of a goal.

When a defending player or goalkeeper shoots or throws a stick or any other object at the puck or the puck carrier in the defending zone but does not interfere in any manner with the puck or puck carrier, a minor penalty shall be assessed.

When the player or goalkeeper discards the broken portion of a stick or some other object by tossing it or shooting it to the side of the ice (and not over the boards) in such a way as will not interfere with play or opposing player, no penalty will be imposed for so doing. When moving a stick that is not broken, no penalty shall be assessed as long as it does not interfere with the play and the player or goalkeeper who lost said stick is not attempting to retrieve it, otherwise an interference penalty must be assessed.

A minor penalty for unsportsmanlike conduct plus a game misconduct penalty shall be imposed on a player or goalkeeper who throws his stick or any part thereof or any other object or piece of equipment outside the playing area in protest of an official's decision.

- 53.3 **Bench Minor Penalty** – Should any player, goalkeeper, Coach, or non-playing person on the players' bench or penalty bench throw anything on the ice during the progress of the game or during a

stoppage of play, a bench minor penalty for unsportsmanlike conduct shall be assessed. See **40.3**.

- 53.4 **Misconduct or Game Misconduct Penalty** - A misconduct or game misconduct penalty, at the discretion of the Referee, shall be imposed on a player or goalkeeper who throws his stick or any part thereof or any other object or piece of equipment outside the playing area. If the offense is committed in protest of an official's decision, a minor penalty for unsportsmanlike conduct plus a game misconduct penalty shall be assessed to the offending player or goalkeeper.
- 53.5 **Match Penalty** – If a player or goalkeeper attempts to or deliberately injures an opponent by throwing a stick or any other object or piece of equipment at an opposing player, Coach or non-playing club person, he shall be assessed a match penalty. If injury results from the thrown object, a match penalty must be assessed for deliberate injury of an opponent.
- 53.6 **Penalty Shot** - When any member of the defending team, including the Coach or any non-playing person, throws or shoots any part of a stick or any other object or piece of equipment at the puck or puck carrier in his defending zone, preventing a reasonable shot or pass, the Referee shall allow the play to be completed and if a goal is not scored, a penalty shot shall be awarded to the non-offending team. This shot shall be taken by the player designated by the Referee as the player fouled.

If the officials are unable to determine the person against whom the offense was made, the non-offending team, through the Captain, shall designate a player on the ice at the time the offense was committed to take the shot.

See also Rule **57.3** – Tripping for fouls from behind to a player on a breakaway.

If a player on a breakaway in the neutral or attacking zone is interfered with by an object thrown on the ice by a spectator that causes him to lose possession of the puck or to fall, the Referee shall award a penalty shot to the player who was fouled.

- 53.7 **Awarded Goal** - If, when the opposing goalkeeper has been removed, a member of the defending team, including the Coach or any non-playing person, throws or shoots any part of a stick or any other object or piece of equipment at the puck or puck carrier in the neutral or his own defending zone, thereby preventing the puck carrier from having a clear shot on an "open net", a goal shall be awarded to the attacking side.

For the purpose of this rule, an "open net" is defined as one from which a goalkeeper has been removed for an additional attacking player. The goalkeeper is considered off the ice once the replacement player has entered the playing surface.

- 53.8 **Fines and Suspensions** - There are no specified fines or suspensions for throwing equipment, however, supplementary



SECTION 6 – PHYSICAL FOULS



discipline can be applied by the Commissioner at his discretion (refer to Rule **29**).

SECTION 7 – RESTRAINING FOULS

Rule 54 – Holding

54.1 **Holding** – Any action by a player or goalkeeper that retards the progress of an opposing player whether or not he is in possession of the puck.

54.2 **Minor Penalty** - A minor penalty shall be imposed on a player or goalkeeper who holds an opponent by using his hands, arms or legs.

A player or goalkeeper is permitted to use his arm in a strength move, by blocking his opponent, provided he has body position and is not using his hands in a holding manner, when doing so.

A player or goalkeeper is not permitted to hold an opponent's stick. A minor penalty shall be assessed to a player or goalkeeper who holds an opponent's stick (assessed and announced as "holding the stick").

A player is permitted to protect himself by defending against an opponent's stick. He must immediately release the stick and allow the player to resume normal play.

54.3 **Penalty Shot** – refer to Rule 57.3 – Tripping.

54.4 **Awarded Goal** – refer to Rule 57.4 – Tripping.

Rule 55 – Hooking

55.1 **Hooking** - Hooking is the act of using the stick in a manner that enables a player or goalkeeper to restrain an opponent.

When a player is checking another in such a way that there is only stick-to-stick contact, such action is not to be penalized as hooking.

55.2 **Minor Penalty** - A minor penalty shall be imposed on a player or goalkeeper who impedes the progress of an opponent by "hooking" with his stick. A minor penalty for hooking shall be assessed to any player or goalkeeper who uses the shaft of the stick above the upper hand to hold or hook an opponent.

55.3 **Major Penalty** - A major penalty shall be imposed on any player or goalkeeper who injures an opponent by "hooking" (see 55.4).

55.4 **Game Misconduct** – When a major penalty has been assessed for hooking as a result of an injury to an opponent, a game misconduct penalty must also be assessed.

55.5 **Penalty Shot** – refer to Rule 57.3 – Tripping.

55.6 **Awarded Goal** – refer to Rule 57.4 – Tripping.

55.7 **Fines and Suspensions** - A player or goalkeeper who has been assessed a major penalty and a game misconduct under this rule shall be automatically fined one hundred dollars (\$100).

If deemed appropriate, supplementary discipline can be applied by



the Commissioner at his discretion (refer to Rule 29).

Rule 56 – Interference

56.1 **Interference** - A strict standard on acts of interference must be adhered to in all areas of the rink.

Body Position: Body position shall be determined as the player skating in front of or beside his opponent, traveling in the same direction. A player who is behind an opponent, who does not have the puck, may not use his stick, body or free hand in order to restrain his opponent, but must skate in order to gain or reestablish his proper position in order to make a check.

A player is allowed the ice he is standing on (body position) and is not required to move in order to let an opponent proceed. A player may “block” the path of an opponent provided he is in front of his opponent and moving in the same direction. Moving laterally and without establishing body position, then making contact with the non-puck carrier is not permitted and will be penalized as interference. A player is always entitled to use his body position to lengthen an opponent’s path to the puck, provided his stick is not utilized (to make himself “bigger” and therefore considerably lengthening the distance his opponent must travel to get where he is going); his free hand is not used and he does not take advantage of his body position to deliver an otherwise illegal check.

Possession of the Puck:

The last player to touch the puck, other than the goalkeeper, shall be considered the player in possession. The player deemed in possession of the puck may be checked legally, provided the check is rendered immediately following his loss of possession.

Restrain: The actions of a player or goalkeeper who does not have body position, but instead uses illegal means (e.g. hook with stick; hold with hands, trip with the stick or in any manner) to impede an opponent who is not in possession of the puck. Illegal means are acts which allow a player or goalkeeper to establish, maintain or restore body position other than by skating.

Pick: A “pick” is the action of a player or goalkeeper who checks an opponent who is not in possession of the puck and is unaware of the impending check/hit. A



SECTION 7 – RESTRAINING FOULS



player who is aware of an impending hit, not deemed to be a legal “battle for the puck,” may not be interfered with by a player or goalkeeper delivering a “pick.” A player or goalkeeper delivering a “pick” is one who moves into an opponent’s path without initially having body position, thereby taking him out of the play. When this is done, an interference penalty shall be assessed.

Free Hand: When a free hand is used to hold, pull, tug, grab or physically restrain an opponent from moving freely, this must be penalized as holding. The free hand may be used by a player to “fend off” an opponent or his stick, but may not be used to hold an opponent’s stick or body.

Stick: A player or goalkeeper who does not have body position on his opponent, who uses his stick (either the blade or the shaft, including the butt-end of the shaft) to impede or prevent his opponent from moving freely on the ice shall be assessed a hooking penalty.

56.2 Minor Penalty - A minor penalty shall be imposed on a player or goalkeeper who interferes with or impedes the progress of an opponent who is not in possession of the puck.

A minor penalty shall be imposed on a player or goalkeeper who restrains an opponent who is attempting to “fore-check.”

A minor penalty shall be imposed on an attacking player who deliberately checks a defensive player, including the goalkeeper, who is not in possession of the puck.

A minor penalty shall be imposed on a player who shall cause an opponent who is not in possession of the puck to be forced off-side, causing a stoppage in play. If this action causes a delayed off-side (and not necessarily a stoppage in play), then the application of a penalty for interference is subject to the judgment of the Referee.

A minor penalty shall be imposed on a player who deliberately knocks a stick out of an opponent’s hand, or who prevents a player who has dropped his stick or any other piece of equipment from regaining possession of it.

A minor penalty shall be imposed on a player who knocks or shoots any abandoned or broken stick or illegal puck or other debris towards an opposing puck carrier in a manner that could cause him to be distracted. (See also Rule 53 – Throwing Equipment.)

A minor penalty shall be imposed on any identifiable player on the players’ bench or penalty bench who, by means of his stick or his body, interferes with the movements of the puck or any opponent on the ice during the progress of the play. In addition, should a player about to come onto the ice, play the puck while one or both skates are still on the players’ or penalty bench, a minor penalty for interference

shall be assessed.

The appropriate penalty according to the playing rules shall be assessed when a player on the players' or penalty bench gets involved with an opponent on the ice during a stoppage in play. The player(s) involved may be subject to additional sanctions as appropriate pursuant to Rule 29 – Supplementary Discipline.

56.3 Bench Minor Penalty - A bench minor penalty shall be imposed when an unidentifiable player on the players' bench or penalty bench or any Coach or non-playing Club personnel who, by means of his stick or his body, interferes with the movements of the puck or any opponent on the ice during the progress of the play.

56.4 Major Penalty - The Referee, at his discretion, may assess a major penalty, based on the degree of violence, to a player or goalkeeper guilty of interfering with an opponent (see 56.5).

56.5 Game Misconduct Penalty – When a major penalty is imposed under this rule for a foul resulting in an injury of an opponent, a game misconduct shall be imposed.

56.6 Penalty Shot - When a player in control of the puck in the neutral or attacking zone and having no other opponent to pass than the goalkeeper is interfered with by a stick or any part thereof or any other object or piece of equipment thrown or shot by any member of the defending team including the Coach or non-playing Club personnel, a penalty shot shall be awarded to the non-offending team. When a Coach or non-playing Club personnel is guilty of such an act, he shall be automatically suspended from the game, ordered to the dressing room and the matter will be reported to the Commissioner for possible further disciplinary action.

56.7 Awarded Goal - If, when the goalkeeper has been removed from the ice, any member of his team (including the goalkeeper) not legally on the ice, including the Coach or non-playing Club personnel, interferes by means of his body, stick or any other object or piece of equipment with the movements of the puck or an opposing player in the neutral or attacking zone, the Referee shall immediately award a goal to the non-offending team. When a Coach or non-playing Club personnel is guilty of such an act, he shall be automatically suspended from the game, ordered to the dressing room and the matter will be reported to the Commissioner for possible further disciplinary action.

Rule 57 – Tripping

57.1 Tripping – A player or goalkeeper shall not place the stick, knee, foot, arm, hand or elbow in such a manner that causes his opponent to trip or fall.

Accidental trips which occur simultaneously with a completed play will not be penalized. Accidental trips occurring simultaneously with or after a stoppage of play will not be penalized.

If, in the opinion of the Referee, a player makes contact with the puck first and subsequently trips the opponent in so doing, no penalty shall be assessed.

57.2 Minor Penalty - A minor penalty shall be imposed on any player or goalkeeper who shall place his stick or any portion of his body in such a manner that it shall cause his opponent to trip and fall.

57.3 Penalty Shot - When a player, in the neutral or attacking zone, in control of the puck (or who could have obtained possession and control of the puck) and having no other opponent to pass than the goalkeeper, is tripped or otherwise fouled from behind, thus preventing a reasonable scoring opportunity, a penalty shot shall be awarded to the non-offending side. Nevertheless, the Referee shall not stop play until the attacking side has lost possession of the puck to the defending side.

The intention of this rule is to restore a reasonable scoring opportunity which has been lost by reason of a foul from behind when the foul is committed on the opponent in the neutral or attacking zone. If, however, the player fouled is able to recover and obtain a reasonable scoring opportunity (or a teammate is able to gain a reasonable scoring opportunity), no penalty shot should be awarded but the appropriate penalty should be signaled and assessed if a goal is not scored on the play.

“Control of the puck” means the act of propelling the puck with the stick, hand or feet. If while it is being propelled, the puck is touched by another player or his equipment, or hits the goal or goes free, the player shall no longer be considered to be “in control of the puck”.

In order for a penalty shot to be awarded for a player being fouled from behind, the following four (4) criteria must have been met:

- (i) *The infraction must have taken place in the neutral or attacking zone (i.e. over the puck carrier's own blue line).*
- (ii) *The infraction must have been committed from behind.*
- (iii) *The player in possession and control (or, in the judgment of the Referee, the player clearly would have obtained possession and control of the puck) must have been denied a reasonable chance to score. The fact that he got a shot off does not automatically eliminate this play from the penalty shot consideration criteria. If the foul was from behind and he was denied a “more” reasonable scoring opportunity due to the foul, then the penalty shot should be awarded.*
- (iv) *The player in possession and control (or, in the judgment of the Referee, the player clearly would have obtained possession and control) must have had no opposing player between himself and the goalkeeper.*

It should be noted that if the attacking player manages to get around the goalkeeper and has no defending player between him and the open goal, and he is fouled from behind by the goalkeeper or another defending player, no goal can be awarded since the goalkeeper is still on the ice. A penalty shot would be awarded.



SECTION 7 – RESTRAINING FOULS



57.4 **Awarded Goal** - If, when the opposing goalkeeper has been removed from the ice, a player in control of the puck in the neutral or attacking zone is tripped or otherwise fouled with no opposition between him and the opposing goal, thus preventing a reasonable scoring opportunity, the Referee shall immediately stop play and award a goal to the attacking team.

SECTION 8 – STICK FOULS

Rule 58 – Butt-ending

- 58.1 **Butt-ending** – The action whereby a player or goalkeeper uses the shaft of the stick, above the upper hand, to check an opposing player in any manner or jabs or attempts to jab an opposing player with this part of the stick.
- 58.2 **Double-minor Penalty** - A double-minor penalty will be imposed on a player or goalkeeper who attempts to butt-end an opponent.
- 58.3 **Major Penalty** - A major penalty shall be imposed on a player or goalkeeper who butt-ends an opponent (see section **58.5**).
- 58.4 **Match Penalty** - A match penalty shall be imposed on a player or goalkeeper who injures an opponent as a result of a butt-end.
- 58.5 **Game Misconduct Penalty** – When a major penalty is imposed for butt-ending, a game misconduct penalty must also be assessed.
- 58.6 **Fines and Suspensions** - When a major penalty and game misconduct are imposed under this rule, an automatic fine of one hundred dollars (\$100) will be imposed.

If deemed appropriate, supplementary discipline can be applied by the Commissioner at his discretion (refer to Rule **29**).

Rule 59 – Cross-checking

- 59.1 **Cross-checking** - The action of using the shaft of the stick between the two hands to forcefully check an opponent.
- 59.2 **Minor Penalty** - A minor penalty, at the discretion of the Referee based on the severity of the contact, shall be imposed on a player or goalkeeper who “cross checks” an opponent.
- 59.3 **Major Penalty** - A major penalty, at the discretion of the Referee based on the severity of the contact, shall be imposed on a player or goalkeeper who “cross checks” an opponent (see **59.5**).
- 59.4 **Match Penalty** – The Referee, at his discretion, may assess a match penalty if, in his judgment, the player or goalkeeper attempted to or deliberately injured his opponent by cross-checking.
- 59.5 **Game Misconduct Penalty** - When a major penalty is assessed for cross-checking, an automatic game misconduct penalty shall be imposed on the offending player.
- 59.6 **Fines and Suspensions** - When a major penalty is imposed under this rule, an automatic fine of one hundred dollars (\$100) shall also be imposed.

If deemed appropriate, supplementary discipline can be applied by the Commissioner at his discretion (refer to Rule **29**).

Rule 60 – High-sticking

- 60.1 **High-sticking** - A “high stick” is one which is carried above the height of the opponent’s shoulders. Players and goalkeepers must be in control and responsible for their stick. However, a player or goalkeeper is permitted accidental contact on an opponent if the act is

committed as a normal windup or follow through of a shooting motion. A wild swing at a bouncing puck would not be considered a normal windup or follow through and any contact to an opponent above the height of the shoulders shall be penalized accordingly.

- 60.2 **Minor Penalty** - Any contact made by a stick on an opponent above the shoulders is prohibited and a minor penalty shall be imposed.
- 60.3 **Double-minor Penalty** - When a player or goalkeeper carries or holds any part of his stick above the shoulders of the opponent so that injury results, the Referee shall assess a double-minor penalty for all contact that causes an injury, whether accidental or careless, in the opinion of the Referee.
- 60.4 **Match Penalty** – When, in the opinion of the Referee, a player or goalkeeper attempts to or deliberately injures an opponent while carrying or holding any part of his stick above the shoulders of the opponent, the Referee shall assess a match penalty to the offending player.
- 60.5 **Goals** - An apparent goal scored by an attacking player who strikes the puck with his stick carried above the height of the crossbar of the goal frame shall not be allowed. The determining factor is where the puck makes contact with the stick. If the puck makes contact with the stick below the level of the crossbar and enters the goal, this goal shall be allowed.
- A goal scored by a defending player who strikes the puck with his stick carried above the height of the crossbar of the goal frame shall be allowed.
- 60.6 **Fines and Suspensions** - There are no specified fines or suspensions for high-sticking, however, supplementary discipline can be applied by the Commissioner at his discretion (refer to Rule 29).

Hooking

Although hooking can be classified as a stick-related foul, it has been placed in Section 7 – Restraining Fouls as Rule 55 as this tends to be the more prominent application of this rule.

Rule 61 – Slashing

- 61.1 **Slashing** - Slashing is the act of a player or goalkeeper swinging his stick at an opponent, whether contact is made or not. Non-aggressive stick contact to the pant or front of the shin pads, should not be penalized as slashing. Any forceful or powerful chop with the stick on an opponent's body, the opponent's stick, or on or near the opponent's hands that, in the judgment of the Referee, is not an attempt to play the puck, shall be penalized as slashing.
- 61.2 **Minor Penalty** - A minor penalty, at the discretion of the Referee based on the severity of the contact, shall be imposed on a player or goalkeeper who slashes an opponent.
- 61.3 **Major Penalty** - A major penalty, at the discretion of the Referee based on the severity of the contact, shall be imposed on a player or goalkeeper who slashes an opponent. When injury occurs, a major

penalty must be assessed under this rule (see **61.5**).

- 61.4 **Match Penalty** – The Referee, at his discretion, may assess a match penalty if, in his judgment, the player or goalkeeper attempted to or deliberately injured his opponent by slashing.
- 61.5 **Game Misconduct Penalty** – Whenever a major penalty is assessed for slashing, a game misconduct penalty must also be imposed.
- 61.6 **Penalty Shot** – refer to Rule **57.3** – Tripping.
- 61.7 **Awarded Goal** – refer to Rule **57.4** – Tripping.
- 61.8 **Fines and Suspensions** - There are no specified fines or suspensions for slashing, however, supplementary discipline can be applied by the Commissioner at his discretion (refer to Rule **29**).

Rule 62 – Spearing

- 62.1 **Spearing** - Spearing shall mean stabbing an opponent with the point of the stick blade, whether contact is made or not.
- 62.2 **Double-minor Penalty** - A double-minor penalty will be imposed on a player or goalkeeper who spears an opponent and does not make contact.
- 62.3 **Major Penalty** - A major penalty shall be imposed on a player or goalkeeper who spears an opponent (see **62.5**).
- 62.4 **Match Penalty** - A match penalty shall be imposed on a player or goalkeeper who injures an opponent as a result of a spear.
- 62.5 **Game Misconduct Penalty** - Whenever a major penalty is assessed for spearing, a game misconduct penalty must also be imposed.
- 62.6 **Fines and Suspensions** - There are no specified fines or suspensions for spearing, however, supplementary discipline can be applied by the Commissioner at his discretion (refer to Rule **29**).

SECTION 9 – OTHER FOULS

Rule 63 – Delaying the Game

- 63.1 **Delaying the Game** – A player, goalkeeper or a team may be penalized when, in the opinion of the Referee, is delaying the game in any manner.
- 63.2 **Minor Penalty** - A minor penalty shall be imposed on any player, including the goalkeeper, who holds, freezes or plays the puck with his stick, skates or body in such a manner as to deliberately cause a stoppage of play. With regard to a goalkeeper, this rule applies outside of his goal crease area.

A minor penalty for delay of game shall be imposed on any player or goalkeeper who deliberately shoots or bats the puck outside the playing area during the play or after a stoppage of play.

When any player or goalkeeper, while in his defending zone, shoots the puck directly (non-deflected) out of the playing surface, except where there is no glass, a penalty shall be assessed for delaying the game. When the puck is shot into the players' bench, the penalty will not apply. When the puck is shot over the glass 'behind' the players' bench, the penalty will be assessed.

A minor penalty shall be imposed on any player (including the goalkeeper) who delays the game by deliberately displacing a goal post from its normal position. The Referee shall stop play immediately when the offending team gains possession of the puck.

In the event that a goalpost is deliberately displaced by a defending player or goalkeeper, prior to the puck crossing the goal line between the normal position of the goalposts, the Referee shall assess a minor penalty for delaying the game if the attacking player has not yet taken the shot or in the act of taking the shot at the open net (see 63.4).

When the net is accidentally displaced by an attacking player, and the defending side is in possession of the puck and moving out of their zone, play shall be permitted to continue until such time as the non-offending team loses possession of the puck. The resulting face-off will take place at a face-off spot in the zone nearest the location where the play was stopped, unless it is in the non-offending team's defending zone, and as such the ensuing face-off would be outside the blue line at one of the face-off spots in the neutral zone. It is possible for a goal to be scored at one end of the rink while the net at the other end has been dislodged, provided that the team being scored upon is the team responsible for dislodging the net at the other end of the rink.

A minor penalty shall be imposed on a player other than the goalkeeper who deliberately falls on or gathers the puck into his body. Any player who drops to his knees to block a shot should not be penalized if the puck is shot under him or becomes lodged in his clothing or equipment but any use of the hands to make the puck

unplayable should be penalized promptly.

If a goalkeeper comes out of his crease to “cut down the angle” on a shot and after making the save covers the puck, this shall be legal. If the goalkeeper races out of his crease in an attempt to beat the attacking player to the puck and instead of playing the puck jumps on the puck causing a stoppage of play, this shall be a minor penalty for delay of game.

A minor penalty shall be imposed on a goalkeeper who, when he is in his own goal crease, deliberately falls on or gathers the puck into his body or who holds or places the puck against any part of the goal in such a manner as to cause a stoppage of play unless he is actually being checked by an opponent.

A goalkeeper shall not play the puck outside of the designated area behind the net. Should the goalkeeper play the puck outside of the designated area behind the goal line, a minor penalty for delay of game shall be imposed. The determining factor shall be the position of the puck. The minor penalty will not be assessed when a goalkeeper plays the puck while maintaining skate contact with his goal crease.

Play shall not be stopped nor the game delayed by reasons of adjustments to clothing, equipment, skates or sticks. For an infringement of this rule, a minor penalty shall be given. No penalty should be assessed when a water bottle is delivered to a goalkeeper, however, this should be conducted during time-outs and if, in the opinion of the Referee, it is being done to intentionally delay the game, a minor penalty may be assessed.

No delay shall be permitted for the repair or adjustment of goalkeeper's equipment. If adjustments are required, the goalkeeper shall leave the ice and his place shall be taken by the substitute goalkeeper immediately. For an infraction of this rule by a goalkeeper, a minor penalty shall be imposed.

- 63.3 **Bench Minor Penalty** - A bench minor penalty shall be imposed upon any Team which, after warning by the Referee to its Captain or Alternate Captain to place the correct number of players on the ice and commence play, fails to comply with the Referee's direction and thereby causes any delay by making additional substitutions (including, but not limited to, continually substituting goalkeepers for the purpose of stalling or delaying the game), by persisting in having its players off-side, or in any other manner.
- 63.4 **Objects Thrown on the Ice** – In the event that objects are thrown on the ice that interfere with the progress of the game, the Referee shall blow the whistle and stop the play and the puck shall be faced-off at a face-off spot in the zone nearest to the spot where play is stopped. When objects are thrown on the ice during a stoppage in play, including after the scoring of a goal, the Referee shall have announced over the public address system that any further occurrences will result in a bench minor penalty being assessed to the home Team. Articles thrown onto the ice following a special occasion (i.e. hat trick) will not result in a bench minor penalty being

assessed.

- 63.5 Penalty Shot** - If the goal post is deliberately displaced by a goalkeeper or player during the course of a “breakaway,” a penalty shot will be awarded to the non-offending team, which shot shall be taken by the player last in possession of the puck.

If by reason of insufficient time in the regular playing time or by reason of penalties already imposed, the minor penalty assessed to a player or goalkeeper for deliberately displacing his own goal post cannot be served in its entirety within the regular playing time of the game or at any time in overtime, a penalty shot shall be awarded against the offending team.

No defending player, except the goalkeeper, will be permitted to fall on the puck, hold the puck, pick up the puck, or gather the puck into the body or hands when the puck is within the goal crease. For infringement of this rule, play shall immediately be stopped and a penalty shot shall be ordered against the offending team, but no other penalty shall be given. The rule shall be interpreted so that a penalty shot will be awarded only when the puck is in the crease at the instant the offense occurs. However, in cases where the puck is outside the crease, Rule **63** may still apply and a minor penalty may be imposed, even though no penalty shot is awarded. The significant factor when determining whether or not a penalty shot is warranted is the location of the puck at the time it was held, grabbed or gathered into the body. If the puck is in the crease, penalty shot. If the puck is outside the crease and gathered into the body of a player (other than the goalkeeper) who is inside the crease, minor penalty). See also Rule **67** – Handling Puck.

- 63.6 Awarded Goal** - In the event that the goal post is displaced, either deliberately or accidentally, by a defending player or goalkeeper, prior to the puck crossing the goal line between the normal position of the goalposts, the Referee may award a goal.

In order to award a goal in this situation, the goal post must have been displaced by the actions a defending player or goalkeeper, the puck must have been shot (or the player must be in the act of shooting) at the goal prior to the goal post being displaced, and it must be determined that the puck would have entered the net between the normal position of the goal posts.

When the goal post has been displaced deliberately by the defending team when their goalkeeper has been removed for an extra attacker thereby preventing an impending goal by the attacking team, the Referee shall award a goal to the attacking team.

The goal frame is considered to be displaced if either or both goal pegs are no longer in their respective holes in the ice, or the net has come completely off one or both pegs, prior to or as the puck enters the goal.

- 63.7 Infractions** – The following list of infractions shall result in a penalty (minor, bench minor, penalty shot or awarded goal) being imposed by the Referee for delaying the game:

- (i) *Deliberately shooting the puck out of play.*
- (ii) *Deliberately throwing or batting the puck out of play.*
- (iii) *Deliberately displacing the goal from its normal position (or accidentally by a defending player or goalkeeper in relation to the awarding of a goal).*
- (iv) *Refusing to place the correct number of players on the ice.*
- (v) *Persisting in having players in an off-side position.*
- (vi) *Deliberately falling on the puck.*
- (vii) *Adjustment of clothing or equipment.*

Rule 64 – Diving / Embellishment

64.1 Diving / Embellishment – Any player or goalkeeper who blatantly dives, embellishes a fall or a reaction, or who feigns an injury shall be penalized with a minor penalty under this rule.

A goalkeeper who deliberately initiates contact with an attacking player other than to establish position in the crease, or who otherwise acts to create the appearance of other than incidental contact with an attacking player, is subject to the assessment of a minor penalty for diving / embellishment.

64.2 Minor Penalty - A minor penalty shall be imposed on a player or goalkeeper who attempts to draw a penalty by his actions (“diving / embellishment”).

64.3 Fines and Suspensions - Regardless if a minor penalty for diving / embellishment is called, Hockey Operations will review game videos and assess fines to players or goalkeepers who dive or embellish a fall or a reaction, or who feign injury. See also Rule **29** – Supplementary Discipline. The call on the ice by the Referee is totally independent of supplementary discipline.

The first such incident during the season will result in a warning letter being sent to the player or goalkeeper. The second such incident will result in a one thousand dollar (\$1,000) fine. For a third such incident in the season, the player shall be suspended for one game, pending a telephone conversation with the Director of Hockey Operations. For subsequent violations in the same season, the player’s suspension shall double (i.e. first suspension – one game, second suspension – two games, third suspension – four games, etc.) See also Rule **29** – Supplementary Discipline.

Rule 65 – Equipment

65.1 Equipment – The onus is on the player and/or goalkeeper to maintain his equipment and uniform in playing condition as set forth in these rules.

65.2 Minor Penalty - All protective equipment, except gloves, headgear and goalkeepers’ leg guards must be worn under the uniform. For

violation of this rule, after warning by the Referee, a minor penalty shall be imposed. Players including the goalkeeper violating this rule shall not be permitted to participate in the game until such equipment has been corrected or removed.

Play shall not be stopped nor the game delayed by reasons of adjustments to clothing, equipment, skates or sticks. For an infringement of this rule, a minor penalty shall be given.

No delay shall be permitted for the repair or adjustment of goalkeeper's equipment. If adjustments are required, the goalkeeper shall leave the ice and his place shall be taken by the substitute goalkeeper immediately. For an infraction of this rule by a goalkeeper, a minor penalty shall be imposed.

Rule 66 – Forfeit of Game

66.1 Forfeit of Game - In the event of failure by a Club to comply with a provision of the League constitution, by-laws, resolutions, rules or regulations affecting the playing of a game, the Referee shall, if so directed by the Commissioner or his designee, refuse to permit the game to proceed until the offending Club comes into compliance with such provision.

Should the offending club persist in its refusal to come into compliance, the Referee shall, with the prior approval of the Commissioner or his designee, declare the game forfeited and the non-offending Club the winner. Should the Referee declare the game forfeited because both Clubs have refused to comply with such a provision, the visiting Club shall be declared the winner.

If the game is declared forfeited prior to its having commenced, the score shall be recorded as 1-0 and no player shall be credited with any personal statistics.

If the game was in progress at the time it is declared forfeited, the score shall be recorded as zero for the loser and 1, or such greater number of goals that had been scored by it, for the winner; however, the players on both Clubs shall be credited with all personal statistics earned up to the time the forfeit was declared.

Rule 67 – Handling Puck

67.1 Handling Puck - A player shall be permitted to stop or "bat" a puck in the air with his open hand, or push it along the ice with his hand, and the play shall not be stopped unless, in the opinion of the Referee, he has deliberately directed the puck to a teammate in any zone other than the defending zone, in which case the play shall be stopped and a face-off conducted (see Rule 79 – Hand Pass). Play will not be stopped for any hand pass by players in their own defending zone.

67.2 Minor Penalty – Player - A player shall be permitted to catch the puck out of the air but must immediately place it or knock it down to

the ice. If he catches it and skates with it, either to avoid a check or to gain a territorial advantage over his opponent, a minor penalty shall be assessed for “closing his hand on the puck”.

A minor penalty shall be imposed on a player who, while play is in progress, picks up the puck off the ice with his hand.

- 67.3 **Minor Penalty – Goalkeeper** - A goalkeeper who holds the puck with his hands for longer than three seconds shall be given a minor penalty unless he is actually being checked by an opponent. The object of this entire rule is to keep the puck in play continuously and any action taken by the goalkeeper which causes an unnecessary stoppage must be penalized without warning.

A goalkeeper shall be assessed a minor penalty when he deliberately holds the puck in any manner which, in the opinion of the Referee, causes an unnecessary stoppage of play.

A goalkeeper shall be assessed a minor penalty when he throws the puck forward towards the opponent's net. In the case where the puck thrown forward by the goalkeeper being taken by an opponent, the Referee shall allow the resulting play to be completed, and if goal is scored by the non-offending team, it shall be allowed and no penalty given; but if a goal is not scored, play shall be stopped and a minor penalty shall be imposed against the goalkeeper.

A goalkeeper shall be assessed a minor penalty when he deliberately drops the puck into his pads or onto the goal net.

A goalkeeper shall be assessed a minor penalty when he deliberately piles up snow or obstacles at or near his net that, in the opinion of the Referee, would tend to prevent the scoring of a goal.

- 67.4 **Penalty Shot** - If a player, except a goalkeeper, while play is in progress, falls on the puck, holds the puck, picks up the puck, or gathers the puck into his body or hands from the ice in the goal crease area, the play shall be stopped immediately and a penalty shot shall be awarded to the non-offending team. See also Rule 63 – Delaying the Game.

- 67.5 **Awarded Goal** – When a goalkeeper, prior to proceeding to his players' bench to be replaced by an extra attacker, intentionally leaves his stick or other piece of equipment, piles snow or other obstacles at or near his net that, in the opinion of the Referee, would tend to prevent the puck from entering the net, a goal shall be awarded. In order to award a goal in this situation, the goalkeeper must have been replaced for an extra attacker, otherwise a minor penalty shall be assessed.

If a player, when the goalkeeper has been replaced for an extra attacker, falls on the puck, holds the puck, picks up the puck, or gathers the puck into his body or hands from the ice in the goal crease area, the play shall be stopped immediately and goal awarded to the non-offending team.

- 67.6 **Disallowed Goal** - A goal cannot be scored by an attacking player who bats or directs the puck with his hand into the net. A goal cannot

be scored by an attacking player who bats or directs the puck and it is deflected into the net off any player, goalkeeper or official. When the puck enters the net on a clear deflection off a glove, the goal shall be allowed.

Rule 68 – Illegal Substitution

- 68.1 **Illegal Substitution** – An illegal substitution shall be deemed to have occurred when a player enters the game illegally from either the players' bench (teammate not within the five (5) foot limit, refer to Rule 74 – Too Many Men on the Ice), from the penalty bench (penalty has not yet expired), when a major penalty is being served and the replacement player does not return to the ice from the penalty bench (see 68.2), or when a player illegally enters the game for the sole purpose of preventing an opposing player from scoring on a breakaway (see 68.3 and 68.4).
- 68.2 **Bench Minor Penalty** – When a player receives a major penalty and a misconduct or game misconduct penalty at the same time, or when an injured player receives a major penalty and is unable to serve the penalty himself, the penalized team shall place a substitute player on the penalty bench before the major penalty expires and no replacement for the penalized player shall be permitted to enter the game except from the penalty bench. Any violation of this provision shall be treated as an illegal substitution under this rule calling for a bench minor penalty.
- 68.3 **Penalty Shot** – If a player of the attacking side in possession of the puck shall be in such a position as to have no opposition between him and the opposing goalkeeper, and while in such position he shall be interfered with by a player of the opposing side who shall have illegally entered the game, the Referee shall impose a penalty shot against the side to which the offending player belongs.
- 68.4 **Awarded Goal** - If, when the opposing goalkeeper has been removed from the ice, a player of the side attacking the unattended goal is interfered with in the neutral or attacking zone by a player who shall have entered the game illegally, the Referee shall immediately award a goal to the non-offending team.
- 68.5 **Disallowed Goal** – If a penalized player returns to the ice from the penalty bench before his penalty has expired by his own error or the error of the Penalty Timekeeper, any goal scored by his own team while he (or his substitute) is illegally on the ice shall be disallowed but all penalties imposed on either team shall be served as regular penalties.

In summary, a team cannot score when one of their players has left the penalty bench early, either by his own error or the error of the Penalty Timekeeper. The goal must be disallowed and the player must return to serve his unexpired time (and an additional minor penalty if he left on his own).

If a player shall illegally enter the game from his own players'

bench or from the penalty bench, any goal scored by his own team while he is illegally on the ice shall be disallowed but all penalties imposed on either team shall be served as regular penalties.

- 68.6 **Deliberate Illegal Substitution** – see Rule 74 – Too Many Men on the Ice.

Rule 69 – Interference on the Goalkeeper

- 69.1 **Interference on the Goalkeeper** - This rule is based on the premise that an attacking player's position, whether inside or outside the crease, should not, by itself, determine whether a goal should be allowed or disallowed. In other words, goals scored while attacking players are standing in the crease may, in appropriate circumstances be allowed. Goals should be disallowed only if: (1) an attacking player, either by his positioning or by contact, impairs the goalkeeper's ability to move freely within his crease or defend his goal; or (2) an attacking player initiates intentional or deliberate contact with a goalkeeper, inside or outside of his goal crease. Incidental contact with a goalkeeper will be permitted, and resulting goals allowed, when such contact is initiated outside of the goal crease, provided the attacking player has made a reasonable effort to avoid such contact. The rule will be enforced exclusively in accordance with the on-ice judgement of the Referee(s), and not by means of video replay or review.

For purposes of this rule, "contact," whether incidental or otherwise, shall mean any contact that is made between or among a goalkeeper and attacking player(s), whether by means of a stick or any part of the body.

The overriding rationale of this rule is that a goalkeeper should have the ability to move freely within his goal crease without being hindered by the actions of an attacking player. If an attacking player enters the goal crease and, by his actions, impairs the goalkeeper's ability to defend his goal, and a goal is scored, the goal will be disallowed.

If an attacking player has been pushed, shoved, or fouled by a defending player so as to cause him to come into contact with the goalkeeper, such contact will not be deemed contact initiated by the attacking player for purposes of this rule, provided the attacking player has made a reasonable effort to avoid such contact.

- 69.2 **Penalty** - In all cases in which an attacking player initiates intentional or deliberate contact with a goalkeeper, whether or not the goalkeeper is inside or outside the goal crease, and whether or not a goal is scored, the attacking player will receive a penalty (minor or major, as the Referee deems appropriate). In all cases where the infraction being imposed is to the attacking player for hindering the goalkeeper's ability to move freely in his goal crease, the penalty to be assessed is for goalkeeper interference.

In exercising his judgment, the Referee should give more

significant consideration to the degree and nature of the contact with the goalkeeper than to the exact location of the goalkeeper at the time of the contact.

- 69.3 Contact Inside the Goal Crease** - If an attacking player initiates contact with a goalkeeper, incidental or otherwise, while the goalkeeper is in his goal crease, and a goal is scored, the goal will be disallowed.

If a goalkeeper, in the act of establishing his position within his goal crease, initiates contact with an attacking player who is in the goal crease, and this results in an impairment of the goalkeeper's ability to defend his goal, and a goal is scored, the goal will be disallowed.

If, after any contact by a goalkeeper who is attempting to establish position in his goal crease, the attacking player does not immediately vacate his current position in the goal crease (i.e. give ground to the goalkeeper), and a goal is scored, the goal will be disallowed. In all such cases, whether or not a goal is scored, the attacking player will receive a minor penalty for goalkeeper interference.

If an attacking player establishes a significant position within the goal crease, so as to obstruct the goalkeeper's vision and impair his ability to defend his goal, and a goal is scored, the goal will be disallowed.

For this purpose, a player "establishes a significant position within the crease" when, in the Referee's judgment, his body, or a substantial portion thereof, is within the goal crease for more than an instantaneous period of time.

Refer also to Reference Tables – Table 18 – Interference on the Goalkeeper Situations (page 158).

- 69.4 Contact Outside the Goal Crease** - If an attacking player initiates any contact with a goalkeeper, other than incidental contact, while the goalkeeper is outside his goal crease, and a goal is scored, the goal will be disallowed.

A goalkeeper is not "fair game" just because he is outside the goal crease. The appropriate penalty should be assessed in every case where an attacking player makes unnecessary contact with the goalkeeper. However, incidental contact will be permitted when the goalkeeper is in the act of playing the puck outside his goal crease provided the attacking player has made a reasonable effort to avoid such unnecessary contact.

When a goalkeeper has played the puck outside of his crease and is then prevented from returning to his crease area due to the deliberate actions of an attacking player, such player may be penalized for goalkeeper interference. Similarly, the goalkeeper may be penalized, if by his actions outside of his crease he deliberately interferes with an attacking player who is attempting to play the puck or an opponent.

Refer also to Reference Tables – Table 18 – Interference on the

Goalkeeper Situations (page 158).

- 69.5 **Face-off Location** – Whenever the Referee stops play to disallow a goal as a result of contact with the goalkeeper (incidental or otherwise), the resulting face-off shall take place at the nearest neutral zone face-off spot outside the attacking zone of the offending team.
- 69.6 **Rebounds and Loose Pucks** - In a rebound situation, or where a goalkeeper and attacking player(s) are simultaneously attempting to play a loose puck, whether inside or outside the crease, incidental contact with the goalkeeper will be permitted, and any goal that is scored as a result thereof will be allowed.

In the event that a goalkeeper has been pushed into the net together with the puck by an attacking player after making a stop, the goal will be disallowed. If applicable, appropriate penalties will be assessed.

In the event that the puck is under a player in or around the crease area (deliberately or otherwise), a goal cannot be scored by pushing this player together with the puck into the goal. If applicable, the appropriate penalties will be assessed, including a penalty shot if deemed to be covered in the crease deliberately (see Rule 63 – Delaying the Game).

- 69.7 **Fines and Suspensions** - An attacking player who, in the judgment of the Referee, initiates contact with the goalkeeper, whether inside or outside the crease, in a fashion that would otherwise warrant a penalty, will be assessed an appropriate penalty (minor or major and/or game misconduct) and will be subject to additional sanctions as appropriate pursuant to Rule 29 – Supplementary Discipline.

Rule 70 – Leaving the Bench

- 70.1 **Leaving the Bench** - No player or goalkeeper may leave the players' or penalty bench at any time during an altercation or for the purpose of starting an altercation. Substitutions made prior to the altercation shall be permitted provided the players so substituting do not enter the altercation.
- 70.2 **Legal Line Change** – A player who has entered the game on a legal line change or legally from the penalty bench (penalty time has expired) who starts an altercation may be subject to discipline in accordance with Rule 29 – Supplementary Discipline.

A player or players who have entered the game on a legal line change during a stoppage of play, who line up in preparation for the ensuing face-off, and who participate in an altercation shall be penalized under the appropriate rule and will be subject to discipline in accordance with Rule 29 – Supplementary Discipline (a game misconduct is not automatic in this situation unless provided for as a result of his actions in the altercation).

- 70.3 **Leaving the Players' Bench** – Players shall not be permitted to come on the ice during a stoppage of play or at the end of the first and

second periods for the purpose of warming-up. The Referee will report any violation of this rule to the Commissioner for disciplinary action.

Except at the end of each period or for entering the game legally, no player or goalkeeper may, at any time, leave the players' bench. If it is necessary to proceed to the dressing room during the course of the game (and when it is required to proceed by way of the ice to access the dressing room), the player or goalkeeper must wait for a stoppage of play and ensure there are not altercations in progress before proceeding.

The player or goalkeeper who was the first or second player to leave the players' (or penalty bench) during an altercation or for the purpose of starting an altercation, from either or both teams shall be assessed a game misconduct penalty.

70.4 Leaving the Penalty Bench – Except at the end of each period or on expiration of his penalty, no player may, at any time, leave the penalty bench.

A player serving a penalty on the penalty bench, who is to be changed after the penalty has been served, must proceed at once by way of the ice and be at his own players' bench before any change can be made. For any violation of this rule, a bench minor penalty shall be imposed for too many men on the ice (see Rule 74 – Too Many Men on the Ice).

A penalized player who leaves the penalty bench before his penalty has expired, whether play is in progress or not, shall incur an additional minor penalty after serving his unexpired penalty.

Any player who, having entered the penalty bench, leaves the penalty bench prior to the expiration of his penalty for the purpose of challenging an official's ruling, shall be assessed a game misconduct penalty. He shall also be automatically suspended for the next three (3) regular League and/or playoff games of his Club. This rule does not replace any other more severe penalty that may be imposed for leaving the penalty bench for the purpose of starting or participating in an altercation as outlined in this rule.

Any penalized player leaving the penalty bench during a stoppage of play and during an altercation shall incur a minor penalty plus a game misconduct penalty. The minor penalty plus the unexpired time remaining in his original penalty must be served by a replacement player placed on the penalty bench by the Coach of the offending team.

If a player leaves the penalty bench before his penalty is fully served, the Penalty Timekeeper shall note the time and signal the officials who will stop play when the offending player's team obtains possession of the puck. An additional minor penalty must be served by this player in addition to the time remaining in his original penalty (this unexpired time is calculated from the time he left the penalty bench illegally).

In the case of a player returning to the ice before his time has

expired through an error of the Penalty Timekeeper, he is not to serve an additional penalty, but must serve his unexpired time this unexpired time is calculated from the time he left the penalty bench through the error of the Penalty Timekeeper).

At a stoppage of play following the expiration of their penalties, if a player or players exiting the penalty bench get involved in an altercation, those coming from the penalty bench shall be assessed the penalties they incur in the altercation in addition to a game misconduct and a ten (10) game suspension as outlined in **70.10**. Should a player coming from the penalty bench at a stoppage of play get involved with an opponent and the opponent is deemed to be the instigator of the altercation, then the player coming from the penalty bench would not be subject to the game misconduct and ten (10) game suspension.

- 70.5 Bench Minor Penalty** – A bench minor penalty shall be imposed on a team whose player(s) leave the players' bench for any purpose other than a change of players and when no altercation is in progress.

If a Coach or non-playing Club personnel gets on the ice (unless directed to do so by an on-ice official, i.e. to attend to an injured player or goalkeeper) after the start of a period and before that period is ended, the Referee shall impose a bench minor penalty against the team and report the incident to the Commissioner for disciplinary action.

- 70.6 Game Misconduct Penalty** – A game misconduct penalty shall be imposed on the player or goalkeeper who was the first or second player to leave the players' or penalty bench during an altercation or for the purpose of starting an altercation, from either or both teams.

Any penalized player leaving the penalty bench during a stoppage of play and during an altercation shall incur a minor penalty plus a game misconduct penalty. The minor penalty plus the unexpired time remaining in his original penalty must be served by a replacement player placed on the penalty bench by the Coach of the offending team.

Any player or goalkeeper who has been ordered to the dressing room by the officials and returns to his bench or to the ice surface for any reason before the appropriate time shall be assessed a game misconduct and shall be suspended automatically without pay for the next ten (10) regular League and/or Play-off games.

Once a player enters the penalty bench, he must not leave until his penalty expires and his team is entitled to an additional player on the ice, or, at the end of a period to proceed to his dressing room, or, when he has received permission from an on-ice official. At any other time, he shall be assessed a game misconduct penalty under this rule.

- 70.7 Penalty Shot** – If a player of the attacking side in possession of the puck shall be in such a position as to have no opposition between him and the opposing goalkeeper, and while in such position he shall be interfered with by a player of the opposing side who shall have illegally entered the game, the Referee shall impose a penalty shot against the



side to which the offending player belongs.

70.8 Awarded Goal – If, when the opposing goalkeeper has been removed from the ice, a player of the side attacking the unattended goal is interfered with in the neutral or attacking zone by a player who shall have entered the game illegally, the Referee shall immediately award a goal to the non-offending team.

70.9 Disallowed Goal – If a penalized player returns to the ice from the penalty bench before his penalty has expired by his own error or the error of the Penalty Timekeeper, any goal scored by his own team while he is illegally on the ice shall be disallowed but all penalties imposed on either team shall be served as regular penalties.

If a player shall illegally enter the game from his own players' bench or from the penalty bench, any goal scored by his own team while he is illegally on the ice shall be disallowed but all penalties imposed on either team shall be served as regular penalties.

70.10 Fines and Suspensions – The first player or goalkeeper to leave the players' or penalty bench during an altercation or for the purpose of starting an altercation from either or both teams shall be suspended automatically without pay for the next ten (10) regular League and/or Play-off games of his team.

The second player or goalkeeper to leave the players' or penalty bench during an altercation or for the purpose of starting an altercation from either or both teams shall be suspended automatically without pay for the next five (5) regular League and/or Play-off games.

The determination as to which players (or goalkeepers) shall be deemed the first or second players to have left their respective players' or penalty benches shall be made by the Referees in consultation with the Linesmen and off-ice officials. In the event that they are unable to identify the offending players, the matter will be referred to the Commissioner or his designee and such determinations may be made subsequently based on reports and other information including but not limited to television tapes.

Any team that has a player or goalkeeper penalized for being the first or second player to leave the players' or penalty bench during an altercation or for the purpose of starting an altercation, shall be fined ten thousand dollars (\$10,000) for the first instance. This fine shall be increased by five thousand dollars (\$5,000) for each subsequent occurrence over the next following three-year period.

All players (including goalkeepers) as well as the first and second players who leave the bench during an altercation or for the purpose of starting an altercation shall be subject to an automatic fine in the amount equal to the maximum permitted under the collective bargaining agreement.

Any player who leaves the penalty bench during an altercation and is not the first player to do so, shall be suspended automatically without pay for the next five (5) regular League and/or Play-off games.

Any Club executive or non-playing Club personnel not normally on

the players' bench, who gets on the ice after the start of a period and before that period is ended, will be automatically fined two hundred dollars (\$200) and the Referee will report the incident to the Commissioner for disciplinary action.

Any player or goalkeeper who has been ordered to the dressing room by the officials and returns to his bench or to the ice surface for any reason before the appropriate time shall be assessed a game misconduct and shall be suspended automatically without pay for the next ten (10) regular League and/or Play-off games.

The Coach(es) of the team(s) whose player(s) (including goalkeepers) left the players' bench(es) or penalty bench(es) during an altercation shall be suspended, pending a review by the Commissioner. The Coach(es) also will be fined a maximum of ten thousand dollars (\$10,000).

For all suspensions imposed on players or goalkeepers under this rule, the Club of the player or goalkeeper shall pay to the League a sum equal to the pro-rata of that player or goalkeeper's salary covered by the suspension. For purposes of computing amounts due for a player or goalkeeper's suspension, the player or goalkeeper's fixed salary shall be divided by the number of days in the regular season and then, said result shall be multiplied by the number of games suspended.

In addition, any Club that is deemed by the Commissioner to pay or reimburse to the player or goalkeeper the amount of the fine or loss of salary assessed under this rule shall be fined automatically one hundred thousand dollars (\$100,000).

In the event that suspensions imposed under this rule cannot be completed in regular League and/or Play-off games in any one season, the remainder of the suspension shall be served the following season.

Rule 71 – Premature Substitution

71.1 Premature Substitution - When a goalkeeper leaves his goal area and proceeds to his players' bench for the purpose of substituting another player, the skater cannot enter the playing surface before the goalkeeper is within five feet (5') of the bench. If the substitution is made prematurely, the official shall stop play immediately unless the non-offending team has possession of the puck -- in which event the stoppage will be delayed until the puck changes possession.

There shall be no time penalty to the team making the premature substitution, but the resulting face-off will take place at the center ice face-off spot when play is stopped beyond the center red line. When play is stopped prior to the center red line, the resulting face-off shall be conducted at the nearest face-off spot in the zone where the play was stopped.

In all other situations not covered in the above, a minor penalty may result for "too many men on the ice" (see Rule 74).



71.2 **Announcement** - The Referee shall request that the public address announcer make the following announcement: "Play has been stopped due to premature substitution for the goalkeeper."

Rule 72 – Refusing to Play the Puck

- 72.1 **Refusing or Abstaining from Playing the Puck** - The purpose of this section is to enforce continuous action and both Referees and Linesmen should interpret and apply the rule to produce this result.
- 72.2 **Hand Pass** – When a hand pass has been initiated by one player to a teammate and the teammate elects not to play the puck to avoid the stoppage of play, and the opposing team also abstains from playing the puck (perhaps to allow time to expire on a penalty), the Referee shall stop the play and order the resulting face-off at the nearest face-off location to where the play was stopped for this violation.
- 72.3 **High Stick** – When a player or goalkeeper contacts the puck with his stick above the normal height of the shoulders and a teammate elects not to play the puck to avoid the stoppage of play, and the opposing team also abstains from playing the puck (perhaps to allow time to expire on a penalty), the Referee shall stop the play and order the resulting face-off at the face-off spot in the zone to nearest to where the play was stopped for this violation. See also **76.2**.
- 72.4 **Icing** – If, in the opinion of the Referee, the defending side intentionally abstains from playing the puck on an icing promptly when they are in a position to do so, he shall stop the play and order the resulting face-off on the adjacent corner face-off spot nearest the goal of the team at fault.
- 72.5 **Penalty** – When the Referee signals the delayed calling of a penalty to one team and a player or goalkeeper of that team intentionally abstains from playing the puck in order to allow additional time to expire on the game or penalty time clocks, the Referee shall stop the play and order the resulting face-off at the nearest face-off location to where the play was stopped, or if it was stopped in the team's attacking zone, at the nearest face-off spot in the neutral zone.

Rule 73 – Refusing to Start Play

- 73.1 **Refusing to Start Play** – This rule applies to teams who refuse to play while both teams are on the ice or who withdraws from the ice and refuses to play or who refuses to come onto the ice at the start of the game or at the beginning of any period of the game, when ordered to do so by the Referee.
- 73.2 **Procedure – Team On Ice** - If, when both teams are on the ice, one team for any reason shall refuse to play when ordered to do so by the Referee, he shall warn the Captain and allow the team so refusing fifteen (15) seconds within which to begin the play or resume play. If at the end of that time, the team shall still refuse to play, the Referee shall impose a bench minor penalty for delay of game on a player of

the offending team to be designated by the Coach of that team through the playing Captain. Should there be a repetition of the same incident, the Referee shall notify the Coach that he has been fined the sum of two hundred dollars (\$200). The offending Coach shall be removed from the players' bench and assessed a game misconduct penalty.

Should the offending team still refuse to play, the Referee shall have no alternative but to declare that the game be forfeited to the non-offending Club and the case shall be reported to the Commissioner for further action (see Rule 66 – Forfeit of Game).

First Violation

- (i) Warn the Captain of the offending team and allow 15 seconds within which to resume play.
- (ii) If at the end of the 15 seconds the team still refuses to resume play, assess a bench minor penalty to the offending team for delay of game.

Second Violation

- (i) Warn the Captain of the offending team and allow 15 seconds within which to resume play.
- (ii) If at the end of the 15 seconds the team still refuses to resume play, assess a bench minor penalty to the offending team for delay of game.
- (iii) Referee is to notify the Coach of the offending team that he has been fined the sum of two hundred dollars (\$200) and the Coach is to be assessed a game misconduct penalty.
- (iv) If the team still refuses to play, the Referee shall declare the game be forfeited to the non-offending club (see Rule 66 – Forfeit of Game).

73.3 Procedure – Team Off Ice - If a team, when ordered to do so by the Referee through its Club Executive, Manager or Coach, fails to go on the ice and start play within five (5) minutes, the Club Executive, Manager or Coach shall be fined five hundred dollars (\$500), the game shall be forfeited and the case shall be reported to the Commissioner for further action (see Rule 66 – Forfeit of Game).

- (i) Once it is apparent to the Referee that the team is refusing to come onto the ice and begin play, a bench minor penalty is to be assessed to the offending team for delay of game.
- (ii) Five (5) minutes will be provided for the offending team to return to the ice and begin play.
- (iii) After the five (5) minutes has elapsed and the offending team still has not returned to the ice to resume play, the game shall be forfeited. The Commissioner of the League shall issue instructions pertaining to records, etc., of a forfeited game (see Rule 66 – Forfeit of Game).
- (iv) Once the Club Executive, Manager or Coach has been notified of the five (5) minute warning, and the team returns to the ice to resume play within that time frame, a bench minor penalty for delay of game must be assessed to the offending team.



- (v) *A fine of five hundred dollars (\$500) shall be applied to the Coach, Manager, or Club Executive responsible for the delay.*

Rule 74 – Too Many Men on the Ice

74.1 Too Many Men on the Ice - Players and goalkeepers may be changed at any time during the play from the players' bench provided that the player or players leaving the ice shall be within five feet (5') of his players' bench and out of the play before the change is made. Refer also to Rule 71 – Premature Substitution. At the discretion of the on-ice officials, should a substituting player come onto the ice before his teammate is within the five foot (5') limit of the players' bench (and therefore clearly causing his team to have too many players on the ice), then a bench minor penalty may be assessed.

When a player or goalkeeper is retiring from the ice surface and is within the five foot (5') limit of his players' bench, and his substitute is on the ice, then the retiring player or goalkeeper shall be considered off the ice for the purpose of Rule 70 – Leaving Bench.

If in the course of making a substitution, either the player entering the game or the player (or goalkeeper) retiring from the ice surface plays the puck with his stick, skates or hands or who checks or makes any physical contact with an opposing player while either the player entering the game or the retiring player is actually on the ice, then the infraction of "too many men on the ice" will be called.

If in the course of a substitution either the player(s) entering the play or the player(s) retiring is struck by the puck accidentally, the play will not be stopped and no penalty will be called.

During the play, the player retiring from the ice must do so at the players' bench and not through any other exit leading from the rink. This is not a legal player change and therefore when a violation occurs, a bench minor penalty shall be imposed.

A player coming onto the ice as a substitute player is considered on the ice once both of his skates are on the ice. If he plays the puck or interferes with an opponent while still on the players' bench, he shall be penalized under Rule 56 – Interference.

74.2 Bench Minor Penalty – A bench minor penalty for too many men on the ice shall be assessed for a violation of this rule. This penalty can be assessed by the Referees or the Linesmen. Should a goal be scored by the offending team prior to the Referee or Linesman blowing his whistle to assess the bench minor penalty, the goal shall be disallowed and the penalty assessed for too many men on the ice.

74.3 Penalty Bench - A player serving a penalty on the penalty bench, who is to be changed after the penalty has been served, must proceed at once by way of the ice and be within five feet (5') of his own players' bench before any change can be made. For any violation of this rule, a bench minor penalty shall be imposed for too many men on the ice.

- 74.4 **Deliberate Illegal Substitution** - If by reason of insufficient playing time remaining, or by reason of penalties already imposed, a bench minor penalty is imposed for deliberate illegal substitution (too many men on the ice) which cannot be served in its entirety within the legal playing time, or at any time in overtime, a penalty shot shall be awarded against the offending team.
- 74.5 **Goalkeeper in Regular Season Overtime** - Once the goalkeeper has been removed for an extra attacker in overtime during the Regular season, he must wait for the next stoppage of play before returning to his position. Any attempt by the goalkeeper to return to his position prior to the next stoppage of play ("on the fly") shall be deemed to be an illegal substitution and a bench minor penalty shall be assessed for having an ineligible player would apply.

Rule 75 – Unsportsmanlike Conduct

- 75.1 **Unsportsmanlike Conduct** – Players, goalkeepers and non-playing Club personnel are responsible for their conduct at all times and must endeavor to prevent disorderly conduct before, during or after the game, on or off the ice and any place in the rink. The Referees may assess penalties to any of the above team personnel for failure to do so.

NOTE: When such conduct is directed at an official, Rule **40** – Abuse of Officials shall be applied.

- 75.2 **Minor Penalty** - A minor penalty for unsportsmanlike conduct shall be assessed under this rule for the following infractions:
- (i) *Any identifiable player or goalkeeper who uses obscene, profane or abusive language or gestures directed at any person.*
 - (ii) *Any player or goalkeeper who is guilty of unsportsmanlike conduct including, but not limited to hair-pulling, biting, grabbing hold of a face mask, etc. If warranted, and specifically when injury results, the referee may apply Rule **21** – Match Penalties.*
 - (iii) *Any player or goalkeeper who throws any object onto the ice from the players' or penalty bench (or from any other off-ice location).*
 - (iv) *When a player, including a goalkeeper, is penalized for being the instigator of an altercation and who is wearing a face shield.*
 - (v) *A player who deliberately removes his jersey prior to participating in an altercation or who is clearly wearing a jersey that has been modified and does not conform to Rule **9** – Uniforms, shall be assessed a minor penalty for unsportsmanlike conduct and a game misconduct. If the altercation never materializes, the player would receive a minor penalty for unsportsmanlike conduct and a ten-minute misconduct for deliberately removing his jersey.*

If a penalized player is assessed an additional unsportsmanlike conduct penalty either before or after he begins serving his original penalty(ies), the additional minor penalty is added to his unexpired time and served consecutively.

75.3 Bench Minor Penalty - A bench minor penalty for unsportsmanlike conduct shall be assessed under this rule for the following infractions:

- (i) *When a player, goalkeeper, Coach or non-playing Club personnel throws any object onto the ice from the players' or penalty bench (or from any other off-ice location) during the progress of the game or during a stoppage of play.*
- (ii) *Any unidentifiable player or goalkeeper, or any Coach or non-playing Club personnel uses obscene, profane or abusive language or gesture directed towards any person.*
- (iii) *Whenever Coaches and/or non-playing Club personnel uses obscene or profane language or gestures anywhere in the rink.*

75.4 Misconduct Penalty - Misconduct penalties shall be assessed under this rule for the following infractions:

- (i) *Any player or goalkeeper who persists in using obscene, profane or abusive language directed towards any person after being assessed a minor or bench minor penalty under this Rule.*
- (ii) *Any player or goalkeeper who deliberately throws any equipment out of the playing area. At the discretion of the Referee, a game misconduct may be imposed.*
- (iii) *Any player or goalkeeper who, after warning by the Referee, persists in any course of conduct (including threatening or abusive language or gestures or similar actions) designed to incite an opponent into incurring a penalty.*
- (iv) *When a penalized player challenges or disputes the ruling of an official after he has already entered the penalty bench and play has resumed.*

75.5 Game Misconduct Penalty – Game misconduct penalties shall be assessed under this rule for the following infractions:

- (i) *If a player or goalkeeper persists in any course of conduct for which he was previously assessed a misconduct penalty.*
- (ii) *Any player or goalkeeper who uses obscene gestures on the ice or anywhere in the rink before, during or after the game. The Referee shall report the circumstances to the Commissioner of the League for further disciplinary action.*
- (iii) *Coaches and non-playing Club personnel who have previously been assessed a bench minor penalty for the use obscene or profane language or gestures anywhere in the rink. A confidential report to the Commissioner shall be completed and filed with the League for possible further disciplinary action.*
- (iv) *Any player or goalkeeper who attempts to or deliberately injures a Manager, Coach or other non-playing Club personnel in any manner. Details of such incident must be reported immediately to the Commissioner and may be subject to additional sanctions as per Rule 29 – Supplementary Discipline.*
- (v) *Any player, goalkeeper or non-playing Club personnel who directs obscene, profane or abusive language or gestures to any person after the expiration of the game. This action may occur on or off the ice.*



SECTION 9 – OTHER FOULS



Any player, goalkeeper or non-playing Club personnel penalized under this section may be subject to supplemental discipline under Rule 29.

- 75.6 **Reports** - It is the responsibility of all game officials and all Club officials to send a confidential report to the Commissioner setting out the full details concerning the use of obscene gestures or language by any player, goalkeeper, Coach or other team official. The Commissioner shall take such further disciplinary action as he shall deem appropriate.

SECTION 10 – GAME FLOW

Rule 76 – Face-offs

76.1 Face-off – The action of the Referee or Linesman in dropping the puck between the sticks of two opposing players to start or resume play. A face-off begins when the official indicates the location of the face-off and the officials and players take their appropriate positions. The face-off ends when the puck has been legally dropped.

A goalkeeper may not participate in a face-off.

76.2 Face-off Locations – All face-offs must be conducted on one of the nine (9) face-off spots located on the rink.

When an infringement of a rule has been committed or a stoppage of play has been caused by any player of the attacking side in the attacking zone, the ensuing face-off shall be made in the neutral zone on the nearest face-off spot.

When an infringement of a rule has been committed in the neutral zone by a player of either side, the ensuing face-off shall be made in the neutral zone on the nearest face-off spot that provides the least territorial advantage to the team causing the stoppage of play.

If an attacking player is to be penalized, and the play is stopped due to the actions of a defending player (i.e. puck frozen by the goalkeeper) the ensuing face-off will remain in the defending zone of the non-offending team. This is also true for situations whereby the attacking team is penalized after the play has been stopped in the attacking zone by an act by the defending team. The face-off would remain in the non-offending team's end zone.

When an infringement of a rule has been committed by players of both sides in the play resulting in the stoppage, the ensuing face-off will be made at the nearest face-off spot in that zone.

Once play is stopped and the face-off location has been determined, penalties assessed after the whistle has blown cannot alter the face-off location.

When stoppage occurs between the end face-off spots and near end of the rink, the puck shall be faced-off at the end face-off spot on the side where the stoppage occurs unless otherwise expressly provided by these rules.

No face-off shall be made within fifteen feet (15') of the goal or side boards nor anywhere other than at a face-off dot.

When a goal is illegally scored as a result of a puck being deflected directly off an official anywhere in the defending zone, the resulting face-off shall be made at the end face-off spot in the defending zone.

When the game is stopped for any reason not specifically covered in the official rules, the puck must be faced-off at a face-off spot in the zone nearest to where it was last played.

Following a stoppage of play, should one or both defensemen who are the point players or any player coming from the bench of the attacking team, enter into the attacking zone beyond the outer edge of the end zone face-off circle during an altercation, gathering or “scrum,” the ensuing face-off shall take place in the neutral zone near the blue line of the defending team. This rule also applies when an icing, an intentional off-side, or a high-sticking the puck violation (by the team of greater numerical strength of its opponent) has occurred, and the ensuing face-off is to be in the offending team’s defending zone. Should any of the non-offending players enter into the attacking zone beyond the outer edge of the end zone face-off circle during an altercation, gathering or “scrum,” the ensuing face-off shall take place in the neutral zone near the blue line of the defending team.

For a violation of Rule 71 – Premature Substitution, the resulting face-off will take place at the center ice face-off spot when play is stopped beyond the center red line. When play is stopped prior to the center red line, the resulting face-off shall be conducted at the nearest face-off spot in the zone where the play was stopped.

When play is stopped for an injured player, the ensuing face-off shall be conducted at the face-off spot in the zone nearest the location of the puck when the play was stopped. When the injured player’s team has possession of the puck in the attacking zone, the face-off shall be conducted at one of the face-off spots outside the blue line in the neutral zone. When the injured player is in his defending zone and the attacking team is in possession of the puck in the attacking zone, the face-off shall be conducted at one of the defending team’s end-zone face-off spots.

76.3 Procedure – As soon as the line change procedure has been completed by the Referee and he lowers his hand to indicate no further changes, the Linesman conducting the face-off shall blow his whistle. This will signal to both teams that they have no more than five (5) seconds to line up for the ensuing face-off. At the end of the five (5) seconds (or sooner if both centers are ready), the Linesman will conduct a proper face-off. If, however:

- (i) *One or both centers are not positioned for the face-off,*
- (ii) *One or both centers refrain from placing their stick on the ice,*
- (iii) *Any player has encroached into the face-off circle,*
- (iv) *Any player makes physical contact with an opponent, or*
- (v) *Any player is in an off-side position,*

the Linesman shall have the offending center(s) replaced immediately prior to dropping the puck.

In the last two (2) minutes of regulation time or any time in overtime, the Linesman will still blow his whistle to initiate the face-off, but the five (5) second time limit will not be enforced. However, players must abide by the verbal directions given by the Linesman in his attempt to conduct a fast and fair face-off.

76.4 Procedure – Centers – The puck shall be faced-off by the Referee or

the Linesman dropping the puck on the ice between the sticks of the players facing-off. Players facing-off will stand squarely facing their opponent's end of the rink approximately one stick length apart with the blade of their sticks on the ice.

When the face-off takes place in any of the end face-off circles, the players taking part shall take their position so that they will stand squarely facing their opponent's end of the rink, and clear of the ice markings. The sticks of both players facing-off shall have the blade on the ice, within the designated white area. The visiting player shall place his stick within the designated white area first followed immediately by the home player.

If a player facing-off fails to take his proper position immediately when directed by the official, the official may order him replaced for that face-off by any teammate then on the ice.

If a center is not at the designated face-off area once the five (5) second time limit has elapsed, the Linesman will drop the puck immediately. If the center is back from the face-off dot, is "quarterbacking" or refuses to come into the face-off area when instructed to do so by the Linesman, or the center is simply slow getting to the face-off dot when the five (5) seconds has elapsed, the puck shall be dropped. If the center attempts to arrive at the face-off dot just as the five seconds elapses in an attempt to gain an advantage to win the face-off, he is to be removed from the face-off and replaced, resulting in a face-off violation.

If a player is ejected from the face-off, his replacement must come into position quickly or risk having the puck dropped by the Linesman without the player being set, or ejected from the face-off by the Linesman resulting in a bench minor penalty for delay of game for a second face-off violation during the same face-off.

76.5 Procedure – Other Players – No other player shall be allowed to enter the face-off circle or come within fifteen feet (15') of the players facing-off. All players must stand on-side on all face-offs.

During end-zone face-offs, all other players on the ice must position their bodies on their own side of the restraining lines marked on the outer edge of the face-off circles.

If a player other than the player taking the face-off moves into the face-off circle prior to the dropping of the puck, then the offending team's player taking the face-off shall be ejected from the face-off circle. This shall be considered a face-off violation.

Players on the attacking team (exclusive of the center) must establish their position first and then the defending team may counter and hold its position until the puck is dropped. A violation of this procedure shall be treated as face-off encroachment and the Linesman shall order the center of the offending team replaced. Should an attacking player attempt to establish a new position prior to the face-off, and the defending center steps back from the face-off dot in order to reposition his teammates, the face-off violation shall be charged to the attacking team as they must establish their position

first.

- 76.6 Violations** – If a center should move prematurely prior to the face-off, or if the Referee or Linesman shall have dropped the puck unfairly, the face-off shall be considered a face-off violation and it must be conducted again.

When a least two face-off violations have been committed by the same team during the same face-off, this team shall be penalized with a bench minor penalty to the offending team. This penalty shall be announced as a “Bench Minor Penalty for Delay of Game – Face-off Violation.”

Face-off violations shall be summarized as follows (any of the four on-ice officials may identify a face-off violation):

- (i) *Encroachment by any player other than the center into the face-off area prior to the puck being dropped. Players on the perimeter of the face-off circle must keep both skates outside the face-off circle (skate contact with the line is permitted). If a player's skate crosses the line into the face-off circle prior to the drop of the puck, this shall be deemed as a face-off violation. A player's stick may be inside the face-off circle provided there is no physical contact with his opponent or his opponent's stick.*
- (ii) *Encroachment by any player into the area between the hash marks on the outer edges of the face-off circle prior to the puck being dropped. Players must also ensure that both of their skates do not cross their respective hash marks. Contact with the line with their skate is permitted. If a player's skate crosses the line into the area between the hash marks prior to the drop of the puck, this shall be deemed as a face-off violation. A player's stick may be inside the area between the hash marks provided there is no physical contact with his opponent or his opponent's stick.*
- (iii) *Any physical contact with an opponent prior to the puck being dropped.*
- (iv) *Failure by either center taking the face-off to properly position himself behind the restraining lines or place his stick on the ice (as outlined in Rule 76.4). "Properly position himself behind the restraining lines" shall mean that the center must place his feet on either side of the restraining lines that are parallel to the side boards (contact with the lines is permissible), and the toe of the blade of his skates must not cross over the restraining lines that are perpendicular to the side boards as he approaches the face-off spot.*

The blade of the stick must then be placed on the ice (at least the toe of the blade of the stick) in the designated white area of the face-off spot and must remain there until the puck is dropped.

Failure to comply with this positioning and face-off procedure will result in a face-off violation.

Whenever a team has committed two face-off violations during the same face-off, the Referee shall immediately assess the offending team a bench minor penalty for delay of game. This penalty shall be announced as a “Bench Minor Penalty for Delay of Game – Face-off Violation.”

Players who are in an off-side position for the ensuing face-off will

be warned once in the game by the Referee. This warning will also be given to the offending team's Coach. Any subsequent violation shall result in a bench minor penalty for delay of game being assessed to the offending team. This penalty shall be announced as a "Bench Minor Penalty for Delay of Game – Slow Proceeding to Face-off Location."

In the conduct of any face-off at any of the nine (9) face-off spots on the playing surface, no player facing-off shall make any physical contact with his opponent's body by means of his own body or by his stick except in the course of playing the puck after the face-off has been completed.

For violation of this rule, the Referee may, at his discretion impose a minor penalty or penalties on the player(s) whose action(s) caused the physical contact. Nonetheless, this physical contact prior to the dropping of the puck shall be deemed as a face-off violation and the Linesman shall order the center of the offending team replaced.

Face-off encroachment may be applied during face-offs at any of the nine (9) face-off spots on the playing surface. However, since no such lines are painted on the ice at the four (4) face-off spots adjacent to the blue lines, Linesmen shall use their judgment as to whether or not a violation has occurred. All players, other than the centers, shall be uniformly back from the face-off location similar to being outside the face-off circle for face-offs in the end zones.

- 76.7 **Line Changes** – No substitution of players shall be permitted until the face-off has been completed and play has resumed except when a penalty is imposed which affects the on-ice strength of either team.

Should an on-ice official notice that the defending team has not placed enough players on the ice for the ensuing face-off, the Referee in the neutral zone shall be notified and he will instruct the offending team to place another player(s) on the ice. If, in the opinion of the Referee that this is being done as a stalling tactic, he will issue a warning to the offending team's Coach and any subsequent violations shall result in the assessment of a bench minor penalty for delay of game.

Should an on-ice official notice that the attacking team has not placed enough players on the ice for the ensuing face-off, the Linesman will proceed with conducting the face-off in the normal manner. The attacking team must ensure they put the appropriate number of players on the ice at all times.

- 76.8 **Verification of Time** - Any loss of time on the game or penalty clocks due to a false face-off or face-off violation must be replaced. The Video Goal Judge may be consulted to ensure the time is accurately replaced.

The whistle will not be blown by the official to start play. Playing time will commence from the instant the puck is faced-off and will stop when the whistle is blown or a goal is scored.



Rule 77 – Game and Intermission Timing

- 77.1 Game Timing** – The time allowed for a game shall be three (3) twenty-minute periods of actual play with a rest intermission between periods.
- 77.2 Intermission Timing** – Play shall be resumed promptly following each intermission upon the expiration of seventeen (17) minutes or a length of time designated by the League from the completion of play in the preceding period. Timing of the intermission commences immediately upon the conclusion of the period. (See Rule 35 – Game Timekeeper.) Preliminary warnings shall be given by the Game Timekeeper to the officials and to both teams five (5) minutes and two (2) minutes prior to the resumption of play in each period to enable the teams to start play promptly.

For the purpose of keeping the spectators informed as to the time remaining during intermissions, the Game Timekeeper will use the electronic clock to record length of intermissions.

- 77.3 Delays** - If any unusual delay occurs within five (5) minutes of the end of the first or second periods, the Referee may order the next regular intermission to be taken immediately. The balance of the period will be completed on the resumption of play with the teams defending the same goals after which the teams will change ends and resume play of the ensuing period without delay.

If a delay takes place with more than five (5) minutes remaining in the first or second period, the Referee will order the next regular intermission to be taken immediately only when requested to do so by the home Club.

Rule 78 – Goals

- 78.1 Goals and Assists** - It is the responsibility of the Official Scorer to award goals and assists, and his decision in this respect is final, notwithstanding the report of the Referee or any other game official. The use of video replay to verify the proper awarding of a goal or an assist is essential. Such awards shall be made or withheld strictly in accordance with the provisions of this rule. Therefore, it is essential that the Official Scorer be thoroughly familiar with every aspect of this rule; be alert to observe all actions which could affect the awarding of a goal or assist; and, above all, give or withhold awards with absolute impartiality.

In case of an obvious error in awarding a goal or an assist that has been announced, it should be corrected promptly, but changes should not be made in the official scoring summary after the Referee has signed the game report (except by the League's Chief Statistician).

The team scoring the greatest number of goals during the three (3) twenty-minute periods shall be the winner and shall be credited with two points in the League standings. In the event a winner during the regular season is determined in the overtime period or the shootout,

the winning team shall be credited with two points in the League standings and the losing team will be credited with one point in the League standings.

- 78.2 **Crediting Goals** - A “goal” shall be credited in the scoring records to a player who shall have propelled the puck into the opponent’s goal. Each “goal” shall count one point in the player’s record. Only one point can be credited to any one player on a goal.
- 78.3 **Crediting Assists** - When a player scores a goal, an “assist” shall be credited to the player or players taking part in the play immediately preceding the goal, but no more than two assists can be given on any goal. Each “assist” shall count one point in the player’s record. Only one point can be credited to any one player on a goal.
- 78.4 **Scoring a Goal** - A goal shall be scored when the puck shall have been put between the goal posts by the stick of a player of the attacking side, from in front and below the crossbar, and entirely across a red line the width of the diameter of the goal posts drawn on the ice from one goal post to the other with the goal frame in its proper position. The goal frame shall be considered in its proper position when the flexible peg(s) are still in contact with both the goal post and the hole in the ice. The flexible pegs could be bent, but as long as they are still making contact with both the hole in the ice and the goal post, the goal frame shall be deemed to be in its proper position. The goal frame could be raised somewhat on one post (or both), but as long as the flexible pegs are still in contact with the holes in the ice and the goal posts, the goal frame shall not be deemed to be displaced.

A goal shall be scored if the puck is put into the goal in any way by a player of the defending side. The player of the attacking side who last played the puck shall be credited with the goal but no assist shall be awarded.

If an attacking player has the puck deflect into the net, off his skate or body, in any manner, the goal shall be allowed. The player who deflected the puck shall be credited with the goal.

Should a player legally propel a puck into the goal crease of the opponent Club and the puck should become loose and available to another player of the attacking side, a goal scored on the play shall be legal.

- 78.5 **Disallowed Goals** – Apparent goals shall be disallowed by the Referee and the appropriate announcement made by the Public Address Announcer for the following reasons:
- (i) *When the puck has been directed, batted or thrown into the net by an attacking player other than with a stick.*
 - (ii) *When the puck has been kicked using a distinct kicking motion.*
 - (iii) *When the puck has deflected directly into the net off an official.*
 - (iv) *When a goal has been scored and an ineligible player is on the ice.*
 - (v) *When an attacking player has interfered with a goalkeeper in his goal crease.*

- (vi) *When the puck has been directed into the net by a stick of an attacking player that is above the height of the crossbar.*
- (vii) *When video review confirms the scoring of a goal at one end of the ice, any goal scored at the other end on the same play must be disallowed.*
- (viii) *When a Linesman reports a double-minor penalty for high-sticking, a major penalty or a match penalty to the Referee following the scoring of a goal by the offending team, the goal must be disallowed and the appropriate penalty assessed.*
- (ix) *When a goalkeeper has been pushed into the net together with the puck after making a save.*
- (x) *When the net becomes displaced accidentally. The goal frame is considered to be displaced if either or both goal pegs are no longer in their respective holes in the ice, or the net has come completely off one or both pegs, prior to or as the puck enters the goal.*
- (xi) *During the delayed calling of a penalty, the offending team cannot score unless the non-offending team shoots the puck into their own net. This shall mean that a deflection off an offending player or goalkeeper, or any physical action by an offending player that may cause the puck to enter the non-offending team's goal, shall not be considered a legal goal. Play shall be stopped before the puck enters the net (whenever possible) and the signaled penalty assessed to the offending team.*
- (xii) *When the Referee deems the play has been stopped, even if he had not physically had the opportunity to stop play by blowing his whistle.*
- (xiii) *Any goal scored, other than as covered by the official rules, shall not be allowed.*

78.6 Video Review - No goal may be awarded (or disallowed) as a result of video review once the puck has been dropped and play has resumed following the first stoppage of play after the potential goal. See Rule 39.

When a team scores an apparent goal that is not seen by the on-ice officials and play continues, the play shall be reviewed by the Video Goal Judge at the next stoppage of play. If the goal is confirmed by video review, the clock is re-set to the time the goal was scored. If the goal is not confirmed by video review, no adjustment is required to the clock time.

Only one goal can be awarded at any stoppage of play. If the apparent goal was scored by Team A, and is subsequently confirmed as a goal by the Video Goal Judge, any goal scored by Team B during the period of time between the apparent goal by Team A and the stoppage of play (Team B's goal), the Team B goal would not be awarded. However, if the apparent goal by Team A is deemed to have entered the goal, albeit illegally (i.e. distinct kicking motion), the goal shall be disallowed by the Video Goal Judge and since the play should have stopped for this disallowed goal, no goal can be awarded to Team B on the same play. The clock must be re-set to the time of the disallowed Team A goal and play resumed.

Any penalties signaled during the period of time between the apparent goal and the next stoppage of play shall be assessed in the normal manner, except when a minor penalty is to be assessed to the team scored upon, and is therefore nullified by the scoring of the goal. If an infraction happens after the first stoppage of play following an apparent goal (infraction after the whistle) by either team, it is assessed and served in the normal manner regardless as to the decision rendered by the Video Goal Judge.

Rule 79 – Hand Pass

79.1 Hand Pass - A player shall be permitted to stop or “bat” a puck in the air with his open hand, or push it along the ice with his hand, and the play shall not be stopped unless, in the opinion of the Referee, he has directed the puck to a teammate.

A player shall be permitted to catch the puck out of the air but must immediately place it or knock it down to the ice. If he catches it and skates with it, either to avoid a check or to gain a territorial advantage over his opponent, a minor penalty shall be assessed for “closing his hand on the puck” under Rule 67 – Handling Puck.

79.2 Defending Zone - Play will not be stopped for any hand pass by players in their own defending zone. A hand pass in the defending zone is considered to have occurred when both the player making the pass and the player receiving the pass have both of their skates inside their defending zone.

79.3 Face-Off Location – When a hand pass violation has occurred, the ensuing face-off shall take place at the nearest face-off spot in the zone where the offense occurred, unless the offending team gains a territorial advantage, then the face-off shall be at the nearest face-off spot in the zone where the stoppage of play occurred, unless otherwise covered in the rules. When a hand pass violation occurs by a team in their attacking zone, the ensuing face-off shall be conducted at one of the face-off spots outside the defending team’s blue line in the neutral zone.

Rule 80 – High-sticking the Puck

80.1 High-sticking the Puck – Batting the puck above the normal height of the shoulders with a stick is prohibited. When a puck is struck with a high stick and subsequently comes into the possession and control of a player from the offending team (including the player who made contact with the puck), either directly or deflected off any player or official, there shall be a whistle.

When a puck has been contacted by a high stick, the play shall be permitted to continue, provided that:

- (i) *the puck has been batted to an opponent (when a player bats the puck to an opponent, the Referee shall give the “washout” signal immediately. Otherwise, he will stop the play).*

- (ii) *a player of the defending side shall bat the puck into his own goal in which case the goal shall be allowed.*

Cradling the puck on the blade of the stick (like lacrosse) above the normal height of the shoulders shall be prohibited and a stoppage of play shall result. If this is done by a player on a penalty shot or shootout attempt, the shot shall be stopped immediately and considered complete.

- 80.2 **Face-Off Location** - If a territorial advantage is gained by the offending team, the ensuing face-off will take place at the nearest face-off spot in the zone where the high stick occurred. If a territorial disadvantage occurs to the offending team, the ensuing face-off will take place at the nearest face-off spot in the zone where the puck is touched.
- 80.3 **Disallowed Goal** – When an attacking player causes the puck to enter the opponent's goal by contacting the puck above the height of the crossbar, either directly or deflected off any player or official, the goal shall not be allowed. The determining factor is where the puck makes contact with the stick. If the puck makes contact with the stick below the level of the crossbar and enters the goal, this goal shall be allowed.

A goal scored as a result of a defending player or goalkeeper striking the puck with his stick carried above the height of the crossbar of the goal frame into his own goal shall be allowed.

- 80.4 **Numerical Advantage** - When either team is below the numerical strength (short-handed) of its opponent and a player of the team of greater numerical strength (power-play) causes a stoppage of play by striking the puck with his stick above the height of his shoulder, the resulting face-off shall be made at one of the end zone face-off spots adjacent to the goal of the team causing the stoppage. The numerical strength is determined at the time the play is stopped (not necessarily when the puck was struck with the high stick).

Should a player of the team of greater numerical strength (power-play) cause a stoppage of play by striking the puck with his stick above the height of his shoulder, and in so doing causes the puck to go out of play, the resulting face-off shall still be made at one of the end zone face-off spots adjacent to the goal of the team causing the stoppage.

Should a player of the team of greater numerical strength (power-play) cause a stoppage of play by striking the puck with his stick above the height of the crossbar, and in so doing causes the puck to enter the goal, the goal shall be disallowed and the resulting face-off shall still be made at one of the end zone face-off spots adjacent to the goal of the team causing the stoppage.

Rule 81 – Icing

- 81.1 **Icing** – For the purpose of this rule, the center red line will divide the ice into halves. Should any player or goalkeeper of a team, equal or

superior in numerical strength (power-play) to the opposing team, shoot, bat or deflect the puck from his own half of the ice beyond the goal line of the opposing team, play shall be stopped.

For the purpose of this rule, the point of last contact with the puck by the team in possession shall be used to determine whether icing has occurred or not. As such, the team in possession must “gain the line” in order for the icing to be nullified. “Gaining the line” shall mean that the puck (not the player’s skate) must make contact with the center red line in order to nullify a potential icing.

For the purpose of interpretation of the rule, “icing the puck” is completed the instant the puck is touched first by a defending player (other than the goalkeeper) after it has crossed the goal line and if in the action of so touching the puck, it is knocked or deflected into the net, it is no goal.

The puck striking or deflecting off an official does not automatically nullify a potential icing.

- 81.2 **Face-Off Location** – The resulting face-off following an icing call shall be at the end face-off spot of the offending team, unless on the play, the puck shall have entered the net of the opposing team, in which case the goal shall be allowed.

If during the period of a delayed whistle due to a foul by a player or goalkeeper of the side not in possession, the side in possession “ices” the puck, then the face-off following the stoppage of play shall take place in the neutral zone near the defending blue line of the team icing the puck.

If, in the opinion of the Referee, the defending side intentionally abstains from playing the puck promptly when they are in a position to do so, he shall stop the play and order the resulting face-off on the adjacent corner face-off spot nearest the goal of the team at fault.

If the Linesman shall have erred in calling an “icing the puck” infraction (regardless of whether either team is short-handed), the puck shall be faced-off on the center ice face-off spot.

- 81.3 **Goalkeeper** - If, in the opinion of the Linesman, the goalkeeper feigns playing the puck, attempts to play the puck, or skates in the direction of the puck on an icing at any time, the potential icing shall not be called and play shall continue.

If, however, a goalkeeper is legitimately out of the crease in an attempt to go to the players’ bench to be substituted for an extra attacker and in no way makes an attempt to play the puck, the icing should not be nullified under this section.

If the goalkeeper is out of his crease prior to the shot being taken, and simply retreats to his crease making no attempt to play the puck or feign playing the puck, the potential icing shall remain in effect.

- 81.4 **Line Change on Icing** - A team that is in violation of this rule shall not be permitted to make any player substitutions prior to the ensuing face-off. Should the stoppage of play following the icing infraction

coincide with a commercial time-out, or should the offending team elect to utilize their team time-out at this stoppage of play, they are still not permitted to make any player substitutions. However, a team shall be permitted to make a player substitution to replace a goalkeeper who had been substituted for an extra attacker, to replace an injured player or goalkeeper, or when a penalty has been assessed which affects the on-ice strength of either team. The determination of players on ice will be made when the puck leaves the offending player's stick.

- 81.5 **No Icing** – When the puck is shot and rebounds from the body or stick of an opponent in his own half of the ice so as to cross the goal line of the player shooting, it shall not be considered “icing.”

When a puck is shot by a team from their own half of the ice and is deflected several times before crossing the center red line, icing shall be nullified if at least one of these deflections was off an opposing player.

If a player of the side shooting the puck down the ice who is on-side and eligible to play the puck does so before it is touched by an opposing player, the play shall continue and it shall not be considered a violation of this rule.

If the puck shall go beyond the goal line in the opposite half of the ice directly from either of the players while facing-off, it shall not be considered a violation of this rule.

If, in the opinion of the Linesman, any player (other than the goalkeeper) of the opposing team is able to play the puck before it passes his goal line, but has not done so, play shall continue and the icing violation shall not be called. This includes the situation whereby the opposing team, while in the process of making player substitutions during the play, are able to play the puck, but choose not to do so to avoid being called for too many men on the ice. Icing should not be called.

The Linesman shall have discretion to wave off apparent icing infractions on attempted passes if those passes are deemed receivable (attainable). In order for the Linesman to wash out the icing for this reason, the receiving player's stick must be on the attacking side of the center red line and he must be eligible to receive the pass (e.g. he cannot be in an off-side position and cannot be involved in a player change that would result in a too many men on the ice penalty if he were to play the puck).

If the puck touches any part of a player of the opposing side, including his skates or his stick, or if it touches any part of the opposing team's goalkeeper, including his skates or his stick, at any time before or after crossing the goal line, it shall not be considered icing.

If a goalkeeper takes any action to dislodge the puck from the back of the net, icing shall not be called.

- 81.6 **Numerical Strength** – If the puck was so shot by a player or goalkeeper of a side below the numerical strength of the opposing

team, play shall continue and the icing violation shall not be called.

When a team is “short-handed” as the result of a penalty and the penalty is about to expire, the decision as to whether there has been an “icing” shall be determined at the instant the penalty expires. The action of the penalized player remaining in the penalty box will not alter the ruling.

When a team is “short-handed” by reason of a major penalty, and they have neglected to ensure there is a player on the penalty bench to exit upon the expiry of the penalty, they will continue to play short-handed but are not permitted to ice the puck. Icing will be called. They may substitute for this penalized player at the next stoppage of play. See Rule **20.3** – Major Penalties.

Rule 82 – Line Changes

82.1 Line Change - Following the stoppage of play, the visiting team shall promptly place a line-up on the ice ready for play and no substitution shall be made from that time until play has been resumed. The home team may then make any desired substitution, except in cases following an icing, which does not result in the delay of the game.

“Placing a line-up on the ice” shall mean that both teams shall place the full complement of players (and not exceed) to which they are entitled within the line change time frame.

If there is any undue delay by either team in changing players, the Referee shall order the offending team or teams to take their positions immediately and not permit any further player changes.

When a substitution has been made under the above rule, no additional substitution may be made until play commences.

Once the line change procedure has been completed (**82.2**), no additional player substitutions shall be permitted until the face-off has been completed legally and play has resumed, except when a penalty or penalties are imposed that affect the on-ice strength of either or both teams. This may include penalties imposed following the completion of the line change and prior to the face-off, or due to a penalty assessed for a face-off violation.

A team that is in violation of Rule **81** – Icing shall not be permitted to make any player substitutions prior to the ensuing face-off. However, a team shall be permitted to make a player substitution to replace a goalkeeper who had been substituted for an extra attacker, to replace an injured player or goalkeeper, or when a penalty has been assessed which affects the on-ice strength of either team. The determination of players on ice will be made when the puck leaves the offending player’s stick.

Goalkeepers’ substitution during a game will be conducted within the same time frame as a regular line change. No extra time will be allotted to the goalkeeper coming off the bench, except in the case where an injury to a goalkeeper occurs.

82.2 Procedure - Following a stoppage of play, the Referee will enforce the following line change procedure once he has determined that this procedure may begin:

- (i) *The Referee shall give the visiting team up to five (5) seconds to make its line change.*
- (ii) *The Referee shall raise his hand to indicate no further changes by the visiting team and to commence the home team's line change.*
- (iii) *The Referee shall give the home team up to eight (8) seconds to make its line change.*
- (iv) *The Referee shall lower his hand to indicate no further changes by the home team.*
- (v) *Any attempt by the either team to make a change after the Referee's signal, attempt to place too many men on the ice for the subsequent line change, or attempt to make additional personnel changes, shall not be permitted and the Referee will send the players who have attempted to change back to their players' bench. The Referee will then issue a warning to the offending team (through the Coach) indicating that any subsequent violations during the rest of the game (including overtime), shall result in a bench minor penalty for delaying the game. This penalty shall be announced as a "Bench Minor Penalty for Delay of Game – Improper Line Change."*
- (vi) *The Linesman conducting the face-off will blow his whistle (once the Referee has lowered his hand for the line changes) to indicate that all players must be in position and on-side for the face-off within five (5) seconds. The face-off will then be conducted in accordance with Rule 76 – Face-offs.*
- (vii) *Players who are slow (after the five-second warning whistle given by the Linesman) getting to the face-off location or who are in an off-side position for the ensuing face-off will be warned once in the game by the Referee. This warning will also be given to the offending team's Coach. Any subsequent violation shall result in a bench minor penalty for delay of game being assessed to the offending team.*
- (viii) *In the last two (2) minutes of regulation time and any time in the overtime period(s), points (vi) and (vii) above are not applicable. The Linesman shall give the teams a reasonable amount of time to set up for the ensuing face-off after points (1) through (5) above have been enforced.*

82.3 Bench Minor Penalty - Any attempt by the visiting team to make a change after the Referee's signal shall result in the assessment of a bench minor penalty for delay of game.

Players must proceed directly to the location of the face-off to participate in the ensuing face-off. Any attempts to delay the game by stalling or otherwise unnecessary actions by either team shall result in the assessment of a bench minor penalty for delaying the game. This penalty shall be announced as a "Bench Minor Penalty for Delay of Game – Slow Proceeding to Face-off Location (or, Slow Proceeding to Players' Bench)."

Rule 83 – Off-side

83.1 Off-side - Players of the attacking team must not precede the puck into the attacking zone.

The position of the player's skates and not that of his stick shall be the determining factor in all instances in deciding an off-side. A player is off-side when both skates are completely over the leading edge of the blue line involved in the play.

A player is on-side when either of his skates are in contact with, or on his own side of the line, at the instant the puck completely crosses the leading edge of the blue line regardless of the position of his stick. However, a player actually controlling the puck who shall cross the line ahead of the puck shall not be considered "off-side," provided he had possession and control of the puck prior to his skates crossing the blue line.

It should be noted that while the position of the player's skates is what determines whether a player is "off-side," nevertheless the question of an "off-side" never arises until the puck has completely crossed the leading edge of the blue line at which time the decision is to be made.

If a player legally carries or passes the puck back into his own defending zone while a player of the opposing team is in such defending zone, the off-side shall be ignored and play permitted to continue.

83.2 Deflections / Rebounds – If a puck clearly rebounds off a defending player in the neutral zone back into the defending zone, all attacking players are eligible to play the puck. However, any action by an attacking player that causes a deflection/rebound off a defending player in the neutral zone back into the defending zone (i.e. stick check, body check, physical contact), a delayed off-side shall be signaled by the Linesman.

A puck that deflects back into the defending zone off an official who is in the neutral zone will be off-side (or delayed off-side, as appropriate).

83.3 Delayed Off-Side – A situation where an attacking player (or players) has preceded the puck across the attacking blue line, but the defending team is in a position to bring the puck back out of its defending zone without any delay or contact with an attacking player, or, the attacking players are in the process of clearing the attacking zone.

If an off-side call is delayed, the Linesman shall drop his arm to nullify the off-side violation and allow play to continue if:

- (i) *All players of the offending team clear the zone at the same instant (skate contact with the blue line) permitting the attacking players to re-enter the attacking zone, or*
- (ii) *The defending team passes or carries the puck into the neutral zone.*

If the attacking team does not clear the attacking zone, play shall be stopped for the off-side violation if any attacking player touches the puck, or attempts to gain possession of a loose puck while the puck is still in the attacking zone, or forces the defending puck carrier further back into the attacking zone, or who is about to make physical contact with the defending puck carrier.

If, during a delayed off-side, an attacking player in the attacking zone elects to proceed to his players' bench (which extends into the attacking zone) to be replaced by a teammate, he shall be considered to have cleared the zone provided he is completely off the ice and his replacement comes onto the ice in the neutral zone. If his replacement comes onto the ice in the attacking zone, if the delayed off-side is still in effect, he too must clear the attacking zone. If the remaining attacking players have cleared the attacking zone and the Linesman has lowered his arm for the delayed off-side, he shall be considered on-side.

- 83.4 Disallowed Goal** – If the puck is shot on goal during a delayed off-side, the play shall be allowed to continue under the normal clearing-the-zone rules. Should the puck, as a result of this shot, enter the defending team's goal during a delayed off-side, either directly or off the goalkeeper, a player or an official on the ice, the goal shall be disallowed as the original shot was off-side. The face-off will be conducted at the face-off spot in the zone closest to the point of origin of the shot or at the nearest face-off spot in the neutral zone adjacent to the attacking zone of the offending team.

The only way an attacking team can score a goal on a delayed off-side situation is if the defending team shoots or puts the puck into their own net without action or contact by the offending team.

Other than in situations involving a delayed off-side and the puck being shot on goal, no goal can be disallowed after the fact for an off-side violation, except for the human factor involved in blowing the whistle.

- 83.5 Face-Off Location** - For violation of this rule, the play is stopped and the puck shall be faced-off in the neutral zone at the face-off spot nearest the attacking zone of the offending team, or from the face-off spot in the zone closest to the point of origin of the shot or pass (even if deflected off an attacking or defending player or an official).

For every delayed off-side situation, including an intentional off-side, the Linesman will raise his non-whistle arm. He will allow play to continue and, if a stoppage of play occurs, there will be three possible face-off locations:

- (i) *When an intentional off-side has been called, the face-off location will be on the face-off spot of the offending team's defending zone.*
- (ii) *If an errant pass or shoot-in by an attacking player makes unintentional contact with another attacking player who preceded the puck into the attacking zone, or if the pass or shoot-in goes out of playing area, the whistle shall be blown and the ensuing face-off shall take place at the nearest face-off spot in the zone closest to the location from where the pass or shot originated.*

- (iii) *If the defending player is about to be checked by an attacking player who is unaware that he is in an off-side position, the ensuing face-off shall take place on a neutral zone face-off spot nearest to the defending team's blue line.*

When the Linesman signals a delayed off-side and a defending player or goalkeeper shoots the puck which goes over the glass and out of play, the ensuing face-off shall be conducted at one of the defending zone end zone face-off spots from (and the defending player or goalkeeper would be assessed a minor penalty under Rule 63 – Delaying the Game).

When the Linesman signals a delayed off-side and the original shot deflects off a defending player and out of play, the ensuing face-off shall take place at the nearest face-off spot in the zone from where the puck was shot.

When the defending team is about to be penalized in the defending zone and the Linesman has a delayed off-side signaled against the attacking team on the same play, the ensuing face-off shall be conducted at one of the defending zone end zone face-off spots.

- 83.6 **Intentional Off-Side** - An intentional off-side is one which is made for the purpose of securing a stoppage of play regardless of the reason, whether either team is short-handed.

If in the opinion of the Linesman, an intentional off-side play has been made, the puck shall be faced-off at the end face-off spot in the defending zone of the offending team.

If, while an off-side call is delayed, a player of the offending team deliberately touches the puck to create a stoppage of play, the Linesman will signal an intentional off-side.

If, in the judgement of the Linesman, the attacking player(s) are making an effort to exit the attacking zone and are in close proximity to the blue line at the time the puck is shot into the zone, the play will not be deemed to be an intentional off-side.

Rule 84 – Overtime

- 84.1 **Overtime – Regular-season** - During regular-season games, if at the end of the three (3) regular twenty (20) minute periods, the score shall be tied, each team shall be awarded one point in the League standings.

The teams will then play an additional overtime period of not more than five (5) minutes with the team scoring first declared the winner and being awarded an additional point. The overtime period shall be played with each team at a numerical strength of four (4) skaters and one (1) goalkeeper. Additional penalties to be assessed consistent with the rules in regulation time.

The overtime period will be commenced immediately following a one (1) minute rest period during which the players will remain on the

ice. The teams will not change ends for the overtime period.

Goalkeepers may go to their respective players' benches during this rest period, however, penalized players must remain on the penalty bench. Should a penalized player exit the penalty bench during this rest period, he shall be returned immediately by the officials with no additional penalty being assessed, unless he commits an infraction of any other rule.

- 84.2 Overtime – Regular-season – Extra Attacker** - A team shall be allowed to pull its goalkeeper in favor of an additional skater in the overtime period. However, should that team lose the game during the time in which the goalkeeper has been removed, it would forfeit the automatic point gained in the tie at the end of regulation play, except if the goalkeeper has been removed at the call of a delayed penalty against the other team. Should the goalkeeper proceed to his bench for an extra attacker due to a delayed penalty call against the opposing team, and should the non-offending team shoot the puck directly into their own goal, the game shall be over and the team that was to be penalized declared the winner.

Once the goalkeeper has been removed for an extra attacker in overtime during the regular-season, he must wait for the next stoppage of play before returning to his position. He cannot change "on the fly." If he does, a bench minor penalty shall be assessed for having an ineligible player.

- 84.3 Overtime – Regular-season – Penalties** – When regulation time ends and the teams are 5 on 3, teams will start overtime 5 on 3. Once player strength reaches 5 on 4 or 5 on 5, at the next stoppage of play, player strength is adjusted to 4 on 3 or 4 on 4, as appropriate.

When regulation ends and teams are 4 on 4 teams will start overtime 3 on 3.

If at the end of regulation time teams are three (3) skaters on three (3) skaters, overtime starts three (3) skaters on three (3) skaters. Once player strength reaches five (5) skaters on four (4) skaters or five (5) skaters on five (5) skaters, at the next stoppage player strength is adjusted to four (4) skaters on three (3) skaters or four (4) skaters on four (4) skaters, as appropriate.

At no time will a team have less than three players on the ice. This may require a fifth skater to be added if a two-man advantage occurs.

Refer to Reference Tables – Table 19 – Penalties In Effect Prior to the Start of Overtime – Regular Season on page 165.

If a team is penalized in overtime, teams play four (4) skaters against three (3) skaters. If both teams are penalized with minor penalties at the same stoppage of play (with no other penalties in effect), teams will play three (3) skaters against three (3) skaters.

In overtime, if a team is penalized such that a two-man advantage is called for, then the offending team will remain at three (3) skaters while the non-offending team will be permitted a fifth skater.

At the first stoppage of play after the two-man advantage is no

longer in effect, the numerical strength of the team will revert back to either four (4) skaters on four (4) skaters or a four (4) skaters on three (3) skaters situation, as appropriate.

Refer to Reference Tables – Table 20 – Penalties Assessed in Overtime – Regular Season on page 167.

- 84.4 **Shootout** - During regular-season games, if the game remains tied at the end of the five (5) minute overtime period, the teams will proceed to a shootout. The rules governing the shootout shall be the same as those listed under Rule **25** - Penalty Shot.

The teams will not change ends for the shootout. The home team shall have the choice of shooting first or second. The teams shall alternate shots.

Three (3) players from each team shall participate in the shootout and they shall proceed in such order as the Coach selects. All players are eligible to participate in the shootout unless they are serving a ten-minute misconduct or have been assessed a game misconduct or match penalty.

Guidelines related to stick measurement requests during the shootout are outlined in 10.7 – Stick Measurements – Prior to Shootout Attempt.

Once the shootout begins, the goalkeeper cannot be replaced unless he is injured. No warm up shall be permitted for a substitute goalkeeper.

Each team will be given three shots, unless the outcome is determined earlier in the shootout. After each team has taken three shots, if the score remains tied, the shootout will proceed to a "sudden death" format. No player may shoot twice until everyone who is eligible has shot. If, however, because of injury or penalty, one team has fewer players eligible for the shootout than its opponent, both teams may select from among the players who have already shot. This procedure would continue until the team with fewer players has again used all eligible shooters.

Regardless of the number of goals scored during the shootout portion of overtime, the final score recorded for the game will give the winning team one more goal than its opponent, based on the score at the end of overtime.

The losing goalkeeper will not be charged with the extra goal against. The player scoring the game-winning goal in the shootout will not be credited with a goal scored in his personal statistics.

If a team declines to participate in the shootout procedure, the game will be declared as a shootout loss for that Team. If a team declines to take a shot it will be declared as "no goal."

- 84.5 **Overtime – Playoffs** – In the Stanley Cup Playoffs, when a game is tied after three (3) twenty (20) minute regular periods of play, the teams shall take a normal intermission (fifteen (15) minutes) and resume playing twenty (20) minute periods, changing ends for the



start of each overtime period. The team scoring the first goal in overtime shall be declared the winner of the game.

Rule 85 – Puck Out of Bounds

- 85.1 **Puck Out of Bounds** - When a puck goes outside the playing area at either end or either side of the rink, strikes any obstacles above the playing surface other than the boards or glass, causes the glass, lighting, timing device or the supports to break, it shall be faced-off at the nearest face-off spot in the zone from where it was shot or deflected out of play, except when the attacking team in the attacking zone is responsible for causing the puck to go out of play, the ensuing face-off shall take place at the nearest face-off spot in the neutral zone outside the offending team's attacking zone.

If the puck comes to rest on top of the boards surrounding the playing area, it shall be considered to be in play and may be played legally by hand or stick.

When the puck is shot and it makes contact with the gloves or the body of a player hanging over the players' bench, the face-off shall take place at the nearest face-off spot in the zone from where the puck was shot, however, if the puck hits a opposing player's glove or body that is hanging over the opposing team's players' bench, the face-off shall take place in the neutral zone adjacent to the opponent's players' bench.

Should the puck strike the spectator netting at the ends and the corners of the arena, play shall be stopped and the ensuing face-off shall be determined as if the puck went outside the playing area. However, if the puck striking the spectator netting goes unnoticed by the on-ice officials, play shall continue as normal and resulting play with the puck shall be deemed a legitimate play. Players must not stop playing the game until they hear the whistle to do so.

- 85.2 **Puck Unplayable** - When the puck becomes lodged in the netting on the outside of either goal so as to make it unplayable, or if it is "frozen" between opposing players intentionally or otherwise, the Referee shall stop the play.

The puck may be played off the goal netting by either team. However, should the puck remain on the goal netting for more than three (3) seconds, play shall be stopped. Should the goalkeeper use his stick or glove to freeze the puck on the back of the net or should a defending player shield a an attacking player from playing the puck off the back of the net, the face-off shall take place at one of the face-off spots in the defending zone.

Should the puck go under the goal either from behind or the side, or through the mesh from behind or the side, if this is witnessed by an on-ice official, play should be stopped immediately and the ensuing face-off should take place at the nearest face-off spot in the zone nearest to the location where the play was stopped.

85.3 Puck Out of Sight - Should a scramble take place or a player accidentally fall on the puck and the puck be out of sight of the Referee, he shall immediately blow his whistle and stop the play. The puck shall then be faced-off at the nearest face-off spot in the zone where the play was stopped unless otherwise provided for in the rules.

85.4 Puck Striking Official - Play shall not be stopped if the puck touches an official anywhere on the rink, regardless of whether a team is short-handed or not.

A puck that deflects back into the defending zone off an official who is in the neutral zone, will be deemed to be off-side as per Rule **83** – Off-side.

The puck striking or deflecting off an official does not automatically nullify a potential icing.

When a puck deflects off an official and goes out of play, the ensuing face-off will take place at the face-off spot in the zone nearest to where the puck deflected off the official.

If a goal is scored as a result of being deflected directly into the net off an official, the goal shall not be allowed.

85.5 Face-Off Location - Notwithstanding this rule, should an attacking player cause the puck to go out of play or become unplayable in the attacking zone, the face-off shall take place at a neutral zone face-off spot or at a face-off spot in the zone from which the puck left the ice, whichever is less advantageous to the attacking team.

For a puck that is unplayable due to being lodged in the netting or as a result of it being frozen between opposing players, the resulting face-off shall be at either of the adjacent face-off spots unless in the opinion of the Referee, the stoppage was caused by the attacking team, in which case the resulting face-off shall be conducted in the neutral zone.

85.6 Minor Penalty – A minor penalty for delay of game shall be imposed on a goalkeeper who deliberately drops the puck on the goal netting to cause a stoppage of play.

85.7 Verification of Time - Any loss of time on the game or penalty clocks due to the puck going out of play must be replaced. The Video Goal Judge may be consulted to ensure the time is accurately replaced.

Rule 86 – Start of Game and Periods

86.1 Start of Game and Periods - The game shall be commenced at the time scheduled by a “face-off” in the center of the rink and shall be renewed promptly at the conclusion of each intermission in the same manner.

86.2 Bench Minor Penalty – A bench minor penalty shall be imposed on either or both teams if they are not on the ice or can be seen proceeding to the ice to start the second, third or any overtime period when the intermission time on the clock has expired.

At the start of the second, third and any overtime period, all players with the exception of the starting players must proceed directly to their respective players' benches. Skating, warm-ups or on-ice activities by non-starters will result in a bench minor penalty for delay of game to the offending team.

When the visiting team must proceed by the way of the ice to their dressing room at the end of a period, they must wait for a signal from one of the officials before proceeding. Failure to wait for the official's signal shall result in the assessment of a bench minor penalty for delay of game.

- 86.3 **Choice of Ends** - Home clubs shall have the choice of goals to defend at the start of the game except where both players' benches are on the same side of the rink, in which case the home club shall start the game defending the goal nearest to its own bench. The teams shall change ends for each period of regulation time and, in the playoffs, for each period of overtime. (See Rule **84** – Overtime)
- 86.4 **Delays** - No delay shall be permitted by reason of any ceremony, exhibition, demonstration or presentation unless consented to reasonably in advance by the visiting team.
- 86.5 **End of Periods** - At the end of each period, the home team players must proceed directly to their dressing room while the visiting team players must wait for a signal from the official to proceed only if they have to go on the ice to reach their dressing room. Failure to comply with this regulation will result in a bench minor penalty for delay of game.

Players shall not be permitted to come on the ice during a stoppage of play or at the end of the first and second periods for the purpose of warming-up. The Referee will report any violation of this rule to the Commissioner for disciplinary action.

- 86.6 **Pre-Game Warm-Up** - During the pre-game warm-up (which shall not exceed sixteen (16) minutes in duration) and before the commencement of play in any period, each team shall confine its activity to its own end of the rink. Refer to Rule **47.9** - Fighting.

The Game Timekeeper shall be responsible for signaling the commencement and termination of the pre-game warm-up and any violation of this rule by the players shall be reported to the Commissioner.

Twenty (20) minutes before the time scheduled for the start of the game, both teams shall vacate the ice and proceed to their dressing rooms while the ice is being flooded. Both teams shall be signaled by the Game Timekeeper to return to the ice together in time for the scheduled start of the game.

- 86.7 **Start of Game** - At the beginning of the game, if a team fails to appear on the ice promptly without proper justification, a fine shall be assessed against the offending team, the amount of the fine to be decided by the Commissioner.

86.8 Start of Periods - At the beginning of the second and third periods, and overtime periods in playoffs (0:00 on the clock), clubs must be on the ice or be observed to be proceeding to the ice. Failure to comply with this regulation will result in a bench minor penalty for delay of game.

Before the start of the second and third periods (and overtime periods in the playoffs), the teams will proceed directly to their respective players' benches. Only the starting line-up will be allowed on the ice. The visiting team will immediately place its starting line-up at the face-off circle, then the home team will follow, with the Referee allowing the home team to make a line change if so desired prior to the face-off. Skating, warm-ups or on-ice activities by non-starters will result in a bench minor penalty for delay of game to the offending team.

No warm-up involving pucks on the ice shall be permitted for a goalkeeper at the start of any period. If, after one warning, this continues, the Referee shall assess a delay of game penalty to the offending team.

Rule 87 – Time-outs

87.1 Time-out - Each team shall be permitted to take one thirty-second time-out during the course of any game, regular season or playoffs. All players including goalkeepers on the ice at the time of the time-out will be allowed to go to their respective benches.

This time-out must be taken during a normal stoppage of play. Only one time-out, commercial or team, shall be permitted at any one stoppage of play. For the purpose of this rule, a commercial time-out is deemed an "official time-out" and not charged to either team.

Any player designated by the Coach will indicate to the Referee (prior to the drop of the puck) that his team is exercising its option and the Referee will report the time-out to the Game Timekeeper who shall be responsible for signaling the termination of the time-out.

No time-out shall be granted following a face-off violation.

When a penalty shot has been awarded to either team by the Referee, no time-out will be granted once instructions have been given to the player taking the shot and the goalkeeper defending the shot. No time-out will be granted during the shootout.

No warm-up involving pucks on the ice shall be permitted for a goalkeeper or replacement goalkeeper during a time-out. If, after one warning, this continues, the Referee shall assess a delay of game penalty to the offending team.

TABLE 1
(Rule 15 – Calling of Penalties)
SUMMARY OF PENALTIES TO COACHES AND NON-PLAYING CLUB PERSONNEL

Description	Rule
(i) Hitting the boards with a stick	Rule 40.3 Rule 75.3
(ii) Interference with an opponent on a breakaway	Rule 56.6
(iii) Interference with an opponent or the puck while play is in progress	Rule 56.3
(iv) Interference with an opponent or the puck while the goalkeeper has been removed	Rule 56.7
(v) Interfering with an official	Rule 40.3
(vi) Leaving the bench by stepping onto the ice before the end of the period	Rule 70.5
(vii) Obscene language or gestures	Rule 40.3 Rule 75.3 Rule 40.5 Rule 75.5
(viii) Physically abusing an official	Rule 41.7
(ix) Refusing to start play (teams in their dressing room)	Rule 73.3
(x) Refusing to start play (teams on the ice)	Rule 73.2
(xi) Throwing a stick on the ice to a player or goalkeeper who has lost or broken a stick	Rule 40.3
(xii) Throwing any object onto the ice	Rule 40.3 Rule 75.3
(xiii) Throwing stick (breakaway on an open net)	Rule 53.7
(xiv) Throwing stick (defending zone)	Rule 53.6

TABLE 2
(Rule 16 – Minor Penalties)
SUMMARY OF MINOR PENALTIES

Description	Rule
(i) Boarding	Rule 42
(ii) Broken stick	Rule 10
(iii) Charging	Rule 43
(iv) Clipping	Rule 45
(v) Closing hand on puck	Rule 67
(vi) Cross-checking	Rule 59
(vii) Delay of game	Rule 63
(viii) Elbowing	Rule 46
(ix) Face-off violation	Rule 76
(x) Goalkeeper interference	Rule 69
(xi) High-sticking	Rule 60
(xii) Holding	Rule 54
(xiii) Holding the stick	Rule 54
(xiv) Hooking	Rule 55
(xv) Illegal equipment	Rule 12
(xvi) Illegal stick	Rule 10
(xvii) Instigator	Rule 47
(xviii) Interference	Rule 56
(xix) Kneeing	Rule 50
(xx) Leaving penalty bench too early	Rule 70
(xxi) Leaving the crease (goalkeeper)	Rule 28
(xxii) Participating in the play beyond the center red line (goalkeeper)	Rule 28
(xxiii) Roughing	Rule 51
(xxiv) Slashing	Rule 61
(xxv) Throwing puck towards opponent's goal (goalkeeper)	Rule 67
(xxvi) Throwing stick	Rule 53

TABLE 2
(Rule 16 – Minor Penalties)
SUMMARY OF MINOR PENALTIES

Description	Rule
(xxvii) Tripping	Rule 57
(xxviii) Unsportsmanlike conduct	Rule 75

TABLE 3
(Rule 17 – Bench Minor Penalties)
SUMMARY OF BENCH MINOR PENALTIES

Description	Rule
(i) Delay of game	Rule 63
(ii) Deliberate illegal substitution	Rule 74
(iii) Illegal substitution	Rule 68
(iv) Improper starting line-up	Rule 7
(v) Interference from players' or penalty bench	Rule 56
(vi) Interference with an official	Rule 40
(vii) Leaving bench at end of period	Rule 86
(viii) Refusing to start play	Rule 73
(ix) Stepping onto ice during period (Coach)	Rule 70
(x) Throwing objects onto ice	
(xi) Too many men on the ice	Rule 63
(xii) Unsportsmanlike conduct	Rule 74
(xiii) Unsustained request for measurement	Rule 75
	Rule 10

TABLE 4
(Rule 18 – Double-minor Penalties)
SUMMARY OF DOUBLE-MINOR PENALTIES

Description	Rule
(i) Butt-ending	Rule 58
(ii) Head-butting	Rule 48
(iii) High-sticking	Rule 60
(iv) Spearing	Rule 62

TABLE 5
(Rule 20 – Major Penalties)
SUMMARY OF MAJOR PENALTIES

Description	Rule
(i) Boarding	Rule 42
(ii) Butt-ending	Rule 58
(iii) Charging	Rule 43
(iv) Checking from behind	Rule 44
(v) Clipping	Rule 45
(vi) Cross-checking	Rule 59
(vii) Elbowing	Rule 46
(viii) Fighting	Rule 47
(ix) Head-butting	Rule 48
(x) Hooking	Rule 55
(xi) Interference	Rule 56
(xii) Kneeing	Rule 50
(xiii) Slashing	Rule 61
(xiv) Spearing	Rule 62

TABLE 6
(Rule 20 – Major Penalties)
SUMMARY OF MAJOR PENALTIES THAT RESULT IN AN AUTOMATIC GAME MISCONDUCT

Description	Rule
(i) Butt-ending	Rule 58
(ii) Checking from behind	Rule 44
(iii) Clipping	Rule 45
(iv) Cross-checking	Rule 59
(v) Fighting (after original altercation)	Rule 47
(vi) Fighting (when aggressor)	Rule 47
(vii) Fighting (second instigator in game)	Rule 47
(viii) Fighting (instigator in final 5 minutes)	Rule 47
(ix) Fighting (third instigator in season)	Rule 47
(x) Head-butting	Rule 48
(xi) Hooking	Rule 55
(xii) Kneeing	Rule 50
(xiii) Slashing	Rule 61
(xiv) Spearing	Rule 62

TABLE 7
(Rule 20 – Major Penalties)
SUMMARY OF MAJOR PENALTIES THAT RESULT IN AN AUTOMATIC GAME MISCONDUCT WHEN THERE IS AN INJURY TO THE FACE OR HEAD

Description	Rule
(i) Boarding	Rule 42
(ii) Charging	Rule 43
(iii) Elbowing	Rule 46

TABLE 8
(Rule 21 – Match Penalties)
SUMMARY OF MATCH PENALTIES

Description	Rule
(i) Attempt to injure (in any manner)	Rule 21
(ii) Biting	Rule 21
(iii) Boarding	Rule 42
(iv) Butt-ending *	Rule 58
(v) Charging	Rule 43
(vi) Checking from behind	Rule 44
(vii) Clipping	Rule 45
(viii) Cross-checking	Rule 59
(ix) Deliberate injury (in any manner)	Rule 21
(x) Elbowing	Rule 46
(xi) Goalkeeper who uses his blocking glove to the head or face of an opponent*	Rule 51
(xii) Grabbing of the face mask	Rule 21
(xiii) Hair pulling	Rule 21
(xiv) Head-butting *	Rule 48
(xv) High-sticking	Rule 60
(xvi) Kicking a player (or goalkeeper)	Rule 49
(xvii) Kneeing	Rule 50
(xviii) Punching and injuring an unsuspecting opponent *	Rule 47
(xix) Slashing	Rule 61
(xx) Slew-footing	Rule 52
(xxi) Spearing *	Rule 62
(xxii) Throwing stick or any object	Rule 53
(xxiii) Wearing tape on hands in altercation *	Rule 47

* NOTE - match penalty must be assessed when injury results

TABLE 9
(Rule 22 – Misconduct Penalties)
SUMMARY OF MISCONDUCT PENALTIES

Description	Rule
(i) Banging boards with stick in protest of an official's ruling	Rule 40
(ii) Continuing or attempting to continue a fight	Rule 47
(iii) Deliberately breaking stick or refusing to surrender stick for measurement	Rule 10
(iv) Deliberately throwing any equipment (including stick) out of playing area	Rule 40 Rule 53
(v) Entering or remaining in the referee's crease	Rule 40
(vi) Fighting off the playing surface (or with another player or goalkeeper who is off the playing surface)	Rule 47
(vii) Inciting an opponent	Rule 75
(viii) Instigating a fight	Rule 47
(ix) Interfering or distracting opponent taking a penalty shot	Rule 25
(x) Knocking or shooting puck out of reach of an official	Rule 40
(xi) Leaving bench to speak to official	Rule 6
(xii) Refusing to change non-regulation piece of protective equipment (second violation)	Rule 9
(xiii) Use of profane or abusive language	
(xiv) Verbal abuse of an official	Rule 75 Rule 40

TABLE 10
(Rule 23 – Game Misconduct Penalties)
SUMMARY OF GAME MISCONDUCT FOULS INCLUDED IN THE
“GENERAL CATEGORY”

Description	Rule
(i) Charging	Rule 43
(ii) Clipping	Rule 45
(iii) Elbowing	Rule 46
(iv) Fighting off the playing surface	Rule 47
(v) Head-butting	Rule 48
(vi) Inciting an opponent into incurring a penalty	Rule 75
(vii) Interference	Rule 56
(viii) Intervening in an altercation	Rule 47
(ix) Kneeing	Rule 50
(x) Not properly tied down during an altercation	Rule 47
(xi) Obscene language or gestures	Rule 40 Rule 75
(xii) Persists in continuing an altercation	Rule 47
(xiii) Removing jersey prior to an altercation	Rule 47
(xiv) Resisting a Linesman in the discharge of his duties	Rule 40
(xv) Secondary altercation	Rule 47
(xvi) Third major penalty in a game	Rule 20
(xvii) Throwing stick outside the playing area	Rule 53

TABLE 11
(Rule 23 – Game Misconduct Penalties)
SUMMARY OF GAME MISCONDUCT FOULS INCLUDED IN THE
“STICK-RELATED CATEGORY”

Description	Rule
(i) Butt-ending	Rule 58
(ii) Cross-checking	Rule 59
(iii) Hooking	Rule 55
(iv) Slashing	Rule 61
(v) Spearing	Rule 62

TABLE 12
(Rule 23 – Game Misconduct Penalties)
SUMMARY OF GAME MISCONDUCT PENALTIES

Description	Rule	
(i) Continues or attempts to continue a fight	Rule 47	
(ii) Fighting off the playing surface or with an opponent who is off the playing surface	Rule 47	
(iii) First or second player (or goalkeeper) to leave the players' bench during or to start an altercation	Rule 70	
(iv) First to intervene in an altercation (third man in)	Rule 47	
(v) Interferes with a game official in the performance of their duties	Rule 40	
(vi) Leaving the penalty bench during an altercation	Rule 70	
(vii) Obscene gestures	Rule 40	Rule 75
(viii) Persists to challenge or dispute an official's ruling	Rule 40	
(ix) Physically abuses an official	Rule 41	
(x) Player or goalkeeper who has been ordered to the dressing room but returns to the bench or the ice	Rule 70	
(xi) Player or goalkeeper who deliberately attempts to injure a Manager, Coach or other non-playing Club personnel in any manner.	Rule 75	

TABLE 13
(Rule 25 – Penalty Shot)
SUMMARY OF PENALTY SHOTS

Description	Rule	
(i) Deliberate illegal substitution	Rule 68	
(ii) Intentionally dislodging the net from its moorings during the course of a breakaway	Rule 63	
(iii) Intentionally dislodging the net from its moorings when the penalty cannot be served in its entirety within regulation time	Rule 63	
(iv) Falling on the puck in the goal crease		
(v) Picking up the puck with the hand in the goal crease	Rule 63 Rule 63	
(vi) Player on a breakaway who is interfered with by an object thrown or shot by a defending team player or goalkeeper	Rule 53	Rule 56
(vii) Player on a breakaway who is interfered with by a player or goalkeeper who has illegally entered the game	Rule 70	
(viii) Player or goalkeeper throws or shoots an object at the puck in his defending zone	Rule 53	
(ix) Player on a breakaway who is fouled from behind.	Rule 25 Rule 54 Rule 55	Rule 57 Rule 61

TABLE 14
(Rule 26 – Awarded Goals)
SUMMARY OF AWARDED GOALS (WHEN GOALKEEPER HAS BEEN REMOVED FOR AN EXTRA ATTACKER)

Description	Rule
(i) Delaying the game	Rule 63
(ii) Handling the puck	Rule 67
(iii) Illegal substitution	Rule 68
(iv) Interference	Rule 56
(v) Leaving the players' or penalty bench	Rule 70
(vi) Throwing stick	Rule 53
(vii) Tripping	Rule 57

TABLE 15
(Rule 28 – Goalkeeper's Penalties)
SUMMARY OF GOALKEEPER PENALTIES

Description	Rule	
(i) Illegal stick	Rule 10	
(ii) Illegal equipment	Rule 9	Rule 12
(iii) Leaving crease during an altercation	Rule 28	
(iv) Proceeding to players' bench	Rule 28	
(v) Participates in the play beyond the center red line	Rule 28	
(vi) Playing puck in restricted area	Rule 1 Rule 28	Rule 63
(vii) Proceeds to players' bench to replace stick	Rule 10	
(viii) Deliberately shoots or bats puck out of play	Rule 63	
(ix) Deliberately falls on the puck inside or outside the goal crease	Rule 63	
(x) Deliberately drops the puck in his pads or on the goal net	Rule 67	
(xi) Piling snow or other obstacles	Rule 67	
(xii) Throwing the puck towards opponent's goal	Rule 67	
(xiii) Using blocking glove to punch an opponent in the head or face	Rule 51	

TABLE 16
(Rule 16 – Minor Penalties)
GOALS SCORED AGAINST A SHORT-HANDED TEAM

Minor penalty expiration criteria:

- a. Is the team scored against, short-handed?
- b. Are they serving a minor penalty on the clock?
- c. If the answer is yes to a) and b), delete the minor penalty with the least amount of time on the clock, except when coincidental penalties are being served.

Ex	Time	Team A	Team B	Answer	Remarks
One player with a double minor penalty:					
A1	3:00	A15 – 2+2		No player returns	First penalty ends, the second begins at 4:30.
	4:30		Goal		
A2	3:00	A15 – 2+2		A15 returns.	The first penalty has expired, the second ends with the scoring of the goal.
	5:30		Goal		
One player with a minor and a major penalty:					
B1	3:00	A15 – 5+2		No penalty terminates.	The major penalty must be served first.
	4:30		Goal		
B2	3:00	A15 – 5+2		A15 returns.	The major penalty has expired, the minor penalty ends with the scoring of the goal.
	8:30		Goal		
Two players of the same team – combination of minor and major penalties:					
C1	3:00	A15 – 2		A15 returns.	
	4:00	A23 – 2			
	4:30		Goal		
C2	3:00	A15 – 2		A15 returns.	
	4:00	A23 – 5			
	4:30		Goal		
C3	3:00	A15 – 5		A23 returns.	
	4:00	A23 – 2			
	4:30		Goal		

TABLE 16
(Rule 16 – Minor Penalties)
GOALS SCORED AGAINST A SHORT-HANDED TEAM

Ex	Time	Team A	Team B	Answer	Remarks
C4	3:00	A15 – 2+2			
	4:00	A23 – 2			
	4:30		Goal	No player returns.	The first minor to A15 ends.
	5:30		Goal	A23 returns.	A23 returns because he has the least amount of time to serve in his minor penalty.
C5	3:00	A15 – 2		A15 returns.	The signaled double-minor penalty to A23 is assessed at 4:30. * S = signaled
	(S*) 4:30	A23 – 2+2	Goal		
C6	3:00	A15 – 5+2		A23 returns.	A15 must first serve his major penalty. A23 returns as he is serving a minor penalty.
	4:00	A23 – 2			
	4:30		Goal		
C7	3:00	A15 – 5+2		A23 returns.	Least amount of time to serve.
	7:30	A23 – 2			
	8:30		Goal		
C8	3:00	A15 – 5+2		Both A15 and A23 return.	The major penalty to A15 has expired. His minor penalty ends with the goal. A23's minor penalty has expired.
	6:00	A23 – 2			
	8:00		Goal		
C9	3:00	A15 – 5+2		Captain's choice.	The major penalty to A15 has expired. Both minors terminate at the same time.
	8:00	A23 – 2			
	9:00		Goal		

TABLE 16
(Rule 16 – Minor Penalties)
GOALS SCORED AGAINST A SHORT-HANDED TEAM

Ex	Time	Team A	Team B	Answer	Remarks
Three players of the same team – Delayed (D) or Signaled (S) penalty (no stoppage of play):					
D1	3:00	A15 – 2			
	3:30	A23 – 2			
	4:00	A6 – 2(D)			
	4:30		Goal	A15 returns.	Delayed penalty to A6 begins at 4:30
	5:00		Goal	A23 returns.	The minor penalty to A15 is completed. The minor penalty to A6 begins.
	5:30		Goal	A6 returns.	Penalties to A15 and A23 are completed. The minor to A6 ends with the scoring of the goal.
D2	3:00	A15 – 2			
	3:30	A23 – 2			
	(S)	A6 – 2			
	4:30		Goal	A15 returns and the penalty to A6 starts.	
	5:00		Goal	A23 returns and A6 remains in the box.	
D3	3:00	A15 – 5			
	3:30	A23 – 2			
	(S)	A6 – 2			
	4:30		Goal	A23 returns and the penalty to A6 starts.	

TABLE 16
(Rule 16 – Minor Penalties)
GOALS SCORED AGAINST A SHORT-HANDED TEAM

Ex D4	Time	Team A	Team B	Answer	Remarks
	3:00	A15 – 5		A15 and A23 return and the penalty to A6 starts.	The major penalty to A15 is completed.
	7:30	A23 – 2			The minor penalty to A23 ends on the scoring of the goal.
	(S)	A6 – 2			
	8:00		Goal		
One player from each team – combination of minors and majors:					
E1	3:00	A15 - 2			
	3:30		B12 – 2		
	4:30		Goal	No player returns.	Teams are at equal strength.
	5:00		Goal	A15 returns.	His minor penalty has been completed.
E2	3:00	A15 – 2+2			
	3:30		B12 – 2		
	4:30		Goal	No player returns.	Teams are at equal strength.
	5:00		Goal	No player returns.	The first minor to A15 is completed but teams remain at equal strength.
	5:30		Goal	A15 returns.	The first minor penalty to A15 and that of B12 are complete. The second minor penalty to A15 ends with the scoring of the goal.
E3	3:00	A15 – 5+2		No player returns.	Teams are at equal strength.
	3:30		B12 – 2		
	4:30		Goal		
E4	3:00	A15 – 5+2		No player returns.	The major penalty to A15 is complete but the teams remain at equal strength.
	7:30		B12 – 2		
	8:00		Goal		

TABLE 16
(Rule 16 – Minor Penalties)
GOALS SCORED AGAINST A SHORT-HANDED TEAM

Ex	Time	Team A	Team B	Answer	Remarks
E5	3:00	A15 – 5+2		A15 returns.	The major penalty to A15 and the minor penalty to B12 have expired. The minor penalty to A15 ends on the scoring of the goal.
	6:00		B12 – 2		
	8:00		Goal		
E6	3:00	A15 – 2		No player returns.	The goal nullifies the signaled penalty to A23 (Reason: Team A was not short-handed).
	3:30		B12 – 2		
	(S)	A23 – 2			
	4:10		Goal		
Unequal number of players – combination of minors and majors:					
F1	3:00	A15 – 2		A15 returns.	He had the least amount of time to serve in his minor penalty.
	3:30		B12 – 2		
	4:00	A23 – 2			
	4:30		Goal		
F2	3:00	A15 – 2		A15 returns.	His minor penalty is completed. Teams are at equal strength at the time of the goal.
	3:30		B12 – 2		
	4:00	A23 – 2			
	5:00		Goal		
F3	3:00	A15 – 2		A15 returns.	
	3:30	A23 – 2			
	4:00		B12 – 2		
	4:30		Goal		

TABLE 16
(Rule 16 – Minor Penalties)
GOALS SCORED AGAINST A SHORT-HANDED TEAM

Ex	Time	Team A	Team B	Answer	Remarks
F4	3:00		B12 – 2		
	3:30	A15 – 2			
	4:00	A23 – 2			
F5	4:30		Goal	A15 returns.	Least amount of time to serve in his minor penalty.
	5:00		Goal	A23 returns	
	3:00		B12 – 2	A15 returns.	Least amount of time to serve in his minor penalty.
F6	3:30	A15 – 2			
	4:00	A23 – 5			
	4:30		Goal		
F7	3:00	A15 – 2		A15 returns.	Least amount of time to serve in his minor penalty.
	3:30		B12 – 2		
	4:00	A23 – 2			
F8	4:30		Goal		
	3:00	A15 – 5		A23 returns.	Least amount of time (and Team A is short-handed by reason of a minor penalty).
	3:30		B12 – 5		
F9	4:00	A23 – 2			
	4:30		Goal		
	3:00	A15 – 2		A15 returns.	Least amount of time (and Team A is short-handed by reason of a minor penalty).
F9	3:30		B12 – 5		
	4:00	A23 – 5			
	4:30		Goal		
F9	3:00	A15 – 5		B23 returns.	Short-handed by reason of a minor penalty.
	3:30	A23 – 2			
	4:00		B12 – 2		
	4:30		Goal		

TABLE 16
(Rule 16 – Minor Penalties)
GOALS SCORED AGAINST A SHORT-HANDED TEAM

Ex	Time	Team A	Team B	Answer	Remarks	
F10	3:00	A15 – 5	B12 – 2	A23 returns.	Short-handed by reason of a minor penalty.	
	3:30					
	4:00	A23 – 2				
	4:30	Goal				
F11	3:00	A15 – 2	B12 – 2	A15 returns.	Short-handed by reason of a minor penalty.	
	3:30	A23 – 5				
	4:00					
	4:30	Goal				
F12	3:00	A15 – 2	B12 – 5	A15 returns.	Least amount of time.	
	3:30					
	4:00					A23 – 2
	4:30					Goal
F13	3:00	A15 – 2+2	B12 – 2	No player returns.	First minor penalty to A15 ends.	
	3:30					
	4:00	A23 – 2				
	4:30	Goal				
F14	3:00	A15 – 2	B12 – 2	A15 returns.	The penalty to A6 begins at 4:00	
	3:15	A23 – 2				
	3:30					
	3:45	A6 – 2(D)				
	4:00	Goal				
	4:30	Goal				A23 returns.

TABLE 16
(Rule 16 – Minor Penalties)
GOALS SCORED AGAINST A SHORT-HANDED TEAM

Ex	Time	Team A	Team B	Answer	Remarks	
F15	3:00	A15 – 2	B12 – 2	A23 returns.	Penalties to A6 and B3 are not on the clock.	
	3:15	A23 – 2				
	3:30	A6 – 2	B3 – 2			
	5:10		Goal			
F16	3:00	A15 – 2	B12 – 2	Signaled penalty to B3 is not assessed.	The penalty to B12 does not make Team B short-handed.	
	3:30					
	4:00	A23 – 2				
	(S)					B3 - 2
	4:30	Goal				
F17	3:00	A15 – 2	B12 – 2	A15 returns and the penalty to A6 starts.		
	3:30					
	4:00	A23 – 2				
	(S)	A6 – 2				
	4:30	Goal				
Coincidental penalties – equal number of players on each team:						
G1	3:00	A15 – 5+2	B12 – 2+2	No player returns.	Teams are at equal strength.	
	4:30		Goal			
G2	3:00	A15 – 2+5	B12 – 5	The substitute for A15 returns.	Coincidental major penalties.	
	4:30		Goal			
G3	3:00	A15 – 2	B12 – 2	A15 returns.	Coincidental penalties are not put on the clock.	
	3:30	A23 – 2				
	4:30					Goal
G4	3:00	A15 – 2	B12 – 2	A23 returns.		
	3:30	A23 – 2				
	4:30		Goal			

TABLE 16
(Rule 16 – Minor Penalties)
GOALS SCORED AGAINST A SHORT-HANDED TEAM

Ex	Time	Team A	Team B	Answer	Remarks
G5	3:00	A15 – 2	B12 – 2	No player returns.	Team A is short-handed, however, it is with a major penalty.
	3:30	A23 – 5			
	4:30	Goal			
G6	3:00	A15 – 2	B12 – 5	A15 returns.	Team A is below the numerical strength of it's opponent. Minor penalty to A15 expires on the scoring of the goal.
	3:30	A23 – 5			
	4:30	Goal			
G7	3:00	A15 – 2		A15 returns.	
	3:30	A23 – 2			
	4:30	Goal			
G8	3:00	A15 – 2	B12 – 5	A15 returns.	Penalties to A23 and B12 are not on the clock.
	3:30	A23 – 5			
	4:30	Goal			
G9	3:00	A15 – 5	B12 – 2	No player returns.	A15 is serving a major penalty. Penalties to A23 and B12 are not on the clock.
	3:30	A23 – 2			
	4:30	Goal			
G10	3:00	A15 – 5	B12 – 5	A23 returns.	Short-handed by reason of a minor penalty.
	3:30	A23 – 2			
	4:30	Goal			
G11	3:00	A15 – 2+2	B12 – 5	No player returns.	First minor penalty to A15 is eliminated.
	3:30	A23 – 2			
	4:30	Goal			
G12	3:00	A15 – 2	B12 – 2	The penalty to A6 is not assessed (unless it is a major or match penalty).	
	3:30	A23 – 5			
	(S)	A6 – 2			
	4:30	Goal			

TABLE 16
(Rule 16 – Minor Penalties)
GOALS SCORED AGAINST A SHORT-HANDED TEAM

Ex	Time	Team A	Team B	Answer	Remarks
G13	3:00	A15 – 2			Penalties to A23 and B12 are not on the clock.
	3:30	A23 – 2	B12 – 2		
	4:00	A6 – 2			
	4:30		Goal	A15 returns.	
	4:45		Goal	A6 returns.	
G14	3:00	A15 – 2		A15 returns.	The minor penalty to A6 begins at 4:30. The penalties to A23 and B12 are not on the clock.
	3:30	A23 – 2	B12 – 2		
	(S) 4:30	A6 – 2		Goal	
G15	3:00	A15 – 2+2	B12 – 2	Minor penalty to A15 is eliminated.	Team A would have placed an additional player in the penalty box to serve the extra minor penalty to A15. NOTE: A15's additional minor penalty begins at 3:30 due to the scoring of the goal by Team B, but does not affect the on-ice strength.
	3:30		Goal		
Coincident penalties – unequal number of players on each team:					
H1	3:00	A15 – 2 A23 – 2	B12 – 2	Captain's choice.	This choice must be made at the time of assessment of the penalties.
	4:30		Goal		
H2	3:00	A15 – 2 A23 – 5	B12 – 2	No player returns.	The major penalty makes the team short-handed. The penalties to A15 and B12 do not go on the clock.
	4:30		Goal		
H3	3:00	A15 – 2 A23 – 2	B12 – 5	Captain's choice.	The minor penalties end at the same time.
	4:30		Goal		

TABLE 16
(Rule 16 – Minor Penalties)
GOALS SCORED AGAINST A SHORT-HANDED TEAM

Ex	Time	Team A	Team B	Answer	Remarks
H4	3:00	A15 – 2 A23 – 5	B12 – 5	A15 returns.	Major penalties are coincidental and do not go on the clock.
	4:30		Goal		
H5	3:00	A15 – 5 A23 – 2	B12 – 2	No player returns.	Coincidental minor penalties. Team A is short-handed by reason of the major penalty. Penalties to A23 and B12 do not go on the clock.
	4:30		Goal		
H6	3:00	A15 – 2+2 A23 – 2	B12 – 2	Captain's choice. The minor penalty to B12 can cancel off with any one of the minor penalties assessed to the two players on Team A.	Depending on the choice made by Team A, A23 may return or the first minor penalty to A15 will end with the scoring of the goal.
	4:30		Goal		
H7	3:00	A15 – 2 A23 – 2+2	B12 – 2	Captain's choice. The minor penalty to B12 can cancel off with any one of the minor penalties assessed to the two players on Team A.	Depending on the choice made by Team A, A15 may return or the first minor penalty to A23 will end with the scoring of the goal.
	4:30		Goal		

TABLE 16
(Rule 16 – Minor Penalties)
GOALS SCORED AGAINST A SHORT-HANDED TEAM

Ex	Time	Team A	Team B	Answer	Remarks
H8	3:00	A15 – 2 A23 – 2 A6 – 2	B12 – 2		
	4:00		Goal	Captain's choice.	B12 and one of the minor penalties to Team A (depending on choice) will not go on the clock.
	4:30		Goal	Remaining player returns.	According to the choice made by Team A when the penalties were assessed.
H9	3:00	A15 – 5 A23 – 2 A6 – 2	B12 – 2	Captain's choice.	Coincidental penalty rule applies to B12 and either A23 or A6 (and these penalties would not go on the clock).
	4:30		Goal		
H10	4:00	A15 – 2	B12 – 2	No player returns.	A23's first penalty terminates. A23's second penalty starts.
	4:30	A23 – 2+2			
	5:00		Goal		

NOTE: Coincident penalties must always be served in their entirety.

TABLE 17
(Rule 19 – Coincidental Penalties)
COINCIDENTAL PENALTIES
(all penalties assessed at the same stoppage)

	Team A	Penalties	Team B	Penalties	On-ice Strength
Example 1	A3	2	B10	2+2	Team B will play one player short-handed for two minutes. Team B must place an additional player to serve the extra minor penalty to B10.
Example 2	A3	2	B10	2+2	Teams play at full strength.
	A5	2+2	B12	2	
Example 3	A3	2+2	B10	2+2	Teams play at full strength.
	A5	5	B12	5	
Example 4	A3	2+5	B10	2	Teams play at full strength
			B12	5	
Example 5	A3	2+5	B10	2	Team A will play one player short-handed for two minutes. Team A Captain's choice to determine which penalty would go on the penalty time clock. Should A3 be chosen, then an additional team A player must be placed on the penalty bench to serve the minor penalty for A3.
	A5	2	B12	5	
Example 6	A3	2+2	B10	2+2	Team A one player short-handed for five minutes.
	A5	5			
Example 7	A3	2+2	B10	2	Team A Captain's choice to play one player short-handed for four minutes or two players short-handed for two minutes. Should he choose the latter, an additional team A player must be placed on the penalty bench to serve the minor penalty for A3.
	A5	2			
Example 8	A9	2	B2	2+2	Team B will be one player short-handed for two minutes. Team B Captain's choice of which player's time will go on the penalty time clock. If he chooses B2, then team B must place an additional player on
	A24	2	B18	2	

TABLE 17
(Rule 19 – Coincidental Penalties)
COINCIDENTAL PENALTIES
(all penalties assessed at the same stoppage)

	Team A	Penalties	Team B	Penalties	On-ice Strength
					the penalty bench to serve B2's minor penalty.
Example 9	A3	5	B5	5	Teams play at full strength.
Example 10	A3	5	B5 B7	5 5	Team B short-handed for five minutes (Captain's choice).
Example 11	A3 A4	5 5	B5 B7	5 5	Teams play at full strength.
Example 12	A3	5+5	B5	5	Team A short-handed for five minutes. Team A must place an additional player on the penalty bench to serve the extra major penalty.
Example 13	A3	5+5	B5 B7	5 5	Teams play at full strength.
Example 14	A3 A4	5+5 5	B7	5	Team A has the choice to cancel one of the two major penalties assessed to A3 or to simply cancel the one to A4. Should they choose A3, they will require an additional player in the penalty box.
Example 15	A3 A4	5+5 5	B5 B7	5 5	Team A will be short-handed for five minutes. Team choice to cancel majors assessed. Should they choose A3, they will require an additional player in the penalty box.
Example 16	A3	2+5	B7	5	Team A must place another player in the penalty box to serve the additional minor penalty to A3 immediately.
Example 17	A3	2+5	B7	2+5	Teams play at full strength.

TABLE 17
(Rule 19 – Coincidental Penalties)
COINCIDENTAL PENALTIES
(all penalties assessed at the same stoppage)

	Team A	Penalties	Team B	Penalties	On-ice Strength
Example 18	A3	2+5	B5 B7	5 5	Team A short-handed for two minutes. Team B shorthanded for five minutes (Captain's choice). Team A must place another player in the penalty box to serve the minor penalty.
Example 19	A3	2	B5	5	In the last five minutes of the game or anytime in overtime, the three minute differential will be posted on the penalty clock. Team B will play short-handed for three minutes and it will be served in the same manner as a major penalty.
Example 20	A3	2+2	B5	5	In the last five minutes of the game or anytime in overtime, the one minute differential will be posted on the penalty clock. Team B will play short-handed for one minute and it will be served in the same manner as a major penalty.
Example 21	A3	2+5	B5	2+2+5	Team B will play short-handed for two minutes. Team B will require an additional player in the penalty box to serve the minor penalty.
Example 22	A3 A4	2+5 5	B5 B7	5 5	Team A will play short-handed for two minutes. Team A will require an additional player in the penalty box to serve the minor penalty.
Example 23	A3 A4	2+5 2+2+5	B5 B7	2+5 5+5	Team A will be short-handed either one player for four minutes, or two players for two minutes (Captain's choice). Team B will be short-handed for five minutes (Captain's choice).
Example 24	A3 A4	2+5 5	B5 B7	2+2+5 5+5	Team B will be short-handed either one player for seven minutes or two players, one for two minutes and one for five minutes (Captain's choice).

TABLE 17
(Rule 19 – Coincidental Penalties)
COINCIDENTAL PENALTIES
(all penalties assessed at the same stoppage)

	Team A	Penalties	Team B	Penalties	On-ice Strength
Example 25	A3	2+5	B5	5	Team A will be short-handed, either one player for seven minutes, or two player, one for two minutes and one for five minutes (Captain's choice).
	A4	5			
Example 26	A3	2+5+5	B5	2+5	Teams play at full strength.
			B7	5	
Example 27	A5	2	B12	5+5	Teams play at full strength.
	A6	5+5	B13	2	
	A7	5	B14	5	

TABLE 18
(Rule 69 – Interference on the Goalkeeper)
INTERFERENCE ON THE GOALKEEPER SITUATIONS

Situation	Result
1. THE GOALKEEPER IS IN THE GOAL CREASE.	
A. An attacking player is standing in the goal crease when the puck enters the crease then crosses the goal line. In no way does he affect the goalkeeper's ability to defend his goal.	Goal is allowed. This is a good goal.
B. An attacking player makes incidental contact with the goalkeeper, however, no goal is scored on the play.	Play continues, no whistle.
C. An attacking player makes incidental contact with the goalkeeper at the same time a goal is scored.	Goal is disallowed. The official in his judgment may call a Minor penalty on the attacking player. The announcement should be, "No goal due to interference with the goalkeeper."
D. An attacking player makes other than incidental contact with the goalkeeper, however, no goal is scored on the play.	A Minor penalty, plus assessment of whatever other penalties may be appropriate up to and including Supplementary Discipline.
E. An attacking player makes other than incidental contact with the goalkeeper at the time a goal is scored.	Goal is disallowed, and a Minor and/or Major penalty, plus assessment of whatever penalties may be appropriate up to and including Supplementary Discipline.

TABLE 18
(Rule 69 – Interference on the Goalkeeper)
INTERFERENCE ON THE GOALKEEPER SITUATIONS

Situation	Result
2. THE GOALKEEPER IS OUT OF THE GOAL CREASE.	
A. An attacking player makes incidental contact with the goalkeeper, however, no goal is scored on the play.	Play continues, no whistle.
B. An attacking player makes incidental contact with the goalkeeper at the time a goal is scored.	Goal is allowed.
C. An attacking player makes other than incidental contact with the goalkeeper, however, no goal is scored on the play.	A Minor and/or Major penalty, plus assessment of whatever other penalties may be appropriate up to and including Supplementary Discipline.
D. An attacking player makes other than incidental contact with the goalkeeper at the time a goal is scored.	A Minor and/or Major penalty, plus assessment of whatever other penalties may be appropriate up to and including Supplementary Discipline and the goal is disallowed.
3. A DEFENDING PLAYER PUSHES, SHOVS, OR FOULS AN ATTACKING PLAYER INTO THE GOALKEEPER, WHO IS IN OR OUT OF THE CREASE.	
A. The attacking player, after having made a reasonable effort to avoid contact, makes contact with the goalkeeper at the time a goal is scored.	Goal is allowed.

TABLE 18
(Rule 69 – Interference on the Goalkeeper)
INTERFERENCE ON THE GOALKEEPER SITUATIONS

Situation	Result
B. The contact by the attacking player with the goalkeeper is other than incidental and the attacking player, in the judgment of the Referee, did not make a reasonable effort to avoid such contact. However, no goal is scored on the play.	A Minor and/or Major penalty, plus assessment of whatever other penalties may be appropriate up to and including Supplementary Discipline.
C. The contact by the attacking player with the goalkeeper is other than incidental and the attacking player, in the judgment of the Referee, did not make a reasonable effort to avoid such contact at the time a goal is scored.	A Minor and/or Major penalty may be called at the discretion of the Referee plus assessment of whatever other penalties may be appropriate up to and including Supplementary Discipline and the goal is disallowed.
4. BATTLE FOR LOOSE PUCK WITH THE GOALKEEPER WHILE THE GOALKEEPER IS IN OR OUT OF THE GOAL CREASE.	
A. An attacking player makes incidental contact with the goalkeeper while both are attempting to play a loose puck at the time a goal is scored.	Goal is allowed.
B. An attacking player makes other than incidental contact with the goalkeeper while both are attempting to play a loose puck at the time a goal is scored.	A Minor and/or Major penalty, plus assessment of whatever other penalties may be appropriate up to and including Supplementary Discipline and the goal is disallowed.

TABLE 18
(Rule 69 – Interference on the Goalkeeper)
INTERFERENCE ON THE GOALKEEPER SITUATIONS

Situation	Result
5. SCREENING SITUATIONS.	
<p>A. An attacking player skates in front of the goalkeeper at the top of the goal crease, at the same time a goal is being scored. The attacking player remains in motion and does not maintain a significant position in the crease in front of the goalkeeper.</p>	<p>Goal is allowed. This is a good goal.</p>
<p>B. An attacking player skates in front of the goalkeeper, well inside the crease, at the same time a goal is being scored. The attacking player remains in motion and, in the judgment of the Referee, maintains a significant position in the crease impairing the goalkeeper's ability to defend his goal.</p>	<p>Goal is disallowed. The announcement should be, "No goal due to interference with the goalkeeper."</p>
<p>C. An attacking player skates in front of the goalkeeper, outside the crease, at the same time a goal is being scored. The attacking player remains in motion and impairs the goalkeeper's ability to defend his goal.</p>	<p>Goal is allowed.</p>
<p>D. An attacking player plants himself within the goal crease, as to obstruct the goalkeeper's vision and impair his ability to defend his goal, and a goal is scored.</p>	<p>Goal is disallowed. The announcement should be, "No goal due to interference with the goalkeeper."</p>

TABLE 18
(Rule 69 – Interference on the Goalkeeper)
INTERFERENCE ON THE GOALKEEPER SITUATIONS

Situation	Result
<p>E. An attacking player plants himself on the crease line or outside the goal crease, as to obstruct the goalkeeper's vision and impair his ability to defend his goal, and a goal is scored.</p>	<p>Goal is allowed.</p>
<p>6. CROWDING THE GOALKEEPER.</p>	
<p>A. A goalkeeper initiates contact with an attacking player to establish position in the crease and the attacking player vacates the position immediately. No goal is scored on the play.</p>	<p>Play continues, no whistle.</p>
<p>B. A goalkeeper initiates contact with an attacking player to establish position in the crease and the attacking player does not vacate the position, however, no goal is scored on the play. A possible penalty depends on the Referee's judgment as to the degree of contact and degree of resistance with the attacking player and whether the goalkeeper was truly trying to establish a position.</p>	<p>Minor penalty. This player runs the risk of "bad things" happening by being in the crease. In this example it is a minor penalty.</p>
<p>C. A goalkeeper initiates contact with an attacking player in the crease to establish position and the attacking player vacates the position immediately at the time a goal is scored. Even though the attacking player vacates his position immediately, the contact impairs the goalkeeper's ability to defend his goal.</p>	<p>Goal is disallowed. The announcement should be, "No goal due to interference with the goalkeeper."</p>

TABLE 18
(Rule 69 – Interference on the Goalkeeper)
INTERFERENCE ON THE GOALKEEPER SITUATIONS

Situation	Result
<p>D. A goalkeeper initiates contact with an attacking player to establish position in the crease and the attacking player refuses to give ground at the time a goal is scored.</p>	<p>Goal is disallowed. A Minor penalty is not assessed (loss of goal only). The announcement should be, “No goal due to interference with the goalkeeper.”</p>
<p>E. A goalkeeper deliberately initiates contact with an attacking player other than to establish position in the crease, or otherwise acts to make unnecessary contact with the attacking player.</p>	<p>Minor penalty to the goalkeeper (slashing, etc.).</p>
<p>F. A goalkeeper initiates contact with an attacking player to establish position in the crease by using excessive force or acting in a manner which would otherwise warrant a penalty, and the attacking player refuses to give ground at the time a goal is scored.</p>	<p>Coincidental Minors (goalkeeper/attacking player) [In this situation, the Referee would emphatically display to players and the fans that he was calling penalties before the puck entered the net, and thus the play was dead at the time the infractions occurred and thus stated there is no goal.]</p>
<p>G. A goalkeeper initiates contact with an attacking player to establish position in the crease by using excessive force or acting in a manner which would otherwise warrant a penalty, and the attacking player vacates the crease at the time a goal is scored.</p>	<p>A Minor penalty to the goalkeeper and the goal is disallowed. This is an example where the attacking player has prevented the goalkeeper from doing his job by being in the crease. The announcement should be, “No goal due to interference with the goalkeeper (plus the announcement of the goalkeeper’s penalty).”</p>
<p>H. A goalkeeper initiates contact with an attacking player to establish position in the crease by using excessive force or acting in a manner which would otherwise warrant a penalty and the</p>	<p>Minor penalty to goalkeeper.</p>

TABLE 18
(Rule 69 – Interference on the Goalkeeper)
INTERFERENCE ON THE GOALKEEPER SITUATIONS

Situation	Result
attacking player vacates the crease, but no goal is scored.	
7. CONTACT WITH THE GOALKEEPER.	
A. An attacking player initiates contact with the goalkeeper, inside or outside the goal crease, in a fashion that would otherwise warrant a penalty (e.g. “runs” the goalkeeper).	Appropriate penalty (Minor and/or Major and a Game Misconduct) and subject to additional sanctions as appropriate, pursuant to Rule 33A – Supplementary Discipline.
B. An attacking player is in the crease and makes every effort to vacate the crease and the goalkeeper initiates contact to embellish and draw a penalty. No goal is scored on the play.	This is a dive and a Minor penalty to the goalkeeper (diving).
C. A defensive player directs the puck into his own net while an attacking player initiates contact with the goalkeeper.	Goal is disallowed and a Minor and/or Major penalty, plus assessment of whatever other penalties may be appropriate up to and including Supplementary Discipline to the attacking player.
D. A defensive player directs the puck into his own net while an attacking player is standing in the goal crease. The attacking player does not affect the goalkeeper’s ability to make the save.	Goal is allowed.

TABLE 19
(Rule 84 – Overtime)
PENALTIES IN EFFECT PRIOR TO THE START OF OVERTIME –
REGULAR SEASON

Ex	Time in 3 rd Period	Team A	Team B	Resolve
1	19:10	A5 - 2	B17 - 2	The penalty times remain on the penalty time clock and the teams begin overtime playing three (3) skaters against three (3) skaters.
2	19:10 19:50	A5 - 2 A7 - 2	B17 - 2	The teams would begin the overtime period playing four (4) skaters against three (3) skaters. At the first stoppage of play following the expiration of the penalties to A5 and B17, the on-ice strength would be adjusted from five (5) skaters against four (4) skaters down to four (4) skaters against three (3) skaters.
3	19:10 19:25 19:40	A5 - 2 A7 - 2	B17 - 2	Overtime will begin with the player strength of three (3) skaters for team A and four (4) skaters for team B. Through the normal expiration of penalty times, the penalized players will return to the ice. With continuous play, the potential of reaching an on-ice strength of five (5) on five (5) is a possibility. However, the on-ice strength would be adjusted accordingly at the next stoppage of play.
4	19:10 19:30 19:40	A5 - 2 A7 - 2	A17 - 2 A36 - 2	Overtime will begin with the player strength of three (3) skaters against three (3) skaters. Should there be a stoppage of play following the expiration of A5 and B17's penalties, the on-ice strength shall be adjusted to three (3) skaters against three (3) skaters. This permits the remaining penalties to exit the penalty box and return the teams to four (4) on four (4) status. With continuous play,

TABLE 19
(Rule 84 – Overtime)
PENALTIES IN EFFECT PRIOR TO THE START OF OVERTIME –
REGULAR SEASON

Ex	Time in 3 rd Period	Team A	Team B	Resolve
				the potential of reaching an on-ice strength of five (5) on five (5) is a possibility. However, the on-ice strength would be adjusted accordingly at the next stoppage of play.
5	19:10 19:20 19:30 19:40	A5 – 2 A7 – 2	B17 – 2 B36 – 2	Overtime on-ice strength will begin at three (3) on three (3). Through the normal expiration of penalty times, the penalized players will return to the ice. With continuous play, the potential of reaching an on-ice strength of five (5) on five (5) is a possibility. However, the on-ice strength would be adjusted accordingly at the next stoppage of play to either four (4) on three (3) or four (4) on four (4), as the situation dictates at that particular stoppage of play.

TABLE 20
(Rule 84 – Overtime)
PENALTIES ASSESSED IN OVERTIME – REGULAR SEASON

Time in OT	Team A	Team B	On-ice Strength
0:30	A23 – 2		Team A – 3 skaters Team B – 4 skaters
1:00		B17 – 2	Team A – 3 skaters Team B – 3 skaters
1:30	A7 – 2		Team A – 3 skaters Team B – 4 skaters

Once team A has received their second minor penalty, each team must add one player to their on-ice strength. Should the penalty to A23 expire bringing the on-ice strength back to four (4) on four (4) and there is a subsequent stoppage of play, the on-ice strength must be adjusted down to three (3) on three (3) at this point. However, if there is a stoppage of play once the penalty to B17 has expired (and before A7's expires), the on-ice strength would be adjusted to four (4) on three (3). If there is no stoppage in play until both teams have returned to five skaters each, at the next stoppage of play the on-ice strength would be adjusted back down to four (4) on four (4).

A

Abstaining from playing the puck.....	72, 81.2
Abusive language or gestures	40, 75, Table 1, Table 12
Abuse of officials.....	40 , Table 9, Table 12
- captain or alternate coming off the bench.....	6.1
- game misconduct penalties	23.4
- linesmen reporting to referee.....	33.4
- misconduct penalties	22.4
- referee reports	32.9
- unsportsmanlike conduct	40
Action scorer.....	38.2
Adjustment to clothing	14.1, 63.2, 65.2
Adjustment to equipment.....	14.1, 63.2, 65.2
After the game – fighting.....	47.9
After the period – fighting.....	47.9
After the original altercation – fighting	47.7
Aggressor	36.6, 47.2 , Table 6
Altercation.....	47.3 , Table 6, Table 8, Table 10, Table 12, Table 15
- abuse of officials	40
- aggressor	47.2
- face-off location.....	76.2
- failure to proceed to penalty bench.....	47.19
- game misconduct penalties	23.2
- goalkeeper leaving goal crease	28.6, 32.9
- instigator	47.11, 47.12
- instigator – face shield	47.6, 75.2
- jersey	47.13, 75.2
- leaving the bench.....	70
- match penalties.....	47.15
- official scorer.....	34.5
- physical abuse of officials	41
- referee reports	32.9
- roughing	51.1
- with a spectator	23.7, 32.9
Altered jersey.....	9.1
Alternate captain.....	6.2
- coming off bench to protest.....	40.2
- correct number of players on the ice.....	63.3
- delaying the game.....	63.3
- fails to comply with Referee's direction.....	63.3
- game sheet	34.1
- leaving bench to protest.....	40.2
- listed on game sheet.....	34.1
- official report of match.....	34.1
- requesting stick measurement	10.5



	<u>Rule Number</u>
Appointment of officials	31
Area of a fight - clearing	47.4
Arm pads	11.3
Articles thrown on ice – linesmen reporting	33.4, 53.3, 75.2, 75.3, Table 1, Table 3
Assist.....	32.5, 34.2, 78.1, 78.3
Assists	
– crediting	34.2, 78.3
– public address	32.5, 34.2
Attacking zone.....	1.6
– calling of penalties – face-off location.....	15.5
– coming from the bench without a helmet – face-off location	9.5
– disallowed goal – goalkeeper interference – face-off location.....	69.5
– face-offs.....	76.2
– goalkeeper interference – face-off location	69.5
– hand pass	79.3
– injured player – face-off location.....	8.1
– off-side	83
– player’s bench extending into	83.3
– puck out of bounds	85.1, 85.5
– refusing to play puck.....	72
Attainable pass.....	81.5
Attempt to injure a manager, coach	75.5, Table 12
Attempt to injure an official	40.5, 41
Attempt to or deliberate injury	21
Attempting to continue a fight.....	47.5
Attire	32.1, 33.1
Automatic game misconduct	20.4, 23.6, Table 6, Table 7
– aggressor.....	47.2
– boarding.....	42.5
– butt-ending.....	58.5
– charging.....	43.5
– checking from behind	44.5
– clipping	45.5
– cross-checking.....	59.5
– elbowing	46.5
– fighting – after original altercation.....	47.7
– fighting – second instigator in a game	47.11
– fighting – third instigator in a season	47.11
– fighting – when aggressor	47.2
– head-butting.....	48.5
– hooking	55.4
– kneeling	50.5
– instigator – final five minutes of regulation time	47.12
– instigator – second in a game.....	47.11
– instigator – third in a season.....	47.11
– second fight, same stoppage.....	47.7
– second instigator in a game.....	47.11

Rule Number

- slashing.....	61.5
- spearing.....	62.5
- stick measurement – third violation in season.....	10.5
- third major penalty in a game.....	20.4
- third instigator in a season.....	47.11
Automatic suspension	
- abuse of officials category.....	23.4
- coach or non-playing club personnel involved in altercation.....	47.8
- fighting other than during the periods of the game.....	47.9
- general category.....	23.3
- instigator, aggressor and game misconduct list.....	36.6
- instigator in final five minutes of regulation time.....	47.22
- physical abuse of officials.....	41
- stick infractions, boarding and checking from behind category.....	23.5
- stick measurement – third violation in season.....	10.5
Awarded goal.....	26, Table 14
- covering puck in crease.....	67.5
- displacing goal post.....	63.6
- during penalty shot.....	26.4
- falling on puck in crease.....	67.5
- fouling from behind.....	54.4, 55.6, 57.4 , 61.7
- gathering puck in crease.....	67.5
- goalkeeper deliberately removing face mask.....	9.5
- handling puck in crease.....	67.5
- holding puck in crease.....	67.5
- illegal substitution.....	68.4, 70.8
- interference from bench.....	56.7
- interference by player illegally entered into game.....	68.4, 70.8
- interference by team member not legally on the ice.....	56.7
- picking up puck in crease.....	67.5
- piling snow or other objects.....	67.5
- shoots equipment.....	53.7
- shoots stick.....	53.7
- throwing equipment.....	53.7
- throwing stick.....	53.7
- tripping.....	57.4

B

Back of net.....	85.2, 85.5
Banging boards with stick.....	40.2, 40.3, Table 1, Table 9, Table 12
Banging glass in protest of ruling.....	40.2, 40.4
Batting puck.....	39.4, 67.1, 67.6, 78.5
Before the game – fighting.....	47.9
Before the period – fighting.....	47.9
Bench.....	3
- bench – penalty (see Penalty bench)	
- bench - players' (see Players' bench)	



	<u>Rule Number</u>
Bench minor penalty.....	17
- abuse of officials.....	40.3
- delaying the game.....	63.3
- designated player to serve.....	17.1
- distractions during penalty shot.....	25.4
- end of periods.....	86.5
- face-off violation.....	76.4, 76.6, 76.8
- goalkeeper in regular season overtime.....	84.2
- goalkeeper proceeding to players' bench.....	28.6
- illegal substitution.....	68.2
- injured player leaving the ice during play.....	8.1
- interference from the bench.....	56.3
- leaving the bench.....	70.4, 70.5
- line changes.....	82.2, 82.3
- refusing to start play.....	73.2, 73.3
- starting line-up.....	7.2
- start of game and periods.....	86.2
- short-handed.....	16.2
- slow proceeding to face-off location.....	76.6
- throwing equipment.....	53.3
- too many men on the ice.....	74.2
- unsportsmanlike conduct.....	40.3, 75.3
- unsustained complaint regarding legality of a glove.....	12.2
- unsustained request for stick measurement.....	10.5
Biting.....	21, 75.2, Table 8
Blocking glove.....	11.6, 51.3, Table 8, Table 15
Blood.....	8.3
Boarding.....	23.5, 30.1, 42 , Table 2, Table 5, Table 7, Table 8
- fines.....	42.6
- game misconduct penalty.....	42.5
- major penalty.....	42.3
- match penalty.....	42.4
- minor penalty.....	42.2
- suspensions.....	42.6
Boards.....	1.3
- banging.....	40, Table 1, Table 9
- boarding.....	42
- charging.....	43.1
- color.....	1.3
- dimensions.....	1.3
- frozen against – puck.....	15.5
- glass.....	1.3
- markings.....	1.3
- puck coming to rest on top of.....	85.1
- puck frozen against.....	15.5
- puck out of bounds.....	85
- restricted area.....	28.8

Rule Number

- safety glass	1.3
Boot channel	11.2
Boot of the pad	11.2
Breakaway	25.8, 53.6, 56.6, 57.3, 63.5, 68.1, Table 1, Table 13
Breaking stick when requested for measurement	10.5
Broken stick	10.3, 10.4, 56.2, Table 2
Butt-ending	58 , Table 4, Table 5, Table 6, Table 8, Table 11
- double-minor penalty	15.3, 58.2
- fines	58.6
- game misconduct penalty	58.5
- major penalty	58.3
- match penalty	58.4
- signal	30.2
- suspensions	58.6

C

Calf protectors	11.2
Calling of penalties	15 , Table 1
Calling penalty – goal scored	15.2, 15.3, 15.4
Captain	6.1 , Table 16, Table 17
- alternate captains	6.2
- coming off the bench to protest	6.1, 40.2
- delayed penalties – penalties expire at the same time	27.2
- delaying the game	63.3
- designated player – bench minor penalty	17.1
- designated player – goalkeeper's penalties	28.1
- designated player – match penalty	21.2
- designated player – misconduct penalty to goalkeeper	22.2
- designated player – penalty shot	25.3, 53.6
- listed on game sheet	34.1
- official report of match	34.1
- penalties to two players expire at the same time	16.2, 27.2, 36.5
- refusing to start play	73.2
- requesting stick measurement	10.5
Carrying two sticks	10.5
Catching glove	11.5
Change of players	70.2, 81.4, 82
Change of possession	13.3
Charging	30.3, 42.1, 43 , Table 2, Table 5, Table 7, Table 8, Table 10
- fines	43.6
- game misconduct penalty	43.5
- goalkeeper in crease	43.1
- major penalty	43.3
- match penalty	43.4
- minor penalty	43.2



	<u>Rule Number</u>
- suspensions.....	43.6
Checking from behind	23.5, 30.4, 44 , Table 5, Table 6, Table 8
- fines	44.6
- game misconduct penalty.....	44.5
- major penalty	44.3
- match penalty	44.4
- minor penalty.....	44.2
- suspensions.....	44.6
Chest pad	11.3
Choice of ends	86.3
Circles – face-off	1.9, 76, 86.1, 86.8
Clearing the area of a fight.....	47.4
Clearing the zone	83.3
Clipping	30.5, 45 , Table 2, Table 5, Table 6, Table 8, Table 10
- fines	45.6
- game misconduct penalty.....	45.5
- major penalty	45.3
- match penalty	45.4
- minor penalty.....	45.2
- suspensions.....	45.6
Clock	4 , 35, 36.5, 39.6, 77.2, 86.2, 86.8
Closing hand on the puck.....	67.2, 79.1
Clothing	14.1, 63.2, 65.2
Clothing – adjustment.....	14.1, 63.2, 65.2
Club executive coming onto ice.....	70.10
Coach	5.4
- abuse of officials.....	40, Table 12
- abusive language or gestures	40, 75, Table 12
- attempt to injure a coach	75.5, Table 12
- banging boards.....	40, Table 12
- bench minor penalties	17.1
- captain and alternate captains.....	6.1, 6.2, 34.1
- coming onto ice	70.5
- deliberate injury of a coach.....	75.5, Table 12
- designated player for bench minor penalties.....	17.1
- designated player for goalkeeper penalties.....	28.1
- designated player for match penalties.....	21.2, 28.5
- distraction during a penalty shot.....	25.4
- eligible players.....	5.1, 34.1
- goalkeeper's penalties.....	28
- interference from bench.....	56.3, Table 12
- involved in altercation	47.8
- leaving bench	70.5, Table 3
- line change warning.....	76.6, 76.7, 82.2
- line-up.....	34.3
- match penalties	21.2, 28.5

Rule Number

- obscene language or gestures.....	40, 75, Table 12
- penalties.....	Table 1
- penalty shot – distraction during.....	25.4
- physical abuse of officials.....	41
- profane language or gestures.....	40, 75, Table 12
- refusing to start play.....	73.2, 73.3
- shootout – stick measurement.....	10.7
- starting line-up.....	7, 34.3
- stick measurement – shootout.....	10.7
- supplementary discipline.....	29
- throwing objects.....	53.3, 75.3, 75.4, Table 12
- unable to continue – referee, linesman.....	32.11, 33.6
- warning – line change.....	76.6, 76.7, 82.2
Coincidental major penalties.....	19.2, Table 16
Coincidental match penalties.....	19.3
Coincidental minor penalties.....	19.1, Table 16, Table 18
Coincidental penalties.....	16.2, 19, 28.5, Table 16, Table 17, Table 18
Coincidental penalty rule.....	19.5, Table 16
Coming from bench without helmet during play.....	9.5
Coming off bench to protest.....	40.2
Coming onto ice – club executive.....	70.10
Coming onto ice – coach.....	70.5
Commercial time-out.....	87.1
- light.....	4.1
Commissioner	
- abuse of officials.....	40.7
- altercation with spectator.....	23.7
- appointment of officials.....	31.1
- attempt to injure a coach.....	75.5
- awarded goal – interference.....	56.7
- boarding.....	42.6
- butt-ending.....	58.6
- charging.....	43.6
- checking from behind.....	44.6
- clipping.....	45.6
- club executive coming onto the ice.....	70.10
- coach coming onto the ice.....	70.5
- coach involved in altercation.....	47.8
- coming onto the ice – club executive.....	70.10
- coming onto the ice – coach.....	70.5
- cross-checking.....	59.6
- dangerous equipment – opposing team objection.....	9.6
- deliberate injury of a coach.....	75.5
- elbowing.....	46.6
- end of game / periods.....	32.9, 86.5
- fighting other than during periods of the game.....	47.20
- fighting prior to drop of puck.....	47.10



	<u>Rule Number</u>
- forfeit of game.....	66.1
- game misconduct penalties.....	23.2, 40.5
- goalkeeper leaving goal crease.....	28.6
- goalkeeper substitution – delay.....	8.2
- goalkeeper's equipment.....	11.8
- goalkeepers' sticks.....	10.2
- head-butting.....	48.6
- high-sticking.....	60.6
- hooking.....	55.6
- ineligible player.....	5.2
- interference – awarded goal.....	56.7
- interference – penalty shot.....	56.6
- kicking.....	49.4
- kneeling.....	50.6
- league inspections.....	11.8, 12.5
- leaving goal crease.....	28.6
- leaving the bench.....	70.10
- line-up policy.....	34.3
- match penalties.....	21.3
- obscene gestures / language.....	40.7, 75.7
- officials.....	31.1
- participating in play with two sticks.....	10.5
- penalty shot – interference.....	56.6
- physical abuse of officials.....	41
- pre-game warm-up.....	86.6
- referee reports.....	32.9
- refusing to start play.....	73.2, 73.3
- roughing.....	51.4
- slashing.....	61.7
- slew-footing.....	52.3
- spearing.....	62.6
- spectator.....	23.7
- start of game / periods.....	32.10, 86.7
- supplementary discipline.....	29, 42.6, 43.6, 44.6, 45.6, 46.6, 48.6, 49.4, 50.6, 51.4, 52.3, 53.8, 55.6, 58.6, 59.6, 60.6, 61.7, 62.6, 75.7
- throwing equipment.....	53.8
- throwing object at spectator.....	23.7
- warm-up.....	86.6
Communication.....	34.4, 36.3, 37.2, 39.5
Confirmation of goal at one end prior to goal at other.....	39.6, 78.6
Contact inside the goal crease.....	69.3
Contact outside the goal crease.....	69.4
Continuing a fight (attempting to continue).....	47.5
Control of the puck	
- awarded goals.....	26.1, 57.4
- calling of penalties.....	15.1
- injured player.....	8.1

Rule Number

- off-side	83.1
- penalty shot.....	25.8, 56.6, 57.3
Correct number of players on the ice.....	63.3
Covering puck in goal crease	67.4, 67.5
Crease	1.7
- charging goalkeeper in crease.....	43.1
- contact inside	69.3
- contact outside.....	69.4
- entering referee's crease	40.4, Table 9
- falling on puck.....	67.4, 67.5, Table 13
- freezing puck.....	63.2, 67.4, 67.5, Table 15
- gathering puck	67.4, 67.5, Table 13
- goal crease	1.7
- goal crease during fight.....	47.4
- goalkeeper in crease – charging.....	43.1
- handling puck.....	67.4, 67.5, Table 13
- holding puck.....	67.4, 67.5, Table 13
- icing.....	81.3
- interference on the goalkeeper	69, Table 2, Table 18
- leaving goal crease	28.6, 32.9, Table 15
- loose pucks	69.6, 78.4
- penalty shot.....	25.2
- picking up puck	67.4, 67.5, Table 13
- rebounds	69.6
- referee's crease	1.7
- referee's crease – entering	40.4, Table 9
- remain in goal crease.....	47.4
- stopping play.....	63.2, 67.4, 67.5, Table 15
Crediting assists	34.1, 78.3
Crediting goals.....	78.2
Crossbar	2.1, 25.2, 60.5, 78.5, 80.3
Cross-checking	59, Table 2, Table 5, Table 6, Table 8, Table 11
- fines	59.6
- game misconduct penalty	59.5
- major penalty	59.3
- match penalty.....	59.4
- minor penalty	59.2
- signal.....	30.6
- suspensions	59.6
Curvature	10.1, 10.5

D

Dangerous equipment	9.6, 12.3
- opposing team objection	9.6
Defending zone.....	1.6
- clearing area of a fight – fight in front of benches.....	47.4
- delaying the game.....	63.2



	<u>Rule Number</u>
- face-offs	76.2
- hand pass	79.2
- hand pass – linesman stopping play	33.5
- handling puck	67.1
- net displaced	63.2
- no off-side	83.1, 83.2
- puck off official directly into goal	76.2
- puck over glass	63.2
- puck unplayable	85.2
- shooting puck over glass	63.2
- throwing equipment	53.2, Table 1, Table 13
Deflection	
- disallowed goals	78.5
- distinct kicking motion	49.2
- during delayed calling of a penalty	78.5
- handling puck	67.6
- high-sticking the puck	80.3
- icing	81.1
- kicking the puck	49.2
- off an official	39.4, 76.2, 78.5, 81.1, 83.2, 85.4
- off body into goal	78.5
- off-side	83.2
- puck out of bounds	85.4
- rebound in the crease	69.6
- rebound on a penalty shot	25.2
Delayed calling of a penalty	78.5
- no goal	78.5
Delayed calling of a penalty shot and goal scored	15.4
Delayed off-side	30.9, 56.2, 83.3
Delayed penalty	19.1, 27 , 30.8, 84.2, Table 16
Delaying the game	63 , Table 2, Table 3, Table 14
- adjustment of equipment	65.2
- awarded goal	63.6
- bench minor penalty	63.3
- covering puck	67.2, 67.3
- dangerous equipment	9.6
- displacing goal post	63.2
- dropping puck on netting	85.6
- end of period	86.5
- face-off violation	76.6
- falling on puck in crease	63.5, 67.4, 67.5
- freezing puck unnecessarily	67.3
- goalkeeper deliberately removing face mask	9.5
- goalkeeper playing puck in restricted area	28.8
- improper line change	82.2
- infractions	63.7
- line change	82.3
- minor penalty	63.2

Rule Number

- objects thrown on ice	63.4
- penalty shot.....	63.5
- playing puck in restricted area	28.8
- protective equipment.....	9.5
- puck dropped on goal netting.....	85.6
- puck over glass	63.2
- refusing to start play.....	73.2, 73.3
- restricted area	28.8
- signal.....	30.9
- slow proceeding to face-off location.....	76.6
- start of game	86.2
- start of period	86.2
- unnecessary stoppage of play	67.3
- unsustained request of opponent's equipment.....	12.2
- warm-up during time-out.....	87.1
Deliberate illegal substitution	68.6, 74.4, Table 3, Table 13
Deliberate injury.....	21
Deliberate injury of a manager, coach.....	75.5, Table 12
Deliberately applying physical force against an official	40.5, 41
Deliberately breaking stick.....	10.5, Table 9
Designated player	
- bench minor penalty.....	17.1
- goalkeeper penalty.....	28
- match penalty.....	21.2, 28.5
- penalty shot.....	25.3
Devices – signal and timing	4, 35.4, 36.5, 39.6
Diagrams	
- Approved Goal Frame.....	page v
- catching glove – goalkeeper's.....	11.5
- Detail of Goal Crease.....	page iv
- Dimensions of Rink Surface.....	page iv
- Face-off Configuration	page v
- Goal Crease	page iv
- Goal Frame	page v
- goalkeeper's catching glove.....	11.5
- goalkeeper's jersey	9.4
- goalkeeper's stick	10.2
- jersey – goalkeeper.....	9.4
- jersey – player.....	9.3
- Official Dimensions of Rink Surface.....	page iv
- player's jersey	9.3
- player's stick	10.1
- Restricted Area	page iv
- Rink Dimensions	page iv
- stick – goalkeeper's	10.2
- stick – players'	10.1
- tape measure	11.5
Dimensions	1.2, 3, 10.1, 10.2, 11, 13.1



	<u>Rule Number</u>
Disallowed goals	78.5
- batting puck	39.4, 67.6, 78.5
- confirmation of goal at one end prior to goal at other	39.6, 78.6
- deflected off official	39.4, 76.2, 78.5, 85.4
- delayed calling of a penalty	78.5
- delayed off-side	83.4
- distinct kicking motion.....	39.4, 49.2, 78.5
- goalkeeper pushed into net together with puck.....	69.6, 78.5
- high-sticking the puck	78.5, 80.3
- illegal substitution	68.5, 78.5
- interference on the goalkeeper.....	69, 78.5
- kicking.....	39.4, 49.2, 78.5
- leaving the penalty bench.....	68.5, 70.4, 78.5
- linesman reporting foul that occurred prior to goal	33.4, 78.5
- net dislodged	63.2, 78.5
- off-side	83.4
- play was stopped.....	32.2, 78.5, 83.4
- public address	32.5, 39.2, 78.5
- video goal judge	39.2
- video review.....	78.5
- whistle had blown	32.2, 78.5, 83.4
Discarded stick or other equipment.....	53.2
Discipline – supplementary	29 , Table 18
- abuse of officials.....	40.6, 40.7
- attempt to injure a team official.....	75.5
- boarding.....	42.6
- butt-ending.....	58.6
- charging.....	43.6
- checking from behind	44.6
- clipping	45.6
- cross-checking.....	59.6
- diving	64.3
- elbowing	46.6
- embellishment	64.3
- fighting.....	47.10, 47.20
- game misconduct penalties	23.2
- head-butting.....	48.6
- high-sticking.....	60.6
- hooking	55.6
- interference from the bench.....	56.2
- interference on the goalkeeper.....	69.7
- kicking.....	49.4
- kneeling	50.6
- leaving the bench	70.2
- match penalties	21.2
- physical abuse of officials.....	41.6
- roughing.....	51.4
- slashing	61.7

	<u>Rule Number</u>
- slew-footing	52.3
- spearing	62.6
- throwing equipment.....	53.8
- unsportsmanlike conduct	75.5, 75.6, 75.7
Displacing goal post.....	63.2, 63.5, 63.6
Disputes	
- clock.....	32.2, 35.7, 39.6
- the rulings of an official	40.1, Table 12
- expiration of penalties	32.2, 36.1
- final decision	32.2
- referee.....	32
- penalties.....	32.2, 36.1
- time	32.2, 35.7, 39.6
- unsportsmanlike conduct	40.1, Table 12
Distinct kicking motion	39.4, 49.2, 78.5
Distracting goalkeeper during penalty shot.....	25.4
Distracting player during penalty shot.....	25.4
Diving.....	64
- fines	64.3
- minor penalty	64.2
- suspensions	64.3
Division of ice surface.....	1.6
Double-minor penalty.....	18 , Table 4, Table 16
- butt-ending	58.2
- disallowed goals.....	78.5
- foul resulting in a penalty shot	25.6
- goal scored	15.3
- head-butting	48.2
- high-sticking	60.3
- last five minutes and overtime	19.4
- linesman reporting high-stick causing injury	33.4, 78.5
- spearing	62.2
Drop of puck – fighting prior to.....	47.10

E

Elbow pads	9.5, 12.3
Elbowing	30.10, 46 , Table 2
.....	Table 5, Table 7, Table 8, Table 10
- fines	46.6
- game misconduct penalty	46.5
- major penalty	46.3
- match penalty.....	46.4
- minor penalty	46.2
- suspensions	46.6
Eligible player	5.1, 10.7, 34.1
Embellishment	64
Emergency recall – goalkeeper	5.3, 11.8



	<u>Rule Number</u>
Encroachment	33.5, 76.5, 76.6
End of game	32.10, 86.5
- fighting	47.9
End of period	4, 86.5, Table 3
- fighting	47.9
Ends – choice of	86.3
Entering referee's crease	40.4, Table 9
Equipment	65 , Section 3, Table 2, Table 9, Table 15
- adjustment of equipment	14.1, 63.2, 65.2
- blood stained	8.3
- dangerous equipment	9.6, 12.3
- goalkeeper's equipment	11
- goalkeeper's equipment repairs	28.6
- goalkeeper's jersey	9.4
- illegal equipment	12.1
- jersey	9
- kicking equipment	49.2
- linesmen equipment	33.1
- minor penalty	65.2
- numbers	9.2
- penalty timekeeper equipment	36.2
- player's jersey	9.3
- preventing opponent from retrieving equipment	56.2
- protective equipment	9.5
- puck	13
- referees' equipment	32.1
- retrieving equipment after a fight	47.19
- sticks	10
- throwing equipment	53
- throwing equipment at an official	41.4
- throwing equipment out of playing area	40.4, 75.2, 75.4, 75.5
- uniform	9.1
- video goal judge equipment	39.5
Event summary	38.3
Exhibition games	29.2
Expiration of penalties	32.2, 36.1
Extra attacker	Table 14
- awarded goals	26.3
- goalkeeper in regular season overtime	74.5, 84.2
- goalkeeper on an icing	81.4
- line change on icing	82.1
- illegal substitution	74
- overtime – regular season	74.5, 84.2
- premature substitution	71.1
Eye gouging	21, Table 8

F

Face masks	11.7
Face protection	47.6, 75.2
Face-off.....	76 , Table 2
- abstaining from playing puck	72.1
- calling of penalties	15.5, 76.2
- circles.....	1, 76, 86.1
- false	35.7, 39.6
- fighting prior to	47.10, 70.2
- five second limit	76.3
- goalkeeper losing mask	9.5
- hand pass	79.3
- high-sticking the puck	80.2
- icing.....	81.2
- injured players.....	8.1, 76.2
- interference with goalkeeper.....	69.5
- linesmen.....	33.2
- off-side	83.5
- objects thrown on ice	63.4
- penalty shot.....	25.5
- player losing helmet.....	9.5
- premature substitution	71.1
- procedure.....	76.3
- puck out of bounds.....	85.1
- puck unplayable	85.2
- puck out of sight.....	85.3
- puck striking official.....	85.4
- referees.....	32.3
- refusing to play puck	72
- responsibility	32.3, 33.2, 76.1
- spots	1.9, 8.1, 9.5, 25.2, 30.18, 69.5
.....	71.1, 72, 76, 80.2, 81.2, 83.5, 85.5
- start of game	86.1
- start of periods	86.1
- verification of time	35.7, 39.6
- violations	76.6, 82.1, 87.1, Table 2
Facial injury protection.....	9.6
Fake an injury	64.1
Failure to comply with referee's direction	63.3
Failure to place player on penalty bench – major penalty	20.3
Failure to proceed directly to penalty bench.....	47.19
Fair play	12.4
Falling on puck in crease	67.4, 67.5, Table 13
Fans throwing objects on ice	63.4
Feign an injury	64.1
Fighting.....	47 , 86.6, Table 5, Table 6
.....	Table 9, Table 10, Table 12



	<u>Rule Number</u>
- aggressor.....	47.2, 47.17
- after the original altercation	47.7
- altercation	47.3
- clearing the area.....	47.4, 47.18
- continuing a fight (attempting to continue).....	47.5
- face protection	47.6
- failure to proceed to penalty bench	47.19
- fines	47.17, 47.18, 47.19, 47.20, 47.21, 47.22
- inciting an opponent	75.4
- instigator	47.11, 47.12, 47.21, 47.22
- jerseys	47.13
- major penalty	47.14
- match penalty	47.15
- off the playing surface	47.8
- other than during the periods of the game	47.9, 47.20
- prior to the drop of the puck.....	47.10
- second instigator in game.....	47.11
- suspensions.....	47.17, 47.18, 47.19, 47.20, 47.21, 47.22
- third instigator in season.....	47.11
- third man in.....	47.16
Final decision	32.2
Final five minutes – instigator.....	47.12
Fines	
– aggressor.....	47.17
– boarding.....	42.6
– butt-ending.....	58.6
– charging	43.6
– checking from behind.....	44.6
– clearing the area of a fight	47.18
– clipping.....	45.6
– cross-checking.....	59.6
– diving	64.3
– elbowing.....	46.6
– embellishment.....	64.3
– failure to proceed directly to penalty bench	47.19
– fighting other than during the periods of the game	47.20
- goalkeeper’s equipment	11.8
– head-butting	48.6
– high-sticking	60.6
– hooking	55.6
- illegal stick	10.5, 10.7
– instigator	47.21
– instigator in final five minutes.....	47.22
– interference on the goalkeeper	69.7
– kicking.....	49.4
- kneeling	50.6
– leaving the bench.....	70.10
- major penalties	20.5

Rule Number

- misconduct penalties	22.5
- game misconduct penalties	23.3, 22.4, 22.5, 28.2, 28.3, 28.4, 28.6
- refusing to start play	73.2, 73.3
- roughing	51.4
- slashing	61.7
- slew-footing	52.3
- spearing	62.6
- start of game	86.7
- supplementary discipline	29
- throwing equipment	53.8
- unsustained request for stick measurement	10.5
- video review	39.2
Flexible pegs	2.1, 63.6, 78.5
Flooding the ice	1.1
Forfeit of game	66, 73.2, 73.3
Foul resulting in penalty shot	25.8
Fouling from behind	25.8, 57.3
Freezing the puck (frozen puck)	Table 15
- back of net	85.2
- between opposing players	85.2
- delaying the game	63.2
- face-off location – calling of penalties	15.5, 76.2
- puck unplayable	85.2
- unnecessarily	67.3

G

Game	
- end of	32.10
- forfeit of	66, 73.2, 73.3
- start of	32.10, 86.1
Game Flow	Section 10
Game misconduct – automatic	20.4, 23.6, 47.7, 47.11
.....	59.5, Table 6, Table 7
Game misconduct penalty	23, Table 12
- abuse of officials	40.5
- attempt to injure a team official	75.5
- boarding	42.5
- butt-ending	58.5
- captain coming off the bench	6.1
- charging	43.5
- checking from behind	44.5
- clipping	45.5
- cross-checking	59.5
- elbowing	46.5
- fighting	47
- goalkeeper	28.4
- head-butting	48.5



	<u>Rule Number</u>
- hooking	55.4
- interference.....	56.5
- interfering with a spectator	23.7
- kneeling	50.5
- leaving the bench	70.6
- penalty timekeeper	36.1, 36.6
- physical abuse of officials.....	41.1
- post-game verbal abuse	23.7
- protective equipment	9.5
- racial taunts or slurs	23.7
- refusing to start play	73.2
- request for review / rescind	23.2
- slashing	61.5
- spearing.....	62.5
- spitting	23.7
- striking a spectator	23.7
- throwing equipment	53.4
- unsportsmanlike conduct.....	75.5
- verbal abuse	23.7
- video review.....	39.2
Game sheet.....	34.1
Game summary.....	38.3
Game time clock.....	4
Game timekeeper.....	35
- delays	77.3, 86.4
- game timing	77.1
- interfering with	40.3
- intermission timing.....	35.2, 77.2
- official scorer – time of goals	34.2
- overtime.....	35.3, 84.1, 84.5
- pre-game warm-up	86.6
- public address – one minute remaining.....	35.1
- referee duties.....	32.6
- signal devices	35.4
- start of game.....	86.6
- start of periods.....	35.5, 77.2, 86.1
- television.....	35.6
- time-outs.....	87.1
- verification of time.....	35.7, 39.6
- warm-up.....	86.6
Game timing.....	77.1
Games – exhibition.....	29.2
Gathering puck in crease	67.4, 67.5, Table 13, Table 14
General category.....	23.3, Table 10
General duties	
- game timekeeper.....	35.1
- goal judge.....	37.1
- linesmen	33.3

Rule Number

- official scorer	34.1
- penalty timekeeper	36.1
- real time scorers	38.1
- referees	32.4
- video goal judge	39.1
Glass	
- banging glass	40.2, 40.4
- broken glass – face-off location	85.1
- delay of game	63.2
- dimensions	1.3
- face-off location – broken glass	85.1
- face-off location – off-side	83.5
- height	1.3
- off-side – face-off location	83.5
- penalty bench	3.2
- players' benches	3.1
- puck out of bounds	85.1
Glove	12.2, Table 8, Table 15
- batting into net	67.6
- blocking	11.6, 51.3, Table 8, Table 15
- catching	11.5
- deflection into net	67.6
- disallowed goal	49.2, 67.6
- equipment	65.2
- illegal equipment	12.1
- instigator criteria	47.11
- kicking glove	49.2
- match penalty	51.3
- palm removed or cut	12.2
- protective equipment	9.5
- puck out of bounds	85.1
- roughing	51.1
Goal	78
- awarded	26 , Table 14
- awarded – falling on puck	67.5
- awarded – fouled from behind	54.4, 55.6, 57.4 , 61.7
- awarded – gathering puck	67.5
- awarded – goal displaced	63.6
- awarded – holding puck	67.5
- awarded – illegal player	56.7, 68.4, 70.8
- awarded – interference from bench	56.7
- awarded – picking up puck	67.5
- awarded – piling snow	67.5
- awarded – throwing equipment	53.7
- crediting	78.2
- disputed	39.1
- disallowed	39.4, 78.5
- disallowed – batting puck	67.6



	<u>Rule Number</u>
- disallowed - high-sticking.....	60.5, 80.3
- disallowed – illegal player.....	5.2, 68.5, 70.9
- disallowed – ineligible player.....	5.2
- disallowed – kicking.....	49.2
- disallowed – leaving bench.....	68.5, 70.9
- disallowed – off an official.....	78.5
- disallowed – off-side.....	83.4
- light.....	4.1
- official scorer.....	34.1
- public address.....	32.5, 34.2, 39.2
- referee.....	32.5
- scored – double-minor penalty.....	15.3
- scored – minor penalty.....	15.2
- scored – minor and misconduct penalty.....	22.3
- scored – overtime.....	84.1
- scored – short-handed team.....	15.4
- scored – signal.....	30.11
- throwing equipment.....	53.7
- video review.....	39.2, 78.6
Goal crease (see Crease)	
Goal frame.....	1.7, 2.2
Goal judge.....	37
Goal pegs.....	2.1, 63.6, 78.5
Goal posts.....	2
- awarded goal.....	63.6
- displacing.....	63.2, 63.5, 63.6
- goal crease.....	1.7
- goal frame.....	1.7, 2.2
- goal judge.....	37.1
- penalty shot.....	63.5
- rebound off post on penalty shot.....	25.2
- scoring a goal.....	78.4
Goals scored against a short-handed team.....	Table 16
Goalkeeper	
- back-up (see also substitute).....	11.8
- charging in crease.....	43.1
- deliberately removing face mask.....	9.5
- during the course of a penalty shot.....	25.2, 25.4
- equipment.....	5.3, 11 , 14.1, 28.6, 63.2, 65
- handling puck.....	67.3
- icing.....	81.3
- injured.....	8.2
- interference.....	69
- jersey.....	9.4
- leaving goal crease.....	28.6, 32.9
- losing helmet and/or mask.....	9.5
- overtime – regular season.....	74.5, 84.1, 84.2
- penalties.....	28 , 36.3, Table 15

Rule Number

- player using goalkeeper's stick	10.3
- player's stick – goalkeeper using	10.4
- playing puck over center red line	28.7
- premature substitution	71.1
- proceeding to players' bench	28.6
- pushed into net together with puck	69.6, 78.5
- restricted area	1.8, 28.8, Table 15
- resuming position	8.2
- shootout	84.4
- stick	10.2, 11.1, 49.2
- substitute	5.3, 25.2
- substitution	8.2, 34.1
- third	5.3
- uniform	9.4, 9.5
Gouging – eye	21.1, Table 8
Grabbing face mask	75.2, Table 8

H

Hair pulling	75.2, Table 8
Hand pass	67.1, 79
- abstains from playing the puck	72.2
- linesman stopping play	33.5
- refusing to play puck	72.2
- signal	30.12
Handling puck	67
- awarded goal	67.5
- delaying the game	63.2
- disallowed goal	67.6
- hand pass	79
- in crease	67, Table 13
- minor penalty – goalkeeper	67.3
- minor penalty – player	67.2
- penalty shot	67.4
Hash marks (restraining lines)	1.9, 76.5
Head-butting	15.3, 30.2, 48 , Table 4, Table 5, Table 6, Table 8, Table 10
- double-minor penalty	48.2
- fines	48.6
- game misconduct penalty	48.5
- major penalty	48.3
- match penalty	48.4
- suspensions	48.6
Helmet	9.5
Heel of the stick	10.1
High-sticking	60, 80 , Table 2, Table 4, Table 8
- abstaining from playing puck	72.3
- cradling the puck (like lacrosse)	25.2, 80.1



	<u>Rule Number</u>
- disallowed goal	39.4, 60.5, 78.5, 80.3
- double-minor penalty	60.3
- double-minor penalty – goal scored	15.3
- double-minor penalty – linesman reporting	33.4
- fines	60.6
- goals	60.5
- match penalty	60.4
- minor penalty	60.2
- puck	33.5, 80
- refusing to play puck	72.3
- signal	30.14
- suspensions	60.6
- video review	39.4
Holding	54 , Table 2
- awarded goal	54.4
- interference	56.1
- minor penalty	54.2
- penalty shot	54.3
- restrain	56.1
- signal	30.15
- stick	54.2, Table 2
- stick – signal	30.16
Holding puck in crease	67.4, 67.5, Table 13
Hooking	55 , Table 2, Table 5, Table 6, Table 11
- awarded goal	55.6
- fines	55.7
- game misconduct penalty	55.4
- interference	56.1
- major penalty	55.3
- minor penalty	55.2
- penalty shot	55.5
- restrain	56.1
- signal	30.17
- suspensions	55.7
Human factor	32.2

I

Ice surface	1.1
- division of	1.6
- injured player	8.1
- leaving the penalty bench	70.4
- proceeding to dressing room	70.3
- stick measurement	10.5
- too many men on the ice	74.1
Icing	81
- abstaining from playing puck	72.4, 81.2
- attainable pass	81.5

Rule Number

- back of net	81.5
- deflections in the neutral zone	81.5
- directly off the face-off.....	81.5
- dislodging puck from back of net	81.5
- error – face-off location	81.2
- face-off location.....	81.2
- goalkeeper	81.3
- line change.....	81.4, 82.1
- linesman stopping play	33.5
- no icing.....	81.5
- numerical strength	81.6
- penalty – non-offending team – face-off location	15.5
- puck striking official.....	81.1, 85.4
- rebound of defending player	81.5
- receivable pass	81.5
- refusing to play puck	72.4, 81.2
- short-handed	81.6
- signal.....	30.18
- unnecessary contact	42.1
Illegal equipment.....	11.8, 12, Table 2, Table 15
Illegal puck.....	13.3, 56.2
Illegal stick – remain at penalty bench.....	10.5
Illegal substitution	68, Table 3, Table 13
- awarded goal	68.4, 70.8
- bench minor penalty.....	68.2
- deliberate	68.6, 74.4
- disallowed goal	68.5, 70.9, 78.5
- failure to put substitute in for major penalty	20.2, 68.2
- goalkeeper in regular season overtime.....	74.5
- leaving the penalty bench	68.5, 70.4, 74.3
- leaving the players' bench	68.5, 70.3
- major penalty	20.3, 68.2
- overtime – regular season – goalkeeper.....	74.5
- penalty shot.....	68.3, 70.7
- regular season overtime – goalkeeper.....	74.5
- too many men on the ice.....	74
Improper line change	82.2
Improper starting line-up.....	7.2
Inciting an opponent	75.4, Table 9, Table 10
Ineligible player.....	5.2, 33.5, 70.4, 74.3, 78.5, 84.2
Infractions	
- abuse of officials	40
- awarded goals.....	26, Table 14
- bench minor penalties	17, Table 3
- calling of penalties	15
- delaying the game.....	63
- double-minor penalties.....	18, Table 4
- game misconduct penalties	23, Table 12



	<u>Rule Number</u>
- goalkeepers	28, Table 15
- icing	81
- interference on the goalkeeper	69, Table 18
- major penalties	20, Table 5
- match penalties	21, Table 8
- minor penalties	16, Table 2
- misconduct penalties	22, Table 9
- off-side	83
- penalty shot	25, Table 13
- referee general duties.....	32.4
- unique to goalkeepers	28, Table 15
Injured goalkeeper.....	8.2
Injured player.....	8.1
- attending to.....	70.5
- dangerous equipment.....	9.6
- face-off location	8.1, 76.2
- leaving the ice.....	8.1
- icing	81.4, 82.1
- major penalty - serving	68.2
- penalized player	8.1
- serious injury	8.1
- stopping play	8.1
- substitute for	8.1
Injury.....	8, Table 7, Table 8
- aggressor.....	47.2
- attempt to injure	21.1, Table 8
- attempt to injure a Manager, Coach	75.5
- attempt to injure an official.....	40.5, 41
- biting	21.1, Table 8
- blocking glove.....	51.3, Table 8
- blood.....	8.3
- boarding.....	42.4, 42.5, Table 7, Table 8
- boards.....	1.3
- butt-ending.....	58.4, Table 8
- charging.....	43.4, 43.5, Table 7, Table 8
- checking from behind	44.4, Table 8
- clipping	45.3, 45.4, Table 8
- cross-checking.....	59.4, Table 8
- dangerous equipment.....	9.6
- delays due to	34.1
- deliberate injury	21.1, Table 8
- deliberate injury of a Manager, Coach.....	75.5
- designated player for penalty shot – injury to	25.3
- deliberately applies physical force against an official.....	40.5, 41
- elbowing	46.4, 46.5, Table 7, Table 8
- face – injury to	20.4, Table 7
- facial injury protection.....	9.6
- feigns an injury	64.1

Rule Number

- goalkeeper proceeding to players' bench	28.6
- goalkeeper resuming position	8.2
- grabbing of the face mask.....	21.1, Table 8
- hair pulling.....	21.1, Table 8
- head-butting	48.4, Table 8
- head – injury to	20.4
- high-sticking	60.3, 60.4, Table 8
- hooking	55.3, 55.4
- icing – line change	81.4, 82.1
- injured goalkeeper	8.2
- injured players.....	8.1
- intent to injure an official	41
- kicking	49.3, Table 8
- kneeing	50.4, Table 8
- leaving the ice during play	8.1, 74.1
- line change – icing	81.4, 82.1
- linesmen.....	33.5, 33.6
- major penalties.....	20.3
- match penalties.....	21.1, Table 8
- penalized player.....	8.1
- penalty shot – injury to designated player.....	25.3
- punch causing injury	47.15, 51.3, Table 8
- referees.....	32.11
- slashing.....	61.3, 61.4, Table 8
- spearing	62.4, Table 8
- stopping play	8.1, 8.2
- striking an official	41
- substitution for injured player	8.1
- tape on hands	47.15, Table 8
- threaten to injure an official.....	41.4
- throwing stick / equipment	53.5, Table 8
- warm-up for substitute goalkeeper.....	8.2
- wearing tape on hands.....	47.15, Table 8
Inner knee padding	11.2
Inner risers	11.2
Inspections.....	11.8, 12.5
Instigator	47.11 , Table 2, Table 6
- face shield.....	75.2
- final five minutes of regulation or in overtime	47.12
- instigator, aggressor and game misconduct list.....	36.6
- leaving penalty bench	70.4
- referee reports	32.9
- second in game.....	47.11
- third in season.....	47.11
- visor	75.2
- wearing a face shield	47, 75.2
Instigator, aggressor and game misconduct list	36.6
Intent to injure an official.....	41



	<u>Rule Number</u>
Intentional off-side	76.2, 83.6
Interference	56
- awarded goal	56.7, Table 1
- bench minor penalty	56.3
- breakaway	56.6, 56.7, Table 1
- body position	56.1
- broken stick	53.2, 56.2
- discarded stick or other equipment.....	53.2, 56.2
- free hand	56.1
- from players' bench	56.2, 56.3, 74, Table 3
- game misconduct penalty.....	56.5
- goalkeeper – on the.....	69, 78.5, Table 2, Table 18
- illegally entered the game.....	68.3, 68.4, 70
- major penalty	56.4
- minor penalty	56.2
- official – with an	40.3, Table 1
- penalty shot	56.6, Table 1
- pick	56.1
- play in progress	56.2, Table 1
- possession of the puck.....	56.1
- restrain.....	56.1
- signal	30.19
- spectators – by/with.....	23.7, 33.5, 53.6
- stick (use of)	56.1
Interference on the goalkeeper	69
- contact inside the crease.....	69.3
- contact outside the crease.....	69.4
- face-off location	69.5
- fines	69.7
- loose pucks.....	69.6
- penalty	69.2
- rebounds.....	69.6
- suspensions.....	69.7
Interference on the goalkeeper situations	Table 18
Interfering or distracting from bench on penalty shot.....	25.4
Interfering with an official.....	40.3, Table 1
Interfering with game timekeeper	40.3
Intermission	32.10, 35.2, 77.2, 84.5, 86.1
- timing	35.2, 77.2
Intervening in an altercation (fight).....	47.16, Table 12

J

Jersey.....	Table 10
- altered.....	9.1, 9.3, 9.4
- during fight.....	47.13, Table 10
- goalkeeper.....	9.4
- modified.....	47.13, 75.2

Rule Number

- player	9.3
- removing	47.13, 75.2

K

Kicking	49
- deflections	49.2
- disallowed goals	78.5
- distinct kicking motion	39.4, 49.2
- equipment	49.2
- fines	49.4
- glove	49.2
- goals	49.2
- match penalty	21.1, 49.3, Table 8
- puck	49.2
- suspensions	49.4
- video goal judge	39.4
Kick plate	1.3
Kneeing	30.21, 50 , Table 2, Table 5, Table 6, Table 8, Table 10
- fines	50.6
- game misconduct penalty	50.4
- major penalty	50.3
- match penalty	50.4
- minor penalty	50.2
- suspensions	50.6
Knee strap pad	11.2

L

Lacrosse-like move	25.2, 80.1
Last five minutes and overtime	19.4, Table 17
League inspections	11.8, 12.5
Leaving before time expires	36.1
Leaving the bench	70 , Table 1, Table 3, Table 14
- awarded goal	70.8
- bench minor penalty	70.5
- disallowed goal	68.5, 70.9, 78.5
- during stoppages of play	70.3
- fines	70.10
- game misconduct penalty	70.6
- legal line change	70.2
- penalty bench	36.1, 40.5, 68.1, 68.5, 70.4, Table 12
- players' bench	70.3
- penalty shot	70.7
- protest	6.1, 40.2, Table 9
- suspensions	70.10



	<u>Rule Number</u>
- without helmet during play	9.5
Leaving the goal crease	28.6, 32.9, Table 15
Leaving the ice during the play.....	8.1, 74.1
Leg guards	9.5, 11.2, 65.2
Legal line change	70.2
Light	
- commercial	4.1
- end of period.....	4.1
- goal.....	4.1
Line change	82
- delaying the game	63.3
- face-off procedure	76.3
- icing	81.4, 82.1
- legal line change.....	70.2
- procedure	82.2
- start of periods.....	86.8
- warning	76.6, 82.2
Lines.....	1.5, 28.7
Linesmen.....	33
- abuse of officials.....	40
- appointment of linesmen	31.1
- articles thrown on ice.....	33.4, 53.3, 75.2, 75.3, Table 1, Table 3
- attire and equipment.....	33.1
- equipment.....	33.1
- face-off responsibility.....	32.3, 33.2, 76.1
- goals.....	33.5, 78.5
- hand pass.....	33.5, 79
- high-stick causing injury	33.4, 60.3, 78.5
- high-sticking the puck	33.5, 80.1
- icing	33.3, 81
- ineligible player.....	5.2, 33.5, 70.4, 74.2, 78.5, 84.4
- injury – stopping play.....	8.1
- interference by/with spectators.....	23.7, 33.5
- jersey during fight	47.13, Table 10
- leaving the bench	70.4
- line changes	82.2
- off-side.....	33.3, 83
- penalty shot – throwing equipment.....	33.5, 53.6
- physical abuse of officials.....	41
- premature substitution of the goalkeeper	33.5, 71.1, 74.1
- puck out of bounds	33.5, 85.1
- referee performing duties of linesman.....	32.4
- reporting foul that occurred prior to goal.....	33.4, 78.5
- reporting to the referee	33.4
- resisting a linesman.....	40.5, 41, 47.5, Table 10
- signals	30.9, 30.11, 30.12, 30.14, 30.18, 30.33
- stopping play	33.5
- stopping play for injury.....	8.1

Rule Number

- tie down (jersey).....	47.13, Table 10
- throwing equipment – penalty shot.....	33.5, 53.6
- too many men on the ice.....	74.2
- unable to continue.....	33.6
Line-up	
- line change.....	82.1
- numbers.....	9.2
- start of periods.....	86.8
- starting.....	7, 34.1, 86.8, Table 3
Listed on game sheet.....	34.1
Littering the ice.....	63.4
Logos – on-ice.....	1.1
Loose pucks.....	69.6, 78.4, 83.3, Table 18

M

Major penalty.....	20 , Table 5, Table 6, Table 7, Table 10, Table 16, Table 17, Table 18
- boarding.....	42.3
- butt-ending.....	58.3
- charging.....	43.3
- checking from behind.....	44.3
- clipping.....	45.3
- coincidental major penalties.....	19.2
- cross-checking.....	59.3
- disallowed goal.....	78.5
- elbowing.....	46.3
- fighting.....	47.14
- goalkeeper penalties.....	28.2
- head-butting.....	48.3
- hooking.....	55.3
- interference.....	56.4
- kneeing.....	50.3
- linesmen reporting.....	33.4
- penalty timekeeper.....	36.1
- roughing.....	51.1
- slashing.....	61.3
- spearing.....	62.3
- substitute.....	20.3
- when player (or team) assessed major plus minor penalty.....	27.3
- when player assessed major plus misconduct penalties.....	22.3
- when replacement player not placed on penalty bench – no icing.....	81.6
- when replacement player does not return to ice from penalty bench.....	68.2
Markings.....	1.1
Mask.....	9.5, 11.7, 75.2, Table 8
Match penalty.....	21 , Table 8, Table 16
- boarding.....	42.4
- butt-ending.....	58.4



	<u>Rule Number</u>
- charging	43.4
- checking from behind	44.4
- clipping	45.4
- coincidental match penalties	19.3
- cross-checking	59.4
- designated shooter for penalty shot	25.3
- disallowed goal	78.5
- elbowing	46.4
- fighting	47.15
- goalkeeper during the course of a penalty shot	25.4
- goalkeeper's penalties	28.5
- head-butting	48.4
- high-sticking	60.4
- kicking	49.3
- kneeling	50.4
- linesmen	33.4
- penalty timekeeper	36.6
- reports	32.9
- roughing	51.3
- shootout eligibility	84.4
- slashing	61.4
- slew-footing	52.2
- spearing	62.4
- tape on hands	47.15
- throwing equipment	53.5
Measurements	
- arm pads	11.3
- blocking glove	11.6
- catching glove	11.5
- chest pad	11.3
- curvature	10.1, 10.5
- deliberately breaking stick	10.5, Table 9
- goalkeeper's equipment	11
- illegal stick – remain at penalty bench	10.5
- league inspections	11.8
- leg guards	11.2
- pants	11.4
- refusing to surrender stick	10.5, Table 9
- stick	10.5, 10.6
- stick gauge	36.2
- stick - prior to penalty shot	10.6
- stick - prior to shootout attempt	10.7, 84.4
- tape	10.5, 11.5, 32.1, 33.1, 36.2
- unsustained request for measurement	10.5, Table 3
Measuring tape	10.5, 11.5, 32.1, 33.1, 36.2
Medial rolls	11.2
Minor league goalkeeper	5.3, 11.8
Minor penalty	16, Table 2, Table 16, Table 17, Table 18, Table 20

Rule Number

- abuse of officials	40.2
- adjustment to clothing or equipment	14.1, 63.2, 65.2
- boarding	42.2
- broken stick	10.3, 10.4
- captain coming off bench	6.1
- charging	43.2
- checking from behind	44.2
- clipping	45.2
- closing hand on the puck	67.2, 67.3, 79.1
- coincidental minor penalties	19.1, Table 16, Table 18
- cross-checking	59.2
- dangerous equipment	9.6
- delayed calling of a penalty – no goal	78.5
- delayed penalties	27.1
- delay of game – dropping puck on netting	85.6
- delay of game – face-off violation	76.6
- delay of game – slow proceeding to face-off location	76.6
- delaying the game	63.2
- diving	64.2
- elbowing	46.2
- embellishment	64.2
- expiration criteria	16.2
- face-off violation	76.6
- goal scored	15.2
- goalkeeper leaving the crease	28.6
- goalkeeper playing puck in restricted area	28.8
- goalkeeper playing puck over center red line	28.7
- goalkeeper's penalties	28
- handling puck	67.2, 79.1
- high-sticking	60.2
- holding	54.2
- hooking	55.2
- illegal equipment	12.1
- illegal stick	10.5
- improper starting line-up	7.2
- instigator	47.11
- instigator with face protection	47.6
- interference	56.2
- interference on the goalkeeper	69.2
- kneeling	50.2
- leaving the bench	70.4
- leaving the crease	28.6
- major plus minor assessed to same player at same time	20.1
- misconduct plus minor player substitute	22.3
- penalty timekeeper	36.1
- playing puck in restricted area	28.8
- playing puck over center red line	28.7
- premature substitution	71.1, 74.1



	<u>Rule Number</u>
- protective equipment	9.5, 65.2
- restricted area	28.8
- roughing	51.2
- slashing	61.2
- starting line-up	7.2
- throwing equipment	53.2
- too many men on the ice	71.1, 74.1
- tripping	57.2
- unsportsmanlike conduct	40.2, 75.2
- unsustained request for measurement	10.5, 12.2
Mirrored image benches	3.1
Misconduct penalty	22 , Table 9
- abuse of officials	40.4
- breaking stick when asked for measurement	10.5
- captain coming off bench	6.1
- coincidental minor penalties when misconducts assessed	19.1
- goalkeeper's penalties	28.3
- inciting an opponent	75.4, Table 9, Table 10
- interfering or distracting from bench on penalty shot	25.4
- linesmen reporting	33.4
- penalty timekeeper	36.1
- protective equipment	9.5
- reports by referee	32.9
- signal	30.23
- substitute	22.3
- unsportsmanlike conduct	75.4
Modified jersey	47.13, 75.2
Modified stick	9.5

N

Net dislodged	63.2, 63.5, 63.6, 78.4, 78.5
Nets	1.4, 1.7, 2
Netting	1.4, 85.1
Neutral zone	1.6
- face-offs	76.2
- face-off location – calling of penalties	15.5
- face-off location – interference on the goalkeeper	69.5
- face-off location – puck out of play	85.5
- hand pass	79.3
- high-sticking the puck	80.2
- icing – error	81.2
- off-side	83.5
- penalty bench	3.2
- premature substitution	71.1
- puck on back of net	85.5
- puck out of bounds	85.1
- puck striking official	85.4

Rule Number

NHL Officiating Staff	iii
No icing	30.33, 81.5
No off-side	83.2
Non-playing Club personnel	
- abuse of officials	40.3, 40.5, 40.6, Table 12
- altercation with a spectator	32.9
- attempt to injure non-playing Club personnel	75.5, Table 12
- awarded goal	53.7, 56.7, Table 1
- banging boards with stick	40.3, Table 1
- deliberate injury of non-playing Club personnel.....	75.5, Table 12
- distracting player or goalkeeper during penalty shot	25.4
- fighting	47.8
- interference with opponent on breakaway	56.6, 56.7, , Table 1
- interference while play in progress	56.3, Table 1
- interfering with an official	40.3, Table 1
- obscene language or gestures.....	40.3, 75.3, Table 1, Table 12
- penalty shot.....	25.4, 53.6, Table 1
- physical abuse of an official	41, Table 1, Table 12
- refusing to start play.....	73.3, Table 1
- spectator – altercation with	32.9
- stepping onto the ice.....	70.5, Table 1
- supplementary discipline.....	29, 40.7
- throwing stick or any object onto ice	40.3, 53.3, Table 1
Non-uniformed players	5.1, 5.4
Number	5.1, 7.2, 9.2, 32.5, 34.5
Numerical advantage.....	80.4, 81.6

O

Objects thrown on ice	63.4
- public address.....	63.4
Obscene language or gestures.....	40, 75, Table 1, Table 12
Off the playing surface - fighting	47.8
Off-ice officials	
- action scorer	38.2
- appointment of	31
- commercial coordinator.....	4.1
- control of game officials	32
- game timekeeper	35
- goal judge	37
- leaving the penalty bench	70.4
- official scorer.....	34
- penalty scorer	38.2
- penalty timekeeper.....	36, 70.4
- puck supply	13
- real time scorers	38
- real time scoring manager	38.3
- shot scorer	38.2



	<u>Rule Number</u>
- spotter.....	38.2
- time on ice scorer – home.....	38.2
- time on ice scorer – visitor.....	38.2
- video goal judge.....	39
Off-ice officials report of game misconduct/match penalties.....	36.6
Official report of match.....	34.1
Official Scorer.....	34
- abuse of officials.....	40.4
- captain and alternate captains.....	6.1, 34.1
- eligible players.....	5.1, 34.1
- goalkeeper's penalties.....	36.3
- goals and assists.....	32.5, 34.1, 34.2, 35.7, 39.6, 78.1
- ineligible player.....	5.2
- non-uniformed player.....	5.4
- official report of match.....	34.1
- penalties.....	32.7, 34.5
- starting line-up.....	7.1, 34.3
Officials.....	6, Section 5, 31, 40, 41
- abuse.....	6.1, 22.4, 23.4, 23.7, 32.9, 33.4, 40 , Table 9
- appointment.....	31
- linesmen.....	33.4
- physical abuse.....	33.4, 41
- referees.....	32.9
Officiating Staff.....	iii
Off-side.....	83
- delayed.....	56.2, 83.3
- delaying the game.....	63.7
- deflections.....	83.2
- face-off – players in an off-side position.....	76.6
- forced off-side.....	56.2
- intentional.....	76, 83
- linesmen.....	33.5
- puck striking official.....	85.4
- rebounds.....	83.2
- referee.....	32.4
- signal.....	30.7
- unnecessary contact.....	42.1
Original altercation – fighting after the.....	47.7
Other fouls.....	Section 9
Other than during the periods of the game - fighting.....	47.9
Out of bounds.....	85.1
Out of sight.....	85.3
Outer knee strap pad.....	11.2
Overtime.....	84
- deliberate illegal substitution.....	74.4
- displacing the goal.....	63.5
- extra attacker – regular season.....	84.2
- line changes.....	82.2

Rule Number

- face-offs – five second time limit.....	76.3
- game timekeeper	35.3
- instigator	47.12
- penalties – major and minor (or double minor)	19.4, Table 17
- period length	35.3
- playoffs.....	84.5
- regular season	84.1
- regular season – penalties.....	84.3, Table 19, Table 20
- rest period	35.3
- shootout	84.4
- start of periods	86.8
- stick measurements	10.5, 10.7

P

Pad risers.....	11.2
Pads	
- arm.....	11.3
- chest	11.3
- elbow.....	9.5, 12.3
Paint code.....	1.5, 1.7, 1.8
Palm removed or cut.....	12.2
Pants.....	9.1, 11.4, 47.13
Participating beyond the center red line	28.7, Table 2, Table 15
Participating in play with two sticks.....	10.5
Participating in play without helmet	9.5
Pegs.....	2.1, 63.6, 78.5
Penalties	
- assessed in overtime – regular season	Table 20
- calling of.....	15, Table 1
- coincidental (see Coincidental penalties)	
- in effect prior to the start of overtime – regular season	Table 19
- major and minor (or double minor).....	19.4, Table 17
- public address.....	32.7, 36.1
Penalty – delayed	19.1, 27, 30.8, 84.2, Table 16
Penalty bench	3.2
- articles thrown on ice – linesman reporting	33.4, 53.3, 75.2, 75.3, Table 1, Table 3
- commercial time-out light.....	4.1
- failure to proceed directly.....	47.19
- goalkeeper's penalties	28, Table 15
- injured player – penalty.....	8.1
- interference from bench	56.3, Table 3
- helmet	9.5
- illegal stick.....	10.5
- illegal substitution.....	68, Table 3
- leaving before time expires	36.1
- leaving the bench.....	70.4, Table 1, Table 3, Table 12, Table 14

**Rule Number**

- light – commercial time-out.....	4.1
- linesman reporting – articles thrown on ice	33.4, 53.3, 75.2, 75.3, Table 1, Table 3
- major penalty – substitute.....	20.3
- proceed directly – failure to	47.19
- protective glass.....	1.3, 3.2
- puck supply.....	13.2
- stick – illegal	10.5
- stick – thrown.....	10.3, 53.3, 75.3
- substitute for major penalty	20.3
- substitution – illegal	68 , Table 3
- supply of pucks.....	13.2
- thrown stick.....	10.3, 53.3, 75.3
- time-out light	4.1
- too many men on the ice	74.3
Penalty expiration.....	16.2, 27.2, 36.1, Table 16
Penalty record form	36.6
Penalty scorer	38.2
Penalty shot.....	25 , Table 9, Table 13
- awarded goal during penalty shot.....	26.4
- cradling the puck (like lacrosse)	25.2, 80.1
- delay of game – displacing goal post	63.5
- delay of game – falling on puck in crease	63.5, 67.4
- delayed calling of a penalty shot and goal scored.....	15.4
- deliberate illegal substitution	68.6, 74.4
- designated player	25.3
- distraction during	25.4
- fouled from behind.....	54.3, 55.5, 57.3, 61.6
- goalkeeper deliberately removing face mask	9.5
- goal scored – short-handed.....	16.2
- handling puck	67.4
- holding	54.3
- hooking	55.5
- interference.....	56.6, Table 1
- interference – illegally entered the game.....	68.3, 70.7
- injury to designated player.....	25.3
- lacrosse-like move	25.2, 80.1
- linesman authority – throwing equipment.....	33.5
- penalty timekeeper	36.4
- procedure	25.2
- public address	25.2
- shootout.....	84.4
- short-handed – goal scored on penalty shot	16.2
- signal	30.24
- slashing	61.6
- spin-o-rama move.....	25.2
- stick measurement prior to penalty shot.....	10.6
- third goalkeeper – no warm-up prior to penalty shot.....	5.3

Rule Number

- throwing equipment.....	33.4, 53.3, 53.7, 56.6, Table 1
- throwing stick	53.3, 53.7, 56.6, Table 1
- time-outs	87.1
- timing	25.7
- tripping	57.3
- violations during the shot	25.4
Penalty time clock.....	4.2, 36.5
- coincidental penalties.....	19.1, Table 17
- double-minor penalties.....	18.2
- game timekeeper	35.7
- official scorer	34.2
- penalty timekeeper.....	36.1, 36.5
- timing device	4.2
- verification of time	34.2, 35.7, 36.8, 39.6, 76.8, 85.7
Penalty timekeeper.....	36
- disallowed goal	68.5
- goalkeeper's penalties	36.3
- illegal substitution.....	68.5
- interfering with penalty timekeeper	40.3, 40.4
- leaving penalty bench early	36.1, 68.5, 70.4
- major and minor penalty assessed to same team	27.3
- penalty bench.....	3.2
- penalty expiration.....	27.2, 36.1, 36.5
- penalty shot.....	36.4
- penalty time clock	36.5
- referee's crease	1.7
- reports	36.6
- stick gauge.....	36.2
- stick measurement result	10.5, 36.7
- team's choice – penalty expiration.....	16.2, 27.2
- verification of time	34.2, 35.7, 36.8, 76.8, 85.7
Period – end of	86.5, Table 3
Period length.....	35.1, 77.1, 84.1
Permitted to occupy players' bench.....	5.4
Physical abuse of officials.....	33.4, 41, Table 1, Table 12
Physical fouls.....	Section 6
Picking up puck in crease	67.4, 67.5, Table 13
Piling snow or other objects.....	67.5
Play was stopped.....	32.2, 78.5, 83.4
Player	
- eligible.....	5.1, 10.7, 34.1, 84.4
- ineligible	5.2, 10.7, 33.5, 74.5, 78.5, 84.4
- injured	8, 9.6, 68.2, 70.5, 76.2, 81.4, 82.1
- losing helmet.....	9.5
- substitution.....	68.1, 71.1, 74, 81.4, 82.1
- uniform	9.1, 32.8
Player's jersey	9.3
Players' bench	3.1

**Rule Number**

- articles thrown on ice – linesman reporting	33.4, 53.3, 75.2, 75.3, Table 1, Table 3
- attacking zone – extending into	83.3
- broken stick	10.3
- choice of ends	86.3
- clearing area of fight	47.4
- coaches and team personnel	5.4
- dimensions	3.1
- end of periods	86.5, Table 3
- extending into attacking zone	83.3
- fight – clearing area	47.4
- helmet	9.5
- illegal substitution	68.1, Table 3
- injured player leaving ice	8.1
- interference from bench	56.2, Table 3
- leaving the bench	70.3, Table 1, Table 3, Table 14
- leaving to protest	6.1, 40.2, Table 9
- linesman reporting – articles thrown on ice	33.4, 53.3, 75.2, 75.3, Table 1, Table 3
- measurement – stick	10.5
- non-uniformed players	5.4
- penalty shot	25.2
- permitted to occupy	5.4
- premature substitution	71.1
- protective glass	3.1
- puck striking glove	85.1
- receiving stick	10.3
- replacement stick	10.4
- start of game	86.3
- start of periods	86.2, 86.8
- stick – broken	10.3
- stick – measurement	10.5
- stick – receiving	10.3
- stick – replacement	10.4
- stick – thrown	10.3, 10.4, 53.3, 75.3, Table 1, Table 3
- substitute goalkeeper	5.3, 71.1
- substitution – illegal	68, Table 3
- substitution – premature	71.1
- thrown stick	10.3, 10.4, 53.3, 75.3, Table 1, Table 3
- time-outs	87
- too many men on the ice	74
Player's stick	10.1
- face-off procedure	76.4
- face-off violation	76.6
- icing – determination	82.1
- icing – rebound	81.5
- prior to penalty shot	10.6, 25.4
Playing area	Section 1

	<u>Rule Number</u>
Playing puck in restricted area.....	28.8
Playing puck over center red line.....	28.7
Playing surface – fighting off the.....	47.8
Playoffs.....	84.5
Police protection.....	41.8
Possession of the puck.....	56.1
- awarded goals.....	26.1
- calling of penalties.....	15.1
- displacing goal post.....	63.2
- fouling from behind.....	25.8, 57.3
- goalkeeper losing helmet and/or mask.....	9.5
- goalkeeper – premature substitution.....	71.1
- high-sticking the puck.....	80.1
- holding.....	54.1
- icing.....	81.1
- interference.....	56.1
- leaving the bench.....	70.7
- leaving penalty bench early.....	70.4
- illegal puck.....	13.3
- illegal substitution.....	68.3, 70.7
- injured players.....	8.1
- off-side.....	83.1
- participating in play without helmet.....	9.5
- penalty shot.....	25.8, 57.3, 63.5, 68.3, 70.7
- premature substitution.....	71.1
Post-game – fighting.....	47.9
Post-game verbal abuse.....	23.7
Posts (see Goal posts)	
Power-play	
- high-sticking the puck.....	80.4
- icing.....	81.6
- numerical advantage.....	80.4, 81.6
- penalty expiration.....	27.2
Pre-game warm-up.....	86.6
Premature substitution (of goalkeeper).....	71
- face-off location.....	76.2
- linesman stopping play.....	33.5
- public address.....	71.2
- too many men on the ice.....	74.1
Pre-season games	
- goalkeeper warm-up.....	8.2
- supplemental discipline.....	29.2
Preventing opponent from retrieving equipment.....	56.2
Prior to drop of puck – fighting.....	47.10
Prior to game – fighting.....	47.9
Prior to period – fighting.....	47.9
Procedure – penalty shot.....	25.2
Proceed directly to penalty bench – failure to.....	47.19

**Rule Number**

Profane language or gestures	40, 75, Table 1, Table 12
Protection – face	47.6
Protective equipment.....	9.5, 11, 12.1, 65.2, Table 9
Protective glass	1.3, 3
Public address	
- assists.....	32.5, 34.2
- disallowed goals	32.5, 39.2, 78.5
- game timekeeper.....	35.1
- goal review	39.2
- goals	32.5, 34.2, 39.2
- official scorer	34.2
- objects thrown on ice.....	63.4
- one minute remaining	35.1
- penalties	32.7, 36.1
- penalty shot	25.2
- premature substitution	71.2
- video goal judge	39.2
Puck	13
- coming to rest on top of boards.....	85.1
- deflecting off official directly into goal.....	76.2
- dropped on goal netting.....	85.6
- frozen along the boards.....	15.5, 85.2, 85.5
- frozen by the goalkeeper	15.5
- illegal	13.3, 56.2
- on back of net.....	85.2, 85.5
- out of bounds.....	33.5, 85
- out of sight.....	85.3
- over glass	63.2
- striking glove.....	85.1
- striking official	81.1, 85.4
- supply	13.2
- through net	85.2
- under net	85.2
- unplayable	63.2, 85.2
Puck foils	11.2
Punch causing injury	47.15, 51.3, Table 8

R

Racial taunts or slurs.....	23.7
Raised seam ridges.....	11.2, 11.3, 11.6
Real time scorers	36.3, 38
Rebound in the crease	69.6
Rebound off post on penalty shot.....	25.2
Rebounds	
- icing	81.5
- in crease	69.6
- penalty shot	25.2

Rule Number

Receivable pass	81.5
Receiving stick	10.3, 10.4
Referee crease	1.7, 40.4, Table 9
Referees	32
- abuse of officials	40
- appointment of officials	31
- attire and equipment	32.1
- calling of penalties	15.1
- coincidental penalty rule	19.5
- disputes	32.2
- end of game and periods	32.10
- entering referee's crease	1.7, 40.4, Table 9
- equipment	32.1
- face-offs	32.3
- goal judge	37.1, 37.2
- goals	32.5
- leaving the penalty bench early	36.1, 70.4
- linesmen reporting to referee	33.4
- line-ups	34.3
- off-ice officials	32.6
- penalties	32.7, 36.1
- physical abuse of officials	41
- player or goalkeeper's uniform	9.1
- player's uniforms	9.1, 32.8
- reports	32.9
- signals	30
- start of game and periods	32.10, 35.5
- team uniform	9.1, 32.8
- unable to continue	32.11
- verification of time	35.7, 39.6
- video goal judge	39
Refusing to play the puck	72
- hand pass	72.2
- high stick	72.3
- icing	72.4
- penalty	72.5
Refusing to start play	73 , Table 1, Table 3
Refusing to surrender stick for measurement	10.5, Table 9
Remain in goal crease	47.4
Removing jersey	47.13, 75.2
Replacement stick	10.3, 10.4
Reporting to referee	33.4
Reports	
- abuse of officials – misconduct penalties	22.4, 32.9, 40.7
- altercation with a spectator	32.9
- event summary	38.3
- fighting off the playing surface	47.8
- fighting prior to the drop of the puck	47.10



	<u>Rule Number</u>
- game misconduct penalties	23.2, 32.9
- game summary	38.3
- goalkeeper leaving crease.....	32.9
- instigator penalties.....	32.9, 47.11, 47.12
- instigator, aggressor and game misconduct list	36.6
- leaving the bench	70.10
- match penalties	21.3, 32.9
- misconduct penalties – abuse of officials	22.4, 32.9, 40.7
- off-ice officials report of game misconduct/match penalties.....	36.6
- penalty record form.....	36.1
- penalty timekeeper	36.6
- real time scorers	38.3
- spectator – altercation with.....	32.9
- thrown stick or object outside playing area	32.9
- unusual occurrence	32.9
- video goal judge	39.3
Request for review / rescind – game misconduct	23.2
Requesting stick measurement.....	10.5
Rescind – game misconduct	23.2
Resisting a linesman	47.5, Table 10
Rest period	35.3
Restraining fouls.....	Section 7
Restraining lines (hash marks).....	1.9, 76.5
Restricted area	1.8, 28.8, Table 15
Retrieving equipment after a fight	47.19
Rink	1, 3, 4, 85.1, 86.1
Rink Dimensions	1
Roughing	30.25, 51, Table 2
- fines	51.4
- match penalty	51.3
- minor penalty.....	51.2
- suspensions.....	51.4

S

Safety glass	1.3
Scorer (see Official Scorer)	
Scoring a goal	78.4
Second fight same stoppage.....	47.7
Second instigator in a game.....	47.11
Security	11.8, 12.5, 41.8
Serious injury.....	8, 33.5, 40.2, 40.3
Shooting equipment	53.2, 53.6, 53.7
Shooting puck over glass	63.2
Shootout.....	10.7, 78.1, 84.4
- cradling the puck (like lacrosse)	80.1
- eligibility	84.4
- goalkeeper deliberately removing face mask.....	9.5

Rule Number

- stick measurement.....	10.7
Short-handed	
- bench minor penalties.....	17.2
- calling a penalty – goal scored.....	15.2
- coincidental penalties.....	19, Table 17
- double-minor penalties.....	18.2
- goal scored on penalty shot.....	16.2
- high-sticking the puck.....	80.4
- icing.....	81.6
- intentional off-side.....	83.6
- major penalties.....	20.2
- match penalties.....	21.2
- minor penalties.....	16.2, Table 16
- misconduct penalties.....	22.3
- off-side – intentional.....	83.6
- puck striking official.....	85.4
Shot scorer.....	38.2
Shoulder cap protectors.....	11.3
Shoulder clavicle protectors.....	11.3
Signal device.....	4.1, 35.4
Signals.....	30
Siren.....	4.1
Situations subject to video review.....	39.4
Slashing.....	61, Table 2, Table 5, Table 6, Table 8, Table 11
- awarded goal.....	61.7
- fines.....	61.8
- game misconduct penalty.....	61.5
- major penalty.....	61.3
- match penalty.....	61.4
- minor penalty.....	61.2
- penalty shot.....	61.6
- signal.....	30.26
- suspensions.....	61.8
Slew-footing.....	52, Table 8
- fines.....	52.3
- match penalty.....	52.2
- suspensions.....	52.3
Sliding stick.....	10.4
Slow proceeding to face-off location.....	76.6
Spearing.....	62, Table 4, Table 5, Table 6, Table 8, Table 11
- double-minor penalty.....	15.3, 62.2
- fines.....	62.6
- game misconduct penalty.....	62.5
- major penalty.....	62.3
- match penalty.....	62.4
- signal.....	30.27
- suspensions.....	62.6
Spectator – altercation with.....	23.7, 32.9, 33.5, 53.4



	<u>Rule Number</u>
Spectator netting	1.4, 85.1
Spin-o-rama move	25.2
Spitting	23.7, 41.3, 41.4
Spots – face-off (see Face-off)	
Spotter	38.2
Start of game	86
Start of game – fighting	47.9
Start of period	35.5, 77.1, 86
Starting line-up	7 , 34.1, 34.3, 86.2, 86.8
Stepping onto the ice	70.5, Table 1
Stick	10
- blade width	10.1
- broken	10.3, 10.4, 56.2, Table 2
- curvature	10.1, 10.5
- fouls	Section 8
- gauge	32.1, 33.1, 36.2
- goalkeeper	10.2, 11.1, 49.2
- illegal	10.5
- infractions	23.5, Section 8
- length	10.1
- length exception	10.1
- measurement	10.5, 36.7, 84.4
- measurement prior to penalty shot	10.6
- measurement prior to shootout attempt	10.7, 84.4
- measurement result	10.5, 36.7
- modified	9.6
- player	10.1
- receiving	10.3, 10.4
- replacement	10.3, 10.4
- sliding	10.4
- thrown	10.3, 10.4, 53.2, 53.6, 53.7
.....	75.2, 75.3, 75.4, Table 1, Table 3
Stick infractions, boarding and checking from behind category	23.5
Stopping play	33.5, 63.2, 63.4, 67.1, Table 15
Stopping play for injury	8.1
Striking an official	41
Striking official – puck	78.5, 81.1, 85.4
Substitute goalkeeper	5.3, 71
Substitution	
- bench minor penalties	17.1
- coincidental penalties	19
- delaying the game	63.3
- deliberate illegal	68.6, 74.4, Table 3, Table 13
- face-offs	76.7
- goalkeeper	8.2, 25.2, 34.1, 63.3
- illegal	20.3, 68 , 74.4, Table 3, Table 13
- injured goalkeeper	8.2
- injured player	8.1

Rule Number

- leaving the bench	70.1
- line change	82.1
- line change on icing	81.4, 82.1
- major penalties	20.3
- premature	33.5, 71, 74.1, 76.2
Summary of awarded goals	Table 14
Summary of bench minor penalties	Table 3
Summary of double minor penalties	Table 4
Summary of game misconduct fouls - "general category"	Table 10
Summary of game misconduct fouls - "stick-related category"	Table 11
Summary of game misconduct penalties	Table 12
Summary of goalkeeper penalties	Table 15
Summary of major penalties	Table 5
Summary of major penalties that result in automatic game misconduct ...	Table 6
Summary of major penalties that result in automatic game misconduct when there is injury to face or head	Table 7
Summary of match penalties	Table 8
Summary of minor penalties	Table 2
Summary of misconduct penalties	Table 9
Summary of penalties to coaches and non-playing club personnel	Table 1
Summary of penalty shots	Table 13
Supplementary discipline (see Discipline – supplementary)	
Supply of pucks	13.2
Suspensions	
- automatic	23.2, 23.3, 23.4, 23.5, 36.6, 41
.....	42.6, 44.6, 47.9, 47.20, 47.22
- abuse of officials category	23.4
- aggressor	47.17
- boarding	23.5, 42.6
- butt-ending	58.6
- charging	43.6
- checking from behind	23.5, 44.6
- clearing the area of a fight	47.18
- clipping	45.6
- cross-checking	59.6
- diving	64.3
- elbowing	46.6
- embellishment	64.3
- failure to proceed directly to penalty bench	47.19
- fighting other than during the periods of the game	47.20
- game misconduct penalties	23.3, 23.4, 23.5
- general category	23.3
- general category – playoffs	23.3
- goalkeeper's equipment	11.8
- head-butting	48.6
- high-sticking	60.6
- hooking	55.6
- instigator	47.21



	<u>Rule Number</u>
- instigator in final five minutes	47.22
- interference on the goalkeeper	69.7
- kicking	49.4
- kneeling	50.6
- leaving the bench	70.10
- playoffs – general category	23.3
- playoffs – stick infractions, boarding, checking from behind category	23.5
- roughing	51.4
- slashing	61.7
- slew-footing	52.3
- spearing	62.6
- stick infractions, boarding, checking from behind category	23.5
- stick infractions, boarding, checking from behind category - playoffs	23.5
- stick measurements	10.5
- supplementary discipline	29
- throwing equipment	53.8
Sweater (jersey)	9, 47.13, 75.2, Table 10
- goalkeeper	9.4
- player	9.3

T

Tag up	83.3
Tape measure	10.5, 11.5, 32.1, 33.1, 36.2
Tape on hands	47.15, Table 8
Tape on stick	10.1
Team	Section 2
Team personnel	5.4, 33.4, 75.3, 75.5, 75.6
Team uniform	9.1, 32.8
Team's choice – penalty expiration	16.2, 27.2
Television	34.1, 35.6, 47.20, 70.10
Thigh pads	11.4
Third goalkeeper – no warm-up prior to penalty shot	5.3
Third instigator in season	47.11, 47.21
Third major penalty in a game	20.4
Third man in	47.16, Table 12
Threaten to injure an official	41.4
Throwing equipment	33.5, 53, 56.6, Table 1, Table 8, Table 13
- at an official	41.4
- awarded goal	53.7
- bench minor penalty	53.3
- fines	53.8
- game misconduct penalty	53.4
- match penalty	53.5
- minor penalty	53.2
- misconduct penalty	53.4

	<u>Rule Number</u>
- out of playing area	40.4, 75.4
- penalty shot.....	53.6
- stick.....	10.3, 10.4, 53, 75.1, 75.2, 75.4, Table 1, Table 3
- suspensions.....	53.8
Throwing objects.....	40.3, 53, 75.1, 75.2, 75.4, Table 1, Table 12
- at spectator	23.7
- objects onto the ice	53, 75.1, 75.2
- objects outside playing surface.....	32, 75.4
Tie down (jersey)	47.13, Table 10
Tied games (see Overtime)	
Time clock.....	4.2, 35.1, 36.1
Timekeeper (see Game timekeeper)	
Time on ice – home	38.2
Time on ice – visitor	38.2
Time-out.....	4.1, 30.29, 34.1, 87
Timing device.....	4, 35.1, 36.1, 39.6
Too many men on the ice	71.1, 74 , Table 3
- bench minor penalty.....	74.2
- deliberate illegal substitution.....	74.4
- goalkeeper	74.5
- illegal substitution.....	68, Table 3
- leaving the bench.....	70
- line change procedure	82.2
- linesmen reporting to referee.....	33.4
- no icing.....	81.5
- overtime – regular season	74.5
- penalty bench.....	74.3
- premature substitution	71
Torso.....	47.13
Trapezoid.....	1.8
Tripping.....	57 , 61.6, Table 2, Table 14
- awarded goal	54.4, 55.6, 57.4 , 61.7
- minor penalty	57.2
- penalty shot.....	53.6, 54.3, 55.5, 57.3 , 61.6
- signal.....	30.31
Two players penalties expire at the same time – team choice.....	16.2
Two sticks – participating in the play with.....	10.5
Types of penalties.....	Section 4

U

Unable to continue – referee, linesman.....	32.11, 33.6
Uniform	5.1, 6, 8.3, 9 , 12.1, 32.8, 65.1
Unique to goalkeepers – penalties	28.9, Table 15
Unnecessary stoppage of play	67.3
Unsportsmanlike conduct	40, 75 , Table 2, Table 3, Table 12
- abuse of officials	40
- banging boards with stick.....	40.2



	<u>Rule Number</u>
- banging glass in protest of ruling.....	40.2
- bench minor penalty	40.3, 75.3
- biting	75.2
- captain or alternate captain coming off bench to protest.....	6.1
- face protection – instigator	47.6, 75.2
- game misconduct penalty.....	40.5, 75.5
- grabbing face mask	75.2
- hair pulling	75.2
- instigator wearing a face shield	47.6, 75.2
- jersey – removing	47.13, 75.2
- linesmen reporting to referee.....	33.4
- minor penalty	40.2, 75.2
- misconduct penalty.....	40.4, 75.4
- obscene, profane or abusive language or gestures	40, 75
- removing jersey	47.13, 75.2
- reports	40.7, 75.7
- signal	30.32
- throwing objects onto the ice.....	53.3, 75.2, 75.3
- throwing objects outside playing surface.....	40.4, 75.4
- wearing a face shield – instigator	47.6, 75.2
Unsustained complaint regarding legality of a glove.....	12.2
Unsustained request for measurement.....	10.5, 12.2, Table 3
Unusual occurrence	32.9

V

Verification of time.....	32.2, 34.2, 35.7, 36.8, 39.6, 76.8, 85.7
Video Goal Judge.....	39 , 78.6
- appointment of officials.....	31
- equipment.....	39.5
- goals	32.5, 34.2, 39.2, 78.6
- logistics.....	39.5
- public address	39.2
- reports	39.3
- situations subject to video review.....	39.4
- verification of time.....	32.2, 35.7, 36.8, 39.6, 76.8, 85.7
- video review.....	39, 78.6
Video review.....	36.8, 39, 78.6
Violations during penalty shot	25.4
Violation – starting line-up.....	7.2

W

Wall (see Boards)	
Warm-up.....	5.3, 8.2, 34.3, 86.6, 87
- during stoppages of play	70.3
- during time-out.....	87

Rule Number

- for substitute goalkeeper.....	8.2
Warning – line change	76.6, 82.2
Wash out	30.33
Wearing a face shield – instigator.....	47.6, 75.2
Wearing tape on hands.....	47.15, Table 8
When replacement player does not return to ice from penalty bench	68.1
When replacement player not placed on penalty bench – no icing	81.6
Whistle had blown.....	32.2, 78.5, 83.4

Z

Zone

- attacking (see Attacking zone)
- defending (see Defending zone)
- neutral (see Neutral zone)



NHL Schedule, 2007-08

GAME #	VISITOR	HOME	GAME #	VISITOR	HOME	GAME #	VISITOR	HOME	GAME #	VISITOR	HOME
SAT. SEPT. 29			WED. OCT. 10			THU. OCT. 18			FRI. OCT. 26		
1	•ANA	L.A.*	48	NSH	ST.L.	96	EDM	PHX	144	COL	CGY
SUN. SEPT. 30			49	L.A.	DAL	97	DET	S.J.	SAT. OCT. 27		
2	•L.A.	ANA*	WED. OCT. 10			FRI. OCT. 19			145	•S.J.	CBJ
<i>* in London, England</i>			50	PHI	VAN	98	CBJ	BUF	146	PHI	BOS
WED. OCT. 3			51	BOS	ANA	99	CAR	PIT	147	OTT	N.J.
3	MTL	CAR	THU. OCT. 11			FRI. OCT. 19			148	CAR	NYI
4	ANA	DET	52	ATL	BUF	100	COL	CHI	149	TOR	NYR
5	OTT	TOR	53	NYI	TOR	101	L.A.	VAN	150	MTL	PIT
6	DAL	COL	54	CAR	OTT	SAT. OCT. 20			SAT. OCT. 27		
THU. OCT. 4			55	N.J.	FLA	102	NYR	BOS	151	BUF	T.B.
7	FLA	NYR	56	PHX	NSH	103	CHI	TOR	152	FLA	NSH
8	TOR	OTT	FRI. OCT. 12			104	BUF	MTL	153	ATL	CHI
9	N.J.	T.B.	57	WSH	NYR	105	FLA	OTT	154	WSH	ST.L.
10	COL	NSH	58	CHI	DET	106	N.J.	NYI	155	DAL	PHX
11	CHI	MIN	59	COL	ST.L.	107	CAR	PHI	156	EDM	L.A.
12	PHI	CGY	60	CGY	DAL	108	PIT	WSH	SUN. OCT. 28		
13	S.J.	EDM	61	VAN	EDM	109	ATL	T.B.	157	MIN	COL
14	ST.L.	PHX	62	BOS	L.A.	110	ANA	DAL	158	•EDM	ANA
FRI. OCT. 5			SAT. OCT. 13			111	MIN	ST.L.	159	DET	VAN
15	PIT	CAR	63	WSH	BUF	112	EDM	CGY	MON. OCT. 29		
16	ANA	CBJ	64	PIT	TOR	113	DET	PHX	160	T.B.	NYR
17	NYI	BUF	65	CAR	MTL	114	NSH	S.J.	161	WSH	TOR
18	WSH	ATL	66	OTT	NYR	SUN. OCT. 21			162	S.J.	DAL
19	BOS	DAL	67	NYI	PHI	115	•VAN	CBJ	TUE. OCT. 30		
20	S.J.	VAN	68	N.J.	ATL	116	•COL	MIN	163	PIT	MIN
SAT. OCT. 6			69	T.B.	FLA	MON. OCT. 22			164	ATL	MTL
21	•PHI	EDM	70	CGY	NSH	117	VAN	CAR	165	PHX	ST.L.
22	MTL	TOR	71	DAL	CHI	118	BOS	MTL	166	NSH	CGY
23	NYR	OTT	72	CBJ	COL	119	S.J.	CGY	167	DET	EDM
24	BUF	NYI	73	EDM	VAN	TUE. OCT. 23			WED. OCT. 31		
25	CAR	WSH	74	MIN	PHX	120	NYR	PIT	168	T.B.	N.J.
26	N.J.	FLA	75	BOS	S.J.	121	ATL	TOR	169	CAR	FLA
27	ANA	PIT	SUN. OCT. 14			122	CBJ	CHI	170	CHI	DAL
28	ATL	T.B.	76	•MIN	ANA	123	ANA	ST.L.	171	CBJ	L.A.
29	DAL	NSH	77	•DET	L.A.	124	COL	EDM	THU. NOV. 1		
30	CBJ	MIN	MON. OCT. 15			125	NSH	L.A.	172	BUF	BOS
31	DET	CHI	78	TOR	BUF	WED. OCT. 24			173	T.B.	NYI
32	VAN	CGY	79	S.J.	VAN	126	T.B.	WSH	174	WSH	NYR
33	BOS	PHX	80	DET	ANA	127	BUF	CAR	175	PHI	MTL
34	ST.L.	L.A.	TUE. OCT. 16			128	PHI	FLA	176	ATL	OTT
SUN. OCT. 7			81	ATL	PHI	129	VAN	DET	177	ST.L.	MIN
35	S.J.	COL	82	FLA	MTL	130	MIN	CGY	178	PIT	COL
MON. OCT. 8			83	CGY	COL	THU. OCT. 25			179	DET	CGY
36	•WSH	NYI	84	MIN	L.A.	131	CHI	BOS	180	NSH	VAN
37	•N.J.	OTT	WED. OCT. 17			132	N.J.	NYR	181	CBJ	ANA
38	EDM	DET	85	DAL	CBJ	133	ST.L.	CBJ	FRI. NOV. 2		
TUE. OCT. 9			86	N.J.	PIT	134	TOR	PIT	182	TOR	N.J.
39	CAR	TOR	87	ST.L.	CHI	135	PHI	T.B.	183	PHI	WSH
WED. OCT. 10			88	NSH	ANA	136	ATL	NSH	184	FLA	BUF
40	NYR	NYI	THU. OCT. 18			137	MIN	EDM	185	PHX	DAL
41	OTT	ATL	89	T.B.	BOS	138	PHX	ANA	186	NSH	EDM
42	PHX	CBJ	90	N.J.	PHI	139	DAL	L.A.	187	L.A.	S.J.
43	MTL	PIT	91	NYI	WSH	FRI. OCT. 26			SAT. NOV. 3		
44	FLA	T.B.	92	NYR	ATL	140	VAN	WSH	188	TOR	MTL
45	CGY	DET	93	FLA	TOR	141	MTL	CAR	189	BOS	OTT
46	EDM	MIN	94	MTL	OTT	142	BUF	FLA	190	PIT	NYI
47	S.J.	CHI	95	L.A.	CGY	143	S.J.	DET	191	N.J.	NYR

Copyright © 2007 by the National Hockey League. All rights reserved. Reproduction in whole or in part without permission of the National Hockey League is strictly prohibited. Publication of this schedule is permitted for the sole purpose of informing members of the public who wish to attend or view on television National Hockey League games. Any other publication or other use of any portion of this schedule, including for the purpose of lottery or other form of gambling, whether such gambling is legal or illegal is strictly prohibited.

SUBJECT TO CHANGE

• AFTERNOON GAME



NHL SCHEDULE 2007-08



GAME # VISITOR HOME

SAT. NOV. 3

192 FLA CAR
193 ATL T.B.
194 CGY MIN
195 CHI ST.L.
196 ANA PHX
197 VAN COL
198 S.J. L.A.

SUN. NOV. 4

199 •ST.L. CBJ
200 OTT BOS
201 NSH CHI

MON. NOV. 5

202 PIT N.J.
203 PHI NYR
204 WSH CAR
205 BUF MTL
206 T.B. FLA
207 EDM MIN
208 CGY COL
209 DAL ANA

TUE. NOV. 6

210 NYR NYI
211 WSH ATL
212 TOR OTT

WED. NOV. 7

213 BOS BUF
214 PHI PIT
215 FLA T.B.
216 NSH DET
217 CBJ CHI
218 EDM COL
219 PHX ANA
220 DAL S.J.

THU. NOV. 8

221 MTL BOS
222 PHI N.J.
223 PIT NYR
224 T.B. CAR
225 WSH OTT
226 VAN CGY
227 DAL PHX

FRI. NOV. 9

228 TOR BUF
229 ATL FLA
230 CBJ DET
231 ST.L. CHI
232 COL VAN
233 S.J. ANA

SAT. NOV. 10

234 •MTL OTT
235 BUF BOS
236 NYR TOR[§]
§ Hall of Fame Game
237 N.J. NYI
238 PIT PHI
239 T.B. WSH
240 CAR ATL
241 CBJ NSH
242 EDM CGY
243 DAL L.A.
244 PHX S.J.

SUN. NOV. 11

245 DET CHI
246 MIN COL

GAME # VISITOR HOME

MON. NOV. 12

247 NYI PHI
248 NSH CBJ
249 N.J. PIT
250 CAR FLA
251 PHX S.J.

TUE. NOV. 13

252 FLA ATL
253 DET ST.L.
254 MTL TOR
255 MIN CGY
256 L.A. ANA

WED. NOV. 14

257 NYR N.J.
258 CHI CBJ
259 CAR T.B.
260 S.J. DAL
261 EDM VAN

THU. NOV. 15

262 TOR BOS
263 NYR PHI
264 BUF OTT
265 NYI PIT
266 WSH FLA
267 CHI NSH
268 MIN EDM
269 S.J. PHX
270 ANA L.A.

FRI. NOV. 16

271 NYI N.J.
272 ATL CAR
273 MTL BUF
274 WSH T.B.
275 CBJ ST.L.
276 COL DAL
277 MIN VAN

SAT. NOV. 17

278 •PHX L.A.
279 OTT TOR
280 BOS MTL
281 N.J. PHI
282 FLA CAR
283 CHI DET
284 NYR PIT
285 ST.L. NSH
286 CGY EDM
287 ANA S.J.

SUN. NOV. 18

288 •DET CBJ
289 •COL MIN
290 •CGY VAN

MON. NOV. 19

291 NYI NYR
292 FLA WSH
293 T.B. ATL
294 OTT MTL
295 NSH ST.L.
296 L.A. DAL

TUE. NOV. 20

297 BOS TOR
298 COL CGY
299 VAN EDM

WED. NOV. 21

300 OTT BUF
301 MTL NYI
302 ATL WSH
303 PHI CAR

GAME # VISITOR HOME

WED. NOV. 21

304 FLA CBJ
305 N.J. PIT
306 NYR T.B.
307 ST.L. DET
308 VAN MIN
309 ANA DAL
310 L.A. PHX

THU. NOV. 22

311 PIT OTT
312 DET NSH
313 CHI CGY
314 COL EDM

FRI. NOV. 23

315 NYI BOS
316 •WSH PHI
317 •CBJ MIN
318 •PHX ANA
319 T.B. CAR
320 MTL BUF
321 N.J. ATL
322 NYR FLA
323 VAN ST.L.
324 TOR DAL

SAT. NOV. 24

325 BUF MTL
326 PHI OTT
327 BOS NYI
328 CAR WSH
329 DET CBJ
330 •TOR PHX
331 ATL PIT
332 N.J. T.B.
333 MIN NSH
334 CGY COL
335 CHI EDM
336 L.A. S.J.

SUN. NOV. 25

337 •DAL NYR
338 •CGY ST.L.
339 •L.A. ANA
340 CHI VAN

MON. NOV. 26

341 DAL NYI
342 BOS PHI
343 BUF WSH
344 CBJ EDM

TUE. NOV. 27

345 CGY DET
346 MTL TOR
347 ANA VAN

WED. NOV. 28

348 ST.L. BUF
349 DAL N.J.
350 OTT NYI
351 FLA WSH
352 PHI CAR
353 PHX MIN
354 T.B. CHI
355 EDM COL
356 L.A. S.J.

THU. NOV. 29

357 NYI NYR
358 TOR ATL
359 NSH OTT
360 BOS FLA
361 T.B. DET

GAME # VISITOR HOME

THU. NOV. 29

362 ANA CGY
363 CBJ VAN

FRI. NOV. 30

364 MTL N.J.
365 WSH CAR
366 DAL PIT
367 ST.L. MIN
368 PHX CHI
369 ANA EDM
370 COL S.J.

SAT. DEC. 1

371 •NYR OTT
372 CAR BUF
373 PIT TOR
374 NSH MTL
375 ATL NYI
376 DAL PHI
377 WSH FLA
378 PHX DET
379 BOS T.B.
380 CHI ST.L.
381 CBJ CGY
382 COL L.A.

SUN. DEC. 2

383 •ATL N.J.
384 •VAN MIN
385 •EDM ANA

MON. DEC. 3

386 BOS NYI
387 CAR NYR
388 DAL CBJ
389 PHX PIT
390 S.J. COL
391 EDM L.A.

TUE. DEC. 4

392 DET MTL
393 NSH TOR
394 OTT T.B.
395 ST.L. CGY

WED. DEC. 5

396 BOS N.J.
397 NYI ATL
398 COL CBJ
399 OTT FLA
400 PHI MIN
401 VAN CHI
402 S.J. DAL
403 PIT EDM
404 L.A. PHX
405 BUF ANA

THU. DEC. 6

406 MTL BOS
407 TOR NYR
408 CAR T.B.
409 VAN NSH
410 PIT CGY
411 BUF L.A.

FRI. DEC. 7

412 WSH N.J.
413 NYR ATL
414 NYI FLA
415 MIN DET
416 ANA CHI
417 OTT DAL
418 PHI COL
419 ST.L. EDM
420 S.J. PHX

•AFTERNOON GAME



NHL SCHEDULE 2007-08



GAME #	VISITOR	HOME
SAT. DEC. 8		
421	BOS	TOR
422	CAR	MTL
423	ATL	WSH
424	MIN	CBJ
425	NYI	T.B.
426	ANA	NSH
427	PIT	VAN
428	PHX	L.A.
429	BUF	S.J.
SUN. DEC. 9		
430	•N.J.	NYR
431	•CAR	DET
432	CGY	CHI
433	ST.L.	COL
MON. DEC. 10		
434	BOS	BUF
435	N.J.	WSH
436	ANA	CBJ
437	T.B.	TOR
438	DET	NSH
439	EDM	DAL
440	VAN	L.A.
TUE. DEC. 11		
441	PIT	PHI
442	T.B.	MTL
443	CGY	FLA
444	EDM	ST.L.
445	MIN	S.J.
WED. DEC. 12		
446	NYI	BUF
447	NYR	WSH
448	OTT	CAR
449	BOS	ATL
450	COL	CBJ
451	L.A.	CHI
452	VAN	ANA
THU. DEC. 13		
453	N.J.	BOS
454	PHX	NYI
455	MTL	PHI
456	OTT	PIT
457	CGY	T.B.
458	EDM	DET
459	COL	NSH
460	FLA	ST.L.
461	L.A.	DAL
462	VAN	S.J.
FRI. DEC. 14		
463	BUF	WSH
464	CGY	CAR
465	TOR	ATL
466	MIN	ANA
SAT. DEC. 15		
467	•PHX	N.J.
468	CBJ	BOS
469	CHI	BUF
470	TOR	MTL
471	ATL	OTT
472	PIT	NYI
473	CAR	PHI
474	FLA	DET
475	WSH	T.B.
476	NSH	COL
477	VAN	EDM
478	MIN	L.A.
479	•DAL	S.J.

GAME #	VISITOR	HOME
SUN. DEC. 16		
480	•PHI	N.J.
481	•PHX	NYR
482	•CGY	ST.L.
483	FLA	CHI
484	•S.J.	ANA
MON. DEC. 17		
485	WSH	DET
486	COL	L.A.
TUE. DEC. 18		
487	OTT	BOS
488	PIT	NYR
489	PHX	PHI
490	TOR	CAR
491	T.B.	ATL
492	CGY	CBJ
493	FLA	MTL
494	NSH	MIN
495	DAL	EDM
496	N.J.	VAN
497	ANA	S.J.
WED. DEC. 19		
498	BUF	NYI
499	L.A.	DET
500	NSH	CHI
501	COL	ANA
THU. DEC. 20		
502	PIT	BOS
503	MTL	WSH
504	OTT	ATL
505	TOR	T.B.
506	CAR	FLA
507	NYR	MIN
508	DET	ST.L.
509	DAL	VAN
510	PHX	S.J.
FRI. DEC. 21		
511	L.A.	CBJ
512	PHI	BUF
513	NYI	PIT
514	NYR	COL
515	DAL	CGY
516	N.J.	EDM
SAT. DEC. 22		
517	•ST.L.	BOS
518	CHI	OTT
519	WSH	NYI
520	BUF	PHI
521	MTL	ATL
522	TOR	FLA
523	CAR	T.B.
524	L.A.	NSH
525	DET	MIN
526	VAN	PHX
527	ANA	S.J.
SUN. DEC. 23		
528	•BOS	PIT
529	•NSH	CBJ
530	•ATL	ST.L.
531	OTT	NYR
532	EDM	CHI
533	VAN	COL
534	N.J.	CGY
535	MTL	DAL
WED. DEC. 26		
536	OTT	BUF
537	TOR	NYI

GAME #	VISITOR	HOME
WED. DEC. 26		
538	CAR	NYR
539	T.B.	WSH
540	ATL	CBJ
541	NSH	CHI
542	DET	ST.L.
543	MIN	DAL
544	S.J.	L.A.
THU. DEC. 27		
545	TOR	PHI
546	FLA	ATL
547	NYI	OTT
548	WSH	PIT
549	MTL	T.B.
550	CBJ	NSH
551	DET	COL
552	ANA	EDM
553	MIN	PHX
554	CGY	VAN
FRI. DEC. 28		
555	BUF	N.J.
556	BOS	CAR
557	MTL	FLA
558	S.J.	ST.L.
SAT. DEC. 29		
559	•PHI	T.B.
560	•L.A.	COL
561	NYR	TOR
562	•WSH	OTT
563	N.J.	NYI
564	BOS	ATL
565	CAR	CBJ
566	BUF	PIT
567	S.J.	NSH
568	EDM	MIN
569	ST.L.	DAL
570	DET	PHX
571	ANA	CGY
SUN. DEC. 30		
572	•PHI	FLA
573	MTL	NYR
574	L.A.	CHI
575	•ANA	VAN
MON. DEC. 31		
576	•ATL	BOS
577	EDM	CBJ
578	ST.L.	DET
579	S.J.	MIN
580	NYI	CAR
581	COL	PHX
582	NSH	DAL
583	VAN	CGY
TUE. JAN. 1		
584	•PIT	BUF
585	•OTT	WSH
586	T.B.	TOR
587	CHI	L.A.
WED. JAN. 2		
588	FLA	N.J.
589	ATL	CAR
590	DAL	DET
591	EDM	ST.L.
592	PHX	COL
593	NYR	CGY
594	CBJ	ANA
THU. JAN. 3		
595	WSH	BOS

GAME #	VISITOR	HOME
THU. JAN. 3		
596	FLA	NYI
597	T.B.	MTL
598	TOR	PIT
599	EDM	NSH
600	DAL	MIN
601	CHI	PHX
602	NYR	VAN
603	CBJ	L.A.
604	CGY	S.J.
FRI. JAN. 4		
605	PHI	N.J.
606	OTT	BUF
607	CAR	ATL
608	CHI	ANA
SAT. JAN. 5		
609	•WSH	MTL
610	•DET	DAL
611	N.J.	BOS
612	PHI	TOR
613	T.B.	OTT
614	FLA	PIT
615	MIN	NSH
616	CAR	ST.L.
617	NYI	COL
618	ANA	PHX
619	NYR	EDM
620	CGY	L.A.
621	CBJ	S.J.
SUN. JAN. 6		
622	•BUF	ATL
623	DET	CHI
MON. JAN. 7		
624	MIN	DAL
625	NYI	EDM
626	NSH	ANA
TUE. JAN. 8		
627	CAR	BOS
628	BUF	N.J.
629	T.B.	NYR
630	PHI	ATL
631	CHI	MTL
632	PIT	FLA
633	COL	DET
634	CBJ	ST.L.
635	PHX	CGY
636	NYI	VAN
637	NSH	L.A.
WED. JAN. 9		
638	COL	WSH
639	DAL	CHI
640	TOR	ANA
THU. JAN. 10		
641	MTL	BOS
642	PHI	NYR
643	N.J.	CAR
644	FLA	ATL
645	BUF	OTT
646	PIT	T.B.
647	MIN	DET
648	DAL	ST.L.
649	PHX	EDM
650	TOR	L.A.
651	VAN	S.J.
FRI. JAN. 11		
652	ST.L.	CBJ
653	MIN	CHI



NHL SCHEDULE 2007-08



GAME #	VISITOR	HOME
FRI. JAN. 11		
654	NYI	CGY
655	PHX	VAN
SAT. JAN. 12		
656	• BOS	PHI
657	• DAL	L.A.
658	N.J.	BUF
659	DET	OTT
660	MTL	NYR
661	COL	CAR
662	PIT	ATL
663	T.B.	FLA
664	NSH	CBJ
665	TOR	S.J.
SUN. JAN. 13		
666	• PHI	WSH
667	• COL	FLA
668	• VAN	ST.L.
669	• PHX	MIN
670	NYI	OTT
671	CHI	NSH
672	CGY	EDM
673	• S.J.	ANA
MON. JAN. 14		
674	NYR	PIT
TUE. JAN. 15		
675	MTL	NYI
676	OTT	WSH
677	VAN	CBJ
678	CAR	TOR
679	COL	T.B.
680	ATL	DET
681	CGY	NSH
682	L.A.	EDM
683	S.J.	PHX
684	DAL	ANA
WED. JAN. 16		
685	NYI	N.J.
686	BUF	NYR
687	FLA	PHI
688	CGY	MIN
689	ST.L.	CHI
THU. JAN. 17		
690	TOR	BOS
691	EDM	WSH
692	MTL	ATL
693	CAR	OTT
694	VAN	DET
695	ANA	NSH
696	CBJ	PHX
697	DAL	S.J.
FRI. JAN. 18		
698	FLA	N.J.
699	EDM	CAR
700	ATL	BUF
701	T.B.	PIT
702	ANA	MIN
703	CHI	COL
704	L.A.	CGY
SAT. JAN. 19		
705	• NYR	BOS
706	• CBJ	DAL
707	BUF	TOR
708	PIT	MTL
709	T.B.	OTT
710	PHI	NYI
711	FLA	WSH

GAME #	VISITOR	HOME
SAT. JAN. 19		
712	NSH	ST.L.
713	CHI	PHX
714	L.A.	VAN
715	DET	S.J.
SUN. JAN. 20		
716	• BOS	NYR
717	ANA	DAL
718	• EDM	ATL
719	• TOR	N.J.
720	OTT	PHI
721	CBJ	COL
MON. JAN. 21		
722	• CAR	NYI
723	• BUF	PHX
724	• ST.L.	NSH
725	WSH	PIT
726	MIN	VAN
TUE. JAN. 22		
727	ATL	NYR
728	N.J.	PHI
729	NYI	CAR
730	BOS	MTL
731	EDM	T.B.
732	OTT	FLA
733	CBJ	DAL
734	NSH	COL
735	MIN	CGY
736	DET	L.A.
737	CHI	S.J.
WED. JAN. 23		
738	WSH	TOR
739	ST.L.	VAN
740	DET	ANA
THU. JAN. 24		
741	NYI	BOS
742	MTL	N.J.
743	ATL	NYR
744	PIT	PHI
745	TOR	WSH
746	OTT	T.B.
747	EDM	FLA
748	CBJ	CHI
749	BUF	DAL
750	MIN	COL
751	NSH	PHX
752	ANA	L.A.
753	ST.L.	S.J.
SAT. JAN. 26		
<i>Skills Competition & Future Stars Game in Atlanta</i>		
SUN. JAN. 27		
<i>All-Star Game in Atlanta</i>		
TUE. JAN. 29		
754	NSH	BOS
755	PIT	N.J.
756	OTT	NYI
757	L.A.	PHI
758	NYR	CAR
759	PHX	CBJ
760	ST.L.	TOR
761	WSH	MTL
762	BUF	T.B.
763	S.J.	EDM
764	DAL	VAN

GAME #	VISITOR	HOME
WED. JAN. 30		
765	PIT	ATL
766	BUF	FLA
767	PHX	DET
768	ANA	MIN
769	CHI	COL
770	S.J.	CGY
THU. JAN. 31		
771	L.A.	NYI
772	NYR	PHI
773	MTL	WSH
774	TOR	CAR
775	BOS	OTT
776	VAN	T.B.
777	CBJ	NSH
FRI. FEB. 1		
778	NYR	N.J.
779	BUF	ATL
780	VAN	FLA
781	COL	DET
782	ANA	ST.L.
783	DAL	EDM
SAT. FEB. 2		
784	• NYI	MTL
785	DET	BOS
786	OTT	TOR
787	L.A.	N.J.
788	ANA	PHI
789	ATL	WSH
790	MIN	CBJ
791	CAR	PIT
792	FLA	T.B.
793	PHX	NSH
794	COL	ST.L.
795	DAL	CGY
796	• CHI	S.J.
SUN. FEB. 3		
797	• NYR	MTL
MON. FEB. 4		
798	PIT	N.J.
799	PHX	COL
800	CGY	EDM
TUE. FEB. 5		
801	BUF	BOS
802	ANA	NYI
803	L.A.	NYR
804	PHI	ATL
805	WSH	CBJ
806	FLA	TOR
807	OTT	MTL
808	CAR	NSH
809	DET	MIN
810	T.B.	ST.L.
811	VAN	DAL
812	PHX	CGY
WED. FEB. 6		
813	N.J.	BUF
814	WSH	PHI
815	CHI	EDM
816	COL	S.J.
THU. FEB. 7		
817	ANA	NYR
818	VAN	ATL
819	TOR	MTL
820	FLA	OTT
821	NYI	PIT
822	L.A.	DET

GAME #	VISITOR	HOME
THU. FEB. 7		
823	T.B.	NSH
824	DAL	MIN
825	CHI	CGY
826	CBJ	PHX
FRI. FEB. 8		
827	ANA	N.J.
828	CAR	WSH
829	BOS	BUF
830	CBJ	S.J.
SAT. FEB. 9		
831	• NYR	PHI
832	• L.A.	PIT
833	• DET	TOR
834	• NYI	MIN
835	FLA	BOS
836	MTL	OTT
837	CAR	N.J.
838	T.B.	ATL
839	• EDM	CGY
840	ST.L.	DAL
841	COL	VAN
842	NSH	S.J.
SUN. FEB. 10		
843	• PHI	PIT
844	• NYR	WSH
845	• ANA	DET
846	L.A.	CBJ
847	• MIN	ST.L.
848	FLA	BUF
849	NSH	PHX
850	CHI	VAN
MON. FEB. 11		
851	PHX	DAL
TUE. FEB. 12		
852	CAR	BOS
853	PHI	NYI
854	BUF	OTT
855	MTL	T.B.
856	DET	NSH
857	L.A.	ST.L.
858	ANA	COL
859	MIN	EDM
860	CGY	S.J.
WED. FEB. 13		
861	TOR	BUF
862	OTT	N.J.
863	WSH	ATL
864	CHI	CBJ
865	BOS	PIT
866	MTL	FLA
THU. FEB. 14		
867	T.B.	PHI
868	PIT	CAR
869	NYI	TOR
870	CHI	NSH
871	ST.L.	COL
872	DAL	PHX
873	MIN	VAN
874	EDM	S.J.
FRI. FEB. 15		
875	ATL	N.J.
876	WSH	FLA
877	CBJ	DET
878	DAL	ANA
879	CGY	L.A.



NHL SCHEDULE 2007-08



GAME # VISITOR HOME

SAT. FEB. 16

880 • BUF NYR
881 BOS TOR
882 PHI MTL
883 N.J. OTT
884 ATL NYI
885 FLA CAR
886 WSH T.B.
887 ST.L. NSH
888 L.A. PHX
889 EDM VAN

SUN. FEB. 17

890 • PIT BUF
891 • S.J. NYR
892 COL CHI
893 DET DAL
894 • CBJ ST.L.
895 MTL PHI
896 NSH MIN
897 • CGY ANA

MON. FEB. 18

898 • CAR N.J.
899 • S.J. NYI
900 DET COL
901 PHX L.A.

TUE. FEB. 19

902 BOS CAR
903 CBJ TOR
904 NYR MTL
905 PHI OTT
906 FLA PIT
907 EDM NSH
908 VAN MIN
909 CHI ST.L.
910 CGY PHX

WED. FEB. 20

911 T.B. BUF
912 S.J. N.J.
913 NYI WSH
914 MIN CHI
915 CGY DAL
916 COL ANA

THU. FEB. 21

917 T.B. NYI
918 S.J. PHI
919 ATL CAR
920 BUF TOR
921 PIT MTL
922 CBJ OTT
923 BOS FLA
924 VAN NSH
925 ST.L. L.A.

FRI. FEB. 22

926 EDM DAL
927 DET CGY
928 COL PHX
929 ST.L. ANA

SAT. FEB. 23

930 • NYI N.J.
931 • OTT PIT
932 • CHI L.A.
933 • WSH CAR
934 NYR BUF
935 ATL TOR
936 CBJ MTL
937 FLA PHI
938 BOS T.B.

GAME # VISITOR HOME

SAT. FEB. 23

939 DAL NSH
940 DET VAN

SUN. FEB. 24

941 • CGY MIN
942 • S.J. PIT
943 • N.J. WSH
944 FLA NYR
945 COL EDM
946 ST.L. PHX
947 • CHI ANA

MON. FEB. 25

948 PHI BUF
949 TOR OTT

TUE. FEB. 26

950 OTT BOS
951 PIT NYI
952 MIN WSH
953 N.J. CAR
954 ATL MTL
955 DAL ST.L.
956 COL CGY
957 DET EDM

WED. FEB. 27

958 NSH BUF
959 S.J. CBJ
960 MIN T.B.
961 TOR FLA
962 PHX CHI
963 COL VAN

THU. FEB. 28

964 PIT BOS
965 OTT PHI
966 NYR CAR
967 NYI ATL
968 PHX ST.L.
969 CHI DAL
970 L.A. EDM

FRI. FEB. 29

971 WSH N.J.
972 MTL BUF
973 MIN FLA
974 S.J. DET
975 TOR T.B.
976 CBJ VAN
977 CGY ANA

SAT. MAR. 1

978 • ATL BOS
979 • PHI NYI
980 • PIT OTT
981 N.J. MTL
982 TOR WSH
983 T.B. CAR
984 NSH DAL
985 S.J. ST.L.
986 L.A. COL
987 CGY PHX

SUN. MAR. 2

988 • DET BUF
989 • FLA NYI
990 • PHI NYR
991 • ATL PIT
992 • VAN CHI
993 • L.A. MIN
994 CBJ EDM

GAME # VISITOR HOME

MON. MAR. 3

995 BOS WSH
996 OTT ANA
997 MTL S.J.

TUE. MAR. 4

998 FLA BOS
999 NYI NYR
1000 BUF PHI
1001 N.J. TOR
1002 PIT T.B.
1003 CHI MIN
1004 L.A. ST.L.
1005 VAN COL
1006 CBJ CGY
1007 NSH EDM

WED. MAR. 5

1008 WSH BUF
1009 CAR ATL
1010 ST.L. DET
1011 ANA CHI
1012 PHX DAL
1013 OTT S.J.

THU. MAR. 6

1014 TOR BOS
1015 NYR NYI
1016 T.B. PHI
1017 MIN CAR
1018 PIT FLA
1019 ANA COL
1020 MTL PHX
1021 NSH VAN
1022 OTT L.A.

FRI. MAR. 7

1023 T.B. N.J.
1024 EDM CBJ
1025 MIN ATL
1026 S.J. CHI
1027 NSH CGY

SAT. MAR. 8

1028 • WSH BOS
1029 • MTL L.A.
1030 N.J. TOR
1031 NYI PHI
1032 BUF CAR
1033 ATL FLA
1034 DAL COL
1035 OTT PHX
1036 ST.L. VAN

SUN. MAR. 9

1037 • BOS NYR
1038 • PIT WSH
1039 • NSH DET
1040 • T.B. CBJ
1041 • EDM CHI
1042 • S.J. MIN
1043 COL DAL
1044 • MTL ANA

MON. MAR. 10

1045 NYR BUF
1046 ST.L. CGY
1047 VAN L.A.

TUE. MAR. 11

1048 COL ATL
1049 PHI TOR
1050 N.J. MTL
1051 BOS OTT
1052 NYI T.B.

GAME # VISITOR HOME

TUE. MAR. 11

1053 CHI DET
1054 S.J. NSH
1055 ST.L. EDM
1056 ANA PHX

WED. MAR. 12

1057 TOR PHI
1058 CGY WSH
1059 BUF PIT
1060 NYI FLA
1061 CAR CHI
1062 VAN ANA

THU. MAR. 13

1063 T.B. BOS
1064 CGY ATL
1065 OTT MTL
1066 DAL DET
1067 L.A. NSH
1068 N.J. MIN
1069 EDM COL
1070 VAN PHX

FRI. MAR. 14

1071 ATL WSH
1072 CHI CBJ
1073 CAR BUF
1074 NYR FLA
1075 ST.L. S.J.

SAT. MAR. 15

1076 • PHI BOS
1077 • NSH DET
1078 • N.J. COL
1079 BUF TOR
1080 NYI MTL
1081 NYR T.B.
1082 L.A. MIN
1083 VAN DAL
1084 EDM PHX
1085 ST.L. ANA

SUN. MAR. 16

1086 • PHI PIT
1087 • BOS WSH
1088 • OTT CAR
1089 • DET CBJ
1090 • CGY CHI
1091 • ATL FLA
1092 • EDM S.J.

MON. MAR. 17

1093 COL MIN
1094 PHX VAN

TUE. MAR. 18

1095 TOR NYI
1096 PIT NYR
1097 ATL PHI
1098 CGY CBJ
1099 ST.L. MTL
1100 WSH NSH
1101 PHX EDM
1102 S.J. L.A.

WED. MAR. 19

1103 T.B. BUF
1104 NYR N.J.
1105 CAR ATL
1106 CBJ DET
1107 WSH CHI
1108 ANA DAL
1109 MIN S.J.

• AFTERNOON GAME



NHL SCHEDULE 2007-08



GAME #	VISITOR	HOME
THU. MAR. 20		
1110	MTL	BOS
1111	ST.L.	OTT
1112	T.B.	PIT
1113	CAR	FLA
1114	DET	NSH
1115	COL	CGY
1116	VAN	EDM
1117	L.A.	PHX
FRI. MAR. 21		
1118	NYI	N.J.
1119	NYR	PHI
1120	TOR	BUF
1121	WSH	ATL
1122	MIN	VAN
1123	ANA	S.J.
SAT. MAR. 22		
1124	•CHI	NSH
1125	•L.A.	DAL
1126	•COL	EDM
1127	BOS	MTL
1128	TOR	OTT
1129	T.B.	FLA
1130	DET	CBJ
1131	N.J.	PIT
1132	MIN	CGY
1133	ANA	PHX
SUN. MAR. 23		
1134	•ST.L.	CHI
1135	NYI	PHI
MON. MAR. 24		
1136	PIT	NYI
1137	OTT	MTL
1138	CGY	COL
1139	MIN	EDM

GAME #	VISITOR	HOME
TUE. MAR. 25		
1140	OTT	BUF
1141	PIT	N.J.
1142	PHI	NYR
1143	WSH	CAR
1144	BOS	TOR
1145	FLA	T.B.
1146	CBJ	NSH
1147	DET	ST.L.
1148	VAN	CGY
1149	S.J.	PHX
WED. MAR. 26		
1150	CHI	CBJ
1151	EDM	MIN
1152	VAN	COL
1153	L.A.	ANA
THU. MAR. 27		
1154	TOR	BOS
1155	N.J.	NYR
1156	BUF	OTT
1157	NYI	PIT
1158	WSH	T.B.
1159	ATL	FLA
1160	PHX	L.A.
1161	DAL	S.J.
FRI. MAR. 28		
1162	PHI	N.J.
1163	ATL	CAR
1164	NSH	CBJ
1165	MTL	BUF
1166	ST.L.	DET
1167	VAN	MIN
1168	EDM	COL
1169	S.J.	ANA

GAME #	VISITOR	HOME
SAT. MAR. 29		
1170	•OTT	BOS
1171	•DAL	L.A.
1172	MTL	TOR
1173	PHI	NYI
1174	WSH	FLA
1175	CAR	T.B.
1176	CHI	ST.L.
1177	EDM	CGY
SUN. MAR. 30		
1178	•BOS	BUF
1179	•NYR	PIT
1180	•NSH	DET
1181	•COL	MIN
1182	CBJ	CHI
1183	•DAL	ANA
1184	•PHX	S.J.
1185	CGY	VAN
MON. MAR. 31		
1186	PIT	NYR
1187	ATL	T.B.
TUE. APR. 1		
1188	N.J.	NYI
1189	CAR	WSH
1190	FLA	ATL
1191	BUF	TOR
1192	MTL	OTT
1193	NSH	ST.L.
1194	CGY	EDM
1195	COL	VAN
1196	L.A.	S.J.
WED. APR. 2		
1197	BOS	N.J.
1198	T.B.	CAR
1199	PHI	PIT
1200	DET	CHI

GAME #	VISITOR	HOME
THU. APR. 3		
1201	NYR	NYI
1202	T.B.	WSH
1203	OTT	TOR
1204	BUF	MTL
1205	CBJ	DET
1206	ST.L.	NSH
1207	CGY	MIN
1208	EDM	VAN
1209	DAL	PHX
1210	S.J.	L.A.
FRI. APR. 4		
1211	NYI	NYR
1212	N.J.	PHI
1213	FLA	CAR
1214	BOS	OTT
1215	NSH	CHI
1216	PHX	DAL
SAT. APR. 5		
1217	•CBJ	ST.L.
1218	•ANA	L.A.
1219	BUF	BOS
1220	TOR	MTL
1221	FLA	WSH
1222	T.B.	ATL
1223	CGY	VAN
SUN. APR. 6		
1224	•NYR	N.J.
1225	•PIT	PHI
1226	•CHI	DET
1227	•ST.L.	CBJ
1228	•MIN	COL
1229	•S.J.	DAL
1230	•PHX	ANA

• AFTERNOON GAME

