

Nineteenth century astronomy at the U.S. Naval Academy

Paul D Shankland

AIM, University of Western Sydney, Australia
Address for correspondence: 8465 Cedar Ridge Circle,
Meridian, Mississippi 39305, USA
E-mail: CDR-Paul.Shankland@cnet.navy.mil

and

Wayne Orchiston

Anglo-Australian Observatory, PO Box 296, Epping,
NSW 2121, Australia
E-mail: wo@aaoepp.aao.gov.au

Abstract

During the 1850s the newly-formed U.S. Naval Academy in Annapolis, Maryland, acquired a small observatory featuring a 19.7-cm (7.75-in.) Clark refractor, transit telescopes, and an astronomical clock. The observatory was used as a base by staff to teach students the rudiments of nautical astronomy, but for a short time in 1869 the refractor was relocated to Des Moines, Iowa, as part of a U.S. Naval Observatory initiative to photograph a total solar eclipse. Although the Academy's observatory was demolished in 1908, courses and research in astrophysics were later introduced, and after more than 150 years astronomy continues to thrive at the U.S. Naval Academy.

Keywords: *U.S. Naval Academy, Alvan Clark refractor, astronomical education*

1 INTRODUCTION

Mention of astronomy and the U.S. Navy immediately conjures up images of the U.S. Naval Observatory (USNO) in Washington, proud owner of an historic 66 cm (26-in.) Clark refractor that for a short time was the largest refracting telescope in the world (see Dick, 2002). What is not so widely known is that the U.S. Naval Academy (USNA) in nearby Annapolis also boasted an observatory and a somewhat smaller Clark telescope during the nineteenth century. The USNA was founded in 1845 in order to provide formal training for future naval officers, and it is no surprise that nautical astronomy was an important area of the curriculum and the Observatory an indispensable teaching resource.

After briefly reviewing the founding of the Academy, this study discusses the USNA Observatory, its instrumentation, a solar eclipse expedition undertaken in 1869, Albert Michelson's foray into astronomical optics, and the astronomy training offered at the Academy during the nineteenth century, before ending with some brief remarks about its association with the USNO and more recent astronomy developments at the USNA.

2 FOUNDING OF THE ACADEMY

The USNA was founded in 1845, becoming fully collegiate (i.e. expanding from a two to a four year programme) in 1850. The impetus to create such an institution was an interesting one, and began some years earlier. The seeds were planted with the birth of the U.S. Navy during the Revolutionary War, and the need was further articulated by President John Quincy Adams in 1825 and again underscored in 1842 by U.S. Secretary of the Navy, A P Upshur. Yet it took an attempted mutiny on board a naval training vessel to have naval leadership reconsider the wisdom of immediate on-the-job training for future naval officers. The incident occurred on the American Brig *Somers* in 1842, and was orchestrated by a midshipman named Philip Spencer. Courts-martial were held, resulting in three hangings at the yard-arm (Park, 1900).

In response to this near-mutinuous training travesty, succeeding Secretary of the Navy, George Bancroft, sought a schoolhouse to formalize the educational process, settling on a 'cramming school' called the Philadelphia Naval Asylum. In 1845 he moved it to the "... healthy and secluded location of Annapolis to rescue midshipmen from the temptations and distractions that necessarily connect with a large and populous city ...", and set up a school with fifty students and seven professors (King *et al.*, 1995:2). This Naval School, at Fort Severn in Annapolis, was renamed the 'U.S. Naval Academy' in 1850.

3. THE OBSERVATORY

3.1 Founding of the Observatory

The Observatory at the USNA (Figure 1) was begun on 1850 July 1 and completed by 1854 November 1 (Sweetman, 1979), just one year after the Department of Astronomy, Navigation and Surveying was established. However, manufacture of its principal occupant, a fine-quality 19.7-cm (7.75-in.) Clarke refracting telescope, took more time, and the Observatory only became operational in 1857 (Nourse, 1874b). The building cost \$4696.75 (Lull, 1869), which at the time was a considerable sum given that the entire budget of the Academy in 1853 was just \$48,044.22 (Todorich, 1984). The Observatory was located near the centre of the Academy grounds, close to the chapel and alongside the Severn River. In 1879, Spencer Baird from the Smithsonian Institution reported its longitude as $0^{\text{h}} 2^{\text{m}} 15^{\text{s}}.91$ east of Washington, D.C., and its latitude as $38^{\circ} 58' 53''.5$ N.

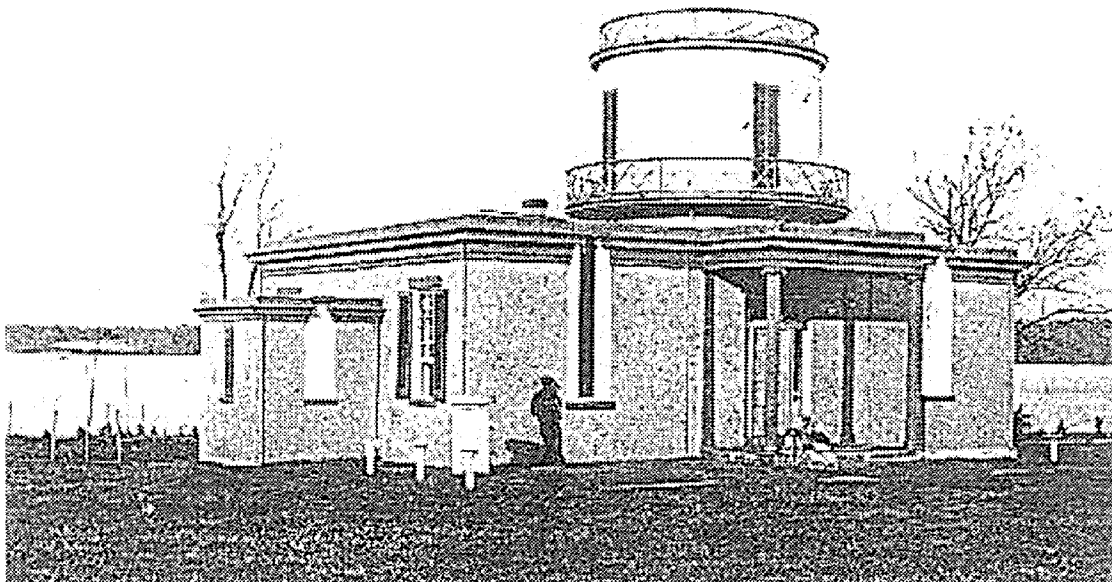

Figure 1. View of the USNA Observatory in 1868, looking north-east
(Courtesy: Physics Department, USNA).

Figure 1, which was taken in 1868 looking north-east, reveals an Observatory with a modicum of architectural charm. The original building had overall dimensions of 9.45×4.88 metres ($31 \text{ ft} \times 16 \text{ ft}$), and was constructed of brick in the shape of a cross (Marshall, 1862). It comprised a central room with entrance portico and a drum-shaped dome, plus adjacent 2.74×2.74 metre ($9 \text{ ft} \times 9 \text{ ft}$) eastern and western transit wings (see Figure 2). At some date(s) between Marshall's report of 1862 and 1868, when the photograph in Figure 1 was taken, the western transit wing was substantially increased, and a small transit annex was added to it. Some time between 1868 and 1897 this annex was enlarged until its northern wall was flush with the wall of the main observatory building (see Figure 4). The two transit wings and the transit annex containing N-S aligned transit slits that extended across the flat roof and down the northern and southern walls are clearly depicted in Figures 1 and 3. The wooden drum, which on the basis of people shown in Figures 3 and 10 would have been 3.0 and 3.2 metres in

diameter, housed the Clark telescope, and access to the sky was provided by a shuttered slit that extended across the flat roof and down one wall to the base of the drum (see Figure 10). The drum also contained two shuttered entranceways to an exterior catwalk, as shown in Figures 3 and 4. The likely reason for the selection of a drum rather than the more common hemispherical dome was its ease of construction and comparative cheapness.

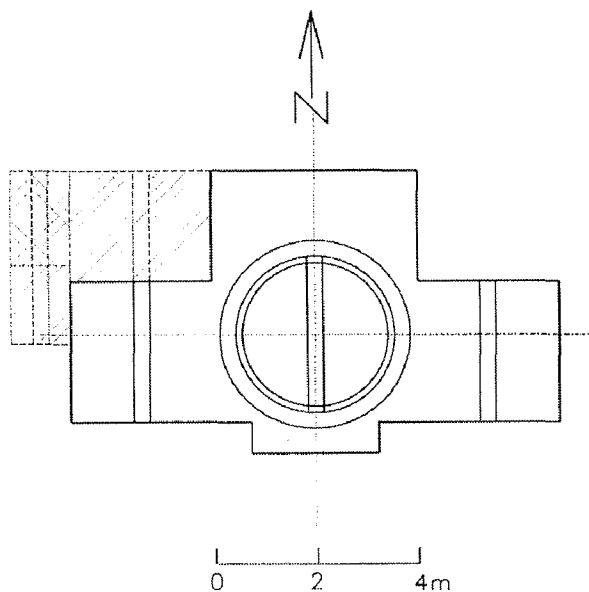

Figure 2. Reconstructed plan of the original Observatory, based on published accounts and archival photographs. The hatched areas were constructed sometime between 1862 and 1868, and the cross-hatched area between 1868 and 1897.

In terms of dimensions and overall design, the USNA Observatory was typical of other small United States observatories constructed during the first half of the nineteenth century. A central room with adjacent transit wings was the norm, and both the Hopkins Observatory and the Western Reserve Academy Observatory (Donnelly, 1973:75, 77), which were built in 1836

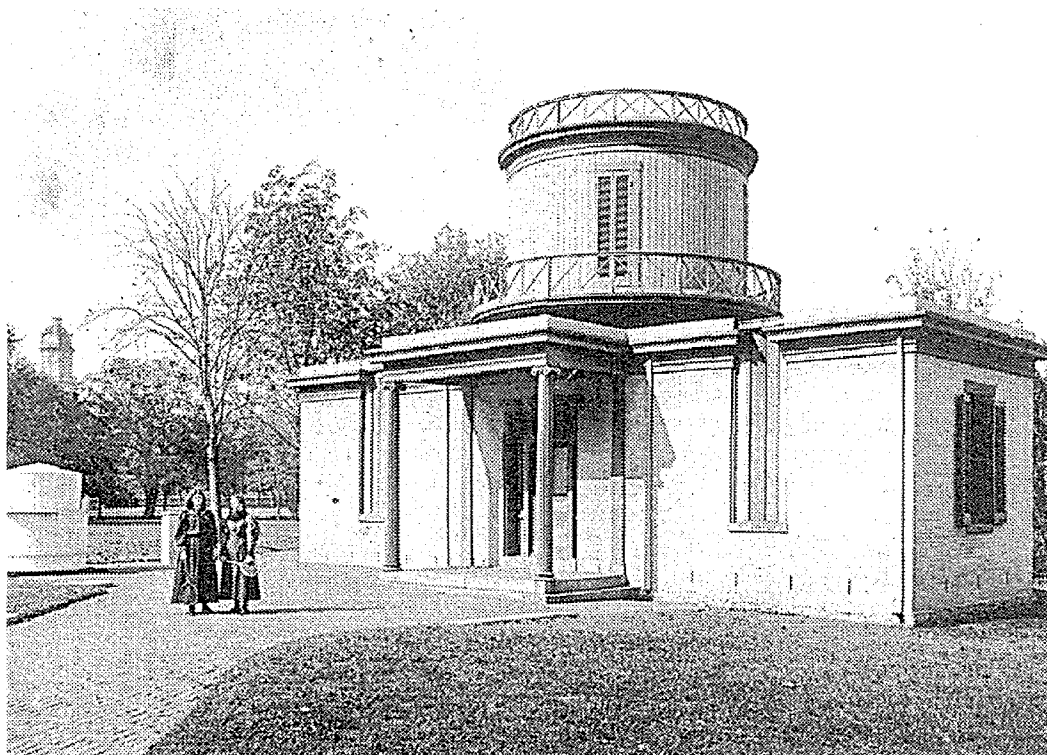

Figure 3. View of the Observatory in 1896, looking north-west (Courtesy: Physics Department, USNA).

and 1837 respectively, bear a close resemblance to the Observatory in Annapolis, while the original USNO and the Georgetown University Observatory, dating to 1842 and 1843 respectively, show the same basic design, even if on a much grander scale (see Donnelly, 1973:78, 81). However, the Hopkins Observatory (see Pasachoff, 1998) is the only one to possess a drum instead of a hemispherical dome, and this has led some at the USNA to speculate that it served as the prototype for their Observatory, even though Milham (1937) does not suggest this and there is no documentation in the USNA archives to support such a viewpoint. Furthermore, Robert Ariail (pers. comm., 2001) has pointed out that the two observatories were designed by different architects. Rather it would appear that generic aspects of nineteenth century observatory architecture influenced the design of the USNA Observatory.

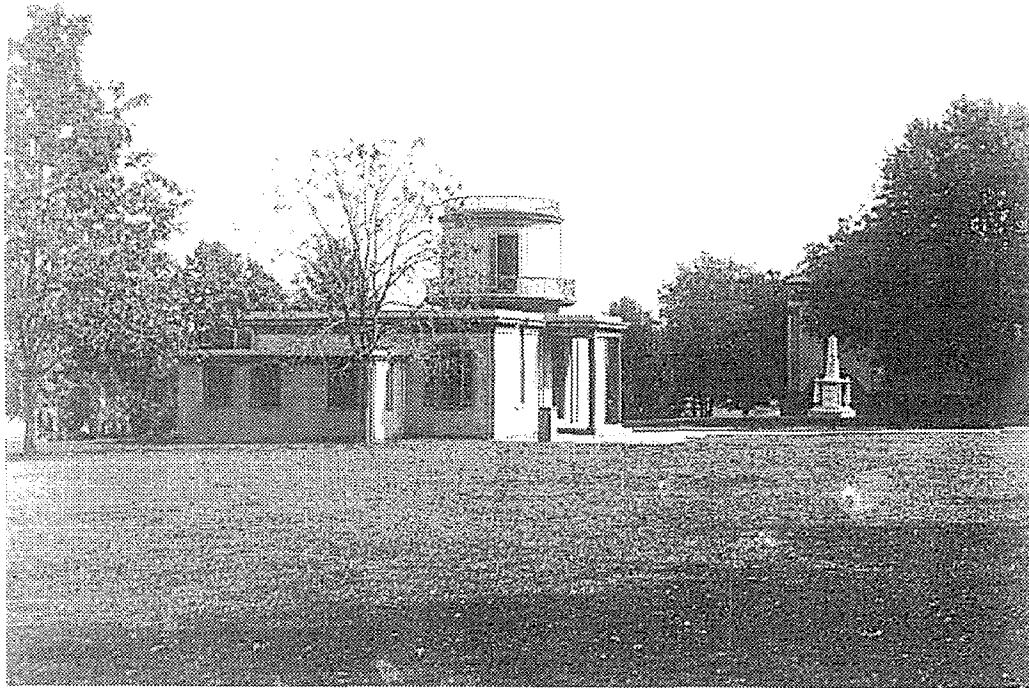

Figure 4. View of the Observatory in 1897, looking east (Courtesy: Physics Department, USNA).

3.2 The 19.7-cm Clark Refractor

The soul of the USNA Observatory was the equatorially-mounted achromatic Clark refractor (see Figure 5). The optics were completed in 1855, but because of funding issues and other delays the telescope only became operational in 1857. With a clear aperture of 19.7 cm (7.75 in.) and a focal length of 2.85 m (112.25 in.) the $f/14.5$ objective (Marshall, 1862) was the only known Clark lens of this exact size (see the listing in Warner and Ariail, 1995). In the eyes of USNA leaders, the telescope and its auxiliary instrumentation were prized educational accoutrements, and when the Academy moved to Fort Adams in Rhode Island during the US Civil War, the Superintendent penned a letter to his fellow Superintendent at the USNO requesting that they store the Clark telescope for safekeeping (*Letters ...*, 1845-1865).

Often compared to refractors of the '8-inch class', the lens was thought to be of exceptional quality (see Marshall, 1862; Phythian, 1869). In the 1850s, Clark approached lens-making in an holistic, almost aesthetic manner, his hands reportedly often gauging excellence merely by feel. Modern anecdotal evidence suggests this mythical ability attributed to Clark is perhaps wishful thinking. Nonetheless, Clark's revered lens-making techniques, as disclosed by Warner and Ariail (1995), involved crown and flint elements matched as unique, optimized pairs. Their confidence was such that the USNA objective was signed "Alvan Clark Cambridge, Mass. 1855" on the edge of the flint element, indicating that a highly-regarded hand was involved in its fabrication and that the company was willing to stake its reputation on the objective's excellence. The objective was of the Fraunhofer design, with little air spacing and a curve on

the flint not equal to that on the convex crown. Recent investigations indicate approximate radii at R1, R2, R3, and R4 of 1.71 m (convex), 0.89 m (convex), 0.85 m (concave) and 2.69 m (convex), respectively, while both crown and flint elements were seen to contain the few small bubbles and internal glass imperfections that are typical of optical quality glass made in the mid-nineteenth century.

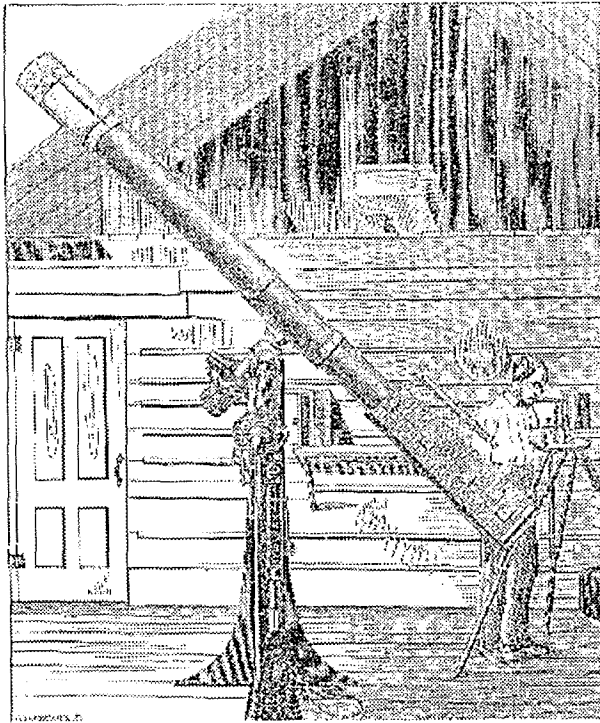

Figure 5. The 19.7-cm Clark telescope, as set up in Des Moines for the 1869 total solar eclipse (after Curtis, 1870:126).

The objective was originally mounted in what is believed to have been a wooden tube, complete with a dew-cap and a 4.4 cm (1.7 in.) aperture $f/11.7$ finder. The tube was supported by a clock-driven German equatorial mounting on a brick and cast iron pier, and the drive clock was regulated by a Bond spring governor. The telescope was supplied with seven different eyepieces and a filar micrometer (Soley, 1876). In an old USNA report dating to 1869, Phythian noted that the telescope was "... one of the best in the state ...", but these laudatory comments need to be taken in context given that there were very few 'competitors' in Maryland at that time with which to compare it.

The USNA telescope was manufactured early in Clark's career, and at that time was his second largest refractor, surpassed only by a 20.3 cm (8 in.) made for Dawes in 1853 (see Warner and Ariail, 1995:204). Meanwhile, by world standards the 19.7-cm Clark was respectable, but not outstanding. The largest refractor in existence in 1857 was the 39.4-cm (15.5-in.) Merz and Mahler instrument at the Harvard College Observatory, closely followed by its near-twin at the Pulkovo Observatory, and by 1859 there were at least fourteen refractors exceeding 24.1 cm (9.5 in.) in aperture world-wide, five of which were in the U.S.A. (see Table 1 in Orchiston, 2001). From a national perspective, the USNA Clark telescope therefore was in elite company.

3.3 Other Instrumentation

Observatory instrumentation which complemented the Clark varied in the course of the lifetime of the Observatory, but certain instruments are reported as principle appurtenances to the refractor. These included a very fine Repsold meridian circle of 2 arc seconds accuracy, with a 10.2-cm (4-in.) objective and a circle 72.9 cm in diameter, which was installed in the eastern transit wing. This instrument was used mainly for solar observation at 200 power, and was supplied with three eyepieces and four microscope circle-readers, and an observing couch (*Annual Register ...*, 1874; Baird, 1879; Boehmer, 1886).

At one time or another the following instruments were mounted on stone piers in the western transit wing and annex: a 7.6-cm (3-in.) Wurdemann zenith telescope with a focal length of 83.8 cm (33 in.); a 6.35-cm (2.5-in.) Stackpole broken-tube transit telescope; and a portable 5.1-cm (2-in.) Wurdemann meridian transit telescope with a focal length of 66 cm (26 in.) (*Annual Register ...*, 1874). The Stackpole transit telescope, which is of a distinctive design that was developed specifically for the US 1874 transit of Venus expeditions (see Dick *et al.*, 1998), was on loan from the USNO. In addition to housing these instruments, the western transit wing sometimes served as a lecture room (Marshall, 1862; Phythian, 1869).

Other instruments found at the USNA Observatory after 1874 included a portable 7.6-cm (3-in.) *f*/12 equatorial refractor by Plössl, a Wurdemann theodolite, an Ertel 'Universal Instrument', four surveyor's transits, 80 sextants, 34 artificial horizon, four reflecting circles, a level, five azimuth compasses, 20 comparing watches, and a plane-table (*Annual Register ...*, 1874), while a surveyor's compass and chain is also mentioned by Phythian (1869).

Timekeepers present were a sidereal clock by Arnold and Frodsham of London and an associated chronograph; five mean time chronometers by Dent, Hatton and Negus; and two Negus sidereal chronometers (*Annual Register ...*, 1874; Baird, 1879; Boehmer, 1886).

The Observatory was also furnished with charts, and a library of books, monographs, and scientific journals (Baird, 1879; Marshall, 1862). The library and instruments were housed in the large central room beneath the drum, and in the eastern transit wing, sometimes referred to as the 'Instrument Room' (Phythian, 1869).

3.4 The Demise of the Observatory

Despite its purportedly-inferior construction (Benjamin, 1900; Todorich, 1984), the Observatory stood defiantly for nearly half a century. Then in 1895 the Board of Visitors found the Academy's overall facilities to be "condemnable" (i.e run-down and ready for upgrade), and they recommended wholesale improvements. Among the building scheduled for demolition was the Observatory, and by the time that this actually occurred, in 1908, the telescope and many of the other instruments had been taken to the USNO for safekeeping (Durgin, 1975).

Meanwhile the new campus plan, prepared in 1895-6 by architect Ernest Flagg and Admiral Porter (the Superintendent), allowed for a replacement observatory. Architectural plans prepared by Flagg in 1896 show this observatory – complete with telescope – atop Mahan Hall, but when the final modified version of this major new building was constructed in 1907–10 the observatory was not included. In hindsight, perhaps this is not entirely surprising given that astronomy at the USNA could be more aptly described as celestial navigation, which did not really require the services of an observatory or the historic Clark refractor. Today Mahan Hall remains a stalwart of granite elegance, and instead of an observatory dome the elaborate central tower hosts a bell and a clock. No documentation has been found to explain why the Mahan Hall observatory was not constructed, but apart from its questionable usefulness, funding may also have been a factor. Furthermore, in the new scheme of things Mahan Hall housed an auditorium and the library, whereas the sciences (including astronomy) had to find other homes, and this may also have contributed to the decision not to build a new observatory there.

With the demise of the USNA Observatory, the Arnold & Frodsham sidereal clock remained at the Academy until it was loaned to the Smithsonian Institution for their Centennial Exposition. It subsequently was returned to the Academy, but was loaned to the Smithsonian again, in 1976, for their Bicentennial Exposition, and remains there (Cheevers, 1979-2001). Meanwhile, most of the other astronomical instruments in storage at the USNO were eventually disposed of or else mislaid (S. Dick, pers. comm, 2001), although the Clark objective was eventually identified and retrieved by the Academy.

4 ASTRONOMICAL RESEARCH

4.1 Introduction

Because the USNA Observatory was basically a teaching facility, it was not used to further positional astronomy – notwithstanding the research potential of the Clark refractor – and the only non-educational contribution made by this telescope was when it was relocated to Des Moines in 1869 to observe a total solar eclipse. The other notable research work that was carried out at the USNA during the nineteenth century was Michelson's investigation of the

speed of light, and history would later prove the important astronomical implications of this. Further details of the 1869 eclipse and of Michelson's work are presented below.

4.2 The Solar Eclipse of 1869

In the second half of the nineteenth century solar physics was at a forefront of astronomy as spectroscopic analysis of the Sun opened new vistas on our nearest star. One of the most contentious issues during the 1860s was the true nature of the corona: was it a solar feature, or was it a terrestrial or even a lunar phenomenon? Spectroscopic analyses during solar eclipses offered a solution to this dilemma, and the eclipse of 1869 August 7 which was visible from the USA fell at precisely the right time in the history of solar astronomy. As a result of this fortuitous situation,

... never before was an eclipsed sun so thoroughly tortured with all the instruments of Science...

The Government, the railway and other companies, and private persons threw themselves into the work with marvellous earnestness and skill; and the result was that the line of totality was almost one continuous observatory, from the Pacific to the Atlantic. We read in *Silliman's Journal*, "There seemed to be scarcely a town of any considerable magnitude along the entire line, which was not garrisoned by observers, having some special astronomical problem in view." This was as it should have been, and the American Government and men of science must be congratulated on the noble example they have shown to us, and the food for future thought and work they have accumulated. (Lockyer (1874:246).

One of the best-equipped observing stations was manned by staff from the USNO, and was located at Des Moines, Iowa. Recounted in meticulous detail in the 1870 printing of *Astronomical and Meteorological Observations Made at the United States Naval Observatory* (see Sands, 1870), this expedition was headed by Dr Edward Curtis (1870) and supported by Professors William Harkness (1870) and J R Eastman. Among the instruments was the USNA's 19.7-cm refractor, which was loaned so that it could be used to photograph the eclipse. It is interesting to note that this was the first time that Clark instruments were extensively used during a solar eclipse (Warner and Ariail, 1995).

The USNA telescope, original mounting and pier were all used, but the telescope had to be extensively modified in order to make it suitable for its intended photographic role. Accordingly, in 1869 May it was temporarily relocated to the Naval Observatory and set up in a wooden shed where it was fitted out with "... a wooden cross base for the pier, a camera box, plate-holders and diaphragm, new drive weights, and new pendulum components (to account for latitude changes). A Huyghenian [*sic*] eyepiece was used for projection to improve accuracy and measurement with cross-wires. The 7-inch plates were placed 4-inches behind the eyepiece for use." (Curtis, 1870:124). Figure 5 shows the telescope in final 'eclipse mode'.

A temporary observatory was erected on high ground near the north-eastern city limits of Des Moines, right on the central eclipse path, and comprised a 7.0 × 4.9 metre tent-like construction made from timber and canvas (Figure 6). This makeshift observatory included a floor, a darkroom, and the large observing room that housed the telescope and a chronometer.

There was some concern about the hoped-for performance of the telescope given that the achromat was corrected for visual use rather than for photography, so a number of preliminary focusing and timing tests were carried out. These experiments also allowed the astronomers to optimize their photographic techniques. These preparations were vindicated on eclipse day when the Clark telescope produced excellent photographs (despite water wash problems just prior to the event and tracking challenges during the eclipse). Eleven negatives of the Sun and 119 of the eclipse were taken, as well as 23 stereo views, and a drawing based on one of the photographs of totality is reproduced here as Figure 7.

Lessons that were learned from using the Clark refractor included a need for a flat-field eyepiece, a better means to ensure a sharp focus at the time of totality, and the aforementioned achromat concerns – to select an objective that was corrected for violet rather than white light. Curtis also reported a disconcerting flexure of the telescope's wooden tube, problems with the camera box (there were vibrations and shifts in tracking), and serious difficulty using the finder telescope with a white screen (see Sands, 1869). Most of these are not marks against the instrument, but simply reflect the adaptive employment of it.

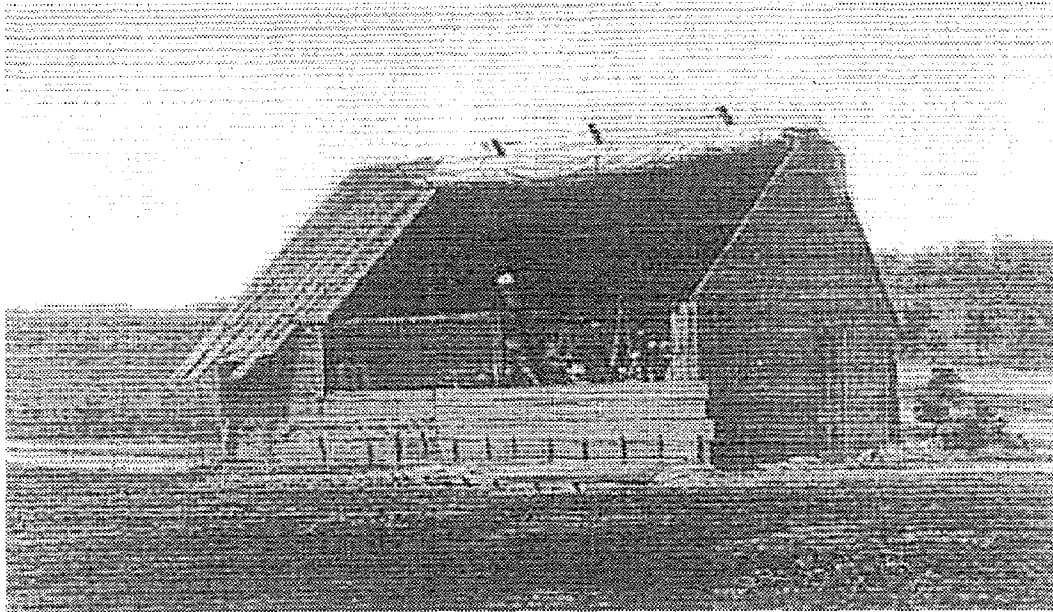

Figure 6. The temporary eclipse observatory set up at Des Moines for the Clark telescope (after Sands, 1870: Plate 1).

In the final analysis the Clark refractor performed well and contributed to forefront science, but the different observing teams across the nation produced conflicting results and the true nature of the corona remained in doubt (see Lockyer, 1874).

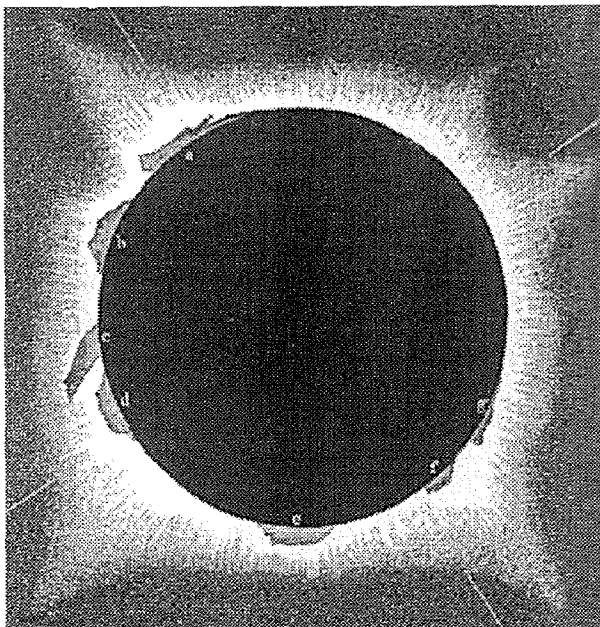

Figure 7. Drawing of the 1869 total solar eclipse, based on a photograph obtained with the Clark telescope. Individual prominences are indicated by letters a-g (after Lockyer, 1874:242).

4.3 Michelson and the Speed of Light

A discussion of research at the USNA is not complete without some consideration the influence that the United States' first Nobel laureate had on the institution, both as a student and as a teacher. Albert Michelson (1852–1931), a Polish emigrant, entered the Naval Academy at age 17 as a midshipman in the Class of 1873 (Figure 8). He did well in the sciences but poorly in seamanship, and after graduation and two years at sea he returned to the Academy and from 1875 to 1878 was an instructor in physics and chemistry. It was during this period that he began conducting his famous experiments into the speed of light. Not satisfied with the existing status

quo, in 1878 Michelson created his own measuring device, which cost a mere US\$10 (King *et al.*, 1995). This employed a 609.6 metre baseline along the shore of the Severn River bordering the USNA campus, and it was here that the result of 299,828 km/sec was obtained. This figure differs from the currently-accepted value by just 0.01%. Through this work, Michelson lent scientific credibility to the Academy's academics of the day, and his name is extensively honoured on campus today, as is the location of his historic research project.



Figure 8. Albert Michelson, 1852-1931, while a midshipman at the Academy (Courtesy: Physics Department, USNA).

In 1883, Michelson left the USNA for a Professorship at the Case School of Applied Science in Cleveland, and later he accepted a Chair at the newly-founded University of Chicago and taught there until his retirement in 1929. He died just two years later.

Michelson was awarded the Nobel Prize for physics in 1907, and his work of the speed of light and invention of the optical interferometer were to have a profound effect on the development of astronomy, cosmology, physics, and quantum mechanics.

5 TEACHING OF ASTRONOMY

5.1 Introduction

Astronomy was taught at the Academy from 1845, initially under the auspices of the Mathematics Department, and from 1853 by staff in the newly-created Department of Astronomy, Navigation, and Surveying (Phythian, 1869). There was also some interest in astronomy within the Physics Department. The respective roles of these three Departments in offering astronomy education at the Academy are discussed below.

5.2 The Department of Mathematics

Better officer education was prompted by the advent of steam propulsion, and actually motivated the creation of the USNA. With it came six foundation Departments, one of which was a Department of Mathematics headed by Professor William Chauvenet (Figure 9) who was destined to make a name for himself through his much-lauded book, *Spherical and Practical Astronomy*. Lankford (1997:126-127) records that "Chauvenet (1820-70) was born in Milford, Pennsylvania, and entered Yale at sixteen. Following an apprenticeship in geodesy and geophysics with Alexander Dallas Bache (1806-67) and astronomy under Seares Cook Walker (1805-53), Chauvenet was appointed ... to the Naval Academy. An expert in astrometry and celestial mechanics, Chauvenet did much to make European ideas and methods available to American astronomers."



Figure 9. William Chauvenet, 1820-1870, founder of the USNA Observatory and the Department of Astronomy, Navigation, and Surveying (Courtesy: Physics Department, USNA).

Midshipmen enrolled at the Academy studied arithmetic, algebra, geometry, trigonometry, and descriptive geometry in the first two years of their course, and analytical geometry, calculus, astronomy, navigation, and surveying in their final two years (Benac, n.d.). Chauvenet was largely responsible for the creation of the Observatory, which was seen as an indispensable teaching aid when it came to astronomy, navigation and surveying. In 1853, courses in these last three subjects were transferred to the newly-formed Department of Astronomy, Navigation, and Surveying.

5.3 The Department of Astronomy, Navigation, and Surveying

While the Observatory was under construction, Chauvenet agitated successfully for a new Department of Astronomy, Navigation, and Surveying, and when this was established in 1853 he became the Founding Professor and Head of Department. In 1859, just two years after the Observatory became operational, Chauvenet resigned to accept a post at Washington University in St. Louis. He was succeeded Professor Coffin, who in turn was replaced by Lieutenant Commander R L Phythian in 1869. Later Phythian would become a captain, and in 1890 Superintendent of the Academy.

Very useful accounts of the nineteenth century astronomy, navigation, and surveying offerings at the Academy can be found in Boehmer (1886), Nourse (1874a), Phythian (1869), Soley (1876) and old Academy registers, and there is also a helpful summary in King *et al.* (1995). Core competencies in marine surveying were taught, including use of the azimuth compass and the sextant (see Figure 10), and students learned how to make time observations and determine latitude and longitude. White's *The Elements of Theoretical and Descriptive Astronomy* was used as a textbook, along with tomes on navigation by Bowditch and Coffin (Pythian, 1869).

Training in navigation was comprehensive, and included such topics as compass sailing, great circle sailing, compass deviation, charts, sextant use, circle of reflection, artificial horizon, azimuth compass, meridian time, latitude by celestial altitudes, longitude by chronometer, Sumner's methods, and spherical trigonometry. First class students (seniors) practised celestial

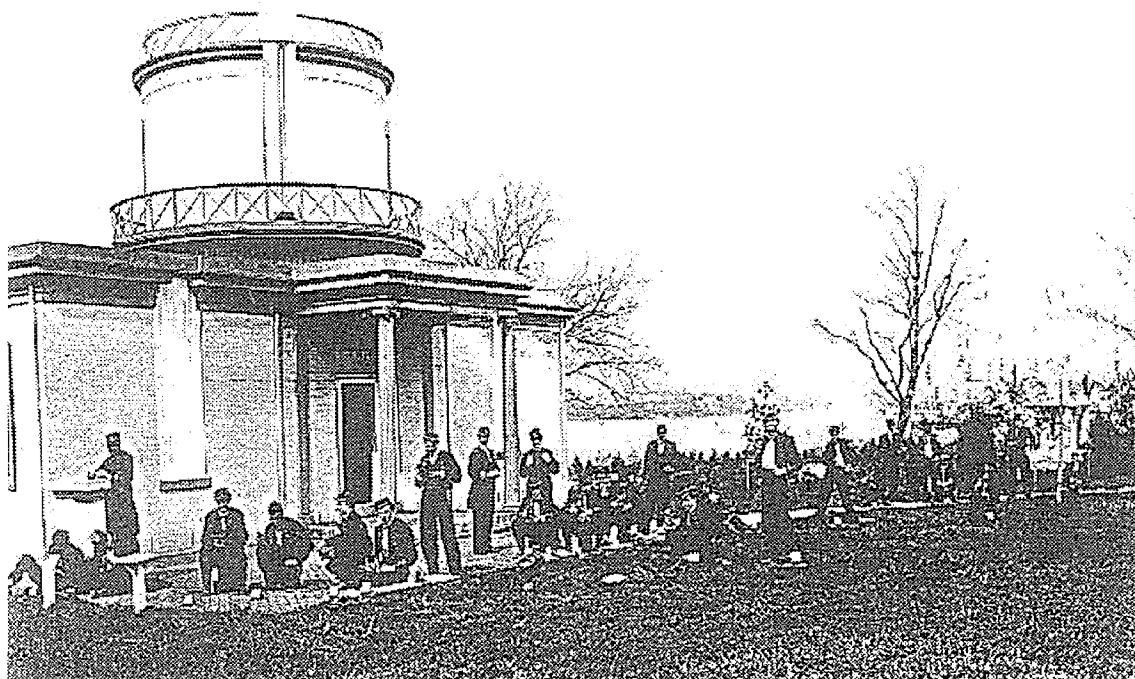

Figure 10. Midshipmen outside the Observatory engaged in a practical class on use of the sextant in 1869 (Courtesy: Physics Department, USNA).

navigation on a short cruise, and continued taking practical instruction for four hours per week throughout the academic year.

Phythian (*ibid.*) noted the Academy's requirement to focus on navigation, and he particularly lamented the limitations placed on astronomical observing and training in astronomy, but all second class students (juniors) took a first semester course in astronomy. Topics taught included physical and descriptive astronomy, the solar system, Kepler's Laws, Earth's motions and positional effects, weather and atmospheric effects, lunar astronomy, tidal theory, theory and calculation of eclipses and occultations, basic stellar astronomy, and time/equation of time. In addition, refraction, optical theory, and instrument construction were taught to upperclassmen. Cadet-engineers, who trained to become engineers on ships, also enrolled in a special astronomy course, but this focused on navigation. In addition, Phythian (*ibid.*) planned elective courses in pure astronomy, but no record exists of their implementation.

Although students were given basic instruction on how to use the Clarke refractor and the meridian circles at the USNA Observatory, there was inadequate time to teach any great proficiency let alone offer an opportunity to carry out research. But as the standards for preparation and appointment of midshipmen prior to entrance improved, less time was spent on the more basic training and slightly improved access to the main telescope was given in order to make students more proficient in carrying out and reducing astronomical observations. There was still no opportunity for research, and the hoped-for pure astronomy electives did not materialize (Phythian, 1869; Soley, 1876). Despite these perceived shortcomings, the USNA Observatory did perform a very valuable training role; but like other nineteenth century US college observatories, it suffered from a general lack of funding and academic staffing (see Lankford, 1995), although it did have ample military staff.

5.4 The Physics Department and its predecessor

The Physics Department was not formed until 1895, but its precursor, the Department of Natural and Experimental Philosophy, was one of the six Departments established when the Academy was founded. Through this Department, midshipmen were able to study various branches of physical science, but astronomy was confined to the Mathematics Department and later to the

Department of Astronomy, Navigation, and Surveying. As we have seen, the emphasis was very much on what we now commonly refer to as 'marine astronomy' or 'nautical astronomy' (see Cotter, 1968; May, 1973), and it was only during Michelson's tenure in the Physics Department that the concept of purist research and provocative thinking began to emerge. Clearly the Academy derived a certain amount of pride from its association with so pioneering a scientist, and the impact of Michelson's early work seems to have encouraged the administration to reconsider its policy of taking teaching in a more military and less academic direction. Michelson was able to show that pure science could be of value in an officer's education, and eventually this philosophy would allow courses in astrophysics to be introduced – but this development only occurred during the twentieth century (see Anderson, 1935).

6 DISCUSSION

6.1 The USNA and the USNO

The USNO began as the Navy's official Depot of Charts and Instruments in 1830, and only became the 'Naval Observatory' in 1844, shortly before the founding of the USNA. It quickly accumulated an impressive cache of world-class instrumentation, including what for a time was the largest refracting telescope in the world, and set the tone for positional astronomy in the United States during the remainder of the nineteenth century. But more than this, the USNO had a dominating and formative influence over much of American astronomy at this time (see Dick, 2002).

As part of this ethos, its influence extended to astronomy at the nearby USNA, but the relationship between the two institutions was more one of symbiosis rather than domination by the larger better-resourced Washington-based Observatory. Both were US naval institutions that enjoyed a common naval chain of command, a common scientific and academic arena, close physical proximity, and a focus on navigationally-oriented astronomy. Meanwhile, the U.S. Navy relied on the USNO for its time service and for nautical almanacs, and on the USNA for its officers. Both institutions were framed by common military requirements, and both were intent on expanding their astronomy regimes, in spite of the odds.

One particularly interesting common feature of the USNO and the USNA was the corps of U.S. Navy Professors of Mathematics that both institutions shared from 1848. This unique group of non-service academics, of whom William Chauvenet was one, was specifically created by Congress to teach at the USNA, with the sole restriction that they were hired with "... the requisite skills for the respective job." (Peterson, 1990). It was this vagueness which allowed a few Professors to be placed at other U.S. naval institutions, including the USNO. With the passage of time, the Academy increasingly-moved away from using these Professors, while the USNO came to depend upon them and fought hard to maintain the corps (see Peterson, 1990).

While the USNO may have benefited from the formation of this corps of academic mathematicians and from the loan of the Academy's Clark refractor for its 1869 solar eclipse programme, for its part the USNA acquired a Stackpole transit telescope and Arnold and Frodsham sidereal clock from the USNO, and was able to store its instrumentation there in complete safety during times of civil threat.

Before ending this section we should note that the USNO and the USNA were not the only US military establishments to take an active interest in astronomy and to maintain observatories during the nineteenth century: from 1839 the U.S. Military Academy at West Point, New York, boasted an observatory, which from 1856 housed a 24.8-cm (9.75-in) Fitz refractor (see André and Angot, 1877). And while observatories at overseas military establishments were by no means common, they did exist, perhaps the best-known example being the famous Pulkovo Observatory where Russian army and naval officers were trained in geodetic, astronomical, and nautical techniques (Nourse, 1874a).

6.2 Twentieth Century Developments at the USNA

Much has changed at the USNA since the first Observatory was demolished in 1908. Postgraduate programmes were begun in 1909, leading to the creation of the Naval Postgraduate School. Academic accreditation was granted in 1930, and in 1933 the first degrees were conferred (King, *et al.*, 1995).

The Academy now boasts a Physics Department that employs professional astronomers and offers undergraduate courses and post-graduate degrees in astronomy. Students have access

to a computer-controlled DFM 50.8-cm (20-in.) reflector in a dome on the top of Michelson Hall, and faculty members are involved in astrophysical research, with emphasis on the photometric properties of certain types of variable stars, the nature of interstellar titanium, and radio emission from supernova remnants, radio galaxies, and quasars. Nautical astronomy, meanwhile, resides in a separate Department of Seamanship and Navigation.

From a heritage perspective, perhaps the most notable development during the twentieth century was the return of the historic 19.7-cm Clark objective to the campus, following its discovery by USNA Astronomy Club members during a visit to the USNO in 1986. After appropriate optical tests were carried out and various restoration options were reviewed, the USNA Alumni Class of 1941 elected to fund reconstruction of the Clark telescope, together with an observatory, as their fifty-year class gift to the Academy. On 1991 June 6, a formal ceremony marked the presentation of the new observatory and replica Clark telescope (but with an aluminium rather than wooden tube) to the Superintendent, Rear Admiral Virgil Hill. Since its opening, the telescope has provided celestial views for numerous groups of school students and Boy and Girl Scouts. Members of the USNA Astronomy Club have also enjoyed using it for casual observing, and for more serious projects (including sunspot counts, CCD imaging, and variable star photometry).

7 CONCLUDING REMARKS

In this paper we have provided an historical perspective on nineteenth century astronomy at the USNA. Along with an assessment of the USNA Observatory and the instruments it contained, we have summarized the nature of education, and in particular how the teaching of astronomy developed from the very founding of the Academy. In a bid to develop viable astronomy courses, there was competition between a more practical programme that served the Navy's nautical needs and a more concept-oriented academic system that emphasized critical-thinking. There was also a strong desire by those at the USNA for their institution to be compared favourably with the best US colleges (that has not changed!), where academic courses tended to be the norm. This struggle to find a viable balance can be likened to the conflicting approaches to life found in the ancient Greek cities of Athens and Sparta. While the mathematician-astronomer William Chauvenet and a number of early Superintendents stressed the practical line, Albert Michelson's eminence late in the nineteenth century encouraged a more academic approach. Even the venerable USNO had to grapple with similar conflicting philosophies, but in a research rather than educational context.

The founding of the Observatory at the USNA followed close on the heels of the Hopkins, Western Reserve Academy, West Point, USNO and Georgetown University Observatories, and although it took some architectural cues from the first of these observatories, its overall design – a central dome with adjacent transit wings – reflected common elements of observatory architecture in vogue at that time.

While by no means the nation's foremost astronomical facility, the USNA Observatory was reasonably well staffed and was an important element in nineteenth century American astronomy. It housed a respectable, if somewhat underutilized, Clark refractor of unique aperture, which served an important educational role by introducing thousands of future naval officers to the finer points of nautical astronomy. And for one brief moment it enjoyed a research role at Des Moines, Iowa, where the USNO set up an observing station for the total solar eclipse of 1869.

A major redevelopment of the campus at the end of the nineteenth century called for the demolition of the Observatory, and this occurred in 1908, bringing to an end exactly half a century of astronomical endeavours. Plans for a replacement Observatory atop Mahan Hall did not eventuate, perhaps through lack of money and changing priorities, and the Clark telescope and other instruments went into storage at the USNO. The Clark objective was only 're-discovered' in 1986, and a replica of the old telescope now offers USNA students and members of the public general sky-viewing opportunities, thereby continuing an educational tradition that was initiated back in 1857.

Throughout the life of the USNA, the competing benefits of academic education versus a professional military grounding have served to spawn interesting curriculum developments, and this is certainly true of astronomy. Courses in astrophysics and non-nautical astronomy were developed during the twentieth century; senior students now have access to a 50.8-cm reflector;

and staff are involved in forefront research. For more than 150 years, astronomy in one guise or another has continued to thrive at the U.S. Naval Academy. This is an institution that is truly rife with heritage and steeped in astronomical tradition.

8 ACKNOWLEDGEMENTS

We are grateful to the following for their guidance and advice: Bob Ariail, Trudy Bell, and Bob Hambleton (Antique Telescope Society); Dr Steve Dick (U.S. Naval Observatory); Jim Cheevers (USNA Museum) and staff from the Physics Department (but especially Dr Elise Albert) and the Nimitz Library at the USNA. We are particularly grateful to Dr Albert for permission to publish Figures 1, 3, 4, 8, 9, and 10, and to Phil Sharp (Australia Telescope National Facility) for preparing Figure 2. Finally, P.S. is grateful to his co-author for making it possible for him to study the history of his Alma Mater as part of the University of Western Sydney Masters programme.

9 REFERENCES

The following abbreviations are used:

USNA = U.S. Naval Academy

USNO = U.S. Naval Observatory

Anderson, A.B. (ed.), 1935. 90th Anniversary, USNA. *US Naval Institute Proceedings*, **61**:1363-1365, 1394, 1417-1418.

André, C., and Angot, A., 1877. *L'Astronomie Pratique et Les Observatoires En Europe et En Amérique, Depuis Le Milieu Du XVII^e Siècle Jusqu'a Nos Jours (Troisième Partie)*. Gauthier-Villars, de L'École Polytechnique, Paris.

Annual Register of the United States Naval Academy, at Annapolis, MD. Twenty-Fifth Academic Year, 1874-1875. Government Printing Office, Washington (1874).

Baird, Spencer, 1879. Reports of American observatories. *Smithsonian Institution Annual Report*: pp. 535-539.

Benac, T.J., n.d. *A Brief History of the Department of Mathematics*. Mathematics Department, USNA, Annapolis.

Benjamin, Park, 1900. *The United States Naval Academy ...* Putnam, New York.

Boehmer, George, 1886. Report on astronomical observatories. *Smithsonian Institution Annual Report*: pp. 367-371.

Cheevers, Jim, 1979-2001. Notes on the USNA Observatory and the sidereal clock. Unpublished personal reference notes, USNA Museum.

Cotter, C.H., 1968. *A History of Nautical Astronomy*. Hollis and Carter, London.

Curtis, Edward, 1870. Report of Dr Edward Curtis, U.S.A. In Sands:123-156.

Dick, Steven, 2002. *Sky and Ocean Joined. The U.S. Naval Observatory, 1830-2000*. Cambridge University Press, Cambridge.

Dick, S.J., Orchiston, W., and Love, T., 1998. Simon Newcomb, William Harkness and the nineteenth century American transit of Venus expeditions. *Journal for the History of Astronomy*, **29**:221-255.

Donnelly, Marian Card, 1973. *A Short History of Observatories*. University of Oregon, Eugene.

Durgin, H., 1975. Letter to William Jefferies, dated February 1. Original in the USNA Museum.

Flagg, Earnest, 1896. Original architectural design drawings: Academic Group USNA Annapolis Md Serial 1153. Drawings of Mahan Hall [Library], indicating observatory dome plans for construction 1907-1910, Public Works Department, USNA.

Harkness, William, 1870. Report of Professor William Harkness, U.S.N. In Sands:25-67.

King, Randy, Cheevers, James, and Harmon, Scott, 1995. *The United States Naval Academy: 150 Years of History*. Public Affairs Office, USNA, Annapolis.

Lankford, John., 1997. *American Astronomy. Community, Careers and Power, 1859-1940*. University of Chicago Press, Chicago.

Letters Sent by the Superintendent of the U.S. Naval Academy 11. 1845-1865. National Archives and Records Service, General Services Administration, Washington, (1973).

Lockyer, J.N., 1874. *Contributions to Solar Physics*. Macmillan, London.

Lull, P., 1869. *Description and History of the U.S. Naval Academy, From Its Origin to the Present Time*. USNA, Annapolis.

Marshall, Edward C., 1862. History of the United States Naval Academy. *The North American Review*, **95**:57-58.

May, W.E., 1973. *A History of Marine Astronomy*. Foulis, Henley-on-Thames.

Milham, Willis, 1937. *Early American Observatories*. Williams College, Williamstown.

Nourse, J.E., 1874a. Observatories in the US. *Harper's New Monthly Magazine*, **48**:526-541.

Nourse, J.E., 1874b. Observatories in the U.S. *Nature*, **10**:209.

- Orchiston, W., 2001. The English equatorial mounting and the history of the Fletcher Telescope. *Journal of Astronomical History and Heritage*, **4**:29-42.
- Pasachoff, Jay M., 1998. Williams College's Hopkins Observatory: the oldest extant observatory in the United States. *Journal of Astronomical History and Heritage*, **1**:61-78.
- Peterson, Charles, 1990. The United States Navy corps of Professors of Mathematics. *The Griffith Observer*, **54**(1):2-14.
- Phythian, R.L., 1869. Report to the Superintendent: Department of Astronomy, Navigation, &c dated April 26. In Lull:33-35.
- Sands, B.F, 1870. Appendix II. Reports on Observations of the Total Eclipse of the Sun, August 7, 1869. In *Astronomical and Meteorological Observations Made at the USNO During the Year 1867*. Government Printing Office, Washington.
- Soley, James, 1876. *Historical Sketch of the United States Naval Academy. Prepared by Direction of Rear-Admiral C.R.P. Rodgers, U.S.N., Superintendent U.S. Naval Academy for the Department of Education at the International Exhibition*. Government Printing Office, Washington.
- Sweetman, Jack, 1979. *The U.S. Naval Academy: An Illustrated History*. Naval Institute Press, Annapolis.
- Todorich, Charles, 1984. *The Stripling Years. The Spirited Years: A History of the Antebellum Naval Academy*. Naval Institute Press, Annapolis.
- Warner, Deborah, and Ariail, Robert, 1995. *Alvan Clark and Sons: Artists in Optics*. Willmann-Bell, Richmond.



Commander Paul Shankland received a B.Sc. degree in 1983 from the U.S. Naval Academy. A veteran carrier pilot with the U.S. Navy, he is currently Executive Officer of Jet Training Squadron Nine at Naval Air Station, Meridian, Mississippi. His astronomical interests include observational astronomy, cosmology, and the study of historic telescopes and observatories. He is currently enrolled in a Masters degree in Astronomy at the University of Western Sydney, Australia, through their graduate internet programme, and is looking forward to a career in astronomy after military retirement.

Dr Wayne Orchiston is a Research Associate at the Anglo-Australian Observatory and Archivist and Historian at the Australia Telescope National Facility, in Sydney, and has research interests in Cook voyage astronomy, Australian and New Zealand astronomical history, the history of radio astronomy, and meteoritics. He has written more than 160 research papers, and the book *Nautical Astronomy in New Zealand. The Voyages of James Cook* (Wellington, 1998). He is Secretary of IAU Commission 41 (History of Astronomy) and of the Inter-Union Commission for History of Astronomy. In 2001 he taught a compulsory double unit on 'Topics in the History of Astronomy' as part of the University of Western Sydney's Astronomy Internet Masters programme.