

DMA TM 8358.1

*The
Defense
Mapping
Agency*



DMA TECHNICAL MANUAL

**DATUMS, ELLIPSOIDS,
GRIDS, AND GRID
REFERENCE SYSTEMS**

**APPROVED FOR PUBLIC RELEASE;
DISTRIBUTION UNLIMITED**

NOTICE !

TM 8358.1 is undergoing revision to incorporate changes to fully implement specifications for the World Geodetic System 1984 (WGS 84) on new DMA products. The revised manual will be published in two parts. Part A will contain general guidance and Part B will provide guidance for production of specific mapping and charting products. Part A will be available spring 1996 and Part B later that year.

This document is a limited reprint of TM 8358.1, Edition 1, to satisfy interim requirements of DOD users, system developers, and DMA production personnel. The information contained in Edition 1 is accurate for portrayal of grids, projections, and geodetic datums on DMA products produced prior to September 1990. Information on maps or charts revised or compiled after that date may reflect differences in Military Grid Reference System (MGRS) 100,000-meter square identification letters due to transition to the WGS 84 datum and ellipsoid.

Appendix D, "Index to Preferred Grids, Datums, and Ellipsoids Specified For New Mapping", has been removed from this interim printing because of obsolete information. The index will be updated and made available as a separate product. Caution should be exercised in applying information provided in chapter 4, "Nonstandard Systems in Current Use". Significant revisions have been made to this chapter.

Questions relating to the contents of this manual should be directed to DMA customer support teams, liaison officers, or Geodesy and Geophysics Department customer support staff at (703) 275-8539, DSN 235-8539.

23 February 1996

Notice !

REPORT DOCUMENTATION PAGE

Form Approved
OMB No. 0704-0188

Public reporting burden for this collection of information is estimated to average 1 hour per response, including the time for reviewing instructions, searching existing data sources, gathering and maintaining the data needed, and completing and reviewing the collection of information. Send comments regarding this burden estimate or any other aspect of this collection of information, including suggestions for reducing this burden, to Washington Headquarters Services, Directorate for Information Operations and Reports, 1215 Jefferson Davis Highway, Suite 1204, Arlington, VA 22202-4302, and to the Office of Management and Budget, Paperwork Reduction Project (0704-0188), Washington, DC 20503.

1. AGENCY USE ONLY (Leave blank)		2. REPORT DATE SEPTEMBER 1990		3. REPORT TYPE AND DATES COVERED FINAL	
4. TITLE AND SUBTITLE Datums, Ellipsoids, Grids, and Grid Reference Systems (UNCLASSIFIED)				5. FUNDING NUMBERS	
6. AUTHOR(S) Hager, John W.; Fry, Larry L.; Jacks, Sandra S.; Hill, David R.					
7. PERFORMING ORGANIZATION NAME(S) AND ADDRESS(ES) Defense Mapping Agency Hydrographic/Topographic Center (SDHG) 6500 Brookes Lane Washington, D.C., 20315-0030				8. PERFORMING ORGANIZATION REPORT NUMBER DMA TM 8358.1	
9. SPONSORING / MONITORING AGENCY NAME(S) AND ADDRESS(ES) Defense Mapping Agency Plans and Requirements Directorate 8613 Lee Highway Fairfax, VA 22031-2137				10. SPONSORING / MONITORING AGENCY REPORT NUMBER DMA TM 8358.1	
11. SUPPLEMENTARY NOTES This manual replaces DMA TM 8358.1 Preliminary Edition					
12a. DISTRIBUTION / AVAILABILITY STATEMENT APPROVED FOR PUBLIC RELEASE; DISTRIBUTION UNLIMITED				12b. DISTRIBUTION CODE DISTRIBUTION UNLIMITED	
13. ABSTRACT (Maximum 200 words) This manual describes the basic principles of the Military Grid Reference System and the non-standard reference systems. It describes the method for determining references on maps and charts at scales of 1:1,000,000 and larger. It contains identifications for the grid zone designations and for the 100,000 meter squares of the Universal Transverse Mercator Grid and the Universal Polar Sterographic Grid. It also contains the specifications and grid identifications for the various non-standard grids. It provides diagrams and textual information for delineating geodetic datums and ellipsoids.					
14. SUBJECT TERMS Position location, military grid, geodetic datum, coordinate reference system, ellipsoid, spheroid, graticule, chart, projection.				15. NUMBER OF PAGES 150	
17. SECURITY CLASSIFICATION OF REPORT UNCLASSIFIED				16. PRICE CODE	
18. SECURITY CLASSIFICATION OF THIS PAGE UNCLASSIFIED		19. SECURITY CLASSIFICATION OF ABSTRACT UNCLASSIFIED		20. LIMITATION OF ABSTRACT	

DEFENSE MAPPING AGENCY

MISSION:

To enhance national security and support the Office of the Secretary of Defense, the Joint Chiefs of Staff, Unified and Specified Commands, Military Departments, and other users, by producing and distributing timely and tailored mapping, charting, and geodetic products, services, and training, and advising on such matters. To provide nautical charts and marine navigational data to worldwide merchant marine and private vessel operators. To maintain liaison with civil agencies and other national and international scientific and other mapping, charting, and geodetic activities.

**DEFENSE MAPPING AGENCY**8613 LEE HIGHWAY
FAIRFAX, VIRGINIA 22031-2137

DMA TM 8358.1



20 SEP 1990

DEFENSE MAPPING AGENCY TECHNICAL MANUAL 8358.1DATUMS, ELLIPSOIDS, GRIDS, AND
GRID REFERENCE SYSTEMS

FOREWORD

1. This manual states current authoritative guidance for the use and portrayal of grids and grid reference systems information as applicable to maps and charts compiled for the United States Department of Defense (DoD).
2. This publication contains no copyrighted material and has been approved for public release. Distribution is unlimited. DoD users may order copies from the Defense Mapping Agency Combat Support Center, ATTN: PMSR, Washington, D.C. 20315-0020. All other requests should be directed to the National Technical Information Center, Cameron Station, Alexandria, VA 22314-6145.

A handwritten signature in black ink that reads "Stan Smith".

STANLEY O. SMITH
Brigadier General, USAF
Chief of Staff

RECORD OF CHANGES AND AMENDMENTS			
AMENDMENT OR CHANGE NO.	DATE	IMPLEMENTATION DATE	REMARKS

CONTENTS

	PAGE
FOREWORD.....	v
LIST OF FIGURES.....	xiii
LIST OF TABLES.....	xv
CHAPTER 1 GENERAL	
Section 1-1 - Authority.....	1-1
1-2 - References.....	1-1
1-3 - Purpose.....	1-1
1-4 - Scope.....	1-1
1-5 - Utilization.....	1-2
1-6 - Definitions.....	1-2
1-7 - Reference Systems.....	1-4
1-8 - Standard and Nonstandard Grids.....	1-4
1-9 - Multiple Grids.....	1-4
1-10 - Overlapping Grids.....	1-4
1-11 - Extended Grids.....	1-4
1-12 - Grid and Datum Related Marginal Notes.....	1-5
1-13 - Supersession.....	1-5
CHAPTER 2 DATUMS, ELLIPSOIDS, PROJECTIONS AND MILITARY GRIDS	
Section 2-1 - General.....	2-1
2-2 - Horizontal Datums.....	2-1
2-3 - Transforming Coordinates from one Horizontal Datum to Another Horizontal Datum.....	2-1
2-4 - Ellipsoids.....	2-5
2-5 - Projections.....	2-5
2-6 - Military Grids.....	2-14
2-7 - Transforming Coordinates from one Grid System to Another Grid System.....	2-19
CHAPTER 3 THE U. S. MILITARY GRID REFERENCE SYSTEM (MGRS)	
Section 3-1 - General Description.....	3-1
3-2 - The Grid Zone Designation.....	3-1
3-3 - 100,000-Meter Square Identification.....	3-3
3-4 - The Military Grid Reference.....	3-5
3-5 - MGRS Application.....	3-5

CHAPTER 4 THE NONSTANDARD GRID SYSTEMS IN CURRENT USE	PAGE
Section 4-1 - Nonstandard Grids on Maps and Charts.....	4-1
4-2 - Diagrams of Nonstandard Grids	4-7
CHAPTER 5 GEOGRAPHIC COORDINATE REFERENCES	
Section 5-1 - Use	5-1
5-2 - The Geographic Reference	5-1
5-3 - Geographic Coordinates on Maps and Charts	5-1
5-4 - The World Geographic Reference System	5-3
CHAPTER 6 PORTRAYAL OF GRIDS ON MAPS AT 1:100,000 SCALE AND LARGER	
Section 6-1 - General.....	6-1
6-2 - The Major Grid	6-1
6-3 - Multiple Major Grids.....	6-3
6-4 - Overlapping Grids.....	6-10
6-5 - Secondary Grids	6-12
6-6 - The Declination Diagram (One Grid).....	6-12
6-7 - The Declination Diagram (More Than One Grid)	6-17
6-8 - The Grid Reference Box	6-17
CHAPTER 7 PORTRAYAL OF GRIDS ON MAPS AT 1:250,000 AND 1:500,000 SCALE	
Section 7-1 - General.....	7-1
7-2 - The Major Grid	7-1
7-3 - Multiple Major Grids.....	7-4
7-4 - Overlapping and Extended Grids.....	7-6
7-5 - Secondary Grids	7-6
7-6 - Grid Declination.....	7-8
7-7 - Magnetic Declination	7-9
7-8 - The Grid Reference Box	7-12
CHAPTER 8 PORTRAYAL OF GRIDS ON MAPS AT 1:1,000,000 SCALE	
Section 8-1 - General.....	8-1
8-2 - The Major Grid	8-1
8-3 - Multiple Major Grids.....	8-3
8-4 - Overlapping, Extended, and Secondary Grids.....	8-4
8-5 - Grid and Magnetic Declinations	8-4
8-6 - The Grid Reference Box	8-4

CHAPTER 9 GRIDS ON NAUTICAL CHARTS AT 1:75,000 SCALE AND LARGER	PAGE
Section 9-1 - General.....	9-1
9-2 - The Major Grid on Combat Charts and Amphibious Assault Charts.....	9-1
9-3 - The Major Grid on Mine Warfare Charts	9-2
9-4 - The Major Grid on Harbor, Approach, and Coastal Charts	9-2
9-5 - Multiple Major Grids on Combat Charts and Amphibious Assault Charts	9-5
9-6 - Multiple Major Grids on Harbor, Approach, and Coastal Charts.....	9-9
9-7 - Overlapping Grids on Combat Charts, Amphibious Assault Charts, and Mine Warfare Charts.....	9-9
9-8 - Overlapping Grids on Harbor, Approach, and Coastal Charts	9-10
9-9 - Secondary Grids	9-10
9-10 - The Declination Note	9-10
9-11 - The Grid Reference Box	9-11
9-12 - World Geodetic System (WGS) Datum Note	9-12
 CHAPTER 10 GRIDS ON NAUTICAL CHARTS AT SCALES SMALLER THAN 1:75,000	
Section 10-1 - General.....	10-1
10-2 - The Major Grid	10-1
10-3 - Multiple Grids	10-2
10-4 - Secondary Grids	10-2
10-5 - The Grid Reference Box (or Notes)	10-5
10-6 - World Geodetic System (WGS) Datum Note	10-5
 CHAPTER 11 GRIDS ON AERONAUTICAL CHARTS AT 1:500,000 SCALE AND LARGER	
Section 11-1 - General.....	11-1
11-2 - The Major Grid	11-1
11-3 - Grid Declination.....	11-3
11-4 - Magnetic Declination	11-3
11-5 - The Grid Reference Box	11-3

DMA TM 8358.1

APPENDIXES

- A - Table of Mil Equivalents
- * B - 100,000-Meter Square Identifications of the Military Grid Reference System (Graphics), Figures B-1 through B-4
- * C - Guide To Geodetic Status Of Large Scale Mapping
- * D - Index to Preferred Grids, Datums and Ellipsoids Specified for New Mapping
- * Requires periodic update and revision.

LIST OF FIGURES

Number	Title	Page
1	Defining Parameters of Ellipsoids	2-9
2	Mercator Projection	2-11
3	Transverse Mercator Projection	2-12
4	Secant Condition of Transverse Mercator Projection; Typical 6-degree Projection Zone.....	2-13
5	Polar Stereographic Projection.....	2-15
6	Lambert Conformal Conic Projection	2-16
7	Grid Zone Designations of the Military Grid Reference System.....	3-2
8	Basic Plan of the 100,000-meter Square Identifications of the U.S. Military Grid Reference System, Between 84°N. and 80°S.....	3-4
9	Method of Reading a U.S. Military Grid Reference from a 1:250,000 Scale Map	3-6
10	Method of Reading a U.S. Military Grid Reference from a Large Scale Map.....	3-7
11	Normal Lettering Plan of the 500,000- 100,000-unit squares of the British Grid System.....	4-2
12	World Geographic Reference (GEOREF) System.....	5-2
13	The Major Grid as Shown on a 1:50,000 Scale Map	6-2
14	The Major Grid as Shown on a 1:100,000 Scale Map	6-4
15	Two Major Grids (in this case, Zones of the UTM) Separated by a Grid Junction as Shown on a Large Scale Map.....	6-5
16	Three Major Nonstandard Grids as Shown on a Large Scale Map.....	6-6
17	Major and Overlapping Grids as Shown on a Large Scale Map.....	6-7
18	Overlapping Grid in Combination with Two Major Grids Separated by a Grid Junction as Shown on a Large Scale Map.....	6-8
19	Major and Secondary (Obsolete) Grids as Shown on a Large Scale Map.....	6-13
20	The Declination Diagram and Accompanying Notes with True North Appearing as the Center Prong.....	6-14
21	The Declination Diagram and Accompanying Notes with True North Appearing as an Outside Prong	6-15
22	The Declination Data when a Sheet Contains an Overlapping Grid and/or More Than One Major Grid	6-18
23	Grid Reference Boxes Most Commonly Used on Maps at Scales of 1:100,000 and Larger.....	6-19
24	Methods of Showing Grid Zone Designations and 100,000- meter Squares of the UTM in the Grid Reference Boxes of Large Scale Maps	6-20
25	Methods of Showing 100,000-unit, and Larger, Square Identifications of Nonstandard Grids in the Grid Reference Boxes of Large Scale Maps	6-21

	Page
26	Treatment for the Major Grid in UTM Areas as Shown on a 1:250,000 Map..... 7-2
27	Treatment for the Major Grid in UTM Areas as Shown on Maps Smaller than 1:250,000 Scale and Larger than 1:1,000,000..... 7-3
28	Two Major UTM Grid Zones Separated by a Grid Junction as Shown on a 1:250,000 Scale Map..... 7-7
29	Three Major Nonstandard Grids Separated by Grid Junctions as Shown on a 1:250,000 Scale Map..... 7-8
30	Two Major Grids (UTM) Separated by an Ellipsoid Junction as Shown on a 1:250,000 Scale Map..... 7-9
31	Treatment when Grid Falls within More than One UTM Grid Zone Designation Area as Shown on a 1:250,000 Scale Map..... 7-10
32	Major and Secondary (Obsolete) Grids as Shown on a 1:250,000 Scale Map 7-11
33	Grid Reference Boxes Most Commonly Used on Maps at 1:250,000 and 1:500,000 Scale 7-12
34	Treatment for the Major Grid in UTM Areas as Shown on Maps at 1:1,000,000 Scale 8-2
35	Two Major Grids (in this case, Zones of the UTM) Separated by a Grid Junction, as Shown on a Map at 1:1,000,000 Scale..... 8-5
36	Three Major Nonstandard Grids as Shown on a Map at 1:1,000,000 Scale..... 8-6
37	Grid Reference Box for 1:1,000,000 Scale Map 8-7
38	The Major Grid as Shown on Combat, Amphibious Assault Charts..... 9-3
39	Two Major Grids (in this case, Zones of the UTM) Separated by a Grid Junction as Shown on Combat, Amphibious Assault Charts 9-4
40	Treatment for the Major Grid on Mine Warfare Charts at 1:75,000 Scale and Larger 9-6
41	Treatment for the Major Grid on Harbor and Approach Charts at 1:75,000 Scale and Larger 9-7
42	Treatment for the Multiple Major Grids on Harbor and Approach Charts at 1:75,000 scale and Larger 9-8
43	Grid Reference Boxes Commonly Used on Nautical Charts at Scales of 1:75,000 and Larger 9-13
44	Treatment for the Major Grid on Nautical Charts at Scales Smaller than 1:75,000..... 10-3
45	Treatment for Multiple Grids on Nautical Charts at Scales Smaller than 1:75,000..... 10-4
46	Treatment for Major and Secondary Grids on Nautical Charts at Scales Smaller than 1:75,000 10-5
47	Grid Reference Box Commonly Used on Aeronautical Charts at 1:500,000 Scale and Larger 11-4

LIST OF TABLES

Number	Title	Page
1	Geodetic Datums Used in Map Production	2-2
2	Molodenskiy Transformation Constants to Convert from Local Datum to WGS 84	2-6
3	Characteristics of Projections.....	2-17
4	Grid Unit Intervals for Various Scale Topographic Maps	2-18
5	Dimensions of Grid Zone Designation Areas	3-3
6	Specifications for Secondary Grids	4-3
7	Corner Labeling on Topographic Maps.....	5-1
8	The Equivalents of 40 Kilometers when Measured Along a Given Parallel of Latitude Expressed in Degrees, Minutes, and Seconds of Longitude	6-11
9	Maximum Acceptable Deviation of the Constructed Grid from the True Grid.....	10-1

CHAPTER 1GENERAL1-1 AUTHORITY.

This document is issued under the authority delegated by DoD Directive 5105.40, subject: Defense Mapping Agency (DMA), 12 December 1988.

1-2 REFERENCES.

- 1-2.1 The DMA TM 8358 series replaces the DA TM 5-241 series of manuals.
- 1-2.2 JCS-MOP 88, Position Reference Procedures, 8 May 1981.
- 1-2.3 STANAG 2211, subject: Geodetic Datums, Ellipsoids, Grids, and Grid References.
- 1-2.4 STANAG 3676, subject: Marginal Information on Land Maps and Aeronautical Charts.
- 1-2.5 QSTAG 544, subject: Geodetic Datums, Spheroids, Grids, and Grid References.
- 1-2.6 IHO Circular Letter 9, International Horizontal Datum for Chart Reference, 15 March 1983.
- 1-2.7 IHO Circular Letter 28, Transformation Notes, WGS-84, 15 July 1988.
- 1-2.8 IHO Circular Letter 46, International Horizontal Datum for Chart Reference, 16 December 1983.
- 1-2.9 IHO Circular Letter 18, Indication on Charts of Relationship of Horizontal Datum to Worldwide and Other Datums, 17 May 1984.
- 1-2.10 IHO Circular Letter 46, Indication on Charts of Relationship of Horizontal Datum to Worldwide and Other Datums, 14 December 1984.
- 1-2.11 DMA TM 8358.2 The Universal Grids: Universal Transverse Mercator (UTM) and Universal Polar Stereographic (UPS).
- 1-2.12 DMA TR 8350.2 (and supplements) Department of Defense World Geodetic System 1984.

1-3 PURPOSE.

1-3.1 This manual provides guidance to DoD Mapping, Charting and Geodesy (MC&G) production elements, product users, and system developers on the application of datums, ellipsoids, grids, and grid reference systems within the DoD.

1-3.2 It describes the standard methods for selecting and portraying grids on maps and charts at scales of 1:1,000,000 and larger. Descriptions are based on the following categories.

- 1-3.2.1 Topographic Maps.
- 1-3.2.2 Hydrographic Charts.
- 1-3.2.3 Aeronautical Charts.

1-4 SCOPE.

1-4.1 This manual specifies the use of geodetic datums, ellipsoids, grids and grid reference systems used in the production of maps and charts for the DoD.

The Universal Transverse Mercator and Universal Polar Stereographic grids, the Military Grid Reference System, and nonstandard grid reference systems are described.

1-4.2 Detailed instructions and formats for grid depictions and labeling, grid margin data, declination data, etc. are contained in the DMA product specifications for approved topographic, hydrographic, and aeronautical products.

1-5 UTILIZATION.

1-5.1 TM 8358.1 is to be used by DoD MC&G production elements, product users, and DoD system developers in the application of datums, ellipsoids, grids, and grid reference systems.

1-5.2 Users are cautioned that the information contained herein applies to current and future MC&G production, and does not necessarily apply to products that are currently available through the DoD supply system.

1-6 DEFINITIONS.

1-6.1 Major Grid. The primary grid or grids on a map or chart.

1-6.2 Military Grid Reference System (MGRS). The alphanumeric position reporting system used by U.S. military. A full description is provided in Chapter 3.

1-6.3 Nonstandard Grids. Grids other than UTM and UPS, such as Ceylon Belt, India Zone IIA, West Malaysian RSO (Metric) Grid, etc.

1-6.4 Operational Grid. A grid in current operational use. Generally this would be the preferred grid but could be a previously prescribed grid.

1-6.5 Overlapping Grid. A major grid from a neighboring area primarily intended to facilitate military surveying and fire-control.

1-6.6 Preferred Grid. The grid designated by the DoD for production of new maps, charts, and digital geographic data; and shown on the "Index to Preferred Grids, Datums, and Ellipsoids Specified for New Mapping" (Appendix D).

1-6.7 Prescribed Grid. The grid that is locally prescribed by the country of origin or military commander.

1-6.8 Primary Grid. The major, or principal, grid on a map or chart.

1-6.9 Secondary Grid. Any grid, other than the primary grid, required for combined operations application. Tick marks along the neat lines are the preferred method of portrayal. Such grids should remain on the maps or charts so long as the secondary grid remains in use.

1-6.10 Standard Grids. The Universal Transverse Mercator (UTM) grid and the Universal Polar Stereographic (UPS) grid.

1-6.11 World Geographic Reference System (GEOREF). A worldwide position reference system that may be applied to any map or chart graduated in latitude and longitude regardless of projection. It provides a method of expressing positions in a form suitable for reporting and plotting. The primary use is for interservice and interallied reporting of aircraft and air target positions.

1-6.12 Other Key Terms.

1-6.12.1 Bleeding Edge. That edge of a map or chart on which cartographic detail is extended beyond the neatline to the edge of the sheet.

1-6.12.2 Coordinate Reference Notation. Grid coordinates are given in terms of linear measurement in meters. Geographic coordinates are given in terms of angular measurement, usually in degrees, minutes, and seconds but occasionally in grads.

1-6.12.3 Datum. As used in this manual, datum refers to the geodetic or horizontal datum. The classical datum is defined by a minimum of five elements giving the position of the origin (two elements), the orientation of the network (one element), and the parameters of a reference ellipsoid (two elements). More recent definitions express the position and orientation as functions of the deviations in the meridian and in the prime vertical, the geoidellipsoid separation, and the parameters of a reference ellipsoid. The World Geodetic System is a geocentric system that provides a basic reference frame and geometric figure for the earth, models the earth gravimetrically, and provides the means for relating positions on various datums to an earth-centered, earth fixed coordinate system.

1-6.12.4 Easting. Eastward (that is left to right) reading of grid values on a map.

1-6.12.5 Ellipsoid. An ellipsoid is a mathematical figure generated by the revolution of an ellipse about one of its axes. The ellipsoid that approximates the geoid is an ellipse rotated about its minor axis, or an oblate spheroid.

1-6.12.6 False Easting. A value assigned to the origin of eastings, in a grid coordinate system, to avoid the inconvenience of using negative coordinates.

1-6.12.7 False Northing. A value assigned to the origin of northings, in a grid coordinate system, to avoid the inconvenience of using negative coordinates.

1-6.12.8 Geoid. The equipotential surface in the gravity field of the Earth which approximates the undisturbed mean sea level extended continuously through the continents. The direction of gravity is perpendicular to the geoid at every point. The geoid is the surface of reference for astronomic observations and for geodetic leveling.

1-6.12.9 Graticule. A network of lines representing parallels of latitude and meridians of longitude forming a map projection.

1-6.12.10 Grid. Two sets of parallel lines intersecting at right angles and forming squares; a rectangular Cartesian coordinate system that is superimposed on maps, charts, and other similar representations of the earth's surface in an accurate and consistent manner to permit identification of ground locations with respect to other locations and the computation of direction and distance to other points.

1-6.12.11 Isogonic Line. A line drawn on a map or chart joining points of equal magnetic declination for a given time. The line connecting points of zero declination is the agonic line. Lines connecting points of equal annual change are isopors. The Magnetic Variation chart for the current 5-year epoch is available from the DMA CSC.

1-6.12.12 Loxodrome. A line on the surface of the Earth cutting all meridians at the same angle, a rhumb line.

1-6.12.13 Map Projection. An orderly system of lines on a plane representing a corresponding system of imaginary lines on an adopted terrestrial datum surface. A map projection may be derived by geometrical construction or by mathematical analysis.

1-6.12.14 Neatline. The lines that bound the body of a map, usually parallels and meridians (but may be conventional or arbitrary grid lines); also called sheet lines.

1-6.12.15 Northing. Northward (that is from bottom to top) reading of grid values on a map.

1-6.12.16 Spheroid. A mathematical figure closely approaching the geoid in form and size. Ellipsoid will be used in this manual.

1-7 REFERENCE SYSTEMS.

1-7.1 Rectangular grid reference systems are usually shown on military maps and charts at scales of 1:1,000,000 and larger. Maps and charts at all scales show the geographic graticule. Maps and aeronautical charts at 1:250,000 scale and smaller show the GEOREF.

1-7.2 The Military Grid Reference System is described in Chapter 3.

1-7.3 Grid reference systems used with operational nonstandard grids are described in Chapter 4.

1-7.4 The geographic coordinates are described in Chapter 5.

1-8 STANDARD AND NONSTANDARD GRIDS.

1-8.1 The standard grid for polar areas north of 84° north, and south of 80° south, is the Universal Polar Stereographic (UPS) grid.

1-8.2 Between 84° north and 80° south, the standard grid is the Universal Transverse Mercator (UTM) grid. Other grid systems are being phased out. The long term objective is to convert the mapping of all areas of the world to UTM and UPS grids.

1-8.3 Normally, grids are not portrayed on maps at scales smaller than 1:1,000,000.

1-9 MULTIPLE GRIDS.

The use of military grids presents complex conditions in junction areas, i.e., grid zone junctions within a grid system, grid junctions between various grid systems, datum junctions, and junctions between ellipsoids. Despite this complexity, these conditions lend themselves to a uniform graphical treatment of the grids with differences in grid orientation and grid color, labels, and values. The treatment of grids under various junction conditions is prescribed in later chapters of this manual.

1-10 OVERLAPPING GRIDS.

Maps at scales of 1:100,000 and larger, falling within approximately 40 kilometers of a grid junction, datum junction, or ellipsoid junction, usually show the adjacent (overlapping) grid by ticks and values around the neatline. In some instances, a coordinate conversion note may be used instead of an overlapping grid.

1-11 EXTENDED GRIDS.

An extended grid is a form of overlapping grid used on city maps. It provides total coverage of a map on a single grid when a portion of the map falls on an adjacent grid. The major grid is extended to cover the adjacent area and is shown by full lines.

1-12 GRID AND DATUM RELATED MARGINAL NOTES.

Marginal notes on maps and charts should include projection, ellipsoid, grid zone or belt, horizontal datum, and magnetic declination data. Specific treatment of these items on each product is covered in the various product specifications.

1-13 SUPERCESSION.

This document supercedes DMA 8358.1, Preliminary Edition.

CHAPTER 2

DATUMS, ELLIPSOIDS, PROJECTIONS
AND MILITARY GRIDS2-1 GENERAL.

2-1.1 The Earth is not a sphere, but an ellipsoid, flattened slightly at the poles and bulging somewhat at the Equator. The ellipsoid is used as a surface of reference for the mathematical reduction of geodetic and cartographic data.

2-1.2 A map projection is the systematic drawing of lines representing the meridians and parallels (the graticule) on a flat surface. Different projections have unique characteristics and serve differing purposes. They are depicted by projecting the graticule of the ellipsoid onto a plane; the intersections of the graticule are computed in terms of the ellipsoid.

2-1.3 U.S. military maps use the sexagesimal system of angular measurement (the division of a full circle into 360°) for designating the values of the graticule. A degree is divided into 60 minutes, and each minute into 60 seconds. Parallels are numbered north and south from 0° at the equator to 90° at the poles. Meridians are numbered east and west from 0° at the prime meridian to a common 180° meridian. The prime meridian used for U.S. military mapping and charting is related to the Bureau International de l'Heure defined Zero Meridian located near Greenwich, England. Some foreign produced maps may use the centesimal (decimal) system of angular measurement (the division of a full circle into 400 grads). A grad (or gon) is divided into 100 centigrads (grad minutes), and each centigrad into 100 deci-milligrads (grad seconds). Other prime meridians may be used in non-U.S. mapping.

2-1.4 Grids are applied to maps to provide a rectangular system for referencing and making measurements. There is a definite relationship between the grid and the graticule so that a corresponding geographic position can be determined for each grid position.

2-2 HORIZONTAL DATUMS.

The identification, pertinent descriptive information, parameters, and attendant explanatory footnotes for some geodetic datums currently in use are contained in table 1. The datums preferred for use in the production of new and revised topographic maps, joint operations graphics, and selected large scale nautical charts are shown in Appendix D which also graphically depicts their areas of application.

2-3 TRANSFORMING COORDINATES FROM ONE HORIZONTAL DATUM TO
ANOTHER HORIZONTAL DATUM.

2-3.1 Coordinates may be transformed from one geodetic datum to another geodetic datum by using the Abridged Molodenskiy Datum Transformation Formulas:

$$\Delta\phi'' = [-\Delta X \sin\phi \cos\lambda - \Delta Y \sin\phi \sin\lambda + \Delta Z \cos\phi + (a\Delta f + f\Delta a)\sin 2\phi] / [R_M \sin 1'']$$

$$\Delta\lambda'' = [-\Delta X \sin\lambda + \Delta Y \cos\lambda] / [R_N \cos\phi \sin 1'']$$

$$\Delta H = \Delta X \cos\phi \cos\lambda + \Delta Y \cos\phi \sin\lambda + \Delta Z \sin\phi + (a\Delta f + f\Delta a)\sin^2\phi - \Delta a$$

where

ϕ = geodetic latitude.

λ = geodetic longitude

H = the distance of a point above or below the ellipsoid measured along the ellipsoid normal through the point.

(2-3.1 is continued on page 2-5)

NO.	DATUM	AREA	DATUM POINT	LATITUDE (ϕ)	LONGITUDE (λ)	ELLIPSOID
1	World Geodetic System 1984	Sino-Soviet Bloc, S.W. Asia, Hydrographic, Aeronautical	Earth center of mass			World Geodetic System 1984 ¹
2	North American 1983	Canada, Cuba, U.S. and Possessions in the Caribbean	Earth center of mass			GRS 80
3	North American 1927	North Greenland	Meades Ranch	39°13'26.686"N	98°32'30.506"W	Clarke 1866
4	Gornoq	Greenland	Station 7008	64°31'06.27"N	51°12'24.86"W	International
5	Hjorsey 1955	Iceland	Hjorsey	64°31'29.260"N	22°22'05.840"W	International
6	Naparima	Trinidad and Tobago	Naparima	10°16'44.86"N	61°27'34.62"W	International
7	Provisional South American 1956	Bolivia, Chile, Columbia, Ecuador, Peru, the Guianas, Venezuela	La Canoa	8°34'17.17"N	63°51'34.88"W	International
8	Corrego Alegre	Brazil	Corrego Alegre	19°50'15.14"S	48°57'42.75"W	International
9	Chua Astro	Paraguay	Chua Astro (Brazil)	19°45'41.16"S	48°06'07.56"W	International
10	Campo Inchauspe	Argentina	Campo Inchauspe	35°58'16.56"S	62°10'12.03"W	International
11	Yacare	Uruguay	Yacare	30°35'53.68"S	57°25'01.30"W	International
12	European 1950	Europe, Middle East, North Africa	Potsdam, Helmerthum	52°22'51.4456"N	13°03'58.9283"E	International
13	Ordnance Survey of Great Britain 1936	Great Britain, Northern Ireland				Airy

Table 1. Geodetic Datums Used in Map Production (page 1 of 3.)

14	Ireland 1965	Ireland						Modified Airy
15	Merchich	Morocco		Merchich		33°26'59.672"N 7°33'27.295"W		Clarke 1880 ³
16	Voirol	Algeria, Tunisia		Voirol Observatory		36°45'07.9"N 3°02'49.45"E		Clarke 1880 ³
17	Adindan	Sudan, Ethiopia		Adindan Z _v		22°10'07.110"N 31°29'21.608"E		Clarke 1880 ³
18	Sierra Leone 1960	Sierra Leone		D.O.S. Astro SLX2		8°27'17.6"N 12°49'40.2"W		Clarke 1880 ³
19	Liberia 1964	Liberia		Robertsfield Astro		6°13'53.02"N 10°21'35.44"W		Clarke 1880 ³
20	Ghana	Ghana		G.C.S. 121 Leigon		5°38'52.27"N 0°11'46.08"W		War Office ⁴ (McCaw)
21	Nigeria	Nigeria		Minna		9°38'08.87"N 6°30'58.76"E		Clarke 1880 ³
22	Arc 1950	Southern Africa		Buffelsfontein		33°59'32.00"S 25°30'44.622"E		Clarke 1880 ³
23	Tananarive (Antananarivo) Obsv. 1925	Malagasy Rep.		Tananarive (Antananarivo) Obsv.		18°55'02.10"S 47°33'06.45"E		International
24	Tokyo	Japan		Tokyo Obsv.		35°39'17.515"N 139°44'40.502"E		Bessel
25	Hu-Tzu-Shan	Taiwan		Hu-Tzu-Shan		23°58'32.340"N 120°58'25.975"E		International
26	Luzon	Philippines		Balanacon		13°33'41.000"N 121°52'03.000"E		Clarke 1866
27	Indonesia 1974	Indonesia		Padang		00°56'38.414"S 100°22'08.804"E		GRS 67
28	Australian Geodetic	Australia		Johnston Memorial Cairn		25°56'54.5515"S 133°12'30.0771"E		Australian National (GRS 67)
29	Geodetic Datum 1949	New Zealand		Papatahi Trig Station		41°19'08.900"S 175°02'51.000"E		International
30	Guam 1963	Marianas Islands		Togcha or Lee 7		13°22'38.490"N 144°45'51.560"E		Clarke 1866
31	Local Astro ⁵	Antarctica		Camp Area Astro		77°50'52.521"S 166°40'13.753"E		Various International
32	Camp Area Astro							

Table 1. Geodetic Datums Used in Map Production – continued.

FOOTNOTES-GEODETTIC DATUMS FOR MAP PRODUCTION

1. The World Geodetic System (WGS) is not referenced to a single datum point. It represents an ellipsoid whose placement, orientation, and dimensions best fit the Earth's equipotential surface which coincides with the geoid. The system was developed from a worldwide distribution of terrestrial gravity measurements and geodetic satellite observations. Several different ellipsoids have been used in conjunction with the various date WGS determinations. The dimensions of the WGS 72 Ellipsoid are:

$$\begin{aligned} a &= 6,378,135 \text{ meters} \\ f &= 1/298.26 \end{aligned}$$

The dimensions of the WGS 84 Ellipsoid are:

$$\begin{aligned} a &= 6,378,137 \text{ meters} \\ f &= 1/298.25722 \text{ 3563} \end{aligned}$$

2. This datum is not defined in terms of an origin. It results from a retriangulation of the area to a number of points whose latitude and longitude were known with respect to Greenwich.

3. The dimensions of the Clarke 1880 Ellipsoid adopted by different countries vary in accordance with which of Clarke's original dimensions are used: (a, b) or (a, f), or which foot-meter relationship is used to convert the units from feet to meters. In the area referenced to Arc 1950 datum, the dimensions adopted are:

$$\begin{aligned} \text{Semimajor axis: } a &= 6,378,249.145326 \text{ meters} \\ \text{Semiminor axis: } b &= 6,356,514.966721 \text{ meters} \end{aligned}$$

The above figures yield:

$$\text{Flattening: } f = 1/293.4663076$$

In the areas of Merchich and Voirol datum, the dimensions adopted are:

$$\begin{aligned} a &= 6,378,249.2 \text{ meters} \\ b &= 6,356,515.0 \text{ meters} \end{aligned}$$

and

$$f = 1/293.46598$$

The values adopted by the Department of Defense are:

$$\begin{aligned} a &= 6,378,249.145 \text{ meters} \\ f &= 1/293.465 \end{aligned}$$

The above figures yield:

$$b = 6,356,514.8696 \text{ meters}$$

4. Dimensions of the War Office Ellipsoid derived by G. T. McCaw (1924) are:

$$\begin{aligned} a &= 6,378,300.58 \text{ meters} \\ f &= 1/296. \end{aligned}$$

5. Local Astro refers to several independently determined datum origins or to areas where maps are positioned by a network of astronomic positions that are not interconnected.

Table 1. Geodetic Datums Used in Map Production – continued.

(2-3.1 is continued from page 2-1)

$\Delta\phi$, $\Delta\lambda$, ΔH = corrections to transform the geodetic coordinates from the input datum to the output datum (output minus input).

ΔX , ΔY , ΔZ = shifts between ellipsoid centers from the input datum to the output datum.

a = semi-major axis of the input ellipsoid.

f = flattening of the input ellipsoid.

Δa , Δf = differences between the parameters of the input ellipsoid and the output ellipsoid (output minus input).

e = eccentricity.

$$e^2 = 2f - f^2$$

R_M = radius of curvature in the meridian. (computed from input ellipsoid)
 $= a(1 - e^2)/(1 - e^2\sin^2\phi)^{3/2}$

R_N = radius of curvature in the prime vertical. (computed from input ellipsoid)
 $= a/(1 - e^2\sin^2\phi)^{1/2}$

$$\sin 1'' = (0.48481\ 36811)(10^{-5})$$

2-3.2 Table 2 (Molodenskiy Transformation Constants to convert from local datum to WGS 84) lists the ΔX , ΔY , ΔZ , Δa , and Δf to transform coordinates from the various datums shown in Appendix D to WGS 84. Values for a and f are listed with figure 1.

2-3.3 The direction of the transformation may be reversed by changing the signs of ΔX , ΔY , ΔZ , Δa , and Δf . Note also that R_M and R_N must be computed with respect to the input ellipsoid.

2-3.4 Transformation procedures and constants are published in DMA TR 8350.2, Department of Defense World Geodetic System 1984.

2-4 ELLIPSOIDS.

2-4.1 Several ellipsoids are presently used in U.S. military mapping. The goal is to eventually refer all positions to the World Geodetic System (WGS), which has a specific set of defining parameters, or to a WGS compatible ellipsoid. Ellipsoids may be defined by a combination of algebraically related dimensions such as the semi-major and semi-minor axes or the semi-major axis and the flattening. Figure 1 illustrates the defining elements and lists the dimensions of the ellipsoids used by the Defense Mapping Agency.

2-4.2 Appendix D (Index of Preferred Grids, Datums, and Ellipsoids Specified for New Mapping) identifies the extent of currently effective ellipsoids.

2-5 PROJECTIONS.

2-5.1 The projections used as the framework of all U.S. military maps and charts have a common characteristic in that they are conformal. Conformality indicates that small areas retain their true shape; angles closely approximate their true values; and, at any point, the scale is the same in all directions.

2-5.2 Certain projections are prescribed for U.S. military topographic mapping and charting that shows military grids:

2-5.2.1 Maps at scales of 1:500,000 and larger for areas between 80° south and 84° north, and some hydrographic charts at 1:50,000 and larger, are based on the Transverse Mercator Projection.

MOLODENSKIY TRANSFORMATION CONSTANTS
LOCAL DATUM TO WGS 84

Datum	ELLIPSOID	ΔX (m)	ΔY (m)	ΔZ (m)	Δa	$\Delta f \times 10^4$
1. North American 1927 except Alaska Alaska	Clarke 1866	-8 -5	160 135	176 172	-69.4	-0.37264 639
2. Old Hawaiian	Clarke 1866	61	-285	-181	-69.4	-0.37264 639
3. Gornoq	International	164	138	-189	-251	-0.14192 702
4. Hjorsey 1955	International	-73	46	-86	-251	-0.14192 702
5. Provisional South American 1956	International				-251	-0.14192 702
Bolivia		-270	188	-388		
Chile		-270	183	-390		
Colombia		-282	169	-371		
Ecuador		-278	171	-367		
Guyana		-298	159	-369		
Venezuela		-295	173	-371		
Peru		-279	175	-379		
6. Carrego Alegre	International	-206	172	-6	-251	-0.14192 702
7. Chua Astro	International	-134	229	-29	-251	-0.14192 702
8. Campo Inchauspe	International	-148	136	90	-251	-0.14192 702
9. Yacare	International	-155	171	37	-251	-0.14192 702
10. European 1950 except Iberia Iberia	International	-87 -88	-96 -109	-120 -122	-251	-0.14192 702
11. Ordnance Survey of Great Britain 1936	Airy	375	-111	431	573.604	0.11960 023
12. Ireland 1965	Mod. Airy	506	-122	611	796.811	0.11960 023
13. Merchich	Clarke 1880	31	146	47	-112.145	-0.54750 714
14. Adindan Ethiopia Sudan	Clarke 1880	-165 -161	-11 -14	206 205	-112.145	-0.54750 714

Table 2. Molodenskiy Transformation Constants to Convert From Local Datum to WGS 84 (page 1 of 3).

15. Liberia	Clarke 1880	-90	40	88	-112.145	-0.54750 714
16. Minna	Clarke 1880	-92	-93	122	-112.145	-0.54750 714
17. Arc 50	Clarke 1880				-112.145	-0.54750 714
Botswana		-138	-105	-289		
Kenya		-161	-7	-300		
Lesotho		-125	-108	-295		
Uganda		-158	-12	-299		
Zaire		-169	-19	-278		
Zambia		-147	-74	-283		
Zimbabwe		-142	-96	-293		
18. Tananarive Obsv. 1925	International	-189	-242	-91	-251	-0.14192 702
19. Tokyo	Bessel 1841	-128	481	664	739.845	0.10037 483
20. Hu-Tzu-Shan	International	-634	-549	-201	-251	-0.14192 702
21. Luzon	Clarke 1866	-133	-77	-51	-69.4	-0.37264 639
22. Kertau 1948	Mod. Everest	11	851	5	832.937	0.28361 368
23. Timbalai 1948	Everest	-689	691	-46	860.655	0.28361 368
24. Djakarta	Bessel 1841	-377	681	-50	739.845	0.10037 483
25. Bukit Rimpah	Bessel 1841	-384	664	-48	739.845	0.10037 483
26. Gunung Segara	Bessel 1841	-403	684	41	739.845	0.10037 483
27. Australian Geodetic 1966	Australian Nat.	-133	-48	148	-23	-0.00081 204
28. Geodetic Datum 1949	International	84	-22	209	-251	-0.14192 702
29. Guam 1963	Clarke 1866	-100	-248	259	-69.4	-0.37264 639
30. Local Astro						
Naparima	International	-2	374	172	-251	-0.14192 702
Trinidad and Tobago						

Transformations are not available for areas referenced to multiple astronomic stations.
When a single astronomic station is used, a transformation may be possible, such as:

Table 2. Molodenskiy Transformation Constants to Convert From Local Datum to WGS 84 - continued.

31. Camp Area Astro International -104 -129 239 -251 -0.14192 702

Note: These shift constants are the best available at the time of publication.
The latest values may be obtained from DMA, ATTN: PR.

Table 2. Molodenskiy Transformation Constants to Convert From Local Datum to WGS 84 -- continued.

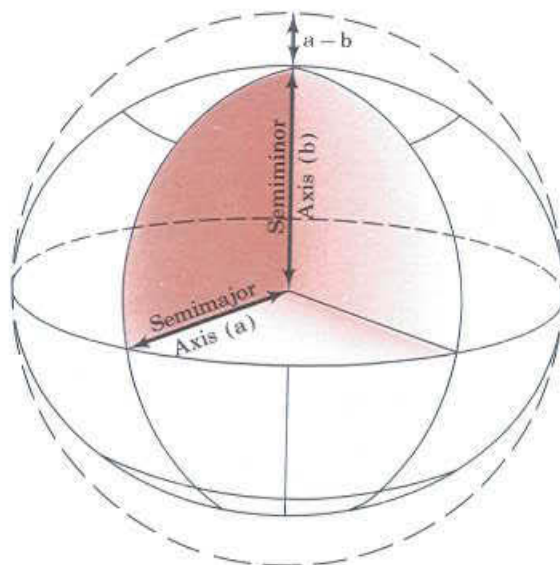

<u>ELLIPSOID</u>	<u>SEMI-MAJOR AXIS (a)</u>	<u>SEMI-MINOR AXIS (b)</u>	<u>1/f¹</u>
AIRY	6,377,563.396	6,356,256.910	299.32496 46
AUSTRALIAN NATIONAL OR SOUTH AMERICAN 1969	6,378,160	6,356,774.7192	298.25
BESSEL 1841	6,377,397.155	6,356,078.9629	299.15281 28
CLARKE 1866	6,378,206.4	6,356,583.8	294.97869 82
CLARKE 1880	6,378,249.145	6,356,514.8696	293.465
EVEREST	6,377,276.34518	6,356,075.41511	300.8017
GEODETIC REFERENCE SYSTEM 1980 ²	6,378,137	6,356,752.3141	298.25722 2101
INTERNATIONAL	6,378,388	6,356,911.9462	297
MODIFIED AIRY	6,377,340.189	6,356,034.446	299.32496 46
MODIFIED EVEREST ³	6,377,304.063	6,356,103.039	300.8017
WORLD GEODETIC SYSTEM 1972	6,378,135	6,356,750.5	298.26
WORLD GEODETIC SYSTEM 1984	6,378,137	6,356,752.3142	298.25722 3563

¹ The flattening $f=(a-b)/a$. It is normally expressed by the reciprocal $1/f$.

² For cartographic purposes, the GRS 80 and WGS 84 ellipsoids are interchangeable.

³ This ellipsoid has the same flattening as the Everest Ellipsoid, but a slightly larger axis (28 meters) because of the difference between foot-meter relationships used in Malaysia and the one used in India.

Figure 1. Defining parameters of ellipsoids.

2-5.2.2 Maps at 1:1,000,000 scale between 80° south and 84° north, some hydrographic charts, and aeronautical charts at 1:500,000 between 80° south and 80° north, are based on the Lambert Conformal Conic Projection.

2-5.2.3 Maps at 1:1,000,000 scale and larger of the polar regions (south of 80° south and north of 84° north), some hydrographic charts smaller than 1:50,000 and at latitude between 70° and the poles, and aeronautical charts at 1:500,000 north of 80° north or south of 80° south, are based on the Polar Stereographic Projection.

2-5.2.4 Coastal charts at 1:75,000 scale and smaller are based on the Mercator Projection.

2-5.2.5 General maps at scales smaller than 1:1,000,000 are based on projections individually selected to conform with the intended use of the map. Because of their variety, complexity, and limited use, such projections are not described in this manual.

2-5.2.6 Maps produced by coproducing nations in non-U.S. areas of responsibility may be based on other projections such as the Transverse Mercator Projection, the Lambert Conical Orthomorphic Projection (Lambert Conformal Conic Projection), Laborde Projection, New Zealand Map Grid Projection, the Rectified Skew Orthomorphic Projection, etc.

2-5.3 The following paragraphs contain concepts of some of the prescribed projections; in practice, however, the projections are reduced to a plane surface by use of mathematical formulas. (See Chapter 1 for references to mathematical tables.) Figures 2, 3, 4, 5, and 6 are provided as an aid in the understanding of these concepts.

2-5.4 The Mercator Projection is not normally used for military topographic maps; however, it is used extensively for naval ocean navigation and bathymetric charts. Its description also serves as a basis for understanding the Transverse Mercator Projection. The Mercator Projection can be visualized as an ellipsoid projected onto a cylinder with tangency established at the Equator and with the polar axis of the ellipsoid in coincidence with the cylinder axis as shown in figure 2. The origins of the projection lines vary and are about three-quarters of the way back along the diameters in the equatorial plane. When the cylinder is opened and flattened, a distortion appears in the polar regions, in as much as the line representing the Equator is the true distance and each parallel is represented by a line as long as the Equator. The poles are infinitely distant from the Equator and can not be shown on the projection. Distortion becomes more pronounced as the distance north and south of the Equator increases. For example, the map scale at 60° north and 60° south is approximately twice that at the Equator.

2-5.5 A Transverse Mercator Projection is a Mercator Projection where the cylinder has been rotated or transversed 90°. The ellipsoid and cylinder are thus tangent along a meridian. By projecting the surface of the ellipsoid onto the cylinder, as shown in figure 3, in the same manner as for the Mercator Projection, the Transverse Mercator Projection is developed on the surface of the cylinder, which is then opened and flattened.

2-5.5.1 Distortion - The east and west extremities appear distorted at the outer edges when projected onto a cylinder. The two shaded areas of figure 3 show the varying distortion of two equivalent geographic areas on the same projection. Note that both areas extend 15° in longitude within the 30° to 45° south latitude band. The area bounded by the 30° and 45° east meridians is greatly magnified in comparison to the area bounded by the 90° and 105° east meridians. When a meridian is tangent to the cylinder of projection, there is no distortion along that meridian. Distances along the tangent meridians are true distances, and all distances within 3° of the meridians are relatively accurate. Therefore, to minimize distortion, the Transverse Mercator Projection, for military purposes, uses 60 longitudinal zones, each zone 6° wide. For example, a zone centered on 3° (central meridian) is bounded by the 0° and 6° meridians, and a zone centered on 9° is bounded by the 6° and 12° meridians.

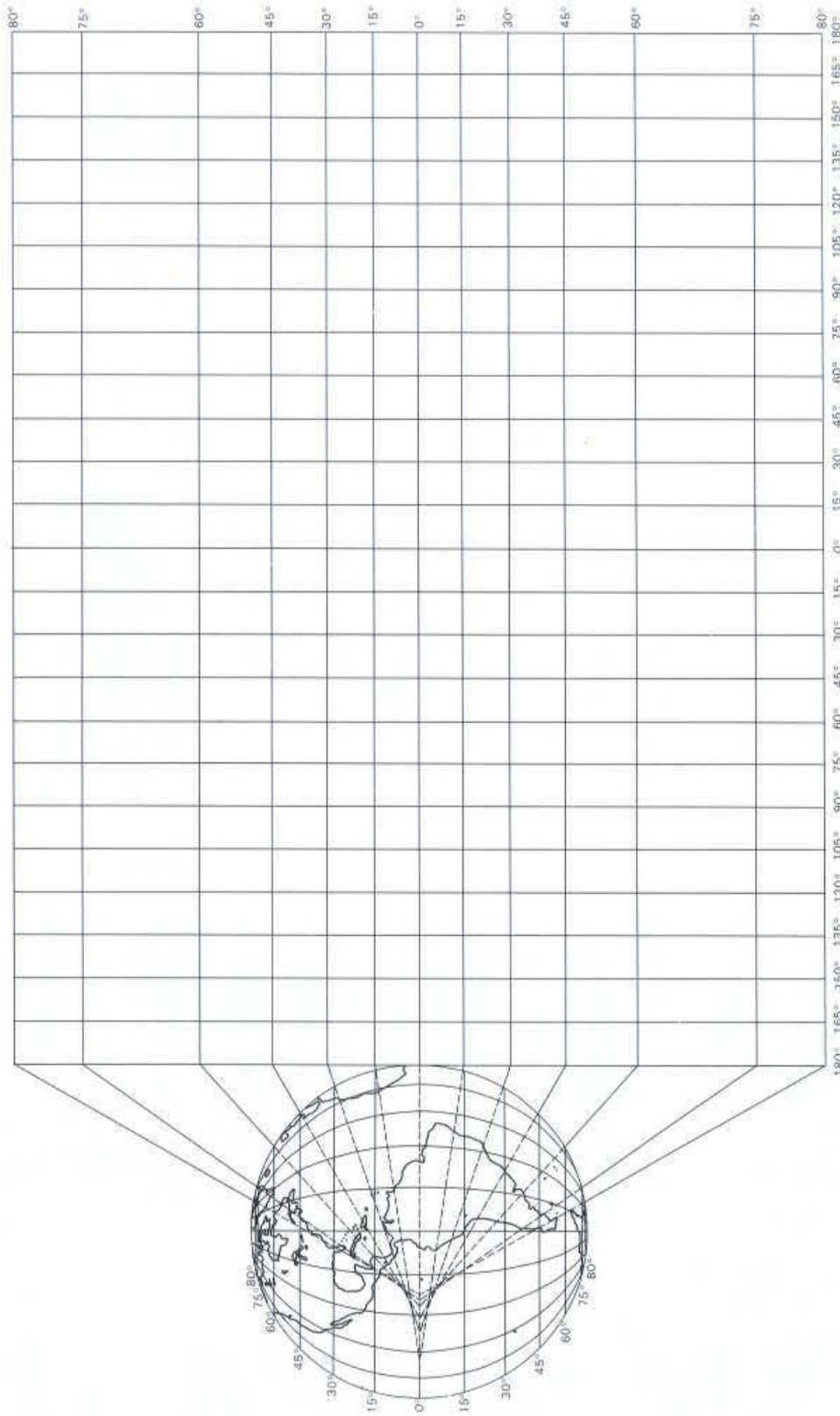

Figure 2. Mercator Projection.

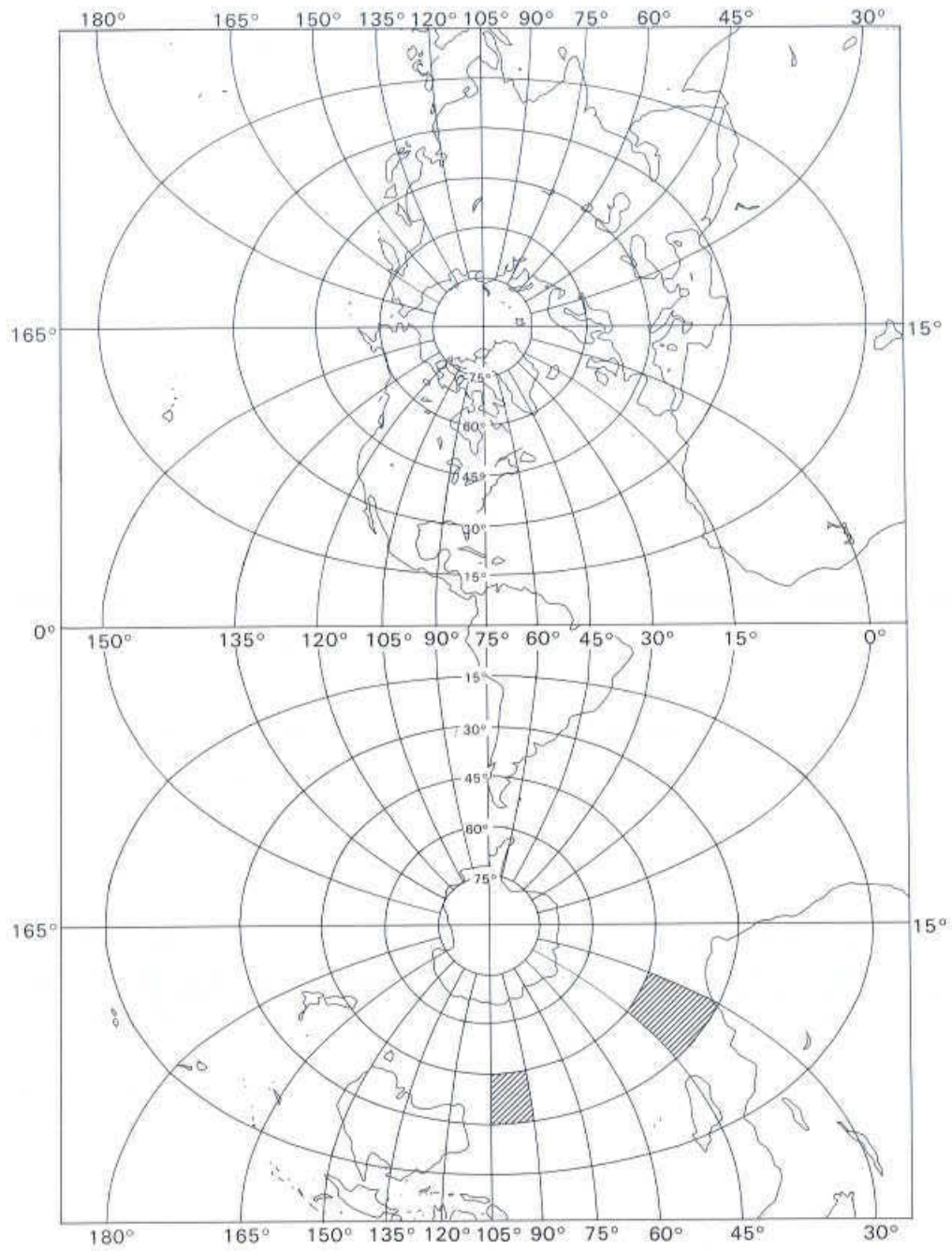
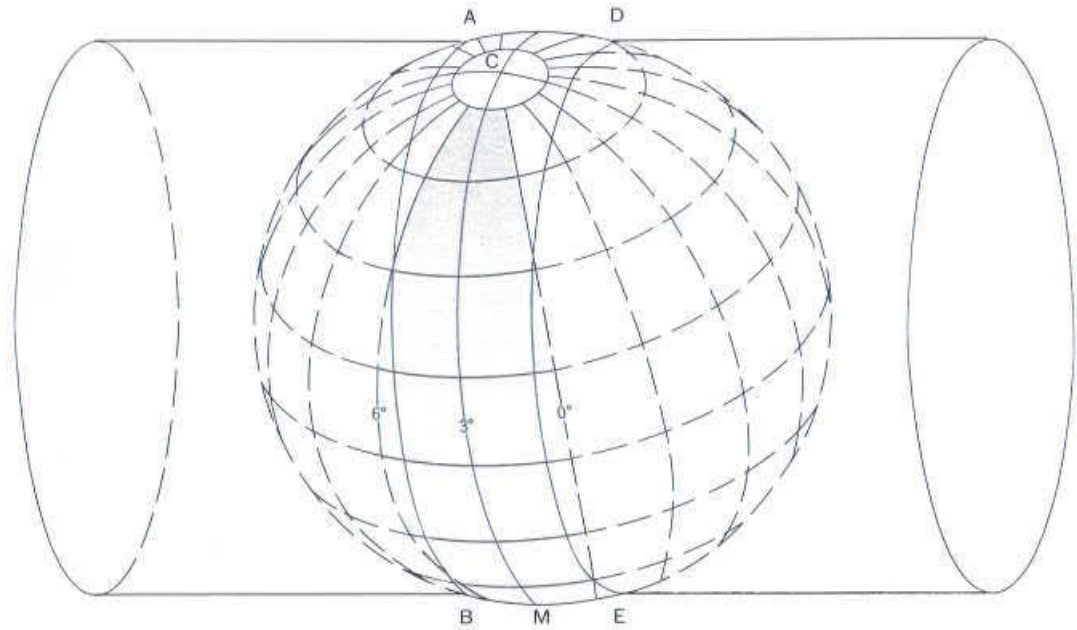

Figure 3. Transverse Mercator Projection



CM—Central meridian
 AB, DE—Lines of secancy formed
 by intersections of
 cylinder and ellipsoid

(Size and shape of zones are exaggerated
 for illustration purposes)

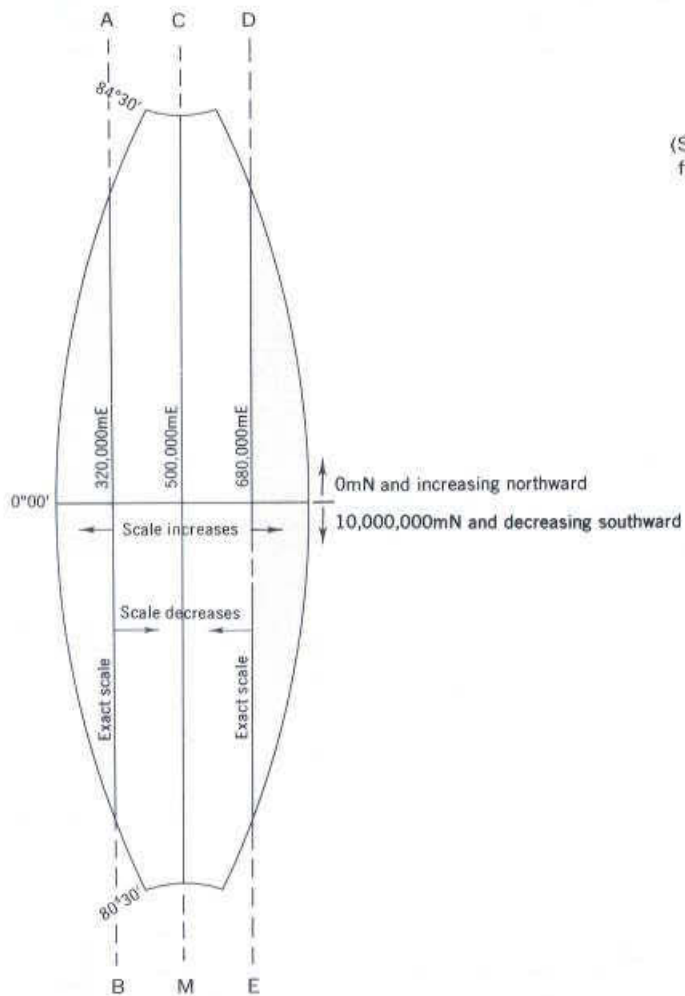

Figure 4. Secant Condition of Transverse Mercator Projection; Typical 6-degree Projection Zone.

2-5.5.2 Secant condition - The cylinder of projection is modified by reducing its elliptical dimensions and making it secant to the ellipsoid, intersecting the ellipsoid along lines parallel to the central meridian (fig. 4). For the Universal Transverse Mercator grid this condition establishes, in one 6° zone, two lines of secancy approximately 180,000 meters east and west of the central meridian. These lines of secancy, in effect, allow a more congruous relationship between ellipsoid and map distances than that of the central meridian tangency. Since the central meridian of all zones is given a false easting value of 500,000 meters east (mE), the secant lines have coordinates of approximately 320,000 mE and 680,000 mE respectively. Figure 4 also gives a schematic representation of the scale distortion in any 6° zone. Note that the scale of the projection at the lines of secancy is exact.

2-5.5.3 Scale factor - For most military operations, map and ground distances are assumed to be equivalent. However, in certain geodetic and artillery operations, where long distances are involved and accuracy of results is essential, it is necessary to correct for the difference between distances on the map and distances on the ground. This is done by the use of scale factors from prepared tables or by formula. For the Transverse Mercator Projection, the scale factor is 1.00000 (unity) at the lines of secancy, decreasing inwardly to 0.9996 at the central meridian, and increasing outwardly to about 1.0010 near the zone boundaries at the equator.

2-5.6 The Polar Stereographic Projection, a conformal azimuthal projection, is similar in both the northern and southern polar regions. The projection is developed on a plane tangent at a pole with the projection lines originating from the opposite pole. The plane is perpendicular to the minor axis, as shown in figure 5. For use with the Universal Polar Stereographic grid, a scale factor of 0.994 is applied at the origin (pole) to lower the plane of projection to intersect the sphere at approximately $81^\circ 07'$ latitude. This arbitrary geometry is applied to reduce the maximum scale distortion of the tangent projection. As shown in figure 5, the scale is exact (unity scale factor) at approximately $81^\circ 07'$ latitude. The scale factor decreases to 0.994 at the pole, increases to 1.0016076 at $80^\circ 00'$ and attains its maximum value of 1.0023916 at $79^\circ 30'$. The scale factor is constant along any given parallel.

2-5.7 The Lambert Conformal Conic Projection can be visualized as the projection of the ellipsoid onto a cone whose axis coincides with the polar axis of the ellipsoid as in figure 6. Usually, the cone is secant to the ellipsoid, intersecting along two parallels of latitude. These two parallels are called standard parallels. Meridians appear as straight lines radiating from a point beyond the mapped areas. Parallels appear as arcs of concentric circles which are centered at the point from which the meridians radiate. None of the parallels appear in exactly the projected positions; they are mathematically adjusted to produce the property of conformality. This adjustment is slight if the standard parallels are sufficiently close together.

2-5.8 The characteristics of prescribed projections are tabulated in table 3.

2-6 MILITARY GRIDS.

2-6.1 Military grids consist of parallel lines intersecting at right angles and forming a regular series of squares. The north-south lines are called eastings and the east-west lines northings. Each grid line is one of an even-interval selection of measurement units. The

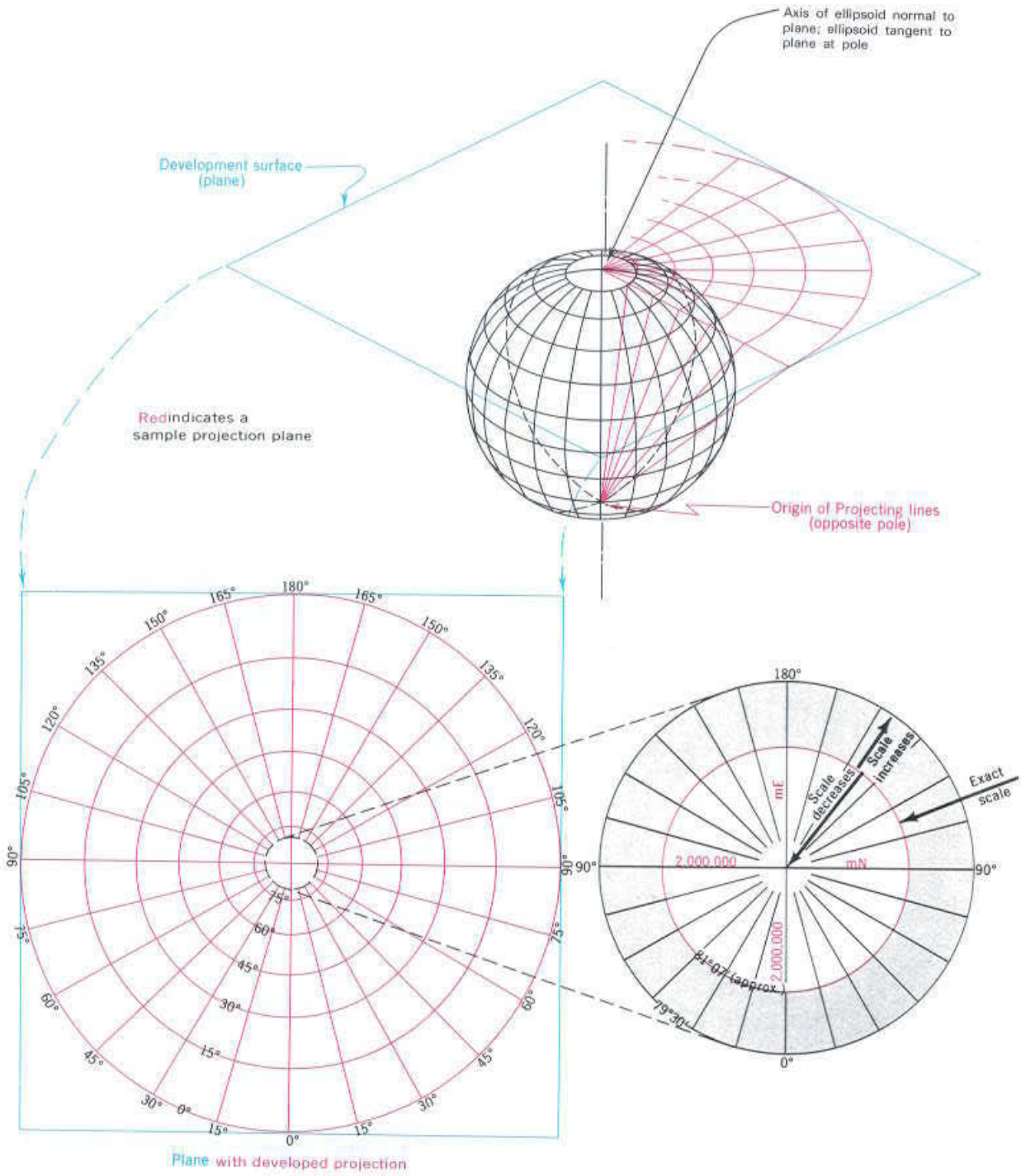

Figure 5. Polar Stereographic Projection.

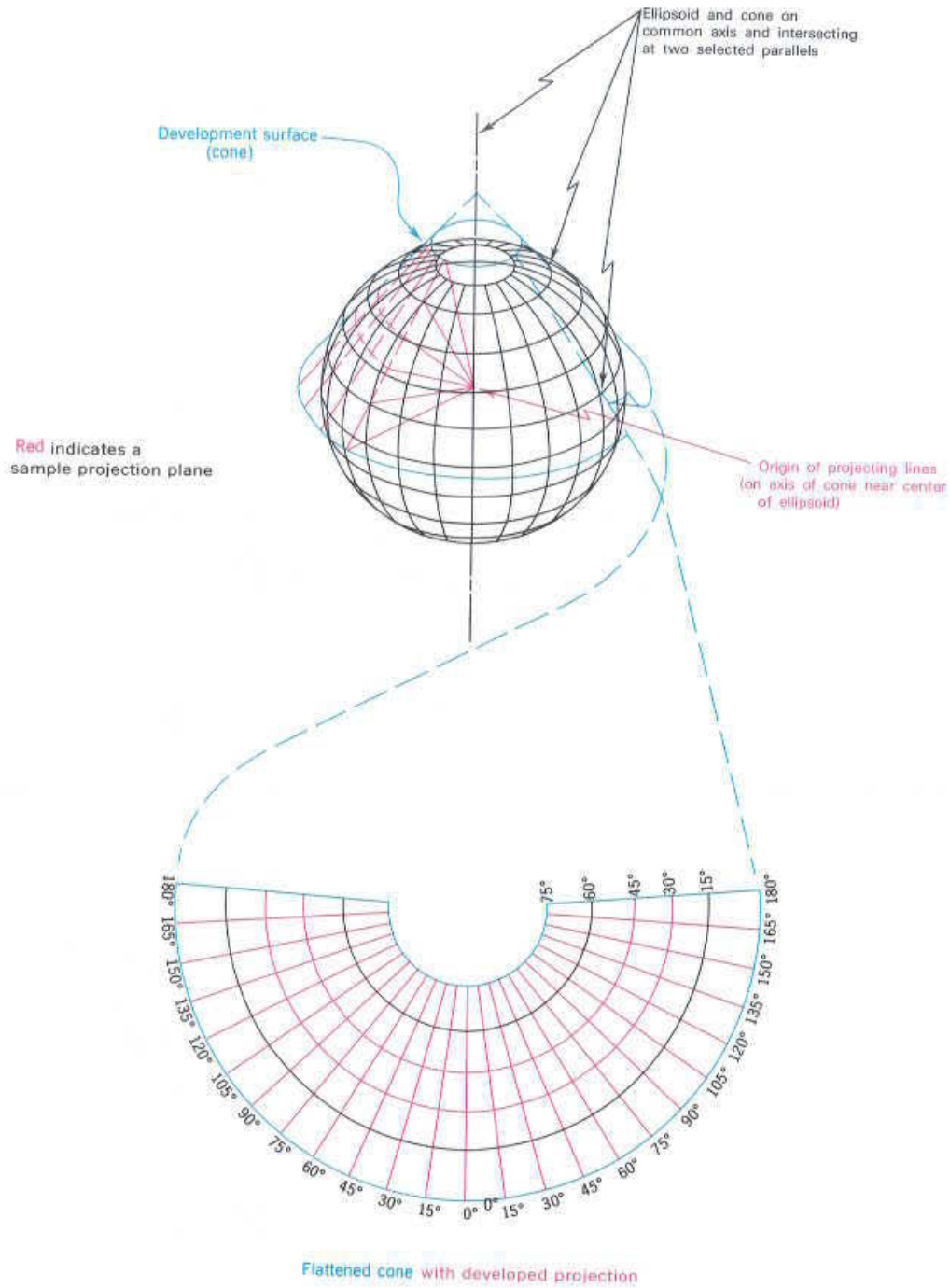

Figure 6. Lambert Conformal Conic Projection.

CHARACTERISTICS	TRANSVERSE MERCATOR	POLAR STEREOGRAPHIC	LAMBERT CONFORMAL CONIC	MERCATOR
Origin of Projection Lines	a point on the diameter varying with the latitude, between the center and the opposite side	opposite pole	axis of cone near center of ellipsoid	a point on the diameter varying with the latitude, between the center and the opposite side
Development Surface	cylinder	plane	cone	cylinder
Tangency	central meridian	pole	central parallel	equator
Secancy	two eastings equidistant from the central meridian	concentric circle of unity scale factor	two standard parallels of unity scale factor	two standard parallels equidistant from the equator
Parallels	equator is a straight line; all others are curves concave toward the nearest pole	concentric circles unequally spaced	arcs of concentric circles whose spacing increases away from the central parallel	unequally spaced straight lines, closest near the equator
Meridians	central meridian is a straight line; all others are curved lines, concave toward the central meridian	straight lines radiating from the pole	straight lines converging on the projected polar axis	equally spaced straight lines
Scale Distortion	tangent – increases away from central meridian; secant – increases outward from secancy, decreases toward central meridian (see figure 4)	tangent – increases away from pole; secant – increases toward equator, decreases toward pole (see figure 5)	increases outward from standard parallel(s); decreases between standard parallels	tangent – increases away from the equator; secant – increases outward from secancy, decreases toward equator
Rhumb Line	curved line	curved line	curved line	straight line
Great Circle	curved line except central meridian and equator	straight line when through pole, all others are curved	approximate a straight line when between standard parallels	curve line
Use	topographic – 1:500,000 and larger hydrographic – 1:50,000 and larger aeronautical – 1:250,000	topographic, hydrographic aeronautical	topographic – 1:1,000,000 and smaller aeronautical – 1:500,000 and smaller	hydrographic

Table 3. Characteristics of projections.

interval is selected in accordance with the map scale. The unit intervals shown on military map scales are:

MAP SCALES	UNIT INTERVALS
1:12,500	1,000
1:25,000	1,000
1:50,000	1,000
1:100,000	1,000 or 10,000
1:250,000	10,000
1:500,000	10,000
1:1,000,000	100,000 with ticks at 10,000

Table 4. Grid Unit Intervals for Various Scale Topographic Maps.

2-6.2 The grids preferred for military maps are:

2-6.2.1 Universal Transverse Mercator (UTM) grid for areas between 80° south and 84° north.

2-6.2.2 Universal Polar Stereographic (UPS) grid for the polar regions south of 80° south and north of 84° north.

2-6.2.3 Other grids for certain parts of the world as shown in Appendix D. These grids are being progressively replaced by the UTM grid, with the intent to eventually cover all military mapping of the world with a universal metric grid system.

2-6.2.4 Area of application for the various other grids are given in Appendix D. A general description of the grids and numbering systems is given in Chapter 4.

2-6.3 Specifications for the Universal Grid Systems follow:

2-6.3.1 Universal Transverse Mercator (UTM) Grid.

Projection: Transverse Mercator (Gauss-Kruger type) in zones 6° wide.

Ellipsoid:

- International
- Bessel 1841
- World Geodetic System 1984
- Geodetic Reference System (GRS 1980)

Longitude of Origin: Central meridian (CM) of each projection zone (3°, 9°, 15°, 21°, 27°, 33°, 39°, 45°, 51°, 57°, 63°, 69°, 75°, 81°, 87°, 93°, 99°, 105°, 111°, 117°, 123°, 129°, 135°, 141°, 147°, 153°, 159°, 165°, 171°, 177°, E and W).

Latitude of Origin: 0° (the Equator).

Unit: Meter.

False Northing: 0 meters at the Equator for the Northern Hemisphere; 10,000,000 meters at the Equator for the Southern Hemisphere.

False Easting: 500,000 meters at the CM of each zone.

Scale Factor at the Central Meridian: 0.9996.

Grid Zone Designations: See Chapter 3 and Appendix B.

Latitude Limits of System: From 80°S to 84°N.

Limits of Projection Zones: The zones are bounded by meridians, the longitudes of which are multiples of 6° east and west of the prime meridian.

Overlap: On large-scale maps and trig lists, the data for each zone, datum, or ellipsoid overlaps the adjacent zone, datum, or ellipsoid a minimum of 40 kilometers. The UTM grid extends to 80°30'S and 84°30'N, providing a 30-minute overlap with the UPS grid.

2-6.3.2 Universal Polar Stereographic (UPS) Grid.

Projection: Polar Stereographic.

Ellipsoid: World Geodetic System 1984

Longitude of Origin: 0° and 180°E-W.

Latitude of Origin: 90°N and 90°S.

Unit: Meter.

False Northing: 2,000,000 meters.

False Easting: 2,000,000 meters.

Scale Factor at the Origin: 0.994.

Grid Zone Designations: See Chapter 3 and Appendix B.

Limits of System:

North Zone: Polar area north of 84°N.

South Zone: Polar area south of 80°S.

Overlap: The UPS grid extends to 83°30'N and 79°30'S, providing a 30-minute overlap with the UTM grid.

2-6.4 Formulas for constructing UTM and UPS grids are contained in DMA TM 8358.2.

2-7 TRANSFORMING COORDINATES FROM ONE GRID SYSTEM TO ANOTHER GRID SYSTEM.

Coordinates may be transformed from one grid system to another grid system, for instance, between a Lambert grid and a UTM grid or between different grid zones. The preferred procedure is to transform the grid coordinates from the first grid system to geographic positions. Then transform the geographic positions to grid coordinates of the second grid system. Note: This procedure does not change the datum. See paragraph 2-3 for the procedure to use when changing from one datum to another datum.

CHAPTER 3

THE U.S. MILITARY GRID REFERENCE SYSTEM (MGRS)

3-1 GENERAL DESCRIPTION.

3-1.1 The U.S. Military Grid Reference System (MGRS) is designed for use with the UTM and UPS grids.

3-1.2 For convenience, the world is generally divided into 6° by 8° geographic areas, each of which is given a unique identification, called the Grid Zone Designation (fig. 7). These areas are covered by a pattern of 100,000-meter squares. Each square is identified by two letters called the 100,000-meter square identification. This identification is unique within the area covered by the Grid Zone Designation. Exceptions to this general rule have been made in the past to preserve the 100,000-meter identifications on mapping that already exists. Appendix B shows the method for finding the 100,000-meter square identifications.

3-1.3 A reference keyed to a gridded map of any scale is made by giving the 100,000-meter square identification together with the numerical location. Numerical references within the 100,000-meter square are given to the desired accuracy in terms of the easting (E) and northing (N) grid coordinates for the point. The Grid Zone Designation usually is prefixed to the identification when references are made in more than one grid zone designation area.

3-2 THE GRID ZONE DESIGNATION.

3-2.1 An MGRS position location uses the standard military practice of reading "right (easting) and up (northing)". In each portion of a military grid reference (grid zone designation, 100,000-meter square identification, and grid coordinates), the first part provides the easting component and the second part provides the northing component.

3-2.2 The MGRS is an alphanumeric version of a numerical UTM or UPS grid coordinate.

3-2.2.1 For that portion of the world where the UTM grid is specified (80° south to 84° north), the UTM grid zone number is the first element of a Military Grid reference. This number sets the zone longitude limits. Zone 32 has been widened to 9° (at the expense of zone 31) between latitudes 56° and 64° to accommodate southwest Norway. Similarly, between 72° and 84°, zones 33 and 35 have been widened to 12° to accommodate Svalbard. To compensate for these 12° wide zones, zones 31 and 37 are widened to 9° and zones 32, 34, and 36 are eliminated.

3-2.2.2 The next element is a letter which designates a latitude band. Beginning at 80° south and proceeding northward, twenty bands are lettered C through X, omitting I and O. The bands are all 8° wide except for band X which is 12° wide. Thus, in the UTM portion of the MGRS, the first three characters designate one of the 1197 areas with the dimensions as shown in Table 5.

3-2.2.3 In the Polar regions, there is no zone number. A single letter designates the semi-circular area and hemisphere. Since the letters A, B, Y, and Z are used only in the Polar regions, their presence in an MGRS, with the omission of a zone number, designates that the coordinates are UPS.

3-2.3 The grid zones are divided into a pattern of 100,000-meter grid squares forming

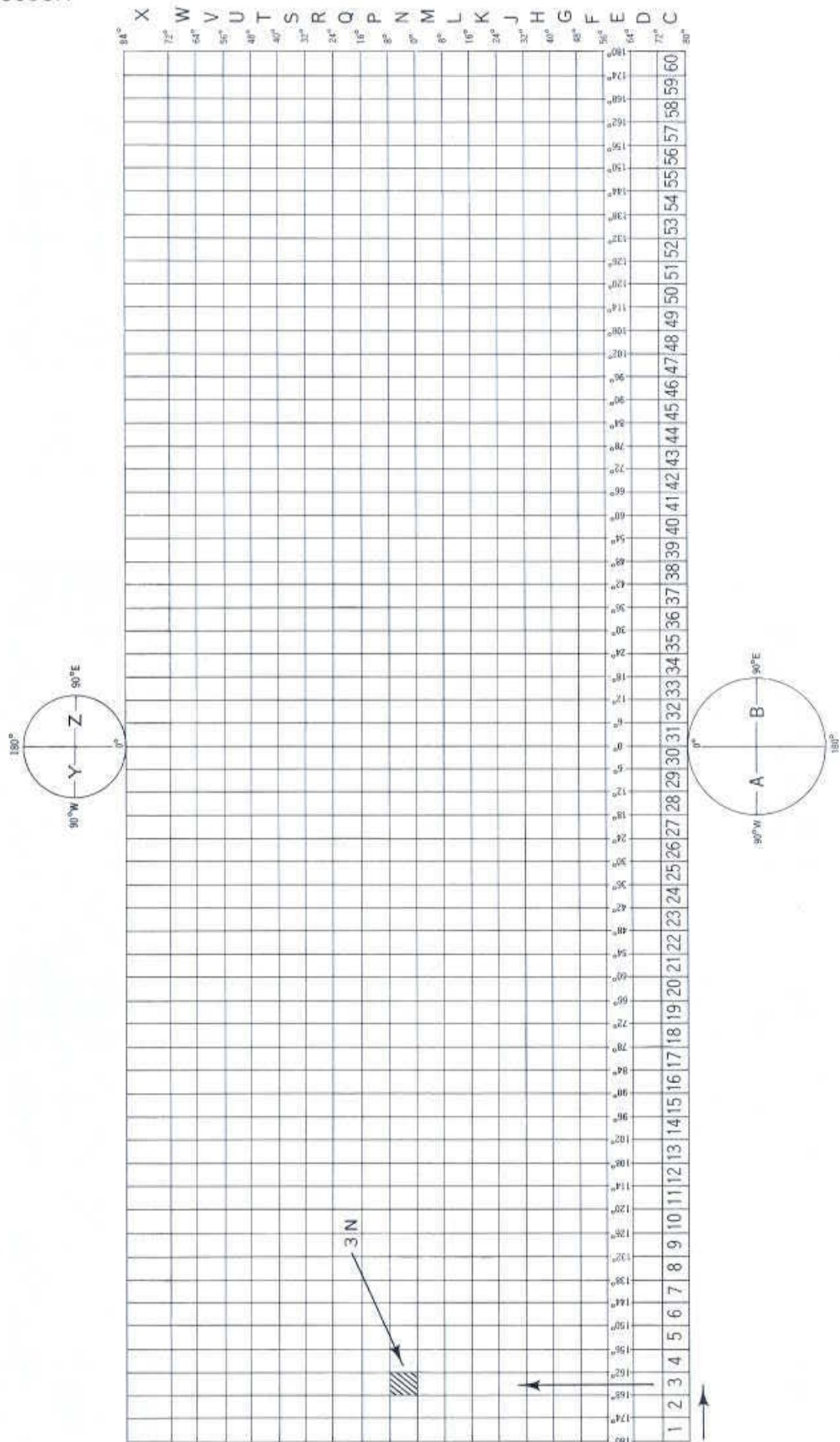

Figure 7. Grid Zone Designations of the Military Grid Reference System.

a matrix of rows and columns. Each row and each column is sequentially lettered such that two letters provide a unique identification, within approximately 9°, for each 100,000-meter grid square. Appendix B provides the location and identification of the grid zones and 100,000-meter grid squares.

Latitude	Longitude	Number
8°	6°	1138
8°	9°	1
8°	3°	1
12°	6°	53
12°	9°	2
12°	12°	2

Table 5. Dimensions of Grid Zone Designation Areas.

3-2.3.1 For many years efforts have been made to reduce the complexity of grid reference systems by standardization to a single world-wide grid reference system. This effort is continuing and will generate additional changes to Appendixes B and D.

3-2.3.2 The remainder of this chapter describes the determination of the 100,000-meter square identification, and the military grid reference.

3-3 100,000-METER SQUARE IDENTIFICATION.

3-3.1 The 100,000-meter columns, including partial columns along zone, datum, and ellipsoid junctions, are lettered alphabetically, A through Z (with I and O omitted), north and south of the Equator, starting at the 180° meridian and proceeding easterly for 18°. The alphabetical sequence repeats at 18° intervals.

3-3.2 To prevent ambiguity of identifications along ellipsoid junctions, changes in the order of the row letters are necessary. The row alphabet (second letter) is shifted ten letters. This decreases the maximum distance in which the 100,000-meter square identification is repeated.

3-3.3 The 100,000-meter row lettering is based on a 20-letter alphabetical sequence (A through V with I and O omitted). This alphabetical sequence is read from south to north, and repeated at 2,000,000-meter intervals from the Equator.

3-3.3.1 The row letters in each odd-numbered 6° grid zone are read in an A through V sequence from south to north.

3-3.3.2 In each even-numbered 6° grid zone, the same lettering sequence is advanced five letters to F, continued sequentially through V and followed by A through V.

3-3.3.3 The advancement or staggering of row letters for the even-numbered zones lengthens the distance between 100,000-meter squares of the same identification.

3-3.4 Users are cautioned that deviations from the preceding rules were made in the past. These deviations were an attempt to provide unique grid references within a complicated and disparate world-wide mapping system.

3-3.5 Determination of 100,000-meter grid square identification is further complicated by the use of different ellipsoids. Figure 8 shows the basic lettering system. Appendix B provides detailed guidance for finding the correct identification in each ellipsoid area.

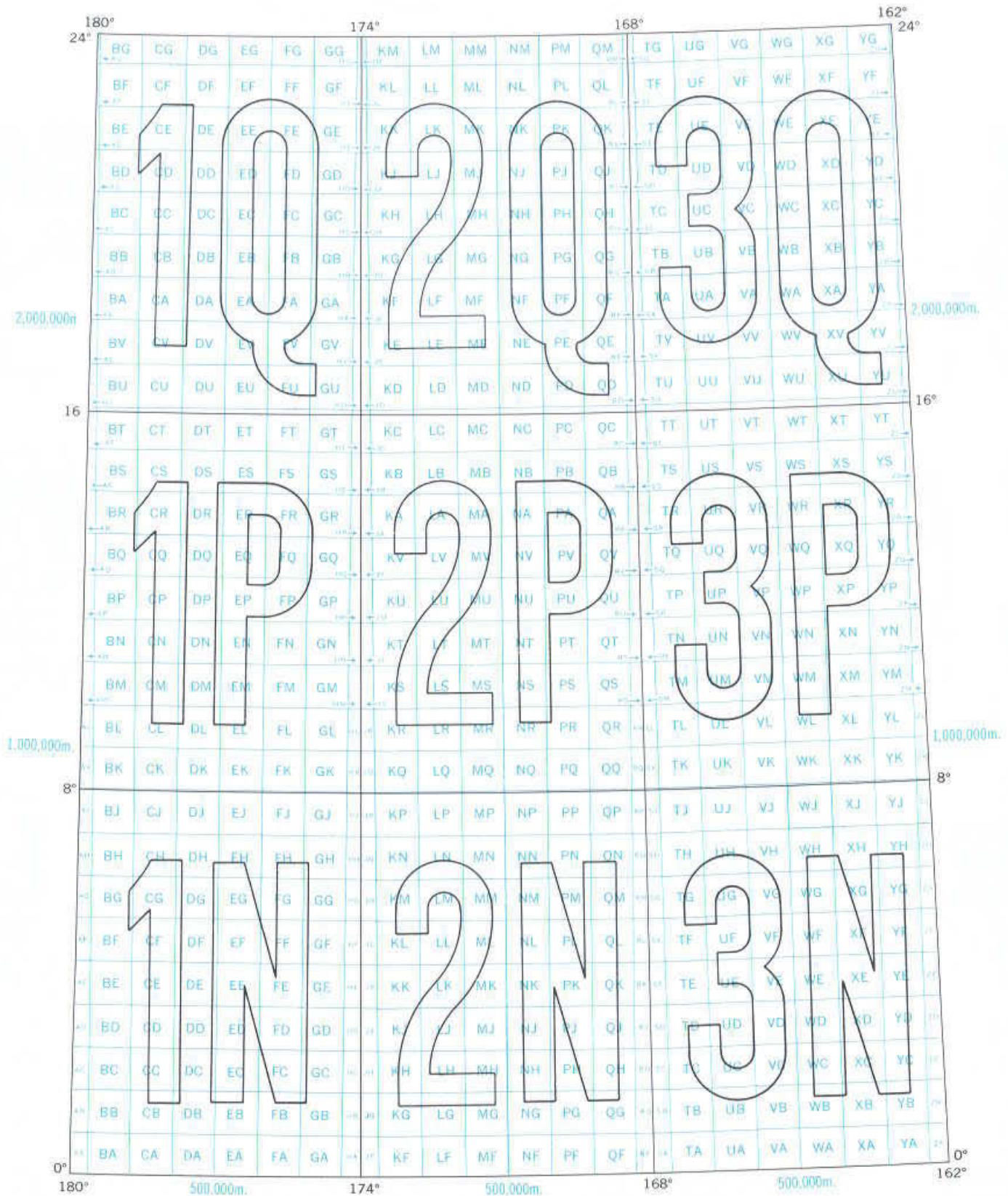

Figure 8. Basic Plan of the 100,000-meter Square Identifications of the U.S. Military Grid Reference System, Between 84°N. and 80°S.

3-4 THE MILITARY GRID REFERENCE.

3-4.1 The MGRS coordinate for a position consists of a group of letters and numbers which include the following elements:

3-4.1.1 The Grid Zone Designation.

3-4.1.2 The 100,000-meter square letter identification.

3-4.1.3 The grid coordinates (also referred to as rectangular coordinates); the numerical portion of the reference expressed to a desired refinement.

3-4.2 A reference is written as an entity without spaces, parentheses, dashes, or decimal points.

Examples

18S (Locating a point within the Grid Zone Designation)

18SUU (Locating a point within a 100,000-meter square)

18SUU80 (Locating a point within a 10,000-meter square)

18SUU8401 (Locating a point within a 1,000-meter square)

18SUU836014 (Locating a point within a 100-meter square)

3-4.3 To satisfy special needs, a reference can be given to a 10-meter square and a 1-meter square as:

18SUU83630143 (Locating a point within a 10-meter square)

18SUU8362601432 (Locating a point within a 1-meter square)

3-5 MGRS APPLICATION.

3-5.1 All elements of a grid reference need not be used. Their use depends upon the size of the area of activities, the type of military operations, and the scale of the map to which the reference is keyed. The military area commander usually designates the elements of the grid references to be used. The following paragraphs provide guidance for the use of Grid Zone Designations and 100,000-meter square identifications.

3-5.1.1 For military operations spanning large geographical areas, the Grid Zone Designation is usually given (such as 18S). This designation will alleviate ambiguity between identical references that may occur when reporting to a station outside the area. The Grid Zone Designation is always used in giving references on 1:1,000,000 scale and 1:500,000 scale maps.

3-5.1.2 For operational areas of lesser extent, but exceeding 100,000 meters, the 100,000-meter square identification is used (such as UU80). The 100,000-meter square identification is used in reporting references on the 1:250,000 and larger scale maps to avoid ambiguity between identical references which occur every 100,000 meters, and near grid zone junctions and ellipsoid junctions.

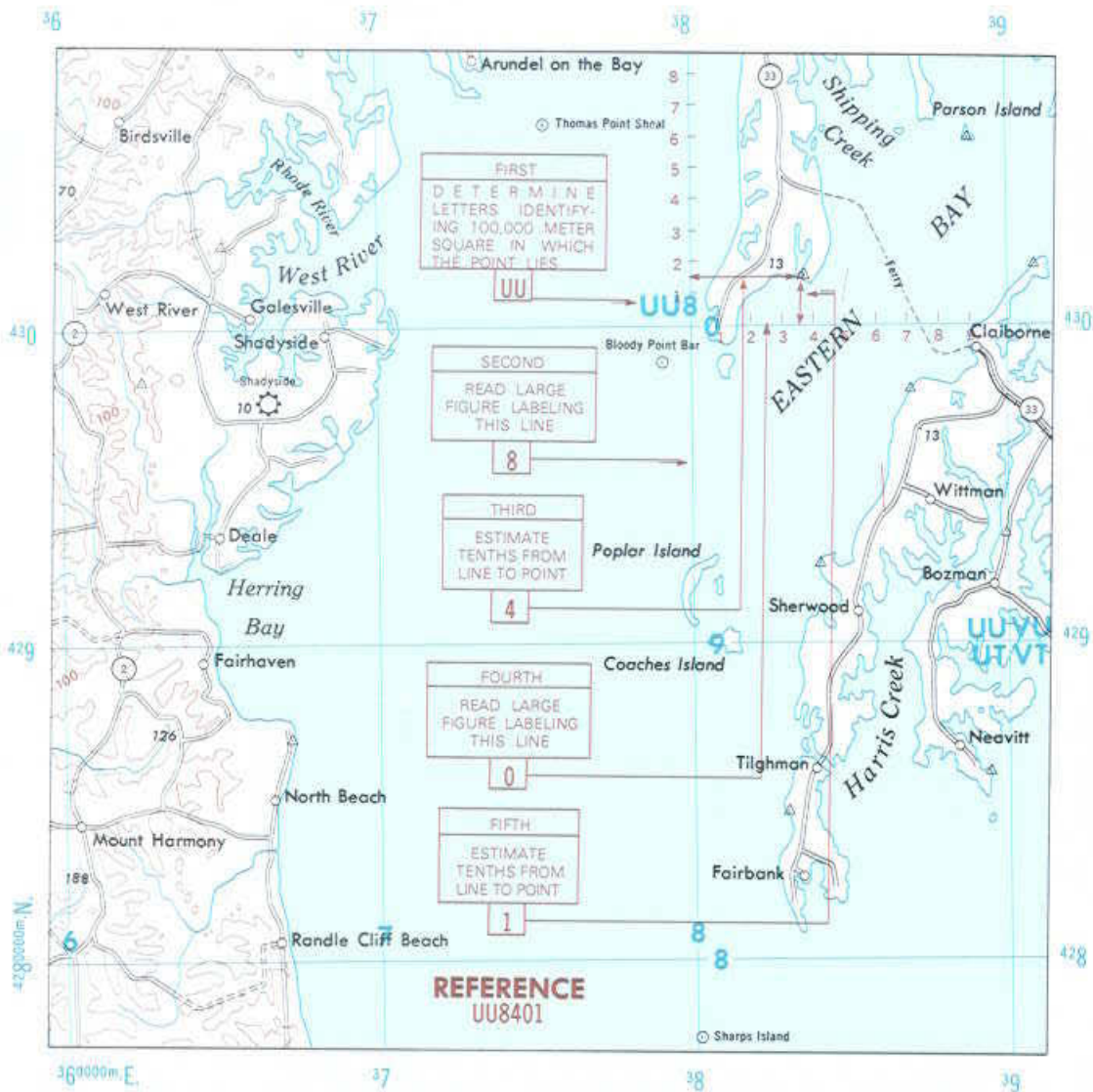

Figure 9. Method of Reading a U.S. Military Grid Reference from a 1:250,000 Scale Map.

3-5.1.3 For small and localized operational areas, the Grid Zone Designations and 100,000-meter square identifications are not used, unless reporting falls within the parameters explained in preceding paragraphs. In the instance of local reporting, only the numerical part of the grid reference is used (such as 836014). This condition applies to 1:100,000 scale maps and larger.

3-5.1.4 Topographic maps at scales 1:500,000 and larger provide a grid reference box with the elements and instructions for making a complete grid reference.

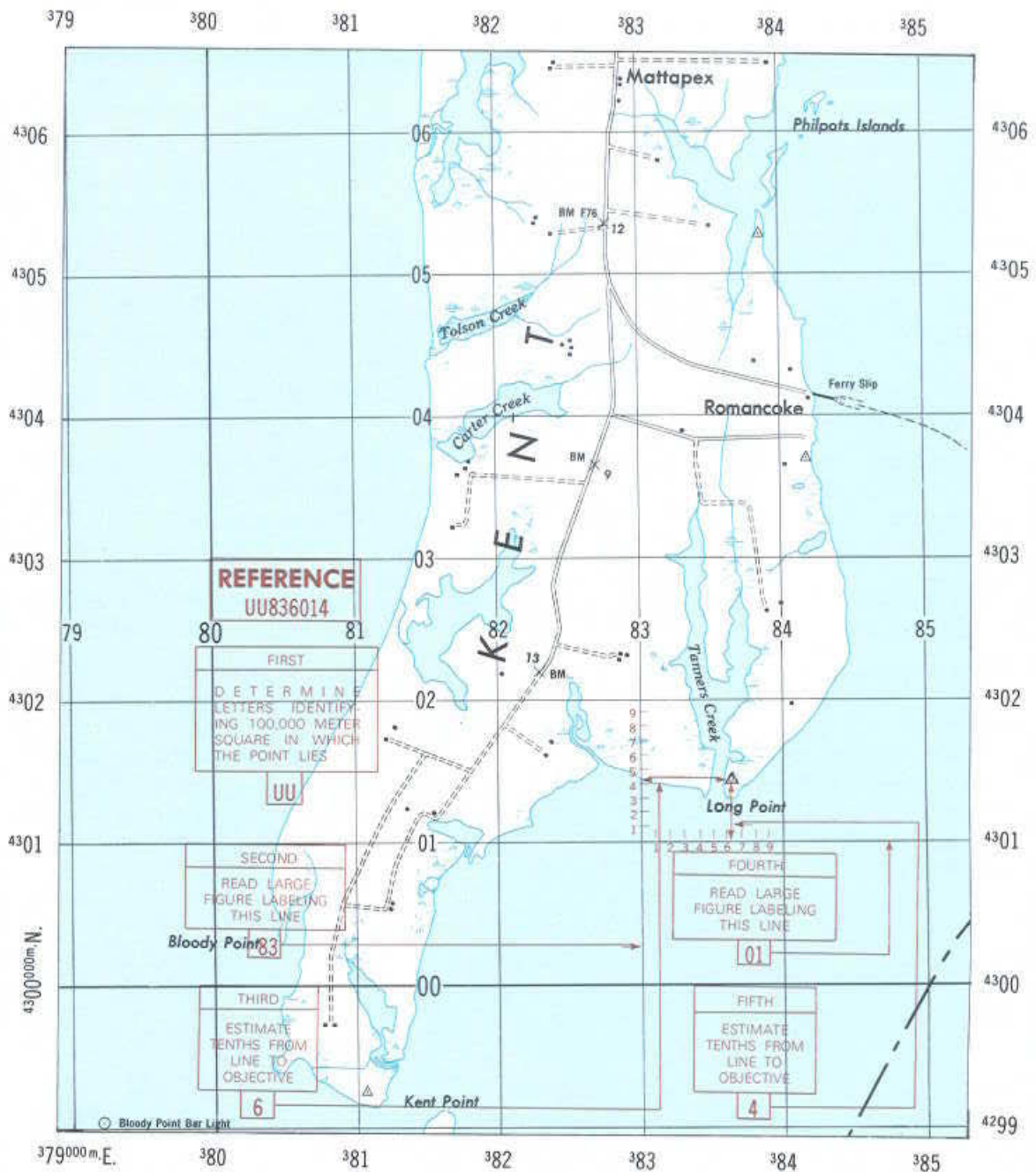

Figure 10. Method of Reading a U.S. Military Grid Reference from a Large Scale Map.

3-5.2 The numerical part of a grid reference always contains an even number of digits. The first half of the total number of digits represents the easting, and second half the northing. The standard military practice of reading "right (easting) and up (northing)" is employed.

3-5.2.1 To read the easting coordinate, locate the first easting (vertical) grid line to the left of the point of reference and read the large digit (or digits), the principal digit labeling the line either in the top or bottom margin or on the line itself. Smaller digits shown as part of a grid number are ignored. Estimate, or scale to the closest tenth of the grid interval, the distance between the easting grid line to the left of the point and the point itself.

3-5.2.2 The reading of the northing coordinate is made in a similar manner. Locate the first northing (horizontal) grid line below the point of reference and read the principal digits labeling the line located in the left or right margin or on the line itself. Then estimate, or scale to the closest tenth of the grid interval, the distance between the northing grid line below the point and the point itself.

3-5.2.3 The numerical part of a point reference taken from a 100,000-meter grid (on maps of 1:1,000,000 scale) is a two-digit number; for example: 80. Reading from left to right, the 8 represents the 10,000 digit of the first easting grid line (or grid tick) to the left of the point; the 0 represents the 10,000 digit of the first northing grid line (or grid tick) below the point.

3-5.2.4 The numerical part of a point reference taken from a 10,000-meter grid (on maps smaller than 1:100,000 scale and larger than 1:1,000,000 scale) is a four-digit number; for example: 8401. Reading from left to right, the 8 represents the 10,000 digit of the first easting grid line to the left of the point, the 4 represents the estimated tenths (nearest 1,000 meters) from the easting grid line to the point, the 0 represents the 10,000 digit of the first northing grid line below the point, and the 1 represents the estimated tenths (nearest 1,000 meters) from the northing grid line to the point. See figure 9.

3-5.2.5 Normally, the numerical part of a point reference taken from a 1,000-meter grid (on maps at scales of 1:100,000 and larger) is a six-digit number; for example: 836014. Reading from left to right, the 83 represents the 10,000 and 1,000 digits of the first easting grid line to the left of the point, the 6 represents the estimated or scaled tenths (nearest 100 meters) from the easting line to the point, the 01 represents the 10,000 and 1,000 digits of the first northing grid line below the point, and the 4 represents the estimated or scaled tenths (nearest 100 meters) from the northing grid line to the point. See figure 10.

CHAPTER 4

THE NONSTANDARD SYSTEMS IN CURRENT USE

4-1 NONSTANDARD GRIDS ON MAPS AND CHARTS.

4-1.1 Nonstandard Grids.

4-1.1.1 There is no regular or uniform global plan for the various grids which make up the nonstandard grid systems. Some were originally developed by the native country and later conveniently adopted by the British and U.S. with or without modifications. Others are of British or French origin. The systems were devised or adopted at different times and, except in certain geographic areas, do not have a direct relationship with one another. Primary considerations in the selection of a grid were the projection, ellipsoid, origin, false coordinates for the origin, and limits which would best suit the particular area. Consequently, various projections and ellipsoids have been employed. Nomenclature, sizes, predominant directions, and outlines of the grids vary considerably. This is demonstrated in Appendix D, which illustrates the layout of the nonstandard grids. This displays what is currently specified for new products and maintenance.

4-1.1.2 The nomenclature for the nonstandard grids includes the terms grid, zone, and belt to characterize the systems.

4-1.1.2.1 A grid covers a relatively small area. Its limits consist of combinations of meridians, parallels, loxodromes (rhumb lines), or grid lines. The origin of each grid is arbitrary. It is generally located approximately in the center of the grid and may bear no relation to the origins of other grids or to those of adjacent grids.

4-1.1.2.2 A zone usually is wide in longitude and comparatively narrow in latitude. Its limits, which are regular in a few cases but irregular in most, consist of parallels and meridians. Each zone has its own origin which, with some few exceptions, falls within the limits of the zone. There is no relation between the origins of the zones, although, in a regional geographic area, those of adjacent zones may be on a common meridian or parallel.

4-1.1.2.3 A belt originally referred to a grid that was extensive in latitude, but narrow in longitude.

4-1.1.3 Each grid, zone, and belt has a name. Where groups of adjacent grids or zones cover a regional geographic area, the same name may be used for each; distinction is preserved by adding either a cardinal point or a number and a letter to the name.

4-1.1.4 The unit of measure is either meters or yards.

4-1.1.5 Normally, a British grid or zone is divided into 500,000-unit squares with each square identified by a letter of the alphabet. In a square comprised of twenty-five 500,000-unit squares the letters are arranged alphabetically (the letter I is omitted) in a left to right - top to bottom fashion. Each 500,000-unit is similarly divided into twenty-five 100,000-unit squares, each of which is identified by a letter following the same plan as for the 500,000-unit squares. The Normal Lettering Plan is illustrated in figure 11. This basic lettering plan is repeated for India Zone IIIA where it exceeds 2,500,000 yards in easting.

4-1.1.6 Among the British grids, deviations from the normal lettering system exist for the Irish Transverse Mercator Grid.

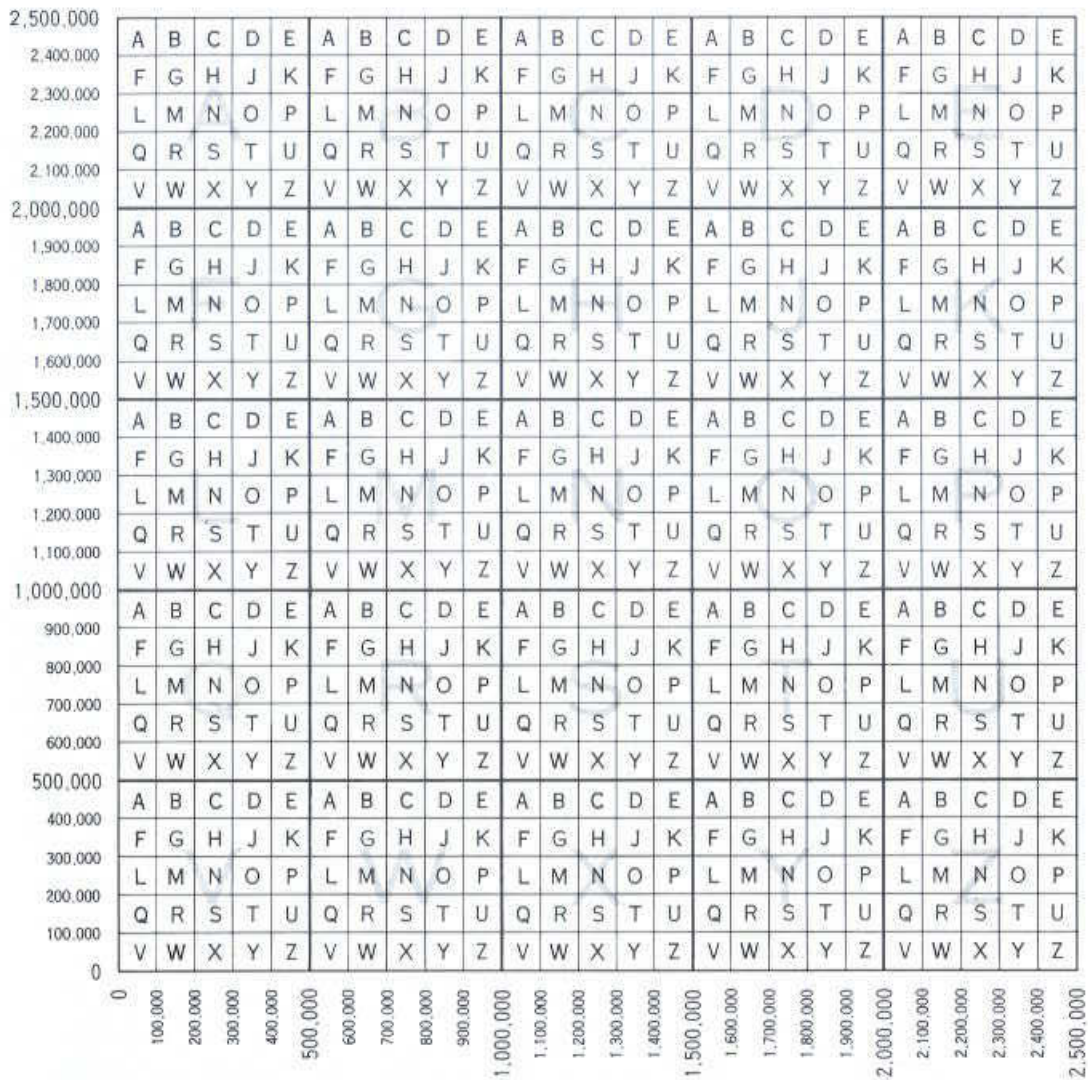

Figure 11. Normal Lettering Plan of the 500,000- 100,000-unit squares of the British Grid System.

4-1.1.7 No letters are used for the Ceylon Belt, New Zealand Map Grid, Nord Algerie Grid, Nord Maroc Grid, Nord Tunisie Grid, Sud Algerie Grid, Sud Maroc Grid, and Sud Tunisie Grid.

4-1.1.8 The secondary grids are constantly changing. Specifications for those grids currently in this category are given in table 6.

NAME	PROJECTION	ELLIPSIOD	LATITUDE	LONGITUDE	FALSE ORIGIN	NORTHING	SCALE FACTOR
British West Indies	TM	Clarke 1880	0°00'00.00"N	62°00'00.00"W	400,000.000m	0.	0.99995
Costa Rica							
Norte	Lambert	Clarke 1866	10°28'00.000"N	84°20'00.000"W	500,000.000m	271,820.522m	0.99995 696
Sud	Lambert	Clarke 1866	9°00'00.000"N	83°40'00.000"W	500,000.000m	327,987.436m	0.99995 696
Cuba							
Norte	Lambert	Clarke 1866	22°21'00.000"N	81°00'00.000"W	500,000.000m	280,296.016m	0.99993 602
Sud	Lambert	Clarke 1866	20°43'00.000"N	76°50'00.000"W	500,000.000m	229,126.939m	0.99994 848
Dominican Republic	Lambert	Clarke 1866	18°49'00.000"N	71°30'00.000"W	500,000.000m	277,063.657m	0.99991 102
Egypt	TM	International	0°00'00.000"N	25°30'00.000"E	300,000.000m	0.	0.99985
				28°30'00.000"E			
				31°30'00.000"E			
				34°30'00.000"E			
				37°30'00.000"E			
El Salvador	Lambert	Clarke 1866	13°47'00.000"N	89°00'00.000"W	500,000.000m	295,809.184m	0.99996 704
Guatemala							
Norte	Lambert	Clarke 1866	16°49'00.000"N	90°20'00.000"W	500,000.000m	292,209.579m	0.99992 226
Sud	Lambert	Clarke 1866	14°54'00.000"N	90°20'00.000"W	500,000.000m	325,992.681m	0.99989 906
Haiti	Lambert	Clarke 1866	18°49'00.000"N	71°30'00.000"W	500,000.000m	277,063.657m	0.99991 102
Honduras							
Norte	Lambert	Clarke 1866	15°30'00.000"N	86°10'00.000"W	500,000.000m	296,917.439m	0.99993 273
Sud	Lambert	Clarke 1866	13°47'00.000"N	87°10'00.000"W	500,000.000m	296,215.903m	0.99995 140
Levant	Lambert	Clarke 1880	34°39'00.000"N	37°21'00.000"E	300,000.000m	300,000.000m	0.99962 56
Nicaragua							
Norte	Lambert	Clarke 1866	13°52'00.000"N	85°30'00.000"W	500,000.000m	359,891.816m	0.99990 314
Sud	Lambert	Clarke 1866	11°44'00.000"N	85°30'00.000"W	500,000.000m	288,876.327m	0.99992 228
Northwest Africa	Lambert	Clarke 1880	34°00'00.000"N	0°00'00.000"E	1,000,000.000m	500,000.000m	0.99908
Palestine	TM	Clarke 1880 ¹	31°44'02.749"N	35°12'43.490"E	170,251.555m ²	126,867.909m ²	1
Panama	Lambert	Clarke 1866	8°25'00.000"N	80°00'00.000"W	500,000.000m	294,865.303m	0.99989 909

¹ Clarke 1880 Ellipsoid for Palestine, a = 6,378,300.79 and 1/f = 293.46630 7656.

² Add 1,000,000.00m to coordinate when coordinate becomes negative.

Table 6. Specifications for secondary grids.

4-1.1.9 The Gauss-Kruger (GK) projection and grids are the basis for the UTM grid system. Within the scope of this manual, there are three GK systems that may be encountered even though the Defense Mapping Agency uses none of them. The Russian GK grid is discussed in Department of the Army Field Manual No. 34-85, Conversion of Warsaw Pact Grids to UTM Grids. General specifications are as follows:

Projection: Transverse Mercator in zones 6° wide.

Ellipsoid: Krassovskiy ($a = 6,378,245$ meters, $1/f = 298.3$) (U.S.S.R., China to 1981).

Geodetic Reference System of China 1980 ($a = 6,378,140$ meters, $1/f = 298.257$) (China from 1981).

Bessel (Germany).

Longitude of Origin: Same as the UTM.

Latitude of Origin: Same as the UTM.

Unit: Meter.

False Easting: 500,000 meters at the CM of each zone. However, the zone number is prefixed to the false easting in most cases, i.e. the false easting for the GK zone 7 is 7,500,000 meters.

False Northing: Same as the UTM.

Scale Factor on Central Meridian: Unity (1).

Grid Zone Designations: The zones are numbered eastward from 1 to 60 starting at the Greenwich meridian rather than the 180° meridian. In other words, the UTM and GK zones differ by 30. Row letters are not used with the GK systems. Limits of System: The limits north and south are not rigidly defined as with the UTM. However, the limits can be assumed to be similar to the UTM.

Overlap: Same as the UTM.

4-1.1.10 The specifications for the nonstandard grids, including the various lettering systems, are shown later in this chapter.

4-1.2 Nonstandard Grids on Maps and Charts.

4-1.2.1 Maps at scales of 1:100,000 and larger are gridded at 1,000-unit intervals. Those at scales 1:250,000 and 1:500,000 are gridded at 10,000-unit intervals. Maps at scales 1:1,000,000 and smaller than 1:500,000 are gridded at 100,000-unit intervals intersected by ticks at 10,000-unit intervals.

4-1.2.2 Each grid line, except on maps at 1:1,000,000 scale, is labeled with its value in the margin and on the line itself. Maps at 1:1,000,000 scale are not labeled on the face of the map. In the margins, the grid values for each line are shown in two sizes of type. The larger digits - the principal digits - are the only digits to be used in determining a grid reference. On the face of the map, the grid lines are labeled with principal digits only. These grid-labeling practices are similar to those of the UTM and UPS grids.

4-1.2.2.1 The number of principal digits labeling the grid lines is dependent upon the particular grid and the interval of the grid lines.

4-1.2.2.2 With grids whose 100,000-unit squares are identified by letters or numbers, the 10,000-unit or 100,000-unit interval grid lines are labeled with one principal digit

only. This represents the 10,000 digit of the grid value. On maps in the same area whose grid lines appear at 1,000-unit intervals, the lines are labeled with two principal digits. These represent the 10,000 and 1,000 digits of the grid value.

4-1.2.2.3 Except the Ceylon Belt, the lines of grids whose 100,000-unit squares are not identified are labeled with two principal digits when the interval is 10,000 units and with three principal digits when the interval is 1,000 units. At the 10,000-unit or 100,000-unit interval, the numbers represent the 100,000, 10,000, and 1,000 digits of the grid value.

4-1.2.2.4 With the Ceylon Belt, two principal digits are used, regardless of the interval of the grid lines. On maps gridded at 10,000- or 100,000-yard intervals, the numbers represent the 100,000 and 10,000 digits of the grid value. On maps gridded at 1,000-yard intervals, the numbers represent the 10,000 and 1,000 digits of the grid value.

4-1.2.3 The 100,000- and 500,000-unit square identifications are shown in several ways, depending upon the scale of the map.

4-1.2.3.1 On maps of British origin which are gridded at 10,000-unit intervals, a miniature representation of the 100,000-unit grid lines is printed in the index to adjoining sheets. Within each square is added the 100,000-unit square identification. If the 500,000-unit squares are identified, the identification is added in smaller type just before each 100,000-unit square identification, such as sC. Similar identifications appear on the face of the map. These will be found either in the center or at the corners of each 100,000-unit square. Variations in these practices will often be encountered.

4-1.2.3.2 This same plan is followed on maps of British origin which are gridded at 1,000-unit intervals, although in many cases it will be found that the identifications are omitted from the face of the map.

4-1.2.3.3 On U.S. maps containing nonstandard grids, a miniature representation of the sheet with 100,000-unit grid lines appears in the grid reference box which is part of the marginal data of the sheet. The appropriate 500,000- and 100,000-unit square identifications appear in each square of the miniature. These are written together, with the 500,000-unit square identification appearing in smaller type, such as sC. Examples are illustrated in figure 27. Similar identifications appear on the face of maps gridded at 10,000-unit intervals.

4-1.3 Referencing.

Two basic methods for giving grid references are used on maps with nonstandard grid reference systems. These are modified in some instances. The first method, referred to as the normal British grid reference system, is used with grids whose 100,000-unit squares are identified by letters. The second method, referred to as the abnormal grid reference system, is used with grids whose 100,000-unit squares are not identified.

4-1.4 The Normal British Grid Reference System.

4-1.4.1 The instructions contained in this section apply only to those grids which adhere to the normal lettering plan.

4-1.4.2 The normal method for giving a reference based on a British grid is similar to that used for the U.S. Military Grid Reference System. See Figures 10 and 11. A reference consists of a group of letters and numbers which indicate (1) the 500,000-unit square identification, (2) the 100,000-unit square identification, and (3) the grid coordinates - the numerical portion of the reference - expressed to a prescribed refinement. It is desirable

to leave a space between letters and numbers.

Examples:

- NT 65 (Locating a point within a 10,000-unit square)
- NT 6354 (Locating a point within a 1,000-unit square)
- NT 632543 (Locating a point within a 100-unit square)

4-1.4.3 The use of the letters of the 500,000- and 100,000-unit square identifications depends on the size of the area of operations. The above examples of reporting are desirable when reporting between 500,000-unit squares so that ambiguity in letter identifications may be avoided. However, when all reporting is within a 500,000-unit square, the 500,000-unit square identification letter may be dropped, and the 100,000-unit square identification is retained to avoid ambiguity in numerical coordinates. When the area of operations is completely localized within a 100,000-unit square, both the 500,000- and 100,000-unit square identifications may be dropped.

4-1.5 Exceptions to the Normal British Grid Reference System.

4-1.5.1 The letter I is used as the 500,000-meter square letter with the Irish Transverse Mercator.

4-1.5.2 No 500,000- and 100,000-meter square letters are used with the New Zealand Map Grid. To avoid ambiguity, references are prefixed with the sheet number. A space separates the sheet number from the numerical reference.

Examples:

- Z15 894623 (Locating a point within a 1,000-meter square at 1:50,000 scale)
- Sht 5 989362 (Locating a point within a 10,000-meter square at 1:250,000 scale)

4-1.6 The Abnormal Grid Reference System.

4-1.6.1 The abnormal grid reference system is used when 100,000-unit squares are not identified, as with the Madagascar grid and the Lambert Grids of northwestern Africa. The reference usually is expressed in terms of grid coordinates only and is determined in the same manner as that used with the normal British grid reference system. The number of digits in the reference depends upon the grid interval and the grid itself.

4-1.6.2 Except for the Ceylon Belt, an abnormal reference taken from a map gridded at 100,000-meter intervals consists of four digits; at 10,000 meters, six digits; and for 1,000-meter intervals, eight digits.

Examples:

- 8645 (Locating a point within a 10,000-meter square)
- 863454 (Locating a point within a 1,000-meter square)
- 86324543 (Locating a point within a 100-meter square)

4-1.6.3 References based on the Ceylon Belt use four digits on maps gridded at 100,000-yard intervals and six digits for all other grid intervals.

Examples:

- Reference from map gridded at 100,000-yard intervals.
3524 (Locating a point within a 10,000-yard square)
- Reference from map gridded at 10,000-yard intervals.
347241 (Locating a point within a 1,000-yard square)

Reference from map gridded at 1,000-yard intervals.
472413 (Locating a point within a 100-yard square)

4-1.6.3.1 The Ceylon Belt grid reference system has a distinct disadvantage. Ambiguity between references is possible when six-digit reporting covers an area exceeding 100,000-yards square.

4-1.6.3.2 No official method is provided for preserving a distinction between the references. In practice, various devices have been used, such as prefixing the reference with the scale, name, or number of the map from which the reference was taken.

4-1.6.3.3 On maps prepared by the United States, the grid reference box will contain instructions for preserving distinctions. Normally, this will require prefixing the numerical reference with the sheet number of the map from which the reference was taken.

4-1.7 Unique Reporting.

Nonstandard reference systems, unlike the U.S. Military Grid Reference System, make no provisions for worldwide reporting. It may be necessary to identify the general areas in terms of geographic coordinates before giving the grid references for the separate general areas.

4-2 DIAGRAMS OF NONSTANDARD GRIDS.

The following pages show the diagrams and specifications of nonstandard grids used as the primary or secondary grid on maps produced by DMA:

BRITISH NATIONAL GRID

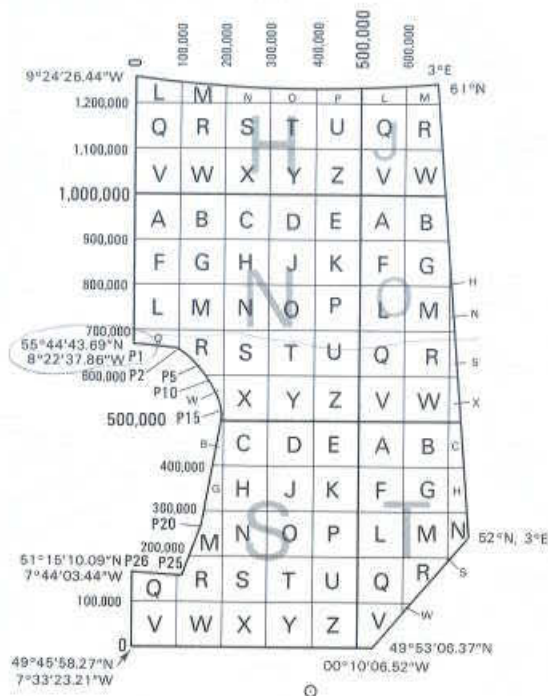

PROJECTION: Transverse Mercator

ELLIPSOID: Airy

UNIT: Meter

ORIGIN: 49°N., 2°W.

FALSE COORDINATES OF ORIGIN: 400,000 meters E.; -100,000 meters N.

SCALE FACTOR: 0.99960 12717

INCIDENCE OF GRID LETTERS: The 500,000-meter square letter S and the 100,000-meter square letter V are both north and east of the false origin.

GRID TABLES: *Projection Tables for the Transverse Mercator Projection of Great Britain.*

GRID "COLOR": Black

REFERENCING FOR 1,000-METER GRID (6-digit numerical reference):

Principal digits: (2); 10,000, 1,000

REFERENCING FOR 10,000-METER GRID (4-digit numerical reference):

Principal digits: (1); 10,000

REFERENCING FOR 100,000-METER GRID (2-digit numerical reference):

Principal digits: (1); 10,000

See next page for junction with Irish TM Grid

The junction with the Irish Transverse Mercator Grid is as follows:

POINT	LATITUDE	LONGITUDE
P1	55°44'43.69"N	8°22'37.86"W
P2	55°44'25.8"N	6°49'55.3"W
P3	55°38'53.1"N	6°35'11.6"W
P4	55°33'22.1"N	6°24'54.2"W
P5	55°27'50.4"N	6°14'47.7"W
P6	55°22'18.3"N	6°05'10.3"W
P7	55°16'45.8"N	5°55'55.8"W
P8	55°11'12.9"N	5°46'58.8"W
P9	55°05'39.4"N	5°38'05.8"W
P10	55°00'08.4"N	5°31'48.4"W
P11	54°54'37.4"N	5°25'49.5"W
P12	54°49'08.0"N	5°21'16.2"W
P13	54°38'10.5"N	5°13'31.2"W
P14	54°30'29.9"N	5°11'00.3"W
P15	54°21'58.8"N	5°12'44.6"W
P16	54°11'14.6"N	5°14'50.9"W
P17	53°55'09.1"N	5°18'45.9"W
P18	53°28'18.0"N	5°23'54.2"W
P19	53°01'26.5"N	5°28'55.6"W
P20	52°34'34.6"N	5°33'51.4"W
P21	52°19'50.3"N	5°36'29.8"W
P22	52°07'47.3"N	5°42'50.5"W
P23	51°41'04.5"N	5°56'41.0"W
P24	51°14'54.6"N	6°11'08.5"W
P25	51°14'21.1"N	6°11'45.0"W
P26	51°15'10.09"N	7°44'03.44"W
Dover Straits	52°00'00.00"N	3°00'00.00"E
Loxodrome	49°53'06.37"N	0°10'06.52"W

The geographic values for these points are the same in the Ireland 1965 and the Ordnance Survey of Great Britain 1936 datums.

CEYLON BELT

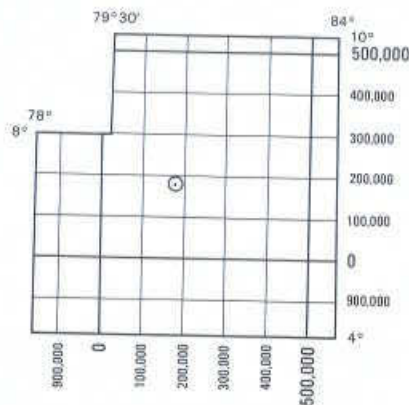

PROJECTION: Transverse Mercator

ELLIPSOID: Everest ($a = 6,974,310.6$ Indian Yards, $1/f = 300.8017$)

UNIT: Indian Yard

ORIGIN: $7^{\circ}00'01.729''N.$, $80^{\circ}46'18.160''E.$

FALSE COORDINATES OF ORIGIN: 176,000 yards E., 176,000 yards N. [south and west of the false origin (0 yards E. and 0 yards N. grid lines) add 1,000,000 yards to the easting and northing.]

SCALE FACTOR: Unity

INCIDENCE OF GRID LETTERS: No letters used.

GRID TABLES: *Transverse Mercator Projection Tables, Ceylon Belt*

GRID "COLOR": Brown (red-brown)

REFERENCING FOR 1,000-YARD GRID (6-digit numerical reference):

Principal digits: (2); 10,000, 1,000

REFERENCING FOR 10,000-YARD GRID (6-digit numerical reference):

Principal digits: (2); 100,000, 10,000

REFERENCING FOR 100,000-YARD GRID (4-digit numerical reference):

Principal digits: (2); 100,000, 10,000

INDIA ZONE I

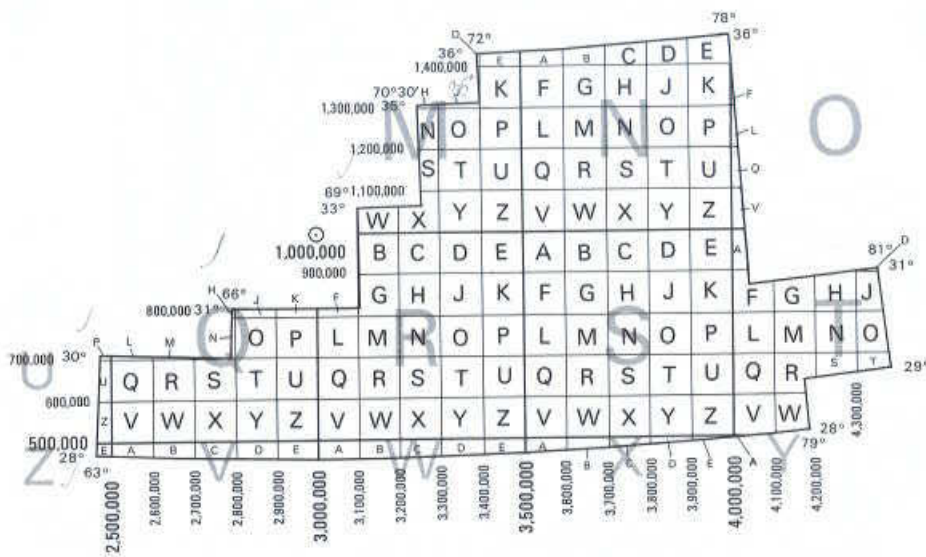

PROJECTION: Lambert Conical Orthomorphic

ELLIPSOID: Everest ($a = 6,974,310.6$ Indian Yards $1/f = 300.8017$)

UNIT: Indian Yard

ORIGIN: $32^{\circ} 30' N.$, $68^{\circ} E.$

FALSE COORDINATES OF ORIGIN: 3,000,000 yards E., 1,000,000 yards N.

SCALE FACTOR: .99878 6408

INCIDENCE OF GRID LETTERS: Normal

GRID TABLES: *Lambert Conical Orthomorphic Projection Tables, India Zone I*

GRID "COLOR": Black

REFERENCING FOR 1,000-YARD GRID (6-digit numerical reference):

Principal digits: (2); 10,000, 1,000

REFERENCING FOR 10,000-YARD GRID (4-digit numerical reference):

Principal digits: (1); 10,000

REFERENCING FOR 100,000-YARD GRID (2-digit numerical reference):

Principal digits: (1); 10,000

INDIA ZONE IIA

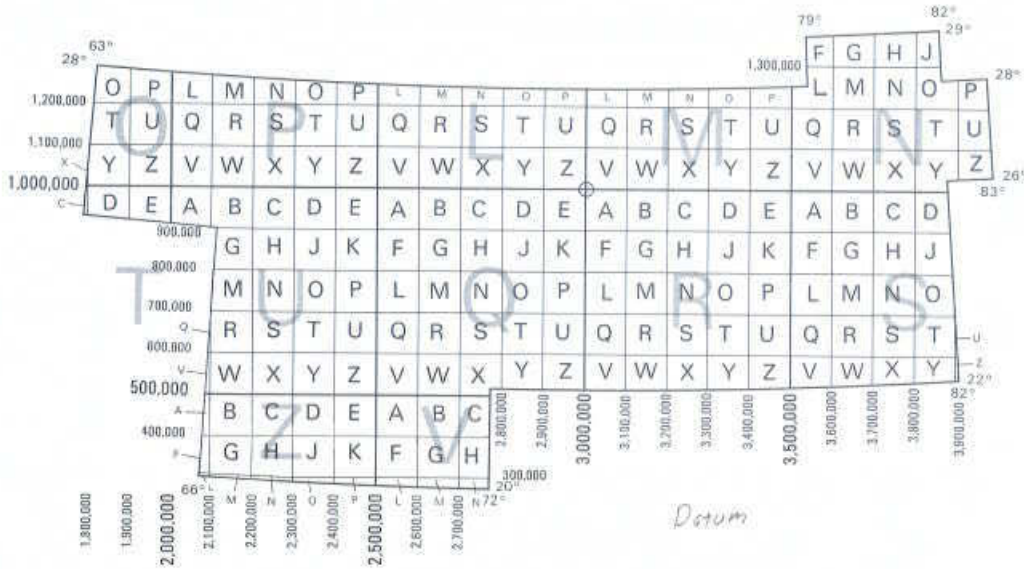

- PROJECTION: Lambert Conical Orthomorphic
- ELLIPSOID: Everest ($a = 6,974,310.6$ Indian Yards $1/f = 300.8017$)
UNIT: Indian Yard
- ORIGIN: 26°N , 74°E .
- FALSE COORDINATES OF ORIGIN: 3,000,000 yards E., 1,000,000 yards N.
- SCALE FACTOR: .99878 6408
INCIDENCE OF GRID LETTERS: Normal
GRID TABLES: *Lambert Conical Orthomorphic Projection Tables, India Zone IIA, India Zone IIB.*
GRID "COLOR": Black
REFERENCING FOR 1,000-YARD GRID (6-digit numerical reference):
Principal digits: (2); 10,000, 1,000
REFERENCING FOR 10,000-YARD GRID (4-digit numerical reference):
Principal digits: (1); 10,000
REFERENCING FOR 100,000-YARD GRID (2-digit numerical reference):
Principal digits: (1); 10,000

INDIA ZONE IIB

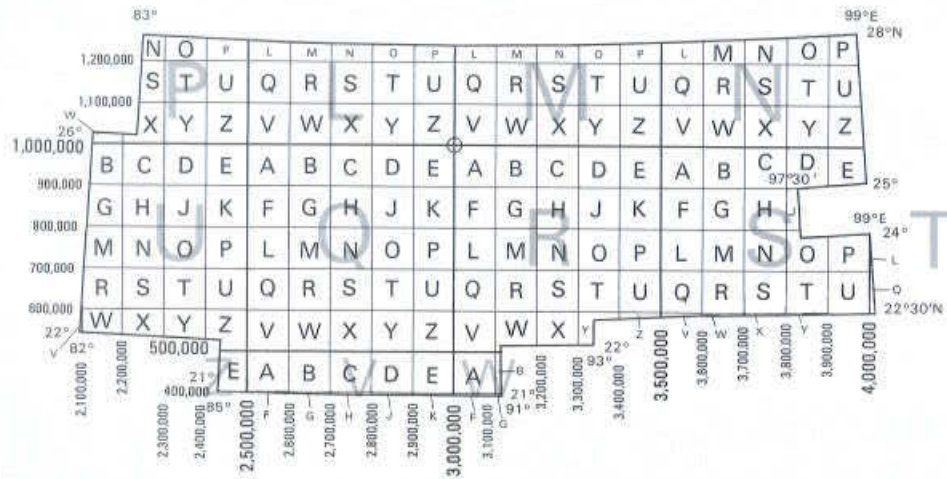

PROJECTION: Lambert Conical Orthomorphic

ELLIPSOID: Everest ($a = 6,974,310.6$ Indian Yards $1/f = 300.8017$)

UNIT: Indian Yard

ORIGIN: $26^{\circ}\text{N}, 90^{\circ}\text{E}$.

FALSE COORDINATES OF ORIGIN: 3,000,000 yards E., 1,000,000 yards N.

SCALE FACTOR: .99878 6408

INCIDENCE OF GRID LETTERS: Normal

GRID TABLES: *Lambert Conical Orthomorphic Projection Tables, India Zone IIA, India Zone IIB*

GRID "COLOR": Black

REFERENCING FOR 1,000-YARD GRID (6-digit numerical reference):

Principal digits: (2); 10,000, 1,000

REFERENCING FOR 10,000-YARD GRID (4-digit numerical reference):

Principal digits: (1); 10,000

REFERENCING FOR 100,000-YARD GRID (2-digit numerical reference):

Principal digits: (1); 10,000

INDIA ZONE IIIA

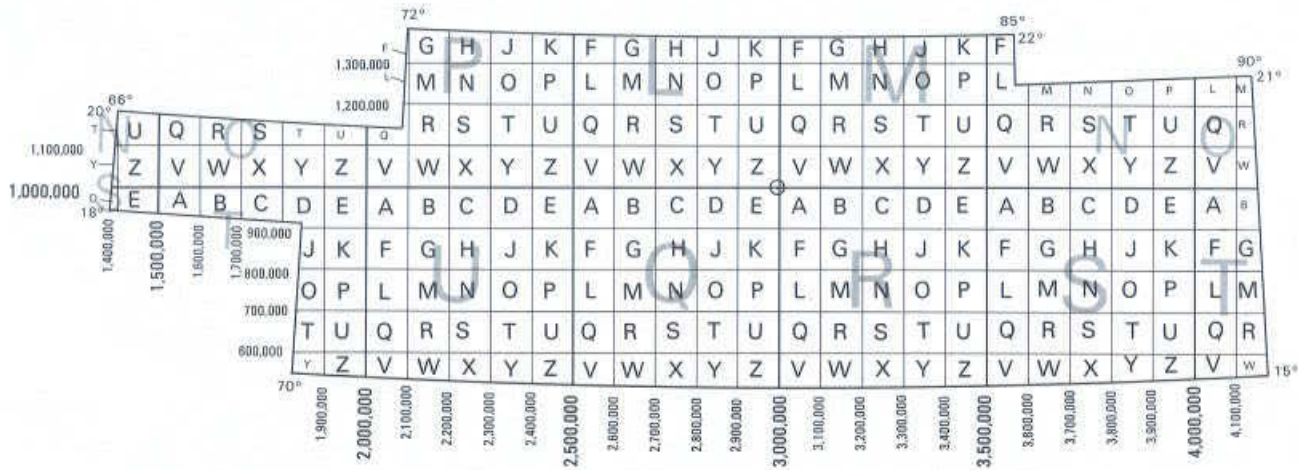

PROJECTION: Lambert Conical Orthomorphic
ELLIPSOID: Everest ($a = 6,974,310.6$ Indian Yards $1/f = 300.8017$)
UNIT: Indian Yard
ORIGIN: 19°N., 80°E.
FALSE COORDINATES OF ORIGIN: 3,000,000 yards E., 1,000,000 yards N.
SCALE FACTOR: .99878 6408
INCIDENCE OF GRID LETTERS: Normal
GRID TABLES: *Lambert Conical Orthomorphic Projection Tables, India Zone IIIA, India Zone IIIB*
GRID "COLOR": Black
REFERENCING FOR 1,000-YARD GRID (6-digit numerical reference):
 Principal digits: (2); 10,000, 1,000
REFERENCING FOR 10,000-YARD GRID (4-digit numerical reference):
 Principal digits: (1); 10,000
REFERENCING FOR 100,000-YARD GRID (2-digit numerical reference):
 Principal digits: (1); 10,000

INDIA ZONE IIIB

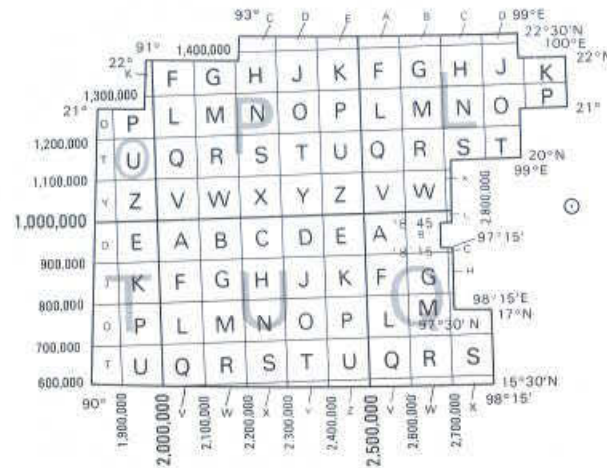

PROJECTION: Lambert Conical Orthomorphic

ELLIPSOID: Everest ($a = 6,974,310.6$ Indian Yards $1/f = 300.8017$)

UNIT: Indian Yard

ORIGIN: $19^{\circ}\text{N.}, 100^{\circ}\text{E.}$

FALSE COORDINATES OF ORIGIN: 3,000,000 yards E., 1,000,000 yards N.

SCALE FACTOR: .99878 6408

INCIDENCE OF GRID LETTERS: Normal

GRID TABLES: *Lambert Conical Orthomorphic Projection Tables, India Zone IIIA, India Zone IIIB*

GRID "COLOR": Black

REFERENCING FOR 1,000-YARD GRID (6-digit numerical reference):

Principal digits: (2); 10,000, 1,000

REFERENCING FOR 10,000-YARD GRID (4-digit numerical reference):

Principal digits: (1); 10,000

REFERENCING FOR 100,000-YARD GRID (2-digit numerical reference):

Principal digits: (1); 10,000

INDIA ZONE IVA

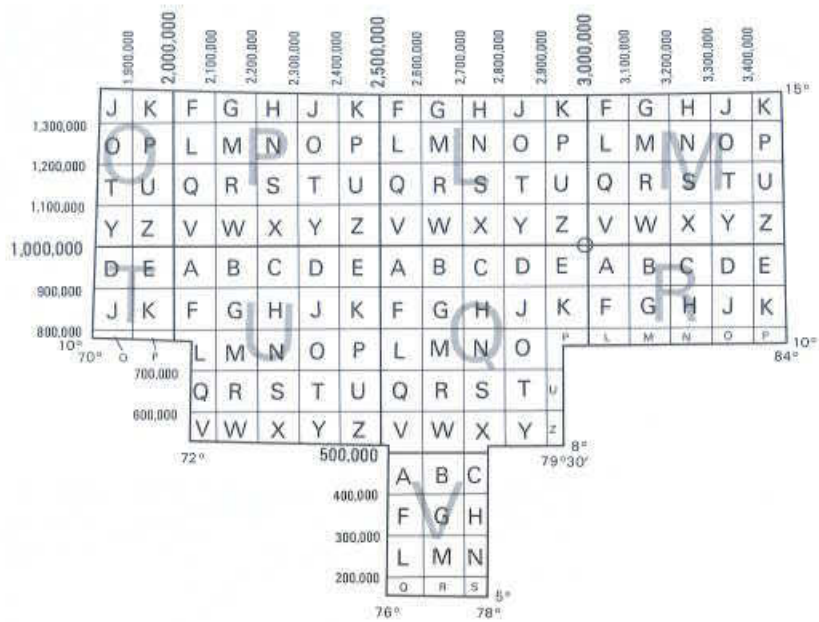

PROJECTION: Lambert Conical Orthomorphic
ELLIPSOID: Everest ($a = 6,974,310.6$ Indian Yards $1/f = 300.8017$)
UNIT: Indian Yard
ORIGIN: 12°N., 80°E.
FALSE COORDINATES OF ORIGIN: 3,000,000 yards E., 1,000,000 yards N.
SCALE FACTOR: .99878 6408
INCIDENCE OF GRID LETTERS: Normal
GRID TABLES: *Lambert Conical Orthomorphic Projection Tables, India Zone IVA, India Zone IVB*
GRID "COLOR": Black
REFERENCING FOR 1,000-YARD GRID (6-digit numerical reference):
 Principal digits: (2); 10,000, 1,000
REFERENCING FOR 10,000-YARD GRID (4-digit numerical reference):
 Principal digits: (1); 10,000
REFERENCING FOR 100,000-YARD GRID (2-digit numerical reference):
 Principal digits: (1); 10,000

INDIA ZONE IVB

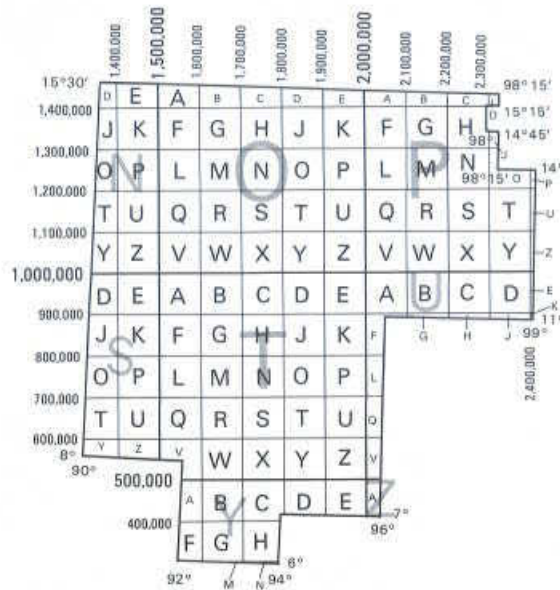

PROJECTION: Lambert Conical Orthomorphic

ELLIPSOID: Everest ($a = 6,974,310.6$ Indian Yards $1/f = 300.8017$)

UNIT: Indian Yard

ORIGIN: $12^{\circ}\text{N.}, 104^{\circ}\text{E.}$

FALSE COORDINATES OF ORIGIN: 3,000,000 yards E., 1,000,000 yards N.

SCALE FACTOR: .99878 6408

INCIDENCE OF GRID LETTERS: Normal

GRID TABLES: *Lambert Conical Orthomorphic Projection Tables, India Zone IVA, India Zone IVB*

GRID "COLOR": Blue

REFERENCING FOR 1,000-YARD GRID (6-digit numerical reference):

Principal digits: (2); 10,000, 1,000

REFERENCING FOR 10,000-YARD GRID (4-digit numerical reference):

Principal digits: (1); 10,000

REFERENCING FOR 100,000-YARD GRID (2-digit numerical reference):

Principal digits: (1); 10,000

IRISH TRANSVERSE MERCATOR GRID

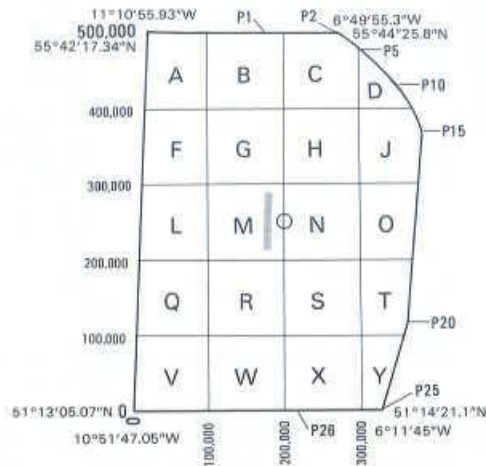

PROJECTION: Transverse Mercator

ELLIPSOID: Modified Airy

UNIT: Meter

ORIGIN: 53°30'N., 8°W.

FALSE COORDINATES OF ORIGIN: 200,000 meters E., 250,000 meters N. (south of the false origin add 1,000,000 meters to the northing.)

SCALE FACTOR: 1.00003 5

INCIDENCE OF GRID LETTERS: For the 500,000-meter square letter use the special letter I. Normal 100,000-meter square letters.

GRID TABLES: *Tables for the Transverse Mercator Projection of Ireland*

GRID "COLOR": Red (red-brown)

REFERENCING FOR 1,000-METER GRID (6-digit numerical reference):

Principal digits: (2); 10,000, 1,000

REFERENCING FOR 10,000-METER GRID (4-digit numerical reference):

Principal digits: (1); 10,000

REFERENCING FOR 100,000-METER GRID (2-digit numerical reference):

Principal digits: (1); 10,000

See British National Grid for Limits of Junction Line

MADAGASCAR GRID

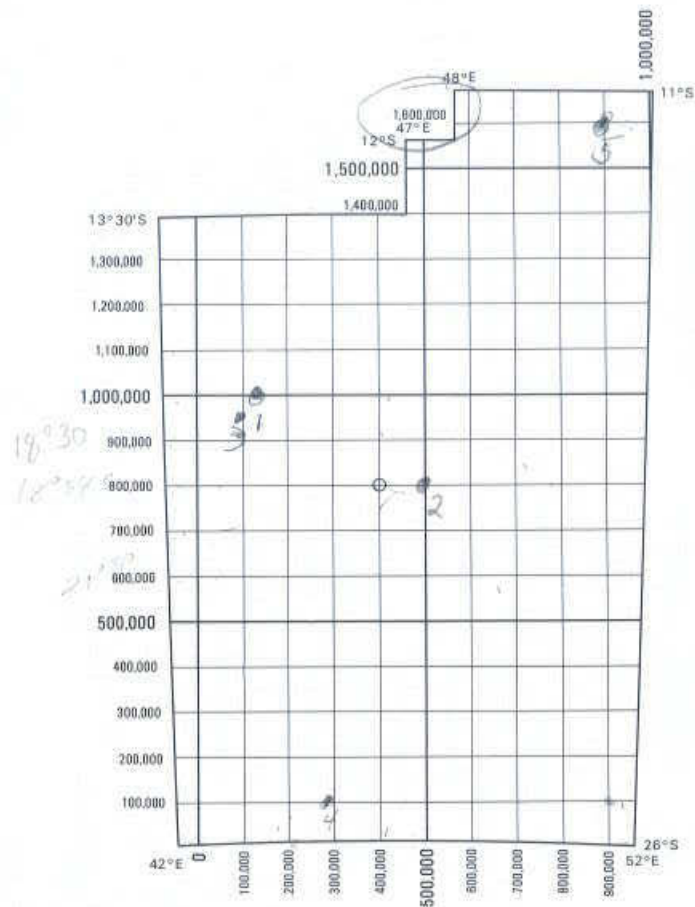

PROJECTION: Laborde

ELLIPSOID: International

UNIT: Meter

ORIGIN: 18°54'S., 46°26'13.95"E.

FALSE COORDINATES OF ORIGIN: 400,000 meters E., 800,000 meters N. (west of the false origin add 1,000,000 meters to the easting.)

SCALE FACTOR: .9995

INCIDENCE OF GRID LETTERS: No letters used

GRID TABLES: *Laborde Projection Tables, Madagascar Grid*

GRID "COLOR": Red (red-brown)

REFERENCING FOR 1,000-METER GRID (8-digit numerical reference):

Principal digits: (3); 100,000, 10,000, 1,000

REFERENCING FOR 10,000-METER GRID (6-digit numerical reference):

Principal digits: (2); 100,000, 10,000

REFERENCING FOR 100,000-METER GRID (4-digit numerical reference):

Principal digits: (2); 100,000, 10,000

NETHERLANDS EAST INDIES
EQUATORIAL ZONE

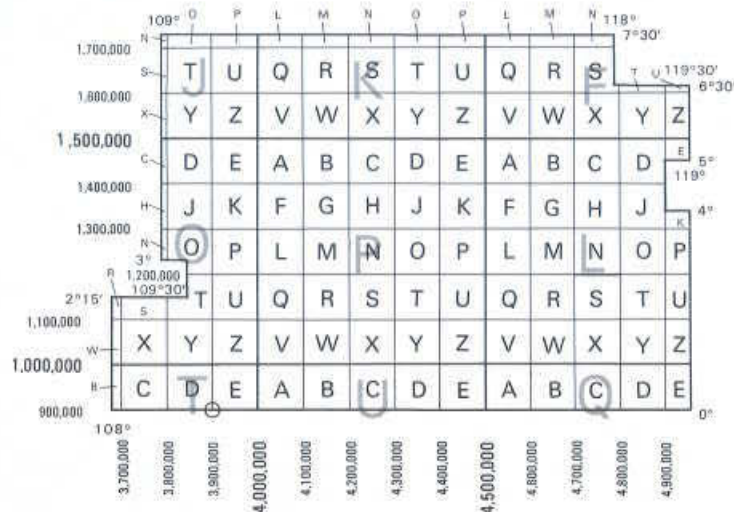

PROJECTION: Mercator

ELLIPSOID: Bessel

UNIT: Meter

ORIGIN: Equator, 110°E.

FALSE COORDINATES OF ORIGIN: 3,900,000 meters E., 900,000 meters N.

SCALE FACTOR: .997

INCIDENCE OF GRID LETTERS: The 500,000-meter square letter P and the 100,000-meter square letter V are both east of the 4,000,000-meter grid line and north of the 1,000,000-meter grid line

GRID TABLES: *Lambert Conical Orthomorphic Projection Tables, Netherland East Indies Equatorial Zone*

GRID "COLOR": Blue

REFERENCING FOR 1,000-METER GRID (6-digit numerical reference):

Principal digits: (2); 10,000, 1,000

REFERENCING FOR 10,000-METER GRID (4-digit numerical reference):

Principal digits: (1); 10,000

REFERENCING FOR 100,000-METER GRID (2-digit numerical reference):

Principal digits: (1); 10,000

NEW ZEALAND MAP GRID (NZMG)

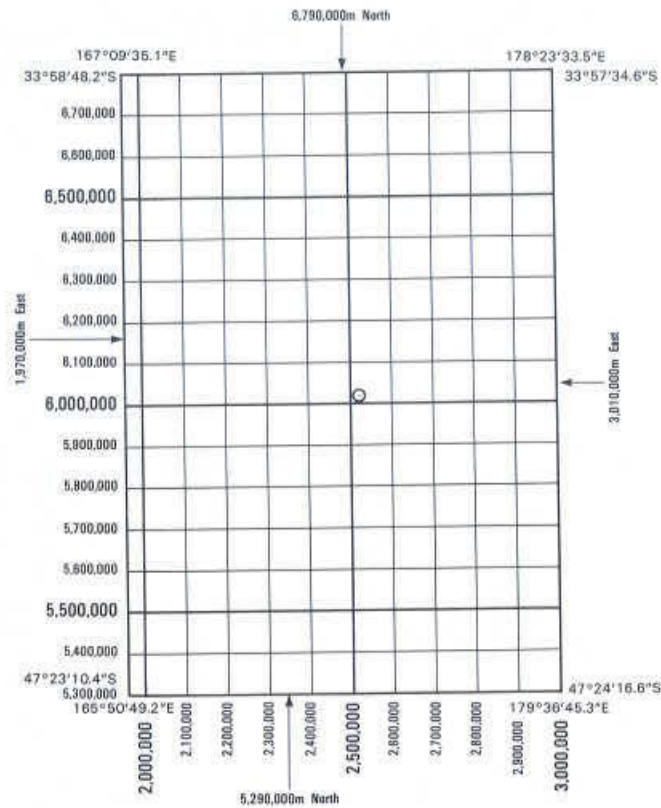

PROJECTION: New Zealand Map Grid (derived by W. I. Reilly)

ELLIPSOID: International

UNIT: Meter

ORIGIN: 41°S., 173°E.

FALSE COORDINATES OF ORIGIN: 2,510,000 meters E.; 6,023,150 meters N.

INCIDENCE OF GRID LETTERS: No letters used

GRID TABLES: Not available

GRID "COLOR": Blue

REFERENCING FOR 1,000-METER GRID (6-digit numerical reference):

Principal digits: (2); 10,000, 1,000

REFERENCING FOR 10,000-METER GRID (6-digit numerical reference):

Principal digits: (2); 10,000, 1,000

REFERENCING FOR 100,000-METER GRID (6-digit numerical reference):

Principal digits: (2); 10,000, 1,000

NORD ALGÉRIE GRID

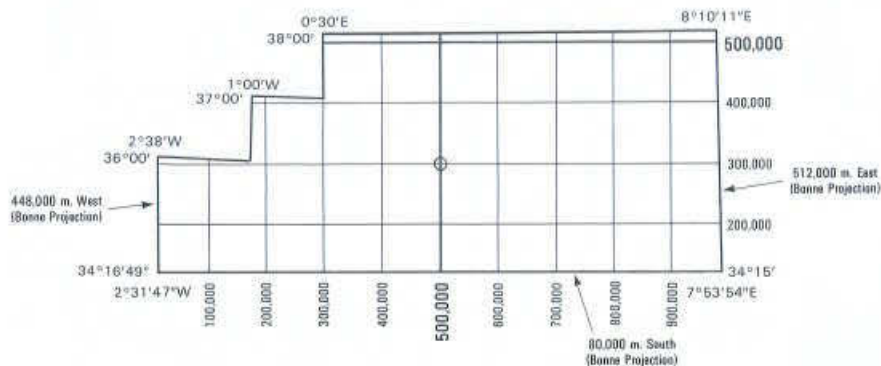

PROJECTION: Lambert Conical Orthomorphic
ELLIPSOID: Clarke 1880
UNIT: Meter
ORIGIN: 36°N., 2°42'E.
FALSE COORDINATES OF ORIGIN: 500,000 meters E.; 300,000 meters N.
SCALE FACTOR: .99962 5544
INCIDENCE OF GRID LETTERS: No letters used
GRID TABLES: *Tables des Constantes Numériques des Systèmes de Projections Lambert*
GRID "COLOR": Blue
REFERENCING FOR 1,000-METER GRID (8-digit numerical reference):
 Principal digits: (3); 100,000, 10,000, 1,000
REFERENCING FOR 10,000-METER GRID (6-digit numerical reference):
 Principal digits: (2); 100,000, 10,000
REFERENCING FOR 100,000-METER GRID (4-digit numerical reference):
 Principal digits: (2); 100,000, 10,000

NORD MAROC GRID

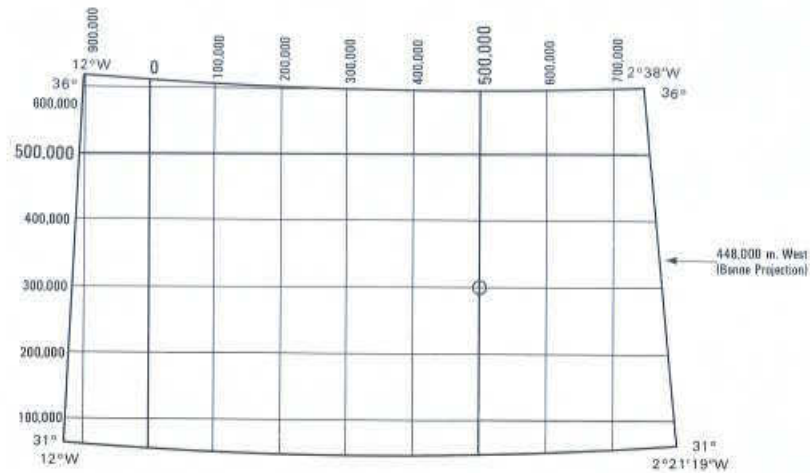

PROJECTION: Lambert Conical Orthomorphic

ELLIPSOID: Clarke 1880

UNIT: Meter

ORIGIN: 33°18'N., 5°24'W.

FALSE COORDINATES OF ORIGIN: 500,000 meters E., 300,000 meters N.
(west of the false origin add 1,000,000 meters to the easting)

SCALE FACTOR: .99962 5769

INCIDENCE OF GRID LETTERS: No Letters used.

GRID TABLES: *Tables des Constantes Numériques des Systèmes de Projections Lambert*

GRID "COLOR": Red (red-brown)

REFERENCING FOR 1,000-METER GRID (8-digit numerical reference):

Principal digits: (3); 100,000, 10,000, 1,000

REFERENCING FOR 10,000-METER GRID (6-digit numerical reference):

Principal digits: (2); 100,000, 10,000

REFERENCING FOR 100,000-METER GRID (4-digit numerical reference):

Principal digits: (2); 100,000, 10,000

NORD TUNISIE GRID

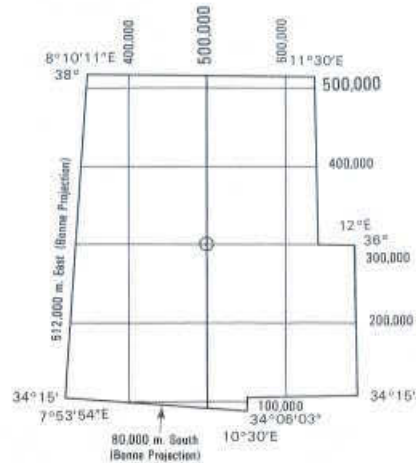

PROJECTION: Lambert Conical Orthomorphic

ELLIPSOID: Clarke 1880

UNIT: Meter

ORIGIN: 36°N., 9°54'E.

FALSE COORDINATES OF ORIGIN: 500,000 meters E., 300,000 meters N.

SCALE FACTOR: .99962 5544

INCIDENCE OF GRID LETTERS: No letters used.

GRID TABLES: *Tables des Constantes Numériques des Systèmes de Projections Lambert*

GRID "COLOR": Brown (red-brown)

REFERENCING FOR 1,000-METER GRID (8-digit numerical reference):

Principal digits: (3); 100,000, 10,000, 1,000

REFERENCING FOR 10,000-METER GRID (6-digit numerical reference):

Principal digits: (2); 100,000, 10,000

REFERENCING FOR 100,000-METER GRID (4-digit numerical reference):

Principal digits: (2); 100,000, 10,000

SUD ALGÉRIE GRID

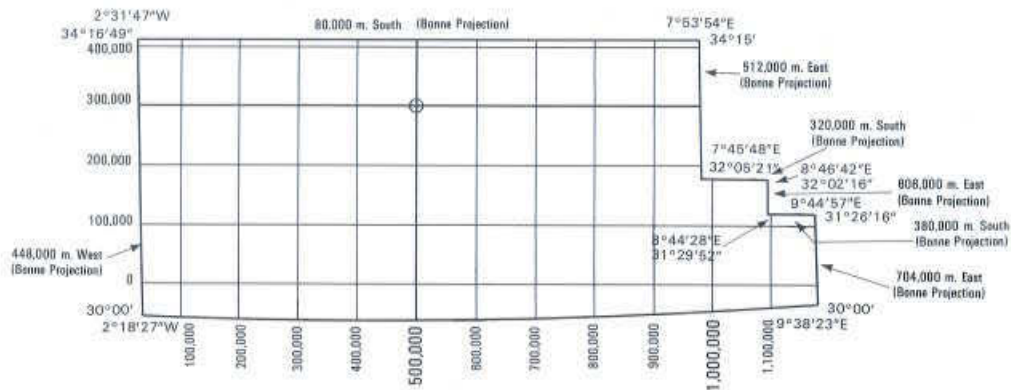

PROJECTION: Lambert Conical Orthomorphic

ELLIPSOID: Clarke 1880

UNIT: Meter

ORIGIN: 33°18'N., 2°42'E.

FALSE COORDINATES OF ORIGIN: 500,000 meters E, 300,000 meters N. (south of false origin add 1,000,000 meters to the northing)

SCALE FACTOR: .99962 5769

INCIDENCE OF GRID LETTERS: No letters used.

GRID TABLES: *Tables des Constantes Numériques des Systèmes de Projections Lambert*

GRID "COLOR": Brown (red-brown)

REFERENCING FOR 1,000-METER GRID (8-digit numerical reference):

Principal digits: (3); 100,000, 10,000, 1,000

REFERENCING FOR 10,000-METER GRID (6-digit numerical reference):

Principal digits: (2); 100,000, 10,000

REFERENCING FOR 100,000-METER GRID (4-digit numerical reference):

Principal digits: (2); 100,000, 10,000

SUD MAROC GRID

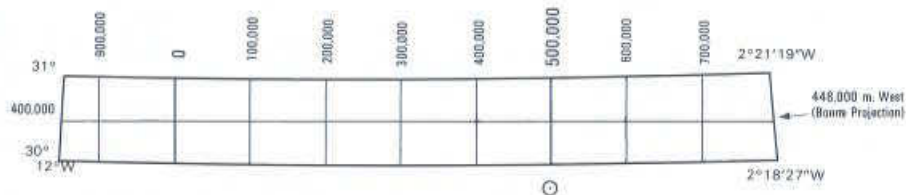

PROJECTION: Lambert Conical Orthomorphic

ELLIPSOID: Clarke 1880

UNIT: Meter

ORIGIN: 29°42'N., 5°24'W.

FALSE COORDINATES OF ORIGIN: 500,000 meters E., 300,000 meters N. (west of the false origin add 1,000,000 meters to the easting).

SCALE FACTOR: .99961 5596

INCIDENCE OF GRID LETTERS: No letters used.

GRID TABLES: *Tables des Constantes Numériques des Systèmes de Projections Lambert*
GRID "COLOR": Blue

REFERENCING FOR 1,000-METER GRID (8-digit numerical reference):

Principal digits: (3); 100,000, 10,000, 1,000

REFERENCING FOR 10,000-METER GRID (6-digit numerical reference):

Principal digits: (2); 100,000, 10,000

REFERENCING FOR 100,000-METER GRID (4-digit numerical reference):

Principal digits: (2); 100,000, 10,000

SUD TUNISIE GRID

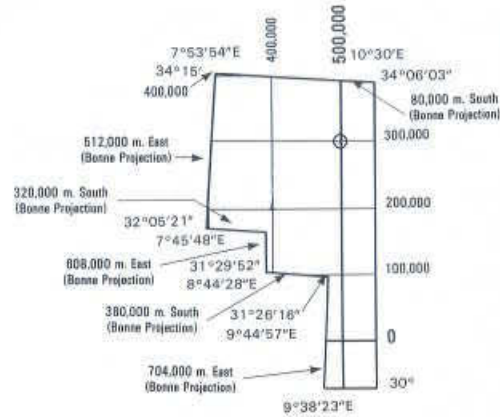

PROJECTION: Lambert Conical Orthomorphic

ELLIPSOID: Clarke 1880

UNIT: Meter

ORIGIN: 33°18'N., 9°54'E.

FALSE COORDINATES OF ORIGIN: 500,000 meters E., 300,000 meters N. (South of false origin add 1,000,000 meters to the northing)

SCALE FACTOR: .99962 5769

INCIDENCE OF GRID LETTERS: No letters used.

GRID TABLES: *Tables des Constantes Numériques des Systèmes de Projections Lambert*
GRID "COLOR": Blue

REFERENCING FOR 1,000-METER GRID (8-digit numerical reference):

Principal digits: (3); 100,000, 10,000, 1,000

REFERENCING FOR 10,000-METER GRID (6-digit numerical reference):

Principal digits: (2); 100,000, 10,000

REFERENCING FOR 100,000-METER GRID (4-digit numerical reference):

Principal digits: (2); 100,000, 10,000

WEST MALAYSIAN RSO GRID

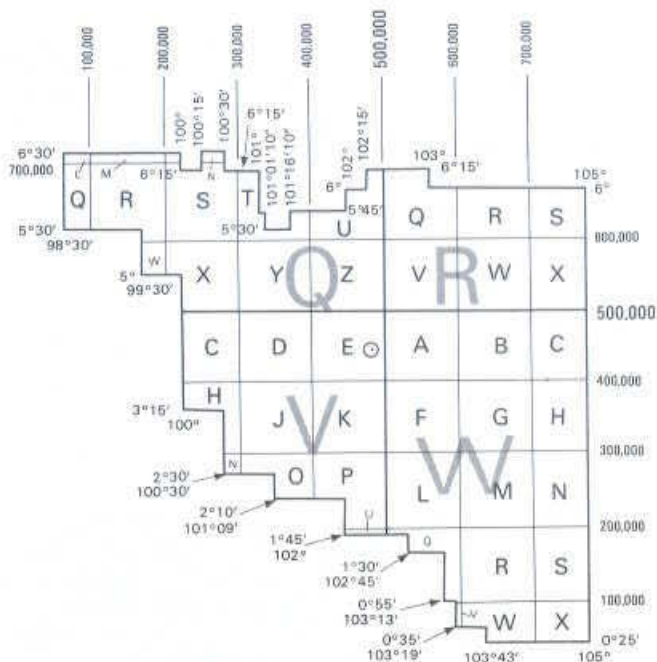

PROJECTION: Rectified Skew Orthomorphic

ELLIPSOID: Modified Everest

UNIT: Meter

ORIGIN: 4°N., 102°15'E.

FALSE COORDINATES OF ORIGIN: 472,854 meters E., 442,420 meters N.

SCALE FACTOR: .99984

INCIDENCE OF GRID LETTERS: Normal

GRID TABLES: Not Available

GRID "COLOR": Black

REFERENCING FOR 1,000-METER GRID (6-digit numerical reference):

Principal digits: (2); 10,000, 1,000

REFERENCING FOR 10,000-METER GRID (4-digit numerical reference):

Principal digits: (1); 10,000

REFERENCING FOR 100,000-METER GRID (2-digit numerical reference):

Principal digits: (1); 10,000

CHAPTER 5

GEOGRAPHIC COORDINATE REFERENCES5-1 USE.

The use of geographic coordinates as a system of reference is accepted worldwide. It is based on the expression of position by latitude (parallels) and longitude (meridians) in terms of arc (degrees, minutes, and seconds) referred to the Equator (north and south) and a prime meridian (east and west).

5-2 THE GEOGRAPHIC REFERENCE.

The degree of accuracy of a geographic reference is influenced by the map scale and accuracy requirements for plotting and scaling purposes.

Examples of references are:

- 40°N 132°E (In degrees of latitude and longitude)
- 40°21'N 132°14'E (To minutes of latitude and longitude)
- 40°21'12"N 132°14'18"E (To seconds of latitude and longitude)
- 40°21'12.4"N 132°14'17.7"E (To tenths of seconds of latitude and longitude)
- 40°21'12.45"N 132°14'17.73"E (To hundredths of seconds of latitude and longitude)

5-3 GEOGRAPHIC COORDINATES ON MAPS AND CHARTS.

5-3.1 U.S. military maps and charts include a graticule (parallels and meridians) for plotting and scaling geographic coordinates. Graticule values are shown in the map margin.

5-3.2 On most maps and charts at the scale of 1:1,000,000, the parallels and meridians are shown by intersections or full lines at one-degree intervals. The intersections or lines are labeled in degree values.

5-3.3 On maps and charts at the scale of 1:500,000, parallels and meridians are shown by full lines at 30-minute intervals. The full degree lines are labeled in degree values; the intermediate lines are labeled in minutes only.

5-3.4 On maps and charts at scales of 1:250,000 and larger the graticule may be indicated in the map interior by lines or ticks at prescribed intervals. The following indicates these intervals:

Scale	Tick Interval	Labeling at Corners ¹	Labeling of ticks
1:250,000	15 minutes	Degrees-minutes	15 minutes
1:100,000	10 minutes	Degrees-minutes	10 minutes
1:50,000	1 minute	Degrees-minutes-seconds	5 minutes
1:25,000	1 minute	Degrees-minutes-seconds	5 minutes
1:12,500	1 minute	Degrees-minutes-seconds	1 minute

Table 7. Corner Labeling on Topographic Maps.

¹ When departing from standard sheet lines to avoid unnecessary sheets or because of datum changes, corners are labeled to 1 second for 1:250,000 and 1:100,000 scale and to 0.1 second for 1:50,000 to 1:12,500 scale.

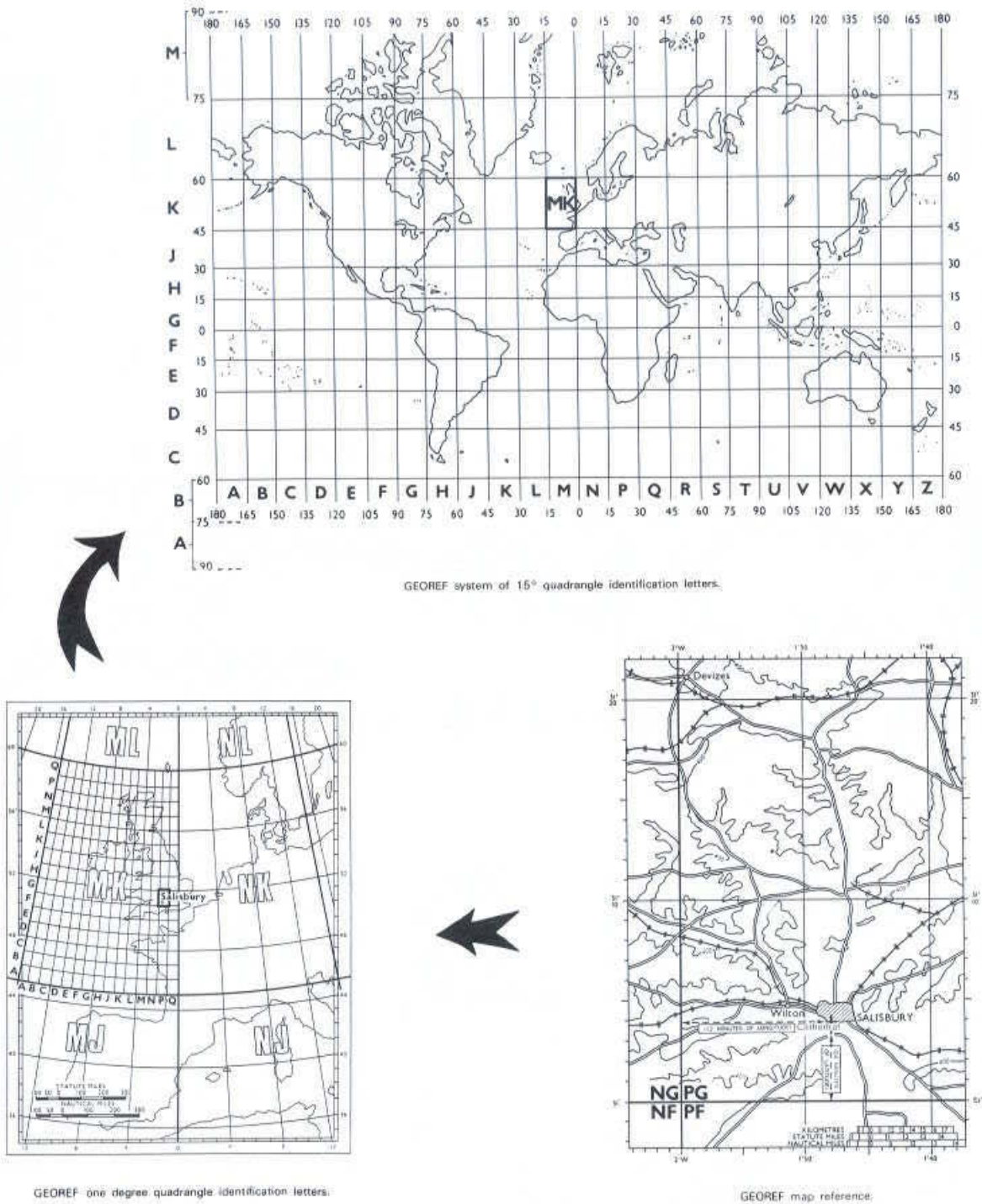

Figure 12. World Geographic Reference (GEOREF) System.

5-3.5 On Joint Operations Graphics (JOG), between 0° and 76°, meridians are shown by full lines at 15-minute intervals with 1-minute ticks. Between 76° and 84° North and between 76° and 80° South, meridians are shown by full lines at 30-minute intervals with 1-minute ticks.

5-4 THE WORLD GEOGRAPHIC REFERENCE SYSTEM.

5-4.1 The World Geographic Reference System (GEOREF) is a system used for position reporting. It is not a military grid, and therefore does not replace existing military grids. It is an area-designation method used for interservice and interallied position reporting for air defense and strategic air operations. Positions are expressed in a form suitable for reporting and plotting on any map or chart graduated in latitude and longitude regardless of map projection.

5-4.2 The system divides the surface of the earth into quadrangles, the sides of which are specific arc lengths of longitude and latitude; each quadrangle is identified by a simple systematic letter code giving positive identification with no risk of ambiguity.

5-4.2.1 There are 24 longitudinal zones each of 15 degrees width extending eastward from the 180° meridian around the globe through 360 degrees of longitude. These zones are lettered from A to Z inclusive (omitting I and O). There are 12 bands of latitude each of 15 degrees height, extending northward from the South Pole. These bands are lettered from A to M inclusive (omitting I) northward from the South Pole. This code divides the earth's surface into 288 15 degree quadrangles, each of which is identified by two letters. The first letter is that of the longitude zone and the second letter that of the latitude band. Thus the major part of the United Kingdom is in the 15 degree quadrangle MK. See figure 12.

5-4.2.2 Each 15 degree quadrangle is sub-divided into 15 one degree zones of longitude, eastward from the western meridian of the quadrangle, these one degree units being lettered from A to Q inclusive (omitting I and O). Each 15 degree quadrangle is also sub-divided into 15 one degree bands of latitude northward from the southern parallel of the quadrangle, these bands being lettered from A to Q inclusive (omitting I and O). A one degree quadrangle anywhere on the earth's surface may now be identified by four letters. Salisbury therefore is in the one degree quadrangle MKPG. See figure 12.

5-4.2.3 Each one degree quadrangle is divided into 60 minutes of longitude, numbered eastward from its western meridian, and 60 minutes of latitude, numbered northward from its southern parallel. This direction of numbering is used wherever the one degree quadrangle is located, i.e., it does not vary even though the location may be west of the prime meridian or south of the equator. A unique reference defining the position of a point to an accuracy of one minute in latitude and longitude (i.e., 2 kms or less) can now be given by quoting four letters and four numerals. The four letters identify the one degree quadrangle. The first two numerals are the number of minutes of longitude by which the point lies eastward of the western meridian of the one degree quadrangle, and the last two numerals are the number of minutes of latitude by which the point lies northward of the southern parallel of the one degree quadrangle. If the number of minutes is less than 10 minutes, the first numeral will be a zero and must be written, e.g., 04. The GEOREF of Salisbury Cathedral is MK PG 12 04. See figure 12.

5-4.2.4 Each of the one degree quadrangles may be further divided into decimal parts (1/10 th and 1/100 th) eastward and northward. Thus, four letters and six numerals will define a location to 0.1-minute; four letters and eight numerals will define a location to 0.01-minute.

CHAPTER 6

PORTRAYAL OF GRIDS ON MAPS AT 1:100,000 SCALE AND LARGER

6-1 GENERAL.

6-1.1 Requirements for grid data and grid formats on maps prepared for the DoD at 1:100,000 scale and larger are essentially the same for Universal Transverse Mercator grids, Universal Polar Stereographic grids and nonstandard grids.

6-1.2 The grid data for DoD maps usually include the major grid, a declination diagram, a grid reference box, and notes identifying the grid.

6-1.3 The adjacent grid is provided as an overlapping grid when a map lies within approximately 40 kilometers of a grid junction line or a datum junction boundary. A separate declination diagram and notes identifying the overlapping grid appear in the margin for grid junctions, and may or may not appear for datum junctions, depending on grid alignments.

6-1.4 A map may show a secondary grid which occurs in the area. The secondary grid is identified by margin notes.

6-1.5 Normally, no single map of a foreign area in this scale category ever shows more than three grids. When a sheet covers an area which includes more than three grids (either major, overlapping, or secondary), those omitted are the ones which are considered of least military importance. Major grids are never omitted. When choice lies between two overlapping grids, the one retained usually is the one which occurs most frequently on the sheets in the general area. Domestic maps may show up to five grids.

6-1.6 Specific dimensions, size and style of type, and placement of margin data relating to grids and grid formats at 1:100,000 scale and larger are contained in DMA product specifications.

6-2 THE MAJOR GRID.

6-2.1 The major grid is indicated by full lines at 1,000-unit intervals. Every 10,000-unit grid line is accentuated in weight.

6-2.2 Grid numbers appear outside the neatline on all four sides of the sheet, labeling each grid line. Where a grid line coincides with a neatline of the map, the grid line is omitted, but the neatline is labeled in the margin with the values for the grid line.

6-2.3 Basically, all grid lines are labeled with two principal digits which represent the 10,000- and 1,000-unit values of the grid line, respectively. Some variations to this basic labeling are:

6-2.3.1 On all 10,000-unit grid lines, the basic two principal digits are preceded by the 100,000-unit digits. See figures 13 and 14.

6-2.3.2 On sheets with one major grid, only the first grid lines in each direction from the southwest corner are given full coordinate values. See figures 13 and 14.

6-2.3.3 On sheets containing grid zone junctions, junctions of major grids, or datum junctions, the first grid lines in each direction from all four corners are given full coordinate values. See figures 15, 16, and 18.

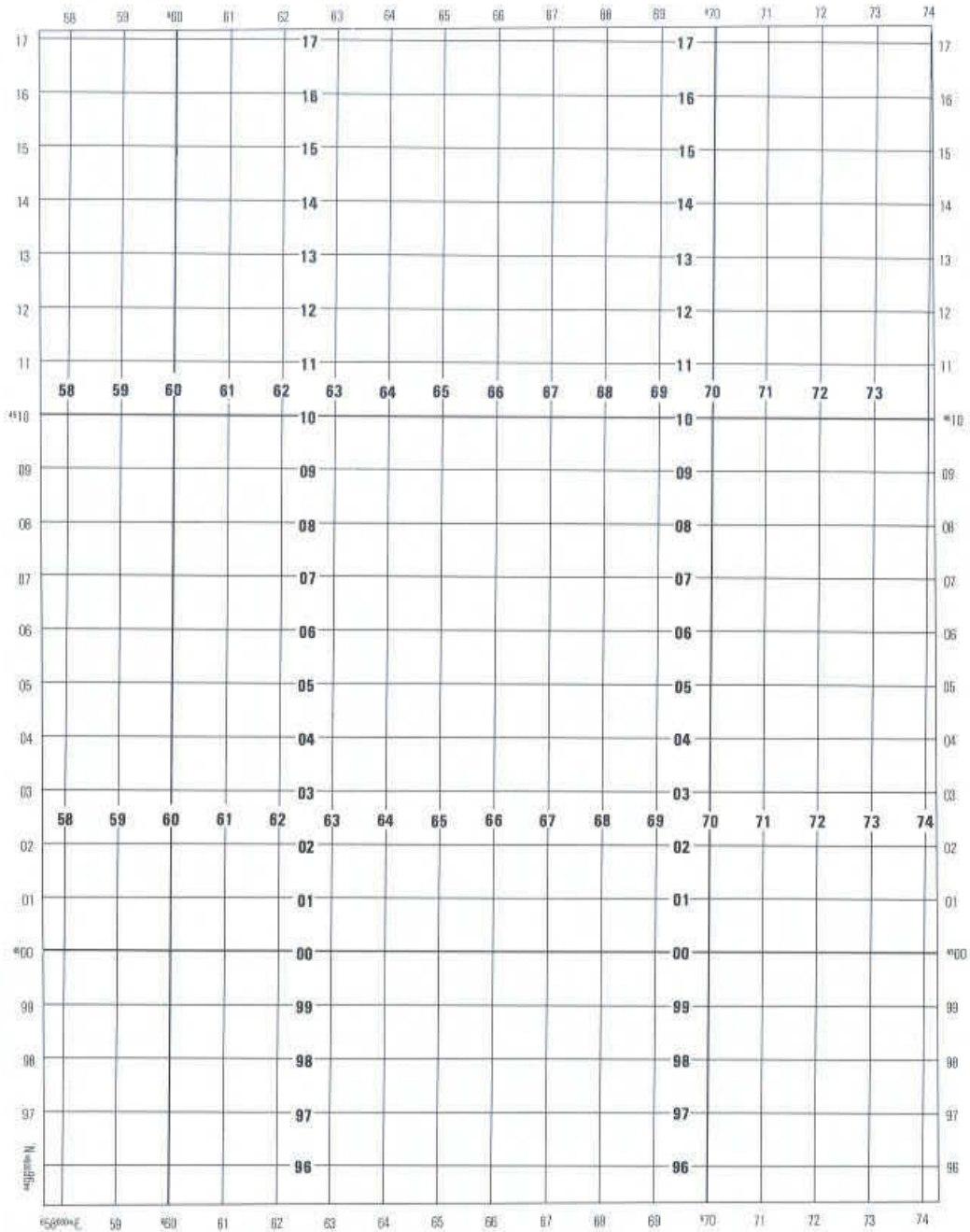

ELLIPSOID WORLD GEODEIC SYSTEM
 GRID 1,000 METER UTM ZONE 49

Scale: 1:50,000 (in miniature)

Figure 13. The Major Grid as Shown on a 1:50,000 Scale Map.

6-2.3.4 On sheets showing the major and overlapping grids, the first grid line and grid tick in each direction from the southwest corner are given the full coordinate values for both grids. See figure 17.

6-2.3.5 On the Madagascar grid and the Lambert grids of northwest Africa, use three principal digits to represent the 100,000-, 10,000-, and 1,000-meter values of the grid lines.

6-2.4 The grid lines in the map interior contain a pattern of grid value labels (principal digits) designed to assist in position referencing on a folded map. The pattern, referred to as a grid ladder, may appear in either of two forms:

6-2.4.1 One row (easting) and one column (northing) intersecting at the approximate center of the sheet.

6-2.4.2 Two rows (easting) and two columns (northing) intersecting at approximate one-third intervals across the sheet. The principal digits are centered between adjacent horizontal (northing) and vertical (easting) grid lines. The digits may be displaced or omitted if they impair the legibility of important map detail. Omissions are held to a minimum. Grid ladder treatments are illustrated in figures 13 and 14.

6-2.5 The color of the grid values is governed by the grid system.

6-2.5.1 Black (blue for 1:100,000 scale) is used when the major grid is the Universal Transverse Mercator or the Universal Polar Stereographic.

6-2.5.2 With nonstandard grids, the color varies. It may be black, blue, or red-brown. The color to be used with each particular nonstandard grid is specified in Chapter 4.

6-2.6 A note identifying the grid and ellipsoid appears in the lower margin of a sheet. The note is modeled after one of the following:

```
ELLIPSOID..... BESSEL
GRID..... 1,000 METER UTM ZONE 53
              (BLACK NUMBERED LINES)
```

```
ELLIPSOID..... INTERNATIONAL
GRID..... 1,000 METER MADAGASCAR
              (RED-BROWN NUMBERED LINES)
```

6-2.7 On maps having a land inset for which the grid or grid zone differs from that of the map proper, the appropriate grid note is shown within the inset.

6-2.8 Figures 13 and 14 illustrate the treatment for the major grid on DoD mapping at 1:50,000 and 1:100,000 scales.

6-3 MULTIPLE MAJOR GRIDS.

6-3.1 In certain instances a sheet contains more than one major grid.

6-3.1.1 With the UTM and UPS grids this may occur:

6-3.1.1.1 Where original sheet lines are retained as established by a mapping agency of a foreign country.

6-3.1.1.2 Where a sheet is shifted from the normal position to avoid making additional sheets.

6-3.1.2 With nonstandard grids, this condition occurs more frequently since, in addition to the above cases, grid junctions are sometimes loxodromes or are grid lines.

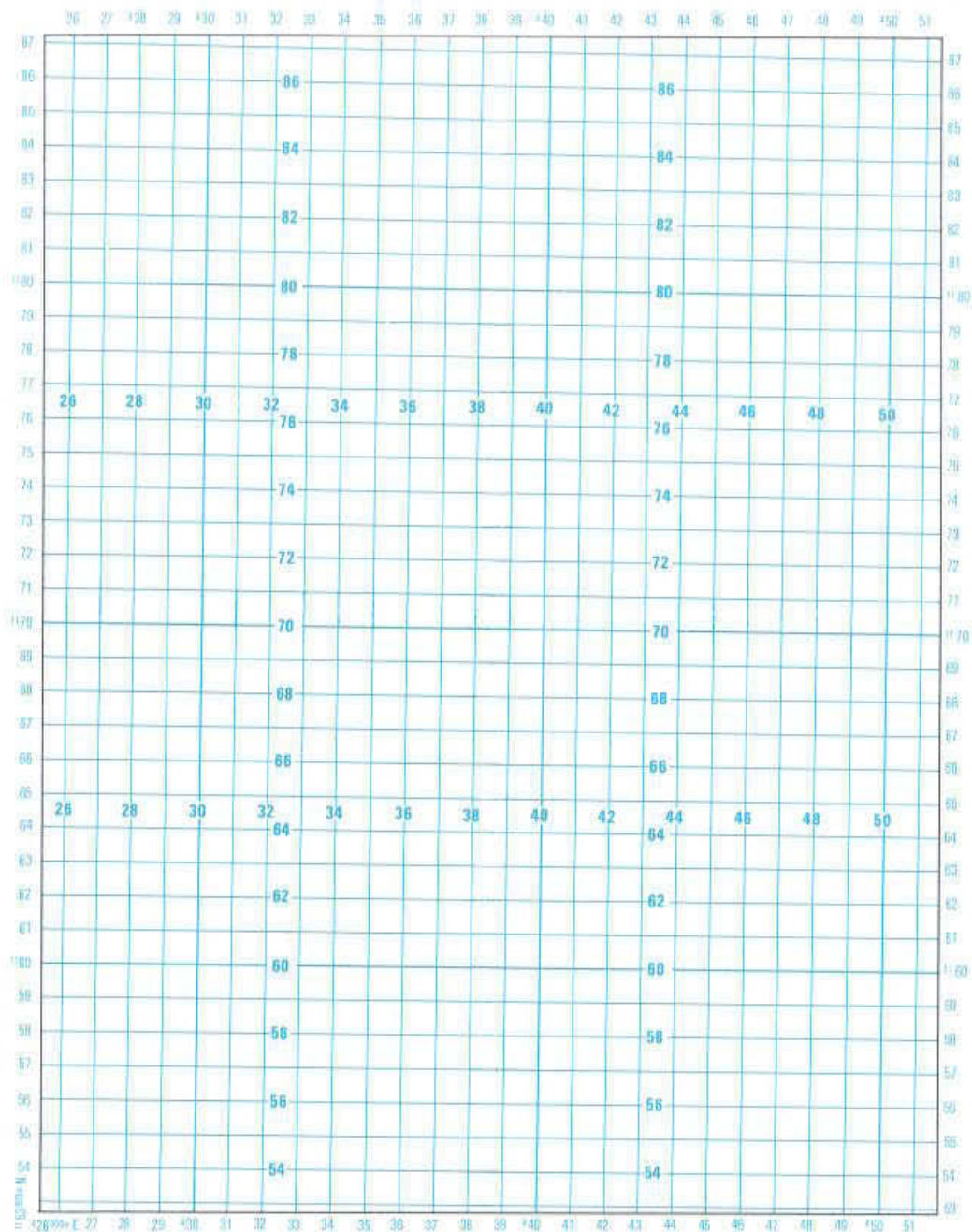

ELLIPSOID WORLD GEODETIC SYSTEM
 GRID 1,000 METER UTM ZONE 47

Scale 1:100,000 (in miniature)

Figure 14. The Major Grid as Shown on a 1:100,000 Scale Map.

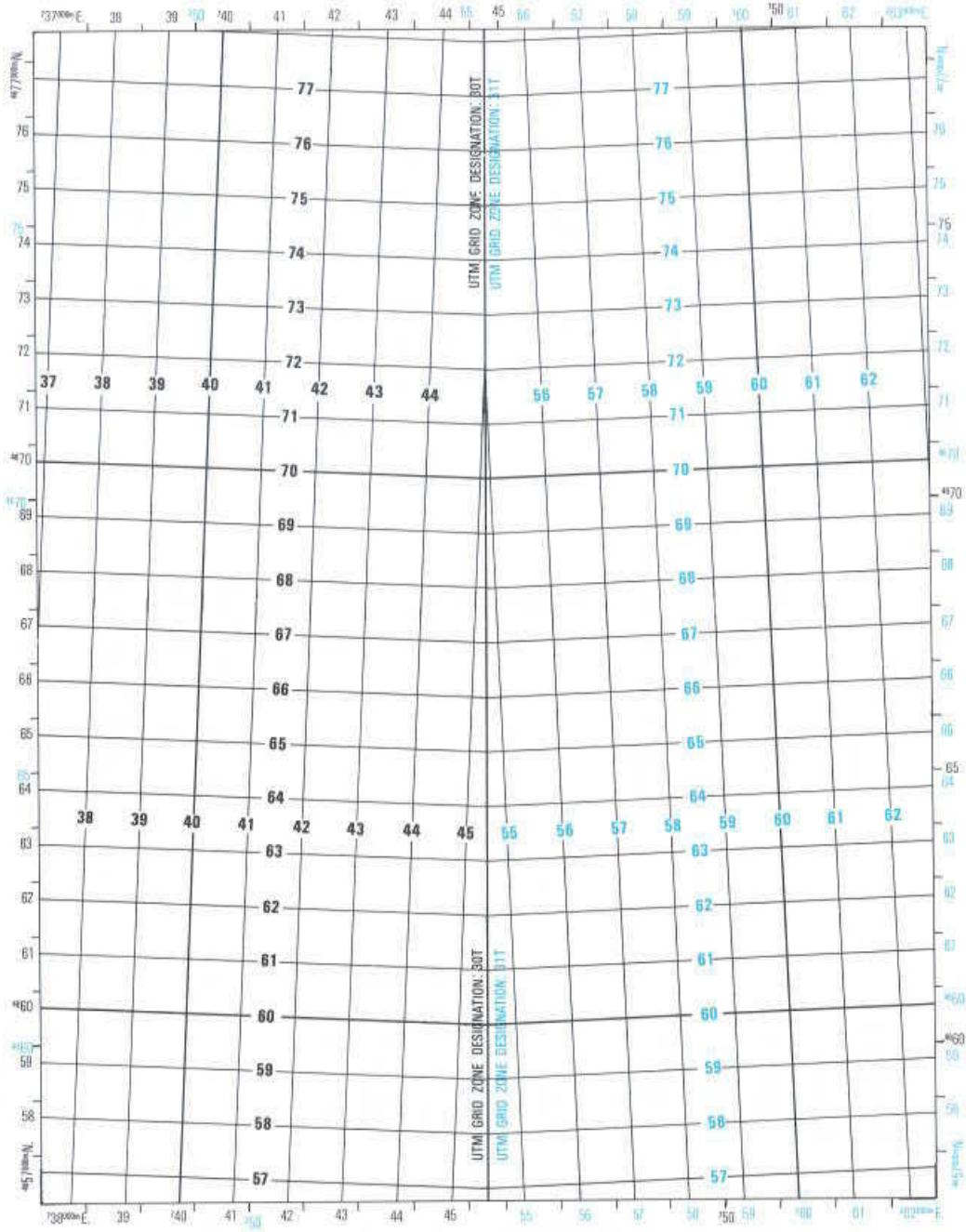

ELLIPSOID INTERNATIONAL
 GRID 1,000 METER UTM ZONE 30 (BLACK NUMBERED LINES AND TICKS)
 1,000 METER UTM ZONE 31 (BLUE NUMBERED LINES AND TICKS)

Scale 1:50,000 (in miniature)

Figure 15. Two Major Grids (in this case, Zones of the UTM) Separated by a Grid Junction as Shown on a Large Scale Map.

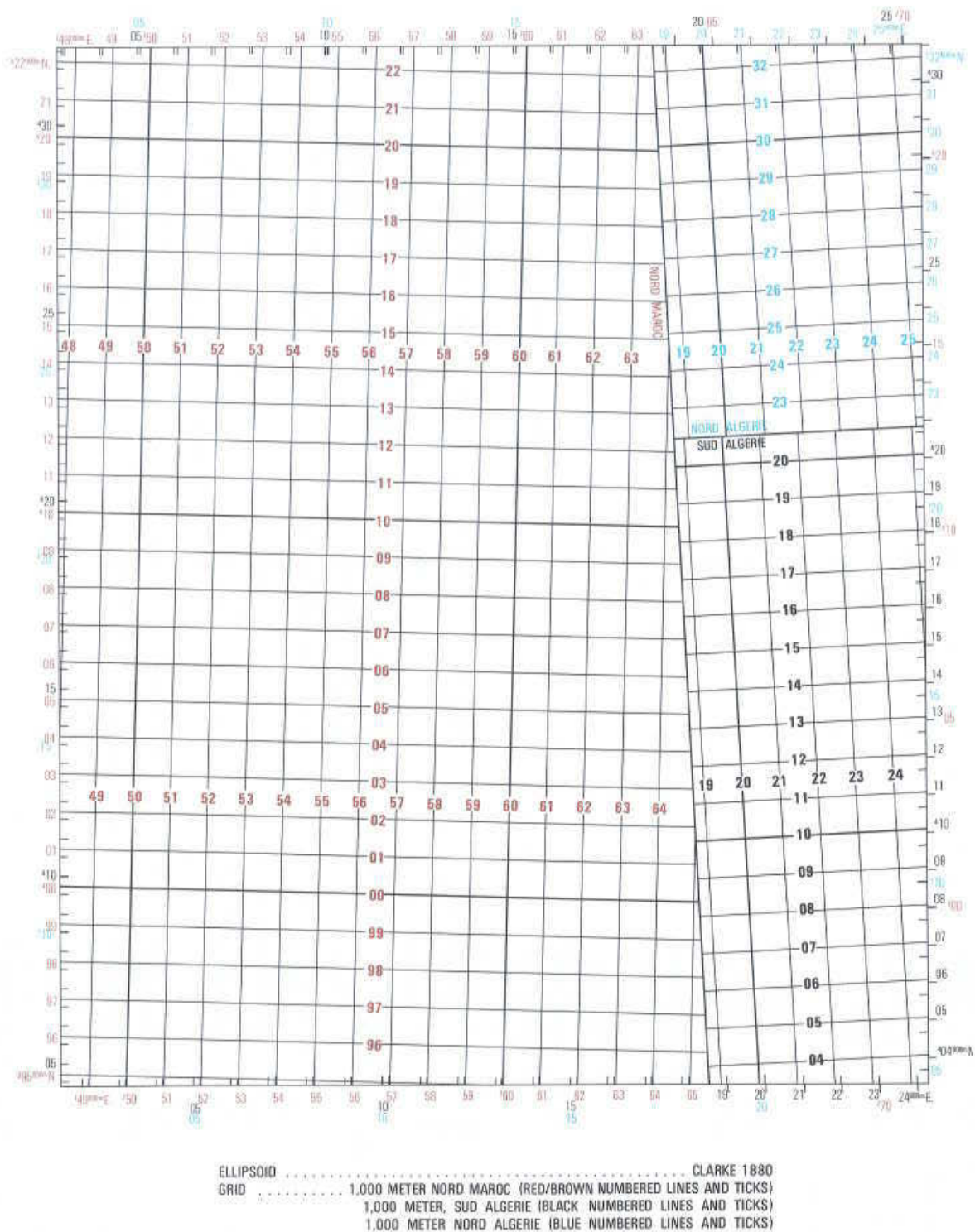

Scale 1:50,000 (in miniature)

Figure 16. Three Major Nonstandard Grids as Shown on a Large Scale Map.

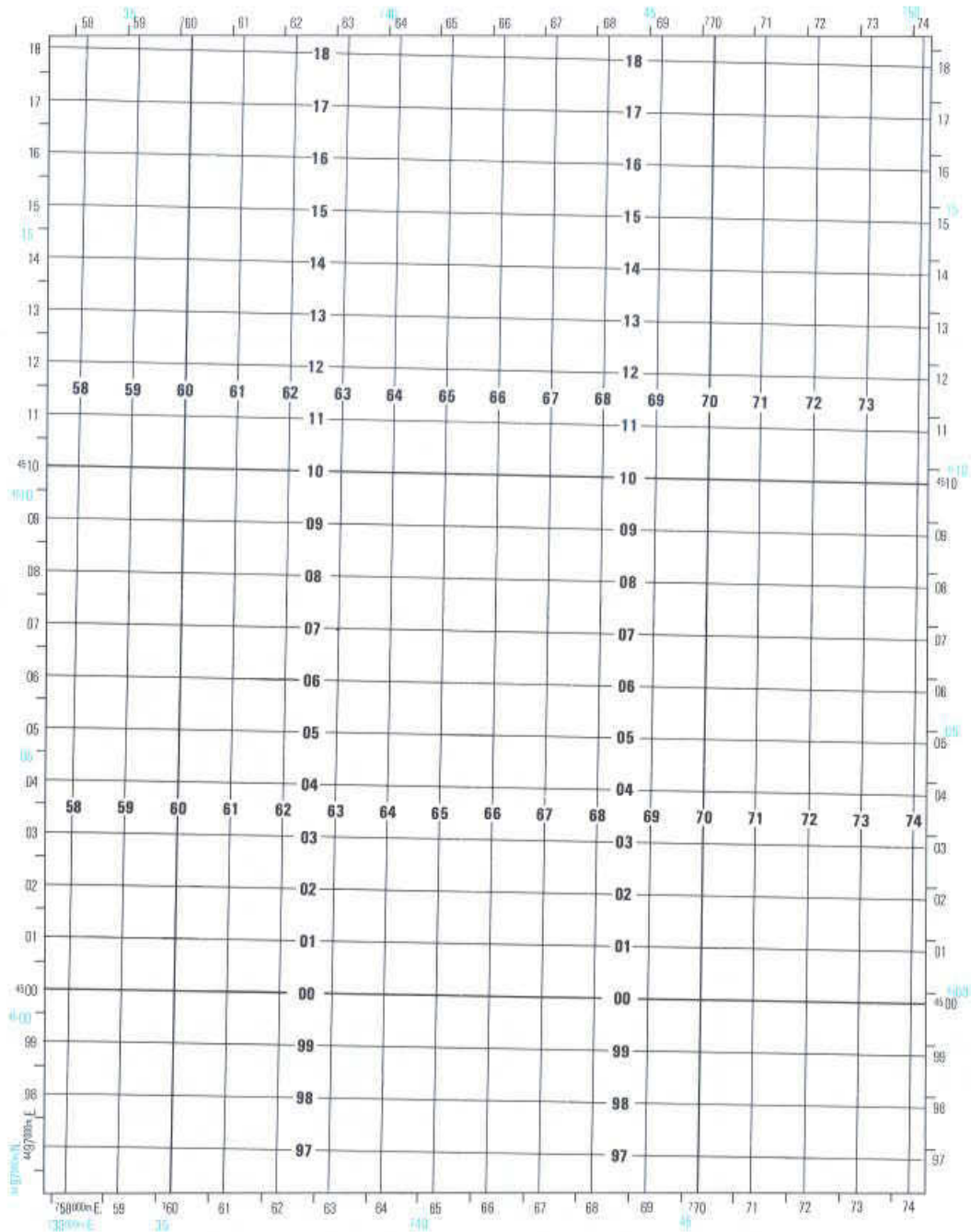

ELLIPSOID WORLD GEODETIC SYSTEM
 GRID 1,000 METER, UTM ZONE 47 (BLACK NUMBERED LINES)
 1,000 METER, UTM ZONE 48 (BLUE NUMBERED TICKS)

Scale 1:50,000 (in miniature)

Figure 17. Major and Overlapping Grids as Shown on a Large Scale Map.

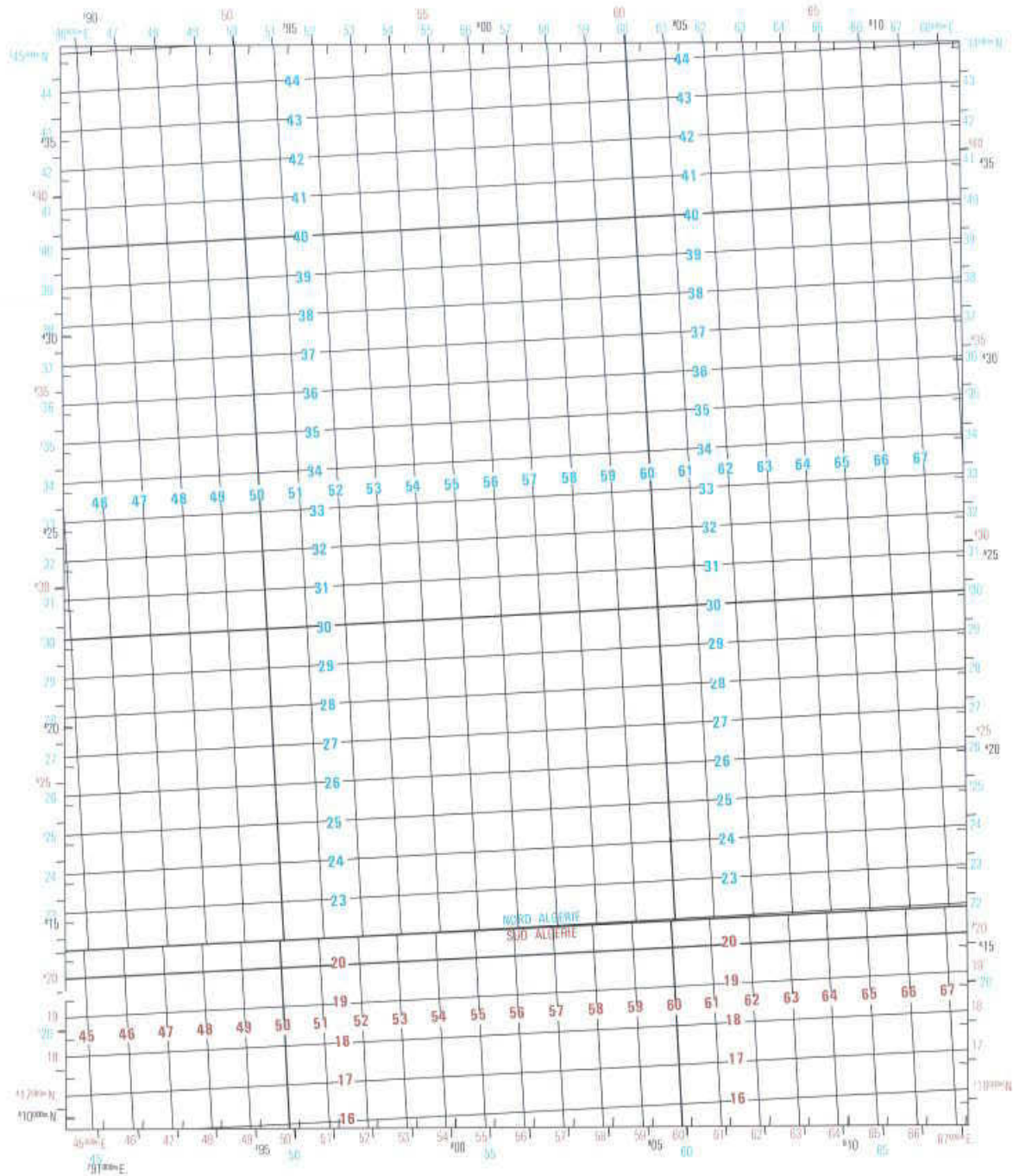

GRID 1,000 METER, NORD ALGERIE, CLARKE 1880 ELLIPSOID
 (BLUE NUMBERED LINES AND TICKS)
 1,000 METER, SUD ALGERIE, CLARKE 1880 ELLIPSOID
 (RED / BROWN NUMBERED LINES AND TICKS)
 1,000 METER, NORD MAROC, CLARKE 1880 ELLIPSOID
 (BLACK NUMBERED TICKS)

Scale 1:50,000 (in miniature)

Figure 18. Overlapping Grid in Combination with Two Major Grids Separated by a Grid Junction as Shown on a Large Scale Map.

6-3.2 Grid, datum, ellipsoid, and zone junctions are indicated by accentuated lines, printed in black (blue for 1:100,000 scale). Labels identifying the junction appear parallel to and on each side of the junction line. The labels may be shown more than once to facilitate identification. Each label is printed in the color designated for the particular grid system. When a grid, datum, ellipsoid, or zone junction line is coincident with a neatline, both the junction line and the identifying labels are omitted. If the junction line falls within 2.5 mm (0.10 inch) of the neatline, the junction line is not shown; it is considered as being coincident with the neatline.

6-3.2.1 For nonstandard grids, the label is modeled after the following:

WEST MALAYSIAN RSO GRID
 SUD MAROC GRID
 NORD TUNISIE GRID
 MADAGASCAR GRID

6-3.2.2 The label for a UTM grid junction, or a UPS grid junction, includes the identification of the Grid Zone Designation and is written in MGRS terms as:

UTM GRID ZONE DESIGNATION: 47T
 UPS GRID ZONE DESIGNATION: B

6-3.3 Each grid is shown by full lines within its own area only, being represented at 1,000-unit intervals with every 10,000-unit line accentuated in weight.

6-3.3.1 On maps bearing two major grids, the extension of either grid into the area of the other (overlapping grid) is shown by outside ticks emanating from the neatline correctly aligned with its respective major grid. The even 10,000-unit ticks are accentuated in weight.

6-3.3.2 On maps bearing three major grids, a similar practice is followed, except that outside ticks are used to indicate the extension of the grid which occupies the major part of the sheet, and inside ticks are used to indicate the extensions of the others.

6-3.4 Grid values appear on all four sides of the sheet labeling each grid line and those grid ticks whose values are multiples of 5,000. Full values appear at each corner, labeling the first grid line in each direction from the corner.

6-3.4.1 For the UTM and UPS grids, the values for the different grids appear in black and blue. Black is reserved for the grid which covers the greater portion of the sheet. If the grid junction divides the sheet equally, black is used for the grid which occurs most frequently on the sheets in the general area. On maps at 1:100,000 scale, blue is used for the dominant grid and red-brown for the other grid.

6-3.4.2 For nonstandard grids, the values appear in the colors designated for the grid system. Where the designated colors are the same, one or more substitutions are made to emphasize distinction, with the order of preference as follows: black, blue, red-brown (or blue, red-brown, black at 1:100,000 scale).

6-3.4.3 Black is used for the UTM or UPS grids when either appears in combination with nonstandard grids. In such cases, if the conventional color for a nonstandard grid is black, a substitution is made for the nonstandard grid with blue, or red-brown being used. On maps at 1:100,000 scale, the order of colors is blue, red-brown, black.

6-3.5 Grid values, expressed in principal digits only, appear on the face of the map labeling each grid line. Refer to figures 15, 16, and 18 for sample treatments of the grid ladder numbers when a sheet contains more than one major grid.

6-3.6 Notes identifying each grid appear in the lower margin of the sheet. The notes are modeled after the following:

ELLIPSOID WORLD GEODETIC SYSTEM
GRID 1,000 METER UTM ZONE 47
(BLACK NUMBERED LINES AND TICKS)
1,000 METER UTM ZONE 48
(BLUE NUMBERED LINES AND TICKS)

6-3.7 When the ellipsoid is not the same for each of the grids shown on the map, the ellipsoids are included with the grid notes. The notes are patterned after the following:

GRID 1,000 METER UTM ZONE 31, INTERNATIONAL ELLIPSOID
(BLACK NUMBERED LINES AND TICKS)
1,000 METER UTM ZONE 32, CLARKE 1880 ELLIPSOID
(BLUE NUMBERED LINES AND TICKS)

6-3.8 Figures 15 and 16 illustrate the treatments described for sheets containing more than one major grid.

6-4 OVERLAPPING GRIDS.

6-4.1 An overlapping grid is generally required within approximately 40 kilometers of a grid, zone, or ellipsoid junction. The overlapping grid may be omitted if there are no land bodies within the 40 kilometer overlap area. See table 8.

6-4.2 The overlapping grid is shown by ticks printed in black (blue for 1:100,000 scale) emanating from the neatline correctly aligned with its respective grid and spaced at 1,000-unit intervals. The even 10,000-unit ticks are accentuated in weight. The direction of the ticks from the neatline (i.e., inside or outside) is dependent on the other grids shown on the map.

6-4.2.1 If the sheet contains one major grid, outside ticks are used.

6-4.2.2 If the sheet contains two major grids, inside ticks are used.

6-4.2.3 If a sheet contains two overlapping grids in conjunction with a single major grid, outside ticks are used for the overlapping grid which occurs most frequently on the sheets in the general area. Inside ticks are used for the other.

6-4.3 Values, similar in composition to those labeling the major grid lines, appear on all four sides of the sheet. The first grid tick in each direction from the southwest corner of the sheet whose values are multiples of 5,000 are labeled.

6-4.4 The color of the overlapping grid values is governed by the grid system. Where the prescribed color for two overlapping grids is the same, the color of the grid which occurs more frequently on the sheets in the general area is retained, and a substitution of black, blue, or red-brown, in that order of preference, is made for the other. (The order of preference for 1:100,000 scale is blue, red-brown, or black.) A similar substitution is made when the color of an overlapping grid is the same as the major grid.

6-4.5 Notes identifying overlapping grids appear in the lower margin of each sheet.

0°	21'41"	30°	25'01"	60°	43'16"
1°	21'41"	31°	25'17"	61°	44'37"
2°	21'42"	32°	25'33"	62°	46'04"
3°	21'43"	33°	25'50"	63°	47'38"
4°	21'44"	34°	26'08"	64°	49'20"
5°	21'46"	35°	26'27"	65°	51'10"
6°	21'48"	36°	26'46"	66°	53'10"
7°	21'51"	37°	27'07"	67°	55'20"
8°	21'54"	38°	27'29"	68°	57'43"
9°	21'57"	39°	27'52"	69°	1°00'20"
10°	22'01"	40°	28'16"	70°	1°03'13"
11°	22'05"	41°	28'41"	71°	1°06'24"
12°	22'10"	42°	29'08"	72°	1°09'58"
13°	22'15"	43°	29'36"	73°	1°13'56"
14°	22'21"	44°	30'06"	74°	1°18'26"
15°	22'27"	45°	30'37"	75°	1°23'36"
16°	22'33"	46°	31'10"	76°	1°29'21"
17°	22'40"	47°	31'44"	77°	1°36'05"
18°	22'48"	48°	32'21"	78°	1°43'58"
19°	22'56"	49°	32'59"	79°	1°53'17"
20°	23'04"	50°	33'40"	80°	2°04'28"
21°	23'13"	51°	34'23"	81°	2°18'10"
22°	23'23"	52°	35'09"	82°	2°35'18"
23°	23'33"	53°	35'57"	83°	2°57'21"
24°	23'43"	54°	36'49"	84°	3°26'46"
25°	23'55"	55°	37'43"	85°	4°08'58"
26°	24'07"	56°	38'41"	86°	5°09'49"
27°	24'19"	57°	39'43"	87°	6°52'57"
28°	24'32"	58°	40'49"	88°	10°19'15"
29°	24'46"	59°	42'00"	89°	20°38'19"

THE EQUIVALENT OF 40 KILOMETERS IS GIVEN AS
22 MINUTES OF LATITUDE WHEN MEASURED AT
ANY POINT ALONG A MERIDIAN.

TABLE 8. The equivalents of 40 kilometers when measured
along a given parallel of latitude expressed in
degrees, minutes, and seconds of longitude.

6-4.6 When the ellipsoid is not the same for the overlapping grid and the major grid, the ellipsoids are included with the grid notes. The notes are patterned after the following:

GRIDS..... 1,000 METER UTM ZONE 42, WORLD GEODETIC SYSTEM
ELLIPSOID (BLACK NUMBERED LINES)
1,000 METER UTM ZONE 41, INTERNATIONAL
ELLIPSOID (BLUE NUMBERED TICKS)

6-4.7 Figures 17 and 18 illustrate the treatments described for sheets containing major and overlapping grids.

6-5 SECONDARY GRIDS.

6-5.1 Secondary grids are temporary grids whose purpose is to provide a common grid to adjacent maps and on companion maps of different scales. Generally, after one printing of the secondary grid, it will be discontinued. Excepted are those instances where mapping arrangements with cooperating foreign agencies specify the showing of a secondary grid. No more than one secondary grid is shown.

6-5.2 When required, the secondary grid is shown by inside ticks, printed in black (blue for 1:100,000 scale), emanating from the neatline in their correct alignment and spaced at 1,000-unit intervals. The even 10,000-unit ticks are accentuated in weight.

6-5.3 Values, similar in composition to those labeling the major grid lines, appear on all four sides of the sheet. The first grid tick in each direction from the southwest corner of the sheet is labeled with full values. Thereafter, only those grid ticks whose values are multiples of 5,000 are labeled. If the secondary grid has a prescribed color, the color is used for the numbers unless there is conflict with another grid shown on the map. In that event, substitutions are made in the established order of preference.

6-5.4 A grid note, identifying the secondary grid, appears in the margin of the sheet.

6-5.5 When a secondary grid differs uniformly from the major grid, a coordinate shift note may be used in lieu of showing the secondary grid. The note should be patterned after the following:

COORDINATE CONVERSION WGS 84 TO ED
Grid: Add 30m.E., Subtract 9m.N.
Geographic: Add 1.1" Long., Subtract 0.1" Lat.

6-5.6 Figure 19 illustrates the treatment described for sheets containing major and secondary grids.

6-6 THE DECLINATION DIAGRAM (ONE GRID).

6-6.1 A declination diagram appears in the margin of each sheet. The diagram shows the relationship of magnetic north and true north to grid north at the center of the sheet. It also provides information regarding the use of this data. See figures 20 and 21.

6-6.2 The diagram contains three prongs which emanate from a central point. These represent grid north, magnetic north, and true north, and are appropriately labeled.

6-6.2.1 The grid north prong is an extension of an easting (vertical) grid line; the extension is a continuous line which stops at the central point near the bottom work limits of the sheet. The prong is broken for the letters GN.

6-6.2.2 The magnetic north prong emanates from the central point to the approximate

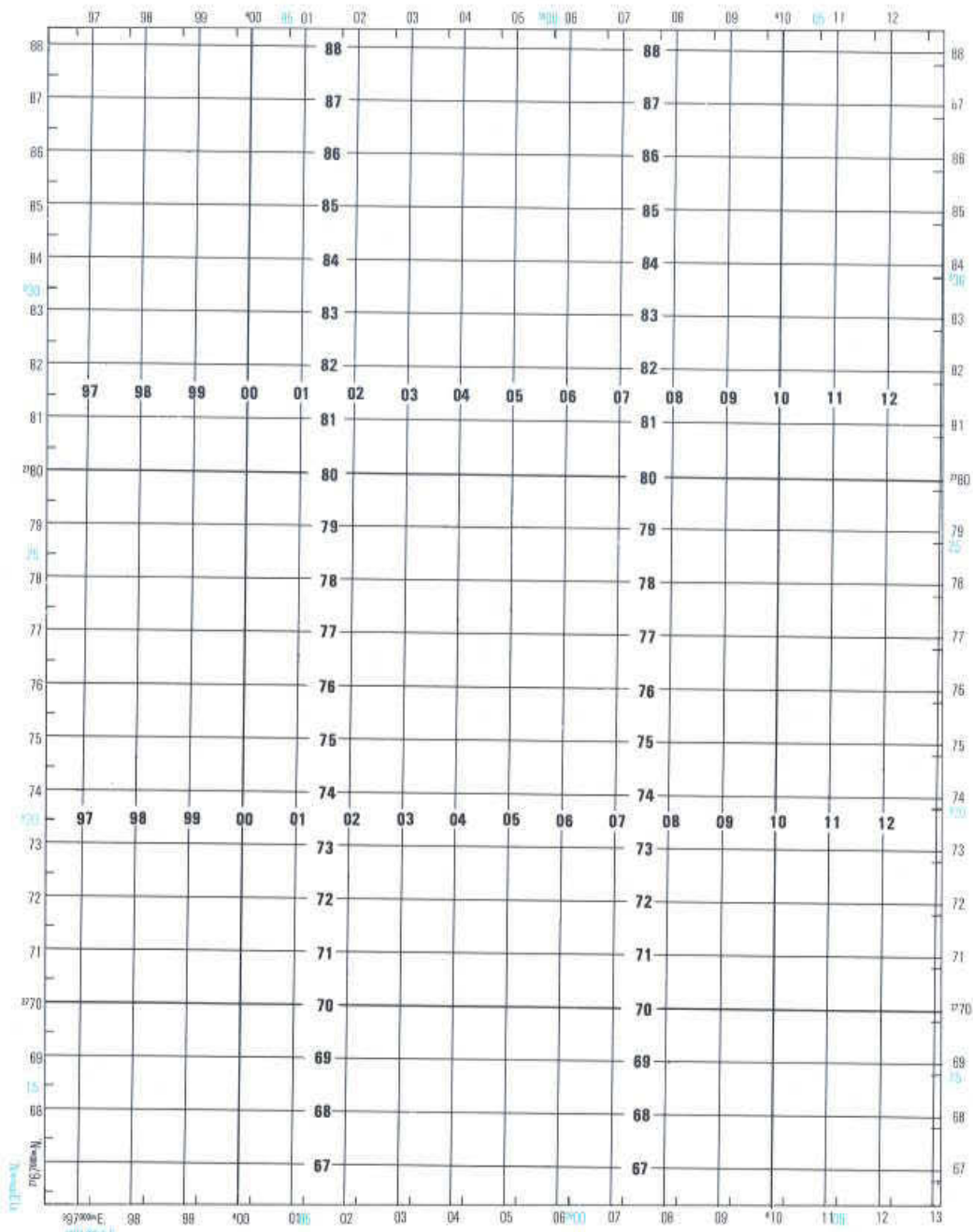

GRID1,000 METER UTM, ZONE 47, WORLD GEODETIC SYSTEM
 1972 ELLIPSOID (BLACK NUMBERED LINES)
 1,000 YARD INDIA II B, EVEREST ELLIPSOID
 (BLUE NUMBERED TICKS)

Scale 1:50,000 (in miniature)

Figure 19. Major and Secondary (Obsolete) Grids as Shown on a Large Scale Map

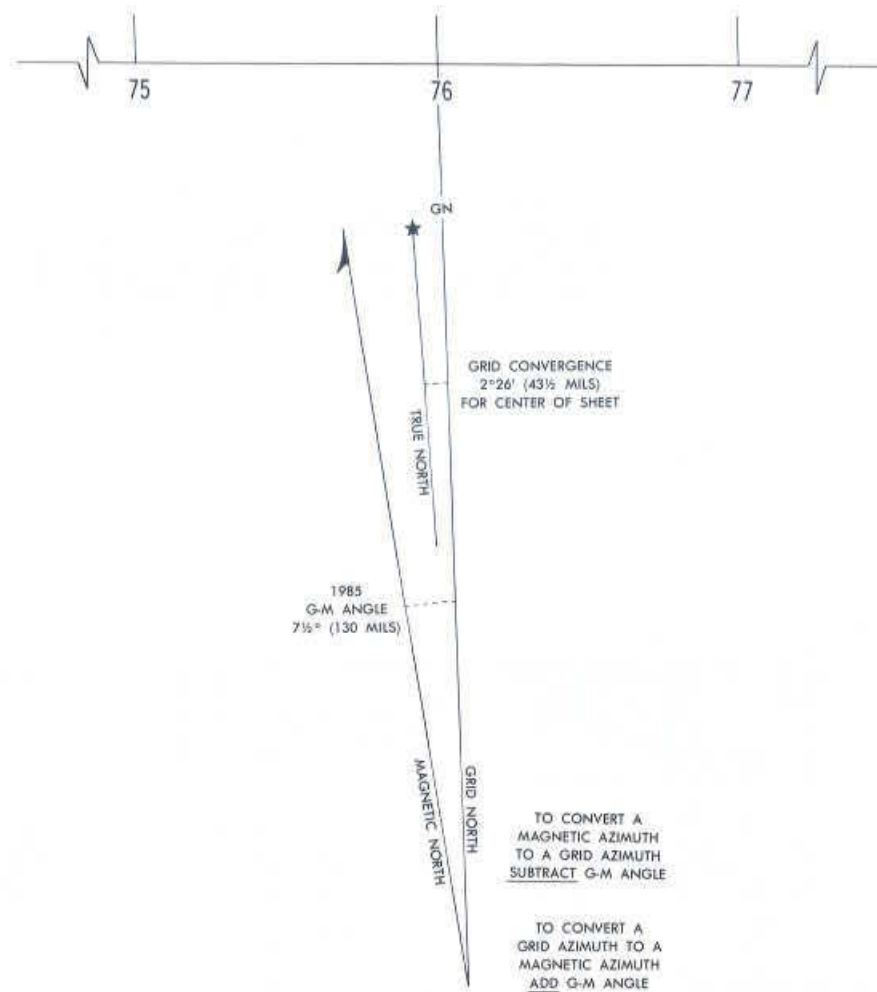

Figure 20. The Declination Diagram and Accompanying Notes with True North Appearing as the Center Prong.

extent of the letters GN. It is surmounted with a half-arrowhead; a left half-arrowhead is used when magnetic north lies to the west of grid north, while a right half-arrowhead is used when magnetic north lies to the east of grid north.

6-6.2.3 The true north prong, surmounted with a five-point star, is shorter in length than the other two prongs. When it occurs as the left or right prong of the diagram, it emanates from the central point. When true north occurs as the middle prong, its characteristic star appears at the approximate height of the magnetic north arrowhead; the prong is shown as an extension from the central point.

6-6.2.4 Angles between the prongs are approximately represented. The magnetic north and true north prongs are plotted within 30 minutes of their given angular position from grid north, except that the magnetic prong is never shown within three degrees of the grid north prong. In maintaining relative symmetry between prongs, the characteristic star of the true north prong must never touch another prong. When there is no declination

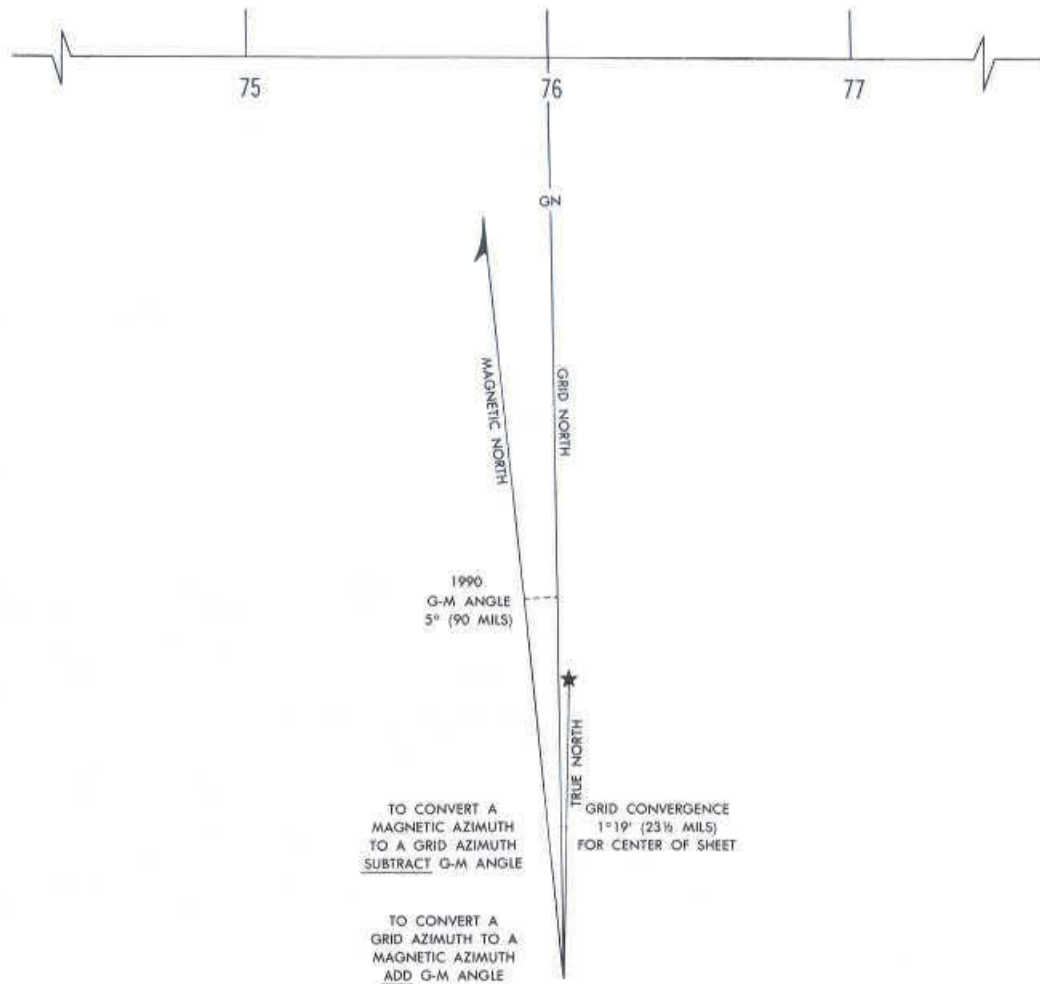

Figure 21. The Declination Diagram and Accompanying Notes with True North Appearing as an Outside Prong.

between prongs, a single prong represents the coincidence, and distinguishing characteristics (star, full arrowhead, or letters GN) of each are shown on the composite prong.

6-6.3 The grid-magnetic angle (G-M Angle) is expressed by a note alongside a dashed arc connecting the grid north and magnetic north prongs. The value of this angle is derived from the latest isogonic data for a standard epoch; i.e., a year that is divisible by five, such as 1990, 1995, etc. The value of the grid-magnetic angle is given to the nearest one-half degree with mil equivalent to the nearest ten mils. See Appendix A for a table of mil equivalents.

6-6.3.1 The grid-magnetic note is modeled after the following:

1990
G-M ANGLE
7 1/2° (130 MILS)

6-6.3.2 For sheets with 0° grid-magnetic angle the note is shown as follows:

1990
G-M ANGLE
0 (0 MILS)

6-6.3.3 For land insets, grid-magnetic data are shown only when the angle is different from that for the map proper. A diagram is not shown. The grid-magnetic data are shown by a note modeled after the following:

GRID TO MAGNETIC DECLINATION
FOR 1990 IS 1 1/2° (30 MILS)
WESTERLY OVER THE ENTIRE INSET

6-6.4 The grid convergence is the angle between grid north and true north. The value of the angle is expressed to the nearest full minute, with the mils equivalent to the nearest one-half mil.

6-6.4.1 In the diagram, the grid convergence is indicated by a note alongside a dashed arc which connects the grid north and true north prongs. The convergence angle is given for the center of the sheet and is modeled after the following:

GRID CONVERGENCE
1°19' (23 1/2 MILS)
FOR CENTER OF SHEET

6-6.4.2 In land insets, a diagram is not shown. The grid convergence is shown only when the angle is different from that on the map proper. The convergence angle is given for the center of the inset and is modeled after the following:

GRID TO TRUE NORTH CONVERGENCE
FOR THE CENTER OF THE INSET IS
1°54' (34 MILS) EASTERLY

6-6.5 Notes appear in conjunction with the diagram explaining the use of the G-M Angle.

6-6.5.1 When the magnetic north prong of the diagram is east of the grid north prong, the notes read as follows:

TO CONVERT A
MAGNETIC AZIMUTH
TO A GRID AZIMUTH
ADD G-M ANGLE

TO CONVERT A
GRID AZIMUTH TO A
MAGNETIC AZIMUTH
SUBTRACT G-M ANGLE

6-6.5.2 When the magnetic north prong of the diagram is west of the grid north prong, the notes read as follows:

TO CONVERT A
MAGNETIC AZIMUTH
TO A GRID AZIMUTH
SUBTRACT G-M ANGLE

TO CONVERT A
GRID AZIMUTH TO A
MAGNETIC AZIMUTH
ADD G-M ANGLE

6-6.5.3 When the magnetic north and grid north prongs are coincident, azimuth conversion notes are omitted.

6-6.5.4 Azimuth conversion notes are not shown for insets.

6-6.6 The diagram and related notes are printed in the same color as the grid values.

6-7 THE DECLINATION DIAGRAM (MORE THAN ONE GRID).

6-7.1 When a sheet bears more than one major grid, or major and overlapping grids, a separate diagram appears for each grid shown on the map. Declination data are not shown for secondary grids. Figure 22 illustrates the declination data shown on a sheet which contains more than one grid.

6-7.2 The grid north prong of each diagram is aligned with the easting (vertical) grid lines or grid ticks of the grid to which it pertains. No connection is shown between the grid north prong and any grid line or grid tick.

6-7.3 The composition of each diagram is the same as described in paragraph 6-6, except:

6-7.3.1 The diagram is miniaturized, and the three prongs are shown as full lines of the same length.

6-7.3.2 The minimum plotted angle between any two prongs is three degrees with relative symmetry maintained.

6-7.3.3 Each diagram bears the identification of the grid to which it pertains.

6-7.3.4 Each diagram and its related notes are printed in the same color as the grid values to which they pertain.

6-8 THE GRID REFERENCE BOX.

6-8.1 A grid reference box appears in the margin of each sheet. The box contains instructions and attendant data to enable the user to compose standard grid references.

6-8.2 The grid system(s) in use on the map dictates the referencing instructions contained in the grid reference box. The grid reference boxes most commonly used on maps, 1:100,000 scale and larger, are illustrated in figure 23. The boxes are subject to modifications.

6-8.3 The grid reference box also contains diagrams identifying applicable grid zone designations and grid square identifications.

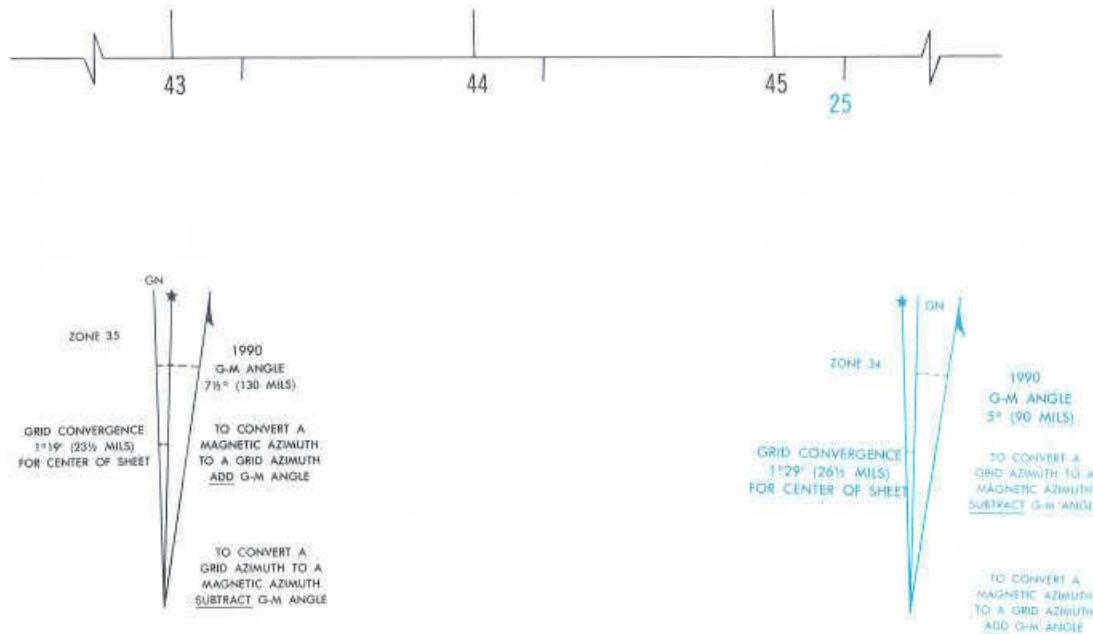

Figure 22. The Declination Data when a Sheet Contains an Overlapping Grid and/or More Than One Major Grid.

6-8.3.1 For the UTM and UPS grids, the diagrams show the grid zone designation, the 100,000-meter grid lines and their values in abbreviated form, and the 100,000-meter square identification(s). Figure 24 illustrates the composition of the diagrams under various conditions.

6-8.3.2 For nonstandard grids, the diagram shows the 100,000-unit square identifications and the values of the 100,000-unit grid lines in abbreviated form. These data are printed in the same color as the grid values to which they pertain. If the grid system identifies larger squares, their identifications are shown in smaller type just preceding the 100,000-unit identifications. The 100,000-unit grid lines and grid junction lines are printed in black (blue at 1:100,000 scale). If a junction is a grid line, its value is shown in abbreviated form and printed in the same color as the grid values to which it pertains. Loxodromes are not labeled. Figure 25 illustrates the composition of this information under various conditions.

<p>SAMPLE 1,000 METER GRID SQUARE</p> <p>100,000 M. SQUARE IDENTIFICATION</p> <p>GRID ZONE DESIGNATION</p>	<p style="text-align: center;">100 METER REFERENCE</p> <ol style="list-style-type: none"> 1. Read numbers labeling the VERTICAL grid line left of point and estimate tenths (100 meters) from grid line to point. 12 3 2. Read numbers labeling the HORIZONTAL grid line below point and estimate tenths (100 meters) from grid line to point. 45 6 <p style="text-align: center;">Example: 123456</p> <hr/> <p>WHEN REPORTING ACROSS A 100,000 METER LINE, PREFIX THE 100,000 METER SQUARE IDENTIFICATION, IN WHICH THE POINT LIES.</p> <p style="text-align: center;">Example:</p> <hr/> <p>WHEN REPORTING OUTSIDE THE GRID ZONE DESIGNATION AREA, PREFIX THE GRID ZONE DESIGNATION.</p> <p style="text-align: center;">Example:</p>
--	---

For use with UTM and UPS Grids.

<p>500,000 YARD (Small Letter) and 100,000 YARD (Large Letter) SQUARE IDENTIFICATIONS</p>	<p style="text-align: center;">TO GIVE A STANDARD REFERENCE</p> <p>SAMPLE POINT:</p> <ol style="list-style-type: none"> 1. Read letter identifying 100,000 yard square in which the point lies. 2. Locate first VERTICAL grid line to LEFT of point and read LARGE figure labeling the line either in the top or bottom margin or on the line itself. Estimate tenths from grid line to point. 3. Locate first HORIZONTAL grid line BELOW point and read LARGE figure labeling the line either in the left or right margin or on the line itself. Estimate tenths from grid line to point. <p>IGNORE the SMALLER figures of any grid number; these are for finding the full coordinates. Use ONLY the LARGER figure of grid number; example:</p> <p>SAMPLE REFERENCE:</p> <p>If reporting beyond 500,000 yards prefix with 500,000 Yard Square Identification as:</p>
---	---

For use with nonstandard grids which identify the 500,000 and 100,000 yard squares.

<p>500,000 METER (Small Letter) and 100,000 METER (Large Letter) SQUARE IDENTIFICATIONS</p>	<p style="text-align: center;">TO GIVE A STANDARD REFERENCE</p> <p>SAMPLE POINT:</p> <ol style="list-style-type: none"> 1. Read letter identifying 100,000 meter square in which the point lies. 2. Locate first VERTICAL grid line to LEFT of point and read LARGE figures labeling the line either in the top or bottom margin, or on the line itself. Estimate tenths from grid line to point. 3. Locate first HORIZONTAL grid line BELOW point and read LARGE figures labeling the line either in the left or right margin, or on the line itself. Estimate tenths from grid line to point. <p>IGNORE the SMALLER figures of any grid number; these are for finding the full coordinates. Use ONLY the LARGER figure of the grid number; example:</p> <p>SAMPLE REFERENCE:</p> <p>If reporting beyond 500,000 meters prefix with 500,000 Meter Square Identification as:</p>
---	--

For use with nonstandard grids which identify the 500,000 and 100,000 meter squares.

<p style="text-align: center;">TO GIVE A STANDARD REFERENCE</p> <p>IGNORE the SMALLER figures of any grid number; these are for finding the full coordinates. Use ONLY the LARGER figures of the grid number; example:</p> <p>SAMPLE POINT:</p> <ol style="list-style-type: none"> 1. Read sheet number 2. Locate first VERTICAL grid line to LEFT of point and read LARGE figures labeling the line either in the top or bottom margin, or on the line itself. Estimate tenths from grid line to point. 3. Locate first HORIZONTAL grid line BELOW point and read LARGE figures labeling the line either in the left or right margin, or on the line itself. Estimate tenths from grid line to point. <p>SAMPLE REFERENCE:</p>	
---	--

For use with nonstandard grids which do not identify the 100,000 unit squares.

Figure 23. Grid Reference Boxes Most Commonly Used on Maps at Scales of 1:100,000 and Larger.

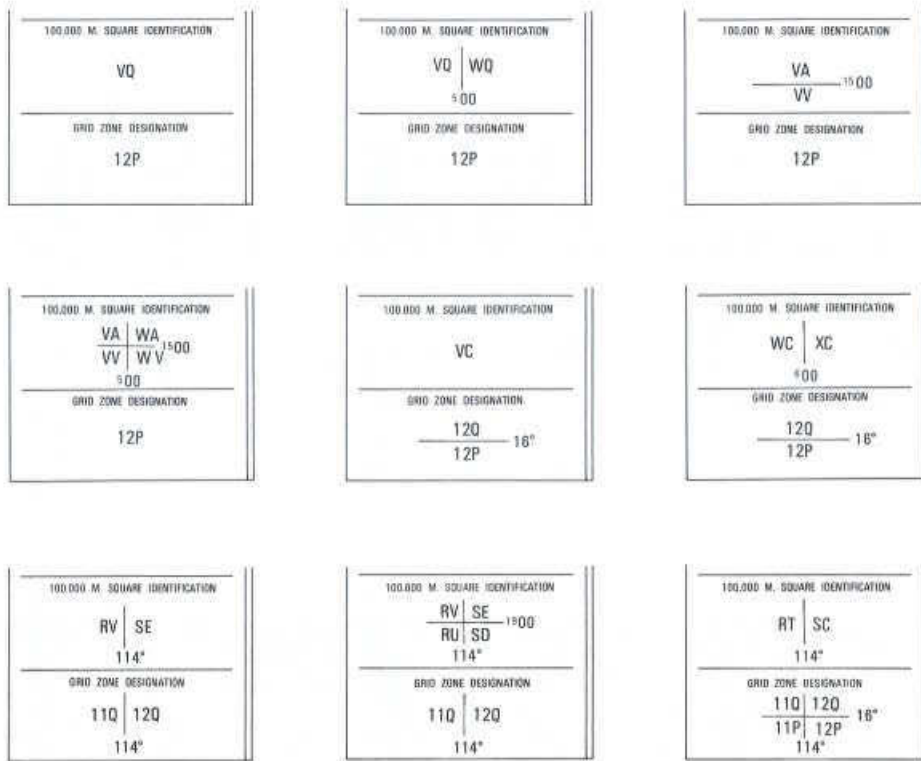

Figure 24. Methods of Showing Grid Zone Designations and 100,000-meter Squares of the UTM in the Grid Reference Boxes of Large Scale Maps.

6-8.3.3 For sheets that have a land inset whose 100,000-unit square identification letters differ from those of the map proper, the identification letters are shown in the interior of the inset, rather than in the grid reference box.

6-8.4 When more than one major grid appears on a sheet and the method for giving a reference is the same for all the grids, a common reference box is used.

6-8.5 When more than one major grid appears on a sheet and the method for giving a reference varies with the grids, circumstances control the treatment of the grid reference boxes.

6-8.5.1 A grid reference box is shown in the margin for each grid. Over each box appears a note limiting the use of the box to the grid or grids concerned.

6-8.5.1.1 When each box describes the method of referencing for one grid only, the note is printed in the same color as the values for its respective grid and is modeled after the following:

USE THIS BOX FOR GIVING REFERENCES ON THE
UNIVERSAL TRANSVERSE MERCATOR GRID

USE THIS BOX FOR GIVING REFERENCES ON THE
MADAGASCAR GRID

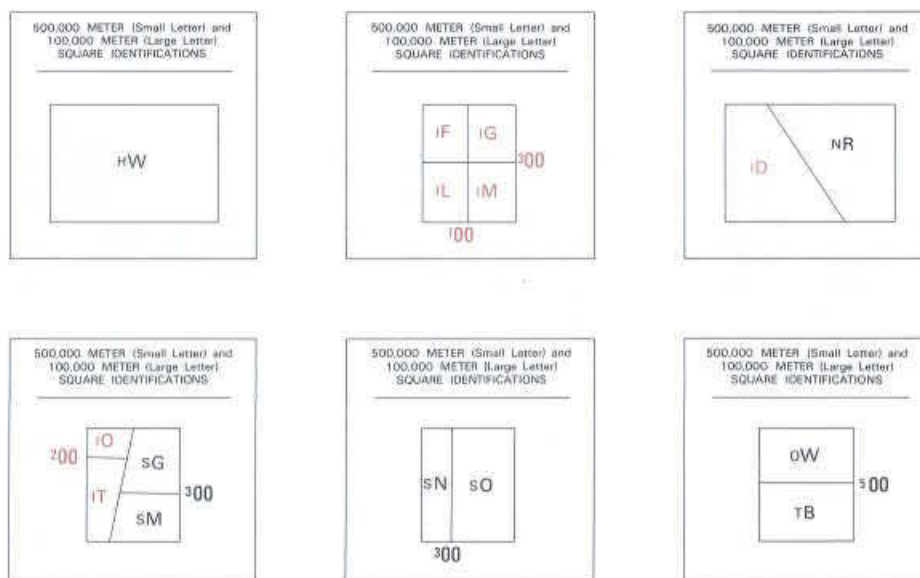

Figure 25. Methods of Showing 100,000-unit, and Larger, Square Identifications of Nonstandard Grids in the Grid Reference Boxes of Large Scale Maps.

6-8.5.1.2 When the same system of referencing is used for two grids occurring in the same sheet with a third grid which uses a different reference system, the note for the common reference box is printed in black and modeled after the following:

USE THIS BOX FOR GIVING REFERENCES ON THE
SUD ALGERIE AND SUD TUNISIE GRIDS

6-8.5.2 When all reference boxes cannot be accommodated in the margin, the excess is shown in expanses of open water on the face of the map. When this is not practicable, a note which refers the user to an adjacent sheet is added to a reference box in the margin. The notes are modeled after the following:

USE THIS BOX FOR GIVING REFERENCES ON THE
UNIVERSAL TRANSVERSE MERCATOR GRID

SEE SHEET 3987 I FOR GIVING REFERENCES ON
THE NORD MAROC GRID

USE THIS BOX FOR GIVING REFERENCES ON THE
UNIVERSAL TRANSVERSE MERCATOR GRID

SEE SHEET 1285 III FOR GIVING REFERENCES ON
THE SUD ALGERIE AND SUD TUNISIE GRIDS

CHAPTER 7PORTRAYAL OF GRIDS ON MAPS AT 1:250,000
AND 1:500,000 SCALE7-1 GENERAL.

7-1.1 Grid data and grid format for maps at scales of 1:250,000 and 1:500,000 are essentially the same for Universal Transverse Mercator grids, Universal Polar Stereographic grids, and nonstandard grids. When possible, sheet lines of maps at these scales are planned to coincide with grid junctions and ellipsoid junctions.

7-1.2 Grids added on reprints of maps of other origin adhere as closely as possible to these standards. There may be minor changes in limits of grid zones and variations in the color of grid lines and grid values. The changes and variations are explained, as necessary, in the margin of the map.

7-1.3 The grid data consist of grid lines and values, grid reference boxes, notes identifying the grids, and notes giving the range of magnetic declination over the sheet. Overlapping and extended grids are not shown.

7-1.4 Descriptions and illustrations are keyed to 1:250,000 scale, unless otherwise indicated. Specific dimensions, size and style of type, and placement of margin data relating to grids and grid formats at 1:250,000 scale are shown on DMA style sheets.

7-2 THE MAJOR GRID.

7-2.1 The major grid is shown by full lines printed in blue, at 10,000-unit intervals. The unit is predominately meters; yards are used for some nonstandard grids. Every 100,000-unit grid line is accentuated in weight and definitive designations are shown at their intersections in the map interior.

7-2.2 Grid values appear outside the neatline on all four sides of the sheet, labeling each grid line.

7-2.3 Where a grid line coincides with a neatline of the map, the grid line is omitted but the neatline is labeled with the values for the grid line. Except for the values labeling the first grid line in each direction from the southwest corner of the sheet, the last four digits (0000) of the values are omitted. The values are shown in two sizes of type, with the larger size being reserved for the principal digits.

7-2.3.1 With most grids, one principal digit is used. This represents the 10,000 digit of the grid values.

7-2.3.2 Two principal digits are used with the Madagascar grid, the Lambert grids of northwest Africa, and the Ceylon Belt. These represent the 100,000 and 10,000 digits of the grid values.

7-2.4 At 1:250,000 scale, a grid ladder is shown in the interior of the map. The grid ladder is an established pattern of columns and rows of grid values, expressed in principal digits only. Positioning of the columns and rows is illustrated in figure 26. In areas of dense detail, a ladder number may be moved along a grid line a maximum of one-fourth of the grid interval, or omitted if it impairs legibility of map detail. Omissions are held to a minimum.

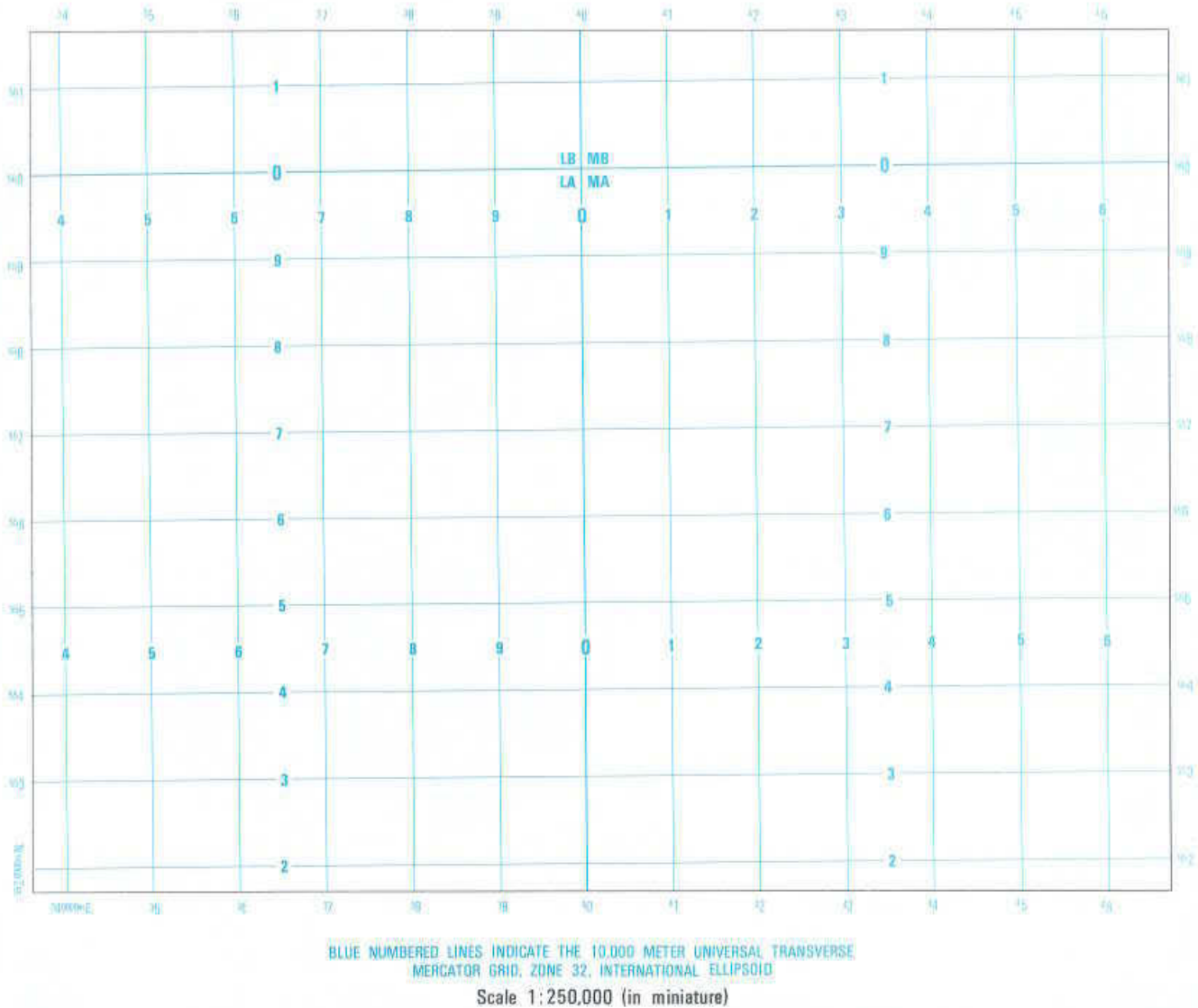

Figure 26. Treatment for the Major Grid in UTM Areas as Shown on a 1:250,000 Map.

7-2.4.1 At the intersection of two 100,000-unit grid lines, the appropriate unit square identification letters are always shown. When this intersection coincides with a neatline, only those identification letters falling inside the neatline are shown. Identification letters are similarly shown - inside the neatline - when the intersection of a 100,000-unit line with a grid or ellipsoid junction line coincides with a neatline. Both sides of the neatline to the north and east on a Joint Operations Graphic (JOG) should be labeled, however, to show the different identification in the overlap area.

7-2.4.2 For nonstandard grids which identify 100,000-unit and 500,000-unit squares, the 500,000-unit identification letter appears in smaller size immediately before the 100,000-unit square identification letter.

7-2.5 At the 1:500,000 scale, the grid ladder is designed to treat each specific 100,000-unit square. Figure 27 illustrates the treatment. Note the relationship of the ladder to the accentuated 100,000-unit lines. For non-standard grids which also identify larger grid squares - such as the 500,000-unit squares - the additional identifications appear in smaller type immediately before each 100,000-unit square identification.

7-2.6 The color of the grid values and ladder values is governed by the grid system.

7-2.6.1 Blue is used when the grid system is either the Universal Transverse Mercator or the Universal Polar Stereographic.

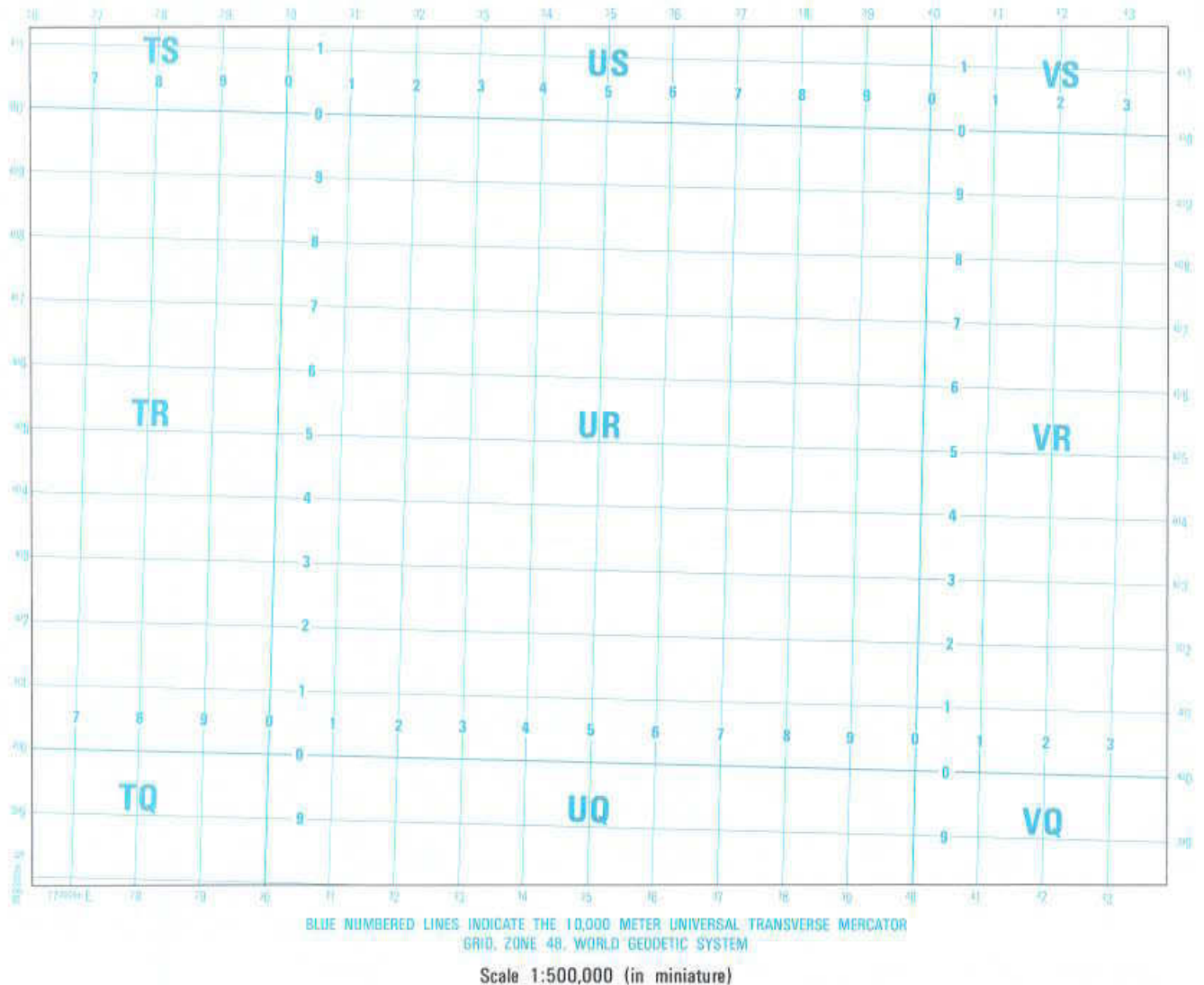

Figure 27. Treatment for the Major Grid in UTM Areas as Shown on Maps Smaller than 1:250,000 Scale and Larger than 1:1,000,000.

7-2.6.2 With nonstandard grids, the color varies - black, blue, or red-brown - as specified in Chapter 4. Sheets with nonstandard grids adhere to these color conventions. (For a JOG, black is substituted for red.)

7-2.7 A grid note printed in the same color as the values for the major grid appears in the lower margin of each sheet to identify the grid. The note is modeled after the following:

BLUE NUMBERED LINES INDICATE THE 10,000 METER
UNIVERSAL TRANSVERSE MERCATOR GRID, ZONE 53,
BESSEL ELLIPSOID

RED-BROWN NUMBERED LINES INDICATE THE 10,000 METER
MADAGASCAR GRID, INTERNATIONAL ELLIPSOID

BLACK NUMBERED LINES INDICATE THE 10,000 METER
BRITISH NATIONAL GRID, AIRY ELLIPSOID

7-2.7.1 On sheets having land insets for which the grid or grid zone differs from that of the map proper, the appropriate grid note is shown within the inset. (A JOG does not have insets.)

7-2.7.2 On maps with nonstandard grids, in addition to identifying the interval, grid, and ellipsoid, the note usually describes the projection, origin, false coordinates of the origin, and the scale factor of the grid.

7-3 MULTIPLE MAJOR GRIDS.

7-3.1 In certain instances a sheet contains more than one major grid.

7-3.1.1 With the UTM and UPS grids this may occur:

7-3.1.1.1 Where a sheet is shifted from the normal position to avoid making additional sheets.

7-3.1.1.2 In higher latitudes, where sheets may be wide in longitudinal extent.

7-3.1.1.3 At datum junctions.

7-3.1.2 With nonstandard grids, this condition occurs more frequently since grid junctions are sometimes loxodromes or are grid lines not coincident with parallels or meridians.

7-3.2 Grid, datum, ellipsoid, and zone junctions are indicated by accentuated lines printed in blue. Labels may appear on each side of the junction line. The labels may be shown more than once to facilitate identification. Each label is printed in the color designated for the particular grid system. Where a grid, datum, ellipsoid, or zone junction line is coincident with a neatline, both the junction line and the identifying labels are omitted.

7-3.2.1 For nonstandard grids, the label is modeled after the following:

BRITISH NATIONAL GRID
NORD ALGERIE GRID
MADAGASCAR GRID

7-3.2.2 The label for a UTM grid junction, or a UPS grid junction, includes the identification of the Grid Zone Designation and is written in MGRS terms as:

UTM GRID ZONE DESIGNATION: 47T
 UPS GRID ZONE DESIGNATION: 8

7-3.3 Each grid is shown by full lines within its own area only, being represented in the normal manner at 10,000-unit intervals with every 100,000-unit line accentuated in weight. All grid lines are printed in blue.

7-3.4 Grid values appear on all four sides of the sheet (outside the neatline) labeling each grid line. The composition of the number is similar to that described in paragraph 7-2.3, except that full grid values label the first grid line in each direction from each corner of the sheet.

7-3.5 On maps at 1:250,000 scale, the grid ladder values are shown as described in paragraph 7-2.4. Departures in labeling are often necessary when two or more major grids are shown. At least one row and one column of identifications are shown within the areal extent of each grid; the normal labeling plan is followed when practical.

7-3.6 Where appropriate for the grid, at 1:250,000 scale, identification of 100,000-unit squares and larger unit squares appear on the face of the map at all 100,000-unit grid line intersections as described in paragraph 7-2.4. The unit-square identifications appear in the same color as the grid values.

7-3.7 The colors of the grid values vary with different grids.

7-3.7.1 The UTM and UPS grid values are shown in blue when either grid appears alone or with another grid. When both the UTM and UPS grids appear on the same sheet, the grid values are shown in blue for whichever of the two grids occurs most frequently on the sheets in the general area. The values for the other grid are shown in red-brown.

7-3.7.2 For nonstandard grids, the values appear in the colors specified for the grid system as described in paragraph 7-2.6.2. Where the designated colors are the same, one or more substitutions are made to emphasize distinction. Usually, the conventional color is retained for the grid which occurs most frequently on the sheets in the general area. In general, the order of preference is black, blue, red-brown. (For a JOG, black is substituted for red.)

7-3.7.3 Blue usually is used for the UTM or UPS grids when either appears in combination with nonstandard grids. In such cases, if the conventional color for a nonstandard grid is blue, a substitution is made for the nonstandard grid with black or red-brown being used.

7-3.8 Notes identifying each grid appear in the lower margin of the sheet. These are printed in the same color as that used for the values for the grid each identifies.

7-3.8.1 When the grids are different zones of the UTM grid, the note is modeled after the following:

BLUE NUMBERED LINES INDICATE THE 10,000 METER
 UNIVERSAL TRANSVERSE MERCATOR GRID, ZONES 50
 AND 51, CLARKE 1866 ELLIPSOID

7-3.8.2 When more than one grid is involved, the notes are modeled after the following:

BLUE NUMBERED LINES INDICATE THE 10,000 METER
 UNIVERSAL TRANSVERSE MERCATOR GRID, ZONE 37,
 INTERNATIONAL ELLIPSOID

RED-BROWN NUMBERED LINES INDICATE THE 10,000 METER
UNIVERSAL POLAR STEREOGRAPHIC GRID, NORTH,
ZONE Z, INTERNATIONAL ELLIPSOID

BLUE NUMBERED LINES INDICATE THE 10,000 METER
UNIVERSAL TRANSVERSE MERCATOR GRID, ZONE 37,
CLARKE 1880 ELLIPSOID

RED-BROWN NUMBERED LINES INDICATE THE 10,000 METER
MADAGASCAR GRID, INTERNATIONAL ELLIPSOID

7-3.8.3 A separate marginal note is not shown for the grid in the north or east overlap of a JOG. Such a grid is identified on the face of the map only.

7-3.9 Figures 28 and 29 illustrate these principles.

7-3.10 When an ellipsoid junction occurs on a map sheet, the UTM grid treatment is the same as that followed when a sheet straddles a grid junction. The ellipsoids are identified on each side of the junction line. See figure 30. A note, printed in the same color as the grid values, appears in the lower margin of the sheet identifying the grids, zone(s), and ellipsoids.

BLUE NUMBERED LINES INDICATE THE 10,000 METER
UNIVERSAL TRANSVERSE MERCATOR GRID, ZONE 52,
WGS ELLIPSOID, AND ZONE 52, BESSEL ELLIPSOID

7-3.11 In certain cases, a sheet bearing the UTM grid may straddle a parallel which marks the division between different grid zone designations. The grid and corresponding labeling appear as previously described. A continuous line in black indicates the dividing parallel. The proper grid zone designations, printed in the same color as the grid values, appear on each side of the line. The dividing parallel is omitted when it falls within 2.5 mm (0.10 inch) of the north or south neatlines. Figure 31 illustrates these principles.

7-4 OVERLAPPING AND EXTENDED GRIDS.

Overlapping and extended grids are not shown on maps at these scales.

7-5 SECONDARY GRIDS.

7-5.1 Secondary grids are seldom shown on JOGs. As a general rule, secondary grids are no longer required on military topographic maps. Excepted are those instances where mapping arrangements with cooperating foreign agencies specify the showing of a secondary grid. No more than one secondary grid is shown.

7-5.2 When required, the secondary grid is shown by inside ticks, printed in blue, emanating from the neatline in their correct alignment and spaced at 10,000-unit intervals. The even 100,000-unit ticks are accentuated in weight.

7-5.3 Values, similar in composition to those labeling the major grid lines, appear on all four sides of the sheet. The first grid tick in each direction from the southwest corner of the sheet is labeled with full values. Thereafter, only those grid ticks whose values are multiples of 50,000 are labeled. If the secondary grid is a nonstandard grid, prescribed colors are used (para. 7-2.6.2), unless there is conflict with another grid shown on the map. In that event, substitutions are made in the established order of preference.

7-5.4 A grid note, identifying the secondary grid, appears in the lower margin of the

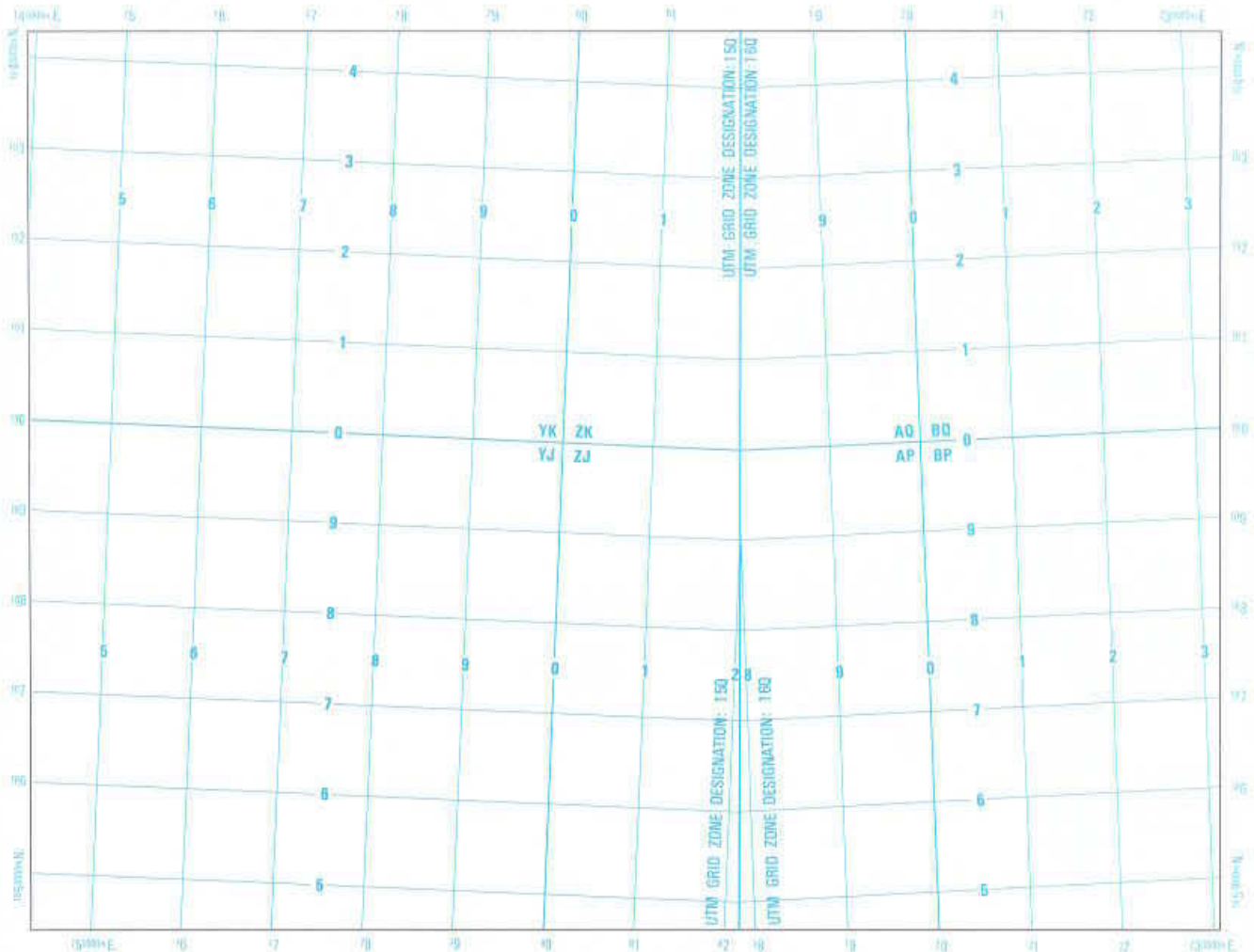

BLUE NUMBERED LINES INDICATE THE 10,000 METER UNIVERSAL TRANSVERSE
 MERCATOR GRIDS, ZONES 15 AND 16, CLARKE 1886 ELLIPSOID
 Scale 1:250,000 (in miniature)

Figure 28. Two Major UTM Grid Zones Separated by a Grid Junction as Shown on a 1:250,000 Scale Map.

sheet. It is printed in the same color as that used for the values of the grid it identifies and is modeled after the following:

BLACK NUMBERED TICKS INSIDE THE NEATLINE
 INDICATE THE 10,000 METER LEVANT ZONE
 GRID, CLARKE 1880 ELLIPSOID

7-5.5 The principles outlined above are illustrated in figure 32.

7-5.6 If a sheet includes areas of more than one secondary grid, only one secondary grid is shown. This is extended over the entire sheet. Usually, the secondary grid shown is that which covers the major portion of the sheet. If the sheet is divided equally by more

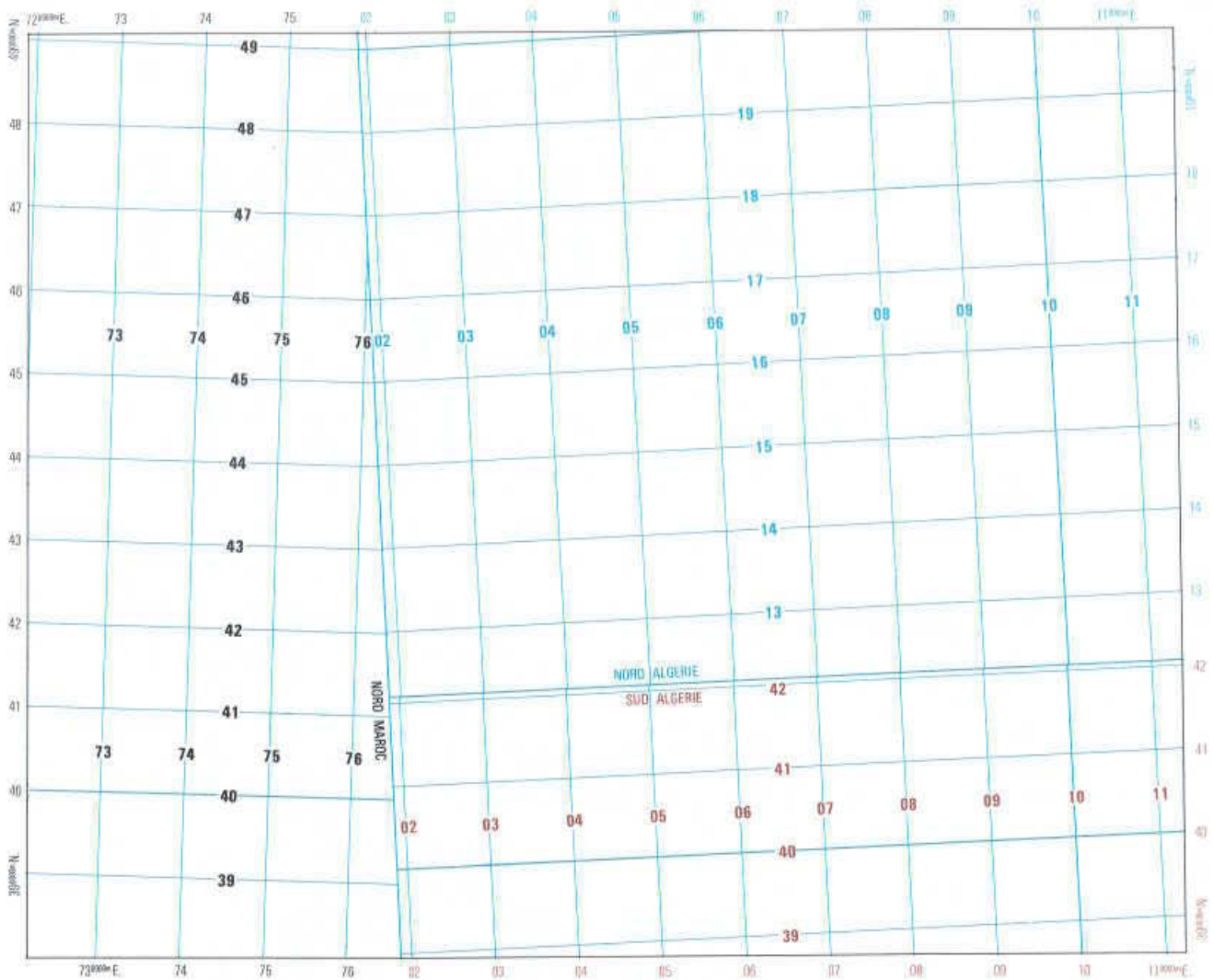

BLUE NUMBERED LINES INDICATE THE 10,000 METER NORD ALGERIE GRID, CLARKE 1880 ELLIPSOID.
 BLACK NUMBERED LINES INDICATE THE 10,000 METER NORD MAROC GRID, CLARKE 1880 ELLIPSOID.
 RED/BROWN NUMBERED LINES INDICATE THE 10,000 METER SUD ALGERIE GRID, CLARKE 1880 ELLIPSOID.

Scale 1:250,000 (in miniature)

Figure 29. Three Major Nonstandard Grids Separated by Grid Junctions as Shown on a 1:250,000 Scale Map.

than one secondary grid, the one shown is that which occurs on most of the sheets in the area.

7-6 GRID DECLINATION.

Grid declinations from true north are not shown on maps at these scales.

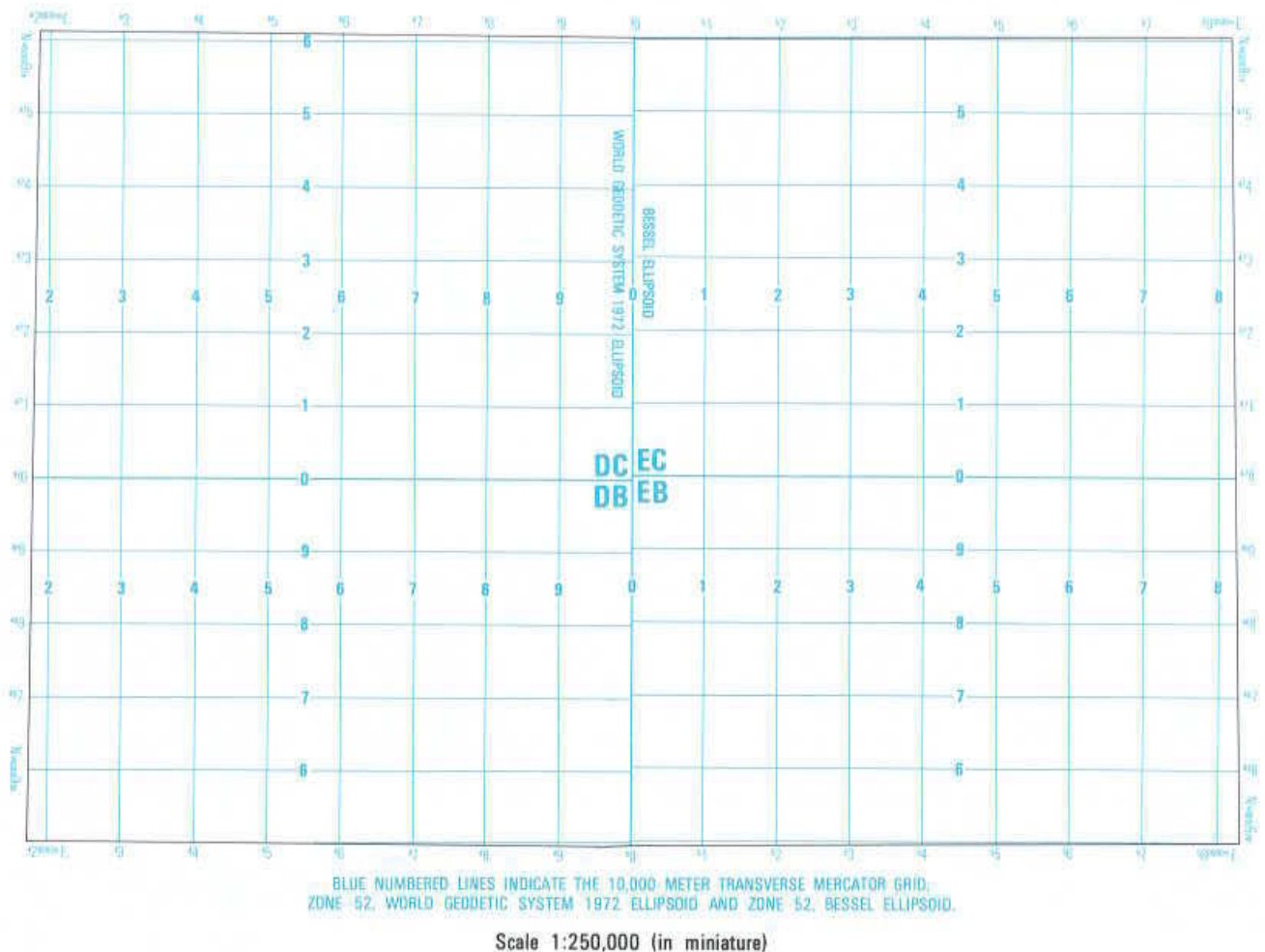

Figure 30. Two Major Grids (UTM) Separated by an Ellipsoid Junction as Shown on a 1:250,000 Scale Map.

7-7 MAGNETIC DECLINATION.

7-7.1 In the margin of each sheet a note is shown to give the magnetic declination, usually for the centers of the west and east edges of the sheet. The declination is expressed to the nearest 1/2 degree, with mil equivalents to the nearest 10 mils.

7-7.1.1 The declination is obtained from the latest isogonic data for a standard epoch (i.e., a year that is divisible by five, such as 1990, 1995).

7-7.1.2 No reference is made to the annual magnetic change.

7-7.2 The note is usually printed in purple and is modeled after the following:

DMA TM 8358.1

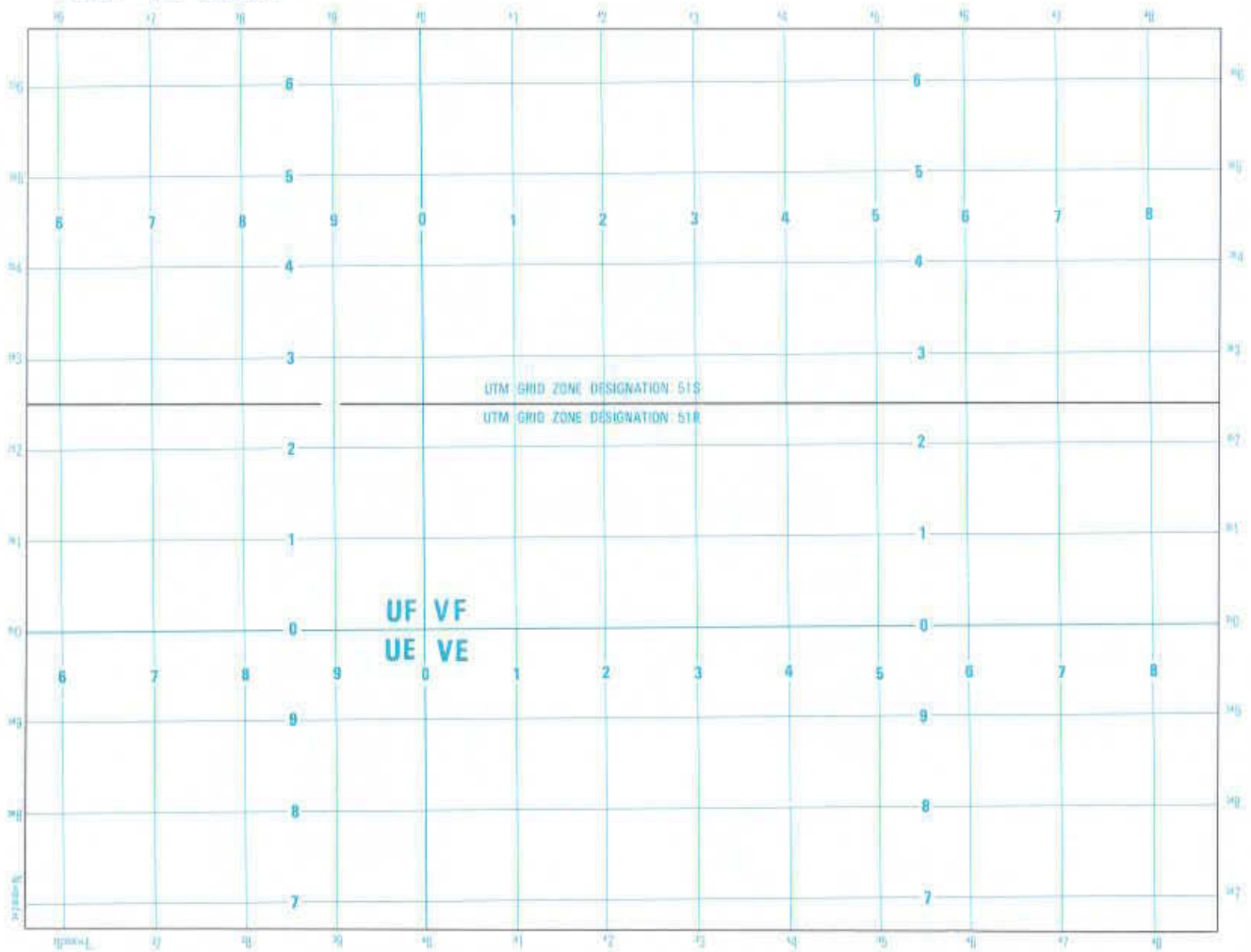

BLUE NUMBERED LINES INDICATE THE 10,000 METER UNIVERSAL TRANSVERSE MERCATOR GRID, ZONE 51, WORLD GEODETIC SYSTEM 1972 ELLIPSOID

Scale 1:250,000 (in miniature)

Figure 31. Treatment when Grid Falls within More than One UTM Grid Zone Designation Area as Shown on a 1:250,000 Scale Map.

1990 MAGNETIC DECLINATION FROM TRUE NORTH VARIES FROM 1 1/2° (30 MILS) WESTERLY FOR THE CENTER OF THE WEST EDGE TO 2° (40 MILS) WESTERLY FOR THE CENTER OF THE EAST EDGE

7-7.3 On sheets where the declination is the same over the entire sheet, the note is modeled after the following:

MAGNETIC DECLINATION FOR 1990 IS 1 1/2° (30 MILS) WESTERLY OVER THE ENTIRE AREA

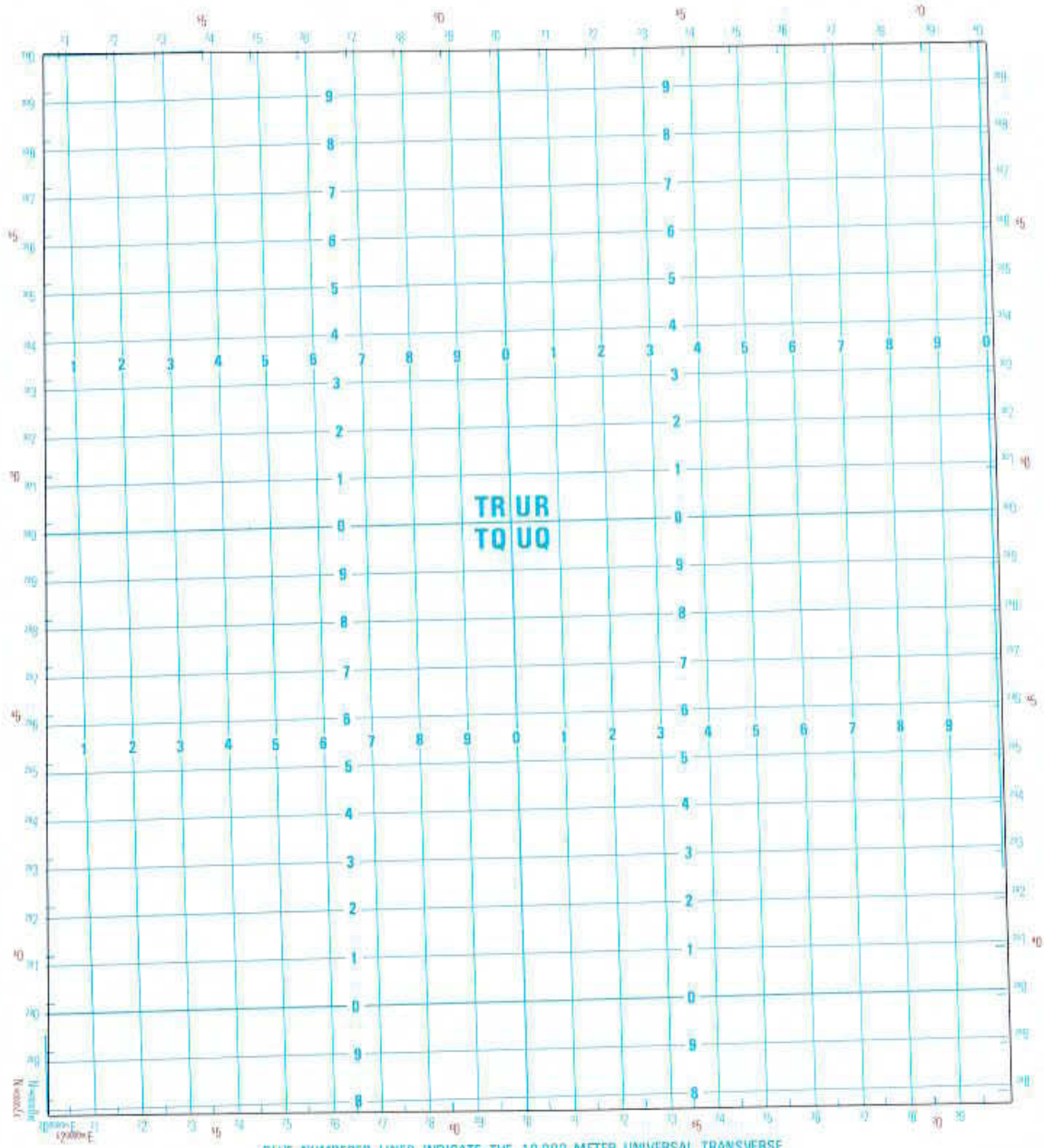

BLUE NUMBERED LINES INDICATE THE 10,000 METER UNIVERSAL TRANSVERSE MERCATOR GRID, ZONE 36, INTERNATIONAL ELLIPSOID

RED/BROWN NUMBERED TICKS INSIDE THE NEATLINE INDICATE THE 10,000 METER EGYPT RED BELT GRID, HELMERT ELLIPSOID

Scale 1:250,000 (in miniature)

Figure 32. Major and Secondary (Obsolete) Grids as Shown on a 1:250,000 Scale Map.

<p>SAMPLE 10000 METER GRID SQUARE</p> <p>100,000 M. SQUARE IDENTIFICATION</p> <p>See Body of Map</p> <p>GRID ZONE DESIGNATION</p>	<p>SAMPLE 1000 METER REFERENCE</p> <ol style="list-style-type: none"> Read letter identifying the 100,000 meter square in which the point lies. Read four number labeling the VERTICAL grid line left of point. Estimate fourth (1,000 meters) from grid line to point. Read larger number labeling the HORIZONTAL grid line below point. Estimate fourth (1,000 meters) from grid line to point. <p style="text-align: right;">AB 1234</p> <p style="text-align: center;">Example AB1234</p> <p>WHEN REPORTING OUTSIDE THE GRID ZONE DESIGNATION AREA IN WHICH THE POINT LIES, PREFIX THE GRID ZONE DESIGNATION.</p> <p style="text-align: center;">Example</p>
--	--

For use with UTM and UPS Grids.

<p>500,000 YARD (Small Letter) and 100,000 YARD (Large Letter) SQUARE IDENTIFICATIONS</p>	<p>TO GIVE A STANDARD REFERENCE</p> <p>SAMPLE POINT</p> <ol style="list-style-type: none"> Read letter identifying 100,000 yard square in which the point lies. Locate first VERTICAL grid line to LEFT of point and read LARGE figure labeling the line either in the top or bottom margin or on the line itself. Estimate fourth from grid line to point. Locate first HORIZONTAL grid line BELOW point and read LARGE figure labeling the line either in the left or right margin or in the line itself. Estimate fourth from grid line to point. <p>IGNORE the SMALLER figures of any grid system; these are for finding the full coordinates. Use ONLY the LARGER figure of the grid number. Example</p> <p>SAMPLE REFERENCE</p> <p>If reporting beyond 500,000 yards prefix with 500,000 Yard-Square Identification, ex.</p>
--	---

For use with British Grids which identify the 500,000 and 100,000 yard squares.

<p>500,000 YARD (Small Letter) and 100,000 YARD (Large Letter) SQUARE IDENTIFICATIONS</p>	<p>TO GIVE A STANDARD REFERENCE</p> <p>SAMPLE POINT</p> <ol style="list-style-type: none"> Read letter identifying 100,000 meter square in which the point lies. Locate first VERTICAL grid line to LEFT of point and read LARGE figure labeling the line either in the top or bottom margin or on the line itself. Estimate fourth from grid line to point. Locate first HORIZONTAL grid line BELOW point and read LARGE figure labeling the line either in the left or right margin or on the line itself. Estimate fourth from grid line to point. <p>IGNORE the SMALLER figures of any grid system; these are for finding the full coordinates. Use ONLY the LARGER figure of the grid number. Example</p> <p>SAMPLE REFERENCE</p> <p>If reporting beyond 500,000 meters prefix with 500,000 Meter-Square Identification, ex.</p>
--	--

For use with British Grids which identify the 500,000 and 100,000 meter squares.

<p>TO GIVE A STANDARD REFERENCE</p> <p>IGNORE the SMALLER figures of any grid system; these are for finding the full coordinates. Use ONLY the LARGER figure of the grid number. Example</p> <p>SAMPLE POINT</p> <ol style="list-style-type: none"> Read sheet number Locate first VERTICAL grid line to LEFT of point and read LARGE figure labeling the line either in the top or bottom margin or on the line itself. Estimate fourth from grid line to point. Locate first HORIZONTAL grid line BELOW point and read LARGE figure labeling the line either in the left or right margin or on the line itself. Estimate fourth from grid line to point. <p>SAMPLE REFERENCE</p>	<p>TO GIVE A STANDARD REFERENCE</p>
---	--

For use with British Grids which do not identify the 100,000 unit squares.

Figure 33. Grid Reference Boxes Most Commonly Used on Maps at 1:250,000 and 1:500,000 Scale.

7-7.4 On the Air version of the JOG, isogonic lines (lines of equal magnetic variation) are shown on the face of the sheet in place of the magnetic declination note in the margin. In addition to the isogonic lines, a note modeled after the following is shown in the margin:

LINES OF EQUAL MAGNETIC VARIATION FOR 1990
(Annual rate of change, no change)

7-7.5 If there are less than two 15 minute isogonic lines, the magnetic variation is shown by a note modeled after the following:

MAGNETIC VARIATION FOR 1990 IS APPROXIMATELY
1°W OVER THE ENTIRE AREA
(Annual rate of change 7' decrease)

7-8 THE GRID REFERENCE BOX.

7-8.1 A grid reference box appears in the margin of each sheet. The box contains step-by-step instructions for composing a grid reference. For examples, see figure 33. The applicable grid zone designation is also identified in the box.

7-8.2 The grid system(s) in use on the map dictates the referencing instructions contained in the grid reference box.

7-8.3 When more than one major grid appears on a sheet and the method for giving a reference is the same for all the grids, a common reference box is used.

7-8.4 When more than one major grid appears on a sheet and the method for giving a reference varies with the grids, circumstances control the treatment of the grid reference boxes.

7-8.4.1 A grid reference box is shown in the margin for each grid, except those falling completely in open water area. Over each box appears a note limiting the use of the box to the grid or grids concerned.

7-8.4.1.1 When each box describes the method of referencing for one grid only, the note is printed in the same color as the values for its respective grid and is modeled after the following:

USE THIS BOX FOR GIVING REFERENCES ON THE
UNIVERSAL TRANSVERSE MERCATOR GRID

USE THIS BOX FOR GIVING REFERENCES ON THE
MADAGASCAR GRID

7-8.4.1.2 When the same system of referencing is used for two grids occurring on the same sheet along with a third grid using a different reference system, the note for the common reference box is printed in blue and modeled after the following:

USE THIS BOX FOR GIVING REFERENCES ON THE SUD
ALGERIE AND SUD TUNISIE GRIDS

7-8.4.2 When all reference boxes cannot be accommodated in the margin, the excess is shown in expanses of open water on the face of the map. When this is not practicable, a note which refers the user to an adjacent sheet is added to a reference box in the margin. This note is positioned below the note described in paragraph 7-8.4.1.2, above. If only one grid is involved, the note is printed in the same color as the values for that grid. If more than one grid is involved, the note is printed in blue. The notes are modeled after the following:

USE THIS BOX FOR GIVING REFERENCES ON THE
UNIVERSAL TRANSVERSE MERCATOR GRID

SEE SHEET NI 30-06 FOR GIVING REFERENCES ON
THE NORD MAROC GRID

USE THIS BOX FOR GIVING REFERENCES ON THE
UNIVERSAL TRANSVERSE MERCATOR GRID

SEE SHEET NI 32-10 FOR GIVING REFERENCES ON
THE SUD ALGERIE AND SUD TUNISIE GRIDS

CHAPTER 8

PORTRAYAL OF GRIDS ON MAPS AT 1:1,000,000 SCALE

8-1 GENERAL.

Grid data and grid format for maps at 1:1,000,000 scale generally appear as described in this section. Except for minor differences, the design is essentially the same for Universal Transverse Mercator grids, Universal Polar Stereographic grids, and nonstandard grids. The maps usually show grid lines and ticks, their values, grid letters, and notes in the margin identifying the grid and the grid zone designation. Variations in the specifications for particular types of products at 1:1,000,000 scale exist. The individual product specifications must be followed. A typical treatment is shown in figure 34.

8-2 THE MAJOR GRID.

8-2.1 The major grid is shown by full lines at 100,000-unit intervals, intersected by ticks at 10,000-unit intervals. Where a grid line coincides with a neatline of the map, the grid line and its intersecting ticks are omitted. However, the neatline is labeled in the margin with the values for the grid line.

8-2.2 Grid values appear outside the neatline on all four sides of the sheet, labeling each grid line. They may also label only the first grid line in each direction from the southwest corner. Except for the values labeling the first grid line in each direction from the southwest corner of the sheet, the last four digits (0000) of the values are omitted. The values are shown in two sizes of type, with the larger size being used for the principal digits.

8-2.2.1 With most grids, one principal digit is used. This represents the 10,000 digit of the grid values.

8-2.2.2 Two principal digits are used with the Madagascar grid and the Lambert grids of northwest Africa, and the Ceylon Belt. These digits represent the 100,000 and 10,000 digits of the grid values.

8-2.3 When the grid system is one which identifies its 100,000-unit squares, the identifications appear on the face of the map, centered within the appropriate squares. For nonstandard grid systems which also identify larger grid squares - such as the 500,000-unit squares - the additional identifications appear in smaller type immediately before each 100,000-unit square identification.

8-2.4 Blue is used for all grid information, including grid lines, grid ticks, 100,000-unit square identifications, grid values, and all margin grid information.

8-2.5 A note printed in blue appears in the lower margin or in the legend of each sheet to identify the grid and the full grid zone designation. The note is modeled after the following:

BLUE LINES AT 100,000 METER INTERVALS AND BLUE
TICKS AT 10,000 METER INTERVALS INDICATE THE
UNIVERSAL TRANSVERSE MERCATOR GRID, ZONE
DESIGNATION 37T, INTERNATIONAL ELLIPSOID

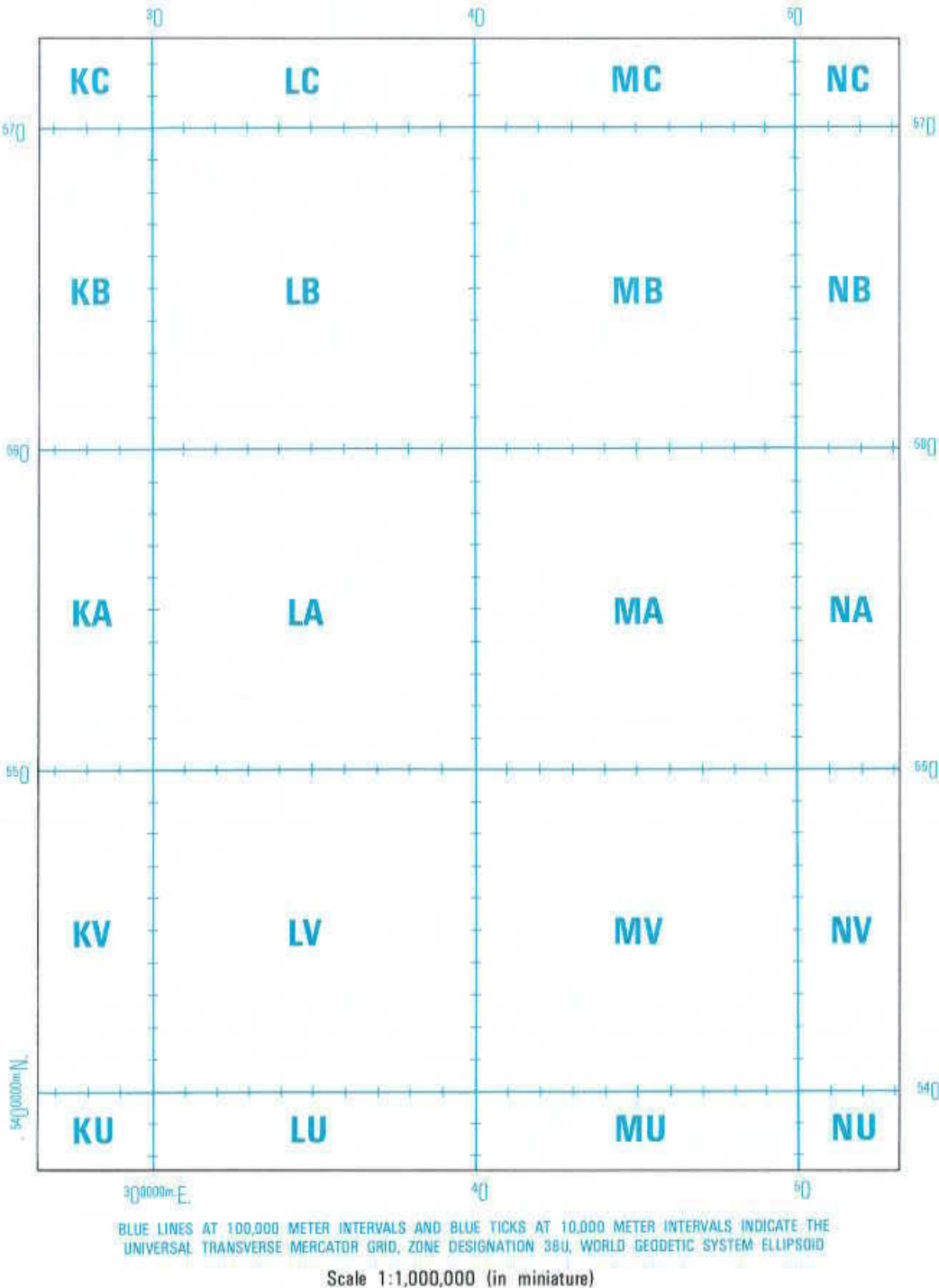

Figure 34. Treatment for the Major Grid in UTM Areas as Shown on Maps at 1:1,000,000 Scale.

BLUE LINES AT 100,000 METER INTERVALS AND BLUE TICKS AT 10,000 METER INTERVALS INDICATE THE MADAGASCAR GRID, INTERNATIONAL ELLIPSOID

8-2.6 On maps having land insets for which the grid or grid zone differs from that of the map proper, the appropriate grid note is shown within the inset.

8-3 MULTIPLE MAJOR GRIDS.

8-3.1 In many instances a sheet contains more than one major grid. This occurs especially in higher latitudes, where sheets may be wide in longitudinal extent, and in areas covered by nonstandard grids, where grid junctions are not necessarily coincident with parallels or meridians.

8-3.2 Grid, datum, ellipsoid, and zone junctions are indicated by accentuated lines, printed in blue. Labels appear on each side of the junction line. The labels may be shown more than once to facilitate identification. Where a grid, datum, ellipsoid, or zone junction line is coincident with a neatline, both the junction line and the identifying labels are omitted.

8-3.2.1 For nonstandard grids, the label is modeled after the following:

BRITISH NATIONAL GRID

MADAGASCAR GRID

8-3.2.2 The label for a UTM grid junction, or a UPS grid junction, includes the identification of the Grid Zone Designation and is written in MGRS terms as:

UTM GRID ZONE DESIGNATION: 22W

UPS GRID ZONE DESIGNATION: A

8-3.3 Each grid is shown by full lines within its own area only, being represented in the normal manner at 100,000-unit intervals, intersected by ticks at 10,000-unit intervals. All grid lines are printed in blue.

8-3.4 Grid values appear on all four sides of the sheet (outside the neatline) labeling each grid line. They may also label only the first grid line in each direction from each corner of the sheet. The composition of the number is similar to that described in paragraph 8-2.2, except that full grid values label the first grid line in each direction from each corner of the sheet.

8-3.5 Where appropriate for the grid, identification of 100,000-unit squares and larger unit squares appear on the face of the map, centered within the appropriate squares, as described in paragraph 8-2.3.

8-3.6 Notes identifying each grid appear in the lower margin of the sheet. The note is modeled after the following:

BLUE LINES AT 100,000 METER INTERVALS AND BLUE TICKS AT 10,000 METER INTERVALS INDICATE THE UNIVERSAL TRANSVERSE MERCATOR GRID, ZONE DESIGNATIONS 22K AND 23K, INTERNATIONAL ELLIPSOID

BLUE LINES AT 100,000 METER INTERVALS AND BLUE TICKS AT 10,000 METER INTERVALS INDICATE THE NORD MAROC GRID, CLARKE 1880 ELLIPSOID

8-3.7 In those cases where a sheet includes an ellipsoid junction, the grids for the two ellipsoids are treated in the same manner as that specified in paragraph 8-3.2. The ellipsoids are identified on each side of the junction line. Where an ellipsoid junction line is coincident with a neatline, both the junction line and the identifying labels are omitted. The grid note in the lower margin of the sheet identifies each ellipsoid which appears on that sheet. It is modeled after the following:

BLUE LINES AT 100,000 METER INTERVALS AND BLUE TICKS AT 10,000 METER INTERVALS INDICATE THE UNIVERSAL TRANSVERSE MERCATOR GRID, ZONE DESIGNATION 33T, INTERNATIONAL ELLIPSOID, AND ZONE DESIGNATION 33T, WGS ELLIPSOID

8-3.8 In certain cases, a sheet bearing the UTM grid may straddle a parallel which marks the division between different grid zone designations. A continuous line in black or blue indicates the dividing parallel. The proper grid zone designations, printed in blue appear on each side of the line.

8-3.9 Figures 35 and 36 illustrate principles described for sheets with more than one major grid.

8-4 OVERLAPPING, EXTENDED, AND SECONDARY GRIDS.

Overlapping, extended, or secondary (obsolete) grids are not shown on the 1:1,000,000 scale map.

8-5 GRID AND MAGNETIC DECLINATIONS.

Grid and magnetic declination data are not shown on 1:1,000,000 scale maps.

8-6 THE GRID REFERENCE BOX.

8-6.1 A grid reference box may be shown in the margin of the sheet. The box contains explicit step-by-step instructions for composing a grid reference. See figure 37 for a typical grid reference box.

8-6.2 The grid system(s) in use on the map dictates the referencing instructions contained in the grid reference box.

8-6.3 When more than one major grid appears on a sheet and the method for giving a reference is the same for all the grids, a common reference box is used.

8-6.4 When more than one major grid appears on a sheet and the method for giving a reference varies with the grids, the treatment of the grid reference boxes is as follows:

8-6.4.1 A grid reference box is shown in the margin for each grid, except those falling completely in open water area. Over each box appears a note limiting the use of the box to the grid or grids concerned.

8-6.4.1.1 When each box describes the method of referencing for one grid only, the note is modeled after the following:

USE THIS BOX FOR GIVING REFERENCES ON THE UNIVERSAL TRANSVERSE MERCATOR GRID

USE THIS BOX FOR GIVING REFERENCES ON THE MADAGASCAR GRID

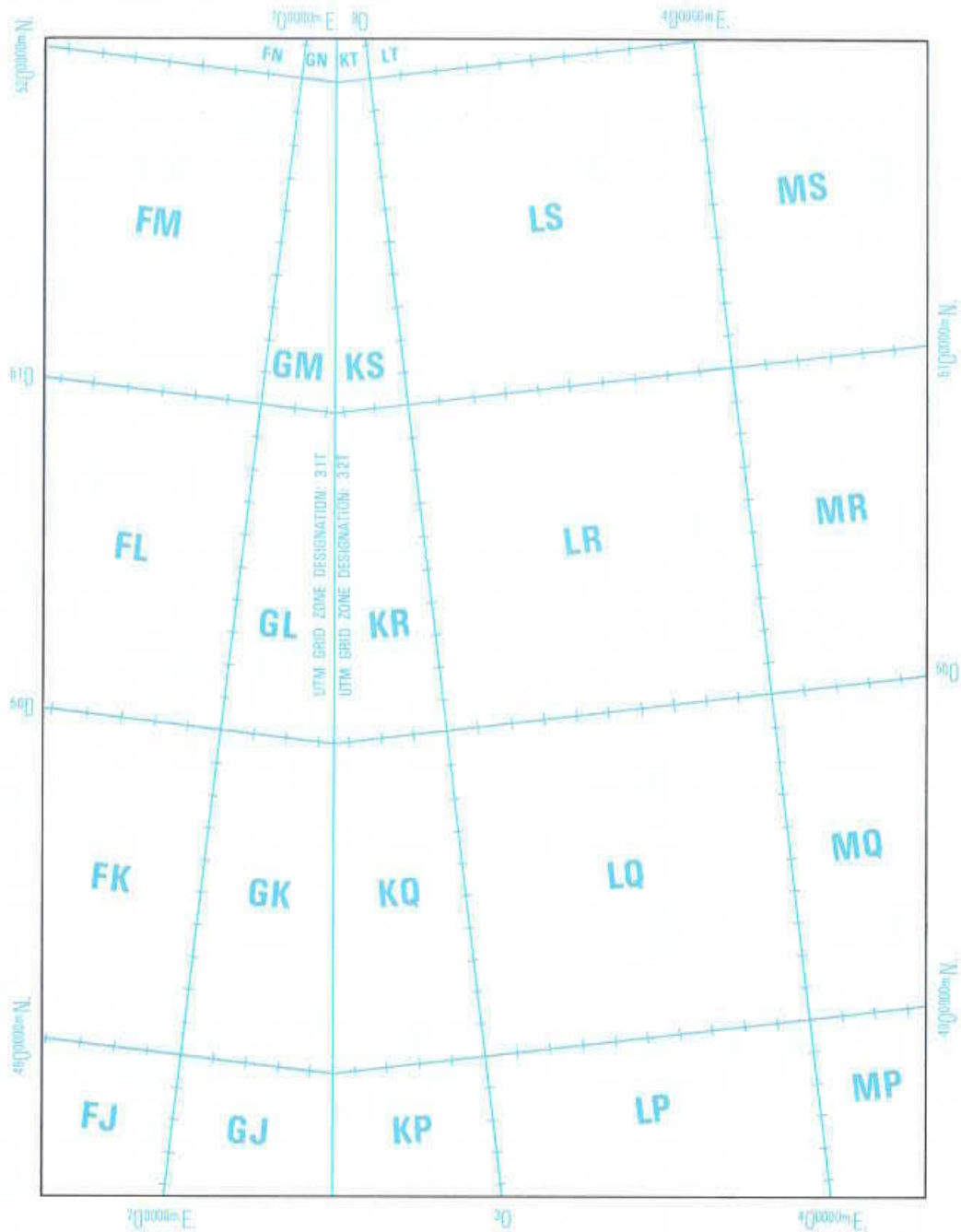

BLUE LINES AT 100,000 METER INTERVALS AND BLUE TICKS AT 10,000 METER INTERVALS INDICATE THE UNIVERSAL TRANSVERSE MERCATOR GRID. ZONE DESIGNATIONS 31T AND 32T INTERNATIONAL ELLIPSOID.
 Scale 1:1,000,000 (in miniature)

Figure 35. Two Major Grids (in this case, Zones of the UTM) Separated by a Grid Junction, as Shown on a Map at 1:1,000,000 Scale.

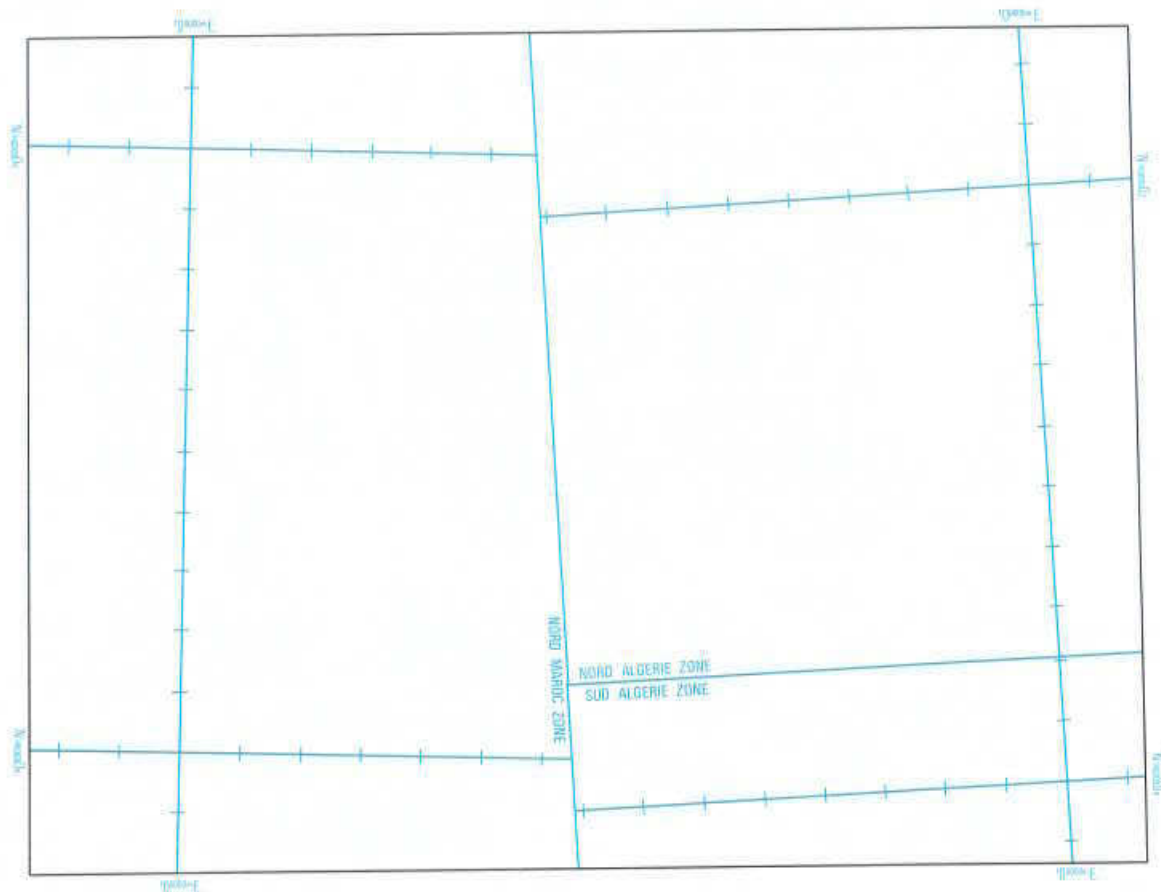

BLUE LINES AT 100,000 METER INTERVALS AND BLUE TICKS AT 10,000 METER INTERVALS INDICATE THE NORD MAROC ZONE GRID, NORD ALGERIE ZONE GRID, AND SUD ALGERIE ZONE GRID, CLARKE 1880 ELLIPSOID

Scale 1:1,000,000 (in miniature)

Figure 36. Three Major Nonstandard Grids as Shown on a Map at 1:1,000,000 Scale.

8-6.4.1.2 When the same system of referencing is used for two grids occurring on the same sheet with a third grid using a different reference system, the note for the common reference box is modeled after the following:

USE THIS BOX FOR GIVING REFERENCES ON THE SUD ALGERIE AND SUD TUNISIE GRIDS

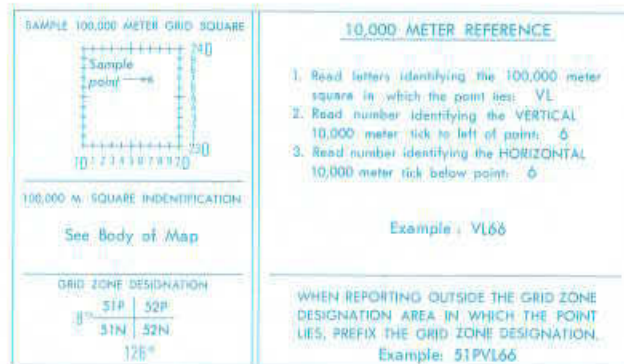

Figure 37. Grid Reference Box for 1:1,000,000 Scale Map.

8-6.4.2 When all reference boxes cannot be accommodated in the margin, the excess is shown in expanses of open water on the face of the map. When this is not practicable, a note which refers the user to an adjacent sheet is added to a reference box in the margin. This note is positioned below the note described in paragraph 8-6.4.1.2 above. The notes are modeled after the following:

USE THIS BOX FOR GIVING REFERENCES ON THE
UNIVERSAL TRANSVERSE MERCATOR GRID

SEE SHEET 1 FOR GIVING REFERENCES ON
THE NORD MAROC GRID

USE THIS BOX FOR GIVING REFERENCES ON THE
UNIVERSAL TRANSVERSE MERCATOR GRID

SEE SHEET 2 FOR GIVING REFERENCES ON
THE SUD ALGERIE AND SUD TUNISIE GRIDS

CHAPTER 9

GRIDS ON NAUTICAL CHARTS AT 1:75,000 SCALE AND LARGER

9-1 GENERAL.

9-1.1 Requirements for grid data and grid formats on nautical charts prepared for the DoD at 1:75,000 scale and larger are essentially the same for Universal Transverse Mercator grids, Universal Polar Stereographic grids and nonstandard grids.

9-1.2 The grid data for DoD charts usually include the major grid, a grid reference box, and notes identifying the grid. Combat Charts and Amphibious Assault Charts also include a declination note.

9-1.3 The adjacent grid is provided as an overlapping grid when a chart lies within approximately 40 kilometers of a grid junction line or a datum junction boundary. A separate declination note, and notes identifying the overlapping grid, appear in the margin for grid junctions, and may or may not appear for datum junctions, depending on grid alignments.

9-1.4 A chart may show a secondary grid which occurs in the area. The secondary grid is identified by margin notes.

9-1.5 No single chart in this scale category ever shows more than three grids. When a chart covers an area which includes more than three (either major, overlapping, or secondary), those omitted are the ones which are considered of least military importance. Major grids are never omitted. When choice lies between two overlapping grids, the one retained usually is the one which best covers the land area of interest.

9-1.6 Specific dimensions, size and style of type, and placement of margin data relating to grids and grid formats at 1:75,000 scale and larger are contained in Defense Mapping Agency (DMA) product specifications.

9-2 THE MAJOR GRID ON COMBAT CHARTS AND AMPHIBIOUS ASSAULT CHARTS.

9-2.1 The major grid on Combat Charts and Amphibious Assault Charts is indicated by full lines at 1,000-unit intervals. The unit is meters. Every 10,000-unit grid line at scales of 1:45,001 and smaller, or 5,000-unit grid line at scales of 1:45,000 and larger, is accentuated in weight (index line).

9-2.2 Grid numbers appear outside the neatline on all four sides of the chart. Each 1,000-unit line is labeled with the principal digits and the higher order digits, i.e. 781 or 6745. Each 10,000-unit line has a full numerical label, i.e. 690000 or 4750000.

9-2.3 Full grid labels, including unit and direction, will be shown on the first full grid line in each direction from each corner, i.e. 392000mE or 2311000mN.

9-2.3.1 Where a grid line coincides with a neatline, the grid line is overprinted and labeled in the margin with its value.

9-2.3.2 On charts showing the major and overlapping grids, the first grid line and grid tick in each direction from each corner are given the full coordinate values for both grids.

9-2.3.3 On the Madagascar grid and the Lambert grids of northwest Africa, use three principal digits to represent the 100,000-, 10,000-, and 1,000-meter values of the grid lines.

9-2.3.4 Only the index grid lines are labeled in the margin of skewed charts. These labels include the appropriate Northing or Easting abbreviation and the unit of measurement.

9-2.4 The grid lines in the chart interior contain a pattern of grid value labels (principal digits) designed to assist in position referencing on a folded chart. The 1,000 meter northing grid lines are labeled to the right of each 10,000 meter easting grid line and the 1,000 meter easting grid lines are labeled above each 10,000 meter northing grid line.

9-2.5 The color of the grid lines and values is purple for the primary major grid, blue for the second major or overlapping grid, and red-brown for the secondary grid.

9-2.6 A note identifying the grid and ellipsoid appears in the margin of a chart. The note is modeled after the following:

PURPLE LINES INDICATE THE 1,000 METER UNIVERSAL TRANSVERSE MERCATOR GRID,
ZONE 59N, INTERNATIONAL ELLIPSOID

9-2.7 Figures 38 and 39 illustrate the treatment for the major grid on Combat Charts and Amphibious Assault Charts.

9-3 THE MAJOR GRID ON MINE WARFARE CHARTS.

9-3.1 The major grid is indicated by interior ticks at 10,000-unit intersections and by ticks along the neatlines at 1,000-unit intervals. The 10,000-unit ticks along the border are accentuated in weight. The major grid ticks are printed in purple.

9-3.2 Grid numbers appear outside the neatlines on all four sides of the chart, labeling every 5,000-unit grid tick. Every 10,000-unit grid tick is labeled with the full coordinate value. The intermediate 5,000-unit grid tick is labeled by the principle digits preceded by the 100,000-unit and 1,000,000-unit digits. The first 10,000-unit tick from each corner includes the E for Easting and the N for Northing. All grids values are printed in the same color as the ticks. See figure 40.

9-3.3 A note identifying the grid and ellipsoid appears in the margin of a chart. The note is modeled after the following:

UNIVERSAL TRANSVERSE MERCATOR (UTM) GRID, ZONE 10T,
NORTH AMERICAN 1927 DATUM, CLARKE 1866 ELLIPSOID
FOR MILITARY GRID REFERENCE

9-4 THE MAJOR GRID ON HARBOR, APPROACH, AND COASTAL CHARTS.

9-4.1 The major grid is indicated by interior and neatline ticks at 10,000-unit intervals for scales of 1:45,001 to 1:75,000. For charts at scales of 1:45,000 and larger, a 5,000-unit interval is used. The grid ticks are printed in purple. Sometimes the size and scale of charts may require the interval to be modified to show at least two ticks in each direction.

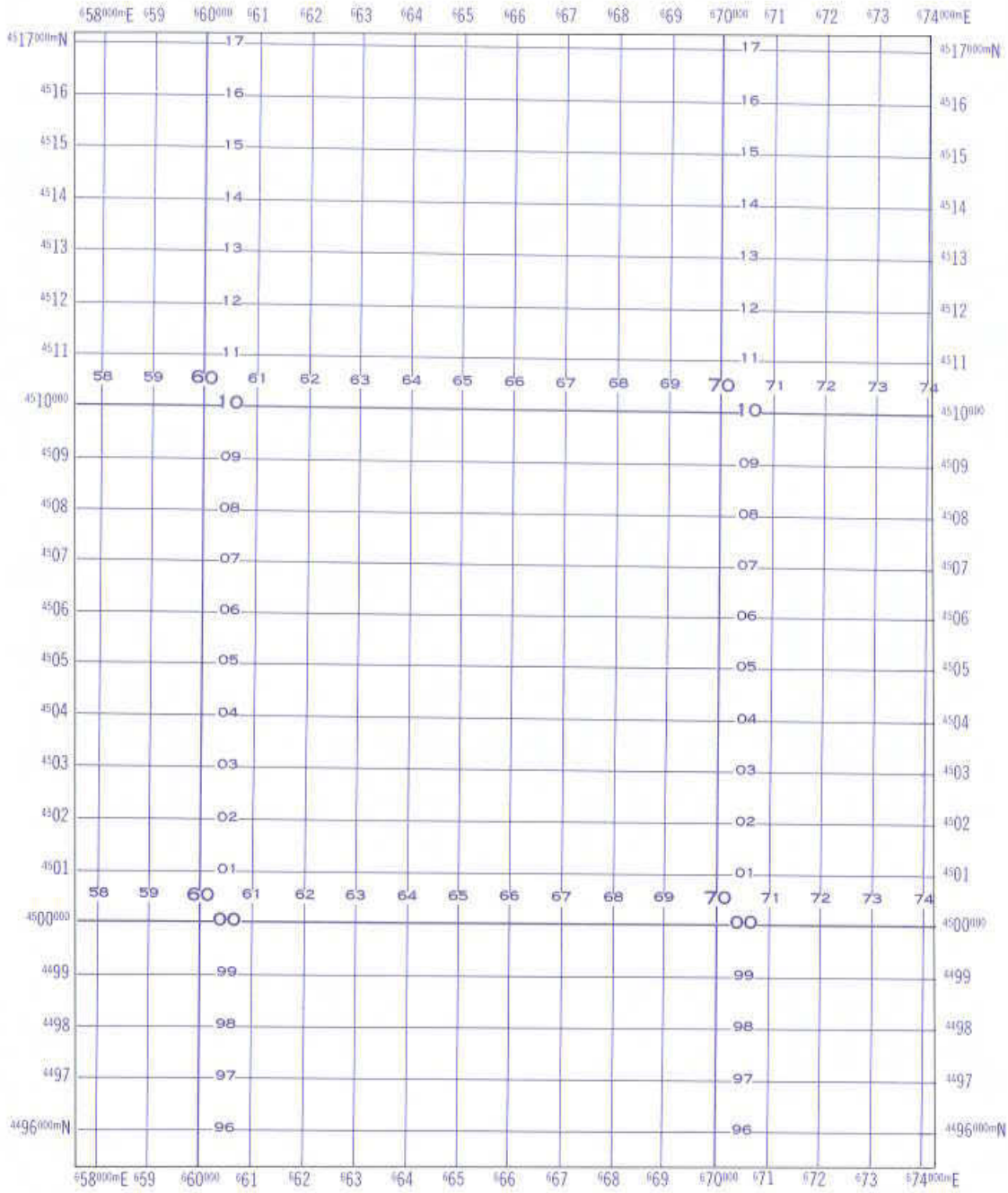

PURPLE LINES INDICATE THE 1,000 METER UNIVERSAL TRANSVERSE MERCATOR GRID, ZONE 49T, WORLD GEODETTIC SYSTEM 1984 ELLIPSOID

Figure 38. The Major Grid as Shown on Combat, Amphibious Assault Charts.

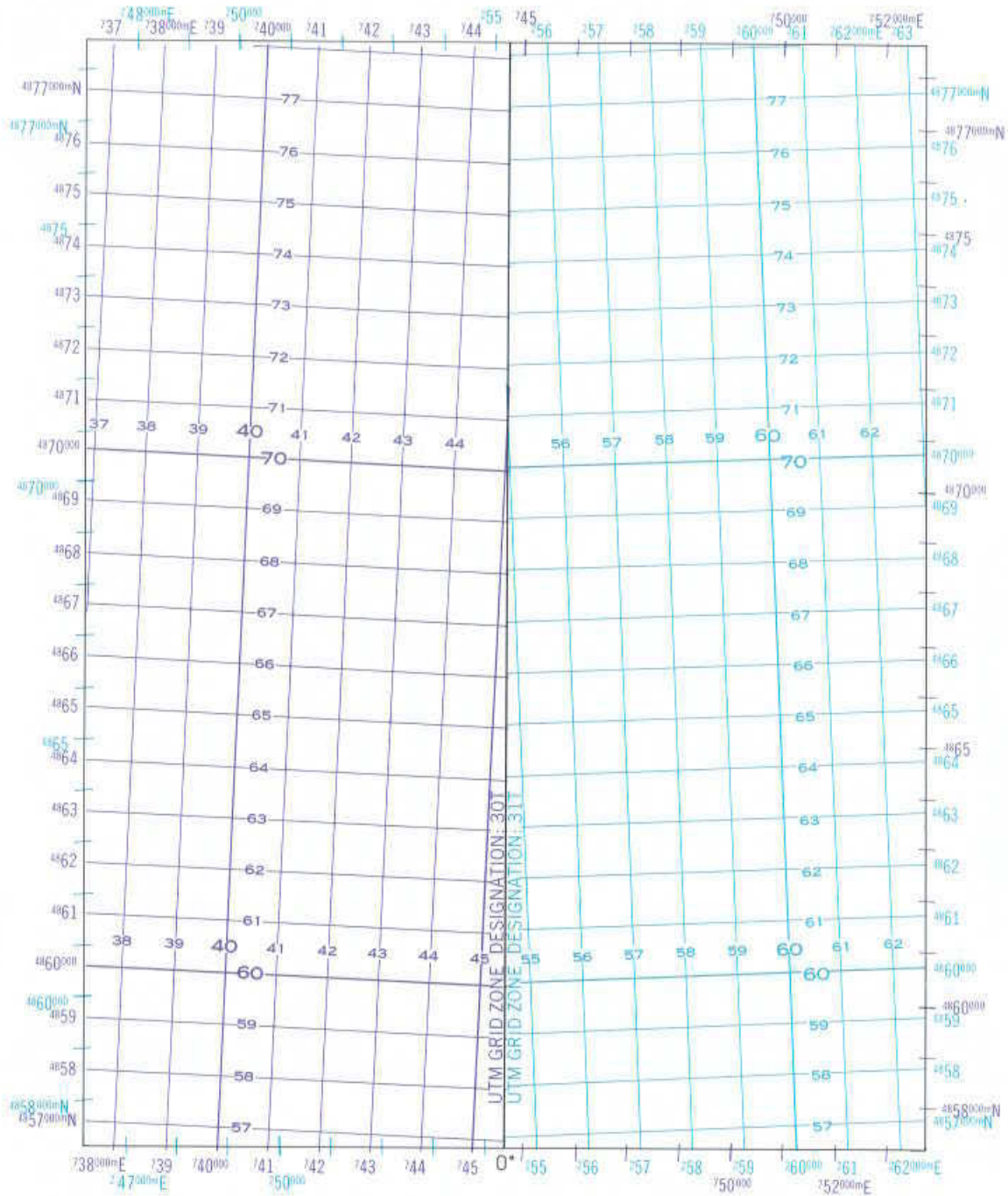

PURPLE LINES AND TICKS INDICATE THE 1,000 METER UNIVERSAL TRANSVERSE MERCATOR GRID, ZONE 30T, INTERNATIONAL ELLIPSOID

BLUE LINES AND TICKS INDICATE THE 1,000 METER UNIVERSAL TRANSVERSE MERCATOR GRID, ZONE 31T, INTERNATIONAL ELLIPSOID

Figure 39. Two Major Grids (in this case, Zones of the UTM) Separated by a Grid Junction as Shown on Combat, Amphibious Assault Charts.

9-4.2 Grid numbers appear outside the neatline on all four sides of the chart, labeling every grid tick. The first tick from each corner includes the E for Easting and the N for Northing, m for meters or yds for yards. All grid values are printed in the same color as the ticks. See figure 41.

9-4.3 A note identifying the grid and ellipsoid appears in the margin of a chart. The note is modeled after the following:

UNIVERSAL TRANSVERSE MERCATOR (UTM) GRID, ZONE 10T,
NORTH AMERICAN 1927 DATUM, CLARKE 1866 ELLIPSOID
FOR MILITARY GRID REFERENCE

9-5 MULTIPLE MAJOR GRIDS ON COMBAT CHARTS AND AMPHIBIOUS ASSAULT CHARTS.

9-5.1 In certain instances a chart contains more than one major grid.

9-5.1.1 With the UTM and UPS grids this may occur:

9-5.1.1.1 Where original chart limits are retained as established by a mapping agency of a foreign country.

9-5.1.1.2 Where a chart is shifted from the normal position to avoid making additional charts.

9-5.1.2 With nonstandard grids, this condition occurs more frequently since, in addition to the above cases, grid junctions are sometimes loxodromes or are grid lines.

9-5.2 Grid, datum, ellipsoid, and zone junctions are indicated by accentuated lines, rited in black. Labels identifying the junction appear parallel to and on each side of the junction line. The labels may be shown more than once to facilitate identification. Each label is printed in the color designated for the particular grid system. When a grid, datum, ellipsoid, or zone junction line is coincident with a neatline, both the junction line and the identifying labels are omitted. If the junction line falls within 2.5 mm (0.10 inch) of the neatline, the junction line is not shown; it is considered as being coincident with the neatline.

9-5.2.1 For nonstandard grids, the label is modeled after the following:

SUD MAROC GRID
NORD TUNISIE GRID
MADAGASCAR GRID

9-5.2.2 The label for a UTM grid junction, or a UPS grid junction, includes the identification of the Grid Zone Designation and is written in MGRS terms as:

UTM GRID ZONE DESIGNATION: 54T
UPS GRID ZONE DESIGNATION: B

9-5.3 Each grid is shown by full lines within its own area only, being represented at 1,000-unit intervals with every 10,000-unit line accentuated in weight. The first major grid is printed in purple, the second major grid in blue, and the third major grid in red-brown.

9-5.3.1 On charts bearing two major grids, the extension of either grid into the area of the other (overlapping grid) is shown by ticks crossing the neatline correctly aligned with its respective major grid. The even 10,000-unit ticks are accentuated in weight.

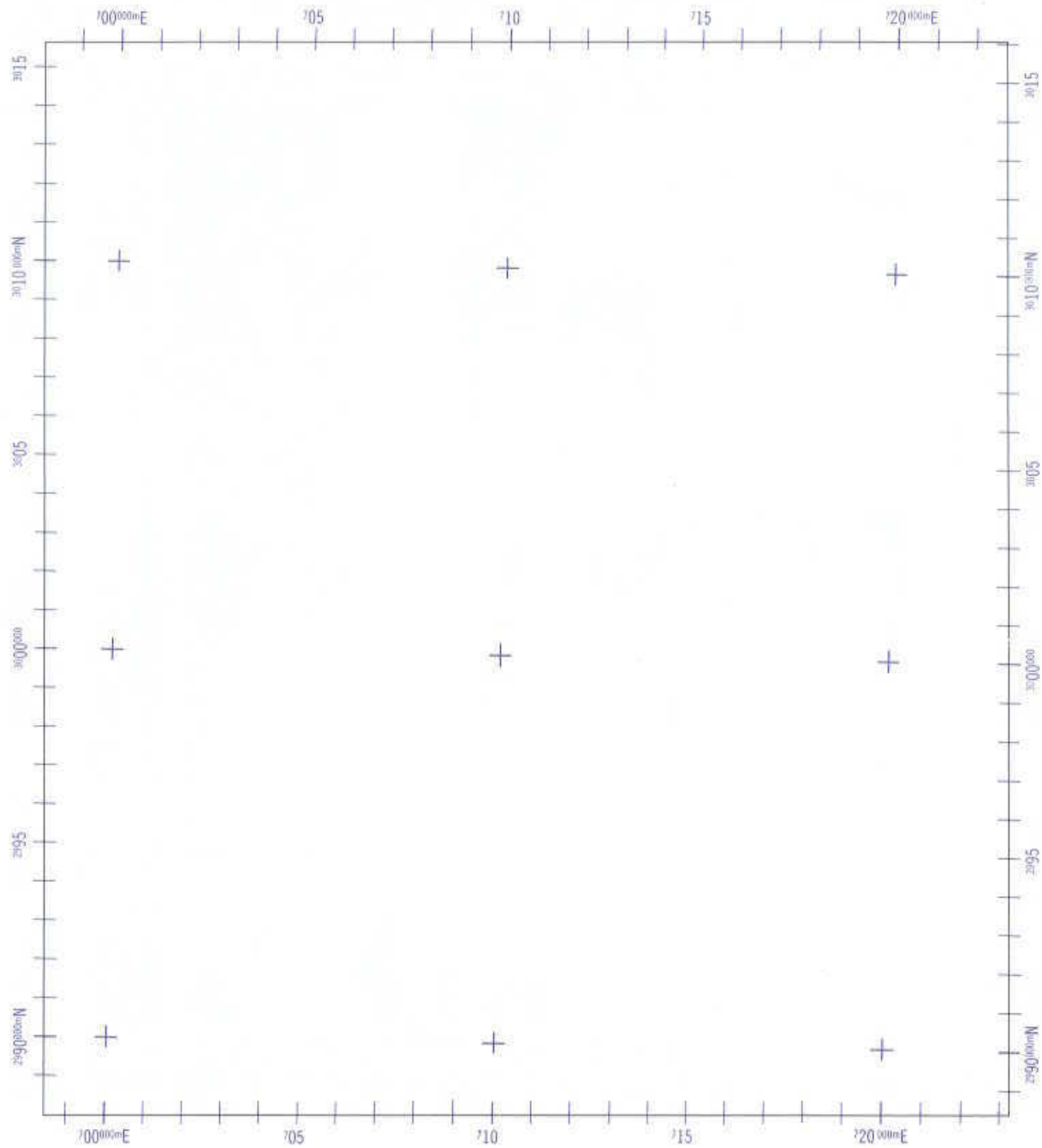

UNIVERSAL TRANSVERSE MERCATOR (UTM) GRID
ZONE 39R, WGS-84 DATUM, WGS-84 ELLIPSOID
FOR MILITARY GRID REFERENCE

Figure 40. Treatment for the Major Grid on Mine Warfare Charts at 1:75,000 Scale and Larger.

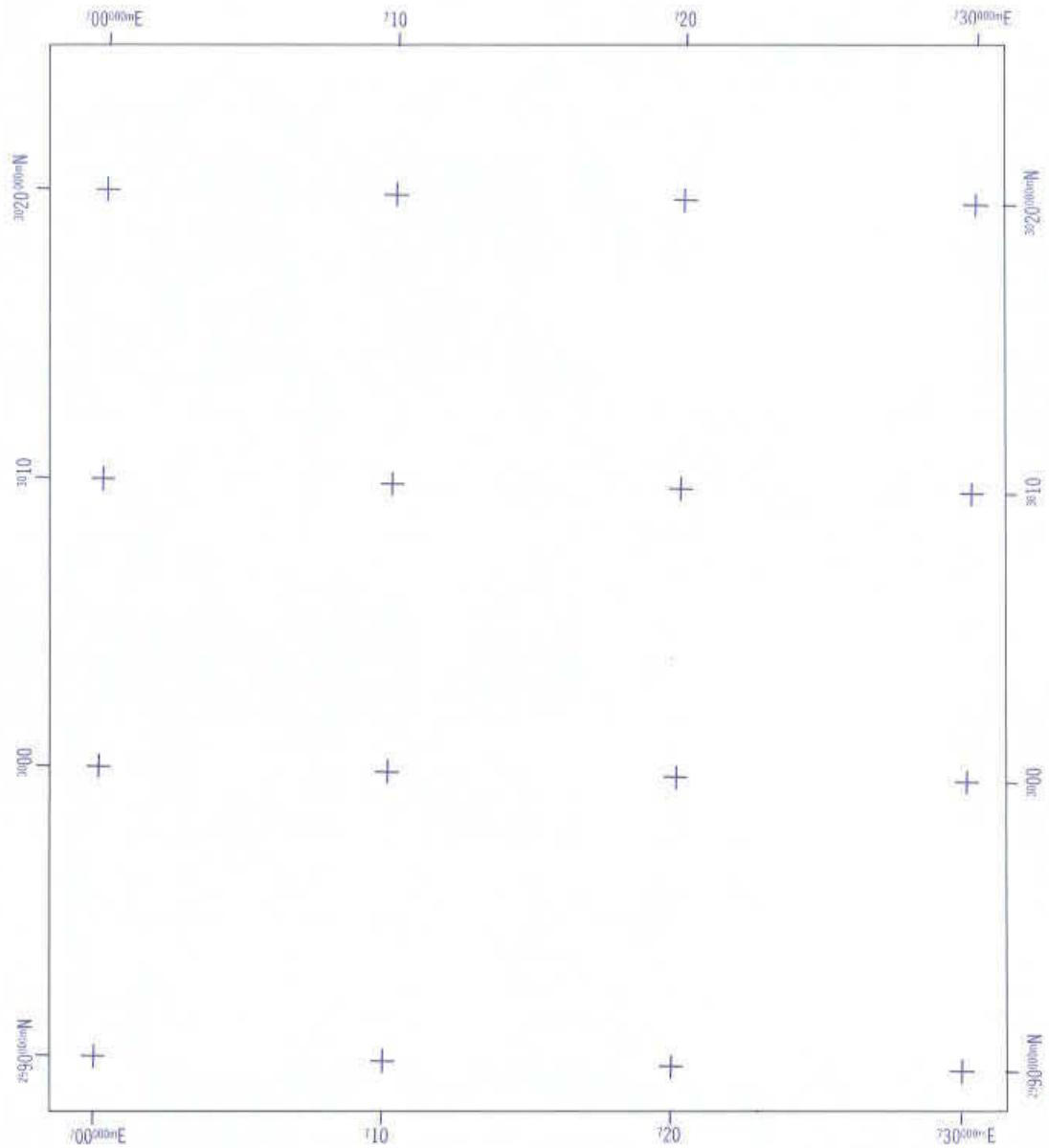

UNIVERSAL TRANSVERSE MERCATOR (UTM) GRID
ZONE 39R, WGS-84 DATUM, WGS-84 ELLIPSOID
FOR MILITARY GRID REFERENCE

Figure 41. Treatment for the Major Grid on Harbor and Approach Charts at T:75,000 Scale and Larger.

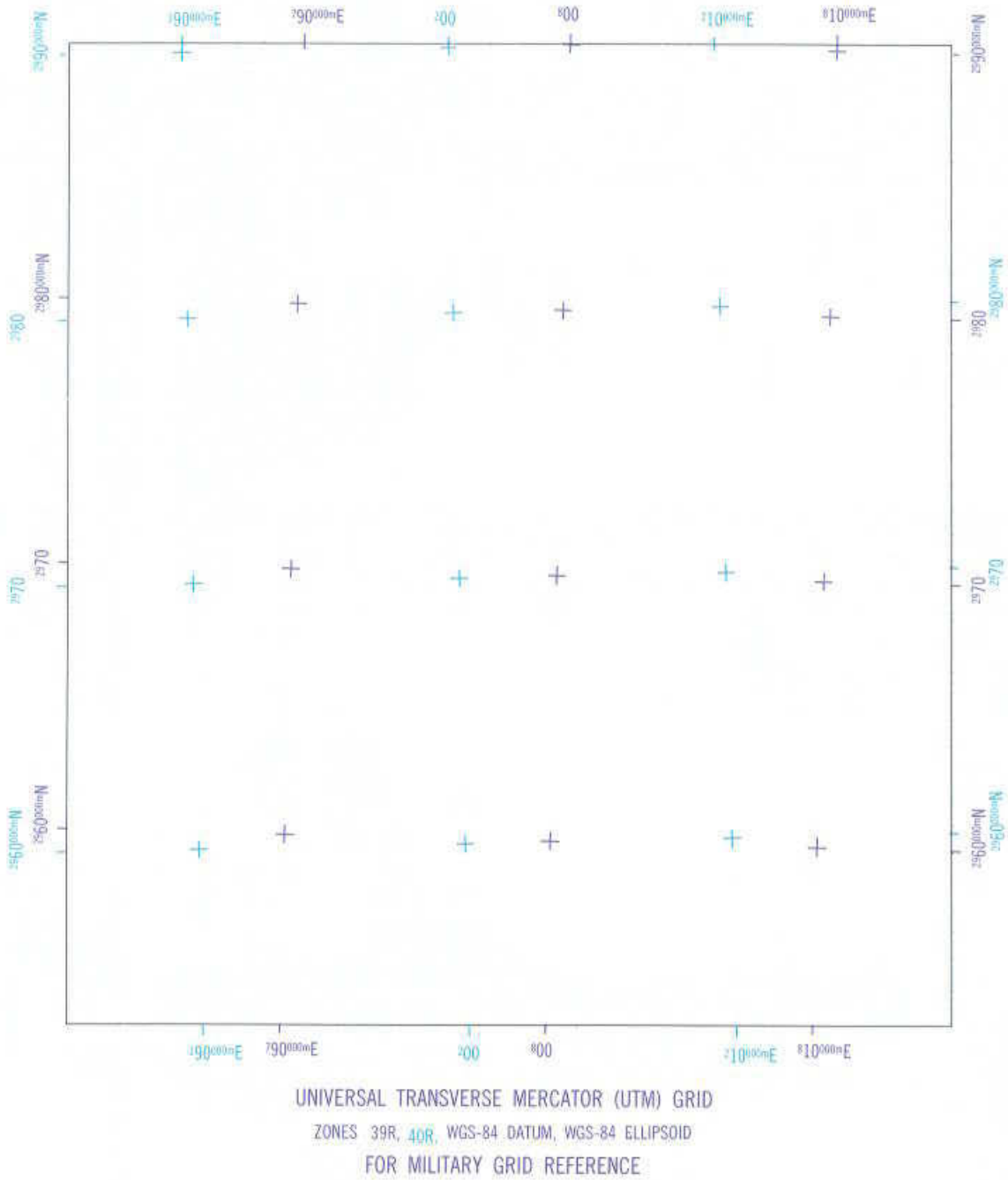

Figure 42. Treatment for the Multiple Major Grids on Harbor and Approach Charts at 1:75,000 Scale and Larger.

9-5.3.2 On charts bearing three major grids, a similar practice is followed.

9-5.4 Grid values appear on all four sides of the chart labeling each grid line and those grid ticks whose values are multiples of 5,000. Full values appear at each corner, labeling the first grid line in each direction from the corner.

9-5.5 Grid values, expressed in principal digits only, appear on the face of the chart labeling each grid line.

9-5.6 Notes identifying each grid appear in the margin of the chart. The notes are modeled after the following:

PURPLE LINES AND TICKS INDICATE THE 1,000 METER UNIVERSAL TRANSVERSE MERCATOR GRID, ZONE 59N, INTERNATIONAL ELLIPSOID

BLUE LINES AND TICKS INDICATE THE 1,000 METER UNIVERSAL TRANSVERSE MERCATOR GRID, ZONE 60N, INTERNATIONAL ELLIPSOID

9-6 MULTIPLE MAJOR GRIDS ON HARBOR, APPROACH, AND COASTAL CHARTS.

9-6.1 In certain instances a chart contains more than one major grid. See paragraph 9-5.1.

9-6.2 Grid, datum, ellipsoid, and zone junctions are not indicated in the interior of the chart. They are marked only in the grid reference box.

9-6.3 Each grid is depicted across the full area of the chart. The first major grid is represented in purple. The second major grid is represented in blue, and a third major grid is shown in red-brown. Figure 42 illustrates the treatment of multiple major grids.

9-6.4 Examples of notes identifying each grid appear in figure 43. These notes may be placed within the chart neatlines or outside the border as space permits.

9-7 OVERLAPPING GRIDS ON COMBAT CHARTS, AMPHIBIOUS ASSAULT CHARTS, AND MINE WARFARE CHARTS.

9-7.1 An overlapping grid is generally required within approximately 40 kilometers of a grid, zone, or ellipsoid junction. The overlapping grid may be omitted if there are no land bodies within the 40 kilometer overlap area.

9-7.2 The overlapping grid is shown by ticks, printed in blue if there is one major grid and red-brown if there are two major grids, crossing the neatline correctly aligned with its respective grid and spaced at 1,000-unit intervals. The even 10,000-unit ticks are accentuated in weight.

9-7.3 Values, similar in composition to those labeling the major grid lines or ticks, appear on all four sides of the chart. The first grid tick in each direction from each corner of the chart whose values are multiples of 5,000 are labeled. These values are printed in the same color as that of the grid.

9-7.4 Notes identifying overlapping grids appear in the margin of each chart. The notes are patterned after those used to identify multiple major grids. Figures 38 and 39 illustrate the treatments described for charts containing major and overlapping grids.

9-8 OVERLAPPING GRIDS ON HARBOR, APPROACH, AND COASTAL CHARTS.

9-8.1 An overlapping grid may be required within approximately 40 kilometers of a grid, zone, or ellipsoid junction. The overlapping grid may be omitted if there are no land bodies within the 40 kilometer overlap area.

9-8.2 The overlapping grid is shown in the same manner as a major grid with interior and neatline ticks at 10,000 meter intervals, printed in blue if there is one major grid and red-brown if there are two major grids.

9-8.3 Values, similar in composition to those labeling the major grid ticks, appear on all four sides of the chart. The first grid tick in each direction from each corner of the chart are labeled with the full grid value. These values are printed in the same color as that of the grid.

9-8.4 Notes identifying overlapping grids appear within the chart or outside the heavy border of each chart. The notes are patterned after those used to identify multiple major grids. Figure 43 illustrates the treatments described for charts containing major and overlapping grids.

9-9 SECONDARY GRIDS.

9-9.1 As a general rule, secondary grids are not required on nautical charts.

9-9.2 When required, the secondary grid is shown in the same manner as overlapping grids except that they are printed in the next color of the hierarchy, blue then red-brown. They are labeled in the same manner as overlapping grids.

9-9.3 A grid note, identifying the secondary grid, appears in the margin or on the face of the chart depending on available space.

9-9.4 When a secondary grid differs uniformly from the major grid, a datum shift note may be used in lieu of showing the secondary grid. The note should be printed in the next color of the hierarchy: blue, then red-brown, and patterned after the following:

TO REFER THIS CHART TO EUROPEAN DATUM:
SUBTRACT 0.1 SECONDS FROM THE LATITUDE VALUE AND
ADD 1.1 SECONDS TO THE LONGITUDE VALUE;
SUBTRACT 9 METERS FROM THE UTM GRID NORTHING VALUE AND
ADD 30 METERS TO THE UTM GRID EASTING VALUE.

9-10 THE DECLINATION NOTE.

9-10.1 A grid declination note appears in the margin of each Combat Chart or Amphibious Assault Chart. The note identifies the grid declination from true north for the approximate mid-latitude of the east and west chart edges.

9-10.2 The note for the first major grid is shown in purple. The note for the second major or overlapping grid is shown in blue. If an overlapping grid occurs in combination with two major grids, the grid declination note for the overlapping grid is shown in red-brown.

The grid declination note for a secondary grid is shown in red-brown.

9-10.3 The grid declination note is modeled after the following:

CAUTION

GRID LINES ARE NOT TRUE NORTH AND SOUTH
 At West edge of chart Grid N. is 0°40'E. of True N.
 At East edge of chart Grid N. is 1°15'E. of True N.

9-10.4 Magnetic information will be derived from the magnetic compass rose.

9-11 THE GRID REFERENCE BOX.

9-11.1 A grid reference box on a Combat or Amphibious Assault Chart is printed in purple and appears in the margin of each chart. The box contains instructions and attendant data to enable the user to compose standard grid references.

9-11.1.1 The grid system(s) in use on the chart dictates the referencing instructions contained in the grid reference box. The grid reference boxes most commonly used on charts, 1:175,000 scale and larger, are illustrated in figure 43. The boxes are subject to modifications.

9-11.1.2 The grid reference box also contains diagrams identifying applicable grid zone designations and grid square identifications.

9-11.1.3 For the UTM and UPS grids, the diagrams show the grid zone designation in black, the 100,000-meter grid lines and their values (in abbreviated form) in the appropriate grid color, and the 100,000-meter square identification(s) in the appropriate grid color. Figure 43 illustrates the composition of the diagrams under various conditions.

9-11.1.4 For nonstandard grids, the diagram shows the 100,000-unit square identifications and the values of the 100,000-unit grid lines in abbreviated form. These data are printed in the same color as the grid values to which they pertain. If the grid system identifies larger squares, their identifications are shown in smaller type just preceding the 100,000-unit identifications. The 100,000-unit grid lines are printed in purple. Grid junction lines are printed in black. If a junction is a grid line, its value is shown in abbreviated form and printed in the same color as the grid values to which it pertains. Loxodromes are not labeled.

9-11.1.5 For charts that have an inset whose 100,000-unit square identification letters differ from those of the chart proper, the identification letters are shown in the interior of the inset, rather than in the grid reference box.

9-11.2 A grid reference diagram for a Mine Warfare, Harbor or Approach Chart is printed in purple and may be located within the chart or in the margin (where space permits).

9-11.2.1 The grid reference diagram identifies the applicable grid zone designation(s) and grid square identification(s).

9-11.2.2 For the UTM and UPS grids, the diagrams show the grid zone designation(s) in the same color to which they apply.

9-11.2.3 The 100,000-unit line(s), square identification(s) and value(s) in abbreviated form are always printed in the same color as the grid values to which they pertain.

9-11.2.4 Grid junction lines are printed in black. Charts that consist of panels, the line depicting the panel limits is printed in black.

9-11.3 For charts that have an inset/plan whose 100,000-unit square identification letters differ from those of the main chart, the identification letters are shown below the inset/plan title rather than the grid reference diagram.

9-11.4 When more than one major grid appears on a chart and the method for giving a reference is the same for all the grids, a common reference box is used.

9-11.5 When more than one major grid appears on a chart and the method for giving a reference varies with the grids, circumstances control the treatment of the grid reference boxes.

9-11.6 Standard nautical charts do NOT show full grid lines and therefore will carry a note below the grid reference diagram for constructing a full line grid, for example:

TO FORM 10,000 METER SQUARES, JOIN THE TICKS ON
NEATLINES WITH STRAIGHT LINE SEGMENTS THROUGH THE
INTERIOR TICKS.

9-12 WORLD GEODETIC SYSTEM (WGS) DATUM NOTE.

9-12.1 All nautical charts, other than Combat Charts, Amphibious Assault Charts, and certain modified facsimiles, are constructed on WGS wherever possible. When the chart is not on the latest World Geodetic System datum, a note is shown in black indicating the correction needed to convert a coordinate to that datum.

Example for Combat Chart:

COORDINATE CONVERSIONS
EUROPEAN DATUM TO WORLD GEODETIC SYSTEM
Grid: Subtract 65m E; Subtract 296m N
Geographic: Subtract 3.5" Long; Subtract 3.0" Lat

9-12.2 When there is insufficient data available or inconsistent deviations result from the available geodetic control, one of the following notes, as appropriate, is shown in place of the WGS correction note:

WORLD GEODETIC SYSTEM DATA ADJUSTMENT
Due to unavailability of geodetic data, this chart
cannot be placed on the World Geodetic System (WGS)
Datum.

The available geodetic control does not indicate a uniform deviation; therefore, this chart cannot be placed on the World Geodetic System (WGS) Datum.

9-12.3 When a Mine Warfare or Harbor, Approach, and Coastal Chart is on WGS, a datum note is shown as follows:

DATUM NOTE

Positions obtained from satellite navigation systems referred to the World Geodetic System (WGS) can be plotted directly on this chart.

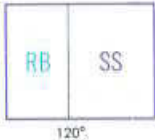
GRID ZONE DESIGNATION: 50P 51P	TO GIVE A STANDARD REFERENCE ON THIS CHART TO NEAREST 100 METERS	
100,000 M. SQUARE IDENTIFICATION	SAMPLE POINT: X 534	
	1. Read letter identifying 100,000 meter square in which the point lies: 2. Locate first 1,000 meter VERTICAL grid line to LEFT of point and read LARGE figures labeling the line either in the top or bottom margin, or on the line itself. Estimate tenths from 1,000 meter grid line to point: 3. Locate first 1,000 meter HORIZONTAL grid line BELOW point and read LARGE figures labeling the line either in the left or right margin, or on the line itself. Estimate tenths from grid line to point:	SS 87 5 37 4
	IGNORE the SMALLER figures of any grid number; these are for finding the full coordinates. Use ONLY the LARGER figures of the grid number; example 1030000	SAMPLE REFERENCE:
If reporting beyond 9° N-S or 18° E-W, prefix Grid Zone Designation, as:		51PSS875374

← Combat, Amphibious Assault Chart example.

CAUTION

GRID LINES ARE NOT TRUE NORTH AND SOUTH

- At Zone Junction Grid N is 0°46'W of True N;
- At East edge of chart Grid N is 0°44'W of True N;
- At West edge of chart Grid N is 0°45'E of True N;
- At Zone Junction Grid N is 0°46'E of True N.

UNIVERSAL TRANSVERSE MERCATOR (UTM) GRID
 ZONES 35V, 36V WGS-84 DATUM, WGS-84 ELLIPSOID
 FOR MILITARY GRID REFERENCE

100,000 METER SQUARES PG, UM

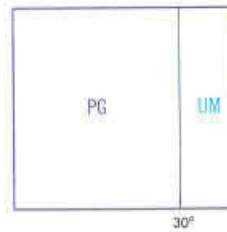

Mine Warfare,
 Harbor, Approach
 & Coastal Chart example. →

TO FORM 10,000 METER SQUARES, JOIN THE TICKS ON NEATLINES WITH STRAIGHT LINE SEGMENTS THROUGH THE INTERIOR TICKS.

THE UTM GRID TICKS, AND THE CHART ARE BASED ON THE WORLD GEODETIC SYSTEM 1984. TO REPORT WORLD GEODETIC DATUM-GRID COORDINATES OF A POINT, GIVE THE LETTERS OF THE 100,000 METER SQUARE DESIGNATION FOLLOWED FIRST BY THE NUMBERS OF THE EAST READING AND THEN BY THE NORTH READING: e.g. TOLBUKHIN LIGHT PG417590.

CAUTION

Grid lines constructed by connecting border ticks are NOT true North and South. The resulting UTM Grid is NOT to be used for navigation. It is designed to facilitate the reporting of positions according to the Military Grid Reference System prescribed for this area.

Figure 43. Grid Reference Boxes commonly used on Nautical Charts at scales of 1:75,000 and Larger.

CHAPTER 10

GRIDS ON NAUTICAL CHARTS
AT SCALES SMALLER THAN 1:75,000

10-1 GENERAL.

10-1.1 Grids are required on nautical charts at scales from 1:75,001 to 1:300,000. For charts at scales smaller than 1:300,000, reference should be made to individual project instructions to determine grid requirements.

10-1.2 Requirements for grid data and grid formats on charts prepared for the DoD at scales smaller than 1:75,000 are essentially the same for Universal Transverse Mercator grids, Universal Polar Stereographic grids and nonstandard grids.

10-1.3 The grid data for DoD charts usually include the major grid, a grid reference box, and notes identifying the grid.

10-1.4 A chart may show a secondary grid which occurs in the area. The secondary grid is identified by margin notes.

10-1.5 No single chart in this scale category ever shows more than three grids. When a chart covers an area which includes more than three (either major or secondary), those omitted are the ones which are considered of least military importance.

10-1.6 Specific dimensions, size and style of type, and placement of margin data relating to grids and grid formats at scales smaller than 1:75,000 are contained in Defense Mapping Agency (DMA) product specifications.

10-2 THE MAJOR GRID.

10-2.1 The grid is indicated by ticks at interior intersections and along the neatline. The spacing of the ticks depends upon the scale and size of the chart and upon the need to keep the grid information within acceptable limits of accuracy. Nautical charts at scales smaller than 1:75,000 are typically constructed on Mercator projections. Grid lines which appear straight on Transverse Mercator projections will therefore appear curved when plotted on a Mercator. Since nautical charts do not normally show full grid lines, ticks are used to represent the grid allowing the user to construct a grid by drawing straight line segments between the ticks. The ticks must be positioned close enough together to allow the chart user to approximate the curve of the true grid line by drawing straight line segments. On charts at scales from 1:75,001 to 1:200,000 the maximum acceptable deviation between the true grid line and the one which the user would construct by joining the ticks is 0.5 mm (0.02in.). As a general rule, charts at this scale should indicate grids by ticks at 20,000-unit intervals. For charts at extreme latitudes, care should be taken to make sure that the maximum acceptable deviation is not exceeded. Similarly, for charts at scales from 1:200,001 to 1:300,000, the maximum acceptable deviation is 1.0 mm (0.04in.) which generally would require ticks at 50,000-unit intervals. Again, care should be taken on charts in the extreme latitudes to see that the maximum acceptable deviation is not exceeded. This paragraph is summarized in table 10.

SCALE	TICK SPACING	MAXIMUM ACCEPTABLE DEVIATION
1:95,001-1:200,000	20,000	0.5mm (0.02in.)
1:200,001-1:300,000	50,000	1.0mm (0.04in.)

Table 10 Maximum acceptable deviation of the constructed grid from the true grid.

10-2.2 Grid numbers appear outside the neatline on all four sides of the chart, labeling every grid tick. Every 100,000-unit grid tick is labeled with the full coordinate value. The intermediate grid tick(s) is (are) labeled by the principal digits preceded by the 100,000-unit digits. The first tick from each corner includes the E for Easting and the N for Northing. All grid values are printed in the same color as the ticks.

10-2.3 A note identifying the grid and ellipsoid appears in the margin or on the face of a chart depending on the available space. The note is modeled after the following:

UNIVERSAL TRANSVERSE MERCATOR (UTM) GRID, ZONE 19,
NORTH AMERICAN 1927 DATUM, CLARKE 1866 ELLIPSOID
FOR MILITARY GRID REFERENCE

10-2.4 Figure 44 illustrates the treatment for the major grid.

10-3 MULTIPLE GRIDS.

10-3.1 In many instances a chart contains more than one major grid. There may be multiple major grids or there may be a special requirement for a secondary grid in addition to the required major grid.

10-3.2 Grid, datum, and zone junctions are indicated in the grid reference box and are not shown on the face of the chart.

10-3.3 Each grid is depicted within its own area by the use of internal and neatline ticks as described in section 10-2. The grid is extended one tick beyond any grid junction line. The first major grid ticks and values are represented in purple. The second major grid ticks and values are represented in blue, and a third major grid is shown in red-brown. Figure 45 illustrates the treatment of multiple major grids.

10-3.4 Notes identifying each grid appear on the chart. The notes are modeled after the following:

UNIVERSAL TRANSVERSE MERCATOR (UTM) GRID, ZONE 19,
NORTH AMERICAN 1927 DATUM, CLARKE 1866 ELLIPSOID,
FOR MILITARY GRID REFERENCE

UNIVERSAL TRANSVERSE MERCATOR (UTM) GRID, ZONE 19,
NORTH AMERICAN 1983 DATUM, GRS 80 ELLIPSOID,
FOR MILITARY GRID REFERENCE

10-4 SECONDARY GRIDS.

10-4.1 As a general rule, secondary grids are not required on nautical charts.

10-4.2 When required, the secondary grid is depicted within its own area by the use of internal and neatline ticks as described in section 10-2. Secondary grid ticks are printed in the next color in the hierarchy, blue then red-brown.

10-4.3 Values, similar in composition to those labeling the major grid lines, appear on all four sides of the chart. The first grid tick in each direction from each corner of the chart is labeled with full values. Secondary grid values are printed in the same color as the grid ticks.

10-4.4 A grid note, identifying the secondary grid, appears in the margin or on the face of the chart depending on the available space.

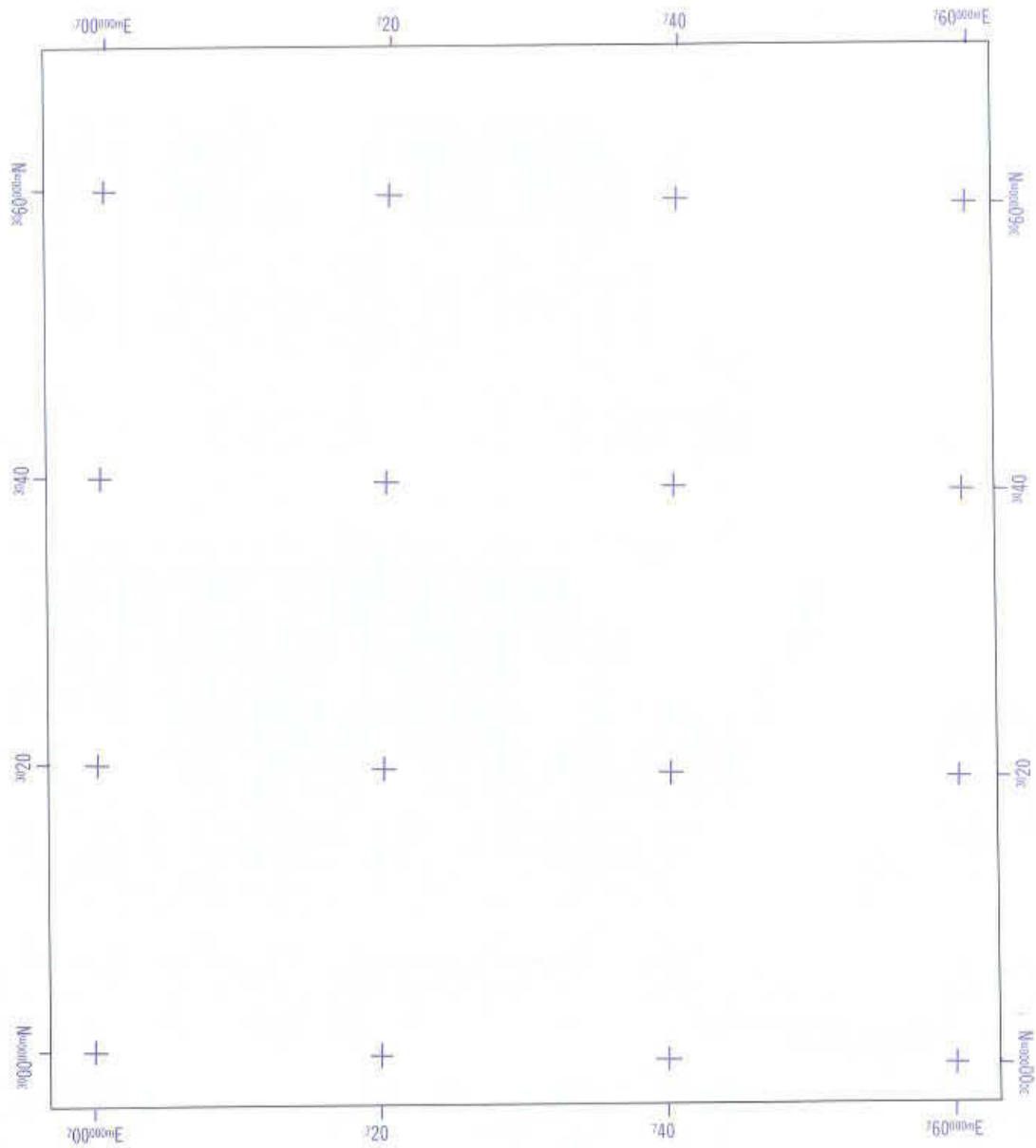

UNIVERSAL TRANSVERSE MERCATOR (UTM) GRID
ZONE 39R, WORLD GEODETIC SYSTEM
FOR MILITARY GRID REFERENCE

Figure 44. Treatment for the Major Grid on Nautical Charts at Scales Smaller than 1:75,000.

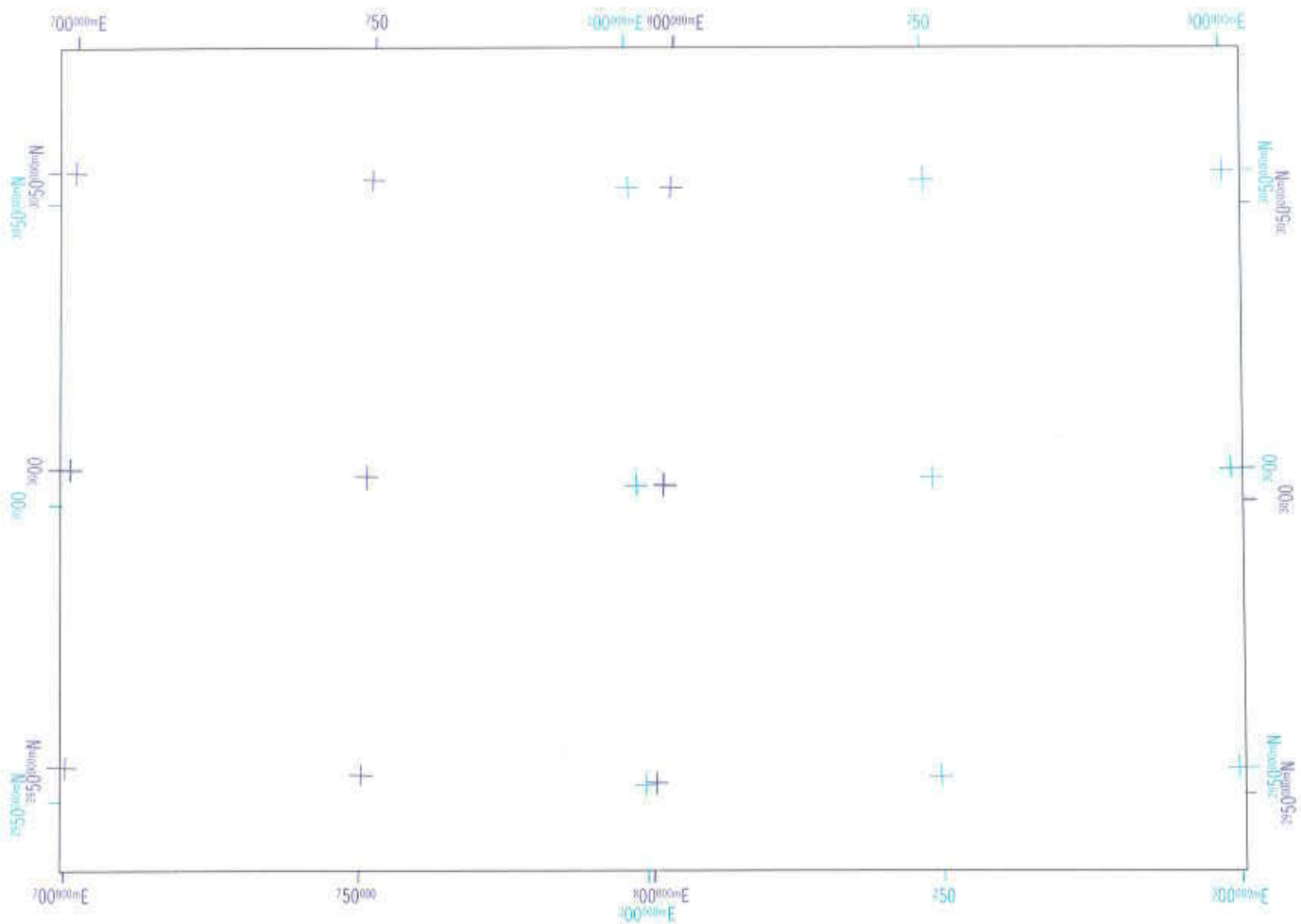

UNIVERSAL TRANSVERSE MERCATOR (UTM) GRID
 ZONES 39R, 40R, WORLD GEODETIC SYSTEM
 FOR MILITARY GRID REFERENCE

Figure 45. Treatment for Multiple Grids on Nautical Charts at Scales Smaller than 1:75,000.

10-4.5 When a secondary grid differs uniformly from the major grid, a coordinate shift note may be used in lieu of showing the secondary grid. The note should be printed in red-brown and patterned after the following:

TO REFER THIS CHART TO EUROPEAN DATUM:
 SUBTRACT 0.1 SECONDS FROM THE LATITUDE VALUE;
 AND ADD 1.1 SECONDS TO THE LONGITUDE VALUE;
 SUBTRACT 9 METERS FROM THE UTM GRID NORTHING VALUE AND
 ADD 30 METERS TO THE UTM GRID EASTING VALUE.

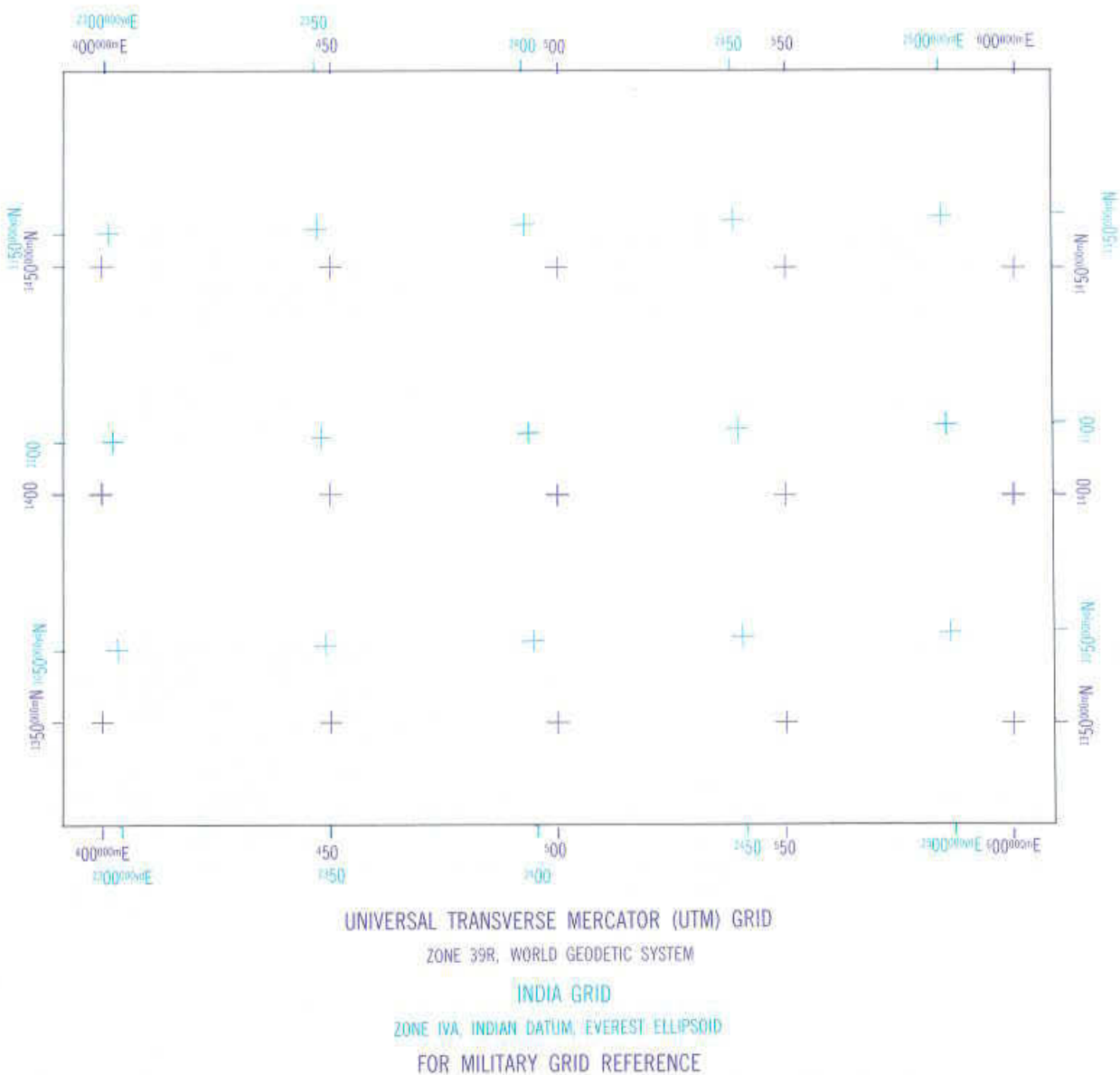

Figure 46. Treatment for Major and Secondary Grids on Nautical Charts at Scales Smaller than 1:75,000.

10-4.6 Figure 46 illustrates the treatment described for charts containing major and secondary grids.

10-5 THE GRID REFERENCE BOX (OR NOTES).

A grid reference box, printed in purple appears in the margin or on the face of each chart depending on available space. The box contains instructions and attendant data to enable the user to compose standard grid references. For information relating to the grid reference box, see Chapter 9 paragraph 9-11.

10-6 WORLD GEODETIC SYSTEM (WGS) DATUM NOTE.

For information relating to the appropriate WGS Datum Note, see Chapter 9 paragraph 9-12.

CHAPTER 11

GRIDS ON AERONAUTICAL CHARTS AT 1:500,000 SCALE AND LARGER

11-1 GENERAL.

11-1.1 The treatment of the grid and isogonic data for the 1:250,000 scale Joint Operations Graphic Air (JOG-A) series is contained in Chapter 7.

11-1.2 Grid data and grid format for the aeronautical chart at 1:500,000 scale are essentially the same for Universal Transverse Mercator grids, Universal Polar Stereographic grids, and nonstandard grids. Sheet lines of charts at these scales are planned to provide a uniform sheet size. Details of the chart format and size are contained in the appropriate product specification.

11-1.3 The grid data consist of grid lines and values, grid reference boxes, notes identifying the grids, and information concerning the magnetic declination over the sheet. Secondary, overlapping and extended grids are not shown.

11-2 THE MAJOR GRID.

11-2.1 The major grid is shown by full lines printed in blue, at 100,000-unit intervals. Ticks are shown at 10,000-unit intervals along the grid lines and neatlines. (For sheets covering the United States, full lines will be shown at 50,000-meter intervals, with intensified lines at 100,000-meter intervals.) The unit of measure is predominately meters; yards are used for some nonstandard grids.

11-2.2 Grid lines are labeled along the margins as follows:

11-2.2.1 Full grid line values shall be shown at the first grid line in each direction from each corner. They are also shown if there is a change of the measuring unit. (Show four pair of full grid line values per unit of measurement only.) Except for the values labeling the first grid line from each corner, the last four digits (0000) of the values are omitted. The values are shown in two sizes of type, with the larger size being reserved for the principal digits.

11-2.2.2 Full grid tick values shall include the abbreviated designation of the measuring unit "m." for meters or "yds." for yards and the abbreviated geographic designation of the tick, "N." for Northings and "E." for Eastings.

11-2.2.3 Intermediate grid line and tick values are shown in the margins and include only the principal digits and digits prefixing the principal digits. The end of each grid line within the neatline are labeled in this manner. With most grids, one principal digit is used. This represents the 10,000-unit digit of the grid values. Two principal digits are used with the Madagascar grid and the Lambert grids of northwest Africa. These represent the 100,000- and 10,000-unit digits of the grid values.

11-2.3 The grid square identification (100,000-unit squares) is shown near each 100,000-unit grid line intersection. When the intersection is coincident with the west or south neatline, only the identification letters falling inside the neatline are shown. When the intersection is coincident with the east or north neatline, identification letters are shown on both sides of the neatline.

11-2.4 On aeronautical charts at 1:500,000 scale, all grid information is printed in blue.

11-2.5 A grid note appears in the lower margin of each sheet to identify the grid. The note is part of the grid reference box and is modeled after the following:

BLUE NUMBERED LINES INDICATE 100,000 METERS.
TICKS 10,000 METERS, UNIVERSAL TRANSVERSE MERCATOR
GRID, ZONE 53S, BESSEL ELLIPSOID

BLUE NUMBERED LINES INDICATE 100,000 METERS,
TICKS 10,000 METERS, LAMBERT SUD MAROC GRID

11-2.6 When the entire grid falls within one ellipsoid, the ellipsoid is not identified within the grid reference box but beneath it as follows:

Entire UTM Grid falls within International Ellipsoid.

11-2.7 In most instances a sheet contains more than one major grid. Grid, ellipsoid, and zone junctions are indicated by solid blue lines. Labels are shown on each side of the junction line. The labels may be shown more than once to facilitate identification. Where a grid, ellipsoid, or zone junction is coincident with the south or west neatline, only the identifying names within the chart area will be shown.

11-2.8 Junction line labels are modeled after the following:

BESSEL ELLIPSOID
WORLD GEODETIC SYSTEM 1972 ELLIPSOID
SUD ALGERIE GRID
UTM GRID ZONE DESIGNATION: 31R
UTM GRID ZONE DESIGNATION: 15C
UPS GRID ZONE DESIGNATION: A

11-2.8.1 When the grids are different zones of the UTM grid, the note is modeled after the following:

BLUE NUMBERED LINES INDICATE 100,000 METERS.
TICKS 10,000 METERS, UNIVERSAL TRANSVERSE MERCATOR
GRID, ZONES 50 AND 51, CLARKE 1866 ELLIPSOID

11-2.8.2 When more than one grid is involved, the notes are modeled after the following:

IN AREAS COVERED BY UTM GRID: BLUE NUMBERED LINES
INDICATE THE 100,000 METERS, TICKS 10,000 METERS,
UNIVERSAL TRANSVERSE MERCATOR GRID, ZONE 37X,
INTERNATIONAL ELLIPSOID

IN AREAS COVERED BY UPS GRID: BLUE NUMBERED LINES
INDICATE THE 100,000 METERS, TICKS 10,000 METERS
UNIVERSAL POLAR STEREOGRAPHIC GRID, ZONE Z,
INTERNATIONAL ELLIPSOID

11-2.8.3 A separate marginal note is not shown for the grid in the north or east overlap of a chart. Such a grid is identified on the face of the chart only.

11-2.9 When an ellipsoid junction occurs on a chart, the UTM grid treatment is the same as that followed when a sheet straddles a grid junction. The ellipsoids are identified on

each side of the junction line. See figure 30. A note, printed in the same color as the grid values, appears in the lower margin of the sheet identifying the grid(s), zone(s), and ellipsoids.

BLUE NUMBERED LINES INDICATE 100,000 METERS.
TICKS 10,000 METERS UNIVERSAL TRANSVERSE MERCATOR
GRID, ZONE 52T, WGS ELLIPSOID, AND ZONE 52T,
BESSEL ELLIPSOID

11-2.10 In certain cases, a sheet bearing the UTM grid may straddle a parallel which marks the division between different grid zone designations. The grid and corresponding labeling appear as previously described. A continuous line in black indicates the dividing parallel. The proper grid zone designations appear on each side of the line. The dividing parallel is omitted when it falls within 2.5 mm (0.10 inch) of the north or south neatlines. Figure 31 illustrates these principles.

11-3 GRID DECLINATION.

Grid declination from true north is not shown on 1:500,000 scale aeronautical charts.

11-4 MAGNETIC DECLINATION.

11-4.1 Isogonic lines are shown on the face of the sheet. In addition to the isogonic lines, a note modeled after the following is shown in the margin:

LINES OF EQUAL MAGNETIC VARIATION FOR 1990
(Annual rate of change, no change)

11-4.2 When the magnetic variation is approximately the same over the entire chart, no isogonic lines are shown, and the magnetic variation is indicated by a note modeled after the following:

MAGNETIC VARIATION FOR 1990 IS APPROXIMATELY
1°W OVER THE ENTIRE AREA
(Annual rate of change 7' decrease)

11-5 THE GRID REFERENCE BOX.

11-5.1 A grid reference box appears in the margin of each sheet. The box contains step-by-step instructions for composing a grid reference. For examples, see figure 47. The applicable grid zone designation is also identified in the box.

11-5.2 The grid system(s) in use on the map dictates the referencing instructions contained in the grid reference box.

11-5.3 When more than one major grid appears on a sheet and the method for giving a reference is the same for all the grids, a common reference box is used.

11-5.4 When more than one major grid appears on a sheet and the method for giving a reference varies with the grids, circumstances control the treatment of the grid reference boxes. A grid reference box is shown in the margin for each grid, except those falling completely in open water area. At the top of each box appears a note limiting the use of the box to the grid or grids concerned.

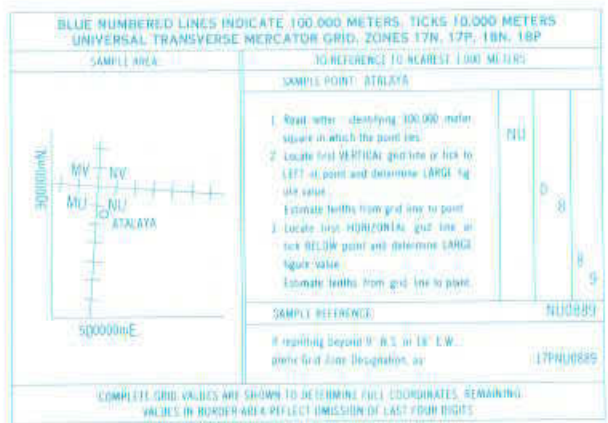

Figure 47. Grid Reference Box Commonly Used on Aeronautical Charts at 1:500,000 Scale and Larger.

APPENDIX A
TABLE OF MIL
EQUIVALENTS

DMA TM 8358.1

TABLE OF MIL
EQUIVALENTS

DEGREE TO MILS					
DEG	MILS	DEG	MILS	DEG	MILS
1	17.7778	21	373.3333	41	728.8889
2	35.5556	22	391.1111	42	746.6667
3	53.3333	23	408.8889	43	764.4444
4	71.1111	24	426.6667	44	782.2222
5	88.8889	25	444.4444	45	800.0000
6	106.6667	26	462.2222	46	817.7778
7	124.4444	27	480.0000	47	835.5556
8	142.2222	28	497.7778	48	853.3333
9	160.0000	29	515.5556	49	871.1111
10	177.7778	30	533.3333	50	888.8889
11	195.5556	31	551.1111	51	906.6667
12	213.3333	32	568.8889	52	924.4444
13	231.1111	33	586.6667	53	942.2222
14	248.8889	34	604.4444	54	960.0000
15	266.6667	35	622.2222	55	977.7778
16	284.4444	36	640.0000	56	995.5556
17	302.2222	37	657.7778	57	1013.3333
18	320.0000	38	675.5565	58	1031.1111
19	337.7778	39	693.3333	59	1048.8889
20	355.5556	40	711.1111	60	1066.6667

MINUTES TO MILS					
MIN	MILS	MIN	MILS	MIN	MILS
1	.2963	21	6.2222	41	12.1481
2	.5926	22	6.5185	42	12.4444
3	.8889	23	6.8148	43	12.7407
4	1.1852	24	7.1111	44	13.0370
5	1.4815	25	7.4074	45	13.3333
6	1.7778	26	7.7037	46	13.6296
7	2.0741	27	8.0000	47	13.9259
8	2.3704	28	8.2963	48	14.2222
9	2.6667	29	8.5926	49	14.5185
10	2.9630	30	8.8889	50	14.8148
11	3.2593	31	9.1852	51	15.1111
12	3.5556	32	9.4815	52	15.4074
13	3.8519	33	9.7778	53	15.7037
14	4.1481	34	10.0741	54	16.0000
15	4.4444	35	10.3704	55	16.2963
16	4.7407	36	10.6667	56	16.5926
17	5.0370	37	10.9630	57	16.8889
18	5.3333	38	11.2593	58	17.1852
19	5.6296	39	11.5556	59	17.4815
20	5.9259	40	11.8519	60	17.7778

SECONDS TO MILS					
SEC	MILS	SEC	MILS	SEC	MILS
1	.0049	21	.1037	41	.2025
2	.0099	22	.1086	42	.2074
3	.0148	23	.1136	43	.2123
4	.0198	24	.1185	44	.2173
5	.0247	25	.1235	45	.2222
6	.0296	26	.1284	46	.2272
7	.0346	27	.1333	47	.2321
8	.0395	28	.1383	48	.2370
9	.0444	29	.1432	49	.2420
10	.0494	30	.1481	50	.2469
11	.0543	31	.1531	51	.2519
12	.0593	32	.1580	52	.2568
13	.0642	33	.1630	53	.2617
14	.0691	34	.1679	54	.2667
15	.0741	35	.1728	55	.2716
16	.0790	36	.1778	56	.2765
17	.0840	37	.1827	57	.2815
18	.0889	38	.1877	58	.2864
19	.0938	39	.1926	59	.2914
20	.0988	40	.1975	60	.2963

NOTE: 360 DEGREES = 6400 MILS

APPENDIX B
100,000-METER SQUARE
IDENTIFICATIONS OF
MILITARY GRID
REFERENCE SYSTEM

TO DETERMINE THE UTM OR UPS 100,000-METER SQUARE MGRS IDENTIFICATION

B-1. These instructions provide a method for determining the correct UTM or UPS 100,000-meter square identification for any point in the world. See Chapter 3 for a full explanation of the 100,000-meter square identification. If geographic coordinates are the only coordinates given, they must be transformed to UTM or UPS grid coordinates. The following data are necessary to determine the correct 100,000-meter square letters:

B-1.1 For the UPS grid:

B-1.1.1 UPS grid coordinates (easting and northing).

B-1.1.2 The polar zone in which the coordinates are located.

B-1.2 For the UTM grid:

B-1.2.1 UTM grid coordinates (easting and northing).

B-1.2.2 UTM grid zone

B-1.2.3 Geographic coordinates or the 8° latitude band letter which is the Grid Zone Designation letter.

B-1.2.4 Ellipsoid and/or datum.

B-2 Determine by area, datum, and/or ellipsoid which of the following figures is appropriate:

Figure B-1: North of 84°N.

Figure B-2: South of 80°S.

Figure B-3: Geodetic Reference System (GRS 1980)
International
World Geodetic System 1984

Figure B-4: Bessel 1841

B-3 Method of use with the UPS grid:

B-3.1 If the coordinates fall in the north Polar region, use figure B-1 to determine the correct square identification letters. If the coordinates fall in the south Polar region, use figure B-2.

B-3.2 In figures B-1 and B-2, the easting lines are labeled every 500,000 meters from left to right with the 2,000,000 meter line being coincident with the 0° and 180° line. If the easting is less than 2,000,000 meters the Grid Zone Designation will be Y or A depending on whether the point is in the North or South Polar region. If the easting is greater than 2,000,000 meters the Grid Zone Designation will be Z or B. The northing lines are labeled every 500,000 meters from bottom to top with the 2,000,000 meter line coincident with the 90°W and 90°E line.

B-3.3 Reduce both easting and northing to the nearest 100,000 meters.

B-3.4 Find these grid lines on the figure.

B-3.5 The 100,000-meter square will be to the right and above these lines.

B-3.6 The procedure is the same for the north Polar region or the south Polar region.

Example: At latitude $86^{\circ}46'$ north, longitude $132^{\circ}30'$ west,
UPS grid coordinates were scaled, $E = 1,735,000$
 $N = 2,243,000$ in the North Polar area.

Use figure B-1.

The easting is less than 2,000,000 meters, therefore
the grid zone designation is Y.

The coordinates reduced to the nearest 100,000 meters
are: $E = 1,700,000$ $N = 2,200,000$.

The 100,000-meter square letters to the right and above
the intersection of these lines are XK.

MGRS to the nearest 1,000 meters is YXK3543

B-4 Method of use with the UTM grid:

B-4.1 To determine the 100,000-meter square letters for UTM grid coordinates, first determine which figure, B-3 or B-4, is needed. The ellipsoid identifications are specified on each figure.

B-4.2 Locate the zone number in the list at the top of the figure. This identifies the set of designators in which the letters will be found.

B-4.3 If the 8° latitude band letter is given, it will be used as the grid designation letter. If the geographic coordinates are given, use the latitude of the point to determine the grid zone designation letter from Appendix D.

B-4.4 Reduce the easting to the nearest 100,000 meters. Find the 100,000-meter easting grid line within the grid zone identified in paragraph B-4.2. The easting lines are labeled below the figure, from 200,000 meters to 800,000 meters within each zone.

B-4.5 Reduce the grid northing by multiples of 2,000,000 meters until the resulting value is between 0 and 2,000,000 meters. Further reduce the grid northing to the nearest 100,000 meters. Find the 100,000-meter northing grid line. The northing lines are labeled at the left side of the figure.

B-4.6 The 100,000-meter square will be to the right and above the intersection of the lines found in paragraphs B-4.4 and B-4.5.

B-4.7 The procedure is the same for the northern hemisphere or the southern hemisphere.

Example: At latitude 34°15' north, longitude 88°36' east,
UTM grid coordinates were scaled, E = 647,000
N = 3,791,000 in UTM zone 45, grid zone
designation letter S.
Grid zone designation is 45S.
The point is referenced to the WGS ellipsoid, therefore
use figure B-3 and set 3 of the zones.
The easting is reduced to 600,000 meters.
For an easting of 600,000 meters start at the column X.
Reduce the northing by 2,000,000 meters and then to the
nearest 100,000 meters, obtaining 1,700,000 and
read across that grid line to the intersection
with the 600,000 meter easting line in zone 45.
The 100,000-meter square letters to the right and above
this intersection is XT.
MGRS to the nearest 1,000 meters is 45SXT4791.

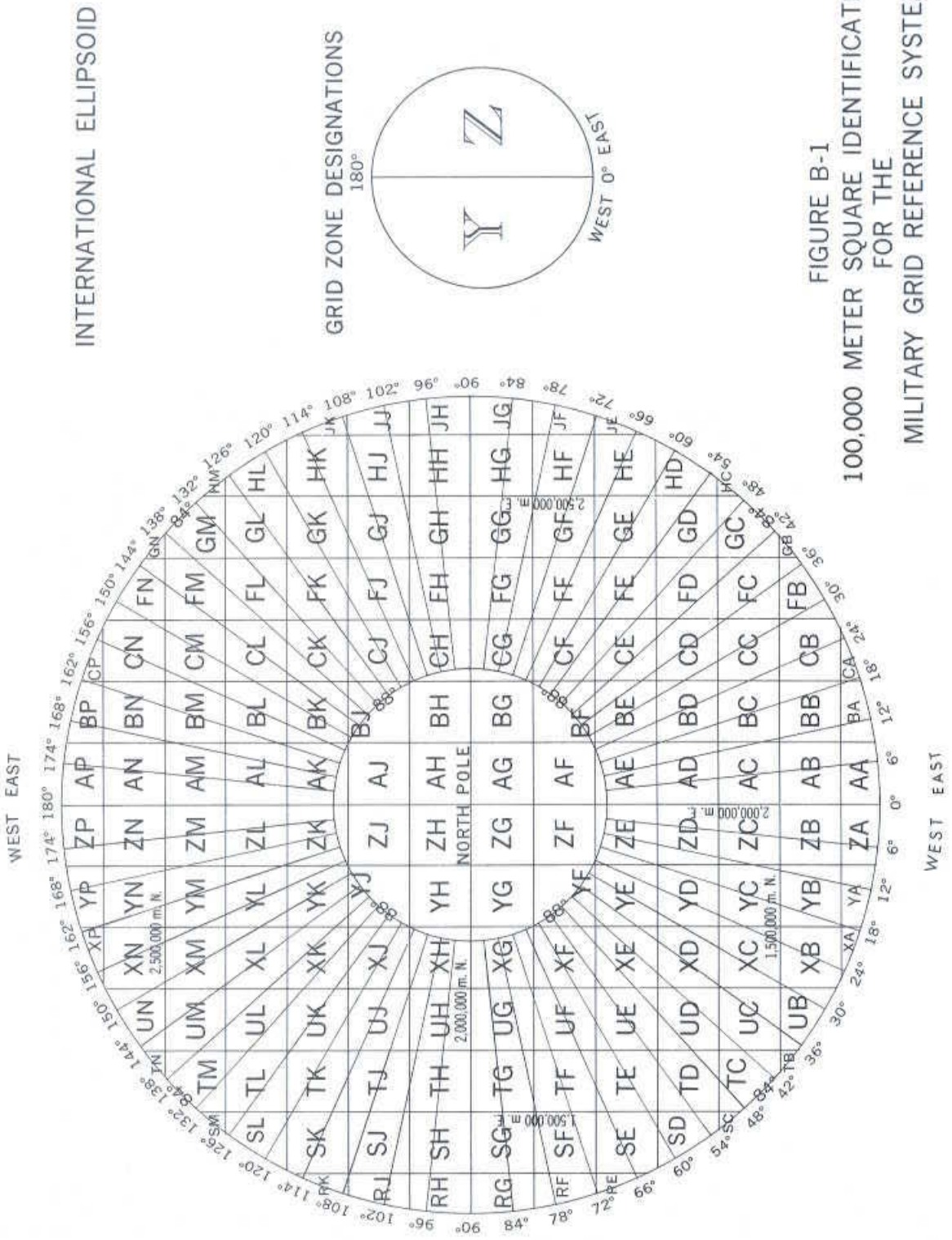

FIGURE B-1
 100,000 METER SQUARE IDENTIFICATIONS
 FOR THE
 MILITARY GRID REFERENCE SYSTEM

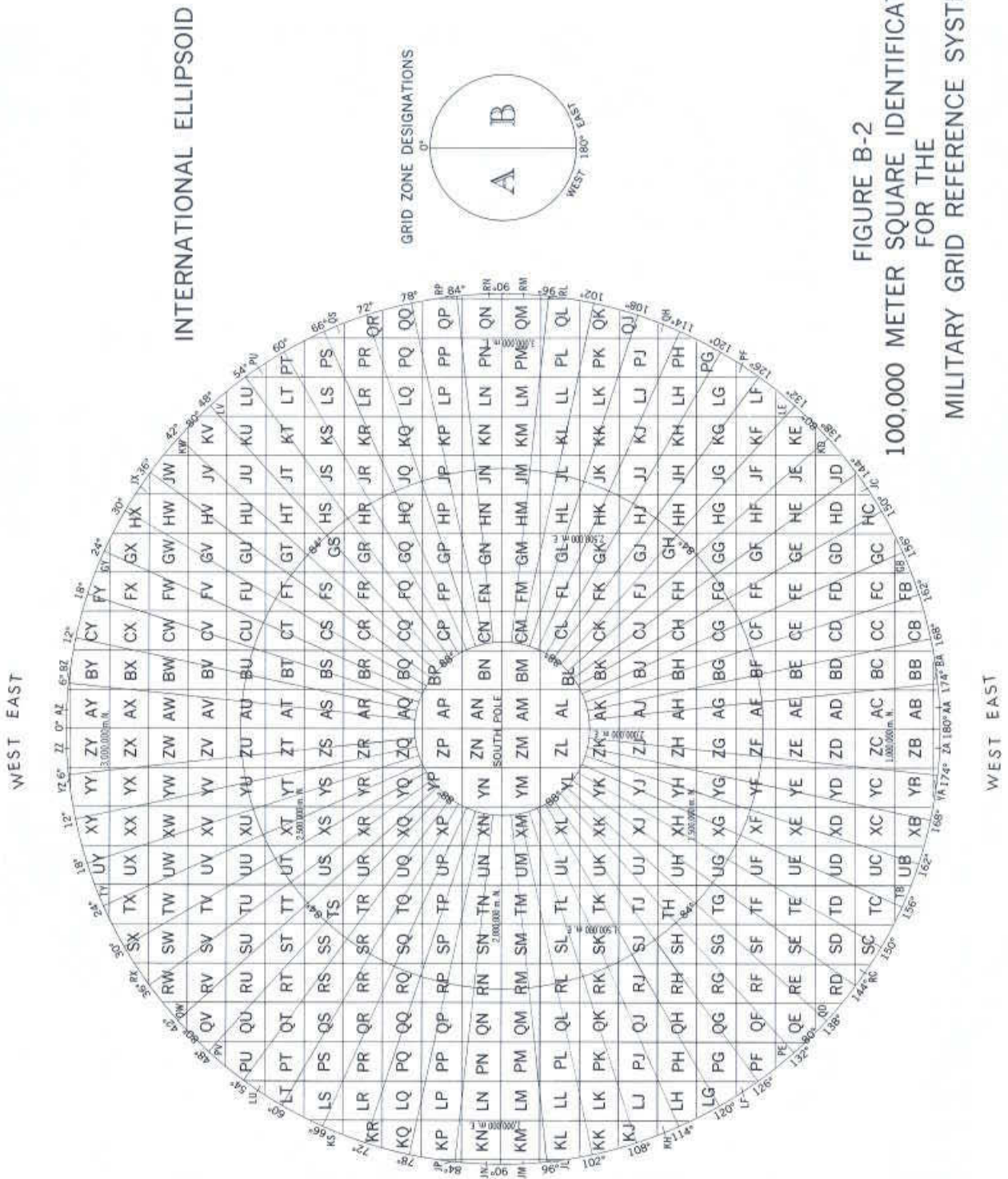
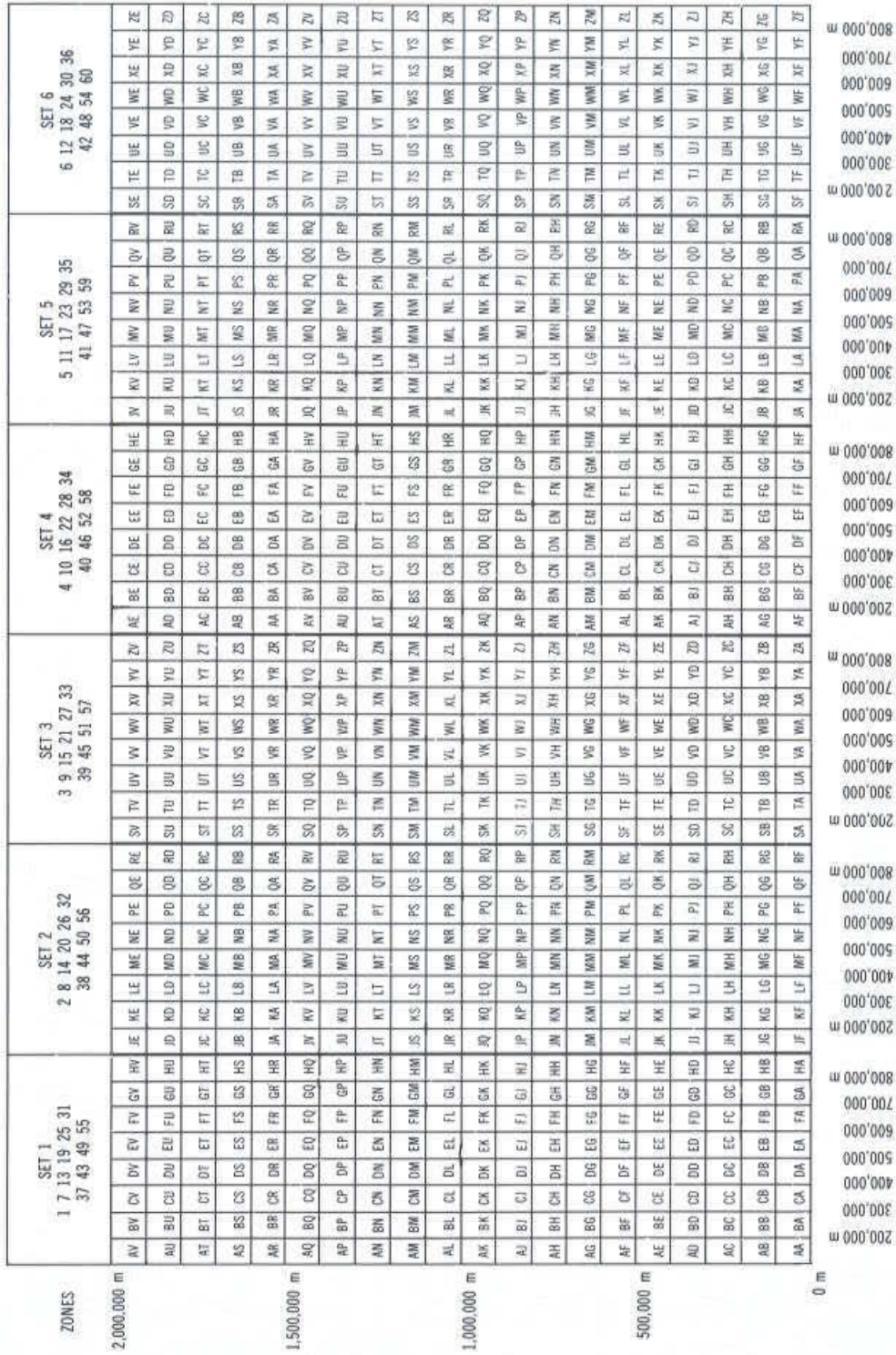
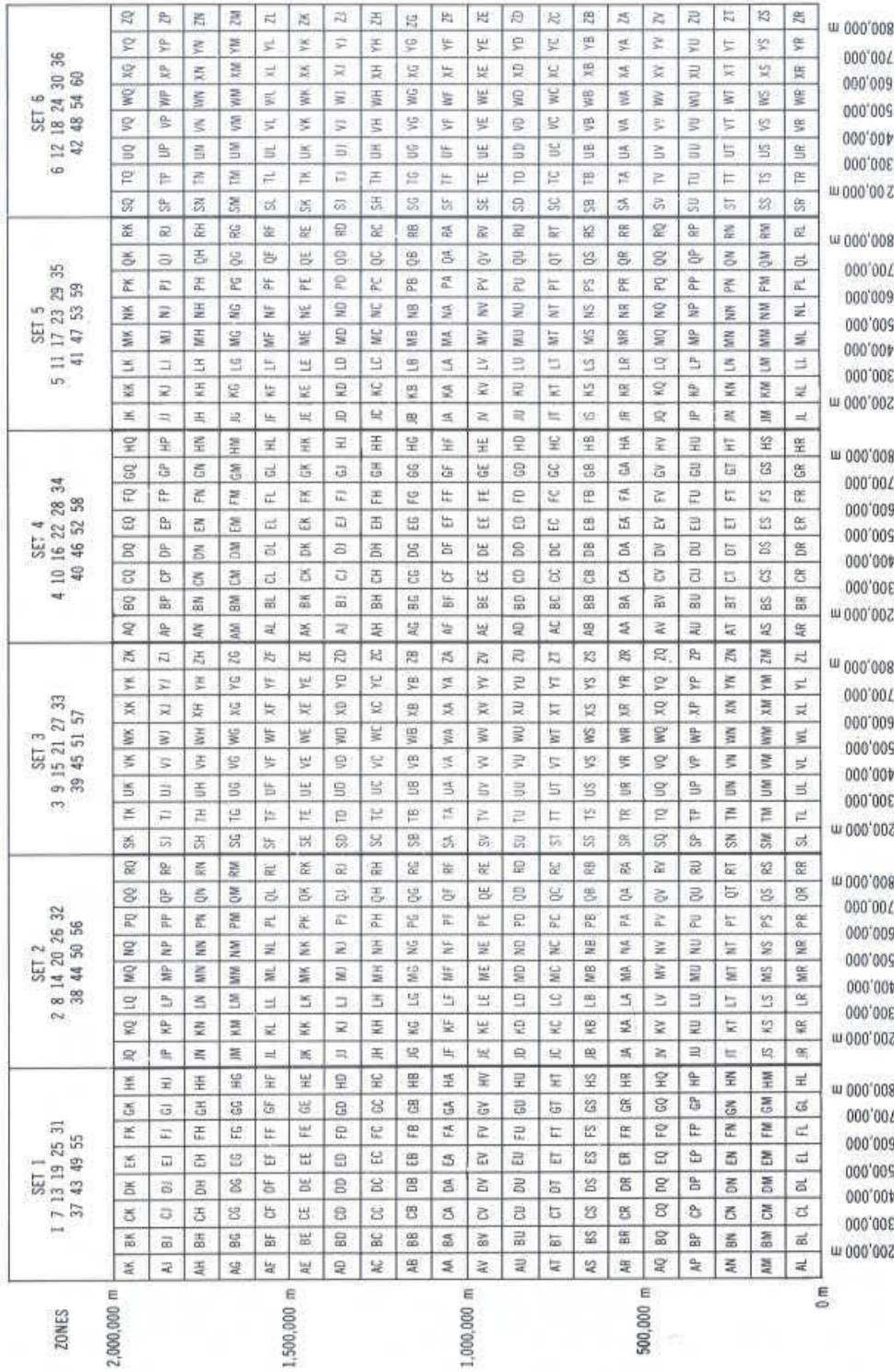

FIGURE B-2
 100,000 METER SQUARE IDENTIFICATIONS
 FOR THE
 MILITARY GRID REFERENCE SYSTEM





USE THIS DIAGRAM FOR: CLARKE 1866 ELLIPSOID (AREA COVERED BY NORTH AMERICAN 1927 DATUM (NAD 27))

CLARKE 1880 ELLIPSOID
BESSELE ELLIPSOID

FIGURE B-4

IN THE NORTH AND SOUTH HEMISPHERES

APPENDIX C
GUIDE TO
GEODETTIC STATUS
OF LARGE
SCALE MAPPING

GUIDE TO GEODETIC STATUS¹
OF LARGE SCALE MAPPING

DATUM CODES

- A Map sheets are on preferred datum.
- B Mapping is being converted to preferred datum.
- C Map sheets are not on preferred datum.
- * Insufficient or unavailable information.

GRID CODES

- 1 Map sheets portray UTM or UPS grid.
- 2 Map sheets portray a nonstandard preferred grid.
- 3 Mapping is being converted to a preferred grid.
- 4 Map sheets portray a nonpreferred grid.
- * Insufficient or unavailable information.

SERIES	AREA	DATUM/GRID
A741	CANADA	B 1
A742	CANADA	B 1
C762	ICELAND	C 1
E703	LESSER ANTILLES	* *
E712	BAHAMAS; TURKS AND CAICOS	* *
E714	BAHAMAS	* *
E721	JAMAICA	C 1
E722	CAYMAN ISLANDS	* *
E724	CUBA	C 1
E732	HAITI	C 1
E733	DOMINICAN REPUBLIC	C 1
E735	PUERTO RICO	B 1
E736	VIRGIN ISLANDS	B 1
E741	MARTINIQUE	C 4
E742	TRINIDAD AND TOBAGO	C 4
E751	NICARAGUA	B 1
E752	HONDURAS	B 1
E753	EL SALVADOR	B 1
E754	GUATEMALA	C 1
E755	BELIZE	C 1
E762	PANAMA	B 1
E763	COSTA RICA	B 1
E772	COLOMBIA	* *
E785	VENEZUELA	C 1
E792	GUYANA	* *
E793	SURINAME	* *
E794	FRENCH GUIANA	* *
F701	MEXICO	* *
G712	CAPE VERDE	* *
G722 ²	MALI	C 1
G723 ²	MAURITANIA	C 1
G724 ²	THE GAMBIA	C 1
G725 ²	SENEGAL	C 1

G726 ²	WESTERN SAHARA	C	1
G731 ²	NIGER	C	1
G742 ²	SIERRA LEONE	C	1
G744 ²	LIBERIA	C	1
G745 ²	GUINEA-BISSAU	C	1
G746 ²	GUINEA	C	1
G751	GHANA	C	*
G753 ²	BENIN	C	1
G754 ²	IVORY COAST	C	1
G755 ²	TOGO	C	1
G756 ²	BURKINA	C	1
G764 ²	NIGERIA	C	1
G771 ²	EQUATORIAL GUINEA	C	1
G772 ²	CAMEROON	C	1
G773 ²	EQUATORIAL GUINEA	C	1
G774 ²	CONGO	C	1
G775 ²	GABON	C	1
G781 ²	CENTRAL AFRICAN REPUBLIC	C	1
G782 ²	CHAD	C	1
G791 ²	SAO TOME AND PRINCIPE	C	1
G792	ST HELENA	*	*
G793	ST HELENA	*	*
H701	ARGENTINA	*	*
H702	BRAZIL	C	1
H733	BOLIVIA	B	1
H741	PARAGUAY	C	1
H771	URUGUAY	C	1
J701	CHILE	C	1
J722	ECUADOR	C	1
J731	PERU	B	1
K717	CYPRUS	A	1
K723 ²	SYRIA	C	1
K724 ²	LEBANON	C	1
K724S ²	LEBANON	C	1
K725 ²	SYRIA	C	1
K737 ²	JORDAN	C	1
K737S ²	JORDAN	C	1
K739 ²	ISRAEL	C	1
K743	IRAQ	B	1
K753	IRAN	B	1
K7610	BAHRAIN	C	1
K7614	KUWAIT	A	1
K7615	UNITED ARAB EMIRATES	A	1
K7617	QATAR	A	1
K7619	YEMEN (SANAA)	A	1
K762	YEMEN (ADEN)	C	1
K763	SAUDI ARABIA	*	*
K768	OMAN	C	1
L7001	TAIWAN, HONG KONG, MACAU	C	1

L7010	MALAYSIA	C	4
L7014	VIETNAM	C	1
L7015	LAOS	C	1
L7016	CAMBODIA	C	1
L7017	THAILAND	C	1
L7021	CHINA	*	*
L7023	MONGOLIA	*	*
L752	SOUTH KOREA, NORTH KOREA	A	1
L753	SOUTH KOREA, NORTH KOREA	A	1
L776	JAPAN	A	1
M619	SWEDEN	C	1
M7020	ALBANIA	A	1
M704	BULGARIA	A	1
M705	ROMANIA	B	1
M709	YUGOSLAVIA	A	1
M711	NORWAY	B	1
M713	FINLAND	B	1
M715	DENMARK	A	1
M716	SWEDEN	C	1
M726	UNITED KINGDOM	A	2
M733	NETHERLANDS	A	1
M736	BELGIUM	A	1
M745	WEST GERMANY, EAST GERMANY	A	1
M753	POLAND	B	1
M761	FRANCE	A	1
M771	AUSTRIA	A	1
M774	CZECHOSLOVAKIA	B	1
M775	HUNGARY	B	1
M781	SPAIN	A	1
M7812	AZORES	*	*
M782	PORTUGAL	A	1
M783	BALLEARIC ISLANDS	A	1
M792	ITALY	A	1
M795	SWITZERLAND	C	1
M796	MALTA	*	*
N701	USSR	B	1
N7011	USSR	A	1
N707	USSR	A	1
N709	USSR	*	*
P711	CANARY ISLANDS	*	*
P722	MADEIRAS ISLANDS	*	*
P733 ²	MOROCCO	C	4
P741S	ALGERIA	*	*
P743 ²	ALGERIA	C	4
P751 ²	TUNISIA	C	4
P761 ²	LIBYA	C	1
P761S ²	LIBYA	C	1
P773 ²	EGYPT	C	1
P777 ²	EGYPT	C	1

Q701	UNITED STATES	C	1
R712	AUSTRALIA	*	*
R722	AUSTRALIA	*	*
R733	AUSTRALIA	C	1
R742	AUSTRALIA	*	*
R753	AUSTRALIA	*	*
R754	AUSTRALIA	*	*
R777	NEW ZEALAND	*	*
S701	PHILIPPINES	C	1
T702	PAPUA NEW GUINEA	*	*
T7113	INDONESIA	C	1
T725	INDONESIA	*	*
T728	INDONESIA	C	*
T731	INDONESIA	C	*
T735	MALAYSIA, BRUNEI	C	4
T753	INDONESIA	*	*
U711	AFGHANISTAN	C	1
U722	PAKISTAN	B	3
U723	BANGLADESH	B	3
U744	BURMA	*	*
U753	INDIA	B	3
U763	NEPAL	*	*
U771	SRI LANKA	B	3
U782	BRITISH INDIAN OCEAN TERRITORY	*	*
U784	MALDIVES	*	*
V712	UNITED STATES	B	1
V713	UNITED STATES	B	1
V714	UNITED STATES	B	1
V715	UNITED STATES	B	1
V716	UNITED STATES	B	1
V721	UNITED STATES	B	1
V722	UNITED STATES	B	1
V731	UNITED STATES	B	1
V733	UNITED STATES	B	1
V734	UNITED STATES	B	1
V741	UNITED STATES	B	1
V742	UNITED STATES	B	1
V743	UNITED STATES	B	1
V744	UNITED STATES	B	1
V745	UNITED STATES	B	1
V746	UNITED STATES	B	1
V747	UNITED STATES	B	1
V751	UNITED STATES	B	1
V752	UNITED STATES	B	1
V753	UNITED STATES	B	1
V754	UNITED STATES	B	1
V761	UNITED STATES	B	1
V762	UNITED STATES	B	1
V763	UNITED STATES	B	1

V772	UNITED STATES	B	1
V774	UNITED STATES	B	1
V775	UNITED STATES	B	1
V776	UNITED STATES	B	1
V777	UNITED STATES	B	1
V778	UNITED STATES	B	1
V779	UNITED STATES	B	1
V781	UNITED STATES	B	1
V782	UNITED STATES	B	1
V783	UNITED STATES	B	1
V784	UNITED STATES	B	1
V785	UNITED STATES	B	1
V791	UNITED STATES	B	1
V792	UNITED STATES	B	1
V793	UNITED STATES	B	1
V794	UNITED STATES	B	1
V795	UNITED STATES	B	1
V796	UNITED STATES	B	1
V796	UNITED STATES	B	1
V797	UNITED STATES	B	1
V798	UNITED STATES	B	1
W721	WAKE ISLAND	*	*
W733	UNITED STATES	A	1
W743	GUAM, NORTHERN MARIANAS	A	1
W756	CAROLINE ISLANDS	*	*
W761	MARSHALL ISLANDS	*	*
X701	FRENCH POLYNESIA	*	*
X711	SOLOMAN ISLAND	*	*
X721	VANUATU	*	*
X731	NEW CALEDONIA	*	*
X7411	TUVALU	*	*
X746	KIRIBATI AND PHOENIX ISLAND	*	*
X747	WALLIS AND FUTUNA	*	*
X754	FIJI	*	*
X765	AMERICAN SAMOA	*	*
X769	WESTERN SAMOA	*	*
X773	TONGA	*	*
Y627	DJIBOUTI	C	1
Y628	ETHIOPIA	*	*
Y712	SUDAN	*	*
Y722 ²	ETHIOPIA	C	1
Y724	SOMALIA	C	1
Y731	KENYA	*	*
Y732	UGANDA	*	*
Y741	TANZANIA	*	*
Y742	ZANZIBAR ISLAND	*	*
Y752	SEYCHELLES	*	*
Y761	MOZAMBIQUE	*	*
Y775	MADAGASCAR	*	*
Y783	MAURITIUS	*	*

Y784	REUNION	*	*
Z703	ZAIRE	*	*
Z721	BURUNDI	*	*
Z722	RWANDA	*	*
Z731	ANGOLA	*	*
Z741	ZAMBIA	*	*
Z742	MALAWI	*	*
Z745	ZIMBABWE	*	*
Z752	NAMIBIA	*	*
Z753	SOUTH AFRICA	*	*
Z762	BOTSWANA	*	*
Z772	SWAZILAND	*	*
Z783	LESOTHO	*	*
Z784 ²	SOUTH AFRICA	C	1

¹This guide provides information concerning unclassified mapping only. It is based on an appraisal of a majority of the maps available in the series. For information regarding map series not listed contact DMA (PR).

²This will be the correct status for these series if the present configuration of Appendix D is approved.

APPENDIX D
INDEX TO
PREFERRED GRIDS,
DATUMS AND
ELLIPSOIDS SPECIFIED
FOR NEW MAPPING

