



ATSC Standard: Programming Metadata Communication Protocol, Revision B

Document A/76B, 14 January 2008

Advanced Television Systems Committee, Inc.
1750 K Street, N.W., Suite 1200
Washington, D.C. 20006



The Advanced Television Systems Committee, Inc., is an international, non-profit organization developing voluntary standards for digital television. The ATSC member organizations represent the broadcast, broadcast equipment, motion picture, consumer electronics, computer, cable, satellite, and semiconductor industries.

Specifically, ATSC is working to coordinate television standards among different communications media focusing on digital television, interactive systems, and broadband multimedia communications. ATSC is also developing digital television implementation strategies and presenting educational seminars on the ATSC standards.

ATSC was formed in 1982 by the member organizations of the Joint Committee on InterSociety Coordination (JCIC): the Electronic Industries Association (EIA), the Institute of Electrical and Electronic Engineers (IEEE), the National Association of Broadcasters (NAB), the National Cable Television Association (NCTA), and the Society of Motion Picture and Television Engineers (SMPTE). Currently, there are approximately 140 members representing the broadcast, broadcast equipment, motion picture, consumer electronics, computer, cable, satellite, and semiconductor industries.

ATSC Digital TV Standards include digital high definition television (HDTV), standard definition television (SDTV), data broadcasting, multichannel surround-sound audio, and satellite direct-to-home broadcasting. Contact information is given below.

Mailing address	Advanced Television Systems Committee, Inc. 1750 K Street, N.W., Suite 1200 Washington, D.C. 20006
Telephone	202-872-9160 (voice) 202-872-9161 (fax)
Web site	http://www.atsc.org
E-mail	standards@atsc.org

The revision history of this document is given below.

A/76 Revision History

A/76 approved	10 November 2004
Revision A approved This revision added support for the ACAP data broadcast services and changed to a modular design approach. It also included one minor change in order to add optional support for multiple languages in the RRT.	18 September 2006
Corrigendum No. 1 approved This corrigendum addressed schema file naming conventions and updated one reference.	25 October 2007
Revision B approved This amendment rolled-up Corrigendum No. 1 and made certain editorial updates.	14 January 2008

Table of Contents

1. SCOPE	7
1.1 Purpose	7
1.2 Extensibility	7
1.3 Application	7
1.4 Organization	7
2. REFERENCES	8
3. DEFINITIONS	8
3.1 Compliance Notation	8
3.2 Abbreviations and Terms	8
4. TRANSPORT	11
4.1 Transport Methods	11
4.2 File Based Transport	11
4.2.1 Common Folders	11
4.2.2 File Name	12
4.3 Connection Based Transport	12
4.3.1 TCP/IP	12
4.3.2 TCP/IP Connections	12
4.3.3 Inactive Connections	12
4.3.4 Unicast	13
4.3.5 List of Devices to Connect To	13
4.3.6 List of Devices to Accept Connections From	13
4.3.7 Initiation of Servers	13
4.3.8 Sending of Messages	13
4.3.9 Encryption	13
4.3.10 Message format	13
5. XML SCHEMA DESCRIPTION	13
5.1 Introduction	13
5.2 Namespace	14
5.2.1 Examples:	14
5.3 Naming Conventions	15
5.4 PMCP Messages	15
5.4.1 Message Validity	16
5.4.2 Message Type	16
5.5 Device Identification	16
5.5.1 Device Name	16
5.5.2 Device Type	16
5.6 Message Identification	17
5.6.1 Message ID	17
5.6.2 Time and Date Stamp	17
5.7 Acknowledgement	17
5.7.1 Valid	17
5.7.2 Invalid	18

5.7.3 OK	18
5.7.4 Error	18
5.7.5 Acknowledgement Timeout	18
5.7.6 Multiple Requests	18
5.8 PmcpMessage Action Attributes	18
5.9 PmcpMessage Children	19
5.9.1 PmcpReply	19
5.9.2 Transport Stream	19
5.9.3 Channel	19
5.9.4 Show	21
5.9.4.1 ISAN	21
5.9.5 PsipEvent	21
5.9.5.1 Precedence for PSIP Event Metadata	21
5.9.6 PSIP Data Events	22
5.9.7 ACAP Service	22
5.9.8 PrivatePmcpInformation	23
5.9.9 Other Children	24
5.9.10 Multiple String Structure Support	24
5.10 PMCP Time Messages	24
5.11 Heartbeat	24
5.11.1 Heartbeat Messages	24
5.11.2 Heartbeat Timing	25
5.11.3 Server Heartbeat Timeout	25
5.11.4 Failed Device	25
5.12 Message Priority and Conflict Management	25
Annex A: PMCP Schema (Normative)	27
Annex B: PMCP Use Cases (Informative)	29
Annex C: PSIP Metadata System Architecture (Informative)	33
C1. SYSTEM COMPONENTS	33
C2. PMCP DATA FLOW	35
C2.1 Program Planning and Listing Service	35
C2.2 Traffic, PSIP Generator, and Automation	36
C2.3 Other Sources of PSIP Information	36
C2.4 Last-Minute Schedule Changes	36
C3. STATION TIMING	37
C3.1 Time Reference	37
C3.2 GPS Time	37
C4. ASSUMPTIONS	37
Annex D: PMCP with Data Broadcasting for ACAP (Informative)	39
D1. SYSTEM COMPONENTS	39
D2. THE PMCP SCHEMA EXTENDED FOR ACAP ENCAPSULATION	41
D3. DATA CAROUSEL TYPE	42

D4. OBJECT CAROUSEL TYPE	43
D5. THE PMCP SCHEMA EXTENDED FOR ACAP SIGNALING	44
D5.1 ACAP Application Type for AIT signaling	45
D5.2 Channel Type for PMT signaling	46
D5.3 ACAP Encapsulation and AIT Signaling	48
D6. PMCP SCHEMA EXTENDED FOR DATA BROADCASTING	50

Index of Tables and Figures

Table 5.1 PMCP Device Types	17
Table A1 Contents of “PPMCP31.zip”	27
Figure 5.1 PMCP message diagram.	20
Figure 5.2 PSIP Data Event type diagram.	23
Figure C1 PSIP metadata system.	33
Figure D1 PSIP metadata system with ACAP.	39
Figure D3 ACAP Object Carousel Type diagram.	42
Figure D2 Encapsulation and fragmentation of BIOP messages.	42
Figure D4 Data Carousel Type diagram.	43
Figure D5 Object Carousel Type diagram.	44
Figure D6 Representation of the contents of the AIT.	45
Figure D7 ACAP Application Type diagram.	46
Figure D8 Application Type diagram.	47
Figure D9 Representation of the contents of the PMT for ACAP data broadcasting.	48
Figure D10 Channel Type diagram for the PMT descriptor.	49
Figure D11 ACAP Data Service Type diagram.	50
Figure D12 The Extended PMCP Schema diagram.	51

ATSC Standard:

Programming Metadata Communication Protocol,

Revision B

1. SCOPE

1.1 Purpose

This standard defines a method for communicating metadata related to PSIP (program and system information protocol), including duplicate data that needs to be entered in other locations in the transport stream. Communication is based on a protocol utilizing XML message documents generated in accordance with a Programming Metadata Communication Protocol (PMCP) XML Schema defined herein.

1.2 Extensibility

The first version of the PMCP standard (Schema 2.0) did not make provision for communication of metadata needed to support optional data services in the broadcast transport stream, metadata needed to support directed channel change (DCC), or metadata needed for PSIP in proposed E-USB transmissions. These items may be addressed in future revisions to the standard.

The second release of PMCP (Schema 3.0) adds support for ATSC A/101 (ACAP) data application metadata and restructures the schema to use the modular approach described in <http://www.w3.org/TR/XMLSchema-1/#compound-schema> in Section 4.2.1. All functions supported by Schema 2.0 are supported by Schema 3.0.

PMCP is also capable of extension to incorporate additional metadata and transactions not directly related to PSIP.

1.3 Application

PMCP communications are intended to apply to systems and equipment that affect production of PSIP tables and the digital television transport stream in studio and network centers and associated remote program planning and listing services.

1.4 Organization

The document is organized as follows:

- Section 1 – Provides this general introduction.
- Section 2 – Lists reference documents.
- Section 3 – Provides definitions of terms, acronyms and abbreviations used in this document.
- Section 4 – Defines the transport mechanisms to be used for PMCP communications.
- Section 5 – Describes the PMCP XML schema and how it is used.
- Annex A – The precise name and location of the PMCP schema.
- Annex B – Provides some informative Use Case XML documents illustrating the use of PMCP.

- Annex C – Provides an informative description of the PSIP metadata system environment in which PMCP is expected to operate.
- Annex D – Provides an informative description of the PSIP metadata system environment with ACAP support in which PMCP is expected to operate.

2. REFERENCES

The following documents are applicable to this standard:

- [1] W3C: Extensible Markup Language (XML) 1.0 (Second Edition), W3C Recommendation 6 October 2000, <http://www.w3.org/TR/2000/REC-xml-20001006> (*normative*).
- [2] W3C: XML Schema, W3C Recommendation, 2 May 2001, <http://www.w3.org/TR/2001/REC-xmlschema-0-20010502/> (*normative*).
- [3] ATSC: A/53 Part 3:2007, “ATSC Digital Television Standard, Part 3 – Service Multiplex and Transport Subsystem Characteristics,” Advanced Television Systems Committee, Washington, D.C., 3 January 2007 (*normative*).
- [4] ATSC: “ATSC Standard: Program and System Information Protocol for Terrestrial Broadcast and Cable (Revision C) with Amendment No. 1,” Doc. A/65C, Advanced Television Systems Committee, Washington, D.C., 2 January 2006; Amendment No. 1 dated 9 May 2006 (*normative*).
- [5] ATSC: “Code Point Registry”, Advanced Television Systems Committee, Washington, D.C. (*informative*).
- [6] ISO: ISO 15706-2:2007 Information and documentation – International Standard Audiovisual Number (ISAN) - Part 2: Version identifier (*normative*).
- [7] ATSC: “ACAP Service Signaling and Announcement,” Doc. A/102, Advanced Television Systems Committee, Washington, D.C., 12 September 2006 (*normative*).
- [8] ATSC: “ATSC Advanced Common Applications Platform (ACAP)” Doc. A/101, Advanced Television Systems Committee, Washington, D.C., 2 August 2005 (*informative*).

3. DEFINITIONS

3.1 Compliance Notation

As used in this document, “shall” denotes a mandatory provision of this standard. “Should” denotes a provision that is recommended but not mandatory. “May” denotes a feature whose presence does not preclude compliance, and that may or may not be present at the option of the implementer.

3.2 Abbreviations and Terms

The following terms, acronyms and abbreviations are used in this specification:

automation event	An entry in a playlist that triggers an action by an automation system to initiate playback, start a machine, switch a signal, control an effect, change a configuration, or other action that changes the content or configuration of a program output channel.
attribute	A qualifier on an XML tag that provides additional information.

CDATA	A predefined XML tag for Character DATA that says, “don't interpret these characters”, as opposed to Parsed Character Data (PCDATA), in which the normal rules of XML syntax apply.
content	Essence plus its metadata .
contentId	A label for content . This may take the form of a global label such as ISAN , or a “house number”.
EPG	Electronic program guide.
essence	Actual program material (audio, video and/or data).
GPS	Global Positioning System.
GPS Time	Time signal distributed via GPS comprising number of seconds elapsed since 0000 Universal Time on 6 January 1980. Offset from UTC by an integer number of seconds (currently 13) due to leap seconds added to UTC but not to GPS time.
interstitial	A special kind of work of typically less than 5 minutes inserted between program segments . May comprise advertisements, promotions, or other short program material.
ISAN	International Standard Audiovisual Number.
metadata	Information about essence .
multiplexer	A device that combines MPEG-2 packets from one or more elementary streams into one or more MPEG-2 transport stream outputs containing a multiplex of packets, or that combines multiple transport streams into a system level multiplex.
namespace	A standard that enables the definition of a unique label for the set of element names defined by a specific schema . A document using that schema can be included in any other document without having a conflict between XML element names. The elements defined in the schema are then uniquely identified so that, for example, the parser can tell when an element called <name> should be interpreted according to that schema, rather than using the definition for an element called “name” in a different schema.
packet identifier	A unique integer value used to associate elementary streams of a program in a single or multi-program transport stream.
PID	See packet identifier .
playlist	Also known as the “traffic schedule”. A sequential list of automation events to be played back for a station output channel.
program element	A generic term for one of the elementary streams or other data streams that may be included in a program. For example: audio, video, data, etc.
program segment	Portion of a TV program as defined in the traffic format assigned to the program.
PSIP event	A defined period of time on a virtual channel with associated metadata related to a show .
remultiplexer	A packet multiplexer capable of combining MPEG-2 transport stream packets from one or more inputs containing a multiplex of packets into one or more MPEG-2 transport stream outputs.
root	The outermost element in an XML document that contains all other elements.

schedule	The binding of shows to virtual channels at particular times. A schedule is the generic name for “Television Schedule” that consists of multiple audio-video presentations carried on a channel over a period of time.
schema	A database-inspired method for specifying constraints on XML documents using an XML-based language. Since schemas are founded on XML, they are hierarchical, so it is easy to create an unambiguous specification and possible to determine the scope over which definitions and comments are meant to apply.
show	The composition of the primary work and interstitials in a single timeline suitable for broadcast.
show segment	A contiguous subset of a show identified with a single start time and end time pair referenced to the show’s timeline.
tag	A piece of text that describes a unit of data, or element, in XML . The tag is distinguishable as <i>markup</i> , as opposed to data, because it is surrounded by angle brackets (< and >). For example, the element <Channel>My 100</Channel> has the start tag <Channel>, the end tag </Channel>, which enclose the data “100”. To treat such markup syntax as data, an entity reference or a CDATA section is used.
TCP/IP	Transport Control Protocol/Internet Protocol
traffic format	A defined structure that specifies for each traffic system the organization of a primary work and interstitials . A series of traffic formats linked together form a 24 hour broadcast log. Traffic formats are typically linked to a specific program.
traffic system	A management system comprising a database for tracking the sale of advertising, and the scheduling of program elements , advertising, promotional announcements, and other interstitial material.
UTC	Coordinated Universal Time, the basis for the worldwide system of time. Determined using atomic clocks and maintained by the US Naval Observatory and other laboratories around the world. Adjusted occasionally with leap seconds to maintain synchronization with the solar day based on the rotation of the earth.
valid XML	A valid XML document, in addition to being well formed , conforms to all the constraints imposed by a Schema . It does not contain any tags that are not permitted by the schema, and the order of the tags conforms to the schema’s specifications.
value	Used in XML to indicate the number or characters entered for a particular parameter or variable.
virtual channel	The designation, usually a number, that is recognized by the user as the single entity that will provide access to a set of one or more digital elementary streams or an analog TV program. It is called “virtual” because its identification (name and number) may be defined independently from its physical location.
W3C	The World Wide Web Consortium (http://www.w3c.org/). The international body that governs Internet standards.

well-formed	An XML document that is syntactically correct. To determine whether or not a well-formed document is valid, a validating parser and a schema are required.
work	A completed artistic creation, produced or accomplished through the effort, activity or agency of a person or group, comprised of any combination of picture (or video) essence, sound (or audio) essence, and/or data (or auxiliary) essence .
work segment	A contiguous subset of a work ; identified with a single start time and end time pair referenced to the work's timeline; and a defined subset of the elements of the work.
XML	Extensible Markup Language.
XML document	In general, an XML structure in which one or more elements can contain text intermixed with sub-elements.
XML element	A unit of XML data, delimited by tags which can enclose other elements. For example, in the XML structure, “<VirtualChannels><Channel>.. </Channel>><Channel>.. </Channel></VirtualChannels>”, the <VirtualChannels> element contains two <Channel> elements
XML schema	The W3C schema specification for XML documents.

4. TRANSPORT

4.1 Transport Methods

The PMCP protocol may be implemented using two different transport mechanisms, File Based and Connection Based transport, depending on the users' needs. All PMCP-compliant devices shall support both mechanisms as specified in Section 4.2 and 4.3 and both methods may coexist in the same system. By agreement with the providers of all affected devices, system implementers may use other protocols, not specified herein, for communication within a system.

4.2 File Based Transport

File Based transfer will usually be used where large amounts of data needs to be communicated from one system to another without the need for acknowledgement, and where timing is not critical. The user will simply download a file containing the XML document from the originating device and import it into the receiving device. Alternatively, the files may be pushed or pulled to the receiving device in an automatic process.

4.2.1 Common Folders

Receiving devices that implement the file based transport mechanism shall utilize at least one folder where new content is placed. This folder may be on the device itself or elsewhere across any accessible network. The receiving device may automatically detect when new content is available in this folder or may periodically poll the folder for new content.

Separate folders should be used for different receiving devices since the defined file name scheme identifies the message origin but not the intended recipient.

If required there should be other folders for files that will not automatically be processed when moved to a receiving device.

4.2.2 File Name

The originating device shall utilize a common naming scheme for the files so that the receiving device can be set up to identify the files. The file name shall be in the format of:

“PMCPyyyymmdd<Device>nnnnnnnnnn.xml”

where:

“yyyymmdd” is the year, month, and day that the file was sent (using UTC clock)

<Device> is a string of up to 14 letters and digits that identifies the creator of the file uniquely in the system

“nnnnnnnnnn” is a 10-character decimal number including leading zeros

4.3 Connection Based Transport

Connection Based transport of PMCP requires that there be a direct network connection between the sending and receiving devices.

4.3.1 TCP/IP

TCP/IP protocol shall be used for communication. The server default port number shall be 3821¹. Systems and devices shall have the ability of changing this port number to accommodate cases where 3821 is in conflict with something else in the facility.

4.3.2 TCP/IP Connections

Each device using the PMCP protocol that will receive and respond to messages shall act as a server. Each device using the protocol to initiate the sending of messages shall act as a client. Devices that plan to both send and receive messages shall act as both a server and a client.

A TCP/IP connection shall be initiated by a PMCP client to connect to a PMCP server. A server that can also be a client shall be responsible for managing the connection separately from the other client connections. A client shall be allowed to open connections to as many PMCP servers as are available.

4.3.3 Inactive Connections

It is expected that inactive and abnormal TCP connections will be detected and managed by TCP protocols. In addition, PMCP clients shall periodically monitor the status of connected servers and the transport connection by sending either heartbeat requests as defined in Section 5.11, or any other request as defined in Section 5.4.2. Also, PMCP servers shall monitor the status of connected clients and the transport connection by looking for heartbeat requests as defined in Section 5.11, or any other request as defined in Section 5.4.2.

Arrangements for managing connection failures and what to do in each case are left up to implementation by each manufacturer.

1. Port number 3821 is also assigned to PMCP for UDP communications, in case this protocol is used in accordance with Section 4.1.

4.3.4 Unicast

The PMCP protocol shall support only unicast over TCP/IP connections. If multicast functionality is required, it may be implemented by the client opening connections to all devices.

4.3.5 List of Devices to Connect To

Each PMCP device that is configured as a client shall store a list of available PMCP devices (configured as servers) that it will need to communicate with. This list shall contain the IP address or DNS name of the device, the port number, the Device Name, and its Device Type (see Section 5.5). Arrangements for setting up and maintaining this list are left up to implementation by each manufacturer.

4.3.6 List of Devices to Accept Connections From

It is recommended that each device that is configured as a server should keep a list of the IP addresses or DNS names for devices that it will accept connections from. This list may or may not be the same as the list of devices it can connect to. If the list is present, then devices that attempt to connect and are not in the list shall not be allowed a connection. Arrangements for setting up and maintaining this list are left up to implementation by each manufacturer.

4.3.7 Initiation of Servers

When a device that is configured as a server is turned on, it shall begin accepting TCP/IP connections. When a client attempts to connect to the server, the server should reference its list of Devices to Accept Connections From (if present) before deciding to accept the connection.

4.3.8 Sending of Messages

Once a connection is made from a client to a server, only the client may initiate communication. This communication can either be a “push” of information where the client sends data to the server, or a “pull” where the client requests certain information from the server. If there is a need for the server to initiate messages to the client, then a separate TCP/IP connection shall be opened where the client/server roles are reversed.

4.3.9 Encryption

By agreement with the providers of all affected devices, system implementers may use methods of encryption, not specified herein, for secure communication within a system.

4.3.10 Message format

All messages in PMCP shall be sent as XML documents as defined in Section 5.

5. XML SCHEMA DESCRIPTION

5.1 Introduction

The Extensible Markup Language (XML) [1] is a standard that allows structuring of information in a text document so that it is both human and machine-readable. It has a hierarchical structure, it can be easily extended and each piece of information can be labeled. A document compliant to the XML standard is said to be “well-formed”.

The XML Schema standard (XML Schema) [2] defines a way of describing a specific format for an XML document. A schema specifies which elements are allowed in a document, which

elements can be the children of another element, which attributes an element can have, and the data types that an element or an attribute can have. An XML document that complies with a given schema is said to be “valid”.

The PMCP schema defined in Annex A describes the structure of a Programming Metadata Communication Protocol (PMCP) message. It is mostly the transformation of the parameters and data needed to generate the tables defined in the ATSC transport (A/53E [3]) and PSIP (A/65C [4]) standards. Due to the nature of XML, it can be further extended to include other metadata that is not directly related to PSIP.

In the event of any discrepancy between the PMCP schema normatively referenced in Annex A and any other paragraph in this standard, the Annex A schema shall take precedence.

5.2 Namespace

The elements and attributes defined in a schema are referred to as a “markup vocabulary” and are specific to a given schema. It is envisaged that for the majority of users of this XML-based standard PMCP will be the default vocabulary of the XML document, or will unambiguously coexists with other vocabularies where explicit namespace use is unnecessary.

It is possible that there may be applications using PMCP where XML documents may contain markup vocabulary defined by multiple XML schemas. For those rare cases where the use of namespace cannot be avoided, the four lower-case letters “pmcp” shall be used as a namespace prefix to refer to the elements and attributes defined in this standard.

5.2.1 Examples:

1) Private PMCP Information – PMCP is default and WM is explicit.²

```
<PmcpMessage xmlns=http://www.atsc.org/pmcp/2006/3.0
xmlns:wm="http://www.atsc.org/XMLSchemas/pmcp/2006/3.0"...>
...
...
  <PrivatePmcpInformation>
    <wm:Key date="yyyy-mm-dd">
      ...
      <wm:Channel .....>
        ...
      </wm:Channel>
    </wm:Key>
  </PrivatePmcpInformation>
</PmcpMessage>
```

2. Note that the informative example given here is based on PMCP version 3.0.

2) SOAP Example where PMCP message is contained inside another XML SOAP document (namespace is not required)³.

```
<SOAP-ENV:Envelope
  xmlns:SOAP-ENV="http://schemas.xmlsoap.org/soap/envelope/"
  SOAP-ENV:encodingStyle="http://schemas.xmlsoap.org/soap/encoding/">
  <SOAP-ENV:Body>
    <PmcpMessage xmlns="http://www.atsc.org/XMLSchemas/pmc/2006/3.0" id="17365"
      origin="Vendor W, Model X PSIP Generator" dateTime=
        "2009-12-16T09:30:48-05:00" type="reply">
      <PmcpReply id="12345" origin="Vendor Y, Model Z Automation System" dateTime="2009-12-
        16T09:30:47-05:00"status="OK"/>
    </PmcpMessage>
  </SOAP-ENV:Body>
</SOAP-ENV:Envelope>
```

5.3 Naming Conventions

In order to guarantee consistency in the way elements, attributes and values are named the following conventions have been followed in the PMCP schema:

Elements:

- a. Element names do not contain any space, underscore, or hyphen sign.
- b. Acronyms in token names are treated like English words so only the first letter is capitalized. Example: PsipEvent.

Attributes:

- a. All attributes start with a lower case letter.
- b. Any first letter of any word after the first one is capitalized.
- c. Attributes names do not contain any space or underscore.
- d. Acronyms in attribute names follow the same rules applied to English words; e.g., pmtPid.

String Values of Attributes:

- a. String values of attributes may use lower or upper case letters.
- b. Values do not contain spaces.
- c. Multiple word values are separated by an underscore.

5.4 PMCP Messages

Each PMCP message has a root element called “PmcpMessage”. It has a certain number of required attributes that identify the type of the message, its origin, and generation time. Unless otherwise described here, the semantics of all attributes shall be interpreted as described in [3] and [4].

3. Note that the informative example given here is based on PMCP version 3.0.

5.4.1 Message Validity

Each PMCP message shall conform to the PMCP XML schema defined in Annex A. Senders may transmit messages conforming to other schemas, but messages shall not extend the schema of Annex A without formally declaring it as a new schema according to [1]. Receivers may reject malformed messages or messages conforming to a schema other than that defined in Annex A as further described below.

A PCMP message is valid if and only if it is valid with respect to the PMCP schema in Annex A and all constraints specified elsewhere in this standard.

5.4.2 Message Type

A PMCP message is either of type “information” (default), “request”, or “reply”. An information message may be sent to communicate some set of metadata information. A request message may be sent to communicate or request some information. Zero, one or two reply messages may be sent to acknowledge a specific information message. One or two reply messages shall be sent to acknowledge a specific request message. No reply message shall be sent otherwise. A reply message shall contain the “PmcpReply” element. No “PmcpReply” element shall be present in an information or request message.

A system heartbeat request message is sent using the root PmcpMessage alone. All other information, request, and reply messages comprise the root element and one or more child elements, and their attributes, as defined in the schema.

5.5 Device Identification

5.5.1 Device Name

Each device utilizing PMCP shall have a unique, alphanumeric Device Name. This name shall be unique within the facility (but not necessarily globally). The definition of the device name is left up to implementation by each manufacturer, and it is expected that this will be part of a device’s initial setup. The device name is encoded as the value of the origin and destination attributes of the PmcpMessage element.

5.5.2 Device Type

The Device Type shall be included in all messages sent from the device, and may aid receiving devices in determining message priority and applicability. Table 5.1 identifies the currently defined device types. Other device types may be defined by other standards or other SDOs, but shall be recorded in the ATSC Code Point Registry (<http://www.atsc.org/standards/cpr.html>). The device types are expected to be relatively broad in scope, and it is possible that multiple devices within a facility will be of the same device type. The device type is encoded as the value of the originType attribute of the PmcpMessage element.

Table 5.1 PMCP Device Types

Automation
Conditional_Access
MPEG_Control
Program_Management
Table_Generator
Traffic
Listing_Service
Metadata_Extractor
Table_Extractor
Data_Server
Transcoder
Content_Distribution
Asset_Management

5.6 Message Identification

Every message sent via PMCP shall have a Message ID number and Date/Time stamp so that the individual messages can be acknowledged. In addition, it shall include the Device Name and Device Type of the originating device so that the receiving device can identify the sender and take appropriate actions. This information shall be transmitted as part of the XML.

5.6.1 Message ID

The Message ID shall be a sequential number assigned by the originating device. Message ID numbering arrangements are left up to implementation by each manufacturer but shall be in accordance with the PMCP schema.

5.6.2 Time and Date Stamp

The timestamp shall indicate the time and date that the message was sent. The time and date shall be presented in standard XML schema dateTime format, including the offset from UTC (see Section 5.10).

5.7 Acknowledgement

The sending device shall have the option of asking for an acknowledgment for each message sent. The “PmcpReply” element is used for this and has a required “status” attribute that shall have one of the values “valid”, “invalid”, “OK”, or “error”. It is envisioned that the request for acknowledgements will be used primarily in the connection based protocol, although it could be implemented with files if so desired.

5.7.1 Valid

Except as indicated below, a reply message with status “valid” shall be generated by the receiving device upon receipt of a properly formatted message containing a request for acknowledgement. This acknowledgement shall serve to let the sending device know that the message has been received and that it appears to be valid with regard to this schema. It will not, however, indicate that action has been taken on the message. When the reply message responds with “valid”, then a second reply (with “OK” or “error” status) shall be sent later to indicate the final processing status. If the “OK” or “error” message is generated in time to satisfy the “first acknowledgement” timeout criteria in Section 5.7.5, then the prior “valid” reply is not required.

5.7.2 Invalid

A reply message with status “invalid” shall be generated when the message has been received but does not comply with the schema described in this document and cannot be processed.

5.7.3 OK

When the receiving device has finished acting on a message containing a request for acknowledgement, it shall send a reply message with status “OK”. This acknowledgement shall indicate that the action has been completed successfully.

5.7.4 Error

If the action was not completed correctly, a reply message with status “error” shall be returned to the sending device along with a description of why the action could not be completed.

5.7.5 Acknowledgement Timeout

The timeout period during which a first acknowledgment message should be received shall be configurable per connection, with a default value of 100 ms. If no response at all has been received by the sending device in this time period, it may consider the message lost and initiate a resend.

Since it is impossible to determine how long each and every action resulting from a request message will take, there is no timeout period for reply messages with status “OK” or “error” that are sent following a “valid” reply message. Therefore, it is up to the sending device to determine the proper amount of time to wait after sending the request message before deciding that the message was not acted upon.

5.7.6 Multiple Requests

It is recommended that the sending device should not simply take a single lack of response to indicate a failed device or connection, but instead poll the device again to verify that there is no response.

The number of retries on the client side and the maximum time allowed between requests on both the client and the server sides shall be configurable per connection to address a wide variety of network configurations.

Further arrangements for managing lost messages, “error” and “invalid” messages, and any resulting alarms and actions are left up to implementation by each manufacturer.

5.8 PmcpMessage Action Attributes

Many elements in a PmcpMessage may have an “action” attribute. The allowed values are “read”, “add”, “update” and “remove”. Only a request message may contain “action” attributes with the value “read”. A reply message shall not contain any “action” attribute.

- If an element has no “action” attribute, it is being sent for context and the receiver reads only the attributes necessary to uniquely identify the element. This element’s children may have an “action” attribute with any value.
- If an element has an “action” attribute with the value “read”, a reply message shall be sent in return, and it shall contain the current attributes and children for this element. The receiver of the request message should ignore all children elements and all attributes that are not necessary for unique identification.

- If an element has an “action” attribute with the value “add”, the whole element, including its children, may be added to the current environment of the receiver. If a child of such an element has an “action” attribute, its value shall be “add”. If there was already an element with the same ID, it and its children should be replaced.
- If there is an “action” attribute with the value “update”, all current attributes may be updated with the given values in the receiver environment. Each child element may have its own independent “action” attribute.
- If an element has an “action” attribute with the value “remove”, the referenced element may be deleted from the receiver environment of the receiving device. Only the attributes required for unique identification should be interpreted by the receiver. All children elements and all other attributes should be ignored.

5.9 PmcpMessage Children

Figure 5.1 (see page 20) shows the highest-level children of a PMCP message.

In this diagram, the dotted lines surrounding a child element mean that this element is optional and may not be present. The “0..∞” symbol means that the element may be present an infinite number of times.

Other child elements are defined in the schema as children of the elements shown above. These carry specific metadata related to the parent element, they also may have children, and so on in a hierarchical fashion.

Unless stated in the next sections, an element is uniquely referenced by its required attribute. No two elements sharing the same reference shall be present in a PMCP message.

5.9.1 PmcpReply

The “Reply” element is a special case message used in various ways as described in Section 5.7.

5.9.2 Transport Stream

A “TransportStream” element carries the information about a transport stream that is managed by the system. It carries only the information that applies to the whole transport stream and not to a specific channel.

A Transport Stream is uniquely referenced by its tsid and network attributes. In a system where TSIDs are unique, such as US terrestrial DTV, the network attribute may be omitted, otherwise it is required.

5.9.3 Channel

A “Channel” element carries the information about an ATSC “virtual channel” (see A/65C [4], Section 6.3 on the VCT). All the information found at this level is currently valid for the channel and supersedes whatever information is associated with the current PSIP event (see A/65C [4], Section 6.5 on the EIT, and Section 5.9.5.1).

The tsid and network attributes of the transport stream that carries the channel shall be present if necessary to uniquely define the referenced channel. A channel is referenced by either its channelNumber or sourceId attribute, and one of these attributes shall always be present. ChannelNumber shall be the default method of identification, but devices intended for use in a station environment shall support both methods of identification. By agreement with the providers

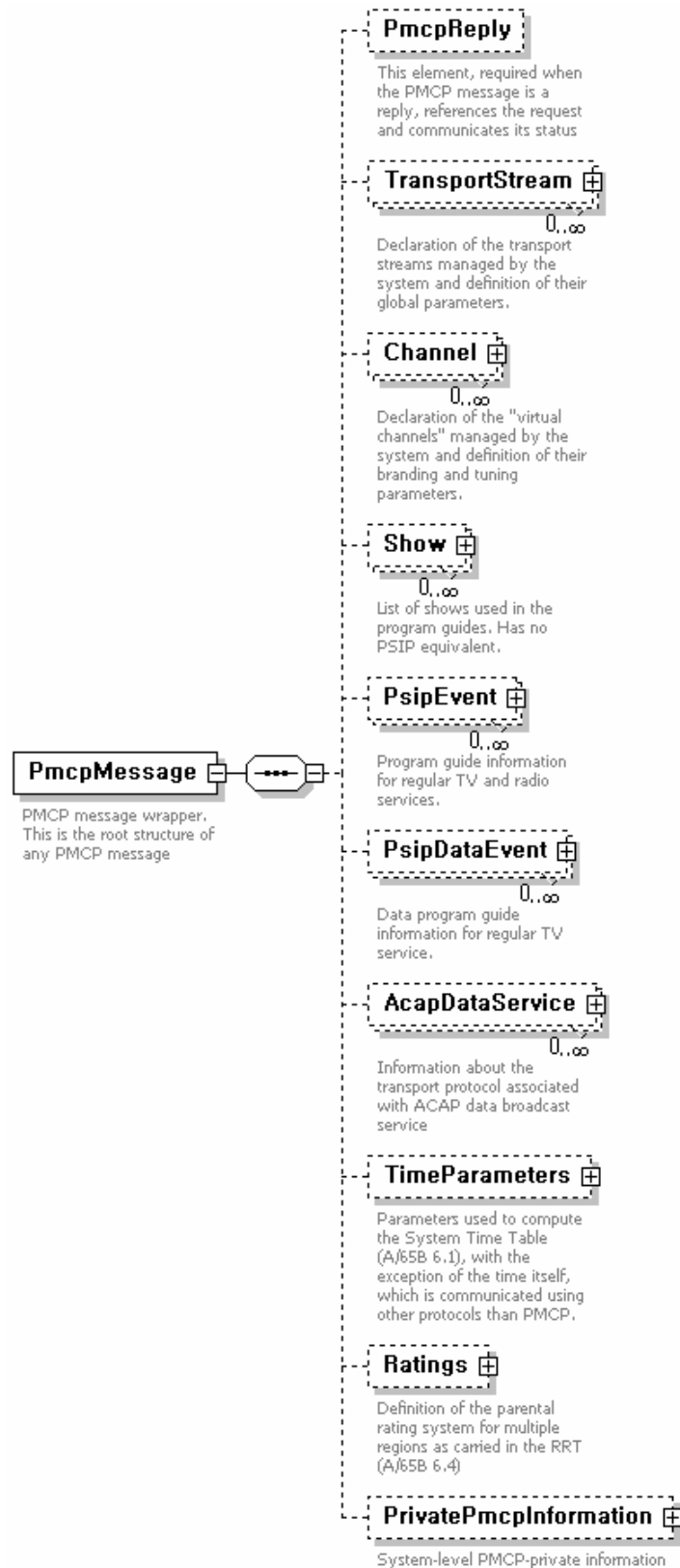

Figure 5.1 PMCP message diagram.

of all affected devices, system implementers may choose to implement sourceID for channel identification between devices in a closed system environment such as an individual station.

5.9.4 Show

The “Show” element may be used to communicate metadata about a show independently of when it is scheduled. Both the “contentId” and “ShowData” elements are required. The “contentId” element shall contain the show label for one or more numbering schemes and should uniquely reference a show.

Where PMCP system implementers choose to use the HouseNumber or AlternateId identifiers for contentId, they should ensure that the scheme used provides unique identification for the show for as long as the show is persistent in any part of the system that may receive PMCP messages relying on those identifiers. In the event that duplication of the contentId occurs, it must be accepted that any updated show data will be applied to more than one show with the same identifier.

5.9.4.1 ISAN

The ISAN numbering scheme used for the ContentIDType/Isan element is defined in ISO 15706-2 [6]. The attributes for the IsanType shall comply with the constraints defined in [6].

5.9.5 PsipEvent

The “PsipEvent” element is the main structure used to communicate both current and future electronic program guide (EPG) information. It shall always have an “EventId” element, used to label or reference the event. The channel used to carry the PSIP Event is referenced through a mandatory “channelNumber” attribute. Optional “tsid” and “network” attributes may be used to further specify the channel when the channel number is not unique in the system. The “Current” element may be used to reference the current event of the channel when no other reference is known. The “Default” element references a default PSIP event, used by the PSIP Generator to fill in the empty time slots of the channel. All other PSIP events shall be referenced using at least one of the following elements:

- PmcpEventId is the preferred referencing method and consists of the event creator device name combined with a unique sequential number assigned by this creator.
- InitialSchedule may be used either to assign the start time initially scheduled by the creator or to reference an event by its initial start time when the PmcpEventId is not known. The initially scheduled start time shall not be modified during the existence of a PSIP event. Adjustments to the actual start time shall be done through the “startTime” attribute of the “PsipEvent” element.
- PsipEventId may be used to reference an event by its PSIP event_id, as carried in the EIT. This value is assigned by the PSIP Generator. It is therefore not known before the event has been scheduled in the PSIP Generator.

5.9.5.1 Precedence for PSIP Event Metadata

The order of precedence for the receiving device with respect to default, current, and regular PSIP events shall be:

- The current parameters associated with the channel, where available, supersede channel information that was otherwise set with PSIP event metadata for the current event.

- Regular and current PSIP events are normally used to communicate schedule information.
- The default PSIP event is used whenever no other information is available about a particular schedule time slot.

The information about an event may be communicated in two non-exclusive ways:

- The PSIP event may be linked to a show defined either previously or in the same PMCP message through a “contentId” element.
- The PSIP event may contain its own “ShowData” element.

When the same type of information is provided through both mechanisms in the same message, the information coming from the “ShowData” element shall take precedence.

Multiple events may be linked to the same show. This provides an efficient way of using the same metadata for multiple events.

5.9.6 PSIP Data Events

PsipDataEventType is similar to PsipEventType in terms of schema structure. The PsipDataEvent element enables the PMCP schema to be extended for ACAP announcement (see Figure 5.2.) . There are four differences between PsipDataEventType and PsipEventType.

- First, PsipDataEventType substitutes a “DataId” element instead of an “EventId”, used to label or reference the event related to data.
- Second, PsipDataEventType contains a new acapContentId element that is substituted for contentId because data contents are created and managed separately from AV content.
- Third, PsipDataEventType substitutes a “DetPrivateInformation” element and a “DetDescriptor” element instead of an “EitPrivateInformation” element and an “EitDescriptor” element, needed for generating PSIP DET [A/90].
- Fourth, it adds the dataBroadcast element that is used to identify data broadcast services in the ATSC framework. This element is used to from the data broadcast descriptor which identifies the type of the data component and may be used to provide a text description of the data component.
- Fifth, PsipDataEventType includes only the “Name” element and “Description” element among the children of “ShowData” element because Data Event Table don’t have to carry the information related to the parental rating, audio service, caption service and redistribution control as Event Information Table. The “Name” element describes the data event title and the “Description” element represents the detailed description of a data event.

The PsipDataEvent shall be optional and when present shall be placed as shown in the XML schema (If there is any conflict between this requirement and the XML schema attached, the schema shall take precedence.).

5.9.7 ACAP Service

ATSC has standardized a software layer to enable support for common applications to provide advanced interactive services. The middleware is defined in ATSC Standard A/101 (2005), “Advanced Common Application Platform”. This standard (A/101) also defines how to arrange and transmit the data elements that make up a ACAP data service. The schema “acapservice” provides for the signaling of the data structures to support an ACAP service.

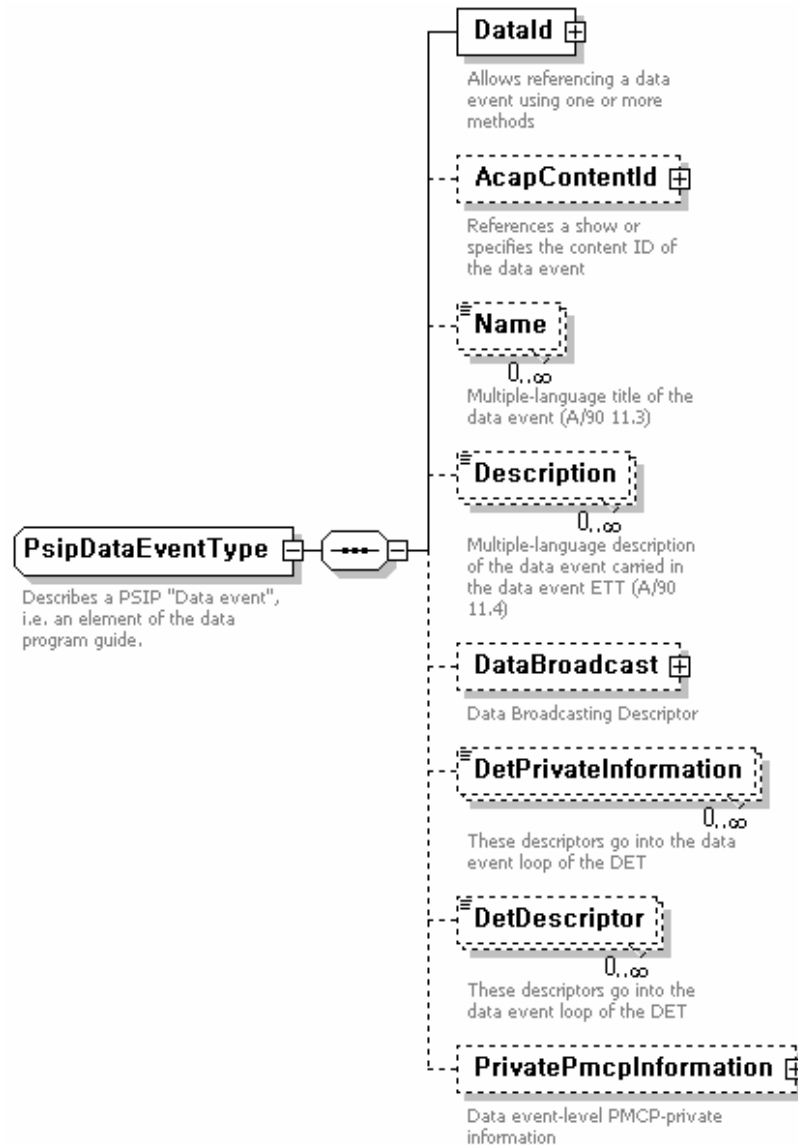

Figure 5.2 PSIP Data Event type diagram.

5.9.8 PrivatePmcpInformation

The PrivatePmcpInformation element is the mechanism used to carry private elements and attributes in a PCMP message. The following constraints apply:

- Elements not defined in the PMCP schema (Private PCMP Elements) are prohibited except when enclosed by the PrivatePmcpInformation element.
- Attributes not defined in the PMCP schema are prohibited except when in Private PMCP Elements.
- All private elements and attributes shall use an XML namespace prefix.

5.9.9 Other Children

The PmcPMessage children – TimeParameters and Ratings – carry the values for the various parameters in the PSIP System Time Table (STT) and Regional Rating Table (RRT) and map to those tables. Rating dimensions and values are encoded in their string forms. For Region 1 (U.S.), the strings of CEA 766 shall be used verbatim when encoding the content advisory descriptor using the Rating element attributes, dimension and value. When encoding an RRT element in PMCP, in order to ensure predictable mapping of rating strings to their numeric assignments by the PMCP decoder, the Dimension and Value elements of the Region element shall be encoded in their numeric order. Further, the PMCP decoder shall assign numeric values starting with zero and sequentially incrementing by one. The Region element shall contain the entire set of dimensions and values for the region—a partial update is not possible. Therefore, the total number of dimensions and their values in the RRT shall be determined from the total number of the respective Dimension and Value elements present in the PMCP Message.

5.9.10 Multiple String Structure Support

Various fields in PSIP are “Multiple String Structures” (see A/65C, Section 6.10). The corresponding elements in PMCP are derived from TextType. These derived elements are intended to be repeated for each language string. So, when multiple such elements are encountered sequentially in the XML document, they are not replacement or alternative strings, but as a group form the Multiple String Structure.

5.10 PMCP Time Messages

All PMCP time fields defined in the PMCP Schema follow the standard XML date/time format and, using the timezone offset syntax, can refer to any time zone (see <http://www.w3.org/TR/xmlschema-2/#datetime>). Based on the techniques described in Annex C, PMCP time will be ultimately referenced to UTC. The PSIP Event has additional optional start frame time and duration frame attributes to allow times for Events to be specified with frame accuracy where this is required.

5.11 Heartbeat

In a connection-based implementation, each PMCP client shall poll each PMCP server that it is connected to with a heartbeat request and shall look for a heartbeat reply message back.

Each PMCP server shall monitor each connected PMCP client by looking for periodic heartbeat request messages.

5.11.1 Heartbeat Messages

The heartbeat request shall be sent using the root PmcPMessage alone as indicated in Section 5.4.2. This message shall include the sending device’s type and identification, and shall have a “type” attribute with the value “request”.

The heartbeat reply is the acknowledgement of the heartbeat request, as defined in Section 5.7, normally with status attribute “OK”.

Examples of such messages are given in Annex B.

5.11.2 Heartbeat Timing

On the client side, the interval between heartbeat request messages shall be configurable per connection. Its minimum value shall be less than or equal to one second. Its maximum value shall be greater than or equal to one minute. In the event that any other message with an acknowledgement request is sent by the client within the same period, this may take the place of the heartbeat request.

The timeout period that the client shall use for the acknowledgement response is defined in Section 5.7.5. The client shall ensure that the heartbeat request interval is always greater than this timeout.

5.11.3 Server Heartbeat Timeout

The server heartbeat timeout is defined as the maximum duration that the server waits between two heartbeat request messages before deciding that a message has been lost. It shall be configurable per connection. Its minimum value shall be less than or equal to one second. Its maximum value shall be greater than or equal to one minute.

It is recommended that the server should not simply take a single lost heartbeat request to indicate a failed device or connection, but instead wait for subsequent messages to verify if they are also lost. The number of heartbeat periods to wait before considering the connection lost shall be configurable per connection. In order to prevent false communication failure alarms, while detecting communication failures in a timely fashion, the server time out period and number of periods to wait should be adjusted during system set up based on the heartbeat message period set for the client.

5.11.4 Failed Device

If a device does not respond to repeated polling messages, the sending device should assume that the device is no longer in service and should address the backup device if one exists.

Further arrangements for managing heartbeat messages and any resulting alarms and actions are left up to implementation by each manufacturer.

5.12 Message Priority and Conflict Management

In many cases, it is foreseeable that a given device could receive multiple, potentially conflicting, pieces of information from different sources. How these conflicts are handled is left up to implementation by each manufacturer. Possible methods include “Last Message” mode where the last message sent (based on the message send time) is used, or a more intelligent approach where the receiving device takes into account the sender’s name and device type and the amount of time before air. It is expected that certain devices will have more relevant or more reliable information depending on how close to broadcast time it is for the related PSIP event. In these cases, having a message send time, and device name and type to identify the sending device will aid the receiving device in making a decision on how best to handle the messages.

It is recommended that the PSIP table generator and other systems’ validity rules should be configurable based on input from a user interface or configuration control system, as may be necessary for network and station operational changes.

A/76B, Annex A: PMCP Schema (Normative)

The schema that shall be used is found in the file PPMCP31.zip, which is available from the ATSC Web site using the following link:

<http://www.atsc.org/XMLSchemas/pmcp/2007/3.1>

Note that the file PPMCP31.zip is 24 kB in size and contains 15 individual files, as detailed in Table A1.

Table A1 Contents of “PPMCP31.zip”

File Name	Size (uncompressed)
acapservice.xsd	58 kB
audios.xsd	7 kB
captions.xsd	4 kB
channel.xsd	12 kB
contentid.xsd	3 kB
databroadcast.xsd	4 kB
elementarystream.xsd	10 kB
essencemetadata.xsd	4 kB
event.xsd	17 kB
isan.xsd	3 kB
pmcp31.xsd	8 kB
pmcptype.xsd	10 kB
regionrating.xsd	6 kB
timeparameters.xsd	3 kB
transportstream.xsd	7 kB

A/76B, Annex B: PMCP Use Cases (Informative)

Sample PMCP XML documents have been developed to illustrate the use of some of the PMCP messages. Links to these documents, available from the ATSC Web site, are embedded in the icons below⁴. The following informative examples are provided:

- HeartbeatRequest.xml
- HeartbeatReply.xml
- ErrorMessage.xml
- ScheduleDownload.xml
- ScheduleRead.xml
- DurationChange.xml
- EventNameChange.xml
- ShowNameChange.xml
- EventShift.xml
- Captions.xml
- AudioInformationStart.xml
- AudioInformationNext.xml
- AudioInformationStop.xml
- PrivateInformation.xml
- ACAP_Channel_Add
- ACAP_PsipDataEvent_Add.xml
- ACAP_PsipEvent_Add.xml
- ACAP_DataService_Add.xml
- Kcrg_psip_pmcp_5421_326

HeartbeatRequest.xml



HeartbeatRequest.xml

HeartbeatReply.xml



HeartbeatReply.xml

ErrorMessage.xml



ErrorMessage.xml

ScheduleDownload.xml



ScheduleDownload.xml

4. Note that the informative examples given in this Annex are based upon PMCP version 3.0.

ScheduleRead.xml

ScheduleRead.xml

DurationChange.xml

DurationChange.xml

EventNameChange.xml

EventNameChange.xml

ShowNameChange.xml

ShowNameChange.xml

EventShift.xml

EventShift.xml

Captions.xml

Captions.xml

AudioInformationStart.xml

AudioInformationStart.xml

AudioInformationNext.xml

AudioInformationNext.xml

AudioInformationStop.xml

AudioInformationStop.xml

PrivateInformation.xml

PrivateInformation.xml

ACAP_Channel_Add.xml

1_ ACAP_Channel_Add.xml

ACAP_PsipDataEvent_Add

2_1_ ACAP_PsipDataEvent_Add.xml

ACAP_PsipEvent_Add.xml

2_2_ ACAP_PsipEvent_Add.xml

ACAP_DataService_Add.xml

3_ ACAP_DataService_Add.xml

USRatingTable.xml

USRatingTable.xml

USCanadaRatingTable.xml

USCanadaRatingTable.xml

Kcrg_psis_pmcp_5421_326 (part of a program schedule with details)



kcrg_psis_pmcp_5421_326.xml

A/76B, Annex C: PSIP Metadata System Architecture (Informative)

C1. SYSTEM COMPONENTS

Figure C1 shows a generic digital television system related to the production of PSIP, with interconnections showing various categories of metadata/data. Note that the blocks relate to the functions of the different devices and subsystems involved and do not necessarily indicate specific items of equipment. The level of implementation of these functional blocks will vary from station to station and in some cases may be absent or only partially implemented.

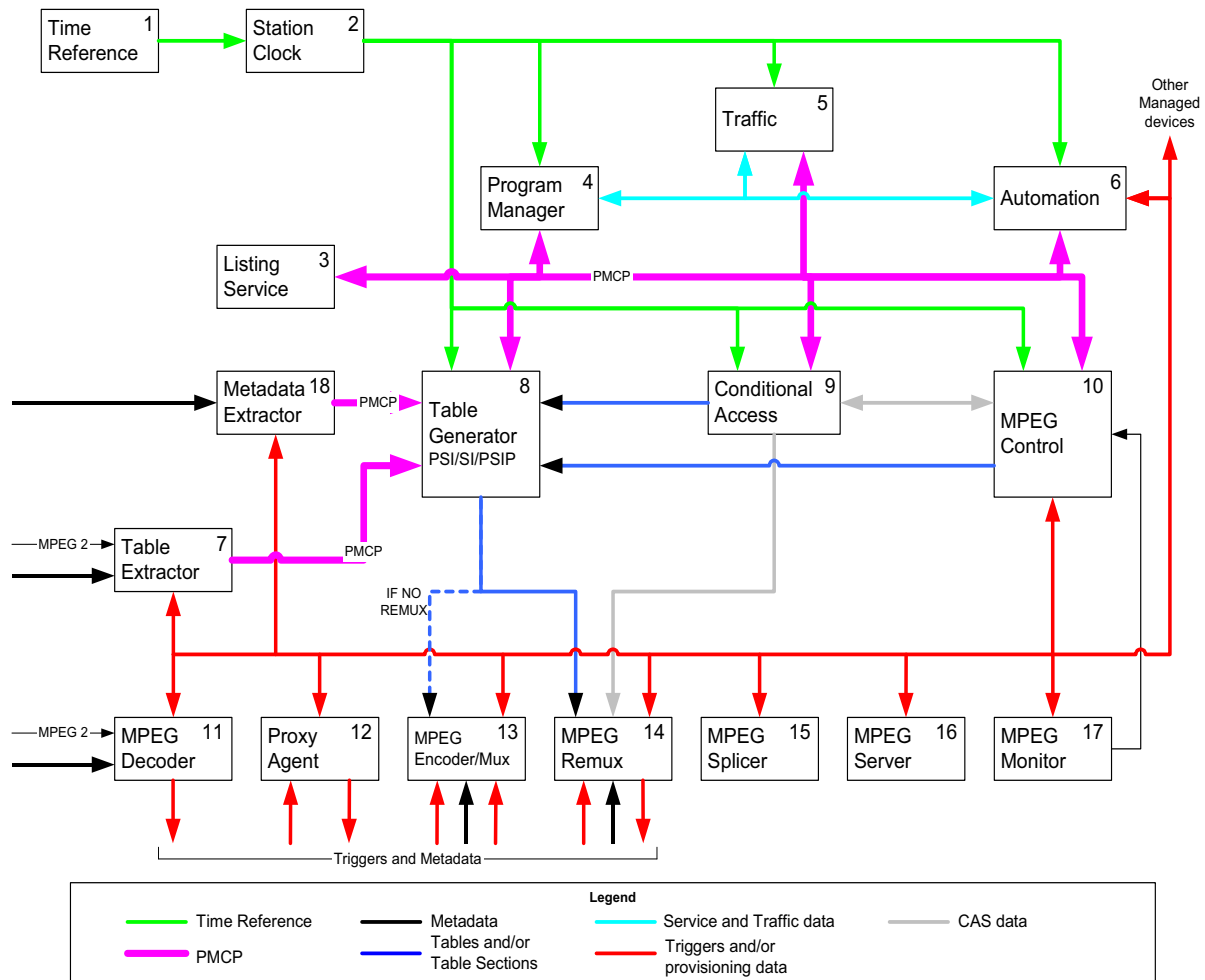

Figure C1 PSIP metadata system.

The blocks in Figure C1 have the following functions:

1	Time Reference	A source of accurate time signals, usually referenced directly or indirectly to UTC.
2	Station Clock	A device that generates and/or distributes time signals to devices and systems within the station. May include a highly stable internal clock that is updated on a regular basis from an external standard reference such as GPS or the US Naval Observatory. Typically provides local time at the station, referenced to UTC. Outputs SMPTE time code and/or NTP (network time protocol) and/or proprietary time clock signals. May be combined with a video sync generator.
3	Listing Service	A third-party service using a database where program information is collected and compiled into programming data, for delivery to broadcasters and to other media for program guide publication.
4	Program Manager	A management and planning system, including a database of program elements, used to produce the broadcast schedule to be carried over one or more channels.
5	Traffic	A management system comprising a database for tracking the sale of advertising and the scheduling of advertising, promotional announcements, program elements, and other interstitial material.
6	Automation System	A management and control system comprising a database of schedule information used for triggering multiple devices with precision timing, for frame or near frame accurate operation of a broadcast system.
7	Table Extractor	A bridge device that monitors a transport stream for the presence of PIDs carrying tables, and parses the table data for use by other devices.
8	Table Generator	Also referred to as the PSIP Generator. A server device that creates defined system information table structures, including PSIP, associated with a multiplex of programs, that are inserted into a transport stream for play out in the multiplex.
9	Conditional Access	A component or collection of components used for encrypting a PID, a program event, a channel or collection of channels, or any combination of the above, in order to restrict access to the material to certain authorized groups of users only.
10	MPEG Control	A manager, control system, or set of controls used to manipulate the configuration and operation of any of the components of an MPEG system. May control device parameters directly or enable, modify or delete profiles used to operate the equipment, and manage redundancy and log errors.
11	MPEG Decoder	A device that transforms a compressed MPEG-encoded bitstream into an analog or uncompressed digital video or audio signal.

12	Proxy Agent	<p>1) A device (usually a computer) that bridges between two protocols so that incompatible interface messages can be passed from one domain to another.</p> <p>2) A device used for protocol translations for extending signal reach beyond network limitations.</p>
13	MPEG Encoder	A transformation device used to convert a video, audio or raw data signal into a compressed bitstream of packetized data (packetized elementary stream or PES) carried as a multiplex of PIDs over a transport stream in real time.
14	MPEG Remultiplexer	A device capable in real time of disassembling and re-assembling packet streams from one or more MPEG-2 transport stream inputs into one or more transport stream outputs containing a multiplex of packets.
15	MPEG Splicer	A real time device that allows switching between compressed bitstreams, providing seamless or near-seamless program transitions triggered from commands either in the transport stream or from an external control system.
16	MPEG Server	A disk-based storage device that stores content in the MPEG domain.
17	MPEG Monitor	A device that monitors the attributes of a compressed bitstream and that may log and report out-of-limit parameters and occurrences.
18	Metadata Extractor	A device that extracts metadata transported with an associated video or audio signal and forwards it for use by other devices

C2. PMCP DATA FLOW

Programming metadata flow between devices and systems will vary depending on the requirements of the broadcaster, the number and type of program and traffic support services used, and the degree of automation implemented. Arrangements are described in the following sections for one possible flow of information using PMCP. Not all broadcasters will implement all functions mentioned. Time periods mentioned for metadata transfer may change in the future since it is possible that the use of PMCP and other new technological advances will change operational practices.

C2.1 Program Planning and Listing Service

Long-term program planning and scheduling may take place in the Program Manager (4). This system may take input from station staff and also from the network that the station belongs to (if any). A draft television schedule, usually covering many weeks or months for the television station output channel(s), is typically sent monthly using PMCP to the Listing Service (3) and to Traffic (5) (updates may be sent more frequently). The listing service may add detailed information about the particular shows, including actual durations, titles and content details, and then may send a revised schedule back to the station using PMCP. The Listing Service may also distribute program schedules to other news media for publication. For schedules sent to the station, a 16-day rolling schedule may be used, with daily or more frequent downloads.

C2.2 Traffic, PSIP Generator, and Automation

At the station the schedule with program information may be received by Traffic and the PSIP Table Generator (8), and may also be fed back to program management. The PSIP Generator may use the information from the Listing Service to populate much of the PSIP table information. Meanwhile Traffic establishes the detailed daily schedule and on-air playlist, taking account of network and local programming, advertisements, promotional and other interstitial material. One or more Alternate Schedules may also be created to cater for different operational scenarios, live program over-runs, emergencies, etc. The detailed playlist, typically covering one day (often more at weekends and holidays) is distributed from Traffic to Automation (6), usually one to three days before the airdate, and an associated schedule with PSIP events is sent from Traffic to the PSIP Generator using PMCP.

Once control of the schedule has been handed over to Automation, any changes to the schedule may be communicated from Automation to the PSIP Generator using PMCP. It should be noted that the Traffic and Automation system databases may not hold all the detailed show content information downloaded from the listing service to the PSIP generator, so updates about the schedule sent from Traffic or Automation to the PSIP Generator may update PSIP event times, durations and other information, while leaving other show details already entered into the PSIP tables intact.

C2.3 Other Sources of PSIP Information

Where the Network generates PSIP information for network programs, this can be distributed to the station along with a program in an MPEG bitstream. The metadata may be extracted using the Table Extractor (7) and fed to the PSIP generator using PMCP.

Some PSIP information associated with a show (e.g., caption service information, parental advisory, AC-3 audio, broadcast flag) can be carried in data packets inserted into the baseband video or audio streams. This metadata may be extracted using the Metadata Extractor (18) and fed to the PSIP generator using PMCP to update the appropriate current channel parameters.

Some PSIP information can be generated by particular hardware associated with the MPEG encoding and distribution process, and may not be known to upstream planning systems, or may over-ride previously entered values (e.g., audio stereo or surround sound mode). This metadata may be sent by MPEG Control (10) and fed to the PSIP Generator using PMCP to update the appropriate current channel parameters.

C2.4 Last-Minute Schedule Changes

Automation controls the on-air program switching of the station output in real-time. If last-minute changes to the schedule are required, this may take place in Traffic, in which case a new play list is produced and equivalent schedule updates are sent to the PSIP Generator. If the schedule changes are made in Automation, with manual intervention from the master control operator, then Automation may send updates for particular events to the PSIP Generator using PMCP.

If a decision is taken to switch to an alternate schedule, then new schedule information is sent to the PSIP Generator. This could be in the form of updates from automation, or as a new schedule download from traffic to the PSIP generator.

C3. STATION TIMING

An accurate time reference is required for a station to broadcast programs to a published schedule, synchronized with program contributions from a network or other sources, and including accurate PSIP time information. Use of the following techniques will help ensure that automation control and on-air switching can be carried out with frame accuracy, and that PSIP time accuracy will meet the ± 1 second requirement of A/65C.

C3.1 Time Reference

The automation system and any other time-sensitive systems and equipment affecting on-air operations should be locked to a feed of SMPTE time code or other timing signal from a station master clock system. The PSIP table generator and other computer-based systems should be locked to the station master clock or to a source of the same standard time distributed through the local area network. Depending on broadcast operational requirements, the time used by the station may be local time or UTC (sometimes informally referred to as GMT—Greenwich Mean Time, now an obsolete term).

The accuracy of the station clock should be maintained with a standard external reference. Several methods exist including radio broadcast signals, telephone dial-up, Internet access, and GPS. Whichever way the time signal is received, to maintain a uniform time system the ultimate time reference should be a national laboratory source of UTC (in the US this is the US Naval Observatory in Washington DC).

Systems and equipment external to the station that send signals and information affecting current operations in real time should also be referenced directly or indirectly to UTC.

Systems such as the traffic system, program management system, and program listing service typically process program schedule and timing information in non-real-time and off-line from the on-air broadcast chain. It is noted that timing reference accuracy for these systems may therefore be less stringent than for on-air devices. However, if such systems may on occasions be required to send PSIP information or other metadata for current on-air program events, then they should use the same ultimate timing reference and have the same timing accuracy as the PSIP generator.

C3.2 GPS Time

GPS time is defined as the number of seconds elapsed since 0000 Universal Time on January 6, 1980. It is offset from UTC by an integer number of seconds (currently 13) due to leap seconds added to UTC but not to GPS time. The time offset is distributed with the GPS signal, so any station clock or other device that is referenced to GPS is locked to UTC and is aware of actual UTC time.

C4. ASSUMPTIONS

The following assumptions apply to equipment and systems designed for use with PMCP:

- a) Metadata for a given program element in the transport stream may arrive at multiple locations and multiple times.
- b) The actual broadcast time, duration and/or content of a PSIP event may change and the associated metadata may need to be updated.
- c) When a change occurs in the transport stream it is acceptable that updates to affected system information and PSIP tables may miss the first instance of transmission of the table after the

transport stream change occurs. Therefore equipment that makes a change in one or more characteristics of the transport stream may report the changes to other affected equipment immediately after the change is made. This does not preclude advance notice for tables that send advance information.

- d) Automation, Traffic, and some other systems may handle program segments at a more detailed level than used for PSIP events. Only information about the primary automation event that coincides with the start of the PSIP event (as determined by station policy) will be communicated from these systems to other equipment and systems as the PSIP event. Primary and secondary automation events at other times may affect the configuration of the transmitted bitstream and such information may be communicated as channel information updates at any time.

A/76B, Annex D: PMCP with Data Broadcasting for ACAP (Informative)

D1. SYSTEM COMPONENTS

Figure D1 shows a generic digital television system related to the production of PSIP, with interconnections showing various categories of metadata and the addition of a data server. Note that the blocks relate to the functions of the different devices and subsystems involved and do not necessarily indicate specific items of equipment. The level of implementation of these functional blocks will vary from station to station and in some cases may be absent or only partially implemented.

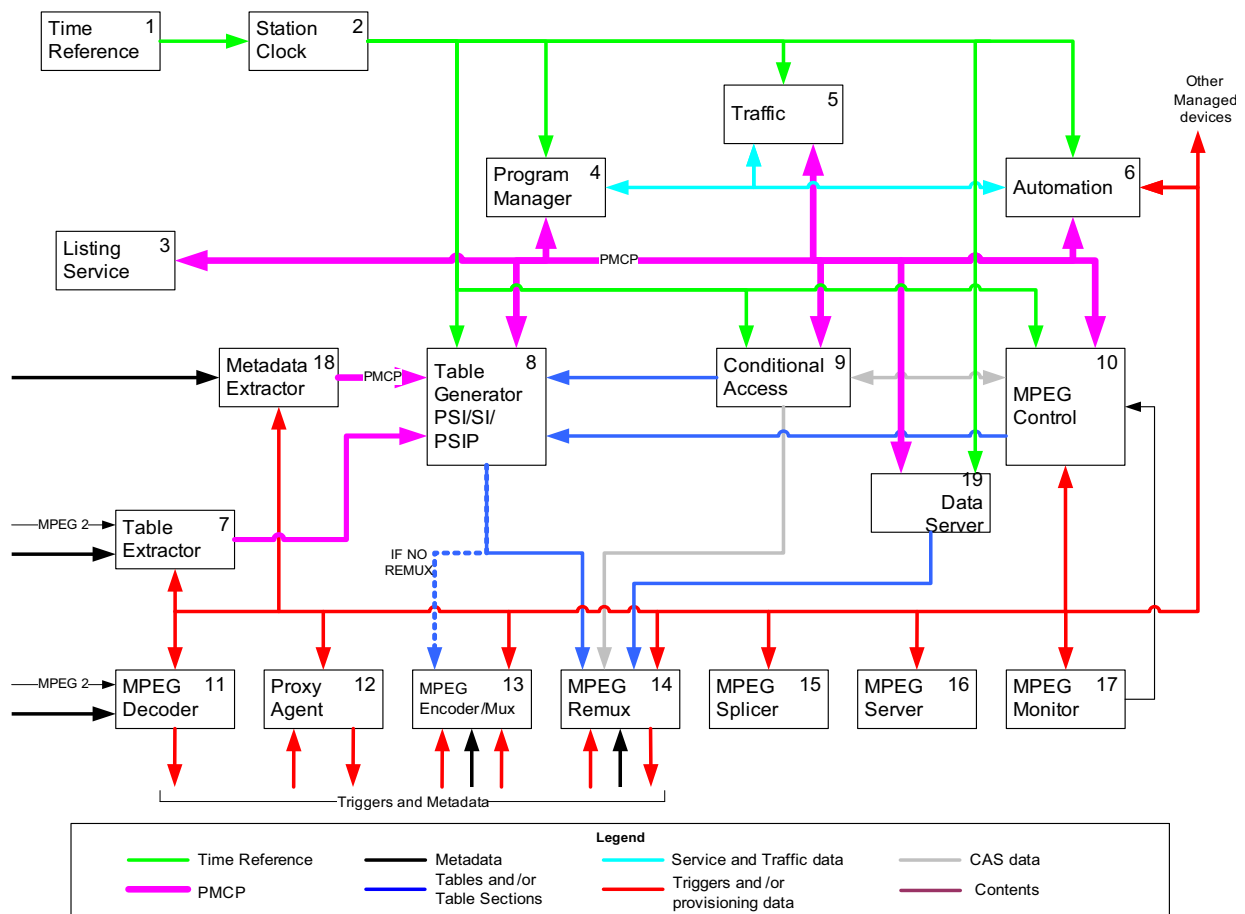

Figure D1 PSIP metadata system with ACAP.

The blocks in Figure D1 have the following functions (numbers 1 through 18) are the same as in Figure C1 and repeated here for convenience, with the addition of the description of the new block:

1	Time Reference	A source of accurate time signals, usually referenced directly or indirectly to UTC.
2	Station Clock	A device that generates and/or distributes time signals to devices and systems within the station. May include a highly stable internal clock that is updated on a regular basis from an external standard reference such as GPS or the US Naval Observatory. Typically provides local time at the station, referenced to UTC. Outputs SMPTE time code and/or NTP (network time protocol) and/or proprietary time clock signals. May be combined with a video sync generator.
3	Listing Service	A third-party service using a database where program information is collected and compiled into programming data, for delivery to broadcasters and to other media for program guide publication.
4	Program Manager	A management and planning system, including a database of program elements, used to produce the broadcast schedule to be carried over one or more channels.
5	Traffic	A management system comprising a database for tracking the sale of advertising and the scheduling of advertising, promotional announcements, program elements, and other interstitial material.
6	Automation System	A management and control system comprising a database of schedule information used for triggering multiple devices with precision timing, for frame or near frame accurate operation of a broadcast system.
7	Table Extractor	A bridge device that monitors a transport stream for the presence of PIDs carrying tables, and parses the table data for use by other devices.
8	Table Generator	Also referred to as the PSIP Generator. A server device that creates defined system information table structures, including PSIP, associated with a multiplex of programs, that are inserted into a transport stream for play out in the multiplex.
9	Conditional Access	A component or collection of components used for encrypting a PID, a program event, a channel or collection of channels, or any combination of the above, in order to restrict access to the material to certain authorized groups of users only.
10	MPEG Control	A manager, control system, or set of controls used to manipulate the configuration and operation of any of the components of an MPEG system. May control device parameters directly or enable, modify or delete profiles used to operate the equipment, and manage redundancy and log errors.
11	MPEG Decoder	A device that transforms a compressed MPEG-encoded bitstream into an analog or uncompressed digital video or audio signal.

12	Proxy Agent	<p>1) A device (usually a computer) that bridges between two protocols so that incompatible interface messages can be passed from one domain to another.</p> <p>2) A device used for protocol translations for extending signal reach beyond network limitations.</p>
13	MPEG Encoder	A transformation device used to convert a video, audio or raw data signal into a compressed bitstream of packetized data (packetized elementary stream or PES) carried as a multiplex of PIDs over a transport stream in real time.
14	MPEG Remultiplexer	A device capable in real time of disassembling and re-assembling packet streams from one or more MPEG-2 transport stream inputs into one or more transport stream outputs containing a multiplex of packets.
15	MPEG Splicer	A real time device that allows switching between compressed bitstreams, providing seamless or near-seamless program transitions triggered from commands either in the transport stream or from an external control system.
16	MPEG Server	A disk-based storage device that stores content in the MPEG domain.
17	MPEG Monitor	A device that monitors the attributes of a compressed bitstream and that may log and report out-of-limit parameters and occurrences.
18	Metadata Extractor	A device that extracts metadata transported with an associated video or audio signal and forwards it for use by other devices
19	Data Server	A device that provides, encapsulates, and transmits data content, announcement and binding information.

The ATSC PMCP schema 3.0 was extended to the interface message for data broadcasting by specifying the new elements for encapsulation, signaling and announcement. The PMCP extension schema for data broadcasting is backward compatible with the PMCP schema so that conventional emission station based on PMCP schema can be easily implemented for data broadcasting emission system in the future.

With regard to the encapsulation and signaling protocol, the transport standards defined how to send the object carousel of [8]. ATSC also specified signaling and announcement of ACAP in [7]. Therefore, PMCP extension schema for data broadcasting provides the data needed by [7]. This document considers only ACAP data broadcasting in defining the extension schema for encapsulation and signaling of ACAP using the DET and the EIT for announcement in terrestrial data broadcasting.

D2. THE PMCP SCHEMA EXTENDED FOR ACAP ENCAPSULATION

The data and attributes of one U-U object in an object carousel are transmitted in one message. The message format is specified by the BIOP (Broadcast Inter ORB Protocol) and is referred to as the BIOP Generic Object Message format. BIOP Messages are carried in Modules of Data Carousels. A module is composed of the one or more BIOP Message. Each object in the module is identified by the objectkey. According to the DSM-CC data carousel specification, each module is fragmented into one or more Blocks which are carried in a DownloadDataBlock message as shown in Figure D2.

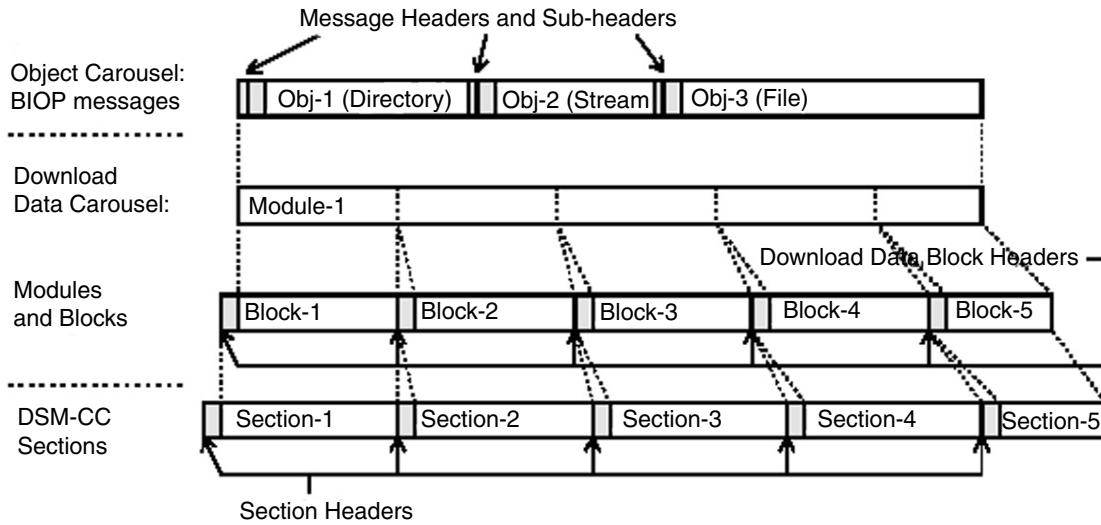

Figure D2 Encapsulation and fragmentation of BIOP messages.

The AcapObjectCarouselType describes the encapsulation information of object carousel data defined in the ACAP standard [8]. The AcapObjectCarouselType is divided into two children elements: the “DataCarousel” element and the “ObjectCarousel” element. (See Figure D3.) The “DataCarousel” element represents the information of data carousel that delivers the BIOP messages in modules, and the “ObjectCarousel” element contains the information of BIOP messages of the object carousel.

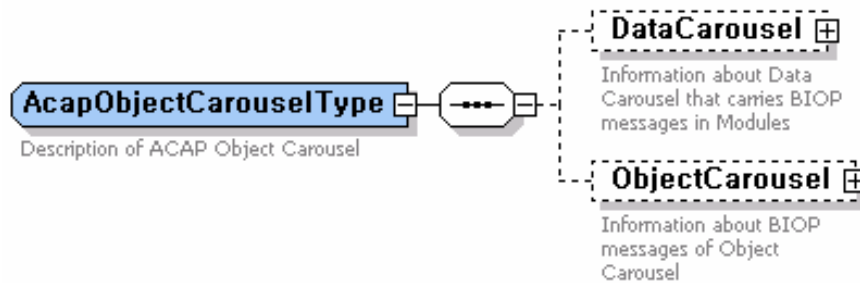

Figure D3 ACAP Object Carousel Type diagram.

D3. DATA CAROUSEL TYPE

The BIOP message is carried through the data carousel. Data carousel consists of DownloadServerInitiate messages, DownloadInfoIndication message, and DownloadDataBlock message. The function of these data carousel messages are:

- DownloadServerInitiate(DSI): a message to provide the reference of service gateway (i.e., root directory) of the object carousel
- DownloadInfoIndication(DII): a message to describe a set of modules such as module’s location, version and size

- DownloadDataBlock(DDB): a message to carry BIOP messages with its payload

DataCarouselType is composed of three elements: the “Dsi” element (DSI), the “Dii” element (DII), and the “PidList” element to describe the DSI, DII, and PIDs, as shown in Figure D4. The lowercase form is used in the schema to comply with the schema naming convention. One “Dsi” element and more than one “Dii” element are defined in a DataCarouselType because the two-layer data carousel for ACAP object carousel is initiated to one DSI message and more than one DII message. The “PidList” element in DataCarouselType describes the condition that DII message may be delivered by means of several modules with different PIDs. Each child element in DataCarouselType can be identified and combined with an association_tag that is defined with the required attribute in “Dsi” element, “Dii” element, and “PidList” element.

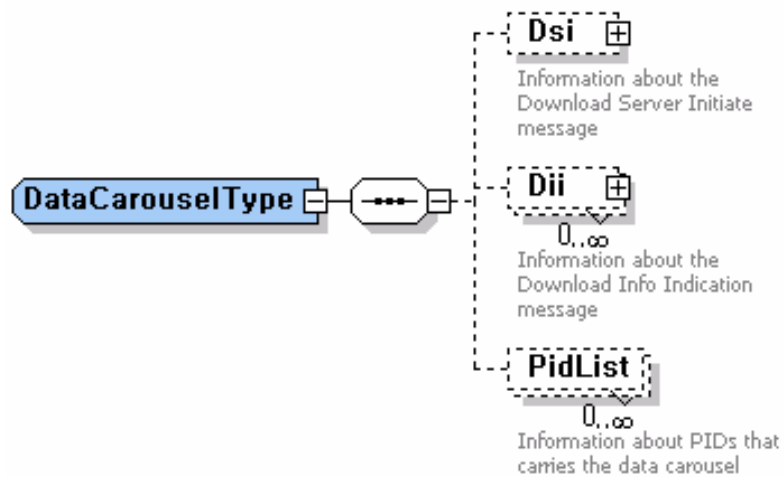

Figure D4 Data Carousel Type diagram.

D4. OBJECT CAROUSEL TYPE

The ObjectCarouselType defines the BIOP messages of the object carousel as illustrated in Figure D5. The ObjectCarouselType includes the children elements to describe the following BIOP messages.

- **Service Gateway Message**

The service gateway message references the root directory of the file system delivered by an object carousel.

- **Directory Message**

The directory message represents the sub directory of the file system to be transported by object carousel.

- **File Message**

The file message is used to convey the data of file and describes the information such as the location and contents type of files.

- **Stream Message**

The stream message describes the list and references to the streams in the broadcast network.

- **Stream Event Message**

The stream event message contains the list and references to stream events in the broadcast network

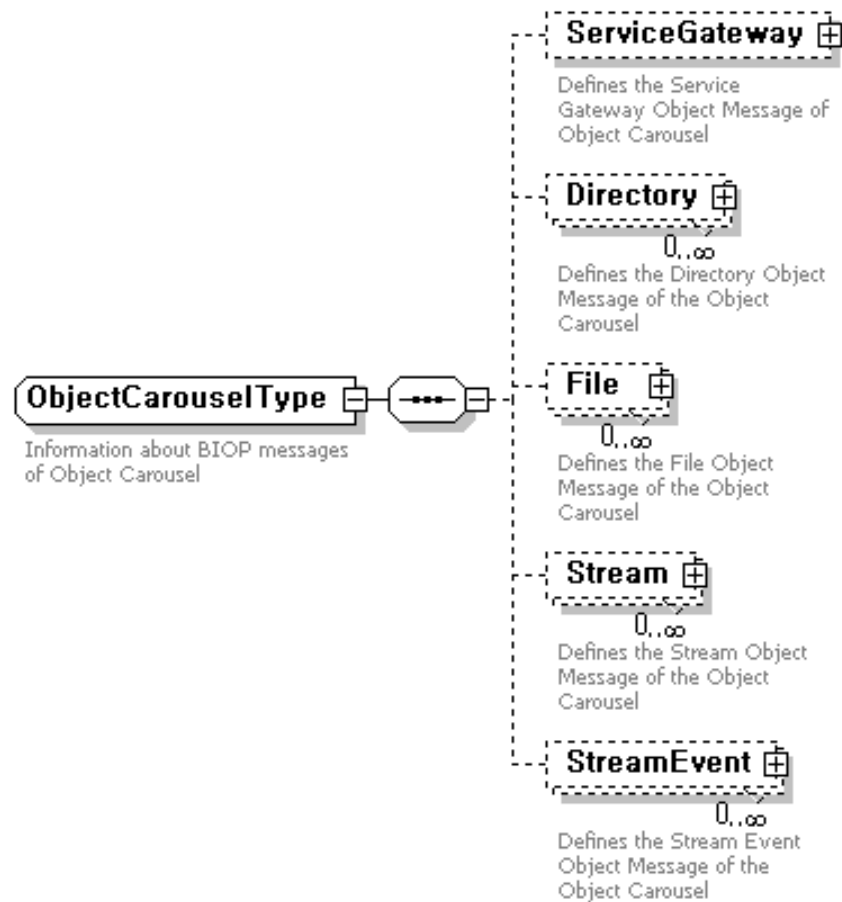

Figure D5 Object Carousel Type diagram.

D5. THE PMCP SCHEMA EXTENDED FOR ACAP SIGNALING

The signalling information enables receivers to identify applications associated with a service, and the location from which to recover them. The ACAP standard specifies the PMT (Program Map Table) and AIT (Application Information Table) to signal a data application to the receiver. The PMCP extension schema for data broadcasting, therefore, includes these elements to describe the information relating to both the AIT and the PMT.

D5.1 ACAP Application Type for AIT signaling

The Application Information Table describes applications and their associated information. Each Application Information Table includes one “common” descriptor loop at the top level for descriptors that are shared between application of that sub-table and a loop of application. Each application identified in the application loop has an application descriptor loop containing the descriptors associated with that application. Figure D6 illustrates the syntax structure of AIT defined in [8].

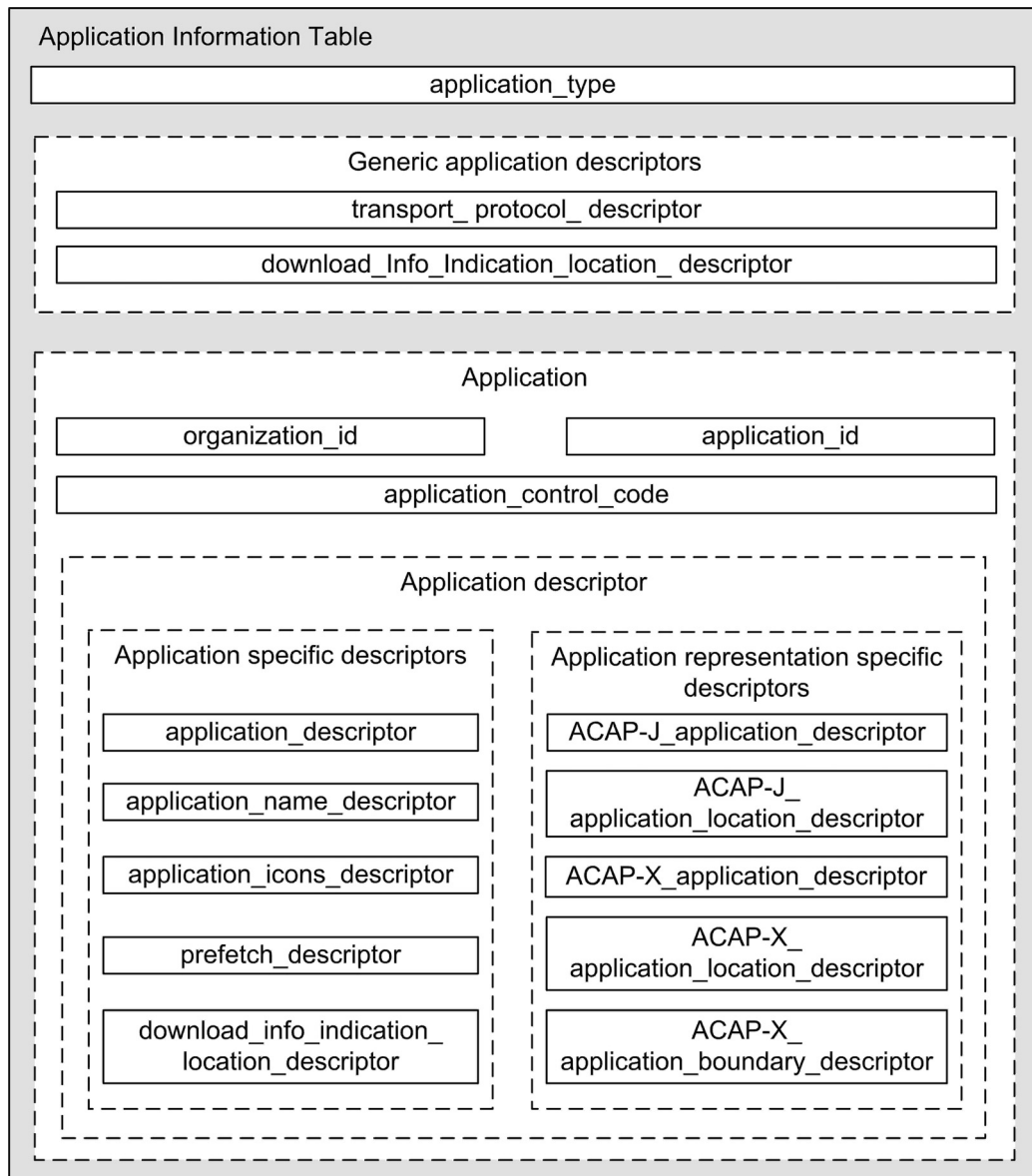

Figure D6 Representation of the contents of the AIT.

AIT descriptors are categorized into three parts: generic application descriptor, application specific descriptor, and application representation specific descriptor. Generic application

descriptors are included in a common descriptor loop. The application specific descriptors also are specific to the application instance. Application representation specific descriptors are specific not only to an application instance but also to an application representation.

The AIT and descriptors mentioned above are represented by the schema shown in Figure D7.

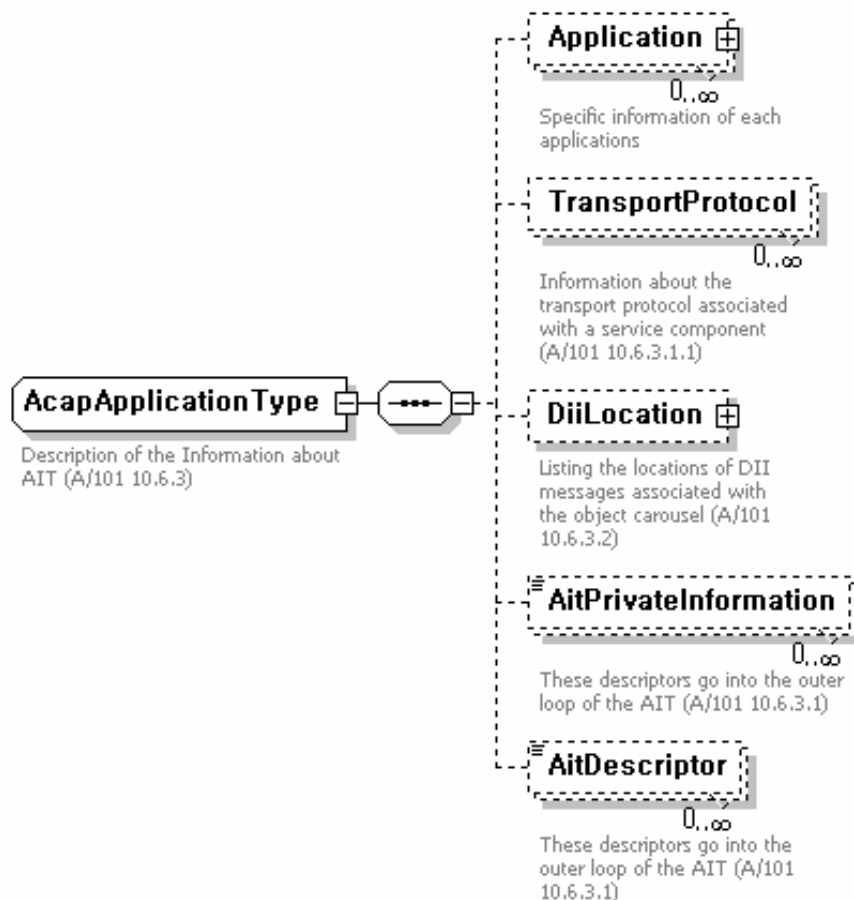

Figure D7 ACAP Application Type diagram.

The Application element (shown in Figure D7) attributes include organizationId, applicationId and controlCode, and also includes the elements to describe the information of application descriptors of the AIT. The TransportProtocol and the DiiLocation describes the information of the transport_protocol_descriptor and the download_info_indication_descriptor, respectively. (See also Figure D8.)

D5.2 Channel Type for PMT signaling

In order to describe the elementary streams of the object carousel, the PMCP schema extended for ACAP data broadcasting includes several additional elements to describe PMT descriptors. Figure D9 represents the PMT descriptors relating to data broadcasting. The first loop for the PMT descriptor delivers the deferred_association_tags_descriptor; the second loop for the PMT descriptor

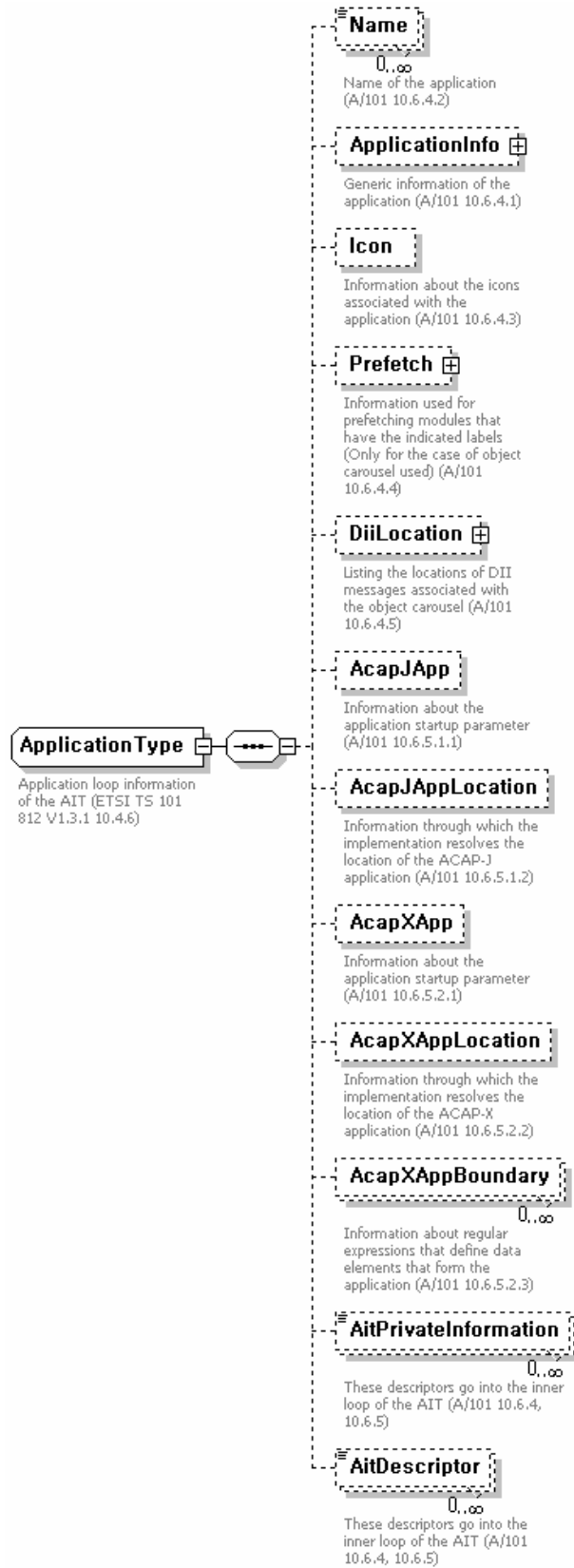

Figure D8 Application Type diagram.

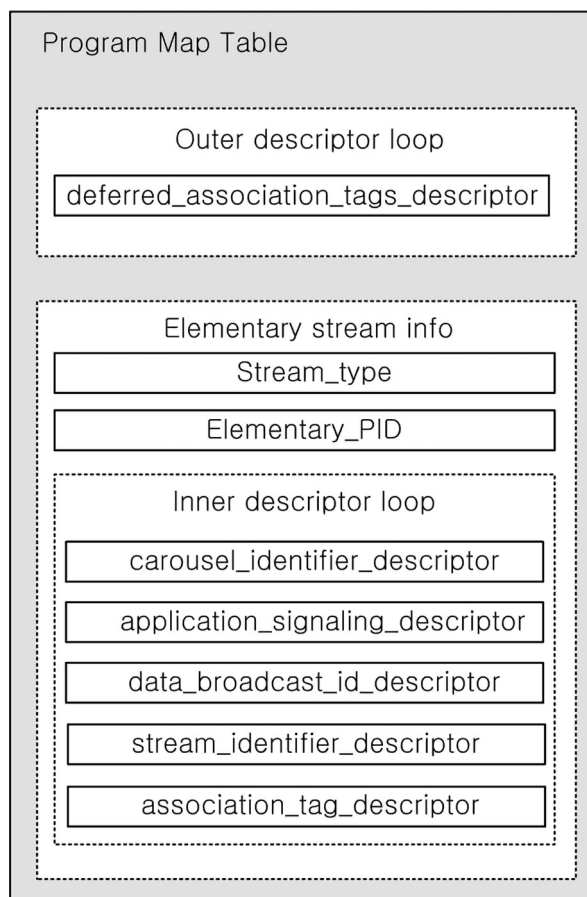

Figure D9 Representation of the contents of the PMT for ACAP data broadcasting.

consists of the `carousel_identifier_descriptor`, `application_signaling_descriptor`, `data_broadcast_id_descriptor`, `stream_identifier_descriptor`, and `association_tag_descriptor`.

Figure D10 illustrates the schema of PMT descriptors for the object carousel. New elements, which describe PMT descriptors for data broadcasting, can be added into the `ElementaryStream` element of the `ChannelType` defined in PMCP because `ElementaryStream` element plays a role in describing the information of the second loop descriptors for the PMT.

D5.3 ACAP Encapsulation and AIT Signaling

Figure D11 illustrates the `AcapDataServiceType` structure which defines the encapsulation and the AIT signaling for data broadcasting. The `AcapDataServiceType` is composed of the `ContentId` element, `AcapApplication` element, `AcapObjectCarousel` element, and the optional `PrivatePmcpInformation` element. The `ContentId` element provides the linkage between `AcapDataServiceType` and `PsipEventType`, or `AcapDataService` and `PsipDataEventType`. The linkage enables ACAP transport stream to obtain the schedule information from `PsipEventType` or `PsipDataEventType` that describes start time and duration with its attributes. Both the `AcapObjectCarousel` element in Section D2 and the ACAP Application element in Section D5.1 describe the encapsulation and the signaling information defined in ACAP.

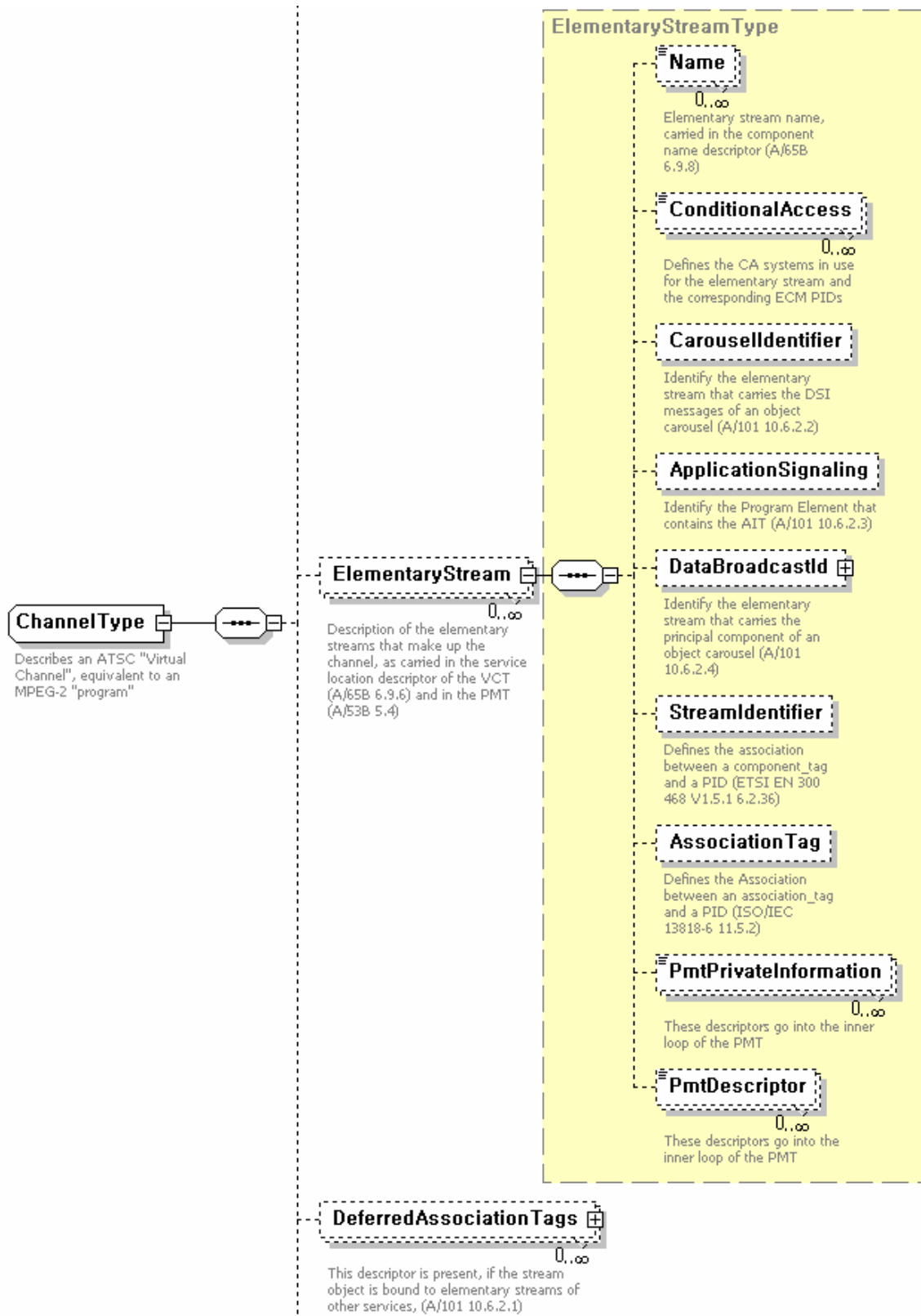

Figure D10 Channel Type diagram for the PMT descriptor.

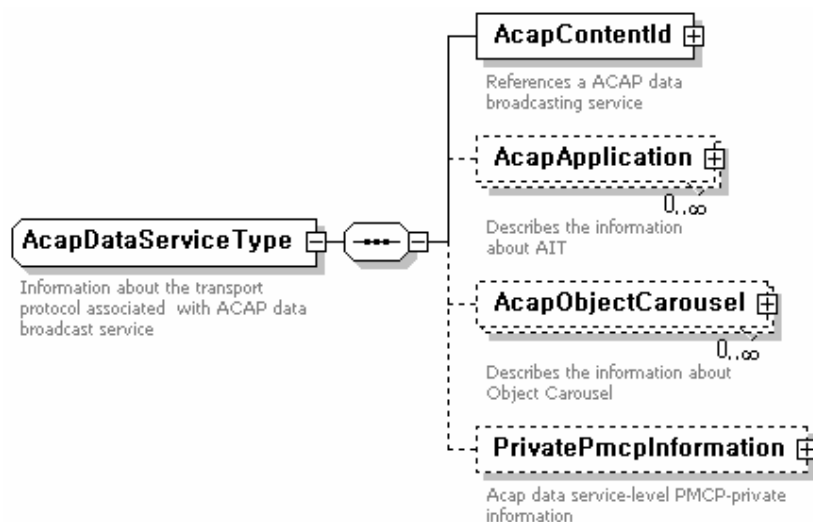

Figure D11 ACAP Data Service Type diagram.

D6. PMCP SCHEMA EXTENDED FOR DATA BROADCASTING

The extended PMCP schema for data broadcasting has newly defined **PsipDataEvent** element for ACAP announcement in Section 5.9.6 and **AcapDataService** element for ACAP encapsulation and AIT signaling in Section D5. In addition, it describes the Channel element modification for PMT signaling specific to ACAP in Section D5.2. The **AcapDataService** element consists of three elements such as **ContentId**, **AcapObjectCarousel**, and **AcapApplication**. Both the **AcapObjectCarousel** and the **AcapApplication** are combined with an **AcapDataService** element in that an ACAP data broadcast service is provided with the AIT and the object carousel delivers applications and their signaling information, respectively. The **AcapDataService** element contains **ContentId** element defined in the **PsipEvent** or the **PsipDataEvent** in the PMCP schema to associate an ACAP transport stream with an event. The **ContentId** element enables the **AcapDataService** element to identify the schedule information defined in the **PsipEvent** element or the **PsipDataEvent** element. The schedule information is used in controlling the delivery of the transport stream for the ACAP data service.

The overall structure showing the previously described elements is shown in Figure D12.

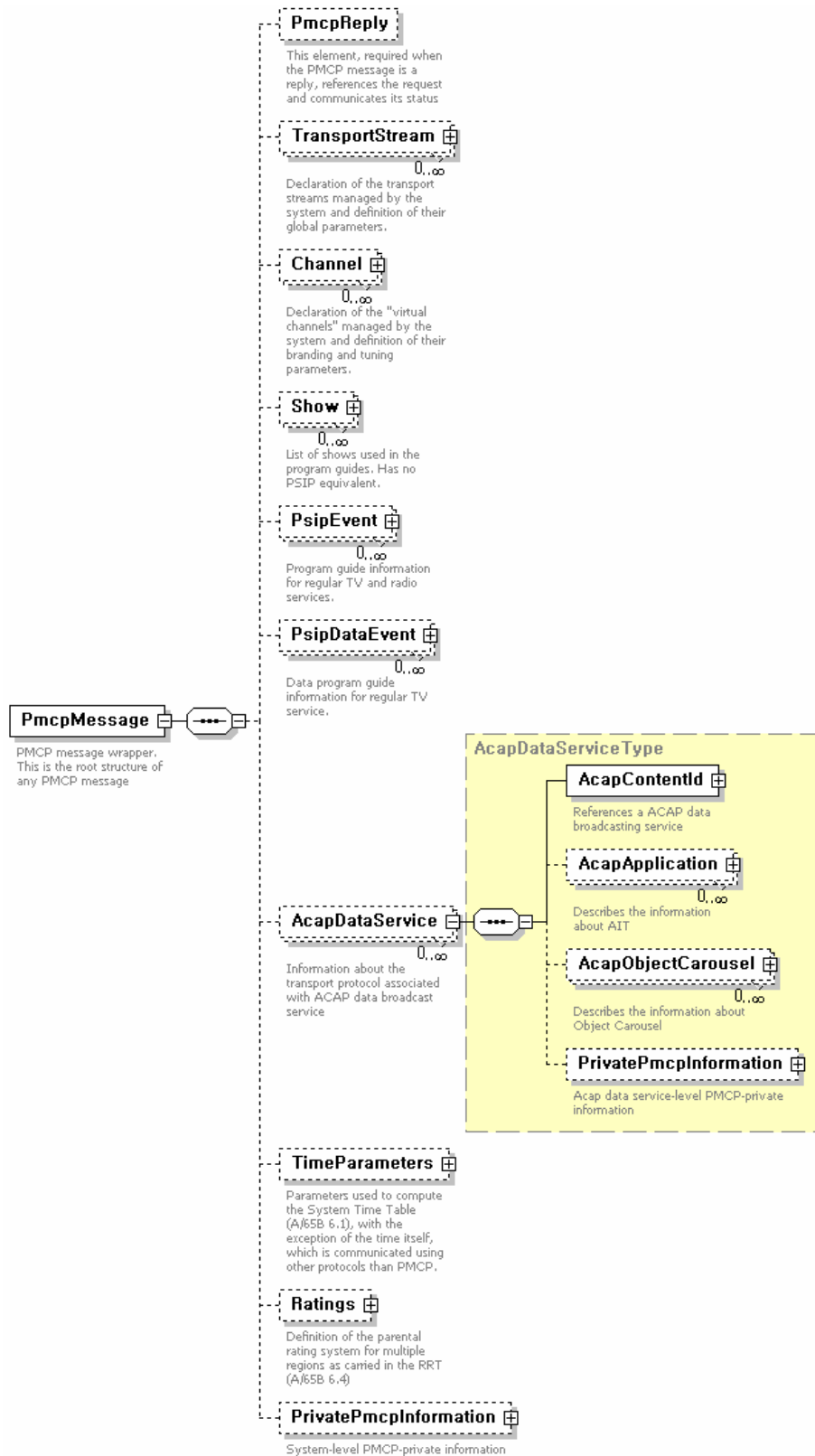
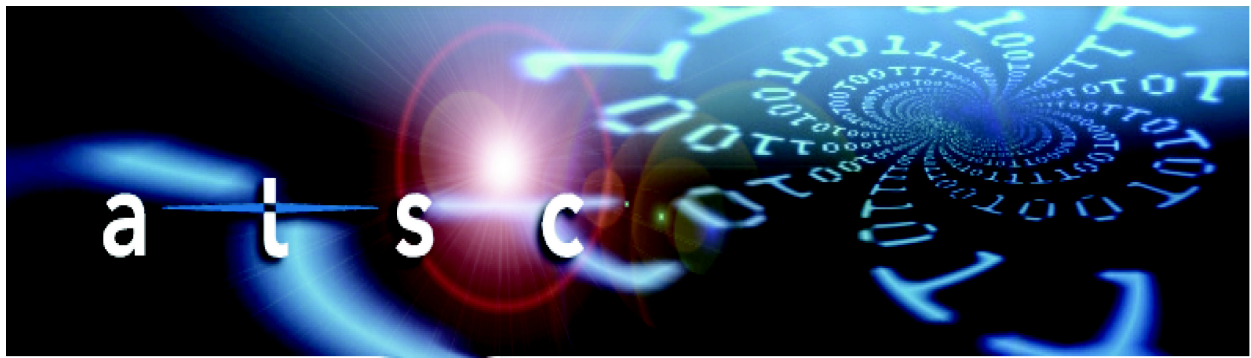

Figure D12 The Extended PMCP Schema diagram.



advancedtelevisionssystemscmitteeinc

Advanced Television Systems Committee, Inc.
1750 K Street, N.W., Suite 1200
Washington, D.C. 20006