

Exploring the science of complexity: Ideas and implications for development and humanitarian efforts

Ben Ramalingam and Harry Jones
with Toussaint Reba and John Young

Foreword by Robert Chambers

Working Paper 285

Results of ODI research presented
in preliminary form for discussion
and critical comment

Working Paper 285

Exploring the science of complexity

**Ideas and implications for
development and humanitarian efforts**

Second Edition

**Ben Ramalingam and Harry Jones
with Toussainte Reba and John Young**

Foreword by Robert Chambers

October 2008

Overseas Development Institute
111 Westminster Bridge Road
London SE7 1JD

ISBN 978 0 85003 864 4

© Overseas Development Institute 2008

All rights reserved. No part of this publication may be reproduced, stored in a retrieval system, or transmitted in any form or by any means, electronic, mechanical, photocopying, recording or otherwise, without the prior written permission of the publishers.

Contents

Foreword by Robert Chambers	vii
Executive summary	viii
Introduction	viii
Key concepts of complexity science	viii
Conclusions	viii
1. Introduction	1
1.1 Aims and overview of the paper	1
1.2 Background: The RAPID programme and the focus on change	2
2. Putting complexity sciences into context	4
2.1 Origins	4
2.2 Applications in the social, political and economic realms	5
3. Concepts used in complexity sciences and their implications for development and humanitarian policy and practice	8
3.1 Unpacking complexity science: Key concepts and implications for international aid	8
3.2 Complexity and systems	8
3.3 Complexity and change	23
3.4 Complexity and agency	44
4. Conclusions	59
4.1 How do the concepts of complexity science fit together?	59
4.2 What do the complexity science concepts offer to those facing international development and humanitarian problems?	60
4.3 How does complexity science differ from existing ways of understanding and interpreting international development and humanitarian problems?	60
4.4 What kinds of phenomena can complexity science help us better understand?	61
4.5 What is the value of complexity science for those engaged in humanitarian and development work? Specifically, does complexity science tell us anything new?	62
4.6 What kinds of practical uses are there for complexity science in international aid?	63
4.7 Concluding remarks	63
References	68

Figures and boxes

Figure 1: The complexity of aid flows in crises	13
Figure 2: Example of a feedback system	16
Figure 3: Key variables and relationships between them in the Euro debate	18
Figure 4: Sensitivity to initial conditions – ball striking razor blade	27
Figure 5: Phase Space Table of the Leicester Urban Area	32
Figure 6: Phase space of a pendulum	33
Figure 7: Phase space of a simple pendulum under friction	33
Figure 8: The two attractors of a pencil being placed on a table	34
Figure 9: Tabular representation of socio-economic system with six dimensions	36
Figure 10: The strange attractor	38
Figure 11: A strange attractor as a creative metaphor	41
Figure 12: Factors affecting adaptive agents in geographical analysis	48
Figure 13: Summary of the three attitudes towards complexity	64
Box 1: Similarities and differences between complexity and systems approaches	5
Box 2: Edge of chaos	40
Box 3: Agent-based modelling	47

Ben Ramalingam is currently Head of Research and Development to the Active Learning Network for Accountability and Performance in Humanitarian Action (ALNAP). He can be contacted on b.ramalingam@alnap.org

Harry Jones is a Research Officer working with the RAPID programme. He can be contacted on h.jones@odi.org.uk.

Toussainte Reba worked as a Research Associate with the RAPID programme in 2006.

John Young is Director of the RAPID Programme. He can be contacted on j.young@odi.org.uk

Acknowledgements

This working paper greatly benefited from thoughts and comments from a dedicated group of peer reviewers, including Simon Burall, Fred Carden, Paul Currion, Randolph Kent, Alim Khan, Sean Lowrie, Simon Maxwell, Lauchlan Munroe, Peter Walker and Nancy White. Additional valuable comments were provided by Robert Chambers and Rosalind Eyben of the Institute of Development Studies (IDS) at Sussex University, Nick Hall of Plan International and Enrique Mendizabal of ODI. Special thanks are due to Robert Chambers for his foreword.

This paper would not have been possible without the diligent editorial and formatting work of Roo Griffiths of Griffiths-Saat Research and Editorial (www.griffiths-saat.org.uk) and Jeff Knezovich of ODI.

Note on the second edition

I have taken advantage of the popularity of the first edition to make some revisions and amendments before publishing the second run. Changes include addressing certain small errors and oversights, but also trying to improve specific concepts, such as phase space and attractors, and adaptive agents. I am currently starting the process of developing the ideas in this paper into a book length publication – any suggestions for this would be gratefully received at b.ramalingam@alnap.org.

Ben Ramalingam, London, October 2008

Acronyms

ABC	Abstain, Be faithful, use Condoms
ABM	Agent-based Modelling
ALNAP	Active Learning Network for Accountability and Performance in Humanitarian Action
BDI	Beliefs, Desires and Intentions
CAS	Country Assistance Strategy
CBNRM	Community-based Natural Resource Management Organisation
CGE	Computable General Equilibrium
DFID	UK Department for International Development
DoC	Drivers of Change
GDI	Gender-related Development Index
GDP	Gross domestic product
HAP	Humanitarian Accountability Partnership
HDI	Human Development Index
HIV/AIDS	(Human) Acquired Immunodeficiency Syndrome (Virus)
IBM	International Business Machines Corporation
IDRC	International Development Research Centre
IDS	Institute of Development Studies
IFI	International Financial Institution
IISD	International Institute for Sustainable Development
INGO	International NGO
IRC	International Rescue Committee
ISCID	International Society for Complexity, Information, and Design
LFA	Logical Framework Approach
LSE	London School of Economics
M&E	Monitoring and Evaluation
MDG	Millennium Development Goal
MEP	Monitoring Environmental Progress
NGO	Non-governmental Organisation
ODI	Overseas Development Institute
PD	Prisoners' Dilemma
RAPID	Research and Policy in Development
RCT	Randomised Control Trial
Sida	Swedish International Development Cooperation Agency
SNA	Social Network Analysis
SOSOTEC	Self-organising System on the Edge of Chaos
SWAp	Sector-wide Approach
T21	Threshold 21
UCL	University College London
UK	United Kingdom
UN	United Nations
UNDAF	UN Development Assistance Framework
UNDP	UN Development Program
US	United States
WASH	Water Sanitation Hygiene

Foreword by Robert Chambers

Much development and humanitarian thinking and practice is still trapped in a paradigm of predictable, linear causality and maintained by mindsets that seek accountability through top-down command and control. Recent years have seen more emphasis on the mechanistic approaches of this paradigm and the kinds of procedures which are increasingly questioned by successful private sector organisations.

This has widened the gap between actual aid practices and the rhetoric of the many initiatives which aim to improve them – including aid effectiveness, institutional reform, participation, local ownership and empowerment.

In the meantime and in parallel, complexity science has explored and articulated a contrasting world of understanding, helping to explain complex dynamic phenomena in a widely diverse range of settings using insights and concepts like non-linearity, edge of chaos, self-organisation, emergence and co-evolution.

This Working Paper is, to my knowledge, the first comprehensive and substantial work to be published that attempts, systematically and thoroughly, to bridge these two worlds, explaining and then relating the ideas of contemporary complexity theory to current development and humanitarian thinking and practice. The ten concepts of complexity science – organised into the three domains of *complexity and systems*, *complexity and change*, and *complexity and agency* – provide us with lenses through which to examine, and see differently, the realities with which we grapple in international aid work.

Ben Ramalingam and his colleagues describe and interpret a world of messy and unpredictable change which corresponds with much experience in the aid sector. They challenge dominant ideas and practices of development and change, locked in as these are to linear thinking and to procedures and requirements such as the logical framework and impact assessments. With scholarly authority and illustration, they explore the implications for how we see and think about development and humanitarian work. In doing so, they help to make clearer why so much aid is so problematic, in both conception and execution.

Exploring the Science of Complexity should provoke and inspire changes in aid thinking and practice that will lead to greater realism. Realism means more modesty and more honesty, which will not be easy. The authors suggest that political, professional, institutional and personal changes are necessary. Such changes require transformations of power relations, procedures, mindsets, behaviours, and professional education and training. More than anything, these changes demand the exercise of agency by individuals with the vision, commitment and courage to learn from and champion new and challenging approaches.

Let me hope that the ideas and orientations explored here will be understood and internalised by policy-makers and others with power, as well as by researchers, analysts and managers; that this will lead to norms, actions and relationships that will make development and humanitarian practice more attuned to reality, more sensitive to context, more adaptive, less reductionist and less simplistic; and that this will in turn generate and enable changes that enhance social justice and are more effectively pro-poor.

The potential is there. The need is there. We have in this Working Paper new analysis and insights to inform, inspire and underpin the radical changes in mindsets and practice required. It is now up to readers to read, reflect, debate, internalise and use these insights to find new and creative ways to bring about a better world.

Robert Chambers
January 2008

Executive summary

Introduction

The key concepts of complexity science provide a means of understanding dynamics and processes of change found in a range of physical and biological phenomena. Complexity science as it stands at the present day is a collection of ideas and principles, many of which have been influenced by other bodies of knowledge. Increasing attention is now being paid to how these concepts can help researchers and practitioners understand and influence social, economic and political phenomena. There is energetic debate occurring around their relevance and applicability outside their discipline of origin.

In the international development and humanitarian spheres, work in this area has grown relatively slowly. The application of complexity science to human realms has by no means been non-contentious: it has its champions, pragmatists and critics (for more on this, see the conclusions to this executive summary). This paper explores and explains the key concepts of complexity science, then moving on to reflect on the implications of the concepts, before arriving at some general conclusions about what complexity science means for development and humanitarian efforts. It is hoped that the conclusions may be of use for the busy policy advisors, overstretched managers and time-constrained evaluators and researchers who are interested in improving reform and change efforts, and keen to better understand how complexity science relates to such efforts and, by extension, the future of the sector.

Key concepts of complexity science

The paper details each of the 10 concepts of complexity science, using real world examples where possible. It then examines the implications of each concept for those working in the aid world. Here, we list the 10 concepts for reference, using the next section of this summary to suggest some **overall** implications of using the concepts for work in international development and humanitarian spheres.

The ten concepts are as follows:

- *Interconnected and interdependent elements and dimensions;*
- *Feedback processes promote and inhibit change within systems;*
- *System characteristics and behaviours emerge from simple rules of interaction;*
- *Nonlinearity;*
- *Sensitivity to initial conditions;*
- *Phase space – the ‘space of the possible’;*
- *Attractors, chaos and the ‘edge of chaos’;*
- *Adaptive agents;*
- *Self-organisation;*
- *Co-evolution.*

Conclusions

This brief conclusion attempts to bring together the above concepts and their various implications to answer a number of key questions for international development and humanitarian efforts overall.

1. **How do the concepts of complexity science fit together?** Complexity concepts are best described as a loose network of interconnected and interdependent ideas. Their relevance and applicability may be best seen through empirical studies of practical realities. A firm foundation for complexity may never be achieved; it may be that there is a need to become better accustomed to a network-oriented model of how knowledge and ideas relate to each other, instead of a classical model of knowledge which focuses on ‘foundations’ , ‘pillars’, etc.
2. **What do the complexity science concepts offer to those facing international development and humanitarian problems?** The debate on this subject continues.

Classical science has been described as a set of ‘useful fictions’ that enables us to cut through real world complexities. Clearly, this can oversimplify issues, and prove less than useful. Our conclusion is that complexity science offers a set of useful, challenging ‘fictions’ which enable us to better delineate and understand complexities of the real world.

3. **How does complexity science differ from existing ways of understanding and interpreting problems?** Complexity steers a course between induction and deduction by aiding understanding of the mechanisms through which unpredictable, unknowable and emergent change happens. This enables a reinterpretation of existing systems and problems faced within them. Complexity generates insights that help with looking at complex problems in a more realistic and holistic way, thereby supporting more useful intuitions and actions.
4. **What kinds of phenomena can complexity science help us better understand?** There are multiple ways in which the work carried out by development and humanitarian agencies can be seen as taking place within complex systems. Complexity science can prove particularly useful in allowing us to embrace what were previously seen as ‘messy realities’. This might allow comparisons between cases and systems previously not related, potentially strengthening insight and helping to highlight possible effective actions.
5. **What is the value of complexity science for those engaged in humanitarian and development work? Does it tell us anything new?** The concepts of complexity theory provide a series of important stepping stones towards a more realistic understanding of the limitations of aid as well of the factors involved in ‘messy realities’. As to whether complexity science tells us anything new: 1) it allows old concepts to be understood in different ways; 2) it allows for new generalisations about certain kinds of phenomena; and 3) it has unique concepts of its own, such as sensitive dependence on initial conditions, already manifest in the idea of path dependence in neoclassical economics.
6. **What kinds of practical uses are there for complexity science in international aid?** In particular, qualitative and quantitative approaches have a lot more in common when seen using the light of complexity. The concepts can be used individually or in combination, to reflect on an individual phenomenon, the overall system, or specific sub-systems. They can be used *ex-ante* and *ex-post*, to augment existing models or as a framework in their own right. In sum, they can be used in a highly flexible manner. Future collaborative work might prove especially useful in identifying the range and scope of the concepts.

At the start of this exploration, our view was that complexity would be a very interesting place to visit. At the end, we are of the opinion that many of us in the aid world live with complexity daily. There is a real need to start to recognise this explicitly. Whether solutions to longstanding problems can be arrived at using complexity thinking will become clearer when those individuals and institutions working in international aid start consciously and deliberately to use the complexity lens.

We have tried to be aware of the different attitudes towards complexity science and not overextend the concepts’ potential applications. Perhaps the greatest challenge lying in complex systems stems from the fact that they fundamentally state that the best course of action will be highly context-dependent. For this reason, we realise that many of the implications here are at a meta-level, in that they suggest new ways to think about problems and new questions that should be posed and answered, rather than concrete steps that should be taken as a result.

Given the scope for new ideas, the most serious implication of complexity science for international aid is the inability or unwillingness to engage with complexity in aid policy and practice. Meanwhile, the financial and political costs of bringing a complexity framework to bear on development and humanitarian problems are far from trivial.

Four changes seem to be of particular importance: the **openness** to new ideas, the **restraint** to accept the limitations of the approach; the **honesty and humbleness** to accept the limitations of aid efforts and to accept mistakes, and the **courage** to face up to the implications of these ideas.

1. Introduction

‘Complexity science’ is a term used to describe a set of concepts, principles, propositions and ideas that have emerged and clustered together over the course of the 20th century. As the open source encyclopaedia has it:

‘Complexity science is not a single theory – it encompasses more than one theoretical framework and is highly interdisciplinary, seeking the answers to some fundamental questions about living, adaptable, changeable systems’ (Wikipedia, 2007).

The concepts of complexity science have presented a way of better describing and understanding dynamics and processes of change found in a range of physical and biological phenomena. As a result, complexity science has been described as being ‘at the forefront of science and mathematics’ (Berreby, 1998), and is the focus of an ‘impressive literature’ and an increasingly ‘specialised vocabulary’ (Rosenhead, 2001). The champions of complexity science have identified underlying parallels in phenomena as diverse as the rise and fall of civilisations, the human immune system, the origins of life, the evolution of species, the workings of the human brain, the onset of psychiatric illnesses, ecological systems, genetic selection, flocking birds, the stock market and the world economy (Breslin, 2004, among others). This breadth of coverage means that few fields of scientific endeavour have not been examined, in one way or another, by use of the concepts of complexity science. There are even dedicated research institutes, such as Santa Fe in the US, set up in 1984, where scientists from a range of disciplines collaborate with computing experts to conduct interdisciplinary work on the application of complexity science to new fields and questions (Rosenhead, 2001).

Increasing attention is being paid to how the key ideas and concepts of complexity science can help researchers and practitioners understand and influence social, economic and political phenomena. Much of the effort focuses on policy and practice within Western developed countries – for example, education policy in the US (Sanders and McCabe, 2003), global energy policy, government policy implementation in the UK (Chapman, 2004), community development in the UK (Gilchrist, 2000) and international relations (e.g. Jervis, 1997; Urry, 2003; Cutler, 2002). Alongside this increasing interest, energetic debate is occurring around the relevance and applicability of this cluster of concepts for social, economic and political life.

In the international development and humanitarian spheres (in which the Overseas Development Institute – ODI – specialises), the volume of work in this area has grown relatively slowly, although it is now increasing. A handful of studies highlight the potential and implications of complexity sciences for understanding and operating in the aid system (Chambers, 1997; Eyben, 2006; Rihani, 2002; Warner, 2001; Groves and Hinton, 2004; Lansing and Miller, 2003; Sellamna, 1999). Of these previous studies, two are ODI working papers (Warner, 2001; Sellamna, 1999). There are studies that focus on related and overlapping fields of endeavour, such as peace operations (Aoi et al., 2007) and, increasingly, on military and security agendas. Tools and methods have been inspired and influenced by complexity science, including IDRC’s outcome mapping (Earl et al., 2001) and social network analysis (Davies, 2003). Some thinkers see complexity approaches as fundamental to the reorientation needed to improve the effectiveness and legitimacy of aid (Groves and Hinton, 2004). Others argue that an understanding of complexity should shape the dominant trends of thinking in development over the next decade (Rihani, 2002).

1.1 Aims and overview of the paper

Our first aim in this working paper is to explore the literature on complexity science. The bulk of this literature is technical, mathematically focused and applies to physical and biological sciences. This is accompanied by a sizable set of publications in the popular science genre. In addition, there is a rapidly growing set of books, journals and articles by thinkers who are exploring and applying

complexity science concepts in social, political and economic realms. Our aim in reviewing this spectrum of material is primarily to clarify what is meant by this arcane-sounding and often perplexing set of ideas.

We also explore relevant reports, evaluations and practices from the international development and humanitarian sectors. We do this in order to uncover the implications of the concepts of complexity for organisations and individuals who work in the aid world. Wherever possible, we will use concrete and real world examples and illustrations.

The two strands of ideas and evidence, that from the complexity science literature and that from the international development and humanitarian sectors, are woven together. In this way, the paper presents the reader with a general introduction to the topic, followed by a review of each of the key concepts of complexity, placed in the context of its implications for international aid. In our conclusion, we attempt to draw these strands together to arrive at some general conclusions about what complexity science means for development and humanitarian efforts.

In particular, we want to identify: what potential value complexity science holds for the busy policy advisors, overstretched managers and time-constrained evaluators and researchers who work on change and reform initiatives within our sector; what the potential costs are of incorporating complexity perspectives; and the likelihood that these ideas will be utilised in programmes and projects. In particular, this paper should appeal to those who are keen to better understand how thinking from the cutting edge of scientific endeavours can be related to international aid efforts and, by extension, what meaning they carry for the future of the sector.

Our overall approach to this paper resonates with that of two earlier thinkers (Chambers and Conway, 1992). To paraphrase: we will try to open up and explore concepts, analogies and relationships and will put forward working concepts, categories and hypotheses for testing for practical utility. In the spirit of exploration, we have also allowed ourselves the liberty of reflection and speculation, of seeing where a line of thinking would lead, and as a consequence, the paper may raise more questions than it answers.

The unashamedly exploratory nature of this work does not however preclude thorough critical reflection. In particular, we are keen to address the following questions in the conclusions:

- How do the concepts of complexity science fit together?
- What do the complexity science concepts offer to those facing international development and humanitarian problems?
- How does complexity science differ from existing ways of understanding and interpreting problems?
- What kinds of phenomena can complexity science help us better understand?
- What is the value of complexity science for those engaged in humanitarian and development work? Does it tell us anything new?
- What kinds of practical uses are there for complexity science in international aid?

1.2 Background: The RAPID programme and the focus on change

While we hope that this paper will prove relevant for international development and humanitarian efforts generally, we have given special attention to the themes that have shaped the work of the Research and Policy in Development (RAPID) group at ODI. These themes are: the role of evidence in policy processes; communications; knowledge management and organisational learning; capacity building; and networks. A better understanding of the dynamics of social and organisational change is at the heart of our work in each of these areas.

Typical questions we try to address in RAPID include:

- Why do some research and ideas get taken up and utilised in policy processes, whereas others never gain any time in the limelight?
- Why are communications activities in some contexts successful in informing and building shared understanding, while identical activities elsewhere have no effect?
- Why do some organisations successfully learn and adapt to environmental constraints and opportunities, whereas others implode or fade away?
- Why is capacity building so hard to achieve in practice?
- Why are some networks successful over many years, whereas others fail to take off?

RAPID has worked hard to further understanding in these areas of work, through efforts to deepen awareness of what works in practice, to explore new and innovative ways to apply this awareness, and to undertake action and theoretical research across a wide range of circumstances.

From the start of our programme in 1999, complexity science appeared to carry potential, both as a means of generating more insights about our ongoing work on change processes, and as a means for providing an underlying theoretical framework for our thinking in our diverse areas of interest, helping to bring them together in a more effective and coherent manner.

This paper is our first attempt to investigate this potential systematically. We see this as part of an ongoing intellectual and practical effort to understand and apply complexity approaches in our work, one which has already generated much interest and energy from those focusing in different areas of the aid endeavour.

2. Putting complexity sciences into context

2.1 Origins

In scientific efforts to investigate natural phenomena, some of the most longstanding conceptual and methodological issues have centred on natural systems that undergo sudden, unexpected and disorderly change (Sanders, 1998). Scientists could use systematic methods to understand the elements making up water, the structure of a water molecule and the different physical states of water, but it was much harder to apply a similar approach to understanding the dynamics of change present in a whirlpool or a change in the climate. Not only were the required methods and tools not available until relatively recently, but also their form was beyond the imagination of most thinkers (Gleick, 1987). The unspoken consensus was that these questions could not, in fact, be answered, and that any attempt was doomed to frustration and failure.

In a work widely acknowledged as helping to popularise an understanding of perhaps the most famous element of complexity – namely, chaos – science journalist James Gleick (1987) describes how, in the 1960s and 1970s, a scattered group of scientists in the US and Europe started to investigate ways to understand and explain disorder and change. The most famous of these was Edward Lorenz, whose ‘butterfly effect’ is still the strongest metaphor for chaos in the public imagination. The butterfly effect demonstrated how small differences at the outset of an experiment – such as a butterfly flapping its wings – could lead to massive differences at a later stage – such as storms raging over New York.

The work of Lorenz was crucial because it was an early – and highly influential – step in illuminating a world of nonlinear dynamics. This world was an important addition to Newton’s reductionist model of a predictable and orderly universe. Under Newtonian principles, analysing complex phenomena first involves dividing it into component parts, then explaining the behaviour of these parts, and then aggregating these partial explanations into an understanding of the whole. In contrast, Lorenz’s approach involved understanding phenomena by analysing patterns in a system’s behaviour as a whole. Under certain conditions, even the most insignificant agent has some influence on the system, influencing the initial conditions and ensuring that things never happen in the same way twice (personal communication with Alim Khan, 2007). Deterministic modes of thinking, in which the future is seen as a straightforward extrapolation of past trends, were reassessed in light of this discovery. Those conditions to which deterministic thinking could not be applied were scrutinised using a new set of concepts and ideas – which were increasingly referred to as complexity science (Sanders, 1998).

In the following years, researchers were able to use new technologies and analytical frameworks to help strengthen understanding of processes and data that did not fit existing theories and models. The irregular side of nature – the discontinuous and erratic side – had been a puzzle to science, but illumination was occurring rapidly by means of the new science of complexity. We will come later to the distinct concepts of complexity; suffice it to say here that these concepts were elaborated in a range of different settings but shared a very precise definition in terms of the mathematical relationships between the elements of the system under study. Showing that these relationships applied to a range of physical phenomena was the first step in moving chaos theory from a matter for curious interest to the basis of new efforts for understanding dynamic change processes.

The tools of complexity science and chaos found their early articulation within the physical sciences. However, once developed, scientists started to see similar processes everywhere – not just in the atmosphere, but also in the turbulent sea, in the fluctuations of wildlife populations, in the oscillations of the heart and the brain, in the movement of stock markets, and in the movement of traffic.

It is important to reiterate that what is usually referred to as complexity science is actually a collection of ideas, principles and influences from a number of other bodies of knowledge, including chaos

theory, cybernetics and complex adaptive systems (a term coined by researchers at the Santa Fe Institute) in the natural sciences, postmodernism in the social sciences, and systems thinking, which is found across all sciences.

Systems thinking is particularly close in its origins and scope to complexity science. As we shall see, complexity can only emerge in the context of a system, and certain aspects of complexity, such as feedback, find clear parallels in systems thinking. From the perspective of one of its leading proponents, Peter Senge (1990), systems thinking focuses on seeing interrelationships rather than linear cause-effect chains, and seeing processes of change rather than snapshots. This leads to a search for certain types of systems structures that recur again and again: the deeper patterns lying behind events and details. In our reading of the literature, the differences vary depending on the perspective of the thinker. Some systems thinkers argue that they have always been focused on complex systems. Some complexity specialists argue that complexity is built on fundamentally different assumptions. Some thinkers have gone so far as to outline the key differences – see Box 1 below.

Box 1: Similarities and differences between complexity and systems approaches

It is worth noting that:

- Systems thinking assumes that systems have dominant rules that can be used to calculate potential equilibrium, whereas complexity emphasises that systems tend to defy calculated equilibrium.
- Systems thinking sees that systems have some kind of ‘control system’ that provides guidance and shapes the system, whereas complexity recognises the possibility of self-organisation.
- Systems thinking suggests that elements in a system can be understood as isolated elements and symbols, whereas complexity forces us to see the interdependence of the nature/meaning of individual elements and the context in which they are embedded.
- Systems thinking assumes that systems propose rational processes and predictable results, albeit through complicated means, whereas complexity recognises that solutions are arrived at via dynamic processes that are not likely to result in a final conclusion.
- Systems thinking assumes that systems change their structures in accordance with rule-based learning, whereas complexity recognises that change is perpetual, so learning is a constant factor.

For more on this debate, see Haynes (2003) and Cilliers (1998).

2.2 Applications in the social, political and economic realms

Following initial applications of the new body of work to the physical sciences, a number of thinkers and institutions started to work towards new approaches, ones which viewed social, political and economic phenomena through a complexity lens. Many statements have been made about the relevance of complexity science, of which the following is typical:

‘Economies are complex dynamic systems. Large numbers of micro agents engage repeatedly in local interactions, giving rise to global regularities such as employment and growth rates, income distributions, market institutions, and social conventions. These global regularities in turn feed back into the determination of local interactions. The result is an intricate system of interdependent feedback loops connecting micro behaviours, interaction patterns, and global regularities’ (Tesfatsion and Judd, 2006).

Some thinkers, who include Nobel laureates among their number, have even argued that complexity sciences provide a mechanism to overcome the boundaries between the physical and social sciences (Urry, 2003). Despite such kinds of statements or ambitions, the application of complexity to human realms has not consisted of a straightforward, non-contentious transfer. In *Whose Reality Counts* (1997), a book that represents one of the first attempts to bring complexity thinking into thinking about international development, Robert Chambers provides a pertinent summary of the debate:

‘... the striking resonance by analogy with the few simple rules on non-hierarchical self-organising systems in computer simulations poses the question whether we have a *deep paradigmatic insight, an interesting parallel, or an insignificant coincidence*’ (Chambers, 1997, emphasis added).

This debate continues to shape the applications of complexity outside the physical sciences.

It is useful to have an initial overview of the debate at this stage. As with all debates, we can find champions, pragmatists and critics. (And, naturally, one person’s serious champion is often another’s lightweight evangelist, but that is another matter.)

The **champions**, for whom complexity is a deep paradigmatic insight, see it as a new approach to science, thought and action. To them, complexity science signifies a change in the way that social sciences should be conducted, and this should in turn lead to a fundamental shift in policy and practice. Opinions vary on how this should materialise. Some are concerned with the direct application of mathematical definitions found in the natural sciences to social phenomena. As Nobel Laureate Ilya Prigogine (1997) suggested, complexity is not simply a theory of the physical world, but deals with the dynamics of all populations that can be understood using statistical methods. Such efforts focus on ‘hard’ data which are collected over time and analysed to identify the existence of the key concepts of complexity. This approach calls for evidence of complexity which is identical to, or at the very least comparable with, that found in the natural sciences. Such approaches face methodological and data issues.

Other, perhaps less mathematically minded, champions suggest that lack of data and other issues facing quantitative applications of complexity in the social sciences should not deprive social analysts of a set of useful insights (Dendrinou, 1997), and that many significant phenomena of so-called social realms are in fact hybrids of physical and social realms – for example, health, environment, technology and so on (Urry, 2003). In general, complexity has appealed most to those who feel that top-down, command-and-control and reductionist approaches *can* be inappropriate in many real world situations. As Chambers puts it:

‘... provisionally, it would seem that the key is to minimise central controls, use rules which promote and permit complex, diverse and locally fitting behaviour: decentralise, minimise controls, enable local appraisal, analysis, planning and adaptation for local fit in different ways’ (Chambers, 1997).

The sections to follow will help to clarify and understand why the above might be the case, and look at the ideological implications of this approach more closely.

The **pragmatists**, for whom complexity provides interesting and potentially useful parallels, are exploring the relevance of complexity science to social systems and organisations, and working to assess the practical benefits that arise from its application outside the natural sciences (Mittleton-Kelly, 2003). This work suggests that complexity is a lens that helps us look at our world and shape our action but, importantly, that it is a set of concepts and tools that should not be treated as the ‘only way’ to look at and do things (ibid).

The pragmatists tend to accept the work-in-progress nature of complexity sciences, and the challenges that arise from drawing on diverse and varied bodies of knowledge. These challenges create issues around definition, measurement, analysis and coherence, and lead to a general acknowledgement that there is a need for a deeper theoretical understanding and further practical applications. As has been suggested by one thinker:

‘The atmosphere of complexity work is of a construction site, not a completed building, which has led in the last few years to complaints that the grand edifice cannot be erected’ (Berreby, 1998).

Critics, for whom complexity may be nothing more than an insignificant coincidence, dismiss the relevance of complexity science beyond the natural sciences, levelling a number of potentially troubling objections. Some have argued that, in each case of transferring an idea from philosophy or the natural sciences into the social sciences, one must first demonstrate specific application (Sokal and Bricmont, 1998), and that this is not being carried out sufficiently in complexity science. Since there are now numerous examples of such application, especially in the past decade, this argument becomes less of a criticism and more of an important proviso.

There are also frequent criticisms of the fact that complexity science has become a favourite of management consultants, with a growing number of ‘complexologists’ selling their services in the realm of organisational management. As one thinker on military operational analysis has put it:

‘The majority of these writings seem to claim that the “old” thinking needs to be wholly replaced with “new” thinking, and that a new all-embracing perspective, sometimes referred to as “complexity thinking”, is available that will solve all our apparent woes’ (Richardson et al., 2000).

Such consultants have been accused of using ‘well defined technical terms’ as ‘window dressing’ to add an air of scientific authority to their own agendas (Haynes, 2003). Equally critical is the fact that the key concepts of complexity often seem poorly understood, and issues of their relevance and applicability often glossed over or ignored (Piepers, 2006). As one writer on the role of complexity in management has said:

‘... there is no evidence that complexity science-based prescriptions for style, structure and process do produce the results claimed for them ... Such evidence as is adduced is almost exclusively anecdotal in character’ (Rosenhead, 2001).

Even more challenging is the following statement:

‘Much of the work claiming to import complexity science into [the social sciences] ... typically writes that the world is complex therefore managers should do “X” (insert most recent pop management idea)’ (Sorenson, 1999).

Following a famous example of Western confidence tricksters offering shares in a highly valuable but fictional commodity, such approaches have been described as peddling ‘managerial snake oil’ (Sorenson, 1999).

Critics have also argued that complexity sciences can show us nothing new in socioeconomic realms. Specifically, they are seen to add nothing to approaches dealing with understanding social phenomena, only offering recommendations already reached by other thinkers. Its popularity is related less to the inherent value in the approach and more to the current wider societal need to better understand an increasingly interconnected and uncertain world.

Over the course of the paper, we will attempt to navigate these debates by using empirical studies as the basis of our exploration, being as rigorous as possible in interpreting their implications. In taking an empirically based approach, we hope to establish careful and considered connections between complexity and specific implications for aid work, while avoiding accusations of peddling ‘managerial snake oil’ (Sorenson, 1999).

We will revisit debates both throughout the paper and in our conclusions.

3. Concepts used in complexity sciences and their implications for development and humanitarian policy and practice

3.1 Unpacking complexity science: Key concepts and implications for international aid

This chapter presents the 10 key concepts of complexity science. Over the course of the chapter, each concept is described, its relevance to social economic and political contexts established, and key implications for international development and humanitarian efforts highlighted.

The three sets of complexity science concepts are as follows:

Complexity and systems: These first three concepts relate to the features of systems which can be described as complex:

1. Systems characterised by **interconnected and interdependent elements and dimensions** are a key starting point for understanding complexity science.
2. **Feedback processes** crucially shape how change happens within a complex system.
3. **Emergence** describes how the behaviour of systems emerges – often unpredictably – from the interaction of the parts, such that the whole is different to the sum of the parts.

Complexity and change: The next four concepts relate to phenomena through which complexity manifests itself:

4. Within complex systems, relationships between dimensions are frequently **nonlinear**, i.e., when change happens, it is frequently disproportionate and unpredictable.
5. **Sensitivity to initial conditions** highlights how small differences in the initial state of a system can lead to massive differences later; butterfly effects and bifurcations are two ways in which complex systems can change drastically over time.
6. **Phase space** helps to build a picture of the dimensions of a system, and how they change over time. This enables understanding of how systems move and evolve over time.
7. **Chaos and edge of chaos** describe the order underlying the seemingly random behaviours exhibited by certain complex systems.

Complexity and agency: The final three concepts relate to the notion of adaptive agents, and how their behaviours are manifested in complex systems:

8. **Adaptive agents** react to the system and to each other, leading to a number of phenomena.
9. **Self-organisation** characterises a particular form of emergent property that can occur in systems of adaptive agents.
10. **Co-evolution** describes how, within a system of adaptive agents, co-evolution occurs, such that the overall system and the agents within it evolve together, or co-evolve, over time.

Each of these concepts is described in more detail in the remainder of this chapter. We have illustrated the concepts with pertinent examples from social, economic and political spheres, wherever possible drawing specifically from development and humanitarian work.

3.2 Complexity and systems

Complexity sciences look at the phenomena that arise in systems of interconnected and interdependent elements and multiple dimensions (Concept 1). Both positive and negative feedback processes take place (Concept 2), acting to dampen or amplify change; emergent properties (Concept 3) result from the interactions of the elements, but these are not properties of the individual elements themselves.

These first three concepts help to clarify aspects of **systems** that are complex, drawing on applications from social, economic and political life. These are features by which complexity in a given system can be recognised.

Concept 1: Interconnected and interdependent elements and dimensions

‘... complexity is built on ... interconnections between the simple parts that make up a complex system’ (Gribbin, 2004).

‘... the word “complexity” comes from the Latin *complexus*, meaning braided or entwined together’ (Gell-Mann, 1996).

Outline of the concept

The starting point in understanding complexity science is the idea of a complex system. All systems are made up of elements and processes that make up a whole. A complex system is one made up of multiple elements (which may be elements or processes) which are **connected** to and **interdependent** on each other and their environment (Nicolis and Prigogine, 1989). Complex systems are also characterised by multiple variables, or dimensions, which are interconnected and interdependent. Complex systems frequently have multiple levels of organisation. The degree of connectivity between these elements, dimensions and levels has a profound influence on how change happens within the broader system.

Detailed explanation

Interconnectedness may occur between individual elements of a system, between sub-systems, among systems, between different levels of a system, between systems and environments, between ideas, between actions, and between intentions and actions (Weick, 1976). This interconnectedness leads to **interdependence** between the elements and the dimensions of a system, and gives rise to complex behaviour. Stuart Kauffman of the Santa Fe Institute has developed a formal framework called Boolean Networks (Kauffman, 1996), which shows that at the heart of all complexity phenomena there is a network of elements and dimensions. The number and nature of connections between elements was proved to be a crucial feature that determined the behaviour of the overall system.

The relationship between interconnectedness, interdependence and complexity is simply and powerfully illustrated with reference to the metaphor of a sandpile (following Bak and Tang, 1989). Imagine dropping sand, a grain at a time, onto a flat surface. Eventually, a pile will start to form; as further grains are dropped, a pyramid of sand grains will form. During formation of the sandpile, grains will land so as to touch other grains in a way that forms stable interactions within the pile, leading to increases in the size of the pile. As more grains are added, different parts of the pile will become increasingly complex, owing to the increased connectivity between grains in different areas. Some grains will be positioned in such a way that, if hit by other grains, they will move with minimal disturbance of the surrounding grains. The vast majority of the sand grains will be loosely connected with the other grains. By contrast, there may be some very highly connected grains, whose influence is wider, but these will be far less common. The pile evolves naturally to a condition in which a single grain has the potential to trigger a domino-like reaction of tumbling grains that can sweep through the entire pile.

As the sandpile continues to build, avalanches will start to occur. Given the above, it should not be surprising that there will be a greater frequency of small avalanches and a smaller number of large avalanches.¹ What makes one avalanche much larger than another has nothing to do with its original cause, and nothing to do with some special situation present in the pile just before the avalanche

¹ This is an example of a ‘power law’, according to which the frequency of events of a certain size – from sand grain avalanches to wars to stock market crashes – reduces as the size of the event increases. Each time the size of an avalanche is doubled, it becomes twice as rare. In addition, this experiment demonstrates how even the largest events have no special or exceptional causes – every avalanche, large or small, is caused by falling grains which makes the pile just slightly too steep at one point.

starts. Rather, it has to do with the perpetually unstable organisation of the critical state, which makes it always possible for the next grain to trigger an avalanche of any size. Of course, the sandpile is a rather static and small-scale example – in the real world, events both inside and outside the system can cause radically different outcomes (Gribbin, 2004).

Degrees of interconnectedness and interdependence are therefore central to understanding complex systems. Degrees of connectivity can vary across different parts of a system, over time in a system, and – obviously – across different systems. High degrees of connectivity and interdependence in a system mean that a change in elements, dimensions and the relationships within and between them can lead to further changes in other parts of the system (Casti, 1998). Charles Perrow's work illustrates dramatically the implications of connectedness for interdependence by distinguishing between accidents that occur in **tightly coupled** systems and in **loosely coupled** systems (Perrow, 1999, cited in Urry, 2003). In tightly coupled systems, relatively trivial changes in one element or dimension can spread rapidly and unpredictably through the system and have dramatic and unpredictable effects. A good example is provided in the following description of world foreign exchange markets:

'... the system [is] now tightly interdependent so that microeconomic responses can easily escalate into macroeconomic contagion ... when China gets a cold, the US ... sneeze[s]' (Urry, 2003).

Relating this to the sandpile, the longer a critical state builds up in an economy, the greater the potential for a serious 'avalanche'. For example, mortgage mis-selling resulting in defaults in the US sub-prime mortgage market leading to massive impacts on the global economy represent a vivid and very real demonstration of this effect. The entire global financial market is connected, and instability at the lower end of the US housing market is having a profound – and, at time of writing, still unpredictable – effect on the economies of countries all around the world.

Those systems where elements are not tightly linked or interdependent with many other components are called loosely coupled systems. In these systems, elements influence each other over longer timeframes, and in more diffuse and subtle ways. An influential example of loose coupling is to be found in the work of Karl Weick, which looked at the US educational system:

'... [educational] systems are responsive but... [connections may play out] infrequent, weak in their mutual effects, unimportant [and] slow to respond ...' (Weick 1976).

The coupling of the system has an effect on its adaptability to the environment and its potential to survive, and therefore defines its fitness. Complexity science proposes an interesting perspective on the fitness of organisations and sectors based on the tradeoffs of loose or tight coupling. Loosely coupled systems may contain certain problems owing to their lack of connectivity. However, there are also benefits, in that the elements in such a system have more independence than in tightly coupled systems because, almost by definition, they can maintain their equilibrium or stability even when other parts of the system are affected by a change in the environment. This builds the resilience of the system, an idea that will be covered in more detail in Concept 8 on adaptive agents. The components of loosely coupled systems may also be better at responding to local changes in the environment, since any change they make at the local level does not require the whole system to respond.

The dimensions of a system are also important to consider. For example, any country can be seen as a system made up of a number of interconnected elements and levels, from cities, towns, villages and communities all the way to individual citizens. In addition, human societies have social, cultural, physical, technical, economic and political dimensions (Mittleton-Kelly, 2003), all of which are intricately intertwined. The degree of connectivity between these elements and dimensions has a crucial impact on how change happens within a given country.

The previous example highlights the fact that complex systems are also frequently made up of nested hierarchies or levels. These are unlike hierarchies in organisations, which are linked to authority and

status; instead, these relate to sub-systems within an overall system – or hierarchies of scale. For instance, individuals are parts of families, which are parts of neighbourhoods or villages, which in turn make up larger communities and so on. This means that an initiative, such as improving public hygiene, taken on any given scale – say a neighbourhood – has implications for other higher and lower levels of the same system – for example, citywide water supply infrastructures *and* individual family behaviour (Waltner-Toews, 1999). In addition, where there is a high degree of interconnectivity and interdependence, different elements and dimensions at different levels of a system can feed back into each other, constraining, driving and influencing changes at other levels. Holland (2000) uses the example of the discovery of ‘pressure fronts’ that drive the daily weather to illustrate the importance of looking for interlocking mechanisms that shape complex systems at different scales and levels of detail.

This interconnectedness and interdependence of elements and dimensions of a complex system questions the traditional social and political science approach of identifying cause and effect relationships and generating hypotheses about dependent and independent variables, thus explaining the nature of a range of phenomena (Homer-Dixon, 1995).² The complexity of real world systems is not always recognised and acknowledged. This has been highlighted by the work of Russell Ackoff (1974), who suggests three different kinds of problems faced by scientists and policy makers, and ways of dealing with them.

The first level, **messes**, relates to systems or issues that do not have a well defined form or structure. There is often not a clear understanding of the problem faced in such systems. Such systems often involve economic, technological, ethical and political issues. Ackoff suggests that all of the really important issues in the world start out as messes. For example, how will rising HIV/AIDS incidence in China be dealt with? This concerns money, technology, ethics, social relations, politics, gender relations, poverty, and all of these dimensions need to be dealt with simultaneously, and as a whole.

The next level is **problems**, which are systems that do have a form or structure, in that their dimensions and variables are known. The interaction of dimensions may also be understood, even if only partially. In such systems, there is no single clear cut way of doing things – there are many alternative solutions, depending on the constraints faced. For example, dealing with the sewage system in a particular city may rely on amount of money available, technology, political stance of leaders, climatic conditions, etc.

The final level is a **puzzle**, which is a well defined and well structured problem with a specific solution that can be worked out (Ackoff, 1974).

In much of modern science and policy, Ackoff identified a bias towards ‘puzzle solving’. He argued that the real-world, complex, *messy* nature of systems is frequently not recognised, leading to simple puzzle-based solutions for what are in fact complex messes. As one thinker puts it, one of the greatest mistakes when dealing with a mess is not seeing its dimensions in their entirety, carving off a part, and dealing with this part as if it were a problem and then solving it as if it were a puzzle, all the while ignoring the linkages and connections to other dimensions of the mess (Pidd, 1996).

This habit extends beyond dealing with big global problems, such as climate change, into more everyday and relatively mundane realms. For example, most organisations are more comfortable in a world that is run:

‘... with clockwork precision through a code of rules and consequences ... a predictable world, occasionally shaken by the hand of fate only to return to its meticulous order’ (Sanders, 1998).

Complex systems are far harder to model and analyse, especially when considering social, economic and political phenomena. This carries cost implications – in terms of time, money and skills – that are

² This is also known as the **independent variable** and will be covered in more depth in Concept 4.

far from trivial. However, these need to be balanced with the possibility that when dealing with complex systems, linear cause-and-effect thinking may in fact be useless. More may be learned by trying to understand the **important patterns of interaction and association** across different elements and dimensions (Haynes, 2003). For more on this, see concept 6 on Phase space and attractors.

Example: A loosely coupled industry – global construction

In a study of the global construction industry, individual projects are shown to be tightly coupled systems, owing to the conditions in temporary networks that form to ensure delivery against contracts. The prominent couplings in such contractually driven networks are twofold. There are technical couplings – which occur between technologies, tasks, roles – and authority couplings – which occur between positions, offices, rewards and sanctions and which work to hold the project system together. The project task is to handle the activity interdependence arising when standardised resources are adapted to local conditions by actors. However, these actors strive for independence beyond the scope of individual projects. The tight couplings in the temporary project systems occur within the broader, loosely coupled but permanent, system of construction firms.

Collective adaptations by the firms in the industry have served to provide a means to cope with the tight couplings required in each construction project, whereas the loose couplings provide the slack needed to maintain flexibility. The pattern of tight and loose couplings can be interpreted as a means of coping with the prevailing complexity in construction operations. The combination of the tight couplings in individual projects with the loose couplings in the permanent system makes it possible to come to grips with both uncertainty and interdependence.

Deeper analysis of this reveals that the behaviour of firms differs considerably from what is common in other industries, especially in terms of the absence of inter-firm adaptations. In particular, it appears that the loose couplings in the permanent network together shape the slack that is necessary in order to handle the tight couplings in projects. The focus on individual projects, the use of standardised components, the local adjustments and the multiple roles played by firms allow both for handling complexity in individual projects and for securing economies of scale in manufacturing.

One important conclusion is that ‘the number of possible permutations and combinations of specific places and entities is enormous, even for one product’. The complexity of construction operations and the subsequent problem-solving capability needed is perceived to be formidable. The overall conclusion is thus that the behaviour of the industry seems to be an appropriate response to the inherent complexity of construction projects.

Implication: Assess and deal with the interconnectedness of elements and dimensions

Organisations in the international development and humanitarian sector deal with complexity every day. As one thinker has put it:

‘... the questions [faced by] aid agencies ... are perhaps the most complex and ill-defined questions facing human kind’ (Ellerman, cited in Roper and Pettit, 2002).

Why might this be the case? From the perspective of a complex system, there are many connections and interactions within the various dimensions of economic and social development, such as between education and the economy, between health and poverty, between poverty and vulnerability to disasters, between growth and environment – the list is literally endless. International aid to address these issues takes place in the context of a dense and globalised web of connections and relationships between individuals, communities, institutions, nations and groups of nations. Interactions among the various elements of these different systems are themselves complex and multifaceted. Aid relations run alongside many other kinds of international relations: military and security relations, relations of economic cooperation and trade competition. Naturally, these wider relationships have an effect – often a profound one – on the aid-related relationships that exist between countries.

If that were not enough, every aid agency operates in a global aid system which is itself characterised by a huge number interacting systems, each of which is made up of multiple parts (Martens, 2005). There are a bewildering number of different relationships and interactions between bilateral aid agencies and multilateral agencies, between multilaterals and country governments, between aid agencies and communities, among neighbouring communities, between NGOs and governments, and among an increasing number of ‘non-traditional’ development actors such as the media, diaspora communities and the military. Figure 1 conveys some of this complexity by illustrating the principal routes of resource flows within the humanitarian aid system.

Given the above, perhaps the primary implication of seeing international aid through a complexity lens is that aid agencies need to be very careful not to oversimplify the systems being dealt with, whether talking about the developing countries in which they operate to reduce poverty and alleviate suffering, or dealing with the international aid system itself. For example, research has illustrated that, at the heart of many disasters, there are seldom single causes but instead many interacting and interdependent dimensions and factors (Buckle, 2005). Famine can be caused by drought, a rise in the price of grain, a drop in the price of livestock, inadequate road infrastructure, a lack of food aid, or by all these factors simultaneously (Pirrotte et al., 1999). Despite this level of complexity, a bias towards and reliance on simplistic models pervades the aid system. For example, a study on drought-related work in the Sahel identifies that many analyses tend to divide causes into immediate and structural factors, with the structural issues largely ignored in agency responses (Sahel Working Group, 2007).

Figure 1: The complexity of aid flows in crises

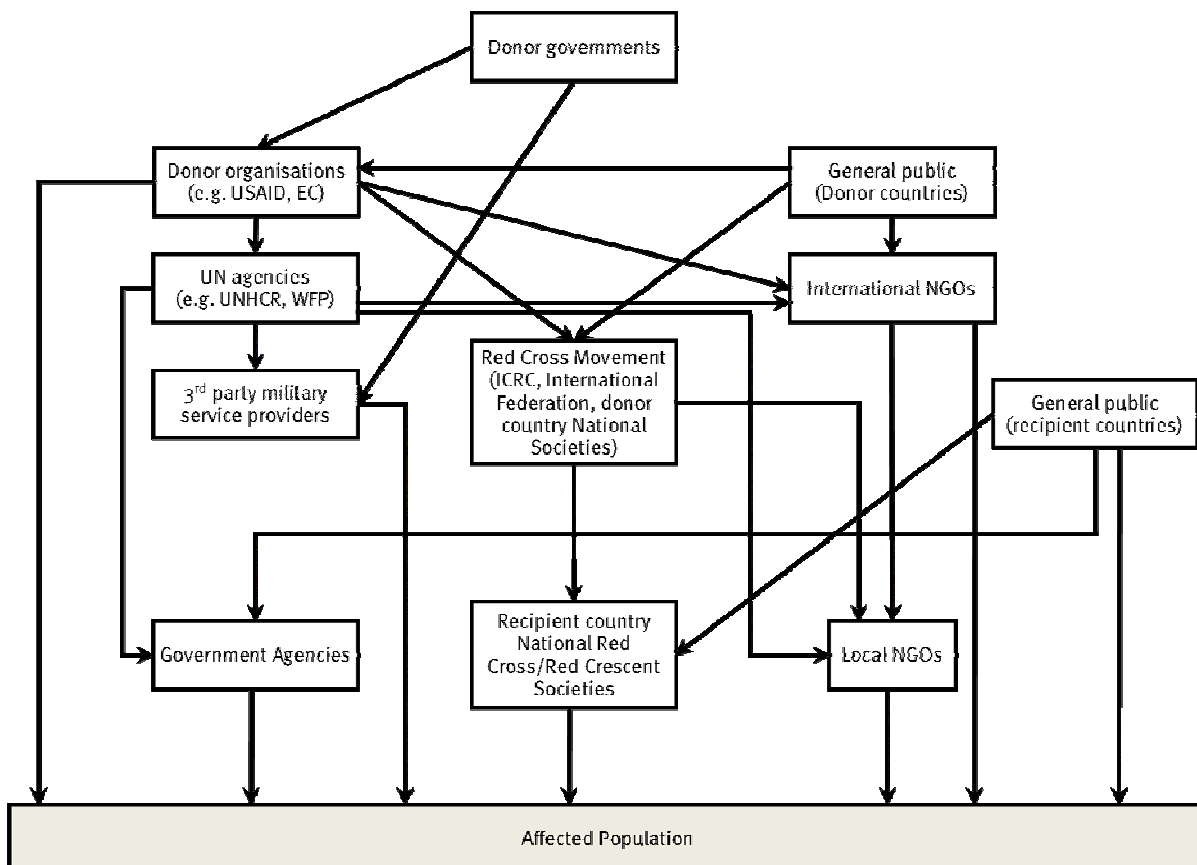

Source: <http://www.oecd.org/dataoecd/9/50/2667294.pdf>.

The argument for a more holistic approach to problems has also been made on the developmental side of the aid system, among thinkers who argue that the ‘multidimensionality of poverty’ would be better recognised by those designing and evaluating development interventions. The starting point is that a large number of factors that lead to poverty need to be considered in development work. These

dimensions include income consumption poverty, deprivation of capabilities linked to health, education, mortality, under-nourishment, illiteracy and participation in the activities of society, which involves freedom, social inclusion, employment, dignity and human rights (Sen, 1999). These dimensions relate and interact in a dynamic fashion such that, when attempting to address the problem of 'poverty', it may not be possible to deal with each dimension in isolation, or to quantify the effects of an intervention in terms of direct 'impact' on the targeted 'dimension'. The implications of complexity for targets is covered in more detail in Concept 10 – at this stage it is important to note that there are inherent dangers that overly focusing on one dimension may pave the way for indirect effects to produce negative trends in the others.

Different perspectives on what the system is also need to be taken into account. Those who are being affected by aid initiatives need to be part of the process of identifying the important elements of the relevant system, as well as defining the problems and their solutions (Funtowicz and Ravetz, 1994; Röling and Wagemakers, 1998). As there are many perspectives on how to understand the complex social, economic and political contexts of aid work, it is important to bring together as many of these as possible in order to gain a rich picture of constraints and opportunities. This means that the practical, social and institutional dimensions should be of as much concern to aid agencies as the scientific and scholarly concerns. If development and humanitarian work is to incorporate properly the concept of a system of interconnected and interrelated elements, dimensions and levels, it may be that both qualitative and quantitative data should be used to gain insight into phenomena – no mean task – and that the task of *selection* and *synthesis* becomes as important as analysis (Haynes, 2003).

This will require learning to distinguish between messes, problems and puzzles, and being clear about the kinds of problems that can be handled with what might be termed 'conventional' perspectives, where precise prediction and solution is possible, and the kinds of problems associated with unavoidable complexity, where different kinds of approaches may be needed (Buchanan, 2004). As has already been suggested, explanations of phenomena based on linear cause and effect are often not viable in systems that consist of numerous interdependent relationships. This means that approaches that have more in common with historical research may prove useful. Instead of asking questions such as 'did x cause y ?', these methods acknowledge the complexity of the real world, asking 'what happened and why?', thereby moving towards building narratives about events and processes (OECD, 1999).

This casts the notion of optimal ignorance and appropriate imprecision, developed in participatory methods, in a new and useful light. Optimal ignorance means getting only the information that is really needed and no more, and appropriate imprecision means that a certain level of inaccuracy needs to be accepted in any analysis. In light of the idea of messes, problems and puzzles, it is arguable that both of these concepts are based on the idea of a puzzle or a problem, rather than a mess. What is meant by 'optimal' and 'appropriate' is crucially dependent on the interconnectedness and interdependence of the systems in question. The nature of the interconnectivity and interdependence within a given system carries interesting implications for the aid system, which appears to be both loosely coupled in some respects and tightly coupled in others. There may be aspects of the system that are extremely tightly coupled in relation to a particular issue – for example, the influence of changes in donor policy on implementing agency practices highlights a high degree of interdependence and coupling between the attitudes of donors and implementing agencies. The knowledge that, in this tightly coupled context, changes can occur in a dynamic fashion may be one explanation for increasing risk-averse behaviours within international agencies.

On the other hand, there may be continued difficulties in dealing with aspects of the aid system that are loosely coupled, and where there is less interdependence between the elements that are involved. For example, partnerships and coordination between otherwise autonomous agencies, learning attempting to link up decentralised country offices within agencies, or initiatives to allow greater involvement of recipients in aid programme design are all characterised by loose coupling. This last example is a particular problem for the legitimacy of aid agencies. As one recent review of international aid put it:

‘... improving the welfare of beneficiaries is the ultimate goal of aid agencies ... [but] links between beneficiaries and a donor are weak to non-existent ... Many activities do not focus on beneficiaries as much as on policy goals’ (Gibson et al., 2005).

In these areas, systematic change initiatives may continue to be frustrated because of the limited scope for planned actions to change loosely coupled parts of systems.

It is important to note that different modes of thinking may not be easy to integrate into aid agencies processes. As the UN Secretary-General recently wrote about the conflict in Darfur:

‘Almost invariably, we discuss Darfur in a *convenient* military and political shorthand – an ethnic conflict pitting Arab militias against black rebels and farmers. Look to its roots, though, and you discover a more complex dynamic’ (Ki-Moon, 2007, emphasis added).

If it is ‘convenient’ to try and solve real world problems as if they were merely isolated problems, rather than interconnected and part of a longer-term process, what kind of convenience are we talking about? Is it analytical, institutional, political, or a combination of all three? Whatever the answer, this perspective implies that it may be unlikely that international aid agencies will be able to incorporate a more holistic, complexity-oriented understanding of the delivery of assistance in the near future.

Concept 2: Feedback processes promote and inhibit change within systems

‘... feedbacks are central to the way systems behave. A change in an element or relationship often alters others, which in turn affect the original one’ (Jervis, 1997).

Outline of the concept

Feedback, as illustrated in the quote above, is at the heart of phrases such as ‘vicious circles’ or ‘self-fulfilling prophecies’ and, in this broad sense, can be described as an influence or message that conveys information about the outcome of a process or activity back to its source (Capra, 1996). At its most basic, feedback can be amplifying, or positive, such that a change in a particular direction or of a particular kind leads to reinforcing pressures which lead to escalating change in the system (Jervis, 1997; Maruyama, 1968). Feedback can also be damping, or negative, such that the change triggers forces that counteract the initial change and return the system to the starting position, thereby tending to decrease deviation in the system.

Although feedback plays out in very distinctive ways in complex systems, the basic principles are the same as in simpler systems. The major differences relate to how feedback is treated – in simpler systems, feedback may be linear, predictable and consistent. In complex systems, as Byrne suggests (1998), feedback is about the consequences of nonlinear, random change over time.

Detailed explanation

In simple systems, the dynamics and information flows around the system are referred to as feedback loops. This is usually represented mechanically, as shown in the typical example of a feedback system in Figure 2 below. Input into a system results in an output which feeds back into the system again, potentially adjusting the inputs.

In such systems, where outputs are predictable and determined, feedback is often associated with controlling the system. A common metaphor is of a bath filling up (Meadows, 1999), in which both the taps and the plug enable feedback to control the system. Another common example is of a heater and a thermostat.

Figure 2: Example of a feedback system

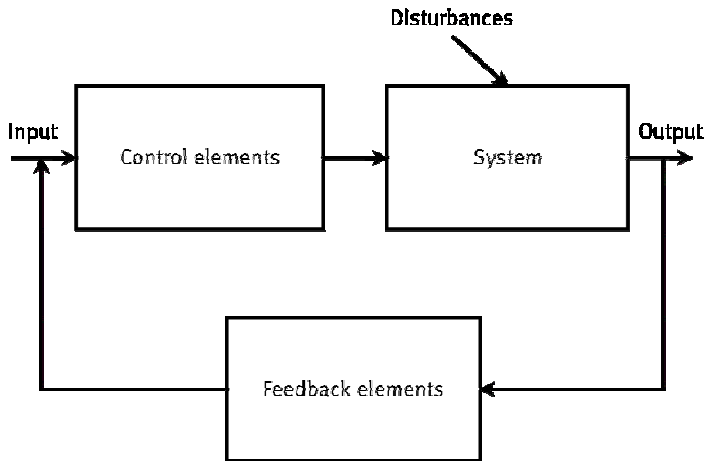

Source: Schueler and Schueler (2001).

Although feedback in complex systems is distinct from that in more simple systems, the basic principles are the same. Simply put, feedback can be amplifying, or positive, such that a change in a particular direction or of a particular kind leads to reinforcing pressures which lead to escalating change in the system (Jervis, 1997; Maruyama, 1968). Feedback can also be damping, or negative, such that the change triggers forces that counteract the initial change and return the system to the starting position, thereby tending to decrease deviation in the system. Negative feedback is associated with the concept of homeostasis, which will be addressed in Concept 10.

Mittleton-Kelly (2003) provides a useful qualification by suggesting that it is feedback **processes**, rather than feedback **loops**, that are to be found in complex systems. For example, like any complex system, the Earth's climate has many feedback processes. Some of these amplify and reinforce an underlying trend and so destabilise the climate, moving it in new directions. Other feedbacks are fundamentally stabilising, in that they counteract the original change and return the climate to equilibrium. Scientists do not understand many of the principal feedbacks in the Earth's climate but are most concerned with the positive feedback that could drive climate to a higher temperature or even produce a runaway greenhouse effect. Events in the Arctic show how this could happen – open water left by the Arctic ice melting is much darker and absorbs about 80% more solar energy than ice, which makes the waters warmer, melting ice and leading to more 'dark' water – this could change the energy balance of the entire Northern hemisphere. Simultaneously, northern boreal forests will die as the Arctic warms, releasing more carbon into the atmosphere. And the 2,500 cubic kilometres of peat under the tundra of Siberia, Alaska and Canada would release vast amounts of methane into the atmosphere. Climate scientists have also identified some counterbalancing negative feedback processes – the newly melted Arctic may absorb more carbon dioxide. There is fierce debate about the relative influence of positive and negative feedbacks, but in recent years the evidence is mounting that dangerous positive feedbacks are outweighing negative ones (Homer-Dixon, 2005).

Work on the international food system has highlighted that feedback may also be **masked** or **disregarded** (Sundkvist et al., 2005). Because of the distances between the use of resources and the environmental consequences – both in times of geography and time – feedback signals are not perceived or are difficult to correlate to consumer choices and management practices. Such feedback might occur at a scale where the information cannot be detected or transferred – masked feedback – or is not acted upon despite the fact that it is perceived (disregarded feedback). Feedback relationships that are not functioning properly can have serious implications for the food system and life-supporting ecosystems. While unmasking masked feedback is often a question of deepening the understanding of

ecosystem functioning through scale-relevant monitoring and institutions, coping with disregarded feedback is a matter of enhanced communication between actors in the food system.

In simple systems, feedback operates in a relatively straightforward and predictable fashion. In complex systems, by contrast, feedback **processes** occur when there is change among any of the elements or dimensions of a system, which then have a dynamic influence on other elements or dimensions. This has clear relationships with the degree of connectivity of the system, as outlined in Concept 1. Meadows takes the bath tub metaphor mentioned earlier and skilfully uses it to illustrate feedback in complex systems:

‘... mentally turn the bath tub into a [bank] account. Write checks, make deposits, add a faucet that keeps dribbling in a little interest ...’

This creates a simple predictable system of stocks and flows. Meadows continues:

‘... attach your bank account to thousands of others and let the bank create loans as a result of your combined and fluctuating deposits. Link a thousand of those banks into a federal reserve system ... Simple, predictable stocks and flows, plumbed together, make up a system [that is] complex’ (Meadows, 1999).

In such a system, changes in the elements and dimensions mutually feed back to each other in a continually dynamic manner (Haynes, 2003). Any change in a particular element or dimension has an influence on others in the system, causing further changes around the system (Capra, 1996). In more complex systems, several interacting feedback processes mean that changes in some directions are amplified while changes in other directions are suppressed (other distinctions made between complexity science and systems thinking, some of which were outlined in Box 1 on page 5).

The word ‘tends’ is often used in the context of feedback processes in complex systems, as other factors may also influence the change or deviation. A rather more prosaic example than the previous one on global climate change can be drawn from the situation of facilitating meetings. Consider a situation where a particular topic is under discussion, and a particular participant suggests broadening the conversation to cover other areas. Such a deviation may tend to make the discussion facilitator steer the discussion back to the original topic, which returns the overall discussion to the planned agenda. Fellow participants may wish to go in the new direction suggested, or the facilitator may not feel confident to speak against the suggestion, both of which would work against the tendency.³

This can lead to very complicated and difficult-to-predict behaviour (Heylighen, 2001). Work by IDRC on the ecosystem approach highlights some of the broader implications of these issues in social settings:⁴

‘An enforced policy on low-pollution transportation could within a few years result in cleaner air, less respiratory disease, healthier people who walk more – as well as the loss of income from motor-related activities and a change in the physical structure of the cities and in structure of the national economy. Building a road may increase access of poor villagers to markets (increasing income), but also result in restructuring of the landscape and the local economy in ways that ultimately drive the farmers from the land. The exact outcome cannot be predicted’ (Waltner-Toews, 1999).

Example: UK political debates and feedback

UK political engagement with the complex factors behind the EU illustrates aspects of feedback in public debates (Haynes, 2003). In the build-up to the 2001 election, the New Labour agenda was to create positive feedback around the Euro issue leading to change, whereas the more sceptical

³ For more on how complexity can be applied to facilitation, see Robert Chambers on self-organising systems on the edge of chaos (SOSOTEC) (Chambers, 1997; 2002).

⁴ The ecosystem approach is perhaps the area of aid work which has seen the greatest and most systematic application of complexity science. See the journal of the International Society of Ecological Economics for more details: www.ecologicaleconomics.org

Conservative party attempted to reinforce negative feedback, inhibiting change. Specifically, a number of key variables were identified by both sides, and the relationship between them was highlighted in order to support their separate arguments (see Figure 3).

At the same time as trying to maintain their preferred set of relationships in the minds of the public, the parties had to deal with wider issues such as the movement of the Euro on currency markets and public reactions in other countries. Figure 3 illustrates how the debate on the Conservative side created a set of assumptions that were geared towards minimising change (the left-hand side of the figure), whereas New Labour was working towards amplifying change (the right-hand side).

Figure 3: Key variables and relationships between them in the Euro debate

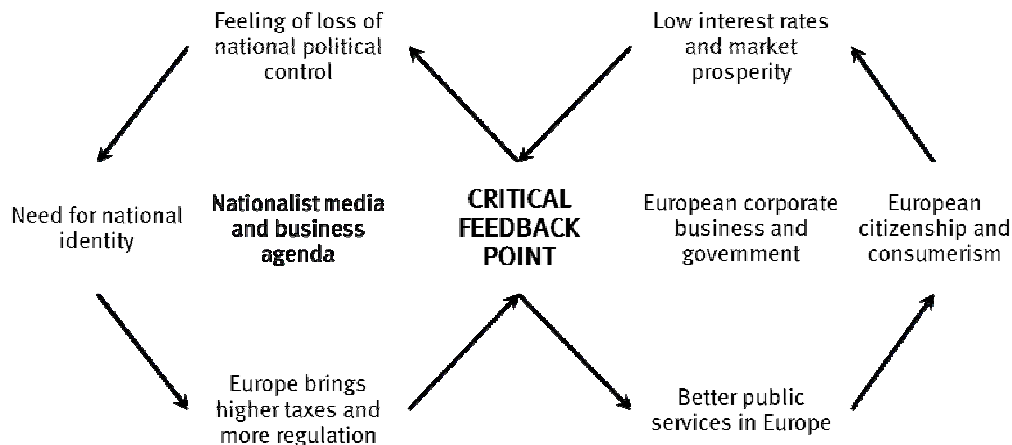

Source: Haynes (2003).

The complexity and combination of these feedback processes highlight the dynamic interaction of multiple issues, which made it hard to disentangle one issue from the other, creating unpredictability in the overall circumstances.

Implication: Identify and work with the positive, negative, masked and disregarded feedback processes that foster and inhibit change

In order to better understand how feedback plays out in the international aid system, it is important to pay careful attention to areas where change has not happened despite continual pressure, and to areas where there has been considerable change. It is useful to assess how negative and positive feedback plays out over time in the context of the relationships embedded in the international development system between the various communities, institutions, countries, etc. There is also feedback that plays out between different dimensions of the development, and between different dimensions and specific elements.

Incorporating feedback can have dramatic effects on models of complex systems. For example, the Stern Review highlights that the cost of climate change over the next two centuries will be equivalent to a loss of at least 5% of global per capita consumption in perpetuity. However, scientific evidence has highlighted a number of important feedback loops, whereby rising temperatures could lead to further increases in greenhouse gases through the release of carbon dioxide from soils and methane from permafrost, thereby boosting the global temperature response to greenhouse gas emissions. When Stern's analysis incorporates these known feedback loops, the total average cost rises from 5% to 14.4% of global per capita consumption (HM Treasury, 2006). In complex systems, positive feedback can make deviations grow in a runaway, explosive manner, leading to accelerating changes and potentially a radically different configuration for the system (Heylighen, 2001).

The notion of feedback can help to better understand an increasing range of phenomena being faced by international agencies. For example, beyond its economic effects, climate change is also seen as

contributing to the rise in disasters. Much of this thinking suggests that disasters are discrete phenomena that are external to the social or environmental systems upon which they impinge. According to this approach, disasters and society are related to one another in a linear, cause and effect manner. However, in reality, growing population, migration of population to coasts and to cities, increased economic and technological interdependence, and increased environmental degradation are just a few of the factors that feedback into each other and underlie the increase in disasters (Red Cross, 1999; CRED, 2001). Feedback suggests that there is a different way to view disasters: not as isolated phenomena, but as the result of escalating positive feedback within or between complex, dynamic systems.

‘Consider the following three ingredients: a mega-city in a poor, Pacific rim nation; seasonal monsoon rains; a huge garbage dump. Mix these ingredients in the following way: move impoverished people to the dump, where they build shanty towns and scavenge for a living in the mountain of garbage; saturate the dump with changing monsoon rain patterns; collapse the weakened slopes of garbage and send debris flows to inundate the shanty towns. That particular disaster, which took place outside of Manila in July 2000, and in which over 200 people died ... starkly illustrates the central point that disasters are characterised and created by context. The disaster was not inherent in any of the three ingredients of that tragedy; it emerged from their interaction’ (Sarewitz and Pielke, 2001).

In many parts of any economy, there are positive feedback processes at play, which magnify the effect of small economic shifts. Once economic forces select a particular path, they may become locked in, regardless of the advantages of other paths. If one product or nation in a competitive marketplace gets ahead, it tends to stay ahead and even increase its lead. This concept, known to economists as path dependence, will be explored in more depth later, in Concept 5. By contrast, Arthur’s work (1990, among others) on feedback and economics argues that conventional economic theory – with its focus on diminishing returns – overemphasises negative feedback. Specifically, economic actions eventually lead to negative feedback loops which, in turn, lead to a predictable equilibrium for prices and market shares. According to conventional theory, the equilibrium marks the ‘best’ outcome possible under the circumstances: the most efficient use and allocation of resources. Negative feedback in this sense tends to stabilise the economy, because any major changes will be offset by the very reactions they generate.

In order to illustrate the implications of positive and negative feedback in the aid world, it is worth drawing on the work of a leading analyst (Killick, 2005) who suggests that there have been major movements in almost all dimensions of British aid policies to Africa in the past four decades. To cite a few examples, the department responsible has shrunk and grown, there have been changes in the influence of commercial motives, there have been changes in the real value of aid, there have been changes owing to lessons learned, there have been changes away from growth towards poverty reduction, and so on. Importantly, Killick also suggests that it is ‘almost inevitable’ that changes at ground level have been less dramatic than those at head office and policy levels.

Applying the concept of feedback would imply that the feedback processes at the head office and policy level are more likely to be amplifying and more change-enabling than those surrounding the work of agencies in developing countries, where there may be some degree of homeostasis and where negative feedback processes that inhibit change may prevail. Moreover, the international aid system may be characterised by both masked and disregarded feedback. The sheer size and scope of the system, and the loose coupling that occurs between the different elements, may mask many aspects of the system. Furthermore, the political dimensions within which aid is embedded may also lead to disregarding feedback as to the actual effects of aid.

An approach for furthering such understanding, Drivers of Change, has been developed within DFID (Booth et al., 2006). This approach was motivated by the fact that donor organisations frequently explained away the failure of their programmes by pointing to a lack of political will for change among aid recipients, without examining the underlying reasons for this lack of the will. Drivers of Change was developed as a learning exercise to enable a better appreciation of the interlocking causes that make

progressive change so difficult in some of the poorest developing countries. This includes assessments of the ways in which the efforts of donor organisations can become part of the problem rather than a source of solutions. The exercise enables an approach to aid policy that focuses on how the complex interaction between economic, social and political factors can variously enable and inhibit change.

The above suggests there needs to be more attention within development agencies to how strategies for change address broader dynamics of feedback, positive and negative. Of particular importance is the fact that feedback processes do not always produce the same effects and are not predictable. In addition, because such complex feedback loops have both positive and negative effects, different people will look at the same situation and evaluate it differently. Where one sees the excitement of economic activity, another sees deforestation; where one sees disease control by draining swamps, another sees loss of wildlife and clean water provided by the filtering effects of wetlands; where one sees more robust housing provision through metal roofing, another sees increased costs and less comfortable houses. As such, international aid should be seen as part of broader, often unpredictable, processes of feedback, which play out differently at local levels. An ODI study summarises these issues succinctly in the context of the dependency of disaster-affected populations on humanitarian relief:

‘Rather than seeing dependency on relief as necessarily negative, we should be trying to understand the role that relief plays in the complex web of interdependencies that make up livelihoods under stress in crises. The many interdependencies that comprise a community’s social relations and people’s livelihoods may have both positive and negative aspects ... external aid influences these existing patterns of social relations and, if it continues over a prolonged period, it may become embedded within them’ (Harvey and Lind, 2005).

Concept 3: System characteristics and behaviours emerge from simple rules of interaction

‘... From the interaction of the individual components ... emerges some kind of property ... something you couldn’t have predicted from what you know of the component parts ... And the global property, emergent behaviour, feeds back to influence the behaviours of the individuals that produced it’ (Langton, cited in Urry, 2003).

Outline of the concept

At its simplest, emergence describes how:

‘... a [complex] system emerges from the interactions of individual units ... The units ... are driven by local rules... and are not globally coordinated’ (Marion, 1999).

Emergent properties are often used to distinguish complex systems from applications that are merely complicated. They can be thought of as unexpected behaviours that stem from basic rules which govern the interaction between the elements of a system.

Detailed explanation

Many patterns and properties of a complex system emerge from the interrelations and interaction of component parts or elements of the system. These can be difficult to predict or understand by separately analysing various ‘causes’ and ‘effects’, or by looking just at the behaviour of the system’s component parts. They are known as emergent properties, and they form an important element in the defining concepts of complex systems. This concept of emergent properties is far from being a new one in social, economic and political thinking. As one writer has it:

‘It has been held that order in market systems is spontaneous or emergent: it is the result of “human action and not the execution of human design”. This early observation, well known also from the Adam Smith metaphor of the invisible hand, premises a disjunction between system wide outcomes and the design capabilities of individuals at a micro level and the distinct absence of an external organizing force’ (Markose, 2004).

Work at the University of Strathclyde has established that structure, processes, functions, memory, measurement, creativity, novelty and meaning can all be identified as emergent properties in complex systems. The researchers involved have used this to develop a useful classification of the kinds of emergence that occur in complex systems (McDonald and Weir, 2006). Emergence describes how overall properties of a complex system emerge from interconnections and interaction. While the nature of the entities, interactions and environment of a system are key contributors to emergence, there is no simple relationship between them. Emergence has been used to describe features such as social structure, human personalities, the internet, consciousness and even life itself. As one lucid account has it (Newell, 2002):

“...metaphors [are] useful. The music created by an orchestra may be envisaged as an emergent phenomenon that is a result of the dynamic, temporal interactions of many musicians at a point in time... the process that is the music may alter a listeners actions or behaviours in the real world... this viewpoint supports the proposition that complex systems, such as people, have multiple emergent levels, each level generating phenomena that is more than the sum of the parts and is not reducible to the parts...” (Newell, 2003)

Emergence, then, describes how a system emerges from the interactions of individual units driven by local rules (Marion, 1999). The dynamic feedback between the parts crucially shapes and changes the whole (Haynes, 2003). One of the most widely cited examples of computerised emergence is the boids application, developed by Craig Reynolds (cited in Chambers, 1997). This visual tool shows how models of flocking birds can be created by programming visuals on a screen using three basic rules: separation of flight path from that of local boids, alignment of steering with the average direction of the local flock, and cohesion to move towards the average position of the local flock. Perhaps the best known example of organisational emergence is that which is promoted within US marine operations which, like the boids, have a set of three rules that govern military behaviour in complex and unpredictable environments. These are: 1) capture the high ground; 2) stay in touch; and 3) keep moving. This enables maximum adaptive behaviours in the context of operational work. It is also worth noting that the internet embodies emergent properties on a grand scale. As Plant puts it:

‘... no central hub or command structure has constructed it ... It has installed none of the hardware on which it works, simply hitching a largely free ride on existing computers, networks, switching systems, telephone lines ... [it] presents itself as a multiplicitous, bottom-up, piecemeal, self-organising network which could be seen to be emerging without any centralized control’ (Plant, cited in Urry, 2003).

But you do not have to look to the computer world to find examples of emergence. Adam Smith’s ‘invisible hand’ is perhaps the best known and most frequently cited example of emergent properties, as seen above, and is at the heart of economic thinking. Similarly, the alternative globalisation movement that has arisen in global civil society has the ‘emergent properties of acting in a decentralised, participatory, and highly democratic manner’ (Chesters, 2004). As with the web, this is the product of interactions among various parts of civil society, and is not implemented as part of some overall ‘plan’.

Overall, the principles of emergence mean that over-controlling approaches will not work well within complex systems – that in order to maximise system adaptiveness, there must be space for innovation and novelty to occur. While this may be obvious, this is often the reverse of what happens in the real world, because of a tendency to over-define and over-control rather than simply focus on the critical rules that need to be specified and followed (Morgan, 1986).

Example: public sector accountability as an emergent property of a complex system

Work by researchers at the University of Kentucky (O’Connell, 2005) uses the term ‘accountability environment’ to capture the emergent nature of accountability in public sector organisations. In this approach (consistent with a school of thinking termed *new institutionalism*), public sector organisations are shaped and structured by interactions between themselves and other entities in their organisational ‘field’. Besides the focal organisation, the field includes the external organisations and

social groups that make up the organisation's stakeholders. The constituent parties in a field might include competitors, suppliers, unions, environmentalists, local residents, government regulators, local contractors, customers / clients, with internal management being just one of a number of parties.

Similarly, managers of aid organisations operate in a field that comprises other parties — that is, a program field. Each party in the field can hold the organisation accountable for some particular output. The overall accountability environment is the 'constellation of forces — legal, political, socio-cultural, and economic — that place pressure on organisations and the people who work in them to engage in certain activities and refrain from engaging in others' (O'Connell, 2005, p. 86). Different parties can press for accountability for different concerns. In particular, there are three dimensions of accountability which are of relevance: finances, performance and fairness. A donor might expect an implementing agency to provide a high quality of service (performance) at a lower cost (finance) while serving more citizens in a more equitable manner (fairness).

With these multiple concerns and multiple actors, accountability can be seen as the 'multidimensional product of many forces operating in the accountability environment'. The overall level of accountability — while measurable at times — is not a predictable product of hierarchical relationships and managerial rules. Rather, with multiple actors who have a variety of ties to each other and differing goals, the degree and nature of accountability is best described as an *emergent property* which is a result of the interactions between actors. By implication, to enlarge total accountability, it is necessary to attend to the web of relationships between the parties and to the resources they bring to the setting. That accountability is the emergent result of complex interactions between multiple actors is to be expected. '[I]n today's world no single person, group or organisation has the power to resolve any major public problem; yet at the same time, many people, groups and organisations have a partial responsibility to act on such problems' (O'Connell, 2005, p. 86). It is for this reason that accountability can be seen as an emergent property, and as more than a collection of rules and procedures.

Implication: Approach 'grand designs' with care

Chambers argues in *Whose Reality Counts?* that top-down attempts to manage complex interrelations have not worked in development aid — such efforts have generated 'dependency, resentment, high costs, low morale and actions which cannot be sustained' (Chambers, 1997). The applicability of the emergence concept is seen as having some potential, although it is qualified it as follows:

'... development projects can be paralysed by overloads at their centres of control. But they differ from [computer simulations]. Projects deal with varied environments and idiosyncratic people as independent agents. The simple rules which then work have to go further, allowing and enabling people to manage in many ways with their local, complex, diverse, dynamic and unpredictable conditions, and facilitating not the uniform behaviour of flocks but the diverse behaviour of individuals' (Chambers, 1997).

Examples are provided of a southern Indian NGO that runs savings and credit societies, using only two minimal rules: 1) there is transparent, accurate and honest accounting; and 2) those with special responsibility are democratically elected, regularly rotated and not given honorifics, but called 'representatives'. As Chambers suggests:

'... the key is to minimise central controls, and to pick just those few rules which promote or permit complex, diverse and locally fitting behaviour'.

In fact, looking at the development world, there are some interesting examples of minimum rules used to promote certain kinds of initiatives. For example, the well publicised example of Uganda's 1990s HIV/AIDS campaign (Cohen, 2003), referred to by some as a miracle, is synonymous with the ABC approach to HIV/AIDS prevention. ABC stands for 'Abstain, Be faithful, use Condoms', and refers to the necessary changes in individual behaviours, as well as the programmatic tools and techniques designed to promote these behaviours.

The evidence shows that some combination of important changes in all three of these sexual behaviours contributed both to Uganda's extraordinary reduction in HIV/AIDS rates and to the country's ability to maintain its reduced rates through the second half of the 1990s. This drastic reduction can be seen as an emergent property of implementing the three 'minimum rules'. Subsequently, Western leaders backing the export of the ABC approach elsewhere in Africa, with rather less success (for example in Botswana). A vigorous debate is ongoing around the widespread applicability of this approach to other countries.

This debate highlights an important aspect of dealing with emergence. It may be easy to say that those working in aid organisations who are in the position to determine programmes and projects should define no more than is absolutely necessary to launch a particular initiative, and that the role of grand designer should be avoided in favour of the role of facilitation, orchestration and creating the enabling environment that allows the system to find its own form (Morgan, 1986). However, in specifying the minimum rules, it is crucial to understand the dynamics of local circumstances and actors. As Holland puts it:

'... [emergent properties are global, but] context ... determines their function. It is important to build a perspective on an issue from the point of view of those who live their lives immersed in it' (Holland, 2000).

This heightens the importance of local knowledge and a good understanding of the contexts in which an agent is acting within a complex system. One needs a detailed understanding of the factors and dimensions of the complex social system that affect an area in order to refine one's perspective to see which features are important and which are irrelevant to the context. One must then look to discern the wider patterns that drive these factors. It is quite possible that

'... rules governing [the local context are likely to be] only be partially and inadequately understood by the outside actor' (Holland, 2000).

The case for seeking out, transferring and harnessing knowledge of local actors increases in importance from the perspective of emergent properties.

More generally, the changing demographic, economic and environmental conditions around the world are the dynamic contexts within which aid problems will emerge, be experienced and have to be addressed. This, in combination with the point about local actors, gives a sound theoretical basis for the argument made in the Tsunami Joint Evaluation, the first recommendation of which was to reorient the international aid system towards local actors and affected peoples.

3.3 Complexity and change

The next four concepts relate to different aspects of how complex systems – those characterised by Concepts 1-3 – change over time. The causal relationships that play out within complex systems are explained using the concept of nonlinearity (Concept 4) and the sensitivity of complex systems to their starting conditions is highlighted (Concept 5). The overall shape of the system and its future possibilities are described using the idea of phase space (Concept 6). The patterns underlying seeming chaos within complex systems are explained (Concept 7).

Concept 4: Nonlinearity⁵

‘... the darkest corner of science [is] the realm of non-linear problems’ (Strogatz, 2003).

Outline of the concept

Traditional scientific approaches are based on the idea that linear relationships can be identified through data gathering and analysis, and can be used as the basis of ‘laws’ of behaviour (Byrne, 1998). Such approaches in the physical sciences have informed the development of social, economic and political science, using broad theories of behaviour to generate hypotheses about causal relations between variables of interest (Homer-Dixon, 1995). However, complexity science suggests that human systems do not work in a simple linear fashion. Feedback processes between interconnected elements and dimensions lead to relationships that see change that is dynamic, nonlinear and unpredictable (Stacey, 1996). Nonlinearity is a direct result of the mutual interdependence between dimensions found in complex systems. In such systems, clear causal relations cannot be traced because of multiple influences.

The distinction between linear and nonlinearity is far from trivial. If **dynamic nonlinear feedbacks** in response to rising greenhouse gases are included in the model used in the Stern Review of Climate Change (cited in Concept 2), for example, the total average cost of climate change rises from 5% to at least 20% of global per capita consumption (HM Treasury, 2006).⁶

Detailed explanation

Vast numbers of naturally occurring systems exhibit nonlinearity. As one thinker has dryly suggested (Stanislaw Ulam, in the 1950s), calling a situation nonlinear is like going to the zoo and talking about all the interesting non-elephant animals you can see there (Campbell et al., 1985): there are as many nonlinear situations as there are non-elephant animals.

Linearity describes the proportionality assumed in idealised situations where responses are proportional to forces and causes are proportional to effects (Strogatz, 2003). Linear problems can be broken down into pieces, with each piece analysed separately; finally, all the separate answers can be recombined to give the right answer to the original problem. In a linear system, the whole is exactly equivalent to the sum of the parts. However, linearity is often an approximation of a more complicated reality – most systems only behave linearly if they are close to equilibrium and are not pushed too hard. When a system starts to behave in a nonlinear fashion, ‘all bets are off’ (Strogatz, 2003).

This is not to suggest that nonlinearity is necessarily a dangerous or unwanted aspect of systems. The biology of life itself is dependent on nonlinearity, as are the laws of ecology. Combination therapy for HIV/AIDS using a cocktail of three drugs works precisely because the immune response and viral dynamics are nonlinear – the three drugs taken in combination are much more effective than the sum of the three taken separately.

The nonlinearity concept means that linear assumptions of how social phenomena play out should be questioned. It is important to note that such thinking has only relatively recently been incorporated into the ‘hard’ science paradigms and, moreover, is still only starting to shape thinking in the social, economic and political realms. Nonlinearity poses challenges to analysis precisely because such relationships cannot be taken apart – they have to be examined all at once, as a coherent entity. However, the need to develop such ways of thinking cannot be overstated – as one thinker puts it:

‘... every major unresolved problem in science – from consciousness to cancer to the collective craziness of the economy, is nonlinear’ (Capra, 1996).

⁵ It is important to distinguish nonlinearity as used here, which relates to relationships and proportionality, and nonlinearity in terms of sequences of events – one thing following another.

⁶ Note that the previously cited increase from 5 to 14.4% was due to natural, known feedbacks and does not include non-linear feedbacks

Although nonlinearity is a mathematical formulation, it is useful to take the suggestion that what is required is a ‘qualitative understanding of [the] quantitative’ when attempting to investigate them systematically (Byrne, 1998). Such a qualitative understanding has been furthered by the work of Robert Jervis (1997) on the role of complexity in international relations. Starting with the notion that understanding of social systems has tacitly incorporated linear approaches from Newtonian sciences, Jervis goes on to highlight three common assumptions that need to be challenged in order to take better account of nonlinearity. These assumptions provide a solid basis for investigating nonlinearity.

First, it is very common to test ideas and propositions by making comparisons between two situations which are identical except for one variable – referred to as the **independent variable**. This kind of analysis is usually prefaced with the statement ‘holding all other things constant’. However, in a system of interconnected and interrelated parts, with feedback loops, adaptive agents and emergent properties, this is almost impossible, as everything else cannot be held constant and there is no independent variable. Jervis argues that, in such systems, it is impossible to look at ‘just one thing’, or to make only one change, hence to look at a situation involving just one change is unrealistic.

Secondly, it is often assumed that changes in system output are proportional to changes in input. For example, if it has been assumed that a little foreign aid slightly increases economic growth, then more aid should produce more growth. However, as recent work by ODI and others argues, absorption capacity needs to be taken account – more aid does not necessarily equate to better aid. In complex systems, then, the output is not proportional to the input. Feedback loops and adaptive behaviours and emergent dynamics within the system may mean that the relationship between input and output is a nonlinear one:

‘Sometimes even a small amount of the variable can do a great deal of work and then the law of diminishing returns sets in [a negative feedback process] ... in other cases very little impact is felt until a critical mass is assembled’ (Jervis, 1997).

The third and final commonly made assumption of linearity is that the system output that follows from the sum of two different inputs is equal to the sum of the outputs arising from the individual inputs.

In other words, the assumption is that if Action A leads to Consequence X **and** Action B has Consequence Y **then** Action A plus Action B will have Consequences X plus Y.

This frequently does not hold, because the consequences of Action A may depend on the presence or absence of many other factors which may well be affected by B or B’s Consequence (Y). In addition, the sequence in which actions are undertaken may affect the outcome.

Example: The growth dynamics model as an alternative to linear regression models

Studies of economic growth face methodological problems, the foremost of which is dealing with real world complexity. The standard way of understanding growth assumes, implicitly, that the same model of growth is true for all countries, and that linear relationships of growth are true for all countries. However, linear relationships might not apply in many cases. An example would be a country where moderate trade protection would increase economic growth but closing off the economy completely to international trade would spell economic disaster. Linear growth models imply that the effect of increasing the value of the independent variable would be the same for all countries, regardless of the initial value of that variable or other variables. Therefore, an increase of the tariff rate from 0% to 10% is presumed to generate the same change in the growth rate as a change from 90% to 100%. Furthermore, the change from 0% to 10% is assumed to have the same effect in a poor country as in a rich country, in a primary resource exporter as in a manufacturing exporter, and in a country with well developed institutions as in a country with underdeveloped institutions. Despite some efforts to address these issues by relaxing the linear framework and introducing mechanisms to capture nonlinearities and interactions among some variables, this is still a poor way of addressing real world nonlinearity. Econometric research has identified that linear models cannot generally be expected to

provide a good approximation of an unknown nonlinear function, and in some cases can lead to serious misestimates (Rodríguez, 2007).

Research at Harvard University has focused on the problem of designing a growth strategy in a context of ‘radical uncertainty’ about any generalised growth models. They call their method ‘growth diagnostics’, in part because it is very similar to the approach taken by medical specialists in identifying the causes of ailments. In such a context, assuming that every country has the same problem is unlikely to be very helpful. The principal idea is to look for clues in the country’s concrete environment about the specific binding constraints on growth. The growth diagnostics exercise asks a set of basic questions that can sequentially rule out possible explanations of the problem. The answers are inherently country-specific and time-specific. The essential method is to identify the key problem to be addressed as the signals that the economy would provide if a particular constraint were the cause of that problem.

Implication: Challenge linearity in underlying assumptions

Within complex systems, the degree of nonlinearity and relationships between various factors, and the lack of proportionality between inputs and outputs, means that the dynamics of change are highly context-specific. Therefore, if there are assumptions, aggregations and theories about the relations among different aspects of a specific situation, and these are not entirely appropriate when applied to the dynamics of a new local situation, then this perspective is unlikely to lead to a deep understanding of what should be done, and is furthermore unlikely to lead to the hoped-for changes.

Nonlinearity implies that, as well as understanding the limitations of a particular model or perspective, it is important to build and improve new models that can provide the sort of information required for the particular task at hand.

‘No kind of explanatory representation can suit all kinds of phenomena ... any one diagnosis of [a] problem and its solution is necessarily partial’ (Holland, 2000).

From this perspective, it is important to tailor to the particular situation one’s perspective on the dynamics of some phenomena. In a complex system, one must examine the complex web of interrelationships and interdependencies among its parts or elements (Flynn Research, 2003). It is important from the outset to understand the association and interaction among variables, rather than assuming that one causes another to change, and to look at how variables interact and feed back into each other over time (Haynes, 2003). Homer-Dixon, cited above, suggests that political scientists use methods that are modelled on the physical sciences, developing broad theories of political behaviour to generate hypotheses about causal relations between variables of interest.

These ideas resonate strongly with a recent assessment undertaken for Sida on the use of the log frame (Bakewell and Garbutt, 2005), highlighting some of the advantages and disadvantages in a way which is particularly pertinent for this paper. In the international aid world, much of programme planning and development is undertaken using a set of methods and tools called the logical framework. For most of the study respondents, the advantage of logical frameworks was that they force people to think carefully through what they are planning to do, and to consider in a systematic fashion how proposed activities might contribute to the desired goal through delivering outputs and outcomes. As a result, many see the log frame as a useful way of encouraging clear thinking.

However, these positive aspects were offset by the almost universal complaint that the log frame rests on a very linear logic, which suggests that if Activity A is done, Output B will result, leading to Outcome C and Impact D. This linear idea of cause and effect is profoundly ill-at-ease with the implications of complexity science and, indeed, the experiences of many development practitioners. The authors of the study sum up the problems of the log frame in a way that is key to our discussion of complexity:

‘Unfortunately (for the logical framework approach at least) we are not working with such a self-contained system and there are so many factors involved which lie beyond the scope of the

planned initiative that will change the way things work. Although the LFA makes some attempt to capture these through the consideration of the risks and assumptions, these are limited by the imagination and experience of those involved. As a result the LFA tends to be one-dimensional and fails to reflect the messy realities facing development actors' (Bakewell and Garbutt, 2005).

Nonlinearity also has clear implications for the increased interest in randomised control trials (RCTs). While the implications of nonlinearity for techniques and tools such as the log frame and RCTs are increasingly well understood by many actors within the aid system, the answer to the deeper question as to whether incorporation of nonlinearity will be feasible, given the pressure on donors to justify aid budgets while having to deal with a reducing headcount, is less clear. The distinction between linearity and nonlinearity can be seen in as providing a theoretical underpinning of the frequently cited tension between upward accountability and learning. It also provides a means to re-frame the debate. If the two goals of accountability and learning are also about different *mindsets*, the degree to which an appropriate balance can be struck – without exploring these mindsets and the assumptions on which they are based – is open to question.

Concept 5: Sensitivity to initial conditions

Outline of the concept

The behaviours of complex systems are sensitive to their initial conditions. Simply, this means that two complex systems that are initially very close together in terms of their various elements and dimensions can end up in distinctly different places. This comes from nonlinearity of relationships – where changes are not proportional, small changes in any one of the elements can result in large changes regarding the phenomenon of interest.

Detailed explanation

Imagine a small ball dropped onto the edge of a razor blade, as shown in the first image in Figure 4 below. The ball can strike the blade in such a way that it can go off to the left (centre image) or to the right (right-hand image). The condition that will determine whether the ball goes to the left or right is minute. If the ball were initially held centred over the blade (as in the first image), a prediction of which direction the ball would bounce would be impossible to make with certainty. A very slight change in the initial conditions of the ball can result in falling to the right or left of the blade.

Figure 4: Sensitivity to initial conditions – ball striking razor blade

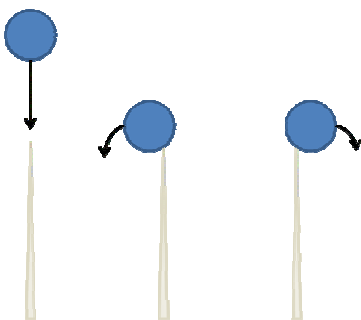

Source: http://www.schuelers.com/ChaosPsyche/part_1_14.htm.

The concept of phase space (Concept 6) allows a more precise understanding of initial conditions. Phase space allows for the analysis of the evolution of systems by considering the evolution process as a sequence of states in time (Rosen, 1991). A state is the position of the system in its phase space at a given time. At any time, the system's state can be seen as the initial conditions for whatever processes follow. The sensitive dependence on initial conditions, in phase space terms, means that the position of a system in its phase space at a particular moment will have an influence on its future evolution. The interactions that are taking place at any moment in time have evolved from a previous moment in time, that is, all interactions are contingent on an historical process. Put simply, history matters in complex systems.

The infamous butterfly effect was a metaphor developed to illustrate this idea in the context of the weather. Edward Lorenz (1972), a meteorologist, used the metaphor of a flapping wing of a butterfly to explain how a minute difference in the initial condition of a weather system leads to a chain of events producing large-scale differences in weather patterns, such as the occurrence of a tornado where there was none before. As more recent thinkers have put it, in relation to complex systems in general, an initial uncertainty in measurement of the state of a system:

‘... however small, inevitably grow[s] so large that long-range prediction becomes impossible ... even the most gentle, unaccounted-for perturbation can produce, in short order, abject failure of prediction’ (Peak and Frame, 1998).

A large proportion of complex systems are prone to exhibiting the butterfly effect, so much so that some have defined complex behaviour as occurring where the butterfly effect is present (ibid). As no two situations will be exactly alike, the phenomenon will inevitably occur in many settings. As with nonlinearity, many have not used formal models to demonstrate the butterfly effect, but instead have tried to develop a qualitative understanding of the likely quantitative nature of real life situations.

Sensitivity to initial conditions also means that ‘the generalisation of good practice [between contexts] begins to look fragile’ (Haynes, 2003) because initial conditions are never exactly the same, and because the complexity and nonlinearity of behaviour make it extremely difficult to separate the contributions to overall behaviour that individual factors have. Any notion of ‘good practice’ requires a detailed local knowledge to understand why the practice in question was good.

This concept highlights the importance of understanding *what can be forecast* in complex systems to what level of certainty, as well as *what is comparable* across complex systems. It reinforces the point that both of these areas are necessarily restricted by the perspective of the observer. Sensitive dependence on initial conditions suggests that no single perspective can capture all there is to know about a system, that it may be wise to look in detail at how appropriate our solution to a problem is, and that it may be better to work with inevitable uncertainty rather than plan based on flimsy or hopeful predictions.

This may mean, to take the example of predictability, that the success of a nation may be best explained not by its population’s virtues, its natural resources and its government’s skills, but rather simply by the position it took in the past, with small historical advantages leading to much bigger advantages later. Another example is how socioeconomic policy can result in a separation of neighbourhoods, driving a large gap between the rich and the poor so that, in short order, a gulf in wealth can result between two families who once had similar wealth (Byrne and Rogers, 1996).

This is closely related to the notion of ‘path dependence’, which is the idea that many alternatives are possible at some stages of a system’s development, but once one of these alternatives gains the upper hand, it becomes ‘locked in’ and it is not possible to go to any of the previous available alternatives. For example,

‘... many cities developed where and how they did not because of the “natural advantages” we are so quick to detect after the fact, but because their establishment set off self-reinforcing expectations and behaviours’ (Cronon, cited in Jervis, 1997).

In economic development, the term ‘path dependence’ is used to describe how standards which are first-to-market can become entrenched ‘lock ins’ - such as the QWERTY layout in typewriters still used in computer keyboards (David, 2000). In certain situations, positive feedbacks leading from a small change can lead to such **irreversible** path dependence (Urry, 2003). Urry gives the example of irreversibility across an entire industry or sector, whereby through sensitive dependence on initial conditions, feedback can set in motion institutional patterns that are hard or impossible to reverse. He cites the example of the domination of steel and petroleum-based fuel models, developed in the late

19th century, which have come to dominate over other fuel alternatives, especially steam and electric, which were at the time preferable.

The concept of path dependence has received some criticism from exponents of complexity science, because it has imported into economics the view that minor initial perturbations are important while grafting this onto an underlying theory that still assumes that there are a finite number of stable and alternative end-states, one of which will arise based on the particular initial conditions. As will be explained in Concept 7 on attractors and chaos, this is not always the case in complex systems (Margolis and Liebowitz, 1998).

Example: Sensitive dependence on initial conditions and economic growth

Economists have generally identified sensitive dependence on initial conditions as one of the important features of the growth process – that is, what eventually happens to an economy depends greatly on the point of departure. There is mounting evidence that large qualitative differences in outcomes can arise from small (and perhaps accidental) differences in initial conditions or events (Hurwicz, 1995). In other words, the scope for and the direction and magnitude of change that a society can undertake depend critically on its prevailing objective conditions and the constellation of socio-political and institutional factors that have shaped these conditions.

For specific economies, the initial conditions affecting economic growth include levels of per capita income; the development of human capital; the natural resource base; the levels and structure of production; the degree of the economy's openness and its form of integration into the world system; the development of physical infrastructure; and institutional variables such as governance, land tenure and property rights. One might add here the nature of colonial rule and the institutional arrangements it bequeathed the former colonies, the decolonisation process, and the economic interests and policies of the erstwhile colonial masters.

Wrongly specifying these initial conditions can undermine policy initiatives. Government policies are not simply a matter of choice made without historical or socioeconomic preconditions. Further, a sensitive appreciation of the differences and similarities in the initial conditions is important if one is to avoid some of the invidious comparisons one runs into today and the naive voluntarism that policymakers exhibit when they declare that their particular country is about to become the 'new tiger' of Africa. Such comparisons and self-description actually make the process of learning from others more costly because they start the planning process off on a wrong foot (Mkandawire and Soludo, 1999).

Implication: Rethink the scope of learning and the purpose of planning in an uncertain world

Sensitivity to initial conditions suggests that there are inevitably degrees of non-comparability across, and unpredictability within, complex systems. Some have argued that this implies that:

'... the map to the future cannot be drawn in advance. We cannot know enough to set forth a meaningful vision or plan productively' (Tetenbaum, 1998).

The general implications for development theory and practice have been highlighted by a previous ODI working paper on participatory approaches, which suggests that this implies the notion of development as planned change is paradoxical. To quote directly,

'... perfect planning would imply perfect knowledge of the future, which in turn would imply a totally deterministic universe in which planning would not make a difference' (Geyer, cited in Sellamna, 1999).

Sellamna goes on:

'For this reason, development planning should abandon prescriptive, goal-oriented decision making and prediction about future states and focus instead on understanding the dynamics of

change and promoting a collective learning framework through which concerned stakeholders can constantly, through dialogue, express their respective interests and reach consensus.'

With regards to learning, this poses profound issues for the transferability of 'best practice', a concept that has taken on increasing meaning within the development sector since the rise of knowledge management and organisational learning strategies (Ramalingam, 2005). While it is possible that, for example, an understanding of the interplay of factors driving urban change in the Philippines may be relevant for analysis of urban change in Guatemala, this is not necessarily the case. The sensitivity to initial conditions gives us a strong reason to suppose that, even if we have a generally useful perspective on urban environments, this may entirely fail to capture the key features of the next situation we look at. This means that the search for 'best practices' may need to be replaced by the search for 'good principles'. Some have suggested that the most appropriate way to bring the principles of effective approaches from one context to another is for

'... development workers to become facilitators ... enabling representatives of other communities ... to see first hand what in the successful project they would wish to replicate' (Breslin, 2004).

Moving onto planning, to say that prediction of any kind is impossible may be overstating the case. Complexity does suggest that, in certain kinds of systems, future events cannot be forecasted to a useful level of probability and that, from certain perspectives, it is not possible to offer any firm prediction of the way the future will pan out on certain timescales. However, in other systems, future events can be foreseen in a helpful manner. For example, Geyer (2006) suggests that, with political dynamics, it is fairly safe to predict the short-term dynamics of basic power resources and political structures and that, therefore, there is decent scope for forecasting voting and decision outcomes of policy. On the other hand, examining party and institutional dynamics becomes more difficult, and grasping the potential shifts in contested political and social debates is even harder, while the long-term development of political dynamics is effectively characterised by disorder, as far as our ability to predict is concerned.

It is important to clarify that certain levels of uncertainty are unavoidable when looking into the future. Complexity science suggests that it is important to identify and analyse these levels of unpredictability as part of the nature of the systems with which we work, and not treat uncertainty as in some way 'unscientific' or embarrassing. Rather than rejecting planning outright, there is a need to rethink the purpose and principles of planning. This has two key strands.

First, it is necessary to incorporate an **acceptance** of the inherent levels of uncertainty into planning. The requirement for a certain level of detail in understanding future events should be balanced with the understanding that both simple and intricate processes carry uncertainty of prediction. While improving one's models of change and analyses of facets of a situation may be worthwhile, it is just as important and often more practical to work with a realistic understanding of this uncertainty and build a level of flexibility and adaptability into projects, allowing for greater resilience.

It has been argued that development projects have 'fallen under the enchantment of [delivering] clear, specific, measurable outcomes' (Westley et al., 2006). In many cases, this could be unrealistic, ineffective or even counterproductive; it is uncertain whether valuable social outcomes could be planned in terms of a specific series of outputs, and it is unclear why it is more productive to be able to hold agencies strictly accountable to promises at the expense of their promises delivering real results. This resonates with critiques of the log frame approach cited earlier, which argue that the adoption of the log frame as a central tool in effect and impact evaluations assumes higher powers of foresight than in fact is the case (Gasper, 2000).

What is needed is higher levels of flexibility in the funding of international aid work, involving less stringent 'targets' and requirements from donors. The role of M&E would be shifted to value learning from unexpected outcomes. This is at the heart of the participatory approach to M&E developed by IDRC called outcome mapping.

Second, the way organisations look into the future should be adjusted by taking a more systematic and realistic view of what the future can hold:

‘A single vision to serve as an intended organisational future ... is a thoroughly bad idea ... not that the long term is dismissed as an effective irrelevance, [instead we need a] refocusing: rather than establish a future target and work back to what we do now to achieve it, the sequence is reversed. We should concentrate on the significant issues which need to be handled in the short term, and ensure that the debate about their long-term consequences is lively and engaged’ (Rosenhead, 2001).

What is needed is a ‘pragmatic balance between present concerns and future potentialities’ (ibid); this means that ongoing systematic thinking about the future is an important task for any organisation working in development or humanitarian aid. Foresight is ‘the ability to create and maintain viable forward views and to use these in organisationally useful ways’ (Slaughter, 2003), and futures techniques, such as driver analysis or scenario planning, are suitable for this task. Scenario planning constructs a number of possible futures, in order to produce decisions and policies that are robust under a variety of feasible circumstances. This encourages a move away from looking for ‘optimal’ policies or strategies: ‘any strategy can only be optimum under certain conditions’ and ‘when those conditions change, the strategy may no longer be optimal’ (Mittleton-Kelly, 2003), so it may be preferable to produce strategies that are robust and insensitive to future variability rather than optimal for one possible future scenario.

Path dependence and ‘lock ins’ are also important to consider in the context of the practices of international aid agencies. The widespread use of the logical framework approach, despite the often serious critiques, is a clear example of path dependence at play. In fact, it could be argued that linearity has a ‘lock in’ when it comes to the thought processes and approaches of international agencies. How ‘lock ins’ may be addressed in specific agency contexts is touched upon in Concept 7 on attractors and chaos.

Concept 6: Phase space and attractors

Outline of the concept

The dimensions of any system can be mapped using a concept called phase space, also described as the ‘space of the possible’ (Cohen and Stewart, 1995).⁷ For any system, the ‘space of the possible’ is developed by identifying all the dimensions that are relevant to understanding the system, then determining the possible values that these dimensions can take (Romenska, 2006). This ‘space of the possible’ is then represented in either graphical or tabular form. In natural sciences, the prevalence of time-series data means that the phase space can be represented as a graphical map of all of the relevant dimensions and their values. In social scientific thinking, tables of data can be used to apply the same principles. The phase space of a system is literally the set of all the possible states – or phases – that the system can occupy.

Phase space is particularly useful as a way to describe complex systems because it does not seek to establish known relationships between selected variables, but instead attempts to shed light on the overall shape of the system by looking at the patterns apparent when looking across all of the key dimensions. This resonates with a key point raised in Concept 1 – more may be learned about complex systems by trying to understand the important patterns of interaction and association across different elements and dimensions of such systems (Haynes, 2003). Phase space can be used to enable this kind of learning. By creating such a map of a system, it is possible to characterise how that system changes over time and the constraints that exist to change in the system (Musters et al., 1998).

⁷ Phase space is often used interchangeably with the phrase ‘state space’.

Detailed explanation

The dimensions of a complex system mutually influence each other, leading to an intricate intertwining (Mittleton-Kelly, 2003) of these relationships and system behaviours to degrees of nonlinearity and unpredictability. Because of the challenges involved in analysing such systems, scientists studying complex systems have made use of a mathematical tool called phase space, which allows data relating to the dimensions of a system to be mapped rather than solved (Capra, 1996). Put simply, phase space is a visual way of representing information about the dimensions of a system. Rather than a graph, which attempts to show the relationships between specific chosen dimensions, phase space maps the possible values of each dimension of the system (akin to drawing the **axes** of a graph). This is the space within which a complex system displays its behaviour.

Byrne gives the example of a city as a complex system (Byrne, 2006). He describes how the cities are complex problems in that they present situations where a range of variables are interacting simultaneously and in interconnected ways. He cites the specific example of Leicester, a city in the UK that grew from a small market town of 2,000 people in the 11th century to a city of 280,000 in 2001. Using the Census data from 2001, he shows that Leicester could be seen as a complex urban system made up of the following variables:

- Total population of the area
- Ethnic composition of the population
- Distribution of the population between urban core and suburban / exurban periphery
- Proportion of population aged 16-74 which is economically active
- Total employed population
- Distribution of the working population by sector of employment
- Distribution of the working population by kind of economic activity
- Distribution of the working population by gender
- Total number of households
- Tenure of households

These variables together represent the individual dimensions of the multi-dimensional phase space of the Leicester urban area. With year on year data over a number of years, this table can represent the phase space of the system. Figure 5 provides a picture of Leicester using two time points.

Figure 5: Phase Space Table of the Leicester Urban Area

	2001	1971
Total population	579,000	534,000
Percentage ethnic identity other than White British	24.7	8.8
Total of working age	420,000	392,000
Total economically active	261,000	261,000
Percentage of working age economically active	62.1	66.5
Percentage economically active female	46.6	38.2
Percentage economically active in industrial employment	34.5	58.7
Total households	230,000	177,000
Percentage owner occupied	70.0	57.1
Percentage social tenants	18.7	23.7

Source: Adapted from Byrne (2006).

We will return to some of Byrnes's work later, but it is important now to look at the idea of phase space in rather simpler systems in order to illustrate some key principles. The most commonly used simple system is that of a pendulum swinging through a small angle without friction (the top image in Figure 6 below).

Figure 6: Phase space of a pendulum

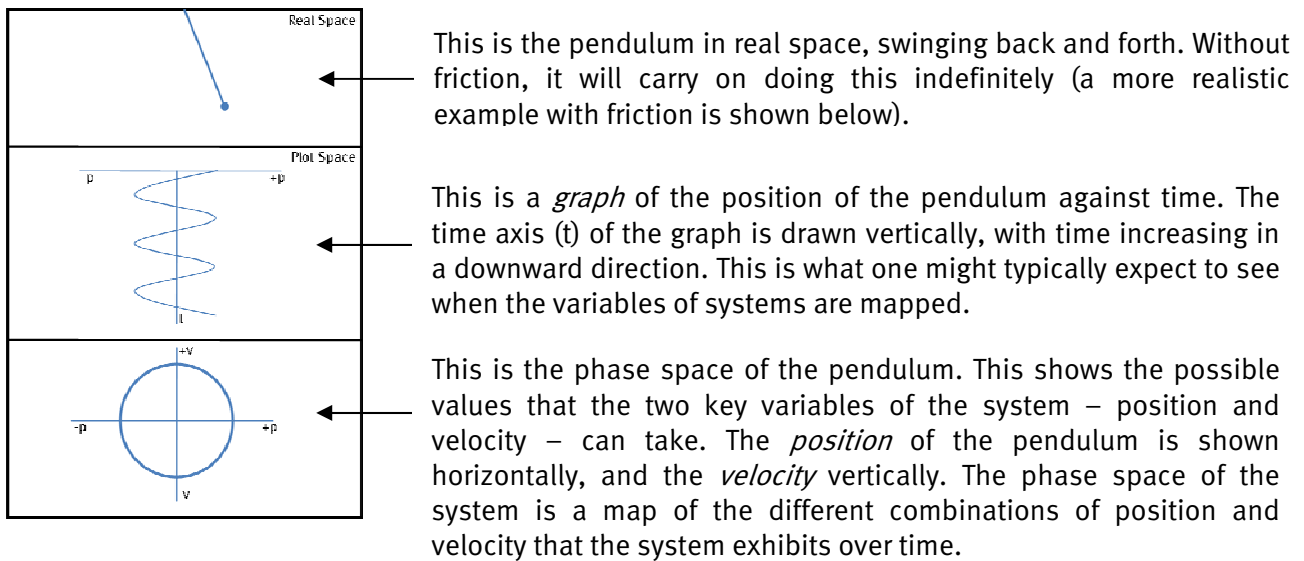

Source: Adapted from <http://mcanv.com/pend1.html>.

Mapping these data points over time shows that the system moves in a circle or ellipse through this phase space. This loop is called the system's trajectory in phase space. **The trajectory provides a metaphorical map of how the values of the system dimensions change over time.** The dimensions of the system at any given point can be represented by a single point which will always be on the trajectory.

In the real world, if friction is taken into account in a pendulum system, the assumption would be that the pendulum would eventually run out of energy and come to a standstill. This is described below.

Figure 7: Phase space of a simple pendulum under friction

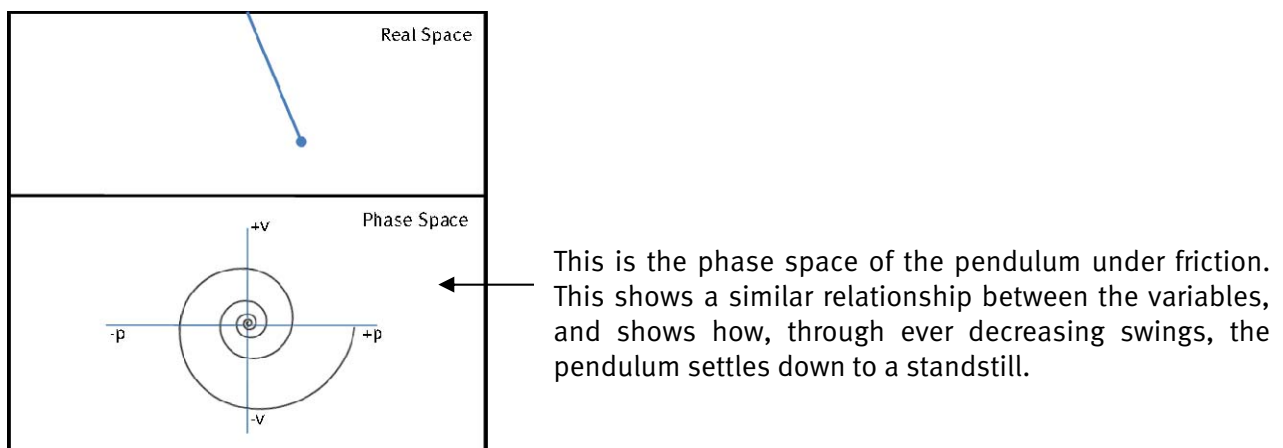

Source: Adapted from <http://mcanv.com/pend1.html>.

The above examples illustrate how phase space enables an understanding of the evolution of the systems: as the system changes, the point marking its location in phase space also moves. The diagrams show how the variables of the system change and how they are interconnected: the velocity is highest when the pendulum is in the centre of its swing, and moves to zero at either end of swing. A pendulum under friction swings smaller and smaller, until it eventually comes to a stop. The graph of

position versus time shown in Figure 6 should help clarify that phase space allows a complementary understanding of the *dynamics of a given system*.

Phase space, in the sense described above, was developed in the early 20th century, but it is with the advent of computing and new levels of number-crunching power that it has come into its own. The same basic technique described above can be used for systems that are far more complex and have many more dimensions. Computers have enabled tracking of systems with many dimensions and have been used to identify the patterns underlying seemingly complex behaviour.

The ways in which the dimensions evolve and interact leads to different system behaviours in phase space (Byrne, 2001). The trajectory of a complex system through its phase space may be totally random, such that at any point in time the system could be anywhere in its phase space. Conversely, the system may be limited to a particular part of the phase space – as in the simple example of the pendulum shown above. When observed over time, the points can start to form recognisable patterns. These patterns are known as attractors, and they embody the long-term **qualitative** behaviour of a system (Capra, 1996).

The first pendulum described above keeps swinging, and so it is said to have a **periodic attractor** – it moves through its phase space periodically, in repeated ways. The second diagram describes a pendulum that eventually comes to a rest, and so is said to be a **point attractor**.

Imagine another simple system of a pencil being put down on its end (see Figure 8). There are two possibilities for how this system could end up – or two attractors. The pencil could end up horizontal, or vertical. In this example, A is possible attractor, but B is the dominant attractor. The lower diagram shows phase space in a different way – in relation to the potential energy of the system.

Figure 8: The two attractors of a pencil being placed on a table

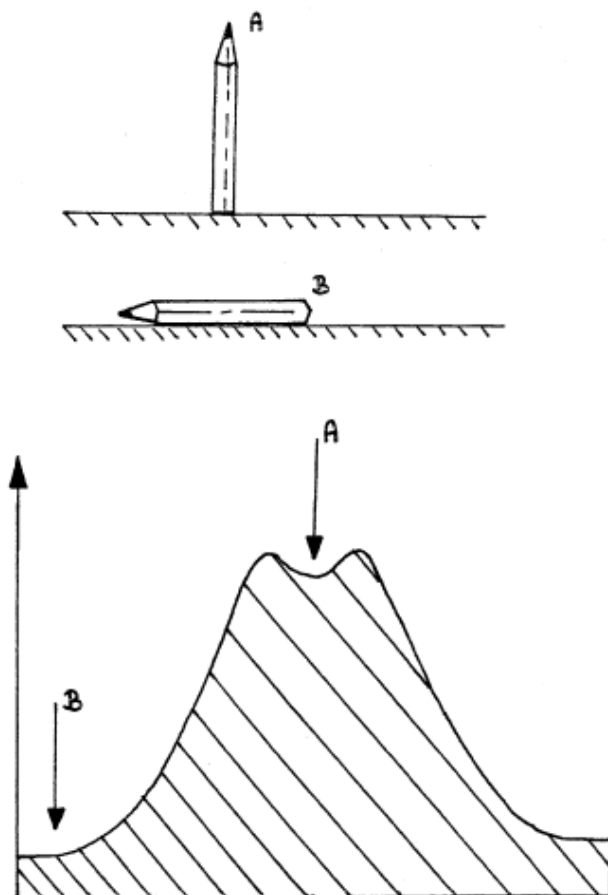

Source: Newell (2003).

Work on strengthening higher education systems in former Soviet bloc countries has highlighted that the concept of phase space is a powerful one in tracking their evolution and therefore informing policy decisions. The higher education system phase space is made up of a wide range of dimensions: number of institutions, private or state institutions, students, staff, etc. (Romenska, 2006). The phase space is developed by tracing how these dimensions change over time (Musters et al., 1998). Each dimension can have a certain, limited set of values – for example, if a university system can educate maximum number of x students, the dimension ‘number of students’ can have values ranging from 0 to x , giving rise to a range of different states (Romenska, 2006). Using this approach can reveal that different dimensions are alternatively constant, stable, evolving or unpredictable.

A higher education system would typically move slowly through its phase space by means of changes in various dimensions – for example, changes in the number of students, in the way that degree examinations are administered, in the results in examinations, or in the number of institutions. The figures for every year may be somewhat different, but not to a degree that will change dramatically the character of the university system.

If, however, new government regulations set a fee for university attendance, which has been free till this moment, a dramatic change will occur. The university may react in too many different ways to the new regulations – it may introduce scholarships, reduce the student places, make some of its staff redundant or cut their salaries or, if there are not enough students enrolling, even close down. This process of sudden movement in the phase space, which is not uncommon for complex systems, is called a phase transition, or ‘bifurcation’, which will be looked at in more detail in Concept 7.

In general, complexity scientists distinguish between conservative systems, which essentially do not have the potential to transform the general shape of their attractor, and dissipative systems, where the form of the attractor may change. The concept of equilibrium is useful here: there might be systems at equilibrium, which do not change their position in phase space; there may be systems close to equilibrium, such that they move back to their original position if disturbed; and there may be systems far from equilibrium, such that radical transformation of the trajectory through phase space is possible. Complex and chaotic systems are described by particular kinds of attractors, which will be described in more detail in Concept 7.

With sufficient data, the phase diagram can be used as a representation (albeit an approximate one) of all the states the system can possibly occupy over time. This has given rise to the term ‘space of the possible’ (Cohen and Stewart, 1995; Stewart, 1992). Over time, the behaviour of a complex system can be mapped by observing the movements of these points within the phase space (Mendenhall et al., 1998; Gleick, 1987). Complex social, economic or political systems can be seen to develop within certain economic, ecological, political and socio-cultural constraints, which can be seen as maintaining the boundaries of the phase space of the system (Musters et al., 1998). Though such systems may be unpredictable in their behaviour, there may be patterns describing the boundaries, or the possibility space, of the system’s behaviour. The shape of phase space can therefore be used to uncover and examine aspects of the system that might not be otherwise obvious.

Example: Phase space and understanding socioeconomic exclusion

In social sciences, a tabular form of representing data may be used to show phase space of the system (Byrne, 1998). This can be particularly useful when analysing qualitative data. For example, data below come from a household survey in Cleveland undertaken with over 1,500 respondents. The survey contained a great deal of information about household structure and employment relations. Byrne uses these data to construct a six-dimensional phase space of the households, as shown below.

Figure 9: Tabular representation of socio-economic system with six dimensions

Dimension	Possible value
Parenthood	Single, double
Tenure	Owner occupier, social housing tenant, other
Work relation	Work rich, work average, work poor
Social class	SC1, SC2, SC3 non-manual, SC4, SC 5, no social class
Age of household head	Less than 25, 26-30, 31-40, 41-50, 50+
Sex of household head	Male, female

Source: Byrne (1998).

If each household could have one value for each of these dimensions, there are 900 different types of households. By looking at the typical combinations of values, it is possible to draw conclusions about the phase space of households, and how this changed over time. Given the data available over time, Byrne was able to use this to analyse how the form of the phase space of excluded households had changed over time.

While some of the potential combinations were not possible because of how data were selected, it was clear that the overall phase space had relatively stable configurations – for example, single parent families were worse off, and their numbers remained reasonably steady over time. By looking at the patterns with many entries, and with few, it is possible to see what phase space conditions are possible in Cleveland at a given point in time. In the example given, exploration of the phase space showed some interesting concentrations. For example, the work poor and young-headed households were very likely to be social housing tenants. The work rich young were more likely to be owner occupiers. Because the Cleveland Social Survey was conducted on an annual basis from 1977 to 1995, it was possible to construct the phase space specified by the six variables for a series of points over time, thereby examining changes in this phase space as a socioeconomic system. During this period, there was a major shift in the attractors for the system. In the late 1970s, social housing was not associated with work poverty. Most very deprived households were female single parent-headed, and there were relatively few of them. By the 1990s, most work poor households were double headed, and the absolute numbers of such households had grown dramatically. They predominated among the social housing tenants in Cleveland. The category of ‘no social class assignable’ became much more significant, because the growth in unemployment meant that there was no employment basis for the assignment of class. In the language of social exclusion, in the late 1970s the attractor of excluded households contained a relative minority of child-containing households in which the households were primarily female headed. By the 1990s, the attractor was much larger in terms of child-containing households, and contained more two-parent households than single-parent households. The phase space analysis shows that exclusion had become de-gendered and had massively expanded.

Implication: Build understanding of the ‘space of the possible’

The concept of phase space suggests complex systems such as those faced by aid organisations are not best understood by simply ‘carving out’ a number of the dimensions and analysing these as a subset. Similarly, it is not ideal to try to understand a variety of causes that have led the dimensions of a system to be the way they are, then moving on to examine each dimension and its cause in isolation. Attempts to understand the system should first identify the key dimensions and track changes in them over time, using this to develop a holistic picture of how the system changes and evolves.

For example, the phase space of an international agency (following Romenska, 2006) would contain dimensions describing the extent to which it is state or privately funded, parameters showing the numbers of staff and offices worldwide, dimensions for the number of programmes and projects and for the number of beneficiaries – the list can be endless. By tracking the changes of all these dimensions over time – the phase space – it is possible to characterise how the organisational system changes in response to internal and external interactions. Certain dimensions may be constant (the number of offices), stable (yearly income from government donors), evolving (the information infrastructure of the organisation), or unpredictable (staff composition). The quest for organisational change will require those involved to appreciate the multiple dimensions of the organisation, which can be influenced and

which cannot, which are constrained and by what, and how these issues play out between the different levels of the organisation. Importantly, if certain dimensions cannot be changed, it may be because they are not being addressed at the appropriate level of the organisational system. For example, it may be hard to influence and improve learning processes across international offices, but much easier at the level of teams.

This aspect of phase space highlights an important issue that has been raised recently with regards to changes in humanitarian organisations. As part of a broader look at realistic expectations for change in the humanitarian sector (Slim, 2007), it has been suggested that the next five years will see mixed progress in ‘outer realm’ issues of politics, and deeper changes in the ‘inner realm’ of organisational efficiency and effectiveness. If the humanitarian system is seen to develop within broader economic, ecological, political and socio-cultural constraints, then this statement should be qualified carefully with the understanding that the ‘outer realm’ may maintain certain aspects of the system such that the ‘inner realm’ issues are effectively constrained by the lack of progress in the outer realm. A clearer understanding of how the ‘outer’ and ‘inner’ dynamically affect each other would be a useful start.

Fully utilising the concept of phase space calls for aid organisations at least to make an attempt to understand the full range of different dimensions of the systems with which they are dealing, the values these dimensions might take over time, and the implications of this for how the system changes and evolves. Ultimately, there should be effort to contextualise the projects or programmes of an agency within these patterns of system behaviours. Enabling such an understanding shapes how aid projects and programmes are conceived, planned and executed.

Concept 7: Strange attractors and the ‘edge of chaos’

Outline of the concept

The concept of phase space and attractors are central to understanding complexity, as complexity relates to specific kinds of system trajectories through phase space over time. The behaviour of complex systems can at first glance appear to be highly disordered or random. Moreover, these systems move through continually new states, with change as a constant in a kind of unending turbulence. However, there is an underlying **pattern** of order that is recognisable when the phase space of the system is mapped, known as a strange attractor.

Detailed explanation

In the 19th century, a mathematician named Henri Poincare was using Newton’s equations of planetary motion, which were – as has already been covered – based on a number of assumptions of linearity. Poincare proved that this approach worked for simple planetary systems of two bodies. In order to test the applicability with systems of three bodies – e.g. the sun and two planets – Poincare used tools that were based on the same principles as phase space to map the movement of such systems over time. He found the trajectory of the system to be one of ‘awesome complexity’ (Capra, 1996). The idea lay more or less dormant until the 1960s, when the Lorenz experiments showed that computer-aided modelling could be used to identify complexity.

Until the 1960s, there were only a few known attractors – including fixed points and periodic (as described previously in concept 6). All of these attractors related to systems that are predictable, in terms of understanding where they may end up. However, complex systems that are hard to predict also have an attractor, but they are much harder to map without the use of computers. The attractor for complex systems was discovered by Lorenz (shown in Figure 10). Most commonly known as strange attractors⁸, these are at the heart of the understanding of complexity.

Strange attractors show how complex systems move around in phase space, in shapes which resembles two butterfly wings⁹. A complex system – such as the three-body planetary system, or the

⁸ But also referred to as chaotic, Lorenz and butterfly attractors

⁹ Given the use of the butterfly metaphor by Lorenz, some have assumed that there is some connection between the two. However, it seems as though this is just a rather happy coincidence.

weather – would move around one loop of the attractor, spiralling out from the centre. When it got close to the edge of the ‘wing’ it would move over to the other ‘wing’ and spiral around again (Strogatz, 2003). Complex systems can have a chaotic dynamic, and develop through a series of sudden jumps (Feigenbaum, 1978). Such a jump, usually referred to as a bifurcation, is an abrupt change in the long-term behaviour of a system, when the value of a particular dimension becomes higher or lower than some critical value. As one gets close to the bifurcation points – which may be seen as those points where the system moves from one wing of the attractor to the other, the values of fluctuations increase dramatically.

This strange attractor shows that complexity – although seemingly completely disordered, actually displays order at the level of its trajectory, and that although it may be unpredictable in its detail, it always moves around the same attractor shape. This ‘narrowness of repertoire’ is at the heart of the order hidden in complexity.

Figure 10: The strange attractor

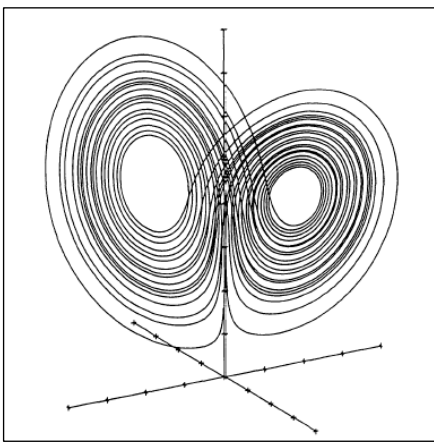

Source: Adapted from Mendenhall et al. (1998).

The lines in the attractor reflect the overall pattern of system behaviour, rather than the sequential movement of the system through time. Points on this attractor appear haphazardly at various locations on the lines, over time, eventually revealing the lines, but giving the observer no clue as to where the point will next appear within phase space. Eventually, the overall pattern of system behaviour is revealed. As Sanders puts it:

‘There are systems that never settle into a predictable or steady state ... these are said to have strange attractors. A graphic representation of such a system will reveal a complicated pattern or shape, where the internal design never repeats itself’ (Sanders, 1998).¹⁰

These observations offer an explanation of why elaborate computer programs cannot predict weather patterns with 100% accuracy. Yet, although the weather is unpredictable, it remains bounded within a certain ‘space of the possible’. A complex system is thus dynamic and nonlinear, and it is hard to predict the outcome of a given input and the feedback loops this causes. When the feedback is positive there is progression: the system moves forward. Feedback loops do not always produce the same effects and are not predictable. Paradoxically, complex feedback systems act to control the chaos in complex systems and keep them within certain boundaries (Nilson, 1995). A somewhat poetic view of a city from this perspective illustrates this:

¹⁰ If any part of the strange attractor were magnified, it would reveal a multi-layered sub-structure in which the same patterns are repeated. Complexity plays out in identical ways at different levels of a system. The development of fractal geometry by the IBM researcher Benoit Mandelbrot has helped to further understanding of chaos, to the extent that the term ‘fractal’ is now widely used to describe the computer-generated images created when mapping strange attractors (Gleick, 1987).

‘Buyers, sellers, administrations, streets ... are always changing, so that a city’s coherence is somehow imposed on a perpetual flux of people and structures. Like the standing wave in front of a rock in a fast-moving stream, a city is a pattern in time. No constituent remains in place but the city persists’ (Holland, 1995).

Such systems do display order, albeit not in the regular sense expected with linear systems. Instead, the order relates to the shape or pattern that the behaviour of a system displays in its phase space over time.

At a more general level, the notion of strange attractors and bifurcations implies that, despite chaotic or turbulent behaviour, the dynamics of complex systems can be investigated and understood. With the use of these tools, complexity scientists have been able to shed light on situations where there is no settling down to a stable equilibrium, no stable states and no repetition. Instead, there are systems undergoing continuous change, driven by the various factors and actors that shape and make them. This process of continuous change is often referred to as far from equilibrium, or ‘unending turbulence’.

This resonates with much thinking in political science, which suggests that ‘economic innovation [is] often driven by social conflicts within economic systems [and] seems to be a constant generator of fluctuations in capitalist social systems’ (Byrne, 1998). In fact, it is possible that a very large number of phenomena in the physical and social worlds can be better understood as complex systems undergoing continuous change and operating far from equilibrium. To cite one thinker, ‘our society and all of its institutions are in continuing processes of transformation ... we must learn to understand, guide, influence and manage these transformations’ (Chapman, 2004). For some, this means operating at the ‘edge of chaos’. A previous ODI working paper looks at applying complexity theory to the process of strengthening capacity in community-based natural resource management organisations (Warner, 2001). Using examples of organisations from the Fiji Islands, Papua, West Bengal and Venezuela, Warner examines three approaches to the adaptation of CBNRM and investigates how organisations can be assisted to manage and adapt in the face of these increasing development pressures. Warner argues that, within certain limits,

‘... methods of interest-based negotiation can be applied to solicit organisation-specific rules that draw ... organisations away from development-induced conflict and social exclusion towards an “edge of chaos” where creativity and adaptation flourish.’

Box 2 provides a more detailed look at the concept of ‘edge of chaos’, with specific reference to urban planning and urban regeneration.

If social systems cannot best be described by reference to fixed point or periodic attractors, this means that social phenomena should not be viewed as tending towards equilibrium, as having defined end-states, or as being cyclical. A more apt metaphor, and one which may help to further understanding, may be to view them as open systems that exchange energy, matter or information with each other and their environment, and that continually create new structures and order (Mittleton-Kelly, 2003). Nobel Prize winner Ilya Prigogine has referred to these as ‘dissipative structures’, in reference to his research on a wide range of systems that displayed such behaviours. Such systems can maintain themselves in stable states which are far from equilibrium, and can transform themselves into new structures of increased complexity. Prigogine’s analysis details how instabilities and bifurcations to new structures are in fact the result of fluctuations which are amplified by positive feedback processes.

Box 2: Edge of chaos

Attractors suggest that systems are understood in terms of the two extremes of order and chaos. The metaphor of solids and gases can be used to clarify this. In solids, atoms are locked into place, whereas in gases they tumble over one another at random. However, right in between the two extremes, at a phase transition, a phenomenon called the 'edge of chaos' occurs. This phenomenon describes systems behaviours where the components of the system never quite lock into place and never quite dissolve into turbulence either. In human organisations, the simplest example is of a system that is neither too centrally controlled (order) nor too unorganised (chaos). The key question for many thinkers, who suggest that the edge of chaos is the place of maximum innovation within human systems, is **how** complex systems get to the edge of chaos. The illustration above on solids and liquids suggests, logically, that ordered systems can achieve this by loosening up a bit, and chaotic ones can do it by getting themselves a little more organised.

A study of urban planning has suggested that the edge of chaos principle relates to the evolving relationship between local authorities and local communities in Hulme, Manchester. This shaped decision-making processes, steering a path between the two extremes of centralised order (local authorities) and bottom-up chaos (community groups). Using social network analysis, the diminishing gap between authorities and communities was measured, drawing conclusions about the strength of the ties and frequency of interaction between the two groups over time. It was found that, from 1960–85, decision making was enshrined in the notion of local authorities making decisions for local communities without the latter being consulted. By the mid-1980s, consensus was beginning to loosen up under the exigencies of the (emergent) local community networks, moving from the highly centralised 'we know best' spirit of the 1960s to an acceptance of the opinions of community groups as useful and valuable in the decision-making process. This represented a massive change and paved the way for real progress in Hulme in the 1990s. Hulme as a system was searching for the edge of chaos, a special kind of balance (in decision making) between central control and the power of community networks. An important point to note here is that nobody designed the search process for the consensus that ensued – the system itself found the balance. A programme was then launched which was able to flourish on this fertile ground of strengthened community–authority interactions. Subsequent evaluations on the regeneration processes highlighted that the success of the initiative came about because it was at a particularly innovative point for community–authority relations. This highlights a potentially fundamental insight into the understanding of the urban system in general and urban regeneration processes in particular.

Source: Moobela (2005).

Example: Organisational change as bifurcations in a complex system

Gareth Morgan (1986) suggests that the idea of strange attractors provides a powerful perspective for the management of stability and change in organisations. Specifically, he suggests that transformational change ultimately involves the creation of new contexts that can break the hold of dominant attractor trajectories in favour of new ones. He uses the idea of a strange attractor as a creative metaphor (as shown in Figure 11) to generate thinking about organisational change, and in doing so raises an important challenge for managers of change processes. If organisations can be described using the attractor metaphor, then it is implied that managers cannot be in control of the change. The new pattern of the attractor cannot be precisely defined – it is only possible to nurture elements of the new context, and create conditions under which the new context can arise. When the old pattern – the old context – is particularly powerful, no significant change is possible, because the organisation ends up trying to do new things in old ways. Morgan sees that the power of this approach lies in its potential both to open up new understandings and possibilities for action but also, importantly, to outline the limitations in terms of individual actors' control and power over organisational change processes.

Figure 11: A strange attractor as a creative metaphor

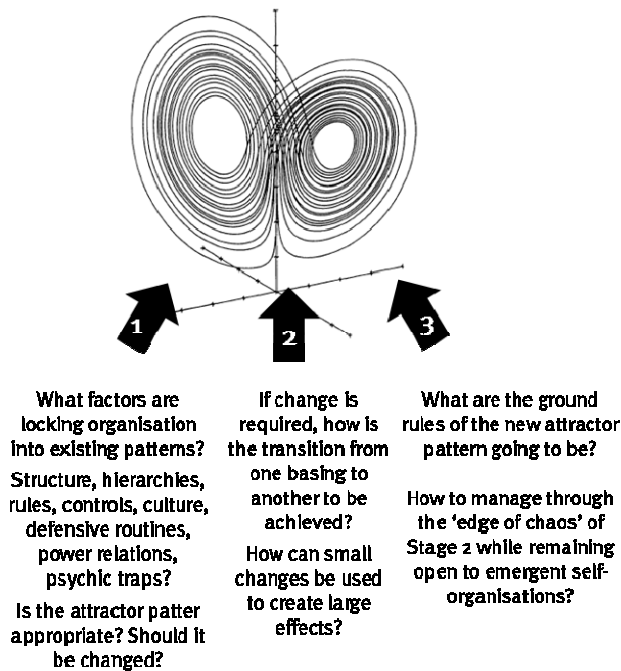

Source: Morgan (1986).

Implication: Manage contexts and ensure decision-making approaches are appropriate to the system

Certain social, economic and political domains seem – at least metaphorically – to fit the image of the strange attractor metaphor, with discontinuities, perpetual novelty and ever-changing elements but recurring patterns and discernible structures. This is true of international aid – as Porter et al. (1991) argue, the whole international development system is ‘a moving, evolving multi-faceted thing, and if it was possible to offer an answer today, it would be inappropriate by tomorrow.’

This equally applies to the process of development in a country, or the adequate means of responding to crises. A particular issue in international aid may not be most usefully solved through the provision of a particular ‘output’. Rather, it may be more productive to see development as an open-ended, ongoing, unpredictable and continually changing process. Similarly, crises can be seen as bifurcation points in which human social systems are exposed to high constraints and stress ‘that upset the balance between the internal forces structuring the systems and the external forces that make up the environment’ (Laszlo, 1991). A crisis could then be defined as a condition in which there is a change in an environmental or human stress that is destabilising enough so that the original set of attractors is supplanted by a new set of attractors.

However, this perspective contrasts with attitudes towards chance and risk prevalent within aid organisations:

‘Venturing into the unknown normally means that the organisation’s standard operating procedures can no longer deal with the types of information it is receiving, and are no longer suitable. Such departures occur when the organisation is on the brink of collapse or is being forced – by means no longer in its control – to change its procedures fundamentally. It often takes a long time for an [aid] organisation to realise that it has hit the point where there is no alternative to change; often, that point comes too late’ (Kent, 2004).

Accepting the notion of chaos and strange attractors encourages an acknowledgement of the continual change in social systems, which by extension requires acceptance of ‘the inevitability of change’ in the

many systems that aid agencies operate within and around. Such change should not be viewed as worrying or necessarily negative (Haynes, 2003). Equally, equilibrium and stability should not be viewed as default and ideal states for a particular system, but as situations of stasis and ossification. Incorporating this insight into the way problems are approached in the development sector points towards an important shift in thinking. As Peter Senge suggests:

‘... most of us have been conditioned throughout our lives to focus on things and to see the world in *static images*. This [in turn] leads to linear explanations of “systemic phenomenon”. Understanding the perpetual flux in systems should lead us to see “interrelationships, not things, and processes, not snapshots”...’ (Senge, 1990).

Whether looking within aid organisations or outside them, this calls for better management of context, and to give up the idea of precise control in favour of the idea of the emergent nature of change. New contexts can be generated through new understandings, such that those operating in the system can be encouraged to challenge and change existing paradigms, norms and assumptions. For example, thinking of an organisation as discrete may lead those within it to try and help it survive as a discrete entity, instead of allowing it to evolve to a new form. New contexts can also be encouraged by identifying and changing the ‘basic rules’ which reinforce the existing attractor patterns, allowing new actions to emerge and become powerful messages for the kind of change that is being sought. These changes can help to catalyse other changes that are in line with the hoped-for new context (Morgan, 1986).

The potential for small changes to lead to large, directed changes is explored by Holland in his work on ‘lever points’ of systems. Holland (1995) argues that such lever points could be the key to solving problems such as ‘immune diseases, inner city decay, industrial innovation, and the like’. The chaos metaphor suggests that there are bifurcation points that tip systems from one state to another – and, if these can be understood, then it may be possible to better identify such leverage points. This has been explored in the context of aid effectiveness (Eyben, 2006) by investigation of the premise that a relatively small intervention through small grants and technical cooperation assistance might cause a disproportionately significant impact. The study suggests that donors may already be funding these kinds of ‘high leverage’ initiatives, but that current reporting procedures and increasing interest in large-scale budget support may mean that these activities and the factors that might contribute to their success are not well documented. These factors are likely to include: the country-specific context; the approach of the donor agency to aid effectiveness; how it understands change; how it invests in relationships; its openness to a diversity of views; and its preparedness to experiment, take risks and learn to alter its views. All of these can be seen as ways to manage the context within which change happens.

The inherent unpredictability of change in such systems also means that there may be significant value in an organisation increasing its ‘agility’. In systems characterised by ‘surprise and discontinuity ... organisations need to rapidly adapt to unexpected conditions ... they have to *improvise*’ (Pina e Cunha and Vieira da Cunha, 2006). Thinking back to concept 5 and the implications for planning, this does not – as some claim – imply that strategy becomes irrelevant: ‘the idea of strategising for the future is fundamentally based on the unpredictability of the future, of which some aspects ... can be foreseen’. To put it another way, working with chaos means ‘it is not about being strategic or opportunistic; it is about being strategically opportunistic’ (John Young, personal communication). It has been suggested that ‘the adoption of minimally structured organisational forms are a necessary condition for strategic improvisation’ (Pina e Cunha and Vieira da Cunha, 2006).

These factors also resonate with suggestions made for dealing with continuous transformation and change. Specifically, some see the potential turbulence of chaotic systems as emphasising the high importance of making continuous learning an inherent part of organisations and policy. To continue the quote from Jake Chapman cited on page 34:

‘Our society and all of its institutions are in continuing processes of transformation ... we must learn to understand, guide, influence and manage these transformations. We must make the capacity for undertaking them integral to ourselves and our institutions. We must, in other words, become adept at “learning”. This “learning” should not be seen as a one-off event, or a case of acquiring new knowledge or skills, rather it involves ongoing practice and reflection on one’s own experience. Since knowledge of “best practice” cannot be easily imported from elsewhere, all organisations must involve themselves in learning as a “continuous, on-the-job process” (Chapman, 2004).

This should be done through a commitment to ongoing reflection and adaptation of aid programmes. Since the context in which a programme is operating is continuously changing, and it is not possible to plan for all eventualities, a successful programme is one that assesses and adapts to changing situations in an intelligent way based on thoughtful reflection. This means that the programme needs to be engaged in ongoing reflection and learning so as to remain relevant and appropriate. This shift towards ongoing processes of learning has some knock-on implications. It has been suggested that this entails a move in attitude away from ‘knowing best’ (‘if one already knows the answer or knows best then there is no need to learn anything’) (ibid), realising that there are ‘no final answers’ and we must approach problems with the mindset of ‘enquiry and not certitude’ (Westley et al., 2006). This could shift focus of policy from ‘specifying targets to be met’ towards ongoing work ‘based on learning what works, and towards improving overall system performance, as judged by the end-users of the system’ (Chapman, 2004). But a chaotic system not only suggests that lessons themselves are **permanently provisional** (Chambers, 1997), but also calls for an approach to learning and decision making that is tailored to the specific situation.

Although it is tempting to suggest methodologies that enable this kind of thinking to be implemented, such as soft systems methodology, or outcome mapping, or most significant change, in reality this reinforces the notion that tools are useful but no single tool should be expected to provide all of the guidance needed for decision making. Similarly, no single tool should be expected to provide the most appropriate means by which to arrive at guidance. The notion of strange attractors and chaos goes further and suggests that no single *mindset* should be seen as the appropriate to all settings.

Researchers from IBM (Kurtz and Snowden, 2003) have done interesting empirical studies which relate to different kinds of organisational systems, with careful attention paid to those which feature chaotic dynamics. Kurtz and Snowden characterise certain decision-making and learning approaches as most appropriate to different kinds of systems. For example, approaches that focus on sensing incoming data, categorising it and responding in accordance with established practice are most appropriate in systems that are ordered and known, for example, when undertaking business process re-engineering, in which cause and effect relationships are seen as linear and understood. Examples of such approaches are single-point forecasting, field manuals and operational procedures.

By contrast, approaches that focus on sensing data, analysing it and then responding in accordance with expert interpretation and advice are most useful in complicated systems, for example, organisational learning initiatives, or strategic futures planning efforts, where there may be stable cause-and-effect relationships, and in which everything can be *understood*, given sufficient resources and time. Examples are experimentation, expert opinion, fact finding and scenario planning. While structured techniques are desirable, underlying assumptions must also be open to examination and challenge.

Finally, approaches that focus on sensing patterns of change and understanding multiple perspectives, and working to strengthen wanted patterns and weakening the unwanted are most appropriate in complex systems characterised by multiple feedback processes and interaction among many agents, emergent properties, nonlinear relationships and limited predictability. In such systems, many examples of which have been covered already, the application of structured methods will frequently confront new and different patterns for which they are not prepared, and approaches need to be tailored to the nature of the problem.

3.4 Complexity and agency

Certain kinds of systems are made up of individual adaptive agents acting for their own purposes, and with their own view of the situation. Such agents can be powerful in shaping the system. A special class of complex systems is made up of adaptive agents (Concept 8), which react to the system and to each other, and which may make decisions and develop strategies to influence other agents or the overall system. The ways in which these actors interact can give rise to self-organised phenomena (Concept 9). And as agents operate in a system, changes in the system and changes in the other actors can feed back, leading to co-evolution of agents and the system (Concept 10).

Concept 8: Adaptive agents

Outline of the concept

All living things are adaptive agents. Individual people are adaptive agents, so are the teams they work in, and so are organisations. The earth has been described as an adaptive agent in James Lovelock's Gaia hypotheses (Gribbin, 2004). Some complex systems are said to be adaptive or evolving when individual adaptive agents respond to forces in their environments via feedback. Regardless of size and nature, adaptive agents share certain characteristics, in that they react to the environment in different ways (ISCID, 2005). Some adaptive agents may also be goal directed; still more may attempt to exert control over their environment in order to achieve these goals. Agents may have goals that can take on diverse forms, including desired local states; desired end goals; rewards to be maximised; and internal needs (or motivations) that need to be kept within desired bounds. They can sense the environment and respond through physical or other behaviours or actions. They may also have internal information processing and decision-making capabilities, enabling them to compare the environmental inputs and their own behavioural outputs with their goals. They may anticipate future states and possibilities, based on internalised models of change (which may be incomplete and/or incorrect); this anticipatory ability often significantly alters the aggregate behaviour of the system of which an agent is part. They may also be capable of abstract self-reflection and internally generated sources of unpredictable conduct (Harvey, 2001).

Complex systems made of adaptive agents are distinguished by the term *complex adaptive systems*, and they exhibit a number of specific phenomena, which will be seen in the next two concepts.¹¹ The ability of adaptive agents to perceive the system around them and act on these perceptions means that their view of the world dynamically influences, and is influenced by, events and changes within the system.

Detailed explanation

Adaptive agents' behaviour within a system has been characterised in a number of ways (Bithell et al, 2006). Not all adaptive agents exhibit all possible properties – some may be reactive, in that there are units within the system that are capable of exhibiting 'different attributes in reaction to changed environmental conditions'.¹² Others may also be goal-directed, in that they are reactive **and** they direct some part of their reactions towards achieving goals (which may be built-in or an emergent phenomenon). Finally, some agents may be planner units, which are reactive, goal-directed **and** attempt to exert some degree of control over the environment in order to achieve these goals. The terms 'weak agent' and 'strong agent' are used as terms to describe the different capacities of agents.

First, and foremost, adaptive agents are able to perceive their own state, that of other agents and the state of their environment. This perception process is not always exact – rather, it acts as a filter in which some information about the environment may be discarded and other information distorted or only partially assimilated. In a social setting, agents' perceptions include the social and cultural

¹¹ These kinds of elements are also sometimes described simply as agents, and systems of such agents are also sometimes referred to by some as complex evolving systems (Mittleton-Kelly, 2003), owing to the fact that from the mass of interactions and adaptations between entities a process of evolution (and co-evolution) emerges.

¹² See <http://nsdl.org/resource/2200/20061003155450956T>.

context inhabited by the agents, which means that particular environmental context may be perceived differently by different agents.

Agents also have the ability to take action, both in changing their social and natural environments and in interacting with other agents. The conversion of perception into action might not involve a process of internal deliberation. The same perception may not always result in the same action being performed – differences may arise owing to changes in the internal state of the agent.

Agents can retain knowledge of a history of past events, with the ability to learn over time and the potential to make plans for the future. In the case of weak agents, the reaction to the current environment may be influenced by past events in a simplistic way, such that beneficial behaviours are repeated and costly behaviours are not.

More sophisticated agents may have more complex behaviour. For example, so-called strong agents have ‘beliefs’, ‘desires’ and ‘intentions’ that are used to formulate plans for future behaviour. These plans are based both on the current state of the environment and its past history and on the perceived states and history of other agents. The ‘beliefs’ may also have cultural content, so reactions to events can be biased by assumptions about the world. Similarly, ‘desires’ may be conflicting and further complicate an agent’s decision to take action. Between them, the ‘beliefs’ and ‘desires’ lead to the formulation of an ‘intention’ to take action. Unlike weak agents, strong agents are capable of setting and attempting to carry out purposeful, goal-driven behaviour.

Agents interact with each other, potentially in nonlinear ways. This interaction can include observation, communication, physical interaction, spread of disease, imitation of perceived successful behaviour, cooperation to achieve common goals, competition for resources, and hunting, gathering or agricultural practices. Although the response to a given perception may be known beforehand, the interactions between agents mean that the overall behaviour of a system of agents will not, in general, be knowable without running simulations such as agent-based models (which will be covered shortly).

The difference between weak and strong agents plays out here. In the case of reactive agents, most of the emergent larger-scale structure of the system is entirely driven by this interaction. For cognitive agents, while interaction may still be important, their internal perceptions and cognitions play a significant role. Agents can retain a history of interactions with other identifiable individuals, so that, for example, if they make a trade with another agent that later proves to have been unfavourable, they will be less likely to trade with that individual in the future. Furthermore, the representation of realistic networks of social contact is possible, and the effects of this on, for example, formation of opinions, can be investigated.

Finally, agents will generally be diverse in their properties and behaviours. This arises not only because they have divergent properties, such as age, gender and cultural values, but also because their experienced history of the environment and other agents is diverse. Even in a system where the agents begin with the same properties, differences arise over time. On the other hand, there is the possibility of convergence of behaviour and the formation of collective belief through the exchange of information between agents (Doran, 1998). In either case, behaviour will be very different from aggregate average behaviour expected from a set of identical entities in an identical environment.

Where an adaptive agent is part of a system made up of other adaptive agents, it may spend time adapting to the patterns of other agents as well as to the broader system dynamics. By way of example, a policy analyst working in international relations who finds sources of knowledge, ideas and credibility can be seen as an adaptive agent. Groups of such agents can be seen as adaptive agents, generating policy-shifting behaviours, for example. An organisation can be described as an adaptive agent, reacting to the complex stimuli surrounding it. This highlights the point made previously, that complex systems have multiple levels, or hierarchies.

Given the argument that human beings are adaptive agents *par excellence*, it should be no surprise that social, political and economic life are characterised by complex systems made up of adaptive agents – known as *complex adaptive systems*. Ideas about such complex systems stem less from the physical sciences and – again, unsurprisingly – more from fields such as biology, ecology, computing and artificial intelligence. This brings the idea of perception, reflection and conscious action into the complexity science perspective. At its simplest, feedback processes occur where actors receive information about the effects of their activities and their environment, so that they can continue doing something if it has the desired effect, or they think it will have the desired effect, and alter their actions if things do not work as planned.

There may be greater dynamism and unpredictability in a system of adaptive agents whose perceptions can influence the system. For example, the existence of adaptive agents leads to feedback processes such as tipping points and self-fulfilling prophecies. Tipping points are essentially bifurcations, described in Concept 7. Malcolm Gladwell suggested that social tipping points are brought about by three kinds of people – or adaptive agents, in complexity terms – who help to create change. These are mavens – or information gatherers, salespeople – those who are good at convincing other people of their point of view, and networkers – who are able to connect with a wide range of people. Gladwell shows how these three kinds of agents can be identified as playing crucial roles in a range of different ‘tipping points’, from the rise in popularity of the hula hoop to the American War of Independence (Gladwell, 2000).

Self-fulfilling prophecies are also worth exploring briefly here. As outlined in Concept 1, world financial markets are an example of a complex, interconnected system with multiple simultaneous feedback loops (Arthur, 1990, among others). Self-fulfilling prophecies are fundamental to understanding certain market movements. Specifically, when stocks are rising (a bull market), the belief that further rises are probable gives investors an incentive to buy, leading to further rises. At certain points, the increased price of the shares, and the knowledge that there must be a peak after which the market will fall, ends up deterring buyers (negative feedback). Once the market begins to fall regularly (a bear market), some investors may expect further losing days and refrain from buying (positive feedback), but others may buy because stocks become more and more of a bargain (negative feedback). Although this is a simplified model, this basic principle is at the heart of an investment strategy adopted by George Soros called ‘reflexism’.

A number of tools may be used to study the behaviour of adaptive agents in the social realms. Perhaps the most widely utilised is game theory, which codifies the types of decision often facing agents, of how best to fulfil one’s aims and proceed in competitive, or cooperative, environments. This is illustrated by the famous Prisoners’ Dilemma (PD) game (Gillinson, 2004), which has seen wide application within economic and institutional theory. Agent-based modelling (ABM) is a particularly powerful tool which is increasingly being used by complexity theorists. This is outlined in more detail in Box 3.

In addition, social network analysis (SNA) looks at how the interactions between individuals create an overall network with particular properties. SNA uses mathematical models to look at network-wide issues, and can be used to analyse a range of properties of a given network, for example: the extent to which the network is held together by intermediaries; the ability of the network members to access information; the density of the interactions within the network; and the cohesion of relationships into cliques. Each of these aspects of a network might be seen as emergent properties, as they emerge unplanned from the basic interactions of the actors within an organisation (see Concept 3 for more on this).

Box 3: Agent-based modelling (ABM)

ABM is a method which builds artificial social systems ‘from the bottom up’ and provides a powerful analytical tool to model complex, dynamic and highly interactive social processes. It is differentiated from simulations by the fact that the process usually involves detailed empirical insights from real world participant observers. ABM can be used to build model economies or communities that are computer representations having some verisimilitude to real world contexts.

Agent-based models involve three basic ingredients: agents; an environment or space; and rules (Epstein And Axtell, 1996). **Agents** are the ‘people’ of artificial societies. Each agent has internal states and behavioural rules. Some states are fixed for the agent’s life (e.g. agent’s sex, age and vision), whereas others change through interaction with other agents or with the external environment (e.g. individual economic preferences, wealth and cultural identity). The changing nature of states allows ABMs to have ‘non-rational’ agents in model economies or communities. Agents can be heterogeneous; there is no need to rely on representative (homogeneous) agents. The **environment** is a medium separate from agents, on which the agents operate and with which they interact. These environments can accommodate large numbers of people and different types of people such as consumers, producers and policymakers.

Rules of behaviour are defined for the agents and for the site of the environment. These rules also can be identified as agent-to-environment rules, environment-to-environment rules, and agent-to-agent rules. Agents relate their behaviour to each other’s. The culture of a society or community emerges and changes as a result of individuals’ acts and behaviours. In an ABM framework, through a rule-based learning process, agents acquire new information and develop rules of thumb, norms and conventions. With agent-based methods, human behaviour can be modelled as changing and adaptable, not merely as an outcome reasoned from general propositions. The introspective qualities of agents and cultural factors directly create and change the social processes. The agent is allowed to re-examine his/her own behaviour step by step and thus learns by trial and error. If agent-based simulation results demonstrate similarities with the case study or the real world story, it is rational to argue that the modelling approach possesses important characteristics of the underlying processes.

ABM has been contrasted with the two standard methods of scientific enquiry (Axelrod, 1997) – induction and deduction. Induction is seen as the discovery of patterns in empirical data, whereas deduction involves specifying a set of axioms and proving consequences that can be derived from those assumptions. Agent-based modelling is like deduction, in that it starts with a set of explicit assumptions but it does not then go on to prove theorems. Like induction, it generates simulated data that can be analysed inductively; unlike induction, simulated data come from a rigorously specified set of rules rather than direct measurement of the real world. Whereas the purpose of induction is to find patterns in data and that of deduction is to find consequences of assumptions, the purpose of agent-based modelling is to aid intuition.

Example: Adaptive agents – A geographers view

The figure shown below gives an outline view of an agent-based modelling system. Several key points are represented in this diagram. Interactions with the environment take place through direct impact on physiology, gathering of resources and other agent actions. Interactions between different types of agent are crucial to the evolution of the agent-environment system as a whole, encompassing demographics, spread of disease, competition, cooperation and other social processes. The agent’s perceptions of the environment may lead to direct reaction – such as fleeing from predators – or to a cognitive process that allows for complex considerations including history, culture and beliefs, and emotional state. The perceptions need not be complete or accurate – the possibility of inadequate information or bias on views of the world can be allowed for.

The agents are embedded in an environment, with which they interact (Russell and Norvig, 2003). This environment is not restricted in character to the physical world, but might be anything that is not represented using the agents themselves. For example, in models of land-use change, the environment is represented by sub-models for insolation, rainfall, soil moisture, topography and other properties. The environment has a direct impact on an agent’s ability to carry out its functions, and may also provide the resources needed by the agent for its function. Similarly, economic agents may require representation of a marketplace and the facilities to buy and sell goods (Teshfatsion, 2002).

Figure 12: Factors affecting adaptive agents in geographical analysis

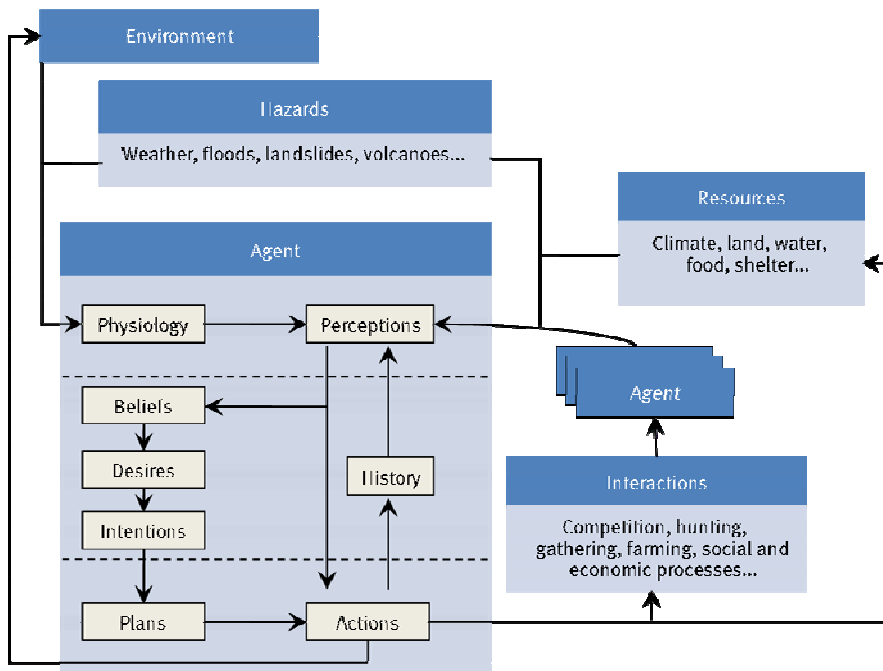

Source: Bithel et al. (2006).

Implication: Build awareness of influences on adaptive agents, their incentives and relative capacities

The concept of adaptive agents in the aid system emphasises the centrality of human agency in international development and humanitarian work, the ways in which the system inhibits or permits adaptation, and the ways in which adaptation at different levels gives rise to systemic phenomena.

This in turn requires a focus on the lives of a wide range of social actors committed to different strategies, interests and political trajectories (Long, 1984). Actor-oriented analysis (Long, 2002) is one way in which this stance has been adopted in the aid world. This focuses on how macro phenomena and pressing human problems result, intentionally and unintentionally, from the complex interplay of specific actors' strategies, projects, resources, discourses and meanings.

For example, for many outside the humanitarian sector it comes as a surprise that communities in drought-stricken regions actively seek out and use resources, set up various networks of relationships and interactions, and exhibit a number of coping strategies. This notion of adaptive capabilities of communities may be particularly relevant for how international humanitarian assistance is designed and implemented – estimates suggest that 'no more than 10% of survival in emergencies can be contributed to external sources of relief aid' (Hilhorst, 2003).

A number of tools may be used to study the behaviour of adaptive agents in the aid world. Agent-based modelling, as described in Box 3, is potentially very useful. One of the most powerful applications to date has been in the field of epidemiology. The Swiss have made widespread use of ABM in epidemiology to model the propagation of disease – e.g. the Swiss Tropical Institute and malaria.

Given the potentially complex nature of the international aid system, it is important to understand the role of clusters of actors, or networks. One method of understanding these is SNA, which looks explicitly at the structure of the network resulting from these relationships and interactions. SNA offers insights through determining the resilience of networks, the level of connectedness between key agents, and the formation of cliques. SNA uses mathematical principles which – it is argued – are employed 'intuitively by people trying to solve complex problems which involve many relationships between many things' (Johnson, 1995). An important factor here is to grasp that the network has

properties as well as parts, and to analyse those properties that arise from the interactions between the network members. This resonates in many ways with the notion of emergence.

Given the web of relations and interactions among various communities, institutions and countries that characterises the aid world, such approaches have the potential to bring about a shift in perspective to one that emphasises the importance of understanding relationships and behaviours. Some initial movement towards this attitude can be perceived. For example, it has been suggested that development projects should regard ‘relationships management as important as money management’ (Eyben, 2006). Rather than seeing aid as an outside force or ‘catalyst’ acting on a developing country, which can intervene without itself being affected, aid agencies should be ‘ready to be influenced by local actors’ and ‘examine more closely with whom it relates and which relationship networks it supports’ (ibid).

Adaptive management practices, which seek to make maximum use of the capacities of individuals working on a project or programme, can also be a useful approach – the overall goal being to learn by experimentation in order to determine the best management strategies in a given setting. Although it is being used in some settings, it is worth more exploration among aid agencies.

The behaviour of adaptive agents is at the heart of a planning, monitoring and evaluation tool called outcome mapping. This methodology, which incorporates an appreciation of complex systems, has as its primary focus the changes in behaviour (defined as actions, attitudes and relationships) of those stakeholders with whom a programme or project interacts directly. These direct stakeholders are referred to as boundary partners in the outcome mapping terminology. The ideal application of the method requires members of an aid programme or project to work with these actors in order collectively to specify hoped-for changes and to identify specific activities that will help contribute to these changes.

One of the critiques levelled at complexity science is that there is no real way of dealing with power. However, in the aid context, the concept of adaptive agents enables understanding of how certain agents may act in order to withhold or suppress the adaptive capacities of others. To cite a few: specific groups who are excluded or marginalised in communities, rural producers who are at the mercy of wholesalers, local NGOs who are at the behest of international agencies, developing country officials who are excluded from trade negotiations. The list goes on – the aid system is full of examples of strong and weak agents that interact in ways to maintain certain kinds of power balances. There are further implications of power and adaptive agents in complex systems, in terms of how their capacity to act together in groups (self-organisation, see Concept 9) and how they evolve in relation to each other and the system (co-evolution, see Concept 10).

Concept 9: Self-organisation

Outline of the concept

Self-organisation is where macro-scale patterns of behaviour occur as the result of the interactions of individuals who act according to their own goals and aims and based on their limited information and perspective on the situation.

The concept of self-organisation echoes emergent properties, and the fact that a complex system cannot be understood as the sum of its parts, since it may not be discernible from the properties of the individual agents and how they may behave when interacting in large numbers. For example, studies have shown how highly segregated neighbourhoods can arise from only low levels of racism in individuals (Schelling, 1978), as well as how cooperative farming practices can arise from the interaction of self-interested farmers owing to the necessities of farming methods and the local ecosystem (Lansing and Miller, 2003). The market is probably the exemplary self-organising system. As Nobel Laureate Ilya Prigogine has put it (in Waldrop, 1994): ‘the economy is a self-organising system, in which market structures are spontaneously organised by such things as the demand for labour and demand for goods and services’.

Detailed explanation

Westerly et al. (2006) argue that:

‘Bottom-up behaviour seems illogical to Western minds ... we have a hierarchical bias against self-organisation ... [which is displayed in] our common understanding of how human change happens, especially in organisations. Our popular management magazines are filled with stories of the omniscient CEO or leader who can see the opportunities or threats in the environment and leads the people into the light. [However,] self-organisation is critical to achieving [change].’

It has been argued that in international development there is a ‘reliance on top-down oversight by, and help and guidance from, global agencies ... local and regional actors are of secondary importance’ (Rihani, 2005).

While many have argued that complexity science as a way of determining social policy may be an articulation of free market ethos as opposed to regulation or government involvement, it is important to note that self-organisation is in fact a neutral concept. A study of the role of self-organisation in the Rwandan genocide (Bhavnani, 2006) argues that the levels of mass participation can be partly explained by a self-organising emergence of a violence-promoting norm among the Hutu community, such that killing Tutsis became the norm among members of the ethnic group. This self-organisation, which Bhavnani demonstrates using ABM, was driven by complex patterns of interactions among individuals forming Rwandan society. The study concludes that the frequently attributed causes of the genocide – including the death of the Rwandan president in a plane crash, the ethnic tensions and the post-war culture in Rwanda at the time – are at best partial explanations that need to be related to the bottom-up collective processes of violence through which the genocide unfolded. It should be apparent that the various ordered structures and patterns that emerge from a mass of complex interactions need not necessarily be ‘good’ for all individuals who are part of them.

Self-organisation, then, describes how the adaptive strategies of individual agents in particular settings are able to give rise to a whole range of emergent phenomena. To take one commonly cited example, in situations where systems exhibit high levels of unpredictability, adaptive behaviours among individual agents can lead to the emergence of resilience.¹³ The agents may try many strategies in the hope that some of them will be able to survive whatever challenges or surprises they encounter. For example, businesses often develop many diverse prototypes but abandon them if they do not meet specific targets. This strategy requires a willingness to accept many failures and/or to deal with the same challenge in different ways. Self-organisation can be seen as emergent phenomena arising from the interactions of adaptive agents.

In the case of weak agents (or reactive), self-organisation may be driven entirely by their interactions with other actors. For strong (or cognitive) agents, interaction may still be important, but their internal cognitive structures, beliefs and perceptions are also significant.

Work on change processes in adaptive ecosystems (Hollings, in Westley et al., 2006) shows that self-organisation need not necessarily be about change, but equally can relate to resilience in the face of change. The capacity for resilience can be seen as a cyclical process with four (continuous and often simultaneous) stages: release, reorganisation, exploitation and conservation. Consider this in relation to an aid agency. **Release** (or creative destruction) involves the destruction of some existing organisational structures. This often frees up essential resources, such as an organisation restructuring to enable growth in new areas, or cycles of destruction in economies releasing innovation and creativity. After release is **reorganisation**, where there is competition for the newly available resources. New opportunities are sought and connections made, similar to the number of new, small projects that are established following a restructuring, competing for space. Then comes **exploitation**, where ‘the system invests heavily in the dominant species or winning proposal’ (Hollings, 2001), and available resources are drawn on heavily; the themes and ideas that gained the upper hand now reap the

¹³ There is a growing body of work that looks at resilience. See, e.g., Gunderson (2003) and Folke et al. (1998).

rewards of resources and skills, growing rapidly. The fourth stage is the **conservation** or maturity stage, where the dominance of elements limits the opportunity for new growth; programmes have now grown large and dominate the landscape, leaving little room for each other to expand and allowing scarce resources for smaller, more innovative projects to emerge.

The idea of resilience through self-organisation is also present in the concept of autopoiesis, which describes how living systems 'are organised in such a way that their processes produce the very components necessary for the continuance of these processes' (Mingers, 1995). In the context of social systems, an interesting manifestation of autopoiesis is the processes through which systems and organisations have a capacity to change their internal structure while maintaining their externally and internally perceived organisational identity. In this sense, autopoiesis and homeostasis may be seen as an adaptive agent's response to 'edge of chaos' systems. A previous ODI working paper (Warner, 2001) argues that autopoiesis can be observed in the ways that community groups can reorganise within themselves in order to effectively manage available natural resources.

Example: Leadership and self-organisation

The traditional perspective of leadership is based on a view of organisations as mechanical systems in which basic laws are in operation (Capra, 1996; Stacey, 1995). From this view, organisations are made up of highly prescriptive rule sets, formalised control and hierarchical authority structures, leading to well defined responses to a changing but knowable world. The aim of the organisation is order, and leaders are expected to contribute to this stabilisation through **directive** actions, based on planning for the future and controlling the organisational response. However, in complex systems, the future cannot be predicted, and change cannot be directed. Marion and Uhl-Bien (2001) suggest that in complex systems there is a need for different leadership qualities.

Empirical research over a five-year period, including an in-depth review of a values-based organisation (Plowman et al., 2007a; 2007b) has highlighted a number of vital leadership qualities. Leaders of self-organised adaptive agents are characterised by their ability to 1) disrupt existing patterns; 2) encourage novelty; and 3) use 'sensemaking'. Each of these is worth exploring in a little more detail.

Leaders **disrupt existing patterns** in organisational behaviour by creating and highlighting conflicts, rather than stabilising the organisation. For example, in the organisation under study, successful leaders made several radical and controversial changes, internally and externally, and used communications to bring attention to these changes as a way of highlighting the importance of the ongoing change. This contrasts with the traditional leadership approach of creating predictable behaviours by minimising conflict and eliminating uncertainty. Another way for leaders to disrupt existing patterns is by acknowledging and embracing uncertainty, refusing to back away from uncomfortable truths, talking openly about the most serious issues, and challenging institutional 'taboos'. This can encourage more open thinking about these issues, and provide legitimate ground for new ideas and patterns to emerge. Again, the traditional leadership approach was to shy away from difficult conversations and focus on hoped-for certainties.

Leaders **encourage novelty**, looking for innovation rather than innovating. They do this by generating and reinforcing simple rules which provide 'tenacious rigidity about principles and complete flexibility in how to go about carrying out the principle'. Facilitating interactions was also key, in that it enabled staff to start interacting with each other in new and different ways. Instead of creating a single 'assembly' point, the successful leaders kickstarted many small group interactions, increasing connections between people and creating a richer and more unpredictable dialogue within the organisation. This contrasts with the traditional model of a leader as using command and control approaches, and maintaining strict hierarchies of reporting relationships.

Finally, leaders acted as '**sensemakers**', interpreting rather than creating change. In any organisation, leaders should work to give meaning to what is happening, but this is particularly the case in complex organisations. In such organisations, successful leaders need to act as 'tags' (Holland, 1995). Tags enable specific behaviours by directing attention to what is important and what things mean. Leaders

become tags when others recognise that they symbolise deeper messages of change. Leaders also make sense of emergent events through reframing, either in the principles of the organisation, or in the context of the hoped-for changes and how important they are. And leaders label behaviours in ways that provide coherence and shared understanding. Using language carefully, leaders are able to articulate meanings, lend weight to collective action, and clarify the hoped-for image of the organisation.

The overall conclusion was that the leaders of the organisation played a key role in radical transformation of the organisation, not by specifying it or directing it but by creating the conditions which allowed for the emergence of such change.

Implication: Use enabling approaches to empower actors at different levels of the team, organisation and system

An appreciation of the potential for social patterns and structures to emerge in a self-organised manner from the perspectives of the specific actors adds a new focus for development interventions. First, one should be prepared to approach problems as patterns of self-organisation; secondly, this needs to be recognised so that more beneficial and robust solutions can emerge. Given this, agencies should look to give actors the freedom to do this and help establish feedback mechanisms to make sense of their environment.

The actors are not restricted to the poor – from the complexity perspective, all actors are in ‘local’ interactions, whether they are at the top of organisational hierarchies or at the outside of agencies receiving assistance (Khan, personal communication, 2007). The key message is that change, order and resilience cannot be imposed from the outside or from the top down, but that these can be achieved through the adaptive tendencies of individual agents operating throughout a system. The occurrence of self-organisation in complex adaptive systems demonstrates how structured and organised relationships need not necessarily have been the result of the work of a coordinating body or have come through some hierarchical process.

An understanding of self-organisation means looking for the possible balances and interplays between the forces attempting to organise a system from the top down and the reactions of the agents within a system to each other and to the environment in which they act. This has resonances with policy processes in international development. The work of Lipsky (1983) on street-level bureaucrats highlights that, while in some situations hierarchical actions may be appropriate and possible, in other situations it may be more important to facilitate the self-reorganisation of elements in a system, to produce a new order that is more beneficial for those involved by creating an ‘enabling environment’.

Looking at development through the complexity lens shows that the landscape of various issues and problems is shaped by patterns of self-organisation through the continual interactions and interconnectedness of different agents acting within, adapting to and changing their environment. This requires a different approach to the current ‘command and control’ culture of many governmental bodies, and a departure from the ‘mechanistic’ mode of thinking behind policy.

To foster change it is important to look to facilitate the rearranging of these agents and interactions in a way which will produce the desired effect. This involves ‘mobilising the power and the resources to change things’ by looking ‘to unlock resources claimed by the status quo’ (Westley et al., 2006). To do this, it is important to understand the tensions, feedback processes and simple rules stemming from actors’ incentives, beliefs and actions, which hold the current pattern together. As the success of one organisation depends on those with whom it interacts,

‘... different individuals and organisations within a problem domain will have significantly different perspectives, based on different histories, cultures and goals. These different perspectives have to be integrated and accommodated if effective action is to be taken by all the relevant agents’ (Chapman, 2004).

Since many patterns and structures observed in development emerge from the characteristics and adaptation of other actors, it is important to understand how actors see their own position and their environment, and how they have come to this position through a need to satisfy various needs, etc. This implies that ‘one key principle for negotiating change is an appreciation of others’ positions’; one of the ‘key components of emotional intelligence’ (Haynes, 2003).

Appreciating the value of those affected by a problem’s perspective on it and, in general, the resilience of self-organised structures should encourage an understanding that many problems may be **better** addressed through facilitating self-reorganisation. This principle can be seen in the rise of ‘governance’ in development, as a way to allow countries to better deal with their problems themselves rather than through an externally applied solution. Jessop (2003) argues:

‘in the face of intensification of societal complexity ... [we should see governance as] the complex art of steering multiple agencies and institutions which are operationally autonomous from one another and structurally coupled through ... reciprocal interdependence ... Governance appears to have moved up the theoretical and practical agenda because complexity undermines the basis for hierarchical top-down control.’

Self-organisation speaks for the potency of looking to influence all those people and organisations affected by a problem, to strengthen relationships among those working towards complementary goals and to bring them together to facilitate change on a large scale. This is echoed by those emphasising the importance of relationships management to aid agencies (Eyben, 2006) and the ‘informal networking’ approach to community development (Gilchrist, 2000). It also leads to a focus on multi-stakeholder participatory processes.

In order to self-organise for their benefit, actors must have the freedom to act and get feedback on their actions to better adapt to their situations. Incorporating such freedom within the accountability frameworks of a development agency might involve granting an ‘earned autonomy’, where a unit might be allowed freedom to determine its course after proving its worth. In this situation, a centrally given policy would look to ‘establish the direction of change, set boundaries not to be crossed, allocate resources and grant permissions where units can exercise innovation and choice’ (Chapman, 2004).

In order to be able to successfully adapt and organise themselves in the face of different problems (Hemelrijk, 2005), actors need feedback about their local environment. The poor position of many communities may owe to a lack of information about the environment, leading to them not being in the best position to deal with new problems affecting them. However, ‘many agents ... without seeing the dynamics of the larger system, can produce a self-organising strategy that effectively deals with a complex and out of control environment’ (ibid). Therefore, local-level and ‘rapid-feedback’ indicators ‘help individuals, agencies and businesses make the best choices for their own actions’, and they can ‘work together to improve the system [and their position in it] so long as they get feedback and so long as they have the capacity to respond’ (Innes and Booher, 2000).

It is important to note here that complexity science is absolutely not a means by which to justify a particular kind of ideological approach. To be explicit, self-organisation does not in and of itself give a justification of the ‘invisible hand’ of the market leading to beneficial outcomes. This is because there is no proof of the assertion that agents self-organising for personal economic benefit produce the emergent macroscopic effect of ‘generally beneficial for all’, or even that it results in ‘overall economic benefit’. In fact, Arthur’s work on complexity in economics (1999) shows how systems of reasonably rational agents (operating under ‘bounded rationality’) do not lead to a system that behaves reasonably rationally overall.

Concept 10: Co-evolution

Outline of the concept

When adaptable autonomous agents or organisms interact intimately in an environment, such as in predator-prey and parasite-host relationships, they influence each other’s evolution. This effect is called co-evolution, and it is the key to understanding how all large-scale complex adaptive systems

behave over the long term. Each adaptive agent in a complex system has other agents of the same and different kinds as part of its environment. As the agent adapts to its surroundings, various elements of its surroundings are adapting to it and each other. One important result of the interconnectedness of adaptive bodies is the concept of co-evolution. This means that ‘the evolution of one domain or entity is partially dependent on the evolution of other related domains or entities’ (Kauffman, 1995).

Detailed explanation

Co-evolution brings a focus on the ‘evolution of interactions’, whereby the characteristics or tendencies of an agent may be powerfully shaped by its interactions with other agents or the wider system. Agents continuously influence and are influenced by their environment in a reciprocal fashion that changes the interacting environment and the agents themselves. To take a commonly cited example, elephants thrive on acacia trees, but the latter can only develop in the absence of the former. After a while, the elephants destroy the trees, drastically changing the wildlife that the area can sustain and even affecting the physical shape of the land. In the process, they render the area uncongenial to themselves, and they either die or move on. The land is adapting to the elephants just as they are to it (Jervis, 1997). As the Maasai proverb has it: ‘cows grow trees, elephants grow grasslands’.

Kauffman (1996) argues that there are two distinct levels of co-evolution: interspecies and system wide. Interspecies co-evolution is widely recognised and there are numerous ecological examples. Numerous examples exist of avian and insect species with co-evolved feeding and breeding strategies that depend on the parasitic or predatory practices of other species. For example, Angraecoid orchids and African moths co-evolve because the moths are dependent on the flowers for nectar and the flowers are dependent on the moths to spread their pollen so they can reproduce. The evolutionary process has led to deep flowers and moths with long probosci. Mutualism can also be used to explain co-evolution between predator and prey species. For example, in the case of the rough-skinned newt and the common garter snake, the newts produce a potent nerve toxin that concentrates in their skin, to which garter snakes have evolved a resistance, enabling them to prey upon the newts. The co-evolving relationship between these animals has resulted in an ‘evolutionary arms race’ that has driven toxin levels in the newt to extreme levels.

System co-evolution is a large-scale process through which the interaction of one or more co-evolved species with the system results in changes so fundamental that all species in the system must adapt and the system itself change in significant ways. Human interaction with the global environment and the increasing numbers of extinctions is a commonly cited example of this phenomenon. Given the above, adaptive agents can be said to have ‘porous boundaries’, in that they are significantly shaped by their interrelations with others, with no hard division between the doer and those that are ‘done-to’ (Westley et al., 2006).

Work in biology on ‘fitness landscapes’ is an interesting illustration of competitive co-evolution (Kauffman, 1995) A fitness landscape is based on the idea that the fitness of an organism is not dependent only on its intrinsic characteristics, but also on its interaction with its environment. The term ‘landscape’ comes from visualising a geographical landscape of fitness ‘peaks’, where each peak represents an adaptive solution to a problem of optimising certain kinds of benefits to the species. The ‘fitness landscape’ is most appropriately used where there is a clear single measure of the ‘fitness’ of an entity, so may not always be useful in social sciences.

However, if fitness is defined broadly as ‘optimal trade-offs’, then there is greater applicability. For example, in the Balinese water temples cited below, ‘fitness’ is viewed as the deliberate efforts of farmers to cooperate in setting water irrigation management patterns so as to maximise both pest control and harvests. Adaptive agents continuously move around a changing fitness landscape, continually changing their and others’ environments and continually adapting to the changes in others. This has been taken by some as a reflection of how the success of any organisation’s strategy crucially depends on the strategies of others. Fitness landscapes can be a powerful metaphor to guide thinking about co-evolution, and to highlight various features of complex adaptive systems.

Co-evolution has implications for many aspects of human systems, but perhaps the most important relates to setting of targets – once a measure becomes a target, it ceases to become a measure. The implication is that measurement is distorted because of the existence of a target: the creation of a target is in fact an intervention in itself that has consequences and incentives, such that the system and the agents evolve together to maintain the *status quo*.

This is highlighted with respect to the concept of homeostasis. Originating in biology and used heavily in cybernetics, homeostasis is a concept that illustrates how adaptive agents seek to maintain certain factors within a desired range, often exerting energy to maintain stable levels (this is a negative feedback process).

Perhaps the clearest example is how the human body works to regulate its temperature. In the social realm, there is evidence to believe that a partially effective vaccine for AIDS or malaria may increase the rate of infection as people respond by cutting back on other precautions (Jervis, 1997), achieving a certain desired trade-off between risk and behavioural convenience. One of the most famous examples of homeostasis is that articulated by James Lovelock in his Gaia theory, which states that the entire mass of living matter on Earth functions as a vast homeostatic super-organism that actively modifies its planetary environment to produce the environmental conditions necessary for its own survival. In this view, the entire planet maintains homeostasis.

Other kinds of homeostasis include risk homeostasis, where, for example, people who have anti-lock brakes have no better safety record than those without anti-lock brakes, because they unconsciously compensate for the safer vehicle with less safe driving habits. It has also been applied to scientific thinking by postmodernists, who argue that there are societal power centres governed by a principle of homeostasis. An example is the scientific hierarchy, which will sometimes ignore a radical new discovery for years because it destabilises previously accepted norms (Lyotard, 1994).

There has been increasing attention in the social and political realms to understand individual behaviour and its relationship to social institutions by application of the concept of coevolution. Work by the Santa Fe Institute (Bowles et al., 2003; Bowles and Choi, 2003), focusing on small-scale societies, has identified a mutual interaction between social behaviour and social interaction – over time, behaviour and institutions evolve in an interrelated way. In this evolution, the relative fitness of behavioural strategies and of specific social institutions determines their success over time.

This has been demonstrated with regard to institutions such as through resource sharing, alongside which supporting social group behaviours have co-evolved, despite the costs this poses at the individual level. This is explained by reference to the contribution such institutions make to the evolutionary success of the group as a whole.

An implication of this work is that altruistic behaviours and warfare as a group practice may have co-evolved, the frequency of warfare contributing to the evolutionary success of altruism and the presence of a significant fraction of altruists in a group contributing to a group's war-making capacity (Bowles and Choi, 2003).

This example highlights how co-evolution emphasises not only how a particular agent adapts to and is shaped by the agents in a system, but also how agents adapt to the overall properties or institutions that result from individual interactions. In this way, the various agents of a complex adaptive system co-evolve with each other, as do the macro properties and institutions.

Example: Balinese water temples

In Bali, rice is grown in paddy fields fed by irrigation systems, which are dependent on rainfall. Rainfall varies by season and elevation and, in combination with groundwater inflow, determines river flow. Traditional irrigation begins with a weir in a river, which shunts all or part of the flow into a tunnel that emerges downstream, lower ground, routed through a system of canals and aqueducts to the summit of a terraced hillside. By controlling flow of river into terraced fields, farmers are able to create pulses in

important processes, e.g. the cycle of wet and dry phases alters soil pH, with numerous effects on the quality of the soil. Flooding and draining of terraces has effects on pest populations. Cooperation between farmers with adjacent terraces can create a fallow area over a sufficiently large area to deprive rice pest of their populations, but if too many farmers follow an identical process, there will be peak irrigation water demand at the same time, and there may not be enough water for all, especially as there are only weirs every few kilometres. Water sharing and pest control are opposing constraints – optimal level of coordination depends on local conditions.

Simulation models are uniquely appropriate for addressing issues of adaptation and determinism in the development of complex social systems. Extending the use of simulations in biology, which might focus on the co-evolution of algae and Antarctic sea ice, this analysis moved from natural ecosystems that evolved through a process of ‘blind’ natural selection. Systems of interest to anthropologists are by definition shaped by conscious human intentions. Life in the sea ice of Antarctica is thought to have evolved opportunistically through the random effects of natural selection. On the other hand, centuries-old Balinese rice terraces would cease to function if the Balinese farmers stopped managing them. The introduction of human agency into natural ecologies blunts the tools designed for the study of such ‘blind’ co-evolutionary processes. As the authors of the study (Lansing and Miller, 2003) suggest:

‘Historical evolution of irrigation systems, rice terraces and water temples [is an example of] engineering of the landscape as generations of Balinese farmers cleared forests, dug irrigation canals, and terraced hillsides to enable themselves and their descendants to grow irrigated rice ... [There would be] false starts, abandoned irrigation works, conflicts ... [but] records would show the traces of conscious design ... the realisation of each generations plans changed the world for their descendants...’

The study uses ecological simulation modelling to illuminate the role of human agency in reshaping the ecosystem and the emergence of cooperative behaviour among Balinese farmer. The ‘fitness value’ or payoff of different farming strategies changes as a result of the complex interactions between irrigation networks and the domesticated ecology of the rice terraces. A spontaneous process of self-organisation occurred when temples were allowed to react to changing environmental conditions over time in a simulation model. Artificial cooperative networks emerged that bore very close resemblance to actual temple networks. Tellingly, as these networks formed, average harvest yields rose to a new plateau. Subsequently, the irrigation systems that were organised into networks were able to withstand ecological shocks such as pest outbreaks or drought much better than those that lacked networks. The networks have a definite structure, which leads to higher sustained productivity than would be the case if they were randomly ordered. Structures emerge without conscious planning through process of co-evolution. Water temple networks may represent a type of social organisation: a self-organising managerial system shaped by a process of agents co-evolving to a changing environment.

Implication: Look for and work with the effects of co-evolution

An understanding of tendencies of adaptive agents to co-evolve in response to opportunities and constraints put on them highlights the drawbacks to certain kinds of development and humanitarian interventions. This means it is important to pay attention to the multi-faceted nature of many problems in development, and the frequency of unintended and indirect effects. In this environment, ‘policies are often found to overlap or be in conflict and the policy system is unduly complicated producing inefficient or even ineffective solutions and generating new problems’ (Briassoulis, 2004).

For example, there is evidence of a mutual construction of events by bilateral donors and relief agencies in a way that suits both agents’ ends. This is a clear example of a potentially damaging kind of co-evolution. As the authors of a HPG study suggest:

‘The [decision making] process involves finding a common “narrative” about the situation in question that fits the priorities of agency and donor alike, and allows the two to be reconciled. While this narrative may indeed be based on sound analysis, and may lead to appropriate responses, there are structural reasons why it may not do so, given the potential organisational interests of both parties in the acceptance of one narrative over another. ... [There is] evidence of

mutual “construction” of crisis by agencies and donors in a way that suits both their ends. Given the tendency of contract-based relationships to be evaluated against contracted input and output rather than actual outcomes, there is a danger of circularity – problems are “constructed” and “solved” in ways that may bear little relation to actual needs’ (Darcy and Hoffman, 2003).

Given the above situation, the natural inclination of agencies may be to not ‘rock the boat’ – the perception of such interdependence may give rise to highly risk-averse behaviours. More worryingly, such interdependence can be used to further the interests of specific agents who control resources. Examples abound, such as the debate on conditions attached to aid, and the conflation of military and humanitarian goals in the war on terror. At a more day-to-day level, there are legitimate concerns that co-evolution shapes the way in which particular actors behave and perceive local contexts. When the idea of the log frame is successfully passed on – usually ‘downwards’ from a donor to an international NGO, or from an international to a local NGO – and adopted, it can create a false belief that everyone is reading the resultant logical frameworks in the same way. For example, an expatriate development worker might feel s/he understands the work of a local NGO if the staff can follow the LFA and produce a clear logical framework. Unfortunately, the most successful local NGOs, those which repeatedly get foreign funding, are those which have learned to play the game and can present their thinking in a logical framework in order to get funding. This creates a distortion of the relationship between so-called ‘partners’; the local NGO has to adapt to the alien way of thinking, whereas the foreign partner, whether NGO or donor, does not need to adapt to the local context, and relates to the nature of adaptive agents highlighted in Concept 8. Some have argued, on the above basis, that the log frame represents an ideology rather than being an objective technical management tool. This highlights the fact that co-evolution in social systems is intimately tied to issues of power and control.

It is crucial to see oneself and one’s own organisation and actions as part of a wider system, and pay attention to the way that various actors may adapt and react to various constraints put upon them and opportunities made available, incorporating into the design an understanding of how they may react to a proposed policy and a willingness to engage in an iterative interaction if the reaction is unanticipated (Khan, personal communication, 2007). It also means taking into account the possible effects of homeostasis, which can often negate any hoped-for gains made by policies, in much the same way ‘risk homeostasis’ leads to drivers who react to improved safety measures by driving faster and hence more dangerously. Where there are clear incentives to co-evolve because not co-evolving would lead to a sub-optimal position, we can expect a degree of homeostasis.

In the context of international aid agencies, there may be a degree of what can be called power homeostasis. The aid system tends to locate power, control and legitimacy in the hands of richer countries and their representatives. This may mean that there are some groups of actors not able to self-organise or to co-evolve with other actors.

One somewhat authoritarian approach is to seek to constrain other actors in order to minimise the number of interconnected factors and reduce unintended consequences. For example, many rock music festivals do not publicise the availability of free medical care, in order to prevent a ‘moral hazard problem’. However, an approach that requires withholding information about one’s actions and purposes may be inappropriate, impractical or impossible in some circumstances. Alternatively, one could plan specifically based upon the likely ‘unintended’ consequences of an action. One such method is known as the Lijphart effect, where ‘the belief that undesired results are likely if decision-makers do not take unusual steps may lead them to take such steps and prevent the “natural” outcome from occurring’ (Jervis, 1997). Again, this may not always be a relevant option.

This issue brings into question the nature and effectiveness of clear and explicit indicators of progress which are conceptualised and defined by external parties. As Jervis (1997) argues, the interactions among perceptions, behaviour and measurement mean that the **meaning** of a particular yardstick or indicator will be altered by its being used to measure progress or performance. Regardless of whether adaptive agents are co-evolving in conscious ways to manipulate results, a consistent reading of the indicator will be undercut by processes set in motion by the behaviour of various actors.

This is similar to the warning against the assumption of 'all other things being equal'. If all things were equal, it might be preferable to financially bolster medical aid programmes with the highest survival rate of beneficiaries. The multiple direct and indirect effects of using such a yardstick, however, as the system reacts to an actor's behaviour, cause undesired effects. For example, this ignores the fact that better programmes may focus on beneficiaries who are in greatest need. However, using survival rates would give those managing aid programmes incentives to avoid more difficult cases and leave those in the greatest need for others to deal with. This is not to say that no indicators can be useful, but it does suggest that they must be carefully formed. It is likely that they will have to be rooted in the context in which they are used.

4. Conclusions

In this exploration of the key concepts of complexity science, we have drawn on the scientific basis of each concept, provided examples of how they have been applied in political, social and economic realms, and reflected on implications for international aid. Specific terminology may have been new to some readers, but many will have – at least partially – recognised the ideas and principles underlying them, because these resonate with many of the experiences of those working in the aid world. Some of the concepts may not seem very startling or new; others may seem more radical and challenging.

In this concluding section, we will reflect on the questions we posed at the start of our journey, namely:

- How do the concepts of complexity science fit together?
- What do the complexity science concepts offer to those facing international development and humanitarian problems?
- How does complexity science differ from existing ways of understanding and interpreting problems?
- What kinds of phenomena can complexity science help us better understand?
- What is the value of complexity science for those engaged in humanitarian and development work? Does it tell us anything new?
- What kinds of practical uses are there for complexity science in international aid?

We conclude with our own stance with regards to the application of complexity science in international aid work, and outline the challenges facing the take-up of these ideas across the sector.

4.1 How do the concepts of complexity science fit together?

The concepts outlined here illustrate a range of ideas and perspectives, many of which are closely related to each other. When starting our exploration, we were struck by how few **successful** attempts there had been at making a clear and comprehensive explanation of the different concepts of complexity and how they fit together. After struggling for some time with organising the key concepts, we settled on what felt like the most pragmatic categorisation– albeit an imperfect one - into concepts which relate to *systems*, *change*, and *agency*.

In doing so, we realised that complexity science as a set of concepts was distinct from many other fields of intellectual endeavour – from sociology and economics through to physics, mathematics and philosophy. Following Capra (1996), it is useful to note that scientific knowledge is usually characterised with reference to the metaphor of a building. The ease with which the terms ‘foundations’, ‘pillars’ and ‘structures’ of knowledge are used indicates the prevalence of this architectural metaphor. Our difficulty was in trying to represent complexity science concepts as though they were parts of a building. They are, in fact, more like a loose network of interconnected and interdependent ideas. A more detailed look highlights conceptual linkages and interconnections between the different ideas. The best way to see how they fit together in the development and humanitarian field would be to try to apply them to a specific challenge or problem.

This notion of complexity as a **network** of ideas means – perhaps disturbingly – that a firm foundation for complexity may not be achievable. This notion contrasts sharply with the perspective that ‘the grand edifice’ of complexity is yet to be erected, as highlighted in our introduction. According to some, this is because of the relative newness of complexity science in the social sciences and indeed in the physical and biological sciences.

Based on our reading, however, a grand edifice may never be erected along the lines of, for example, neoclassical economics. If this is the case, it may be that we need to become better accustomed to a network-oriented model of how knowledge and ideas relate to each other.

4.2 What do the complexity science concepts offer to those facing international development and humanitarian problems?

There are numerous debates as to the applicability of complexity concepts to social, political and economic life. Some authors argue that the concepts are directly applicable to social sciences, others that they provide metaphors that can shape thinking, while the most critical argue that they are simply not applicable outside of the hard sciences. Ison et al. (1997) suggest that complexity science enables users to bridge natural, socioeconomic and management sciences by serving either as explanations of phenomena or as metaphors which can guide thinking and action. Sokal and Bricmont (1998) argue that hard sciences are not a stock of metaphors for instant and unqualified use in social sciences. Sellier (1997) points out the room for backsliding that metaphors afford their authors: when a strict scientific review reveals inconsistencies, they can always fall back on the ‘but it’s only a metaphor’ argument without in fact solving those problems the metaphor was supposed to help them within the first place.

Paul Krugman, in his analysis of the neoclassical economic model (Krugman, 1996), argues that it provides a set of **useful, simplifying fictions about the world which allow us to cut through the complexities of the real world**. In the case of international development and humanitarian work, the main difficulty with such simplifications of complex realities is that they leave aside so many of the important elements of those realities which increasingly beg for attention and explanation.

This is particularly relevant for assessing – at a general level – the applicability of complexity to international development and humanitarian problems. The fact that the world is not predictable, linear and orderly means that interventions based on simplifying fictions – such as neoclassical economics – often simply don’t work. This is not to say that complexity offers new truths – all science is to some extent the process of creating fictions. In our view, complexity science offers a set of **useful, challenging ‘fictions’ about the world, which can enable us to better delineate and understand complexities of the real world**.

4.3 How does complexity science differ from existing ways of understanding and interpreting international development and humanitarian problems?

The value of these useful, challenging fictions of complexity science is that they provide a new way of looking at aid problems. Specifically, the science of complexity stands in contrast with the two standard methods of scientific enquiry (Axelrod, 1997) – induction and deduction (as mentioned in the section on adaptive agents). In one of the two previous ODI working papers on complexity theory, Michael Warner (2001) argues that complexity theory steers a middle ground between these two approaches. It is important to note that these approaches have provided scientists and thinkers with opposing paradigms since classical times right up to the present day, e.g. the contrast between the hard rock of Aristotle and the swirling mysticism of Plato, echoed in the differences between the approach of neoclassical economics compared with that of cultural anthropology.

Specifically, deduction works from the general to the specific. Starting with a theory, we narrow down to specific hypotheses that can be tested through the collection of observations – namely, data. This leads to testing the hypotheses using specific empirical data, thereby confirming the original theories. The deductive approach results in interventions which are designed using a detailed understanding and deconstruction of the parts of a system and how they fit together. The problem with applying such methods to international aid interventions is that they are at odds with the emerging understanding that the range of interconnections and interdependencies are too numerous to predict a specific outcome from a particular intervention. Complex systems cannot be usefully deconstructed into their casual components. The degree of complexity presented by many human systems means that the more each system is deconstructed, the more unknowns are introduced. In terms of the ability to design

predictable interventions, applying deductive approaches to complex systems soon leads to diminishing returns.

By contrast, ‘inductionist’ approaches move from the specific to the general. They focus on observations of the world and try to detect patterns or regularities, thereby forming some tentative hypotheses and finally some general theories. Such approaches result in the development of generic rules for successful interventions, providing a model that can be scaled up and replicated. The problem here is that methods of induction tend to overlook the behavioural, experiential and experimental nature of complex systems. These characteristics mean that it cannot be correct to assume that ‘good practices’ of intervention which work in one setting are applicable to organisations in other systems – good practices may play out in very different ways in different settings.

The theories of complexity science challenge both of these ways of thinking about real world problems. Using concepts relating to the nature of complex systems, the nature of change, and the behaviour of intelligent actors within these, complexity theory provides a basis for guiding thinking in a way that encompasses both approaches and their limitations. By aiding understanding of the mechanisms through which unpredictable, unknowable and emergent change happens, complexity science enables a reinterpretation of existing systems and the problems faced within them. The value of complexity science – at its most effective – is to generate ideas and insights that help to see complex problems in a more realistic and holistic manner, thereby supporting more useful intuitions and actions.

4.4 What kinds of phenomena can complexity science help us better understand?

Our examples have included industries, the global climate system, national political debates on the Euro zone, vulnerability and disasters, the dynamics of growth, national economic development processes, urban planning, socioeconomic exclusion, organisational change, the relationship between actors and geographical factors, leadership and agricultural cooperation mechanisms.

Where we see systems of interconnected elements and dimensions involving adaptive agents, we are more likely to see complex relationships and processes. There are multiple ways in which the work carried out by development and humanitarian agencies can be seen as taking place within such systems – the communities, cities and countries that agencies work within, the agencies themselves, the overall international aid system, or the broader global system of which it is a part.

Complexity science broadens the kinds of things that **can be looked at with a theoretical basis**. It can prove particularly useful when looking at ‘hybrid systems’ which are a combination of social, physical and economic phenomena, because of its nature as a meta-theory of change. It also provides a common lens in developing solutions to aid problems.

Complexity science is useful in the set of concepts it provides, and the potential of these concepts to be used individually or as part of an integrated approach to describe, understand and model various real world phenomena which might previously have been labelled as ‘messy realities’, ‘common sense’ or ‘lessons from experience’. As has already been stated, complexity science concepts provide a support for **intuition**. In a review of the implications of complexity science for economics, one author suggests that complexity science resonates with what many business people know instinctively (Ormerod, 1998). So too with those working in the humanitarian and development sector.

Whereas before these kinds of problems may have been ignored or regarded as not in the systematic remit, complexity promises to bring a greater rigour and ‘legitimacy’ to areas previously lacking this, and allows us to embrace what were previously seen as ‘messy realities’. If such a lens were to be properly and carefully used, it might allow comparisons between cases and systems that were previously not related, potentially strengthening insight and helping to highlight possible effective actions. By widening the lens on phenomena that can be treated systematically, complexity science

offers some hope that the overall approach taken to development and humanitarian problems can be improved, even if this improvement is only partial and incomplete.

4.5 What is the value of complexity science for those engaged in humanitarian and development work? Specifically, does complexity science tell us anything new?

Despite the work-in-progress nature of complexity science, the applications we have examined give us confidence that the concepts of complexity can be used to highlight new possibilities for understanding development and humanitarian problems. In the authors' own work in developing strategies for organisational learning and building international networks, we have found the concepts of complexity can be used to provide a very useful basis for understanding why a particular change initiative was unsuccessful, as well as to construct a pragmatic basis for conceptualising and planning change initiatives. On the basis of our exploration of complexity, and our experience of working on different kinds of change initiatives, we would argue that the concepts of complexity theory provide a series of important stepping stones towards a more realistic understanding of the limitations of aid. For the aid system and the agencies that occupy it, some of these stepping stones may be too slippery to stand on; others may already be well trodden.

Looking at the bigger picture, we recognise the current potential for complexity science to contribute to a new paradigm for development and humanitarian work, but – as discussed later – the nature of change in the aid sector may make it unlikely that this paradigm will become a fully realised practical reality in the near future.

The concepts of complexity science provide a basis for understanding different aspects of 'messy realities' – aspects which may not otherwise be well understood or systematically investigated. These aspects include the kinds of systems that manifest messy realities, the nature of change, and the behaviour of actors. Some of the concepts tap into familiar ways of thinking, while others develop ideas and insights that are more novel.

The notion of the newness of complexity as a science appears to stand in contrast with the perspective of those who suggest that complexity tells us nothing new. We would take exception to these latter in the following three ways:

- Certain concepts may appear to be 'old hat', but complexity science requires them to be understood in different ways. For example, systems need to be understood in terms of interdependence and interconnectedness, and not merely as a collection of elements. Feedback needs to be understood as unpredictable, nonlinear processes rather than predictable loops which are the result of the combination of a number of cause and effect relationships. Adaptive agents need to be seen as reacting to both internal and external stimuli, including each other and the wider system.
- Certain concepts may help to make generalisations about certain kinds of phenomena, broadening the contexts within which such phenomena can be identified. Adam Smith's invisible hand is perhaps the most famous example of emergence; self-organisation shows that actors at all levels of a given system need to be empowered to find solutions to problems, challenging the existing dichotomies of 'top-down' versus 'bottom-up'.
- Some concepts are unique to complexity science, and may have already been partially, and often inappropriately, applied in social, political and economic thinking. For example, sensitive dependence on initial conditions, which is manifest in the idea of path dependence, has been bolted onto the existing neoclassical idea of market equilibrium.

4.6 What kinds of practical uses are there for complexity science in international aid?

Each of these concepts has relevance for those working in social, economic and political realms. We see much potential value in exploring these concepts in more depth in international aid policy and practice. In our view, it is possible to accommodate qualitative approaches of complexity as a set of metaphors to guide thinking **and** see complexity as a rigorous approach to mathematically based modelling. As has been mentioned throughout the paper, qualitative and quantitative approaches have a lot more in common when seen using the light of complexity; aid analysts need to seek a qualitative understanding of quantitative relationships.

The concepts can be used individually, as has been shown; for example, we might use ‘space of the possible’ to understand how an economy has changed over time and the scope for future changes; we could use adaptive agents to understand how different actors trade off altruism and competition in humanitarian crises, and what incentive structures would lead to optimal cooperation in community-based natural resource management. We might use the notion of initial conditions to try and better understand how the history of a particular region continues to shape it today.

The concepts can be used individually to reflect on the overall system – for example, is the aid system adequately coupled with beneficiaries of the system? how could the interdependencies be increased? – or at specific sub-systems – for example, is organisation X working to facilitate self-organisation at different levels of the system? They can be used to review the success or failure of reform efforts – are change efforts taking sufficient account of ideas such as sensitive dependence on initial conditions and nonlinearity?

The concepts can be used *ex-ante*, to ensure that the principles for programme design or the principles of a change initiative take into account the notion and implications of complexity. The concepts can be used *ex-post* to understand change processes – for example, we have used them to analyse the failure of organisational knowledge strategies and the successful emergence of global communities of practice.

All of the above highlights the fact that the concepts can be used in a highly flexible manner – for example, in combination or individually, to augment existing models or frameworks or as a framework in their own right.

As we highlighted in the introduction, this has been an exploration, and an initial one at that. We know that there is much more work still to do. Future collaborative work in these areas will prove especially useful in identifying the range and scope of these concepts and ideas. More shared thinking around potential practical applications is the ideal way to extend the potential horizons. We are already exploring the scope for a number of these ideas and implications to be applied in settings of relevance to our ongoing work, including evidence-based policy making, organisational learning initiatives, monitoring and evaluation, network building, organisational innovation, aid leadership, humanitarian response coordination, aid effectiveness and others. We are also planning to produce a follow up publication – working title: *Applying the Science of Complexity* - which will build on the current exploration with more details of specific methodologies and approaches, their benefits and challenges, which will be aimed at those interested in apply these ideas and concepts in earnest.

4.7 Concluding remarks

Our View: Champions, pragmatists or critics?

There are a number of problems and pitfalls facing the application of complexity to public sector efforts, specifically within the international aid sector. These are not insurmountable. It is worth revisiting the three contrasting perspectives outlined in Chapter 2, presented in Figure 13 below.

Figure 13: Summary of the three attitudes towards complexity

Perspective	Summary of approach and attitude towards complexity
Champions	<ul style="list-style-type: none"> • Complexity is a new paradigm of science, thought and action for social thinking and action. • Direct application of mathematical approaches found in the natural sciences to social phenomena; calling for time series data which are analysed to identify the existence of the key concepts of complexity; demanding evidence comparable with that found in the natural sciences; facing methodological issues. • Those who suggest that the lack of data and other issues facing quantitative applications of complexity in social sciences should not deprive social analysts of a set of useful insights and metaphors – complexity is a metaphor or a conceptual toolkit for clarifying problems and suggesting solutions.
Pragmatists	<ul style="list-style-type: none"> • Exploring relevance of complexity to assess practical benefits from applications outside natural sciences. • Complexity can aid insights and help to guide thinking and, therefore, action. • Complexity as a ‘lens’, providing important concepts and tools, but not the only way to look at and do things.
Critics	<ul style="list-style-type: none"> • Dismiss the relevance of complexity science beyond the natural sciences. • More work to demonstrate specific applicability required. • Criticise fad-driven ‘complexologists’ selling their services in the realm of organisational management. • Complexity sciences adds nothing to existing approaches to understand social phenomena and only offers recommendations already reached elsewhere.

We have tried to be keenly aware of these different approaches and not to overextend the potential applications of complexity. This requires careful and considered application of the concepts of complexity to international aid. While this may limit the immediate applicability of complexity, it does not detract from its potential power. Importantly, a growing number of applications have tried to take serious account of the (sometimes strident) objections that have been made to the application of complexity to socioeconomic phenomena. While our reference to the original science has made us highly sensitive to the careless application of all of these concepts to social sciences, enough serious thinkers are engaging with these issues to give cause for comfort.

However, if in attempting to use the principles of complexity science in international development and humanitarian efforts it is found that certain aspects of a particular phenomenon can be appropriately characterised using a complexity concept, this does not mean that this aspect is in some way the most important feature, or that increasing awareness of this factor is automatically a valuable or useful thing. The fact that complexity **can offer new** ways of looking at aspects of development problems and a focus on different sorts of features and processes in no way suggests that these features will be the **crucial** aspect of some problem. For example, the concept of a complex system shows that there are new possibilities regarding the way that things behave and change over time. This does not mean that any one particular phenomenon is best explained using the concepts of complexity. Some writers appear disinclined to address the issue of whether it is appropriate to apply a concept to a situation. Where this occurs, the reading at best is that their reference to complexity is as a metaphor, thereby at most suggesting interesting potential relationships between factors and elements being described.

Building on the previous issue, if some phenomena can be properly characterised and described using complexity science, and are seen to be crucial features of a situation, this does not necessarily mean that a particular action should automatically follow. Theoretical understanding of complexity is at an early stage and, from some perspectives, there may not appear to be a great deal of prescriptive power within the key concepts. This issue is frequently come across. For example, some writers use complexity to advocate endlessly increasing actors’ connections with each other, or to suggest that allowing self-organisation will unquestionably lead to better results or that organisational strategy is best left as something that ‘emerges’, i.e., is unplanned.

Our examination of complexity science and its underlying principles suggests that these kinds of recommendations do not naturally follow from the concepts of complexity. Perhaps the greatest challenge in using and applying complexity concepts to development and humanitarian issues systems stems from the fact that they fundamentally state that the best course of action will be highly context-dependent.

In our view, the value of complexity concepts are at a meta-level, in that they suggest new ways to think about problems and new questions that should be posed and answered, rather than specific concrete steps that should be taken as a result. This means that they may be more useful in addressing questions of ‘how’ international aid work should be undertaken. The potential value and relevance of this is outlined in the following quote, taken from a recent large scale evaluation of relief efforts:

“...International agencies need to pay as much attention to *how they do things, and their capacities to do them, as they do to the content of their policies and programmes...* sensitivity to context and the flexibility to adapt to evolving realities are essential, instead of applying pre-determined strategies and one-size-fits-all solutions...” (Telford and Cosgrave, 2006, p 119, emphases added)

This highlights the most important implication of complexity science – that it provides ways for practitioners, policy makers, leaders, managers, researchers, all stop and collectively reflect on *how* we are thinking about trying to solve aid problems. Are we using inappropriate mental models and frameworks? Are we continuing to act in inflexible, top-down ways? Are we using too many off-the-peg approaches? Are we driven by naïve expectations of impact? Do we simplify complexities for the sake of convenience?

These questions – many of which will be familiar – are challenging, highly necessary, and can be sharpened and honed using the ideas of complexity science.

The challenge of applying complexity science to development and humanitarian work

Based on our exploration, we feel safe in saying that development is a complex adaptive process – it is highly local, particular, context-bound, time-specific, path-dependent, etc. Similarly, immediate responses to humanitarian crises are local, complex and adaptive – in the Asian tsunami, 97% of lives that were there to be saved were saved before international agencies arrived.

However, the aid system, with a few exceptions and some emerging ideas, is not a complex adaptive system in relation to poverty and needs. Although things may be improving, the aid system is arguably more adaptive in response to, and ‘tightly coupled’ with the political and financial apparatus of Western states and publics. Chambers (1997) argues that the aid sector is ‘a mutually supporting pattern of concepts, values, methods and behaviours which is widely applicable’. Given the limited scope for radical new ideas in this context, the most serious obstacle for application of complexity science for international aid may well be the inability or unwillingness of actors within the system to engage with complexity.

Complexity, for many, is seen as an indulgence. This has led to organisations that are increasingly rigid, risk-averse and bureaucratic; it has meant led to the prevalence of tools and techniques that are linear and simplistic in their scope and outlook (Bakewell and Garbutt, 2005), it has meant change at the level of ideas is much more likely than at the level of ground-level practices (Killick, 2005); it means that one can always predict who will do what, when and how (Seaman, cited in Kent, 2004); and it means that the adaptive learning of particular actors are short-circuited, or worse, suppressed. It means that, when mistakes are made in this complex system of governments, NGOs, UN agencies and donors, everyone points the finger at everyone else (Smillie and Minnear, 2004).

Aside from the political will, there are other more practical issues to consider. Organisations may not have the resources to bear the analytical burden of examining the systems they operate in; most reporting frameworks are geared to a linear mindset; they may not have the scope to incorporate a realistic understanding of the uncertainties of their efforts when planning and implementing projects and programmes; they may not have it in their hands to ensure that those acting to solve a problem address it in a coherent manner; the pressures of accountability to donors or the public may not allow for such uncertainties to be honestly and openly addressed. The following is a summary from a 2004 report on future dynamics of crisis in humanitarian agencies addressing the take-up of complex conceptual frameworks:

‘Coherent analytical frameworks, while a step in the direction of more effective programs, are no panacea ... The challenges for agencies in adopting wider conceptual frameworks are many. Slow uptake may be associated with the burden of more complex analysis and the problems of perceived reliance on outside expertise. A framework requires an elaborate combination of qualitative and quantitative indicators and therefore agencies need to create, teach, develop, sustain, and monitor complex analysis at the national and program levels. Since not all agencies have access to expertise, affiliations with academic or training institutions may be useful. The reluctance to adopt complex frameworks may also reflect an awareness of the difficulties in using these tools for better programming ... Agencies need to use these frameworks to advocate and justify more innovative programming. Similarly, donors need to be more flexible and open to tailored responses’ (Feinstein International Famine Center, 2004).

The financial and political costs of bringing such a framework to bear on development and humanitarian problems are far from trivial. As well as use by implementing agencies, an understanding of complexity must also be built into the frameworks of the donors and others who hold the power to determine the shape of development interventions. This may be easier said than done – complexity requires a shift in attitudes that would not necessarily be welcome to many working in Northern agencies. For example, such a shift may require adjusting away from the ‘mechanistic’ approach to policy, or being prepared to admit that most organisations are learning about development interventions as they go along, or being transparent about the fact that taxpayers’ money may be spent on a project that does not guarantee results. It may mean having smaller, but better programmes.

At the same time, though, we see complexity science as having great potential to be misappropriated and misapplied in the aid world, especially given the speed and frequency with which new ideas and approaches are picked up, used, dropped, reused and reformulated.

An even more challenging problem arises from placing international development and humanitarian work in the context of the wider system of international relations within which development and humanitarian work is embedded and by which it is fundamentally shaped. While the emerging ‘beyond aid’ agenda (Hudson, 2007) shows some hope of this understanding playing a part in the work of at least one major international agency, it is highly unlikely that it will lead to fundamental and comprehensive shifts in foreign policy. Instead, what is likely in the short to medium term is that complexity can support a better awareness as to **exactly why development and humanitarian work is so problematic**, challenging and hard. If complexity science currently provides greater clarity on why so much in the aid world is wrong, it also points to the kinds of questions that should be asked for things to be put right.

At the start of our exploration, our view was simply that complexity would be a very interesting place to visit. At the end, we are of the opinion that many of us in the aid world live with complexity daily. There is a real need to start to recognise this explicitly, and try and understand and deal with this better. The science of complexity provides some valuable ideas. While it may be impossible to apply the complexity concepts comprehensively throughout the aid system, it is certainly possible and potentially very valuable to start to explore and apply them in relevant situations.

To do this, agencies first need to work to develop collective intellectual **openness** to ask a new, potentially valuable, but challenging set of questions of their mission and their work. Second, they

need to work to develop collective intellectual and methodological **restraint** to accept the limitations of a new and potentially valuable set of ideas, and not misuse or abuse them or let them become part of the ever-swinging pendulum of aid approaches. Third, they need to be **humble and honest** about the scope of what can be achieved through 'outsider' interventions, about the kinds of mistakes that are so often made, and about the reasons why such mistakes are repeated. Fourth, and perhaps most importantly, they need to develop the individual, institutional and political **courage** to face up to the implications.

References

- Ackoff, R. (1974) *Redesigning the Future: A Systems Approach to Societal Problems*, New York: John Wiley and Sons.
- Aoi, C., de Coning, C. and Thakur, R. (eds) (2007) *Unintended Consequences of Peacekeeping Operations*, Tokyo: UN University Press.
- Arthur, W.B. (1999) 'Complexity and the Economy', *Science* 284 (April): 107–9.
- Arthur, W.B. (1990) 'Positive Feedbacks in the Economy', *Scientific American* 262 (February): 92–9.
- Axelrod, R. (1997) 'Advancing the Art of Simulation in the Social Sciences', *Complexity*, 3(2): 16–22.
- Back, I. and Flache, A. (2006) 'The Viability of Cooperation Based on Interpersonal Commitment', *Journal of Artificial Societies and Social Simulation* 9(1).
- Bak, P. and Tang, C. (1989) 'Earthquakes as a Self-organized Critical Phenomenon', *Journal of Geophysical Research* 94(15): 635–7.
- Bakewell, O. and Garbutt, A. (2005) *The Use And Abuse Of The Logical Framework Approach*, Stockholm: Sida.
- Benn, H. (2006) 'Development Beyond Aid', 5th White Paper Speech at Chatham House/BOND, 23 February.
- Berreby, D. (1998) 'Complexity Theory: Fact Free Science or Business Tool', *Strategy & Business*, 10: 40–50.
- Bhavnani, R. (2006) 'Agent-based Models in the Study of Ethnic Norms and Violence' in Harrison, N.E. and Rosenau, J.N. *Complexity in World Politics: Concepts and Methods of a New Paradigm*, SUNY Series in Global Politics, New York: State University of New York Press.
- Bithell, M., Brasington, J. and Richards, K. (2006) 'Discrete-element, individual-based and agent-based models: Tools for interdisciplinary enquiry in geography?', *Geoforum* (2006), doi:10.1016/j.geoforum.2006.10.014
- Black, J.A. (2000) 'Fermenting Change: Capitalizing on the Inherent Change Found in Dynamic Non-linear (or Complex) Systems', *Journal of Organizational Change Management* 13(6), 520–5.
- Booth, D., Cammack, D., Harrigan, J., Kanyongolo, E., Mataure, M. and Ngwira, N. (2006) *Drivers of Change and Development in Malawi*, Working Paper 261, London: ODI.
- Bowles, S. and Choi, J.K. (2003) 'The First Property Rights Revolution', Mimeo, Santa Fe Institute.
- Bowles, S., Choi, J.K. and Hopfensitz, A. (2003) 'The Co-evolution of Individual Behaviors and Social Institutions', *Journal of Theoretical Biology* 223(2): 135–147.
- Breslin, P. (2004) 'Thinking Outside Newton's Box: Metaphors for Grassroots Development', *Grassroots Development* 25(1): 1–9.
- Briassoulis, H. (2004) 'Policy Integration for Complex Policy Problems: What, Why and How', Paper presented at Greening of Policies: Interlinkages and Policy Integration, Berlin, 3–4 December.
- Buchanan, M. (2004) 'Power Laws & the New Science of Complexity Management', *Strategy + Business Enews* 34: 1-8, <http://www.strategy-business.com/press/16635507/04107>.
- Buckle, P. (2005) 'Disaster: Mandated Definitions, Local Knowledge and Complexity' in Perry R. and Quarantelli E. (eds) *What is Disaster?* Routledge, London.
- Burnes, B. (2004) *Managing Change: A Strategic Approach to Organisational Dynamics*, Essex: Pearson Education Limited.
- Byrne, D. (2001) 'Complexity Science and Transformations in Social Policy', <http://www.whb.co.uk/socialissues/db.htm>.
- Byrne, D. (2006) 'What is an effect?', Presentation for the Causality Revisited Session at the 2006 International Sociological Association Conference. Durban, South Africa.
- Byrne, D. (1998) *Complexity Theory and the Social Sciences: An Introduction*, London: Routledge.
- Byrne, D. and Rogers, T. (1996) 'Divided Spaces – Divided School: An Exploration of the Spatial Relations of Social Division', *Sociological Research Online* 1(2), <http://ideas.repec.org/a/sro/srosro/1996-17-1.html>.
- Cambel, A.B. (1993) *Applied Chaos Theory: A Paradigm for Complexity*, Boston: Academic Press, Harcourt Brace.

- Campbell, D., Farmer, D., Crutchfield, J. and Jen, E. (1985) 'Experimental Mathematics: The Role of Computation in Nonlinear Science', *Communications of the Association for Computing Machinery* 28(4):374–84.
- Capra, F. (1996) *The Web of Life*, London: Flamingo/Harper Collins.
- Carden, F. (2006) 'Outcome Mapping: A Tool for Measuring the Results of Development Interventions', Talk to Harvard Center for International Development Frontiers in Sustainable Development Speaker Series, 13 December.
- Chay, H. and Chay, D. (1995) 'Complexity Theory', <http://www.learning-communities.com/hms/complexitytheory/complexitytheory.htm>.
- Casti J. L. (1998), Developing and Applying Complex Adaptive Models, Strategy & Complexity Seminar, London School of Economics, 15 May, <http://www.lse.ac.uk/lse/complex>
- Chambers, R. (1997) *Whose Reality Counts: Putting the First Last*, London: Intermediate Technology Publications.
- Chambers, R. and Conway, G.R. (1992) *Sustainable Rural Livelihoods: Practical Concepts for the 21st century*, Brighton, Sussex: IDS.
- Chapman, J. (2004) *System Failure: Why Governments Must Learn to Think Differently*, London: Demos.
- Chesters, G. (2004) 'Global Complexity and Global Civil Society', *Voluntas: International Journal of Voluntary and Nonprofit Organizations* 15.
- Cilliers, P. (1998). *Complexity and postmodernism: Understanding complex systems*. New York: Routledge.
- Cohen, S. (2003) 'Beyond Slogans: Lessons From Uganda's Experience With ABC and HIV/AIDS', *The Guttmacher Report on Public Policy* 6(5).
- Cohen, J. and Stewart, I. (1995) *The Collapse of Chaos*, London: Penguin Books.
- Cohen, M. and Wright, K. (2003) *Managing Client Information: Feedback Loop Lessons from Latin America*, Improving the Impact of Microfinance on Poverty, Action Research Programme, Occasional Paper 2, Brighton, Sussex: IDS.
- CRED (2001) Center for Research on the Epidemiology of Disasters, 2001, website: <http://www.cred.org>.
- Cutler, R.M. (2002) 'Complexity Science and Knowledge-Creation in International Relations Theory' in *Encyclopaedia of Institutional and Infrastructural Resources in Encyclopaedia of Life Support Systems*, Oxford: Eolss Publishers for UNESCO.
- Darcy, J. and Hoffman, C. (2003), According to need? Needs assessment and decision-making in the humanitarian sector, HPG Report 15, London: Overseas Development Institute.
- David, P. (2000) 'Path Dependence, Its Critics and the Quest for "Historical Economics"' in Garrouste P. and Ioannides S. (eds) *Evolution and Path Dependence in Economic Ideas: Past and Present*, Cheltenham: Edward Elgar Publishing.
- Davies, R. (2003) Network Perspectives on the Evaluation of Development Interventions. Paper for the EDAIS Conference November 24–25, New Directions in Impact Assessment for Development: Methods and Practice.
- Dawkins, R. (1986) *The Blind Watchmaker: Why the Evidence of Evolution Reveals a Universe Without Design*, London: Longman.
- Dendrinis, D. (1997) 'Chaos: Challenges from and to socio-spatial form and policy,' in *Discret Dynamics in Nature and Society*, vol. 1, no. 1, pp. 9–15.
- Doran, J. E. (1998) 'Simulating Collective Misbelief', *Journal of Artificial Societies and Social Simulation* 1(1), <http://www.soc.surrey.ac.uk/JASSS/1/1/3.html>.
- Doran, J.E. and Palmer, M. (1995) 'The EOS Project: Integrating Two Models of Palaeolithic Social Change' in Gilbert N. and Conte R. (eds) *Artificial Societies*, London: UCL Press.
- Dubois, A and Gadde, L. (2001) 'The Construction Industry as a Loosely Coupled System – Implications for Productivity and Innovativity', Paper for the 17th IMP Conference, Oslo, Norway, 9–11 September.
- Earl, S., Carden, F. and Smutylo, T. (2001) *Outcome Mapping: Building Learning and Reflection into Development Programs*, Ottawa: IDRC.
- Epstein, M. and Axtell, R. (1996) *Growing Artificial Societies: Social Science from the Bottom Up*, Cambridge, MA: the MIT Press.

- Epstein, J., Steinbruner, J. and Parker, M. (2001) *Modelling Civil Violence: An Agent-Based Computational Approach*, Working Paper, Washington, DC: Center on Social and Economic Dynamics, Brookings Institution.
- Eubank, S., Guclu, H., Kumar, V.S.A., Marathe, M.V., Srinivasan, A., Toroczkai, Z. and Wang, N. (2004) 'Modeling Disease Outbreaks in Realistic Urban Social Networks', *Letters to Nature* 429.
- Eyben, R. (ed.) (2006) *Relationships for Aid*, London: Earthscan.
- Feigenbaum, M. (1978) 'Quantitative Universality for a Class of Nonlinear Transformations', *Journal of Statistical Physics* 19(1), 25–52.
- Feinstein International Famine Center (2004) *Ambiguity and Change: Humanitarian NGOs Prepare for the Future*, Medford, MA: Feinstein International Famine Center, Friedman School of Nutrition Science and Policy, Tufts University.
- Folke, C., Berkes, F. and Colding, J. (1998) 'Ecological Practices and Social Mechanisms for Building Resilience and Sustainability' in Berkes F. and Folke C. (eds) *Linking Social and Ecological Systems: Management Practices and Social Mechanisms for Building Resilience*, Cambridge: Cambridge University Press.
- Flynn Research (2003) *Complexity Science: A Conceptual Framework for Making Connections*, Denver: Flynn Research.
- Funtowicz, S.O. and Ravetz, J. (1994) 'Emergent Complex Systems', *Futures* 26(6): 568–82.
- Gaddis, J. (2002) *The Landscape of History: How Historians Map the Past*, Oxford: OUP.
- Gasper, D. (2000) 'Evaluating the "Logical Framework Approach" towards Learning-oriented Development Evaluation', *Public Administration and Development* 20(1): 17–28.
- Gell-Mann, M. (1996) 'Let's Call It Plectics', *Complexity*, 1(5): 3.
- Geyer, F. (1994) 'The Challenge of Sociocybernetics', Paper prepared for Symposium VI: Challenges to Sociological Knowledge, 13th World Congress of Sociology, Bielefeld, 18–24 July.
- Geyer, R. (2006) 'Is There Anything to Fear from the Politics of Complexity', University of Lancaster, www.psych.lse.ac.uk/complexity/Seminars/2006/LSE_RGeyer.pdf.
- Gibson, C.C., Anderson, K., Ostrom, E. and Shivakumar, S. (2005) *The Samaritan's Dilemma: the Political Economy of Development Aid*, Oxford: Oxford University Press.
- Gilchrist, A (2000) 'The well-connected community: networking to the edge of chaos,' *Community Development Journal* 35:264–275.
- Gillinson, S. (2004) *Why Cooperate? A Multi-Disciplinary Study of Collective Action*, Working Paper 234, London: ODI.
- Gladwell, M. (2000) *The Tipping Point: How Little Things Can Make a Big Difference*, Boston: Little, Brown.
- Gleick, J. (1987) *Chaos: Making a New Science*, New York: Viking.
- Gribbin, J (2004) *Deep Simplicity: Chaos, Complexity and the Emergence of Life* London: Allen Lane
- Groves, L.C. and Hinton R.B. (2004) *Inclusive Aid: Changing Power and Relationships in International Development*, London: Earthscan.
- Gunderson, L.H. (2003) 'Adaptive Dancing: Interactions Between Social Resilience and Ecological Crises' in Berkes F. (ed.) *Navigating Social-ecological Systems: Building Resilience for Complexity and Change*, Cambridge UK and New York: Cambridge University Press.
- HAP (2007) 'Accountability is the Means by Which Power is Used Responsibly', <http://www.hapinternational.org/en/page.php?IDpage=64&IDcat=10>.
- Hare, M. and Deadman, P. (2004) 'Further towards a Taxonomy of Agent-based Simulation Models in Environmental Management', *Mathematics and Computers in Simulation* 64(1): 25–40.
- Harvey, D. (2001) 'Chaos and Complexity: Their Bearing on Social Policy Research', *Social Issues*, 1(2), <http://www.whb.co.uk/socialissues/index.htm>.
- Harvey, P. and Lind, J. (2005) *Dependency and Humanitarian Relief: A Critical Analysis*, HPG Research Briefing 19, London: ODI.
- Haynes, P. (2003) *Managing Complexity in the Public Services*, Berkshire: Open University Press.
- Helbing, D., Farkas, I. and Vicsek, T. (2000) 'Simulating Dynamical Features of Escape Panic', *Nature* 407:487–90.
- Hemelrijk, C. (ed.) (2005) *Self-organisation and Evolution of Biological and Social Systems*, Cambridge: Cambridge University Press.

- Heylighen, F. (2001) 'The Science of Self-organization and Adaptivity', Center Leo Apostel, Free University of Brussels, Belgium, <http://pespmc1.vub.ac.be/Papers/EOLSS-Self-Organiz.pdf>.
- Hilhorst, D. (2003) 'Unlocking Disaster Paradigms: An Actor-oriented Focus on Disaster Response', Abstract submitted for Session 3 of the Disaster Research and Social Crisis Network Panels of the 6th European Sociological Conference, Murcia, Spain, 23–26 September.
- HM Treasury (2006) *The Stern Review of the Economics of Climate Change*, London: HM Treasury.
- Holland, J. (2000) *Emergence: From Chaos to Order*, Oxford: OUP.
- Holland, J. (1995) *Hidden Order: How Adaptation Builds Complexity*, New York: Helix Books.
- Hollings, C.S. (2001) 'Understanding the Complexity of Economic, Ecological and Social Systems', *Ecosystems* 4, no 5: 390–405.
- Homer-Dixon, T (1995) Strategies for Studying Causation in Complex Ecological Political Systems, Occasional Paper Project on Environment, Population and Security Washington, D.C.: American Association for the Advancement of Science and the University of Toronto, on <http://www.library.utoronto.ca/pes/eps/method/methods1.htm>
- Homer-Dixon, T (2005) *The Upside of Down: Catastrophe, Creativity and the Renewal of Civilisation*, Bodmin: Souvenir Press.
- Mendenhall, M., Macomber, J., Gregersen, H., and Cutright, M. (1998) 'Nonlinear Dynamics: A New Perspective On Irm Research And Practice In The 21st Century' in *Human Resource Management Review*, Volume 8, Number 1, 1998, pages 5–22.
- Huang, F. (2005) *The Co-evolution of Economic and Political Development*, Singapore: School of Economics and Social Sciences, Singapore Management University.
- Hudson, A. (2007) *Beyond-aid Policies and Impacts: Why a Developing Country Perspective is Important*, ODI Opinion 79, London: ODI.
- Hurwicz, L. (1995) Social absorption capability and economic development. In Hoo, B.H. (ed.), *Social capability and long-term economic growth*. Macmillan, London, UK.
- Waltner-Toews, D. (1999) An Ecosystem Approach to Health: Communicable and Emerging Diseases, Document presented in the seminar An Ecosystem Approach to Human Health: Communicable and Emerging Diseases. Rio de Janeiro-Brazil, 7–12 November 1999.
- Innes, J. and Booher, D. (2000) 'Indicators for Sustainable Communities: A Strategy Building on Complexity Theory and Distributed Intelligence', *Planning Theory & Practice* 1(2): 173–86.
- ISCID (2005) 'Encyclopaedia of Science and Philosophy', <http://www.iscid.org/about.php>.
- Ison, R., Maiteny, P.T. and Carr, S. (1997) 'Systems Methodologies for Sustainable Natural Resources Research and Development', *Agricultural Systems* 55(2): 257–72.
- Jervis, R. (1997) *System Effects: Complexity in Political and Social Life*, Princeton, NJ: Princeton University Press.
- Jessop, R. (2003) 'The Governance of Complexity and the Complexity of Governance: Preliminary Remarks on Some Problems and Limits of Economic Governance', Lancaster Department of Sociology, <http://www.lancs.ac.uk/fss/sociology/papers/jessop-governance-of-complexity.pdf>.
- Johnson, C.W. (2003) *A Handbook of Accident and Incident Reporting*, Glasgow: Glasgow University Press.
- Johnson, J. (1995) 'Links, Arrows and Networks: Fundamental Metaphors in Human Thought' in Batten, D., Casti, J. and Thord, R. *Networks in Action*, Berlin: Springer Verlag.
- Kauffman, S. (1995) *At Home in the Universe: The Search for the Laws of Self-organisation and Complexity*, London: Penguin Books.
- Kent, R. (2004) 'Humanitarian Futures: Practical Policy Perspectives', Network Paper 46 (April). London: ODI/Humanitarian Practice Network.
- Killick, T. (2005) 'Policy Autonomy and the History of British Aid to Africa', *Development Policy Review* 23(6): 665–81.
- Ki-Moon, B. (2007) 'Darfur's Complex Dynamic: an Opinion' in 'Darfur Conflict Heralds Era of Wars Triggered by Climate Change, UN Report Warns' in *The Guardian*, 23 June.
- Krugman, P (1996) 'What Economists Can Learn From Evolutionary Theorists' *A talk given to the European Association for Evolutionary Political Economy* available at <http://web.mit.edu/krugman/www/evolute.html>
- Kurtz, C.F. and Snowden, D. (2003) 'The New Dynamics of Strategy: Sense-making in a Complex and Complicated World', *IBM Systems Journal* 42(3).

- Ladd, H. (1992) 'Population Growth, Density and the Costs of Providing Public Services', *Urban Studies* 29 (2): 273–95.
- Lansing, J.S. and Miller, J.H. (2003) *Cooperation in Balinese Rice Farming*, Working Paper, Santa Fe, NM: Santa Fe Institute.
- Laszlo, E. (1991) *The age of bifurcation: Understanding our changing world*, New York: Gordon & Breach.
- Lipsky, M. (1983) *Street-level Bureaucracy*, New York: Russell Sage Foundation Publications
- Long, N. (2002) 'An Actor-oriented Approach to Development Intervention', Background Paper prepared for APO Meeting. Tokyo, 22–26 April.
- Lorenz, E. (1972) 'Predictability: Does the Flap of a Butterfly's Wings in Brazil Set off a Tornado in Texas?', Paper presented to American Association for the Advancement of Science, Washington, DC.
- Lyotard, J.F. (1994) *The Postmodern Condition : A Report on Knowledge*, Minnesota Press.
- McDonald, D. and Weir, G.R.S. (2006) 'Developing a Conceptual Model for Exploring Emergence', Computer and Information Sciences, University of Strathclyde.
- Markose, S. (2004) 'Introduction to Markets as Complex Adaptive Systems (CAS) and Agent-based Modelling', http://www.essex.ac.uk/CCFEA/Teaching/CF902/Year2005_06/SpringTerm/Introduction.doc.
- Margolis, S. and Liebowitz, S.J. (1998) 'Path Dependence' in *New Palgrave Dictionary of Economics and Law*, London: Palgrave MacMillan.
- Marion, R. (1999) *The Edge of Organization: Chaos and Complexity Theories of Formal Social Systems*, Sage: Thousand Oaks.
- Marion, R. and Uhl-Bien, M. (2001) 'Leadership in Complex Organizations', *Leadership Quarterly* 12(4): 389–418.
- Martens, B. (2005) 'Why do Aid Agencies Exist?' In *Development Policy Review*, 23 (6): 643–663.
- Maruyama, M. (1968) 'The Second Cybernetics: Deviation Amplifying Mutual Causal Processes' in Buckley, W. *Modern Systems Research for the Behavioural Scientist*, Chicago: Aldine.
- Matutinovic, I. (2005) 'The Microeconomic Foundations of Business Cycles: From Institutions to Autocatalytic Networks', *Journal of Economic Issues* 39(4): 867–98.
- Maxwell, S. (2005) *Spyglass, Spigot, Spoon or Spanner. What Future for Bilateral Aid?* London: ODI.
- Meadows, D. (1999) 'Leverage Points: Places to Intervene in a System', *Whole Earth*, Winter 97.
- Mello, L. (2006) 'Natural Economics: Some Different Ideas', <http://arxiv.org/ftp/cs/papers/0602/0602066.pdf>.
- Mill, J.S. (1884) *A System of Logic*, London: Longman.
- Mingers, J. (1995) *Self-producing Systems: Implications and Applications of Autopoiesis*, London: Plenum Press.
- Mendenhall, M., Macomber, J., Gregersen, H. and Cutright, M. (1998) 'Nonlinear Dynamics: A New Perspective on IHRM Research and Practice in the 21st Century', *Human Resource Management Review* 8(1): 5–22.
- Mittleton-Kelly, E. (2003) 'Ten Principles of Complexity and Enabling Infrastructures' in *Complex Systems and Evolutionary Perspectives of Organisations: The Application of Complexity Theory to organizations*, London: Elsevier Press.
- Mkandawire, T. and Soludo, C. (1999) *Our Continent, Our Future, African Perspectives on Structural Adjustment*, IDRC/CODESRIA/Africa World Press, http://www.idrc.ca/en/ev-88031-201-1DO_TOPIC.html.
- Moobela, C. (2005) 'From Worst Slum to Best Example of Regeneration: Complexity in the Regeneration of Hulme, Manchester', *E:CO* 7(1): 29–42.
- Morgan, G. (1986) *Images of Organization*, 3rd edition updated in 2006 London: Sage.
- Musters, C.J.M. de Graaf, H.J. and ter Keurs, W.J. (1998) 'Defining Socio-environmental Systems for Sustainable Development', *Ecological Economics* 26: 243–58.
- Newell, D. (2003) 'Concepts in the study of complexity and their possible relation to chiropractic healthcare' in *Clinical Chiropractic* (2003) 6, 15-33.
- Nicolis, G. and Prigogine, I. (1989) *Exploring Complexity*, New York: W.H. Freeman.
- Nicolis, G. and Prigogine, I. (1977) *Self-organization in non-equilibrium systems: from dissipative structures to order through fluctuations*, New York: Wiley

- Nilson, T. H. (1995) *Chaos marketing: How to win in a turbulent world*, London: McGraw-Hill.
- O'Connell, L (2005) 'Program Accountability as an Emergent Property: The Role of Stakeholders in a Program's Field' *Public Administration Review*, January/February 2005, Vol. 65, No. 1.
- Ormerod, P. (1998) *Butterfly Economics: A New General Theory of Social and Economic Behaviour*, London: Faber and Faber.
- OECD DAC (1999) 'Evaluation and Aid Effectiveness', <http://www.oecd.org/dataoecd/9/50/2667294.pdf>.
- Peak, D. and Frame, M. (1998) *Chaos under Control: The Art and Science of Complexity*, New York: WH Freeman and Company.
- Pepper, J.W. and Smuts, B.B. (2000) 'The Evolution of Cooperation in an Ecological Context: An Agent-based Model' in Kohler T.A. and Gumerman G.J. (eds) *Dynamics of Human and Primate Societies: Agent-based Modeling of Social and Spatial Processes*, Oxford: Oxford University Press.
- Pidd, M. (1996) *Tools for Thinking: Modelling in Management Science*, Chichester: John Wiley and Sons.
- Piepers, I. (2006) 'The International System: at the Edge of Chaos', <http://arxiv.org/ftp/nlin/papers/o611/o611062.pdf>.
- Pina e Cunha, M. and Vieira da Cunha, J. (2006) 'Towards a Complexity Theory of Strategy', *Management Decision* 44(7).
- Pirrotte, C., Husson, B. and Grunewald, F. (1999) *Responding to Emergencies and Fostering Development: The Dilemmas of Humanitarian Aid*, London and New York: Zed Books.
- Plowman, DA, Solansky, S.T, Beck, TE, Baker, L, Kulkarni, M, Travis, DV (2007a) 'The role of leadership in emergent, self-organization' in *The Leadership Quarterly* 18 (2007) 341–35.
- Plowman, D. A., Baker, L. T., Beck, T. E., Kulkarni, M., Solansky, S. T., & Travis, D. V. (2007b). Radical change accidentally: The emergence and amplification of small change. *Academy of Management Journal*, 50(3), 513•541.
- Porter, D., Allen, B. and Thompson, G. (1991) *Development in Practice: Paved with Good Intentions*, London: Routledge.
- Prigogine, I. (1997) *The end of certainty*, New York: Free Press.
- Prigogine I. and Stengers, I. (1984) *Order Out of Chaos: Man's New Dialogue with Nature*, London: Heinemann.
- Ramalingam, B. (2006) *Tools for Knowledge and Learning: A Guide for Development and Humanitarian Organizations*, London: ODI.
- Ramalingam, B. (2005) *Implementing Knowledge Strategies: Lessons from International Development Agencies*, Working Paper 244, London: ODI.
- International Federation of Red Cross and Red Crescent Societies (1999) *World Disaster Report*, Geneva: International Federation of Red Cross and Red Crescent Societies.
- Richardson, K. A., Mathieson, G. and Cilliers, P. (2000) 'The Theory and Practice of Complexity Science: Epistemological Considerations for Military Operational Analysis', <http://citeseer.ist.psu.edu/389536.html>.
- Rihani, S. (2005) 'Complexity Theory: A New Framework for Development is in the Offing', *Progress in Development Studies* 5(1).
- Rihani, S. (2002) *Complex Systems Theory and Development Practice: Understanding Non-linear Realities*, London: Zed Books.
- Rodríguez, F (2007) *Policymakers Beware: The Use and Misuse of Regressions in Explaining Economic Growth*, Policy Research Brief No. 5, International Poverty Centre, Brasilia: IPC
- Röling, N. and Wagemakers, M.A.E. (1998) *Facilitating Sustainable Agriculture*, Cambridge: Cambridge University Press.
- Romenska, S. (2006) 'Innovation in Higher Education Systems in the Post-socialist Countries in Central and Eastern Europe, 1999-2005: Possibilities for Exploration through a Complexity Theory Framework', *Research in Comparative & International Education* 1(2).
- Roper, R. and Pettit, J. (eds) (2002) *Development and the Learning Organisation*, Oxford: Oxfam.
- Rosen, R. (1991) *Life Itself: A Comprehensive Inquiry into the Nature, Origin and Fabrication of Life*. Columbia University Press, New York.
- Rosenhead, J. (2001) *Complexity Theory and Management Practice*, Working Paper Series, LSEOR 98.25, London: LSE.

- Ruelle, D. and Takens, F. (1971) 'On the Nature of Turbulence', *Communications in Mathematical Physics* 20: 167–92.
- Russell, S. and Norvig, P. (2003) *Artificial Intelligence: A Modern Approach*, London: Prentice Hall.
- Sahel Working Group (2007) 'Beyond Any Drought: Root Causes of Chronic Vulnerability in the Sahel', Paper for IIED, <http://www.careinternational.org.uk/download.php?id=622>.
- Sanders, I. (1998) *Strategic Thinking and the New Science: Planning in the Midst of Chaos, Complexity, and Change*, Columbus OH: The Free Press.
- Sanders, I. and McCabe, J.A. (2003) *The Use of Complexity Science: A Survey of Federal Departments and Agencies, Private Foundations, Universities and Independent Education and Research Centres*, Washington, DC: Washington Centre for Complexity and Public Policy.
- Sarewitz, D. and Pielke, R. (2001) 'Extreme Events: A Research and Policy Framework for Disasters in Context', <http://www.albany.edu/cpr/xedm/Materials/Sarewitz-Pielke2001.pdf>.
- Schelling, T. (1978) *Micromotives and Macrobehavior*. New York: Norton.
- Schueler, G.J. and Schueler, B.J. (2001) 'Feedback Loops', Part 10 of 'The Chaos of Jung's Psyche', http://www.schuelers.com/ChaosPsyche/part_1_10.htm.
- Sellamna, N. (1999) *Relativism in Agricultural Research and Development: Is Participation a Post-modern Concept?* Working Paper 119, London: ODI.
- Sellier, M. (1997) 'Sciences Inexactes et Sciences Inhumaines', Contribution to *Libération*.
- Sen, A. (1999) *Development as Freedom*, New York: Knopf.
- Senge, P. (1990) 'The Leader's New Work: Building Learning Organizations', *Sloan Management Review* 32(1): 7–23.
- Slaughter, R. (2003) 'Futures Concepts', Briefing Paper for Christian Futures Consultation.
- Slim, H (2007) Global Welfare: A Realistic Expectation for the international humanitarian system? *ALNAP Review of Humanitarian Action No 7*, London: ODI.
- Smillie, I and Minear, L (2004) *The Charity of Nations: Humanitarian Action in a Calculating World*, Bloomfield, CT: Kumarian Press.
- Sokal, A. and Bricmont, J. (1998) *Intellectual Impostures*, London: Profile Books.
- Sorenson, O. (1999) 'Book Review' of Eve, R., Horsfall, S. and Lee, M. 'Emergence', *Chaos Complexity and Sociology* 1: 149-51.
- Stacey, R. (1996) *Complexity and Creativity in Organisations*, San Francisco: Berrett-Koehler Publishers.
- Stanford Encyclopaedia of Philosophy (2006) 'Emergent Properties', <http://plato.stanford.edu/entries/properties-emergent/>.
- Stacey, R. (1995) The science of complexity: An alternative perspective for strategic change processes. *Strategic Management Journal*, 16, 477–495.
- Stacey, R. (1993) 'Strategy as Order Emerging from Chaos', *Long Range Planning* 26(1): 10–17.
- Strogatz, S. (2003) *Sync: The Emerging Science of Spontaneous Order*, London: Penguin Books
- Sundkvist, A., Milestad, R. and Jansson, A. (2005) 'On the Importance of Tightening Feedback Loops for Sustainable Development of Food Systems', *Food Policy* 30, 224–39.
- Telford, J and Cosgrove, J (2006) *Joint Evaluation of the International Response to the Indian Ocean Tsunami: Synthesis Report*, Tsunami Evaluation Coalition
- Tesfatsion, L. (2002) 'Agent-based computational economics: Growing economies from the bottom up,' *Artificial Life* 8:55–82.
- Tesfatsion, L. and Judd, K. (eds) (2006) 'Agent-based Computational Economics: A Constructive Approach to Economic Theory' in *Handbook of Computational Economics, Volume 2: Agent-Based Computational Economics* (to appear).
- Tetenbaum, T. (1998) 'Shifting Paradigms: From Newton to Chaos', *Organizational Dynamics*, Spring.
- Urry, J. (2003) *Global Complexity*, Cambridge: Blackwell Publishing Ltd.
- Waldrop, M. (1994) *Complexity: the Emerging Science at the Edge of Order and Chaos*, London: Penguin Books.
- Waltner-Toews, D. (1999) 'An Ecosystem Approach to Health and Infectious Disease', Document presented in the seminar: An Ecosystem Approach to Human Health: Communicable and Emerging Diseases, Rio de Janeiro, Brazil, 7-12 November.
- Warner, M. (2001) *Complex Problems ... Negotiated Solutions: The Practical Applications of Chaos and Complexity Theory to Community-based Natural Resource Management*, London: ODI.

- Weick, K. (1976) 'Educational Organizations as Loosely Coupled Systems', *Administrative Science Quarterly* 21: 1–9.
- Westley, F., Zimmerman, B. and Quinn Patton, M. (2006) *Getting to Maybe: How the World is Changed*, Toronto: Random House.

