

speechless 7

Dirk Kreckler

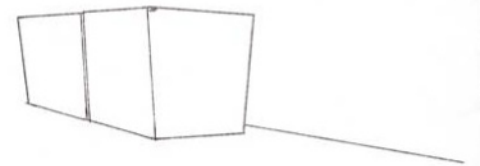

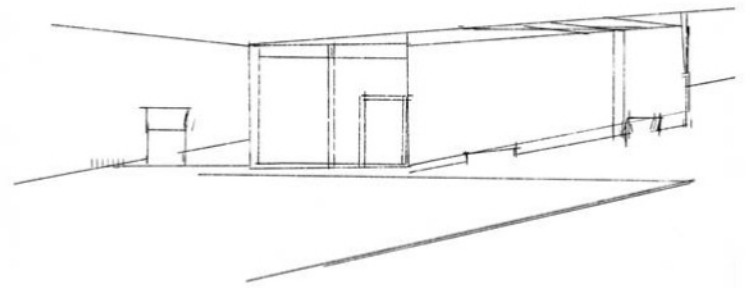

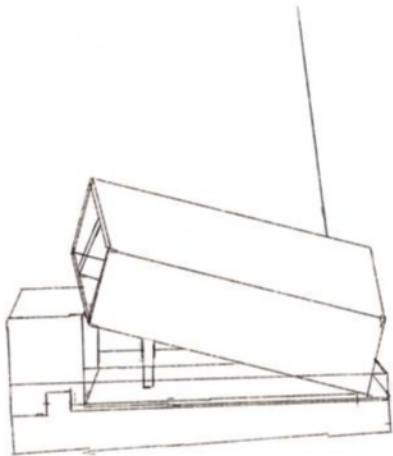
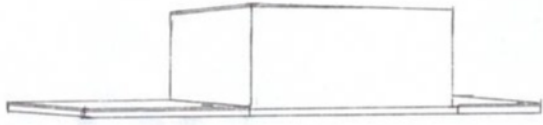
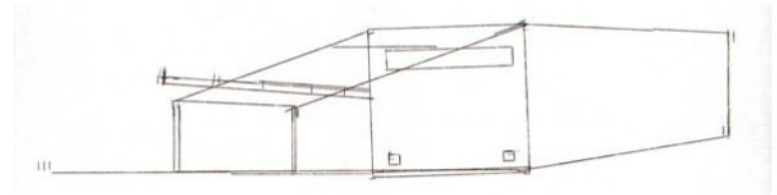
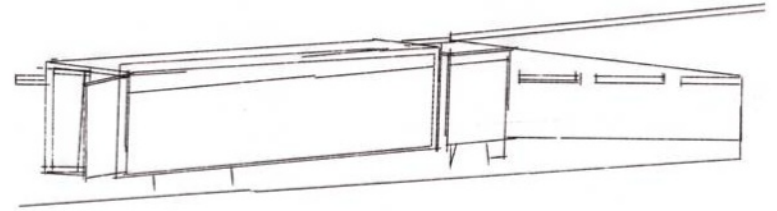
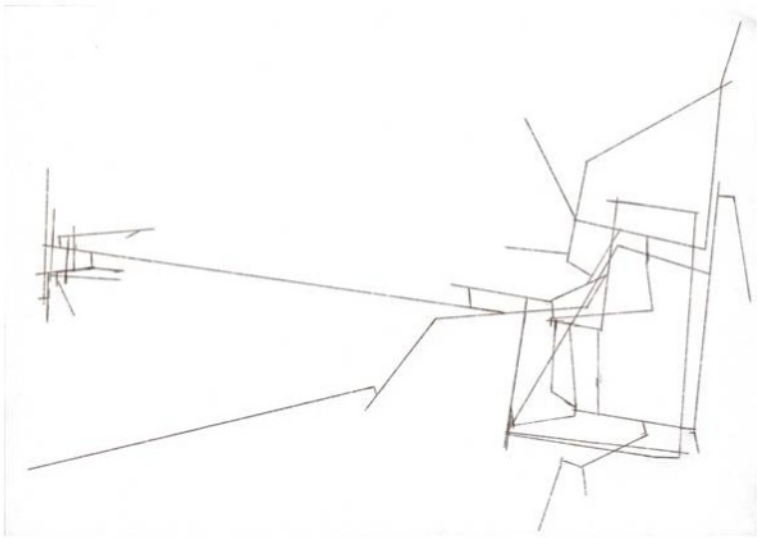

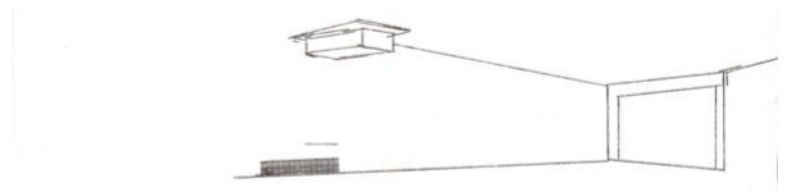
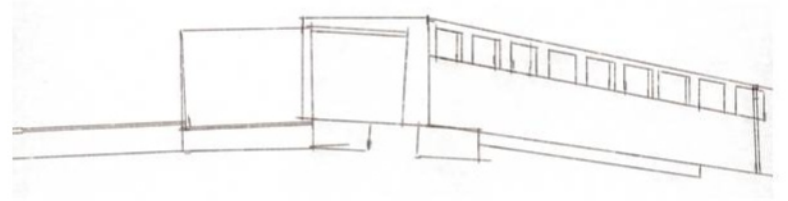
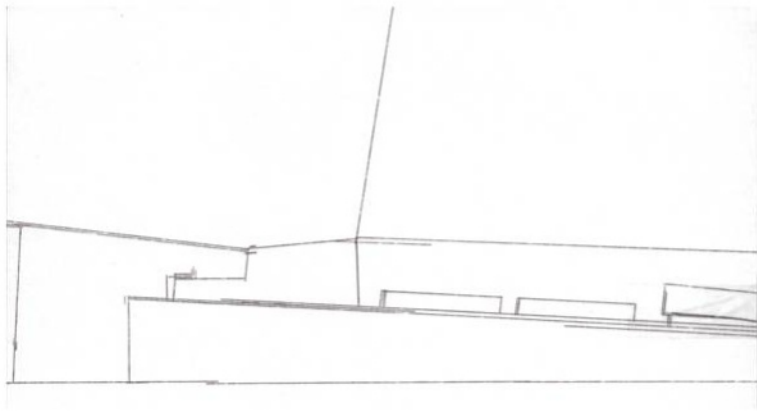

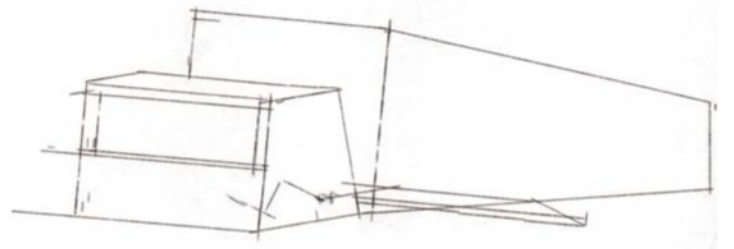
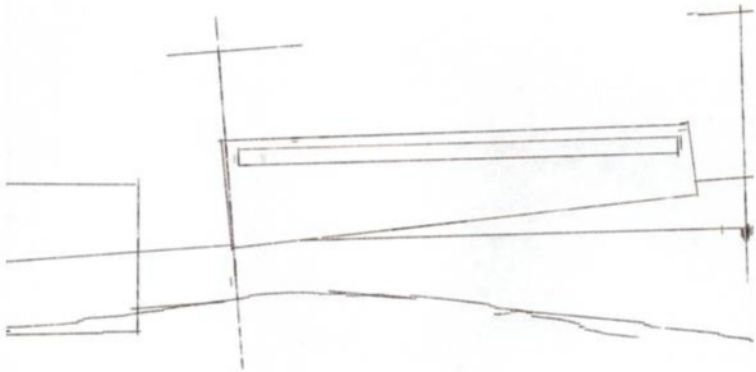
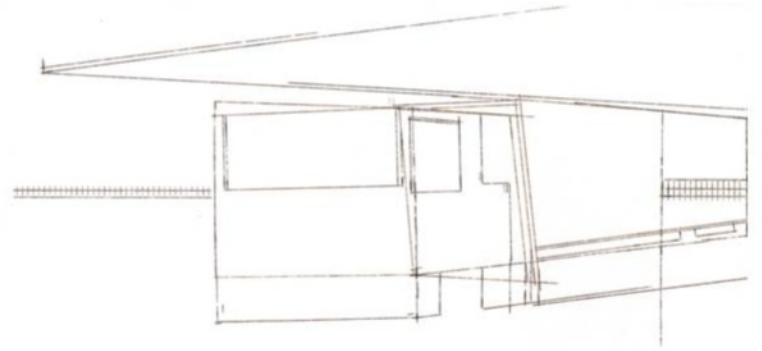
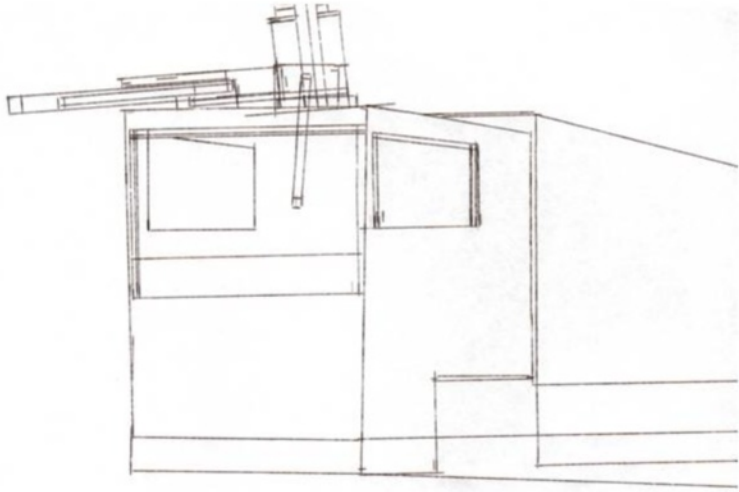

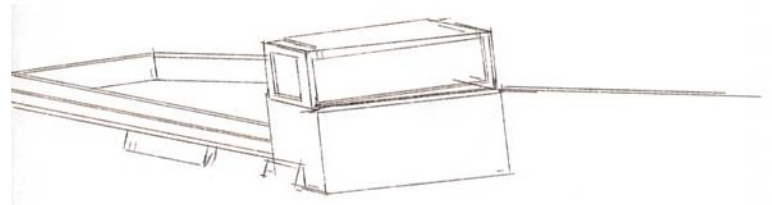
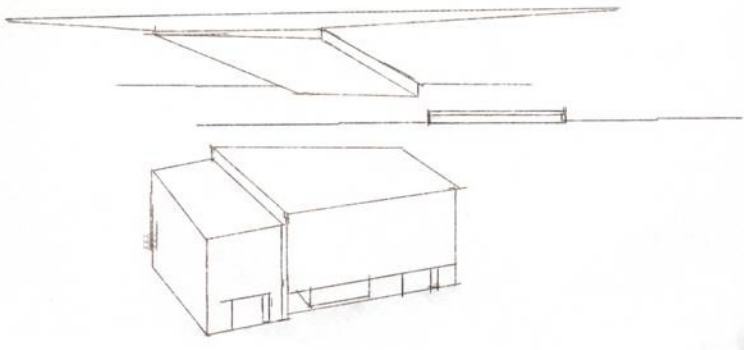
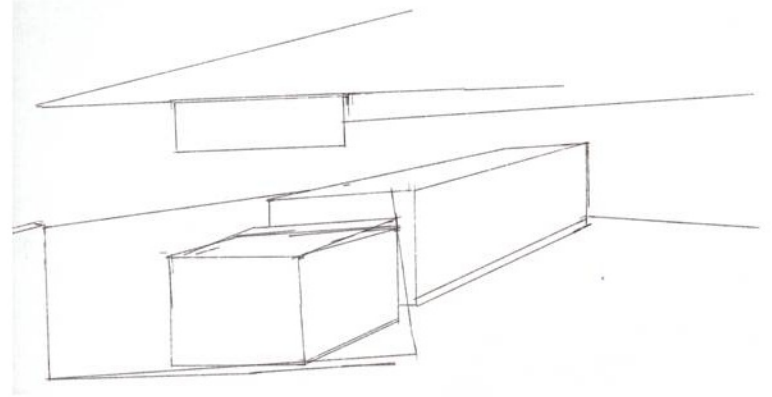
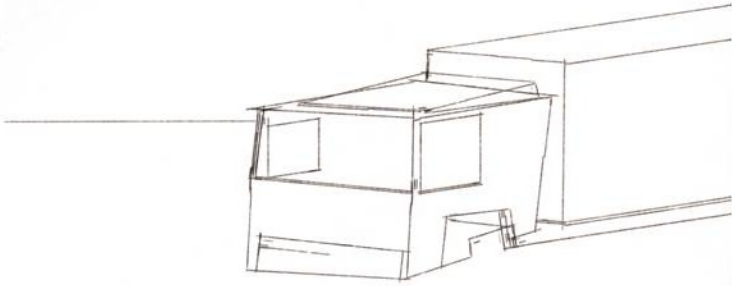

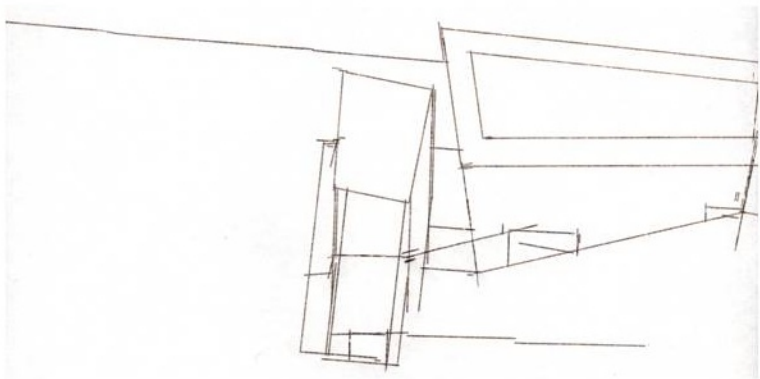
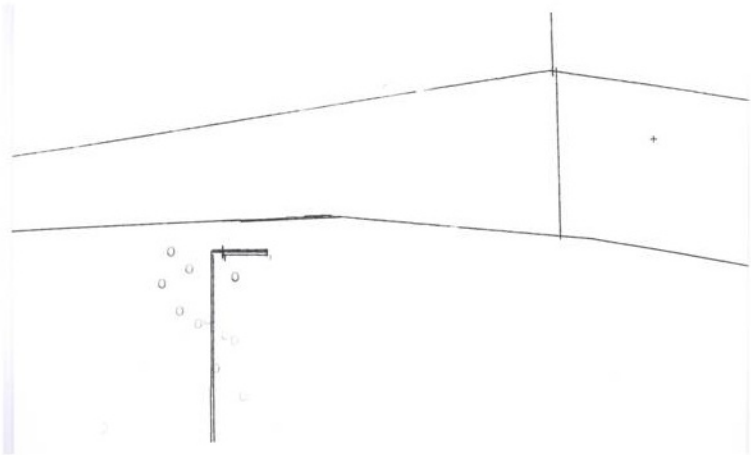

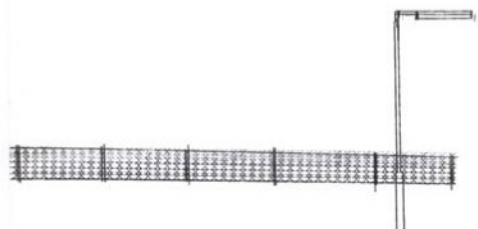
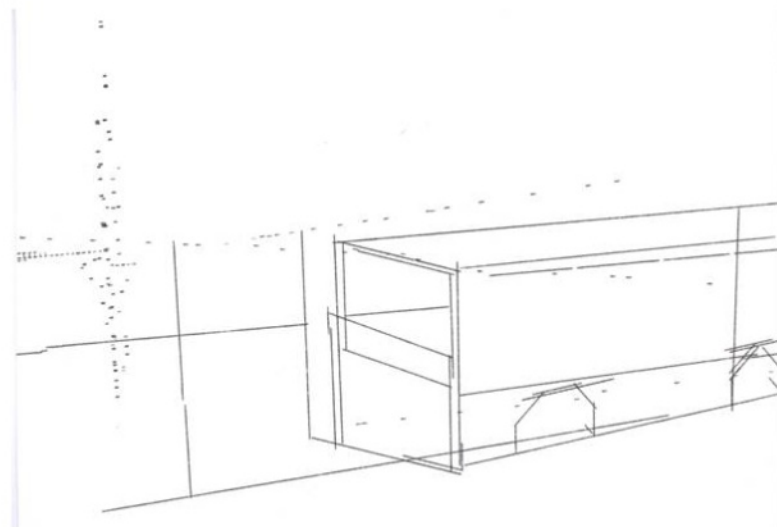
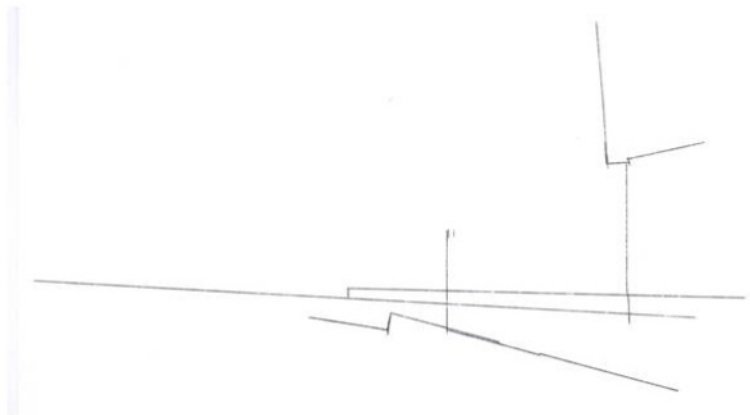

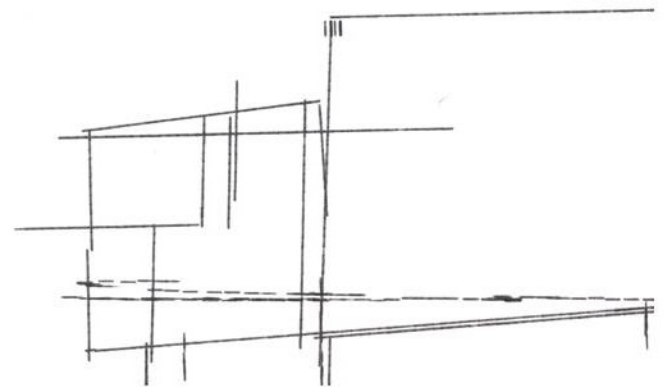
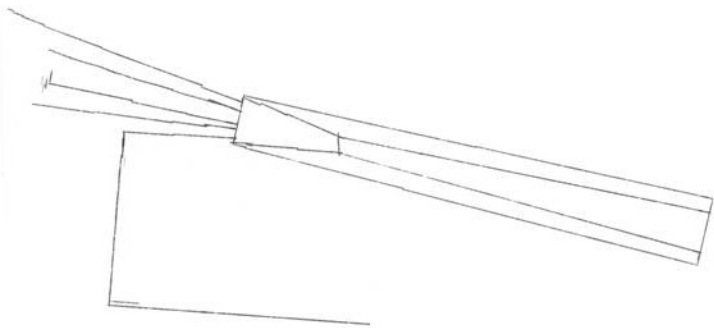
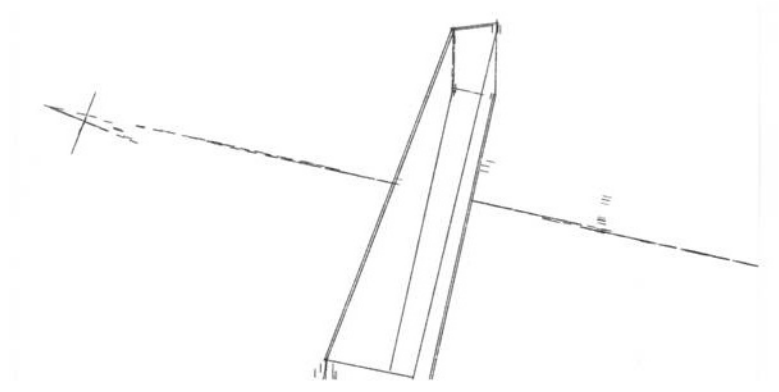
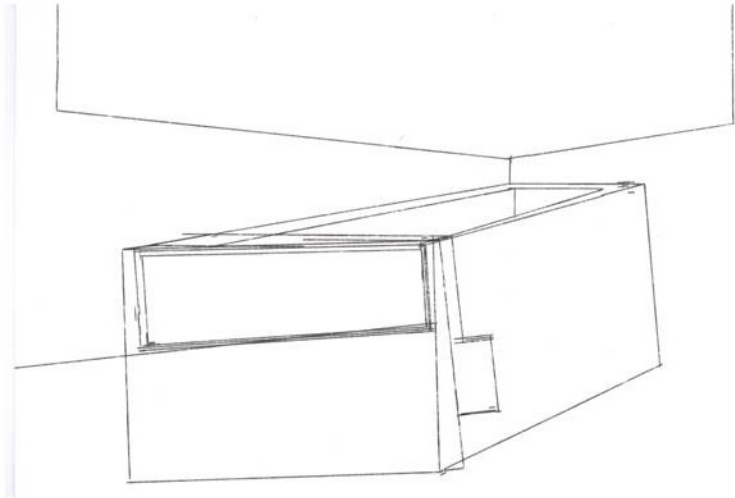

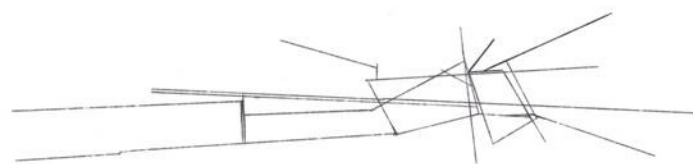
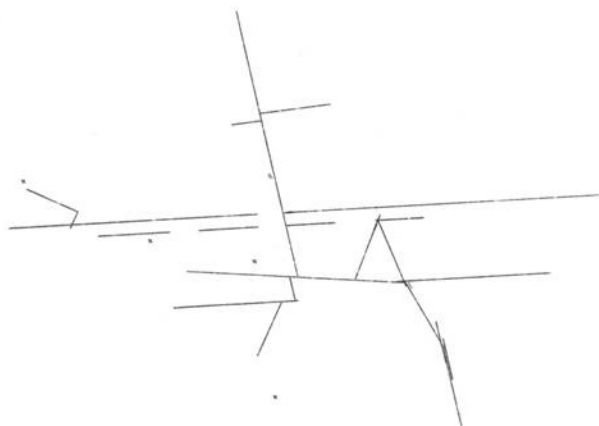
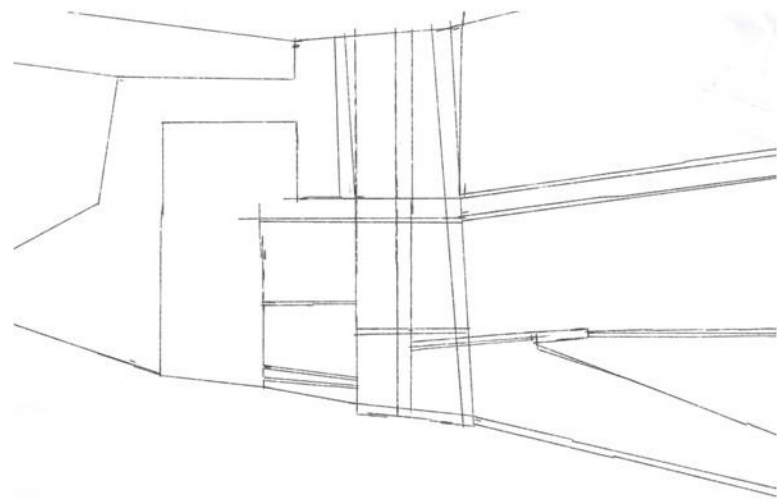
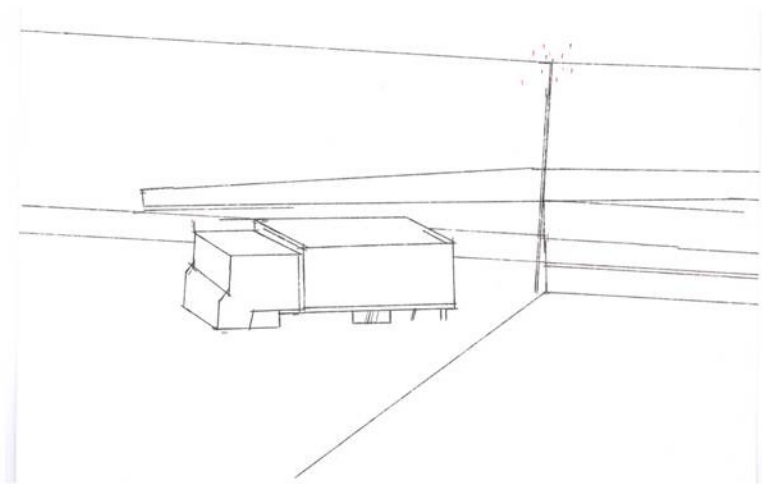

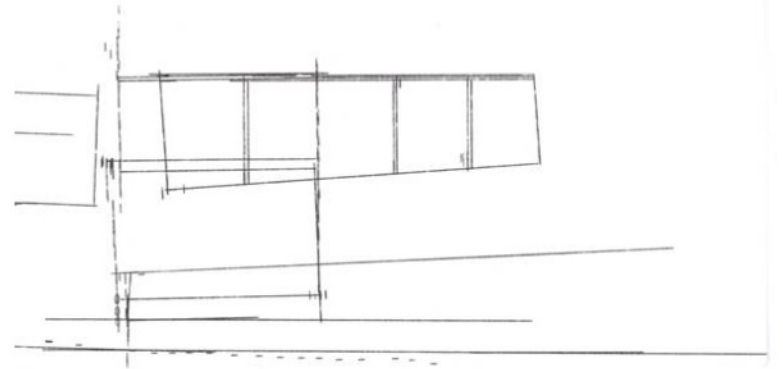
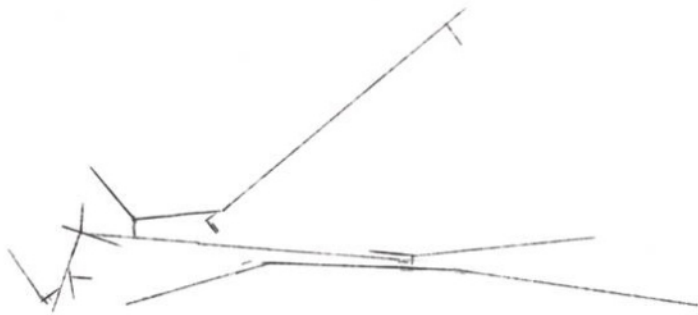
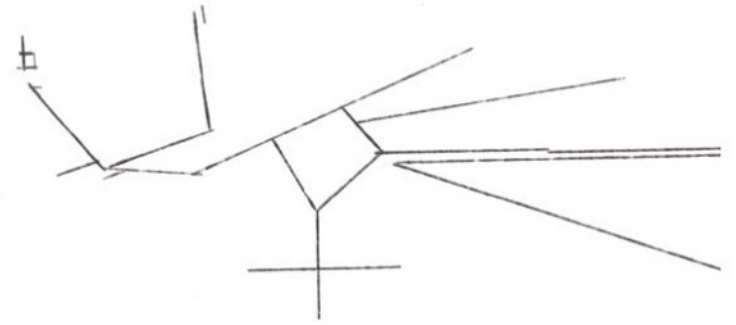
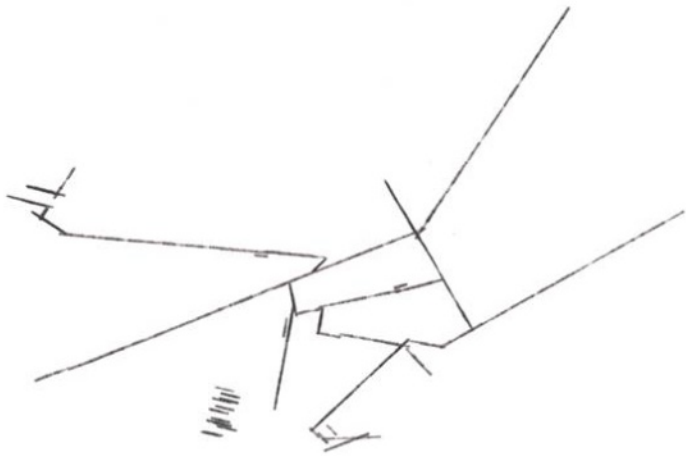

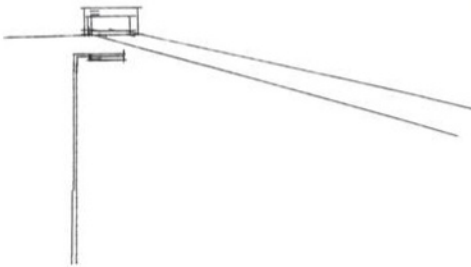
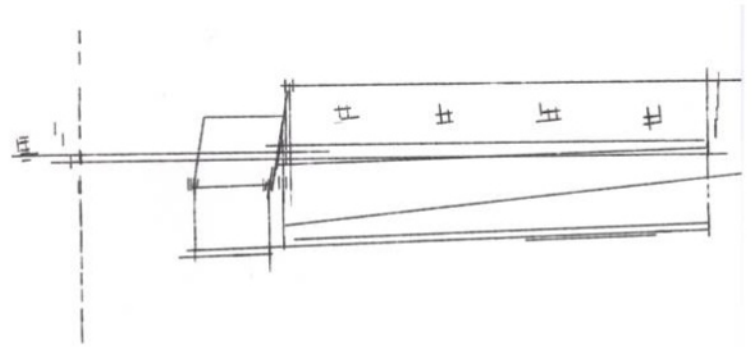
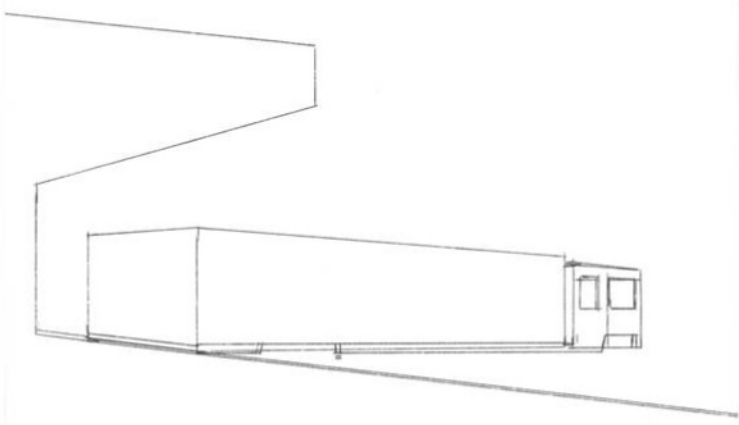

Note: All pieces created on a manual typewriter.

coming soon: Jennifer Scappettone, Bob Cobbing, Lawrence Upton,
Michael Yip and more.
this issue: front & back covers by Dirk Kreckler

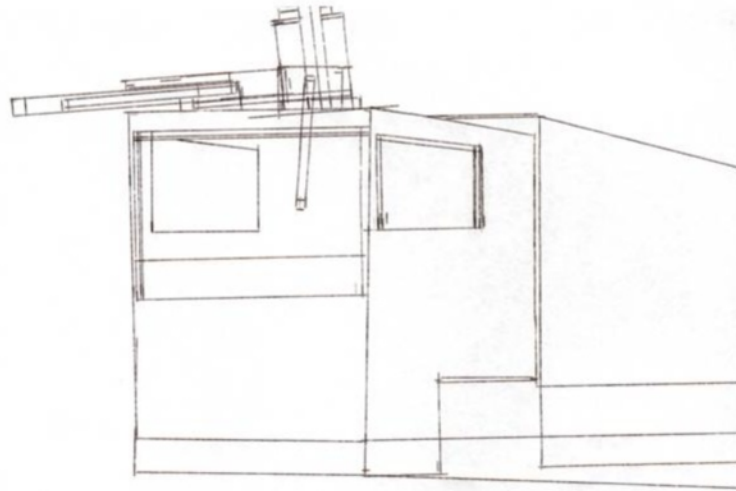

speechless 7
edited by derek beaulieu

speechless is dedicated to the dissemination and discussion
of visual and concrete poetry.

Submissions are welcome.

#2, 733-2nd Avenue NW | Calgary Alberta | Canada | T2N 0E4
derek@housepress.ca